



Nortel Meridian Opt11C Rel25 using E1 QSIG to Cisco Unified CallManager 4.0

November 9, 2007 Revision 3

Table of Contents

Introduction	1
Network Topology.....	2
Limitations.....	2
System Components	2
Hardware Requirements	2
Software Requirements	2
Features	3
Features Supported.....	3
Features Not Supported	3
Configuration.....	3
Configuring the Nortel Meridian Opt11C PBX.....	3
Configuring the Cisco Unified CallManager.....	25
Acronyms	48

Introduction

- This is an Application Note for Connectivity of Nortel Meridian Opt11C Release 25 PBX with Cisco Unified CallManager (CUCM) Release 4.0 using Cisco 6608-E1 QSIG as MGCP Gateway.
- The Network Topology diagram shows the test set-up for end-to-end interoperability with the Cisco Unified CallManager connected to the PBX via 6608-E1 QSIG link as MGCP Gateway.
- Connectivity is achieved by using the PRI ISO QSIG E1 protocol type on the MGCP gateway and ISGF switch type on the Nortel PBX.
- Basic Calls worked fine in both directions with Calling/Connected Name and Calling/Connected Number features support.

Network Topology

Figure 1. Network Topology

Basic Call Setup End-to-End Configuration

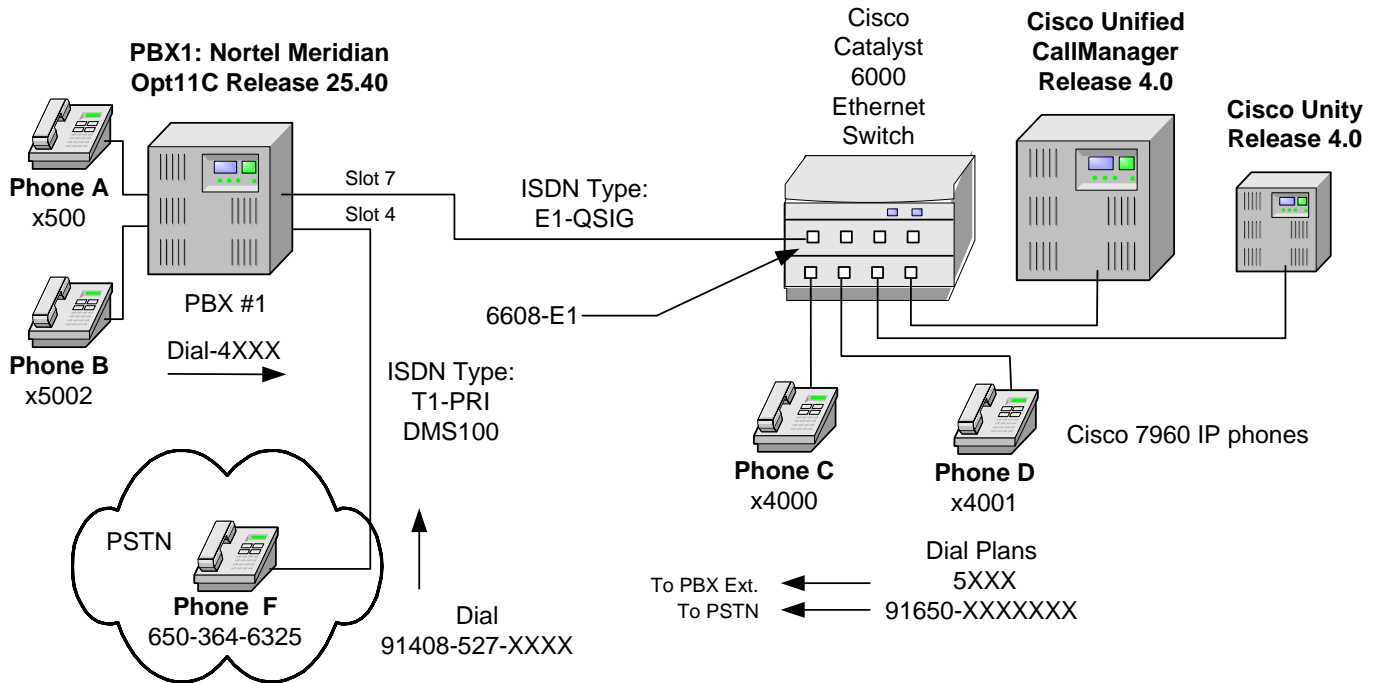

Limitations

No known limitations.

System Components

Hardware Requirements

- Cisco Hardware
 - Cisco Cat6K switch with 6608-E1 Gateway
 - Cisco Unified CallManager Server
- Nortel Meridian Opt11C PBX.
 - Hardware: NTBK50AA, 2 Mb PRI

Software Requirements

- PBX Software Release 25
- Cisco Unified CallManager 4.0
- Cisco WS-X6608-E1 gateway Version 7.6(3a)



Features

Features Supported

- CLIP-Calling Line (Number) Identification Presentation
- CLIR-Calling Line (Number) Identification Restriction
- CNIP-Calling Name Identification Presentation
- CNIR-Calling Name Identification Restriction
- COLP-Connected Line (Number) Identification Presentation
- COLR- Connected Line (Number) Identification Restriction
- CONP-Connected Name Identification Presentation
- CONR- Connected Name Identification Restriction
- CT-Call Transfer (by join)
- CFU-Call Forwarding Unconditional (by join)
- CFB-Call Forwarding Busy (by join)
- CFNR-Call Forwarding No Reply (by join)
- MWI- Message Waiting Indication (lamp ON, lamp OFF) ¹

Features Not Supported

- Cisco Unified CallManager 4.0 does not support sending Alerting Name or Busy Name Identification information

Configuration

Configuring the Nortel Meridian Opt11C PBX

Configure in the following sequence:

1. Configure Common Equipment.
2. Configure D-Channel.
3. Configure Route Data Block.
4. Configure Trunk.
5. Configure Coordinated Dialing Plan
6. Configure Dialing Plan for Tandem Call

¹ MWI was tested with Cisco Unified CallManager 4.0 configured with Cisco Unity as the message center PINX and PBX users as remote subscribers. Nortel Meridian PBX was not configured to handle Q.SIG MWI messages at the time of testing therefore it is not known at that time whether Q.SIG MWI integration with Nortel Meridian PBX will work.



Configuration Menus and Commands

Common equipment

```
>LD 22
PT2000
MARP NOT ACTIVATED
```

```
REQ prt
```

```
TYPE cequ
```

```
CEQU
```

```
MPED 8D
```

```
SUPL 000 004 008 012
```

```
016 032 036 040
```

```
044 048 064 068
```

```
072
```

```
XCT 000
```

```
CONF 029 030 031 062
```

```
094 095
```

```
DLOP NUM DCH FRM LCMT YALM T1TE TRSH
```

```
TRK 03 24 ESF B8S FDL - 00
```

```
PRI 04 24 ESF B8S FDL - 00
```

```
PRI2 05 07
```

```
DTI2 06
```

```
MISP
```

```
REQ ****
```

```
>
```

Configure D-Channel

For QSIG Trunk:

```
>ld 22
PT2000
MARP NOT ACTIVATED
```

```
REQ prt
```

```
TYPE adan dch 7
```

```
ADAN DCH 7
```

```
CTYP MSDL
```

```
CARD 07
```

```
PORT 1
```

```
DES E1_ISGF_4
```

```
USR PRI
```

```
DCHL 7
```

```
OTBF 32
```

```
PARM RS422 DTE
```

```
DRAT 64KC
```

```
CLOK EXT
```



IFC ISGF

PINX_CUST 0
ISDN_MCNT 300
CLID OPT0
CO_TYPE STD
SIDE NET
CNEG 1
RLS ID **
QCHID YES
RCAP COLP NDI CCBI CCNI PRI DV3I CTI
PR_TRIGS DIV 2 3
PR_RTN NO
MBGA NO
OVLN YES
DIDD 0
OVLN NO
T310 120
T200 3
T203 10
N200 3
N201 260
K 7

REQ ****
>

For PSTN Trunk:

>ld 22

PT2000
MARP NOT ACTIVATED

REQ prt

TYPE adan dch 4

ADAN DCH 4
CTYP MSDL
CARD 04
PORT 1
DES t1d100
USR PRI
DCHL 4
OTBF 32
PARM RS422 DTE
DRAT 64KC
CLOK EXT
IFC S100
SIDE USR
CNEG 1
RLS ID **
RCAP ND2
MBGA NO
OVLN NO
OVLN NO
T200 3
T203 10
N200 3
N201 260



K 7

REQ ****

Configure Route Data Block

For QSIG Trunk:

>ld 21
PT1000

REQ: prt

TYPE: rdb

CUST 0

ROUT 107

TYPE RDB
CUST 00
DMOD
ROUT 107
DES E1_ISGF_4
TKTP TIE
NPID_TBL_NUM 0
ESN NO
CNVT NO
SAT NO
RCLS EXT
DTRK YES
BRIP NO
DGTP PRI2
ISDN YES
MODE PRA
IFC ISGF
SBN NO
PNI 00001
NCNA NO
NCRD NO
CTYP UKWN
INAC NO
ISAR NO
CPFXS YES
DAPC NO
INTC NO
DSEL VOD
PTYT DTT
AUTO NO
DNIS NO
DCDR NO
ICOG IAO
SRCH RRB
TRMB YES
STEP
ACOD 407
TCPP NO
TARG 01
CLEN 1



BILN NO
OABS
INST
ANTK
SIGO STD
ICIS YES
TIMR ICF 512
OGF 512
EOD 13952
NRD 10112
DDL 70
ODT 4096
RGV 640
GRD 896
SFB 3
NBS 2048
NBL 4096
TFD 0
DRNG NO
CDR NO
MUS NO
OHQ NO
OHQT 00

PAGE 002

CBQ NO
AUTH NO
TTBL 0
ATAN NO
PLEV 2
ALRM NO
ART 0
SGRP 0
AACR NO

REQ: ****
>

For PSTN Trunk:

>ld 21

PT1000

REQ: prt

TYPE: rdb

CUST 0

ROUT 104

TYPE RDB
CUST 00
DMOD
ROUT 104
DES T1S100
TKTP TIE



NPID_TBL_NUM 0
ESN NO
CNVT NO
SAT NO
RCLS EXT
DTRK YES
BRIP NO
DGTP PRI
ISDN YES
MODE PRA
IFC S100
SBN NO
PNI 00001
NCNA YES
NCRD NO
CHTY BCH
CTYP UKWN
INAC NO
ISAR NO
CPUB OFF
DAPC NO
BCOT 0
DSEL VOD
PTYPR PRI
AUTO NO
DNIS NO
DCDR NO
ICOG IAO
SRCH RRB
TRMB YES
STEP
ACOD 704
TCPP NO
TARG 01
CLEN 1
BILN NO
OABS
INST
ANTK
SIGO STD
ICIS YES
TIMR ICF 512
OGF 512
EOD 13952
NRD 10112
DDL 70
ODT 4096
RGV 640
GRD 896
SFB 3
NBS 2048
NBL 4096
TFD 0
DRNG NO
CDR NO
MUS NO
OHQ NO

PAGE 002



OHQT 00
CBQ NO
AUTH NO
TTBL 0
ATAN NO
PLEV 2
ALRM NO
ART 0
SGRP 0
AACR NO

REQ: ****

OVL000

Configure Trunk

For QSIG Trunk:

>ld 20
PT0000
MARP NOT ACTIVATED

REQ: prt

TYPE: tnb

TN 7 1

DATE

PAGE

DES
DES E1_ISGF_4
TN 007 01
TYPE TIE
CDEN SD
CUST 0
TRK PRI2
PDCA 1
PCML A
NCOS 0
RTMB 107 1
B-CHANNEL SIGNALING
TGAR 0
AST NO
IAPG 0
CLS UNR DTN CND WTA LPR APN THFD
P10 VNL
TKID
DATE 1 MAR 2004

NACT ****

>

For PSTN Trunk:

>ld 20



PT0000
MARP NOT ACTIVATED

REQ: prt

TYPE: tnb

TN 4 1

DATE

PAGE

DES

DES S100

TN 004 01

TYPE TIE

CDEN SD

CUST 0

TRK PRI

PDCA 1

PCML MU

NCOS 0

RTMB 104 1

B-CHANNEL SIGNALING

TGAR 0

AST NO

IAPG 0

CLS UNR DTN CND WTA LPR APN THFD HKD

P10 VNL

TKID

DATE 15 MAR 2004

NACT ****

OVL000

Configure Coordinated Dialing Plan

>>LD 87

ESN000

MEM AVAIL: (U/P): 1269530 USED U P: 73054 33671 TOT: 1376255

DISK RECS AVAIL: 480

REQ prt

CUST 0

FEAT cdoxp

ESN009

FEAT cdp

TYPE dsc



DSC 400

DSC 400
FLEN 0
DSP LSC
RLI 8
NPA
NXX

MEM AVAIL: (U/P): 1269530 USED U P: 73054 33671 TOT: 1376255
DISK RECS AVAIL: 480
REQ ****

OVL000
>ld 87

ESN000

MEM AVAIL: (U/P): 1269530 USED U P: 73054 33671 TOT: 1376255
DISK RECS AVAIL: 480
REQ prt

CUST 0

FEAT cdp

TYPE dsc

DSC 49

DSC 49
FLEN 0
DSP LSC
RLI 8
NPA
NXX

MEM AVAIL: (U/P): 1269530 USED U P: 73054 33671 TOT: 1376255
DISK RECS AVAIL: 480
REQ ****

OVL000

>
OVL000
>LD 86

ESN000

MEM AVAIL: (U/P): 1269530 USED U P: 73054 33671 TOT: 1376255
DISK RECS AVAIL: 480
REQ prt

CUST 0



FEAT rlb

RLI 8

RLI 8

ENTR 0

LTER NO

ROUT 107

TOD 0 ON 1 ON 2 ON 3 ON

4 ON 5 ON 6 ON 7 ON

CNV NO

EXP NO

FRL 0

DMI 0

FCI 0

FSNI 0

SBOC NRR

OHQ NO

CBQ NO

ISET 0

NALT 5

MFRL 0

OVLL 0

MEM AVAIL: (U/P): 1269530 USED U P: 73054 33671 TOT: 1376255

DISK RECS AVAIL: 480

REQ ****

>

Configure Dialing Plan for Tandem Call

Dial Plan Configuration when PBX received AC1 (9) + NPA (1408) digit string

>ld 90

ESN000

MEM AVAIL: (U/P): 1269530 USED U P: 73054 33671 TOT: 1376255

DISK RECS AVAIL: 480

REQ prt

CUST 0

FEAT net

TRAN ac1

TYPE npa

NPA 1408

NPA 1408

RLI 7

SDRR NONE

ITEI NONE



MEM AVAIL: (U/P): 1269530 USED U P: 73054 33671 TOT: 1376255
DISK RECS AVAIL: 480
REQ ****

OVL000
>ld 86

ESN000

MEM AVAIL: (U/P): 1269530 USED U P: 73054 33671 TOT: 1376255
DISK RECS AVAIL: 480
REQ prt

CUST 0

FEAT rlb

RLI 7

RLI 7
ENTR 0
LTER NO
ROUT 107
TOD 0 ON 1 ON 2 ON 3 ON
4 ON 5 ON 6 ON 7 ON
CNV NO
EXP NO
FRL 0
DMI 1
FCI 0
FSNI 0
SBOC NRR
OHQ NO
CBQ NO

ISET 0
NALT 5
MFRL 0
OVLL 0

MEM AVAIL: (U/P): 1269530 USED U P: 73054 33671 TOT: 1376255
DISK RECS AVAIL: 480
REQ
DCH: 5 MAINT INDICATION TIME: 13:43:50
COUNTER VALUE
3 255

>
OVL000
>ld 86

ESN000

MEM AVAIL: (U/P): 1269530 USED U P: 73054 33671 TOT: 1376255



DISK RECS AVAIL: 480
REQ prt

CUST 0

FEAT dgt

DMI 1

DMI 1
DEL 7
CTYP NCHG

MEM AVAIL: (U/P): 1269530 USED U P: 73054 33671 TOT: 1376255
DISK RECS AVAIL: 480
REQ ****

OVL000
Dial Plan Configuration when PBX received AC1 (9) + NPA (1650) digit string

>ld 90

ESN000

MEM AVAIL: (U/P): 1269530 USED U P: 73054 33671 TOT: 1376255
DISK RECS AVAIL: 480
REQ prt

CUST 0

FEAT net

TRAN ac1

TYPE npa

NPA 1650

NPA 1650
RLI 4
SDRR NONE
ITEI NONE

MEM AVAIL: (U/P): 1269530 USED U P: 73054 33671 TOT: 1376255
DISK RECS AVAIL: 480
REQ ****

>
OVL000
>ld 86

ESN000

MEM AVAIL: (U/P): 1269530 USED U P: 73054 33671 TOT: 1376255



DISK RECS AVAIL: 480
REQ prt

CUST 0

FEAT rlb

RLI 4

RLI 4

ENTR 0

LTER NO

ROUT 104

TOD 0 ON 1 ON 2 ON 3 ON
4 ON 5 ON 6 ON 7 ON

CNV NO

EXP NO

FRL 0

DMI 4

FCI 0

FSNI 0

SBOC NRR

OHQ NO

CBQ NO

ISET 0

NALT 5

MFRL 0

OVLL 0

MEM AVAIL: (U/P): 1269530 USED U P: 73054 33671 TOT: 1376255
DISK RECS AVAIL: 480
REQ prt

CUST 0

FEAT dgt

DMI 4

DMI 4

DEL 1

CTYP NCHG

MEM AVAIL: (U/P): 1269530 USED U P: 73054 33671 TOT: 1376255
DISK RECS AVAIL: 480
REQ ****

>

>

Station Configuration for CLIP, CNIP, COLP, and CONP (Number and Name presentation)

>LD 11

SL1000

MARP NOT ACTIVATED



MEM AVAIL: (U/P): 1269530 USED U P: 73054 33671 TOT: 1376255
DISK RECS AVAIL: 480
TNS AVAIL: 97 USED: 103 TOT: 200
ACD AGENTS AVAIL: 300 USED: 0 TOT: 300
AST AVAIL: 100 USED: 0 TOT: 100
DATA PORTS AVAIL: 2498 USED: 2 TOT: 2500
DIGITAL TELEPHONES AVAIL: 2494 USED: 6 TOT: 2500
INTERNET TELEPHONES AVAIL: 6 USED: 0 TOT: 6

REQ: prt

TYPE: 2616

MARP NOT ACTIVATED

TN 1 0 0 0

DATE

PAGE

DES

DES TEST1

TN 001 0 00 00

TYPE 2616

CDEN 8D

CUST 0

AOM 0

FDN 4990

TGAR 0

LDN NO

NCOS 0

SGRP 0

RNPG 0

SCI 0

SSU

XLST

CLS CTD FBD WTA LPR MTD FNA HTA ADD HFD

MWA LMPN RMMD SMWD AAD IMD XHD IRD NID OLD VCE DRG1

POD DSX VMD CMSD SLKD CCSD SWD LND CNDA

CFTA SFD MRD DDV CNID CDCA MSID DAPA BFED RCBF

ICDD CDMD LLCN MCTD CLBD AUTU

GPUD DPUD DNDA CFXA ARHD CLTD ASCD

CPFA CPTA ABDD CFHD FICD NAID BUZZ AGRD MOAD AHD

DDGA NAMA

DRDD EXR0

USRD ULAD RTDD RBDD RBHD PGND FLXD FTTC DNDY DNO3 MCBN

CPND_LANG ENG

RCO 0

EFD 4990

HUNT 4001

EHT 4001

LHK 0

PLEV 02

AST

IAPG 0



```
AACS NO
ITNA NO
DGRP
MLWU_LANG 0
DNDR 0
KEY 00 SCR 5001 0      MARP
      CPND
      NAME BIG BIRD
      XPLN 27
      DISPLAY_FMT FIRST, LAST
01 SCR 5011 0      MARP
      CPND
      NAME MINI BIRD
      XPLN 27
      DISPLAY_FMT FIRST, LAST
02
03 CFW 12 5002
04 AO6
05 TRN
06 DSP
07
08 ADL 16
09 ADL 16
10 ADL 16
11 ADL 16
12 ADL 16
13 ADL 16
14 RGA
15
DATE 16 MAR 2004
```

NACT ****

OVL000
>

Station Configuration for CLIR, COLR-Calling/Connected Line Identification Restriction

```
>LD 11
SL1000
MARP NOT ACTIVATED

MEM AVAIL: (U/P): 1269530      USED U P: 73054 33671      TOT: 1376255
DISK RECS AVAIL: 480
TNS      AVAIL: 97      USED: 103      TOT: 200
ACD AGENTS AVAIL: 300      USED: 0      TOT: 300
AST      AVAIL: 100      USED: 0      TOT: 100
DATA PORTS AVAIL: 2498      USED: 2      TOT: 2500
DIGITAL TELEPHONES AVAIL: 2494      USED: 6      TOT: 2500
INTERNET TELEPHONES AVAIL: 6      USED: 0      TOT: 6
```

REQ: prt

TYPE: 2616

MARP NOT ACTIVATED



TN 1 0 0 0

DATE

PAGE

DES

DES TEST1

TN 001 0 00 00

TYPE 2616

CDEN 8D

CUST 0

AOM 0

FDN 4990

TGAR 0

LDN NO

NCOS 0

SGRP 0

RNPG 0

SCI 0

SSU

XLST

CLS CTD FBD WTA LPR MTD FNA HTA ADD HFD

MWA LMPN RMMD SMWD AAD IMD XHD IRD NID OLD VCE DRG1

POD DSX VMD CMSD SLKD CCSD SWD LND CNDA

CFTA SFD MRD DDV CNID CDCA MSID DAPA BFED RCB

ICDD CDMD LLCN MCTD CLBD AUTU

GPUD DPUD DNDA CFXA ARHD CLTD ASCD

CPFA CPTA ABDD CFHD FICD NAID BUZZ AGRD MOAD AHD

DDGD NAMA

DRDD EXR0

USRD ULAD RTDD RBDD RBHD PGND FLXD FTTC DNDY DNO3 MCBN

CPND_LANG ENG

RCO 0

EFD 4990

HUNT 4001

EHT 4001

LHK 0

PLEV 02

AST

IAPG 0

AACS NO

ITNA NO

DGRP

MLWU_LANG 0

DNDR 0

KEY 00 SCR 5001 0 MARP

CPND

NAME BIG BIRD

XPLN 27

DISPLAY_FMT FIRST, LAST

01 SCR 5011 0 MARP

CPND

NAME MINI BIRD

XPLN 27

DISPLAY_FMT FIRST, LAST

02



03 CFW 12 5002
04 AO6
05 TRN
06 DSP
07
08 ADL 16
09 ADL 16
10 ADL 16
11 ADL 16
12 ADL 16
13 ADL 16
14 RGA
15
DATE 16 MAR 2004

NACT ****

OVL000

>

Station Configuration for CNIR, CONR-Calling/Connected Name Identification Restriction

>LD 11
SL1000
MARP NOT ACTIVATED

MEM AVAIL: (U/P):	1269530	USED U P:	73054 33671	TOT:	1376255
DISK RECS AVAIL:	480				
TNS AVAIL:	97	USED:	103	TOT:	200
ACD AGENTS AVAIL:	300	USED:	0	TOT:	300
AST AVAIL:	100	USED:	0	TOT:	100
DATA PORTS AVAIL:	2498	USED:	2	TOT:	2500
DIGITAL TELEPHONES AVAIL:	2494	USED:	6	TOT:	2500
INTERNET TELEPHONES AVAIL:	6	USED:	0	TOT:	6

REQ: prt

TYPE: 2616

MARP NOT ACTIVATED

TN 1 0 0 0

DATE

PAGE

DES

DES TEST1
TN 001 0 00 00
TYPE 2616
CDEN 8D
CUST 0
AOM 0



```
FDN 4990
TGAR 0
LDN NO
NCOS 0
SGRP 0
RNPG 0
SCI 0
SSU
XLST
CLS CTD FBD WTA LPR MTD FNA HTA ADD HFD
MWA LMPN RMMD SMWD AAD IMD XHD IRD NID OLD VCE DRG1
POD DSX VMD CMSD SLKD CCSD SWD LND CNDA
CFTA SFD MRD DDV CNID CDCA MSID DAPA BFED RCBF
ICDD CDMD LLCN MCTD CLBD AUTU
GPUD DPUD DNDA CFXA ARHD CLTD ASCD
CPFA CPTA ABDD CFHD FICD NAID BUZZ AGRD MOAD AHD
DDGA NAMD
DRDD EXR0
USRD ULAD RTDD RBDD RBHD PGND FLXD FTTC DNDY DNO3 MCBN
CPND_LANG ENG
RCO 0
EFD 4990
HUNT 4001
EHT 4001
LHK 0
PLEV 02
AST
IAPG 0
AACS NO
ITNA NO
DGRP
MLWU_LANG 0
DNDR 0
KEY 00 SCR 5001 0 MARP
      CPND
        NAME BIG BIRD
        XPLN 27
        DISPLAY_FMT FIRST, LAST
01 SCR 5011 0 MARP
      CPND
        NAME MINI BIRD
        XPLN 27
        DISPLAY_FMT FIRST, LAST
02
03 CFW 12 5002
04 AO6
05 TRN
06 DSP
07
08 ADL 16
09 ADL 16
10 ADL 16
11 ADL 16
12 ADL 16
13 ADL 16
14 RGA
15
DATE 16 MAR 2004
```



NACT ****

OVL000

Station Configuration for CFB- Call Forward on Busy

CF-Busy on Nortel requires setting up HUNT DN on Nortel station configuration by changing CLS parameter "HTD" (Hunt denied) to "HTA" (Hunt allowed) and specifying a DN for HUNT parameter.

>LD 11

SL1000

MARP NOT ACTIVATED

MEM AVAIL: (U/P):	1269530	USED U P:	73054 33671	TOT:	1376255
DISK RECS AVAIL:	480				
TNS AVAIL:	97	USED:	103	TOT:	200
ACD AGENTS AVAIL:	300	USED:	0	TOT:	300
AST AVAIL:	100	USED:	0	TOT:	100
DATA PORTS AVAIL:	2498	USED:	2	TOT:	2500
DIGITAL TELEPHONES AVAIL:	2494	USED:	6	TOT:	2500
INTERNET TELEPHONES AVAIL:	6	USED:	0	TOT:	6

REQ: prt

TYPE: 2616

MARP NOT ACTIVATED

TN 1 0 0 0

DATE

PAGE

DES

DES TEST1

TN 001 0 00 00

TYPE 2616

CDEN 8D

CUST 0

AOM 0

FDN 4990

TGAR 0

LDN NO

NCOS 0

SGRP 0

RNPG 0

SCI 0

SSU

XLST

CLS CTD FBD WTA LPR MTD FNA **HTA** ADD HFD

MWA LMPN RMMD SMWD AAD IMD XHD IRD NID OLD VCE DRG1

POD DSX VMD CMSD SLKD CCSW SWD LND CNDA

CFTA SFD MRD DDV CNID CDCA MSID DAPA BFED RCBF

ICDD CDMD LLCN MCTD CLBD AUTU



GPUD DPUD DNDA CFXA ARHD CLTD ASCD
CPFA CPTA ABDD CFHD FICD NAID BUZZ AGRD MOAD AHD
DDGA NAMA
DRDD EXR0
USRD ULAD RTDD RBDD RBHD PGND FLXD FTTC DNDY DNO3 MCBN
CPND_LANG ENG
RCO 0
EFD 4990
HUNT 4001
EHT 4001
LHK 0
PLEV 02
AST
IAPG 0
AACS NO
ITNA NO
DGRP
MLWU_LANG 0
DNDR 0
KEY 00 SCR 5001 0 MARP
CPND
NAME BIG BIRD
XPLN 27
DISPLAY_FMT FIRST, LAST
01 SCR 5011 0 MARP
CPND
NAME MINI BIRD
XPLN 27
DISPLAY_FMT FIRST, LAST
02
03 CFW 12 5002
04 AO6
05 TRN
06 DSP
07
08 ADL 16
09 ADL 16
10 ADL 16
11 ADL 16
12 ADL 16
13 ADL 16
14 RGA
15
DATE 16 MAR 2004

NACT ****

OVL000

Station Configuration for CFNR- Call Forward No Reply

LD 11

SL1000

MARP NOT ACTIVATED

MEM AVAIL: (U/P): 1269530 USED U P: 73054 33671 TOT: 1376255
DISK RECS AVAIL: 480



TNS AVAIL: 97 USED: 103 TOT: 200
ACD AGENTS AVAIL: 300 USED: 0 TOT: 300
AST AVAIL: 100 USED: 0 TOT: 100
DATA PORTS AVAIL: 2498 USED: 2 TOT: 2500
DIGITAL TELEPHONES AVAIL: 2494 USED: 6 TOT: 2500
INTERNET TELEPHONES AVAIL: 6 USED: 0 TOT: 6

REQ: prt

TYPE: 2616

MARP NOT ACTIVATED

TN 1 0 0 0

DATE

PAGE

DES

DES TEST1

TN 001 0 00 00

TYPE 2616

CDEN 8D

CUST 0

AOM 0

FDN 4990

TGAR 0

LDN NO

NCOS 0

SGRP 0

RNPG 0

SCI 0

SSU

XLST

CLS CTD FBD WTA LPR MTD FNA HTA ADD HFD

MWA LMPN RMMD SMWD AAD IMD XHD IRD NID OLD VCE DRG1

POD DSX VMD CMSD SLKD CCSD SWD LND CNDA

CFTA SFD MRD DDV CNID CDCA MSID DAPA BFED RCB

ICDD CDMD LLCN MCTD CLBD AUTU

GPUD DPUD DNDA CFXA ARHD CLTD ASCD

CPFA CPTA ABDD CFHD FICD NAID BUZZ AGRD MOAD AHD

DDGA NAMA

DRDD EXR0

USRD ULAD RTDD RBDD RBHD PGND FLXD FTTC DNDY DNO3 MCBN

CPND_LANG ENG

RCO 0

EFD 4990

HUNT 4001

EHT 4001

LHK 0

PLEV 02

AST

IAPG 0

AACS NO

ITNA NO

DGRP

MLWU_LANG 0

DNDR 0



```
KEY 00 SCR 5001 0      MARP
      CPND
      NAME BIG BIRD
      XPLN 27
      DISPLAY_FMT FIRST, LAST
01 SCR 5011 0      MARP
      CPND
      NAME MINI BIRD
      XPLN 27
      DISPLAY_FMT FIRST, LAST
02
03 CFW 12  5002
04 AO6
05 TRN
06 DSP
07
08 ADL 16
09 ADL 16
10 ADL 16
11 ADL 16
12 ADL 16
13 ADL 16
14 RGA
15
DATE 16 MAR 2004
```

NACT ****

OVL000



Configuring the Cisco Unified CallManager

6608-E1 Gateway Configuration

System Route Plan Service Feature Device User Application Help

Cisco CallManager Administration
For Cisco IP Telephony Solutions

CISCO SYSTEMS

Gateway Configuration

[Back to Find/List Gateways](#)
[Dependency Records](#)

Product : Cisco Catalyst 6000 E1 VoIP Gateway
Gateway : S0/DS1-0@SDA0001C9D8633E
Device Protocol: Digital Access PRI
Registration: Registered with Cisco CallManager 172.20.32.254
IP Address: [172.20.32.103](#)

Status: Ready

Device Information

MAC Address*	<input type="text" value="0001C9D8633E"/>
Description	<input type="text" value="SDA0001C9D8633E"/>
Device Pool*	<input type="text" value="Default"/>
Network Locale	<input type="text" value="United States"/>
Media Resource Group List	<input type="text" value=" < None >"/>
Location	<input type="text" value=" < None >"/>
AAR Group	<input type="text" value=" < None >"/>
Load Information	<input type="text"/>

Multilevel Precedence and Preemption (MLPP) Information

MLPP Domain (e.g., "0000FF")	<input type="text"/>
MLPP Indication	Not available on this device
MLPP Preemption	Not available on this device

Interface Information

PRI Protocol Type*	<input type="text" value="PRI ISO QSIG E1"/>
Protocol Side*	<input type="text" value="User"/>
Channel Selection Order*	<input type="text" value="Top Down"/>
Channel IE Type*	<input type="text" value="Timeslot Number"/>

PCM Type*	A-law
Delay for first restart (1/8 sec ticks)	32
Delay between restarts (1/8 sec ticks)	4
<input checked="" type="checkbox"/> Inhibit restarts at PRI initialization	
<input checked="" type="checkbox"/> Enable status poll	
Call Routing Information	
Inbound Calls	
Significant Digits*	All
Calling Search Space	Incoming Trunk
AAR Calling Search Space	< None >
Prefix DN	
Outbound Calls	
Calling Line ID Presentation*	Default
Calling Party Selection*	Originator
Called party IE number type unknown*	National
Calling party IE number type unknown*	National
Called Numbering Plan*	ISDN
Calling Numbering Plan*	ISDN
Number of digits to strip*	0
Caller ID DN	
SMDI Base Port*	0
PRI Protocol Type Specific Information	
<input checked="" type="checkbox"/> Display IE Delivery	
<input type="checkbox"/> Redirecting Number IE Delivery - Outbound	
<input checked="" type="checkbox"/> Redirecting Number IE Delivery - Inbound	
<input checked="" type="checkbox"/> Send Extra Leading Character In DisplayIE***	
<input type="checkbox"/> Setup non-ISDN Progress Indicator IE Enable****	

<input type="checkbox"/>	Setup non-ISDN Progress Indicator IE Enable****
<input type="checkbox"/>	MCDN Channel Number Extension Bit Set to Zero**
<input type="checkbox"/>	Send Calling Name In Facility IE
<input type="checkbox"/>	Interface Identifier Present**
Interface Identifier Value**	<input type="text" value="0"/>
Connected Line ID Presentation (QSIG Inbound Call)*	<input type="text" value="Default"/>
Connected PBX Model	<input type="text" value="None"/>
Product Specific Configuration 	
Clock Reference*	<input type="text" value="Network"/>
Framing*	<input type="text" value="CRC4"/>
Audio Signal Adjustment into IP Network*	<input type="text" value="NoDbPadding"/>
Audio Signal Adjustment from IP Network*	<input type="text" value="NoDbPadding"/>
Zero Suppression*	<input type="text" value="HDB3"/>
Digit On Duration(50-500ms)*	<input type="text" value="100"/>
Interdigit Duration(50-500msec)*	<input type="text" value="100"/>
SNMP Community String	<input type="text" value="public"/>
Disable SNMP Set operations*	<input type="checkbox"/>
Debug Port Enable*	<input checked="" type="checkbox"/>
Hold Tone Silence Duration*	<input type="text" value="0"/>
Port Used for Voice Calls*	<input checked="" type="checkbox"/>
Port Used for Modem Calls*	<input checked="" type="checkbox"/>
Port Used for Fax Calls*	<input checked="" type="checkbox"/>
Fax and Modem Parameters	
Fax Relay Enable*	<input checked="" type="checkbox"/>
Fax Error Correction Mode Override*	<input checked="" type="checkbox"/>
Maximum Fax Rate*	<input type="text" value="14400bps"/>
Fax Payload Size*	<input type="text" value="20"/>
Non Standard Facilities Country Code*	<input type="text" value="65535"/>

Non Standard Facilities Vendor Code*	<input type="text" value="65535"/>
Fax/Modem Packet Redundancy*	<input type="checkbox"/>
NSE Type*	<input type="text" value="Non-IOS Gateways"/>

Playout Delay Parameters

Initial Playout Delay*	<input type="text" value="40"/>
Minimum Playout Delay*	<input type="text" value="20"/>
Maximum Playout Delay*	<input type="text" value="150"/>

Echo Canceller Configuration

Echo TailLength (ms)*	<input type="text" value="32 ms"/>
Minimum ERL (db)*	<input type="text" value="6 db"/>

* indicates required item
** applicable to DMS-100 protocol only
*** applicable to DMS-100 protocol and DMS-250 protocol only
**** may be required to force ringback from some PBXs

[Back to Find/List Gateways](#)

Partitions Configuration

System Route Plan Service Feature Device User Application Help

Cisco CallManager Administration
For Cisco IP Telephony Solutions

CISCO SYSTEMS

Find and List Partitions [Add a New Partition](#)



2 matching record(s) for Partition Name begins with ""

Find Partitions where Partition Name

and show items per page

To list all items, click Find without entering any search text.

Matching record(s) 1 to 2 of 2

<input type="checkbox"/>	Partition Name	Description
<input type="checkbox"/>	 Incoming Trunk	Incoming Trunk
<input type="checkbox"/>	 Phones	Phones

Page of 1

Calling Search Space Configuration

System Route Plan Service Feature Device User Application Help

Cisco CallManager Administration
For Cisco IP Telephony Solutions

CISCO SYSTEMS

Calling Search Space Configuration

[Add New Calling Search Space](#)
[Back to Find/List Calling Search Spaces](#)
[Dependency Records](#)

Calling Search Space: Incoming Trunk
Status: Ready

Calling Search Space Information

Calling Search Space Name*

Description

Route Partitions for this Calling Search Space

Find Partitions containing

Available Partitions

Phones

▼ ▲

Selected Partitions*
(ordered by highest priority)

Incoming Trunk

▲ ▼

* indicates required item

Calling Search Space Configuration

[Add New Calling Search Space](#)
[Back to Find/List Calling Search Spaces](#)
[Dependency Records](#)

Calling Search Space: Phones (in use)

Status: Ready

Calling Search Space Information

Calling Search Space Name*

Description

Route Partitions for this Calling Search Space

Find Partitions containing

Available Partitions



Selected Partitions*
(ordered by highest priority)

* indicates required item



Enbloc Route Pattern Configuration

Route Pattern/Hunt Pilot: 5XXX
Status: Ready
Note: Any update to this Route Pattern or Hunt Pilot automatically resets the associated gateway or Route/Hunt List

Pattern Definition
Route Pattern/Hunt Pilot*
Partition
Description
Numbering Plan*
Route Filter
MLPP Precedence
Gateway or Route/Hunt List* [\(Edit\)](#)
Route Option
 Route this pattern
 Block this pattern
 Provide Outside Dial Tone Allow Overlap Sending Urgent Priority

Calling Party Transformations
 Use Calling Party's External Phone Number Mask
Calling Party Transform Mask
Prefix Digits (Outgoing Calls)
Calling Line ID Presentation
Calling Name Presentation

Connected Party Transformations
Connected Line ID Presentation
Connected Name Presentation

Called Party Transformations
Discard Digits
Called Party Transform Mask
Prefix Digits (Outgoing Calls)

ISDN Network-Specific Facilities Information Element
Carrier Identification Code
Network Service Protocol
Network Service Service Parameter Name Service Parameter Value



Overlap Sending Route Pattern Configuration

Route Pattern/Hunt Pilot: 9.X

Status: Ready
Note: Any update to this Route Pattern or Hunt Pilot automatically resets the associated gateway or Route/Hunt List

Pattern Definition

Route Pattern/Hunt Pilot*

Partition

Description

Numbering Plan*

Route Filter

MLPP Precedence

Gateway or Route/Hunt List* [\(Edit\)](#)

Route Option

Route this pattern

Block this pattern

Provide Outside Dial Tone Allow Overlap Sending Urgent Priority

Calling Party Transformations

Use Calling Party's External Phone Number Mask

Calling Party Transform Mask

Prefix Digits (Outgoing Calls)

Calling Line ID Presentation

Calling Name Presentation

Connected Party Transformations

Connected Line ID Presentation

Connected Name Presentation

Called Party Transformations

Discard Digits

Called Party Transform Mask

Prefix Digits (Outgoing Calls)

ISDN Network-Specific Facilities Information Element

Carrier Identification Code

Network Service Protocol

Network Service	Service Parameter Name	Service Parameter Value
<input type="text" value=" — Not Selected —"/>	<input type="text" value=" < Not Exist >"/>	<input type="text"/>



PSTN Route Pattern Configuration

Route Pattern/Hunt Pilot: 91650XXXXXXX

Status: Ready
Note: Any update to this Route Pattern or Hunt Pilot automatically resets the associated gateway or Route/Hunt List

[Copy](#) [Update](#) [Delete](#)

Pattern Definition

Route Pattern/Hunt Pilot*

Partition

Description

Numbering Plan*

Route Filter

MLPP Precedence

Gateway or Route/Hunt List* [\(Edit\)](#)

Route Option

Route this pattern

Block this pattern

Provide Outside Dial Tone Allow Overlap Sending Urgent Priority

Calling Party Transformations

Use Calling Party's External Phone Number Mask

Calling Party Transform Mask

Prefix Digits (Outgoing Calls)

Calling Line ID Presentation

Calling Name Presentation

Connected Party Transformations

Connected Line ID Presentation

Connected Name Presentation

Called Party Transformations

Discard Digits

Called Party Transform Mask

Prefix Digits (Outgoing Calls)

ISDN Network-Specific Facilities Information Element

Carrier Identification Code

Network Service Protocol

Network Service	Service Parameter Name	Service Parameter Value
<input type="text" value=" — Not Selected —"/>	<input type="text" value=" < Not Exist >"/>	<input type="text"/>



Route Pattern for Cisco Unity Voicemail

Route Pattern/Hunt Pilot: 499X

Status: Ready
Note: Any update to this Route Pattern or Hunt Pilot automatically resets the associated gateway or Route/Hunt List

[Copy](#) [Update](#) [Delete](#)

Pattern Definition

Route Pattern/Hunt Pilot*

Partition

Description

Numbering Plan*

Route Filter

MLPP Precedence

Gateway or Route/Hunt List* [\(Edit\)](#)

Route Option

Route this pattern

Block this pattern

Provide Outside Dial Tone Allow Overlap Sending Urgent Priority

Calling Party Transformations

Use Calling Party's External Phone Number Mask

Calling Party Transform Mask

Prefix Digits (Outgoing Calls)

Calling Line ID Presentation

Calling Name Presentation

Connected Party Transformations

Connected Line ID Presentation

Connected Name Presentation

Called Party Transformations

Discard Digits

Called Party Transform Mask

Prefix Digits (Outgoing Calls)

ISDN Network-Specific Facilities Information Element

Carrier Identification Code

Network Service Protocol

Network Service	Service Parameter Name	Service Parameter Value
<input type="text" value="— Not Selected —"/>	<input type="text" value="< Not Exist >"/>	<input type="text"/>

Cisco Unity Voicemail HuntList

System
Route Plan
Service
Feature
Device
User
Application
Help

Cisco CallManager Administration
CISCO SYSTEMS

Route/Hunt List Configuration

[Add a new Route/Hunt List](#)
[Back to Find/List Route/Hunt Lists](#)
[Dependency Records](#)

Route/Hunt List Details

 CiscoUM1

Route/Hunt List: UnityHuntList

Status: Ready

Copy Update Delete Reset

Route/Hunt List Information

Route/Hunt List Name*
Description
Cisco CallManager Group*



Enable this Route/Hunt List (change effective on Update; no reset required)



Route/Hunt List Member Information

Add Route Group Add Line Group

Selected Groups*
(ordered by highest priority)

CiscoUM1

Removed Groups
(to be removed from Route/Hunt List when you click Update)

* indicates required item

Cisco Unity Voicemail Line Group



Line Group Configuration

[Add new Line Group](#)
[Back to Find/List Line Groups](#)
[Dependency Records](#)

Directory Numbers

- 4990
- 4991

Line Group: CiscoUM1

Status: Ready

Line Group Information

Line Group Name*

RNA Reversion Timeout*

Distribution Algorithm*

Hunt Options

No Answer*

Busy**

Not Available**

Line Group Member Information

Find Directory Numbers to add to Line Group

Route Partition

Directory Numbers Contains

Available DN/Route Partition
(Do not include directory numbers of application-controlled IP phones, or application-monitored IP phones in the line group.)

Current Line Group Members

Selected DN/Route Partition*

Removed DN/Route Partition
(to be removed from Line Group when you click Update)

Subscribers

- [Profile](#)
- [Account](#)
- [Phone Password](#)
- [Private Lists](#)
- [Conversation](#)
- [Call Transfer](#)
- [Greetings](#)
- [Caller Input](#)
- [Messages](#)
- [Message Notification](#)
- [Alternate Extensions](#)

Bigbird Meridian opt11c



Profile

Subscriber Information

First name:

Last name:

Display name:

Class of service: [View](#)

Extension:

Fax ID:

Recorded voice:

Active schedule: [View](#)

Time zone:

Set subscriber for self-enrollment at next login

List in phone directory

Show subscriber in e-mail server address book

Exchange Information

Alias:

Server:



[Log off](#)

© 1998-2003 Cisco Systems, Inc.

Translation Pattern for Incoming Calls

Translation Pattern Configuration

[Add a New Translation Pattern](#)
[Back to Find/List Translation Patterns](#)

Translation Pattern: 4XXX

Status: Ready

Pattern Definition

Translation Pattern	<input type="text" value="4XXX"/>
Partition	<input type="text" value="Incoming Trunk"/>
Description	<input type="text"/>
Numbering Plan*	<input type="text" value="North American Numbering Plan"/>
Route Filter	<input type="text" value="< None >"/>
Calling Search Space	<input type="text" value="Phones"/>
MLPP Precedence	<input type="text" value="Default"/>
Route Option	<input checked="" type="radio"/> Route this pattern <input type="radio"/> Block this pattern <input type="text" value="— Not Selected —"/>
<input checked="" type="checkbox"/> Provide Outside Dial Tone	<input type="checkbox"/> Allow Overlap Sending
	<input checked="" type="checkbox"/> Urgent Priority

Calling Party Transformations

Use Calling Party's External Phone Number Mask

Calling Party Transform Mask	<input type="text"/>
Prefix Digits (Outgoing Calls)	<input type="text"/>
Calling Line ID Presentation	<input type="text" value="Default"/>
Calling Name Presentation	<input type="text" value="Default"/>

Connected Party Transformations

Connected Line ID Presentation	<input type="text" value="Default"/>
Connected Name Presentation	<input type="text" value="Default"/>

Called Party Transformations

Discard Digits	<input type="text" value="< None >"/>
Called Party Transform Mask	<input type="text"/>
Prefix Digits (Outgoing Calls)	<input type="text"/>

* indicates required item.



CLIR Route Pattern Configuration

System Route Plan Service Feature Device User Application Help

Cisco CallManager Administration
For Cisco IP Telephony Solutions

CISCO SYSTEMS

Route Pattern/Hunt Pilot Configuration

[Add a New Route Pattern/Hunt Pilot](#)
[Back to Find/List Route Patterns and Hunt Pilots](#)

Route Pattern/Hunt Pilot: 5XXX

Status: Ready
Note: Any update to this Route Pattern or Hunt Pilot automatically resets the associated gateway or Route/Hunt List

Pattern Definition

Route Pattern/Hunt Pilot*	5XXX	
Partition	< None >	
Description	Siemens HiPath 4300 route	
Numbering Plan*	North American Numbering Plan	
Route Filter	< None >	
MLPP Precedence	Default	
Gateway or Route/Hunt List*	S0/DS1-0@SDA0001C9D8633E (Edit)	
Route Option	<input checked="" type="radio"/> Route this pattern <input type="radio"/> Block this pattern — Not Selected —	
<input checked="" type="checkbox"/> Provide Outside Dial Tone	<input type="checkbox"/> Allow Overlap Sending	<input type="checkbox"/> Urgent Priority

Calling Party Transformations

Use Calling Party's External Phone Number Mask

Calling Party Transform Mask	
Prefix Digits (Outgoing Calls)	
Calling Line ID Presentation	Restricted
Calling Name Presentation	Default

Connected Party Transformations

Connected Line ID Presentation	Default
Connected Name Presentation	Default

Called Party Transformations

Discard Digits	< None >
----------------	----------

CNIR Route Pattern Configuration

System
Route Plan
Service
Feature
Device
User
Application
Help

Cisco CallManager Administration
CISCO SYSTEMS

Route Pattern/Hunt Pilot Configuration

[Add a New Route Pattern/Hunt Pilot](#)
[Back to Find/List Route Patterns and Hunt Pilots](#)

Route Pattern/Hunt Pilot: 5XXX

Status: Update completed
 Note: Any update to this Route Pattern or Hunt Pilot automatically resets the associated gateway or Route/Hunt List

Pattern Definition

Route Pattern/Hunt Pilot*	<input type="text" value="5XXX"/>
Partition	< None >
Description	Siemens HiPath 4300 route
Numbering Plan*	North American Numbering Plan
Route Filter	< None >
MLPP Precedence	Default
Gateway or Route/Hunt List*	S0/DS1-0@SDA0001C9D8633E (Edit)
Route Option	<input checked="" type="radio"/> Route this pattern <input type="radio"/> Block this pattern <input type="text" value="-- Not Selected --"/>
<input checked="" type="checkbox"/> Provide Outside Dial Tone <input type="checkbox"/> Allow Overlap Sending <input type="checkbox"/> Urgent Priority	

Calling Party Transformations

Use Calling Party's External Phone Number Mask

Calling Party Transform Mask	<input type="text"/>
Prefix Digits (Outgoing Calls)	<input type="text"/>
Calling Line ID Presentation	Default
Calling Name Presentation	Restricted

Connected Party Transformations

Connected Line ID Presentation	Default
Connected Name Presentation	Default

Called Party Transformations

Discard Digits	< None >
----------------	----------



COLR Translation Pattern Configuration

Translation Pattern Configuration

[Add a New Translation Pattern](#)
[Back to Find/List Translation Patterns](#)

Translation Pattern: 4XXX
Status: Update completed

Pattern Definition

Translation Pattern	<input type="text" value="4XXX"/>
Partition	<input type="text" value="Incoming Trunk"/>
Description	<input type="text"/>
Numbering Plan*	<input type="text" value="North American Numbering Plan"/>
Route Filter	<input type="text" value="< None >"/>
Calling Search Space	<input type="text" value="Phones"/>
MLPP Precedence	<input type="text" value="Default"/>
Route Option	<input checked="" type="radio"/> Route this pattern <input type="radio"/> Block this pattern <input type="text" value="— Not Selected —"/>

Provide Outside Dial Tone Urgent Priority

Calling Party Transformations

Use Calling Party's External Phone Number Mask

Calling Party Transform Mask	<input type="text"/>
Prefix Digits (Outgoing Calls)	<input type="text"/>
Calling Line ID Presentation	<input type="text" value="Default"/>
Calling Name Presentation	<input type="text" value="Default"/>

Connected Party Transformations

Connected Line ID Presentation	<input type="text" value="Restricted"/>
Connected Name Presentation	<input type="text" value="Default"/>

Called Party Transformations

Discard Digits	<input type="text" value="< None >"/>
Called Party Transform Mask	<input type="text"/>
Prefix Digits (Outgoing Calls)	<input type="text"/>

* indicates required item.

CONR Translation Pattern Configuration

Translation Pattern Configuration

[Add a New Translation Pattern](#)
[Back to Find/List Translation Patterns](#)

Translation Pattern: 4XXX

Status: Update completed

Pattern Definition

Translation Pattern	<input type="text" value="4XXX"/>
Partition	<input type="text" value="Incoming Trunk"/>
Description	<input type="text"/>
Numbering Plan*	<input type="text" value="North American Numbering Plan"/>
Route Filter	<input type="text" value=" < None >"/>
Calling Search Space	<input type="text" value="Phones"/>
MLPP Precedence	<input type="text" value="Default"/>
Route Option	<input checked="" type="radio"/> Route this pattern <input type="radio"/> Block this pattern <input type="text" value=" - Not Selected -"/>
<input checked="" type="checkbox"/> Provide Outside Dial Tone	<input checked="" type="checkbox"/> Urgent Priority

Calling Party Transformations

Use Calling Party's External Phone Number Mask

Calling Party Transform Mask	<input type="text"/>
Prefix Digits (Outgoing Calls)	<input type="text"/>
Calling Line ID Presentation	<input type="text" value="Default"/>
Calling Name Presentation	<input type="text" value="Default"/>

Connected Party Transformations

Connected Line ID Presentation	<input type="text" value="Default"/>
Connected Name Presentation	<input type="text" value="Restricted"/>

Called Party Transformations

Discard Digits	<input type="text" value=" < None >"/>
Called Party Transform Mask	<input type="text"/>
Prefix Digits (Outgoing Calls)	<input type="text"/>

* indicates required item.

Phone Configuration

[Add a new phone](#)
[Add/Update Speed Dials](#)
[Subscribe/Unsubscribe Services](#)
[Dependency Records](#)
[Back to Find/List Phones](#)

- Directory Numbers**
- 7912 Line 1 - 4001 in
 - 7919 Phones
 - 7912 Line 2 - Add new DN
 - 7919

Phone: SEP003094C39863 (Auto 4001)
Registration: Registered with Cisco CallManager 172.20.32.254
IP Address: [172.20.32.110](#)
Status: Ready

Phone Configuration (Model = Cisco 7960)

Device Information

MAC Address*	<input type="text" value="003094C39863"/>
Description	<input type="text" value="Auto 4001"/>
Owner User ID	<input type="text"/> (Select User ID)
Device Pool*	<input type="text" value="Default"/> (View details)
Calling Search Space	<input type="text" value="< None >"/>
AAR Calling Search Space	<input type="text" value="< None >"/>
Media Resource Group List	<input type="text" value="< None >"/>
User Hold Audio Source	<input type="text" value="< None >"/>
Network Hold Audio Source	<input type="text" value="< None >"/>
Location	<input type="text" value="< None >"/>
User Locale	<input type="text" value="< None >"/>
Network Locale	<input type="text" value="< None >"/>
Device Security Mode	<input type="text" value="Use System Default"/>
Built In Bridge	<input type="text" value="Default"/>
Privacy	<input type="text" value="Default"/>

Phone Button Template Information

Phone Button Template*	<input type="text" value="Standard 7960"/> (View button list)
------------------------	---

Softkey Template Information

Softkey Template	<input type="text" value="< None >"/>
------------------	---

Expansion Module Information

Module 1	<input type="text" value="< None >"/>
Module 2	<input type="text" value="< None >"/>



Module 1 Load Name	<input type="text"/>	(Module 1 selection required)
Module 2 Load Name	<input type="text"/>	(Module 2 selection required)
Cisco IP Phone - External Data Locations (leave blank to use default)		
Information	<input type="text"/>	
Directory	<input type="text"/>	
Messages	<input type="text"/>	
Services	<input type="text"/>	
Authentication Server	<input type="text"/>	
Proxy Server	<input type="text"/>	
Idle	<input type="text"/>	
Idle Timer (seconds)	<input type="text"/>	
Extension Mobility (Device Profile) Information		
<input type="checkbox"/> Enable Extension Mobility Feature		
Log Out Profile	<input type="text" value="-- Not Selected --"/>	
Log In User ID	<input type="text" value="< None >"/>	
Log In Time	<input type="text" value="< None >"/>	
Log Out Time	<input type="text" value="< None >"/>	
Multilevel Precedence and Preemption (MLPP) Information		
MLPP Domain	<input type="text" value=""/>	(e.g., "0000FF")
MLPP Indication	<input type="text" value="Default"/>	
MLPP Preemption	<input type="text" value="Default"/>	
Product Specific Configuration 		
Disable Speakerphone	<input type="checkbox"/>	
Disable Speakerphone and Headset	<input type="checkbox"/>	
Forwarding Delay*	<input type="text" value="Disabled"/>	
PC Port*	<input type="text" value="Enabled"/>	
Settings Access*	<input type="text" value="Enabled"/>	
Gratuitous ARP*	<input type="text" value="Enabled"/>	
PC Voice VLAN Access*	<input type="text" value="Enabled"/>	
Video Capabilities*	<input type="text" value="Disabled"/>	
Auto Line Select*	<input type="text" value="Disabled"/>	

Directory Number Configuration

[Configure Device \(SEP003094C39863\)](#)
[Dependency Records](#)

Associated With

SEP003094C39863
 7960 (Line 1)

Directory Number: 4001 (Phones)

Status: Ready

Note: Any update to this Directory Number automatically resets the associated devices

Directory Number

Directory Number*
 Partition

Directory Number Settings

Voice Mail Profile
 (Choose <None> to use default)
 Calling Search Space
 AAR Group
 User Hold Audio Source
 Network Hold Audio Source
 Auto Answer

Call Forward and Pickup Settings

	Voice Mail Destination	Calling Search Space
Forward All <input type="checkbox"/>	<input type="text"/>	<input type="text" value=" < None >"/>
Forward Busy <input type="checkbox"/>	<input type="text"/>	<input type="text" value=" < None >"/>
Forward No Answer <input type="checkbox"/>	<input type="text"/>	<input type="text" value=" < None >"/>
No Answer Ring Duration <input type="text"/>	(seconds)	
Call Pickup Group <input type="text"/>	<input type="text" value=" < None >"/>	

MLPP Alternate Party Settings

Target (Destination)
 Calling Search Space
 No Answer Ring Duration (seconds)

Line Settings for this Device

Display (Internal Caller ID)
 Line Text Label
 External Phone Number Mask

Message Waiting Lamp Policy	<input type="text" value="Use System Policy"/>
Ring Setting (Phone Idle)	<input type="text" value="Use System Default"/>
Ring Setting (Phone Active)**	<input type="text" value="Use System Default"/>
Multiple Call / Call Waiting Settings	
Maximum Number of Calls*	<input type="text" value="4"/> (1 - 200)
Busy Trigger*	<input type="text" value="2"/> (<= Max. Calls)
Forwarded Call Information Display	
<input checked="" type="checkbox"/> Caller Name	<input checked="" type="checkbox"/> Caller Number
<input checked="" type="checkbox"/> Redirected Number	<input checked="" type="checkbox"/> Dialed Number
<p>* indicates required item; changes to Line or Directory Number settings require restart. ** Ring Setting (Phone Active) applies to this line when any line on the phone has a call in progress.</p>	
Note: If you are using a language other than English for Display (Internal Caller ID) or Line Text Label text, make sure the correct character set (shown below) is selected. Text displays incorrectly if the wrong character set is selected. (English characters are included in all character sets.)	
Character Set	<input type="text" value="Western European (Latin 1)"/>



Acronyms

Acronym	Definitions
CCM	Cisco CallManager
CFB	Call Forwarding Busy
CFNR	Call Forwarding No Reply
CFU	Call Forwarding Unconditional
CLIP	Calling Line (Number) Identification Presentation
CLIR	Calling Line (Number) Identification Restriction
CNIP	Calling Name Identification Presentation
CNIR	Calling Name Identification Restriction
COLP	Connected Line (Number) Identification Presentation
COLR	Connected Line (Number) Identification Restriction
CONP	Connected Name Identification Presentation
CONR	Connected Name Identification Restriction
CT	Call Transfer
PSTN	Public Switched Telephone Network



Important Information

THE SPECIFICATIONS AND INFORMATION REGARDING THE PRODUCTS IN THIS MANUAL ARE SUBJECT TO CHANGE WITHOUT NOTICE. ALL STATEMENTS, INFORMATION, AND RECOMMENDATIONS IN THIS MANUAL ARE BELIEVED TO BE ACCURATE BUT ARE PRESENTED WITHOUT WARRANTY OF ANY KIND, EXPRESS OR IMPLIED. USERS MUST TAKE FULL RESPONSIBILITY FOR THEIR APPLICATION OF ANY PRODUCTS.

IN NO EVENT SHALL CISCO OR ITS SUPPLIERS BE LIABLE FOR ANY INDIRECT, SPECIAL, CONSEQUENTIAL, OR INCIDENTAL DAMAGES, INCLUDING, WITHOUT LIMITATION, LOST PROFITS OR LOSS OR DAMAGE TO DATA ARISING OUT OF THE USE OR INABILITY TO USE THIS MANUAL, EVEN IF CISCO OR ITS SUPPLIERS HAVE BEEN ADVISED OF THE POSSIBILITY OF SUCH DAMAGES.



**Corporate
Headquarters**

Cisco Systems, Inc.
170 West Tasman Drive
San Jose, CA 95134-1706
USA
www.cisco.com
Tel: 408 526-4000
800 553-NETS (6387)
Fax: 408 526-4100

**European
Headquarters**

Cisco Systems International
BV
Haarlerbergpark
Haarlerbergweg 13-19
1101 CH Amsterdam
The Netherlands
www-europe.cisco.com
Tel: 31 0 20 357 1000
Fax: 31 0 20 357 1100

**Americas
Headquarters**

Cisco Systems, Inc.
170 West Tasman Drive
San Jose, CA 95134-1706
USA
www.cisco.com
Tel: 408 526-7660
Fax: 408 527-0883

**Asia Pacific
Headquarters**

Cisco Systems, Inc.
Capital Tower
168 Robinson Road
#22-01 to #29-01
Singapore 068912
www.cisco.com
Tel: +65 317 7777
Fax: +65 317 7799

Cisco Systems has more than 200 offices in the following countries and regions. Addresses, phone numbers, and fax numbers are listed on the Cisco Web site at www.cisco.com/go/offices.

Argentina • Australia • Austria • Belgium • Brazil • Bulgaria • Canada • Chile • China PRC • Colombia • Costa Rica • Croatia • Czech Republic • Denmark • Dubai, UAE • Finland • France • Germany • Greece • Hong Kong SAR • Hungary • India • Indonesia • Ireland • Israel • Italy • Japan • Korea • Luxembourg • Malaysia • Mexico • The Netherlands • New Zealand • Norway • Peru • Philippines • Poland • Portugal • Puerto Rico • Romania • Russia • Saudi Arabia • Scotland • Singapore • Slovakia • Slovenia • South Africa • Spain • Sweden • Switzerland • Taiwan • Thailand • Turkey • Ukraine • United Kingdom • United States • Venezuela • Vietnam • Zimbabwe

© 2007 Cisco Systems, Inc. All rights reserved.

CCVP, the Cisco logo, and Welcome to the Human Network are trademarks of Cisco Systems, Inc.; Changing the Way We Work, Live, Play, and Learn is a service mark of Cisco Systems, Inc.; and Access Registrar, Aironet, Catalyst, CCDA, CCDP, CCIE, CCIP, CCNA, CCNP, CCSP, Cisco, the Cisco Certified Internetwork Expert logo, Cisco IOS, Cisco Press, Cisco Systems, Cisco Systems Capital, the Cisco Systems logo, Cisco Unity, Enterprise/Solver, EtherChannel, EtherFast, EtherSwitch, Fast Step, Follow Me Browsing, FormShare, GigaDrive, HomeLink, Internet Quotient, IOS, iPhone, IP/TV, iQ Expertise, the iQ logo, iQ Net Readiness Scorecard, iQuick Study, LightStream, Linksys, MeetingPlace, MGX, Networkers, Networking Academy, Network Registrar, PIX, ProConnect, ScriptShare, SMARTnet, StackWise, The Fastest Way to Increase Your Internet Quotient, and TransPath are registered trademarks of Cisco Systems, Inc. and/or its affiliates in the United States and certain other countries.

All other trademarks mentioned in this document or Website are the property of their respective owners. The use of the word partner does not imply a partnership relationship between Cisco and any other company. (0711R)

Printed in the USA