



Optimizing the Service Provider Network for Voice, Video, and Data

Santiago Alvarez

saalvare@cisco.com

Internet Technologies Division

December 2005

Agenda

- **Introduction**
- **Designing the edge**
- **Designing the backbone**
- **Summary and references**

Differentiated Services Architecture

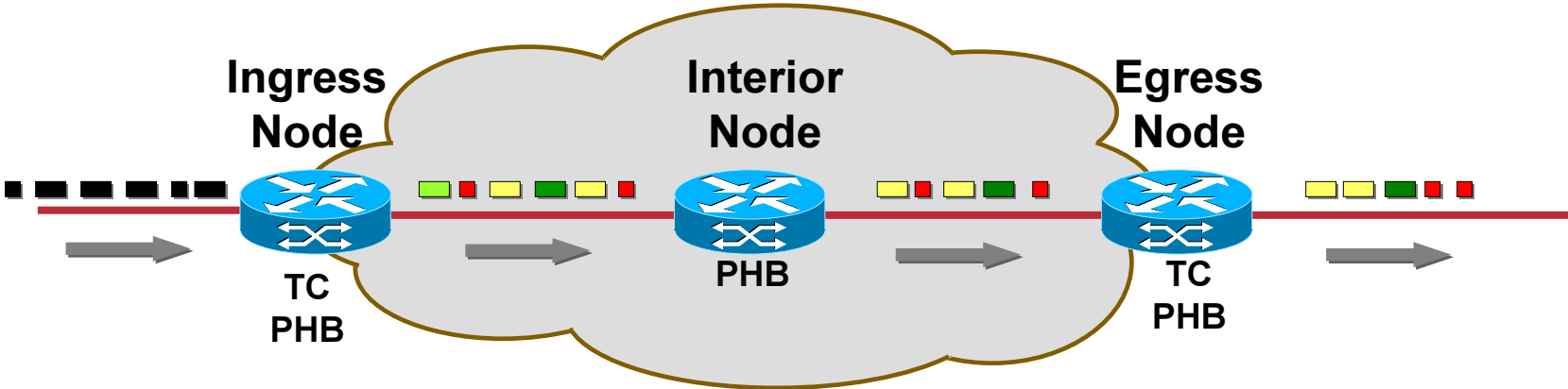

Traffic Classification and Conditioning

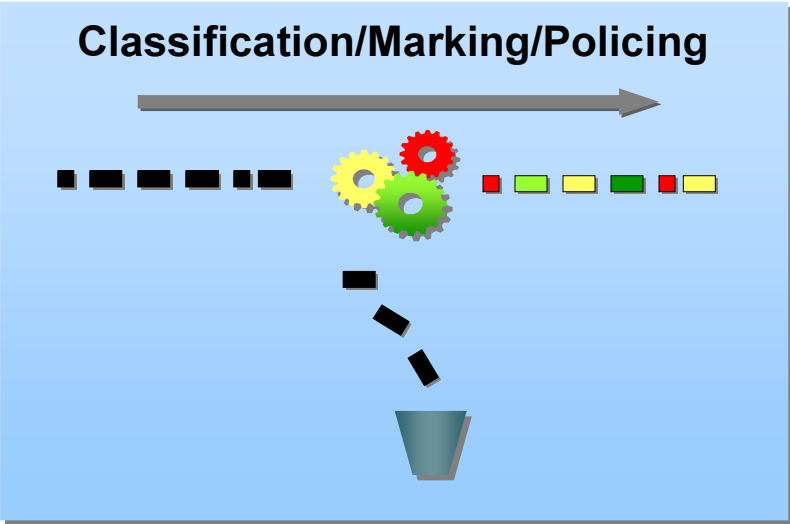

Per-Hop Behavior (PHB)

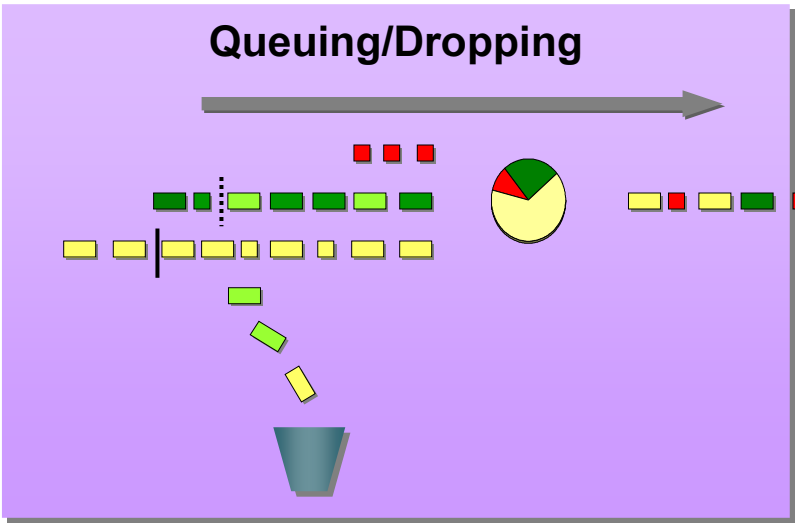

Per-Hop Behaviors

- **Expedited Forwarding (EF)**
 - Building block for low delay/ jitter/loss**
 - Served at a certain rate with short/empty queues**
- **Assured Forwarding (AF)**
 - High probability of delivery if profile is not exceeded**
 - Four classes and three levels of drop precedence**
 - Specific resources (BW, buffer space) allocated to each class at each node**
- **Best Effort (BE)**

PHB Recommended Codepoints for IP

IP Packet



EF



AFxy



Class

Drop
Precedence

Precedence

BE



MPLS Label Header for Packet Media



Label **20 bits**
EXP **Experimental Field, 3 bits**
S **Bottom of Stack, 1 Bit**
TTL **Time to Live, 8 Bits**

- **Can be used over other Layer 2 technologies**
- **Contains all information needed at forwarding time**
- **One 32-bit word per label**

Traditional Enterprise Network

- SP sells Layer 2 service
- Point-to-point SLA from SP
- Enterprise WAN likely to get congested
- IP QoS required for VVD integration
- SP not involved in IP QoS

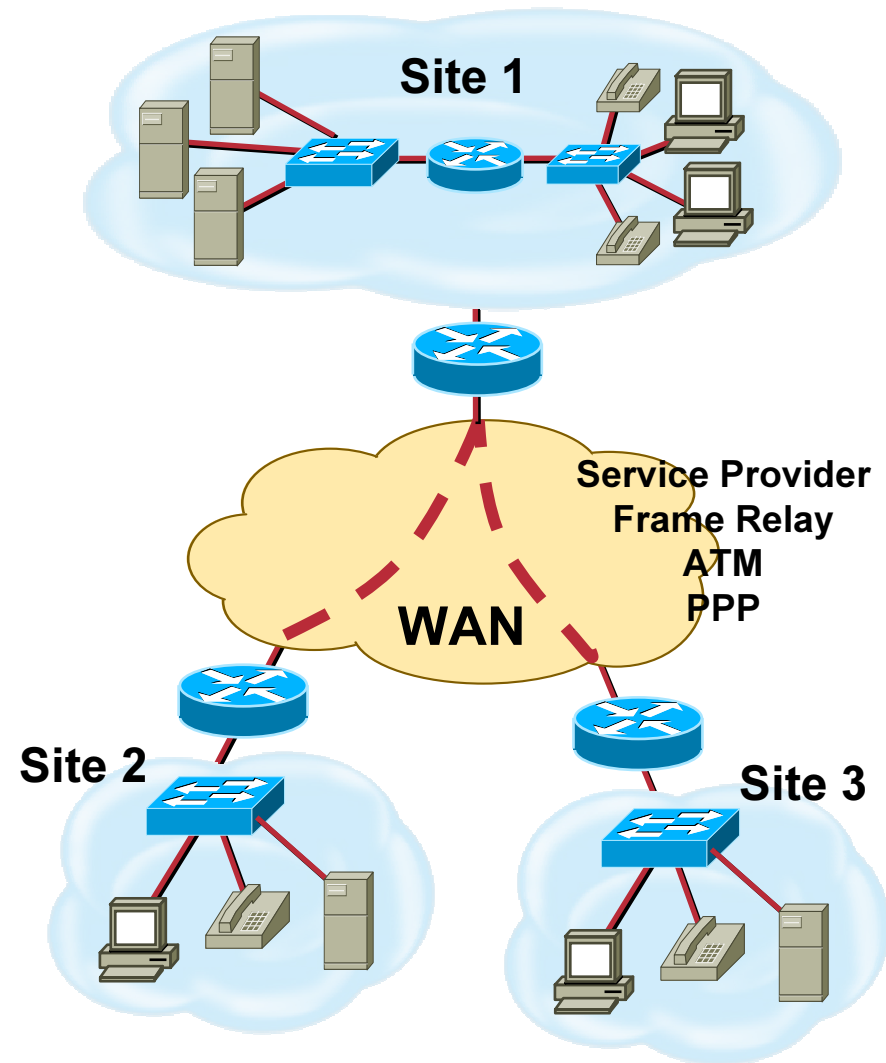

Enterprise Network with IP Service

- SP sells Layer 3 service
- Point-to-Cloud SLA from SP
- Enterprise WAN likely to get congested
- QoS required for VVD integration
- SP involved in IP QoS

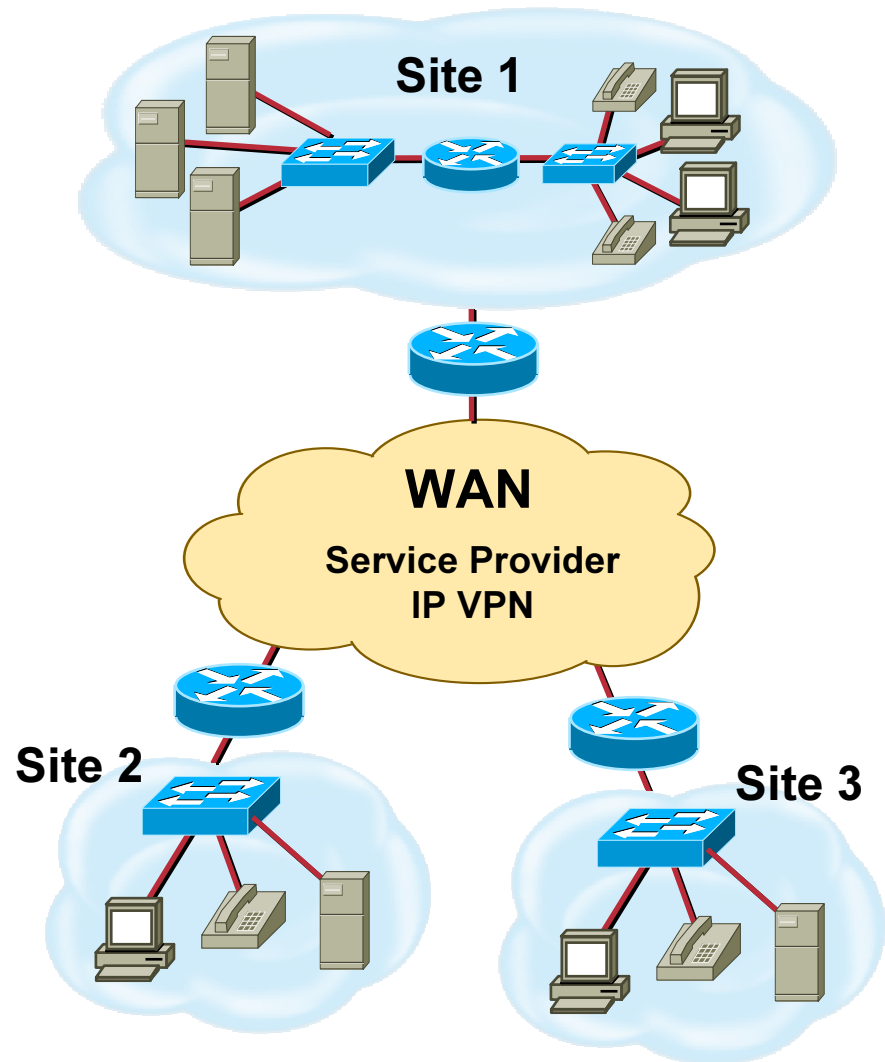

Enterprise Network with Layer-2 Service

- Enterprise may continue with Layer 2 services
- SP needs to consolidate Layer 2 and Layer 3 services
- Layer 2 and Layer 3 SLAs with same IP/MPLS network

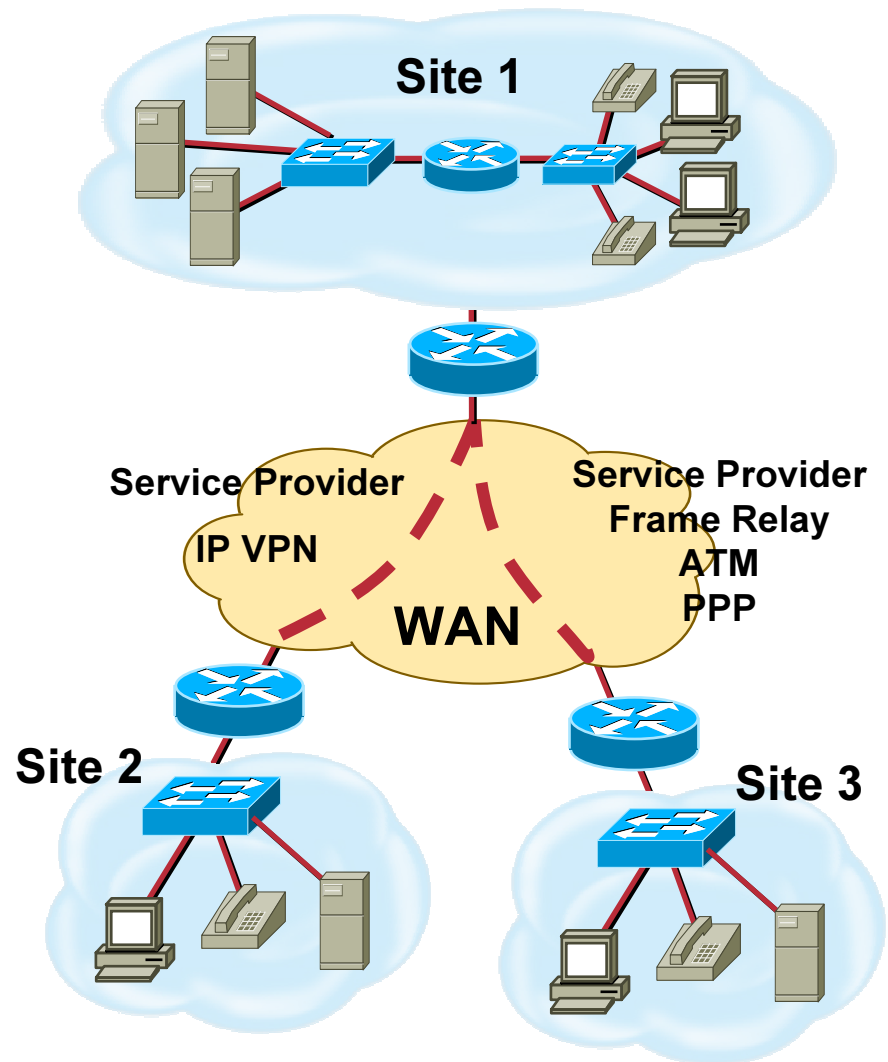

Cisco IOS IP SLAs

- Point-to-cloud guarantees for conforming traffic
- Any site can transmit up to ICR into the cloud
- Any site can receive up to ECR from the cloud

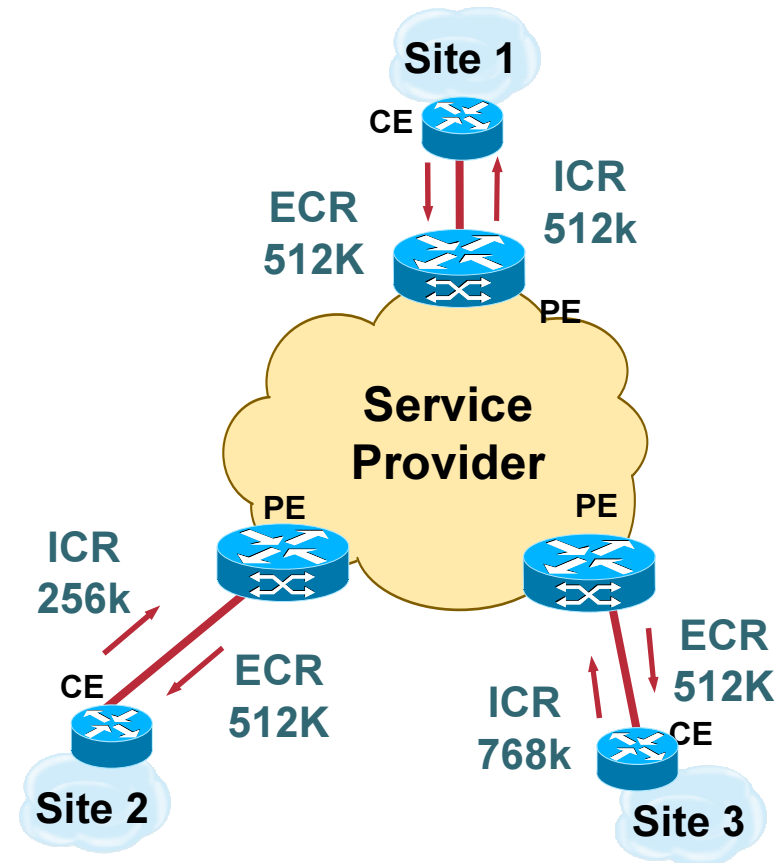

ECR – Egress Committed Rate
ICR – Ingress Committed Rate

Cisco IOS IP SLAs (Cont'd.)

- **SLA typically includes between 3 and 5 classes (real time, video, business, bulk, BE)**
- **Real-time traffic gets fixed bandwidth allocation**
- **Data traffic gets variable bandwidth allocation with minimum guarantee**
- **Frequently, bandwidth allocations defined as percentage of sub-rate (e.g. PVC CIR, shaped rate)**
- **Additional classes not visible to customer may exist at the edge (e.g. management/control traffic)**

**SLA per interface
(possibly sub-rate)**

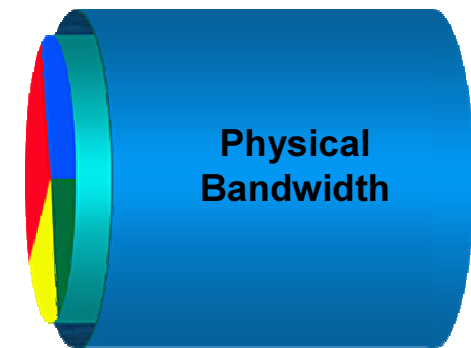

SLA per PVC / VLAN

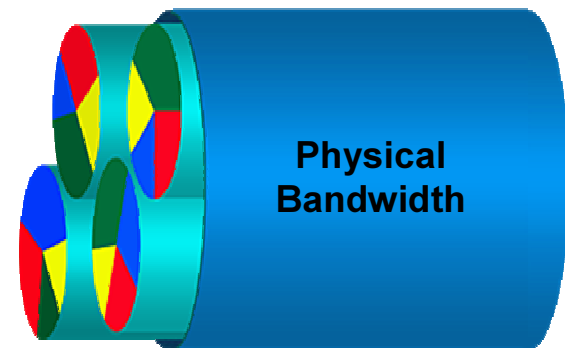

Where is the SP Edge?

- **Managed vs. unmanaged IP service**
- **Trust boundary implications**
- **Different QoS design options**
- **Edge QoS policies offloaded to CE for managed IP**

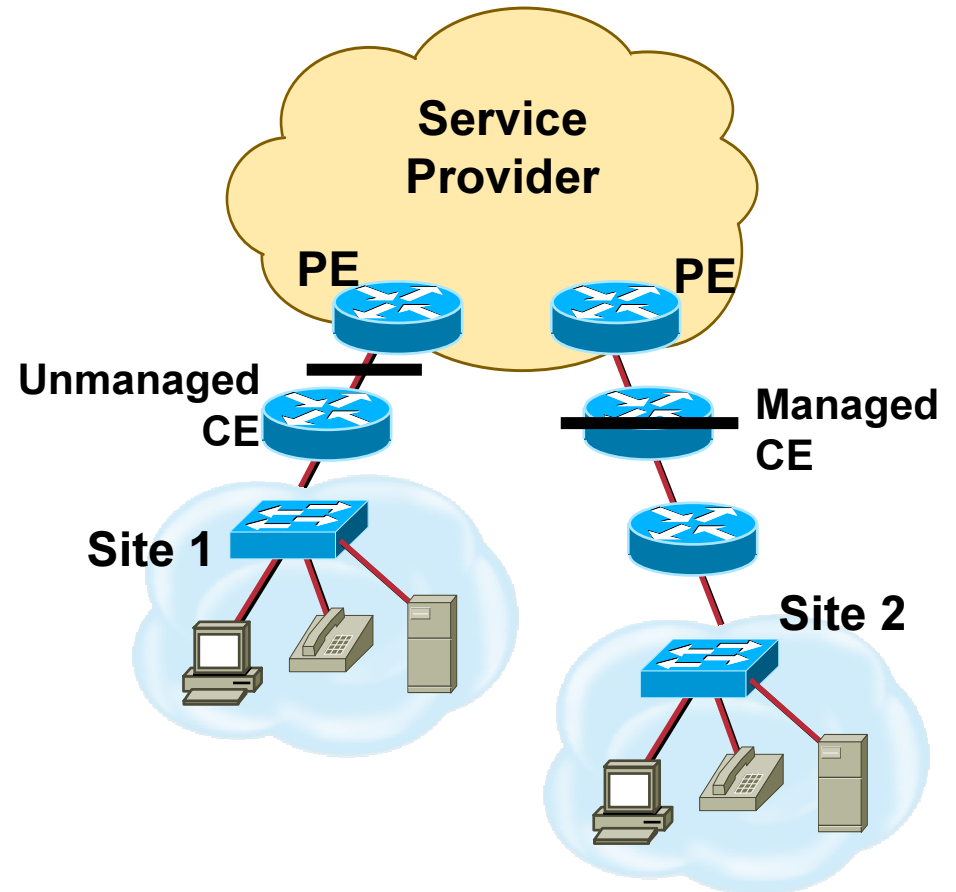

Traffic Leaving Enterprise Network

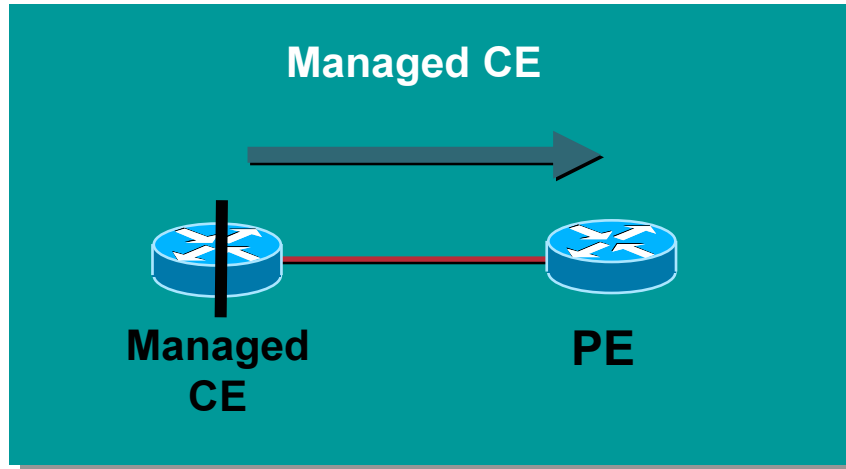

- Output QoS policy on CE controlled by SP
- SP enforces SLA using the output QoS policy on CE
- Output policy uses queuing, dropping and optionally, shaping
- Elaborate traffic classification or mapping of existing markings
- Slow links require LFI / cRTP

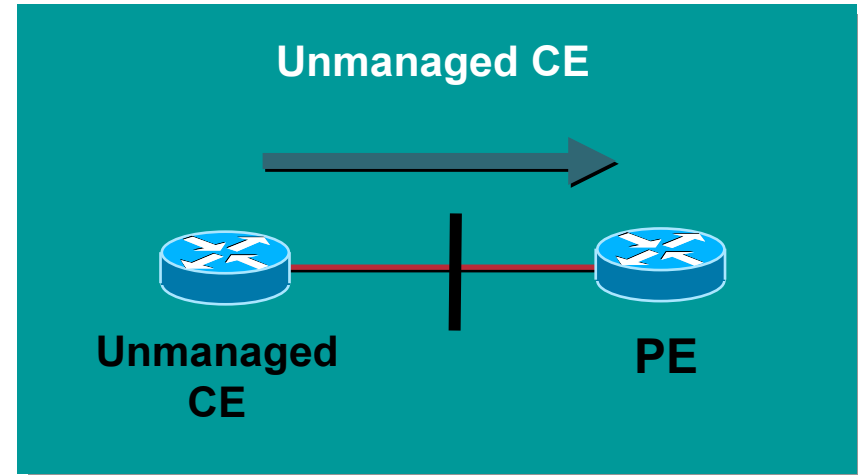

- Output QoS policy on CE not controlled by SP
- SP enforces SLA using input QoS policy on PE
- Input policy uses policing and marking
- Elaborate traffic classification or mapping of existing markings on PE

Traffic Leaving Enterprise Network

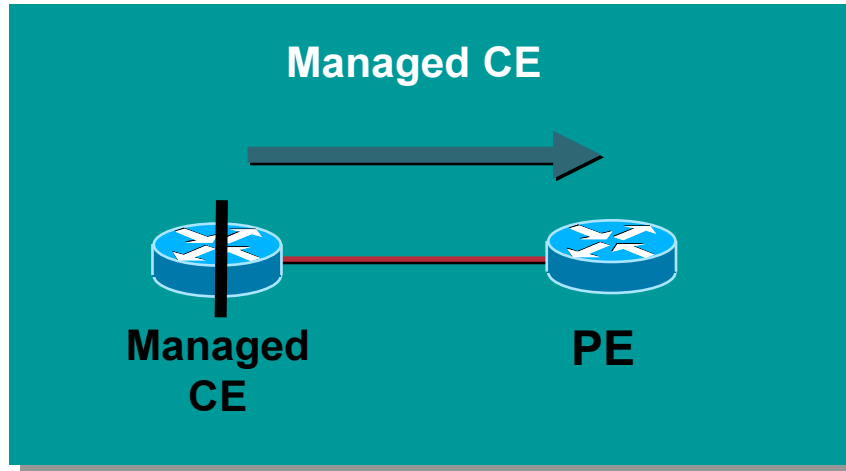

CE	PE
Output Policy	Input Policy
Classification / Marking / Mapping	<Not required>
LLQ	
WRED	
[Shaping]	
[LFI / cRTP]	

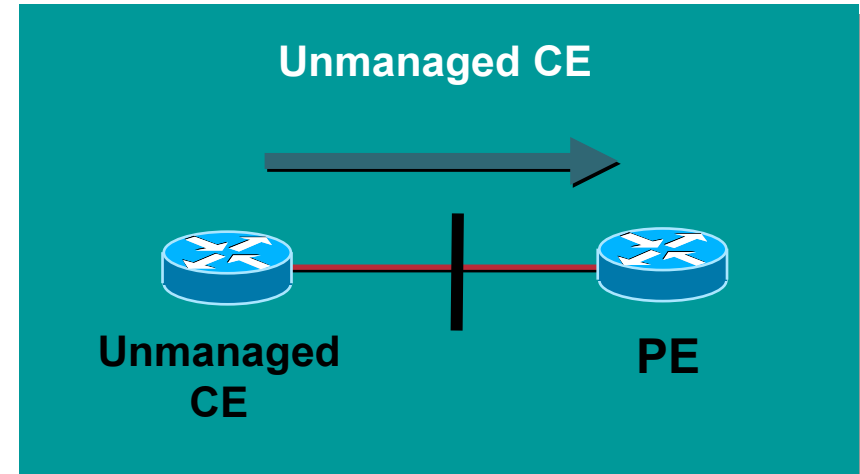

CE	PE
Output Policy	Input Policy
<irrelevant>	Classification / Marking / Mapping
	Policing

Traffic Leaving Service Provider Network

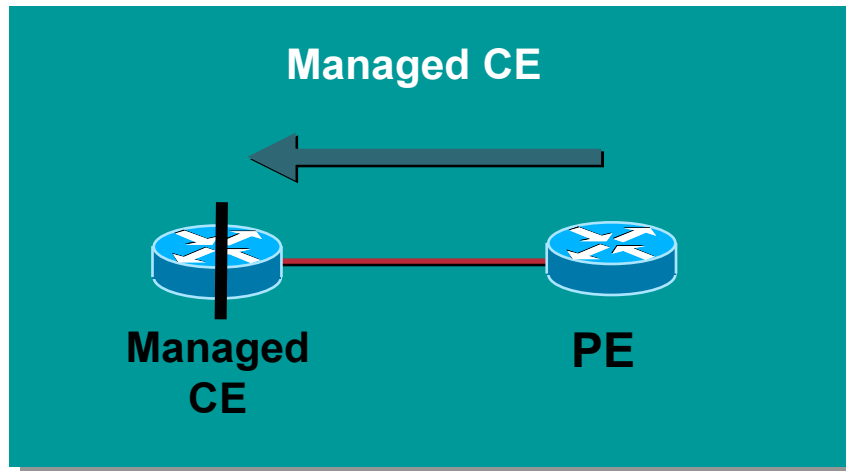

- SP enforces SLA using the output QoS policy on PE
- Output policy uses queuing, dropping and optionally, shaping
- Slow links require LFI / cRTP
- No input QoS policy on CE needed

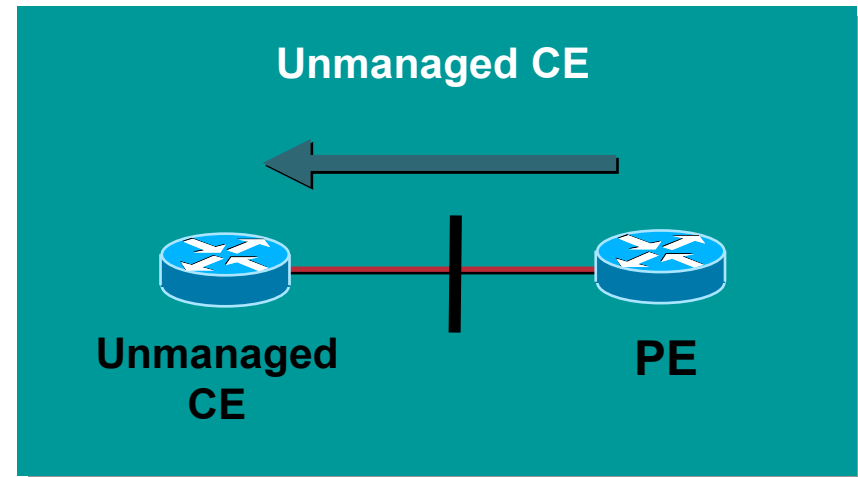

- SP enforces SLA using the output QoS policy on PE
- Output policy uses queuing, dropping and optionally, shaping
- Slow links require LFI / cRTP
- Input QoS policy on CE irrelevant

Traffic Leaving Service Provider Network

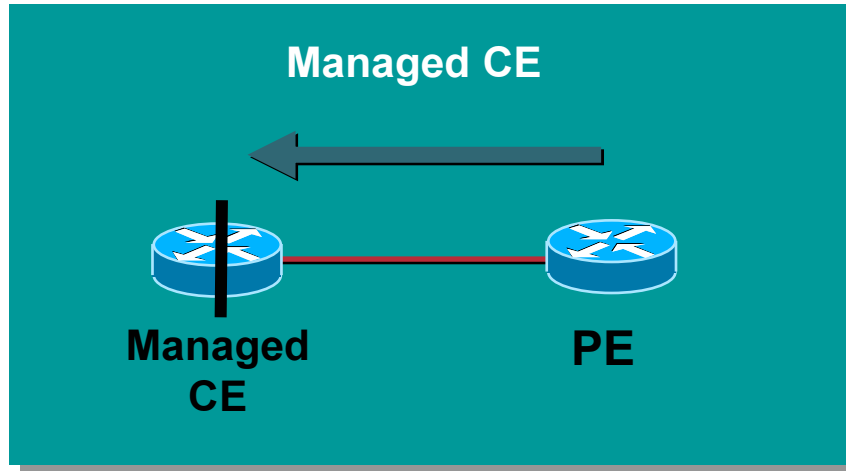

CE
Input Policy
<Not needed>

PE
Output Policy
LLQ
WRED
[Shaping]
[LFI / cRTP]

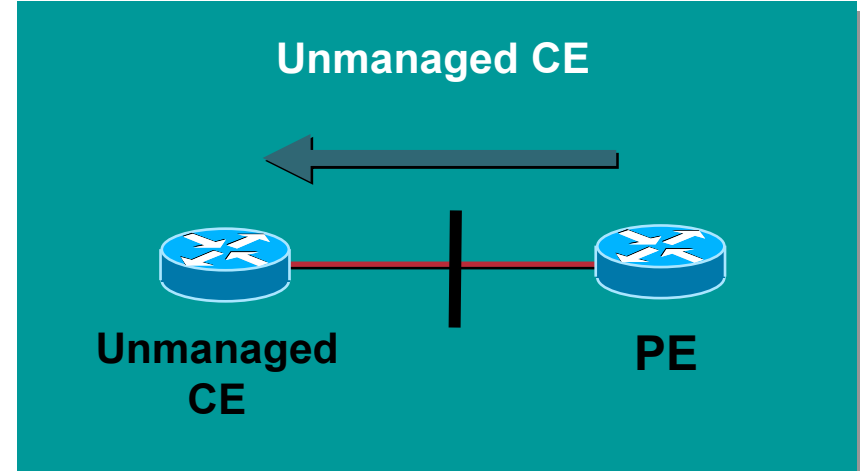

CE
Input Policy
<Irrelevant>

PE
Output Policy
LLQ
WRED
[Shaping]
[LFI / cRTP]

Layer 2 SLAs

- **FR / ATM customers receive traditional SLA**
- **FR / ATM / Ethernet access network may enforce SLA**
- **Pay-as-you-grow services can be implemented for PPP / HDLC**
- **Service is typically unmanaged**

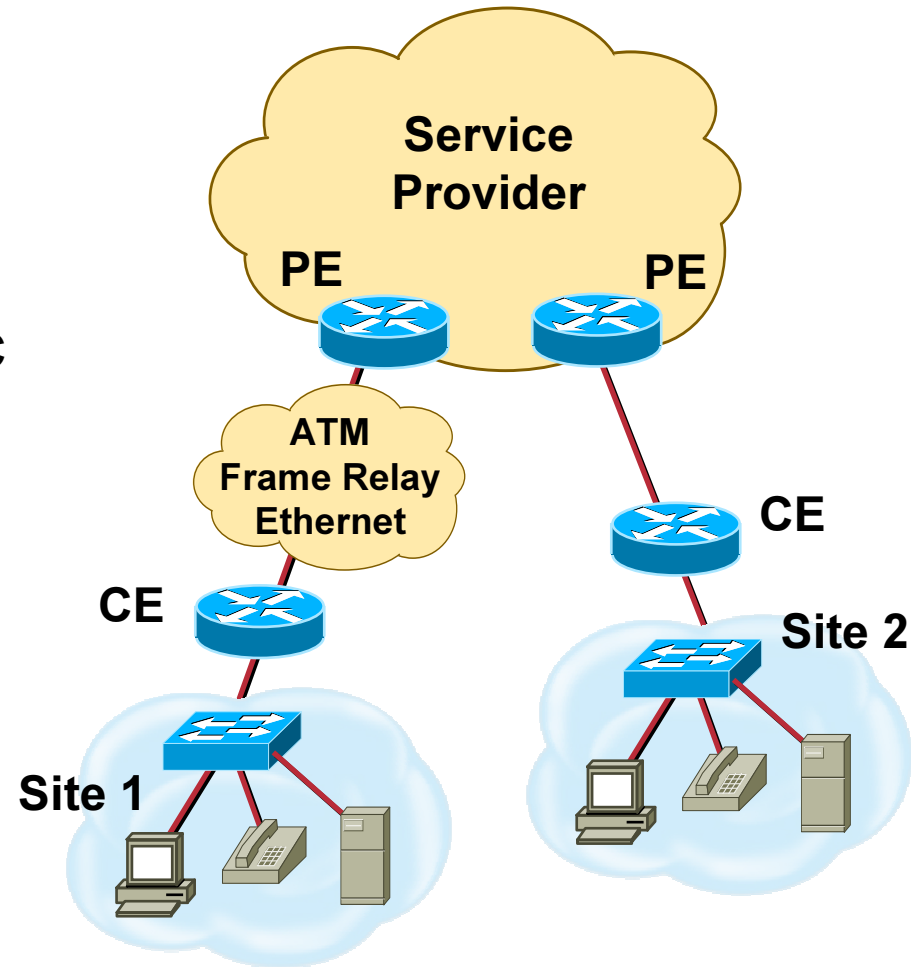

Traffic Leaving Enterprise Network

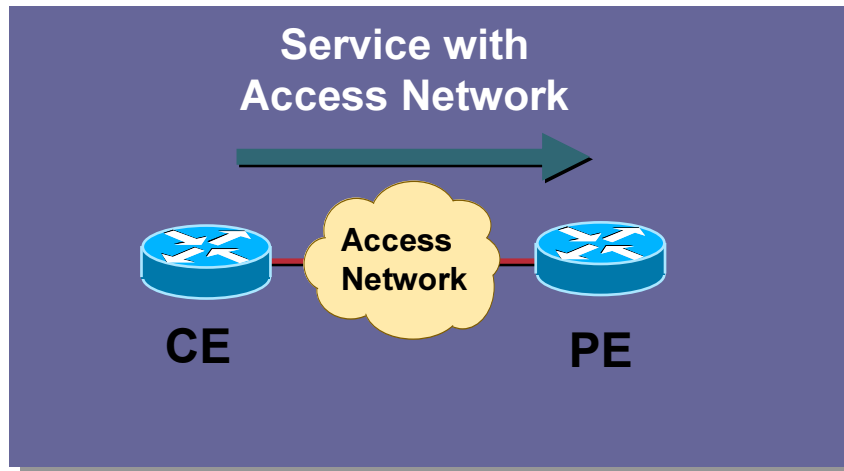

- SP enforces SLA on access network preferably
- Drop precedence may be marked for FR / ATM / Ethernet
- Ethernet may support multiple classes
- PE may mark traffic after encapsulation
- No elaborate traffic classification or mapping of existing IP markings

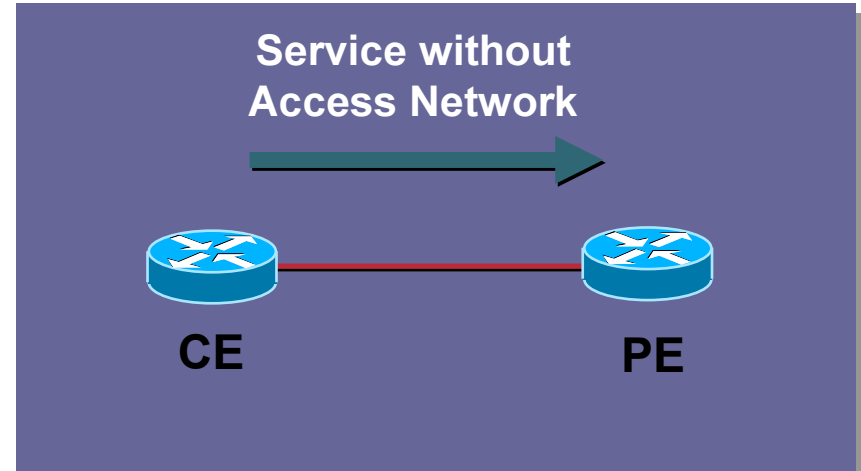

- SP enforces SLA using input QoS policy on PE
- Input policy uses policing and marking
- Drop precedence may be marked for FR / ATM / Ethernet
- Ethernet may support multiple classes
- PE may mark traffic after encapsulation
- No Elaborate traffic classification or mapping of existing markings on PE

Traffic Leaving Enterprise Network

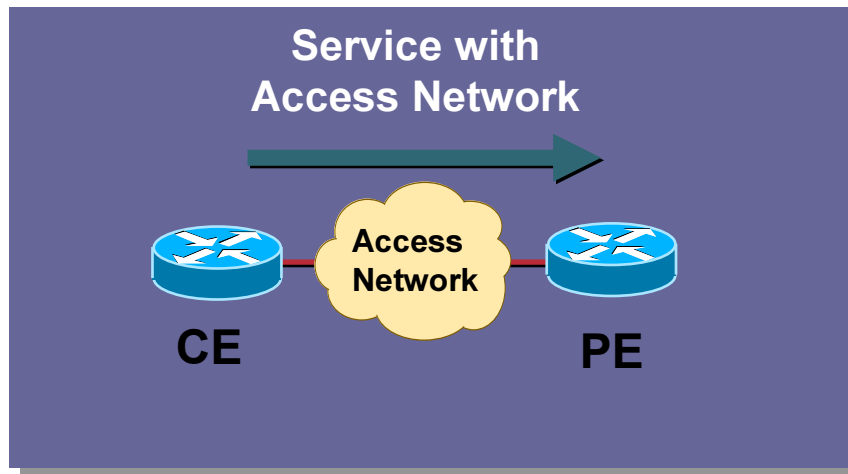

CE	Access Network	PE
Output Policy	Input Policy	Input Policy
<irrelevant>	Policing	[Marking]
	[Marking]	

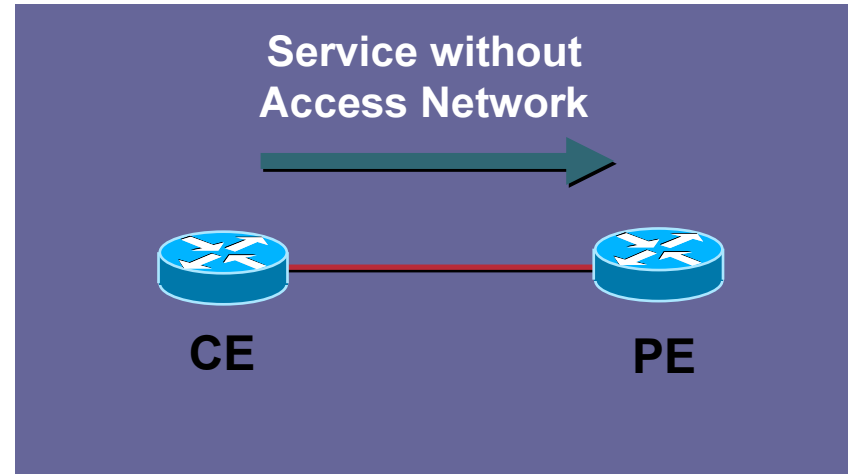

CE	PE
Output Policy	Input Policy
<irrelevant>	Policing
	[Marking]

Traffic Leaving Service Provider Network

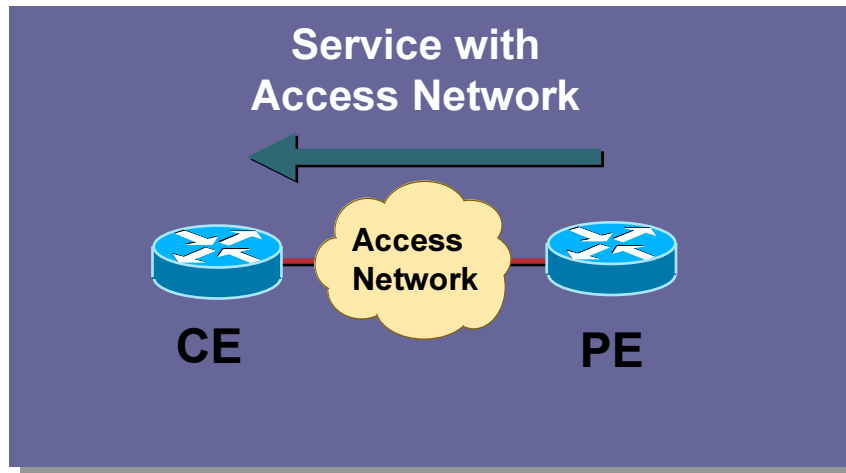

- SP enforces SLA on access network preferably
- Access network should serve packets according to their marking (class / drop precedence) where applicable

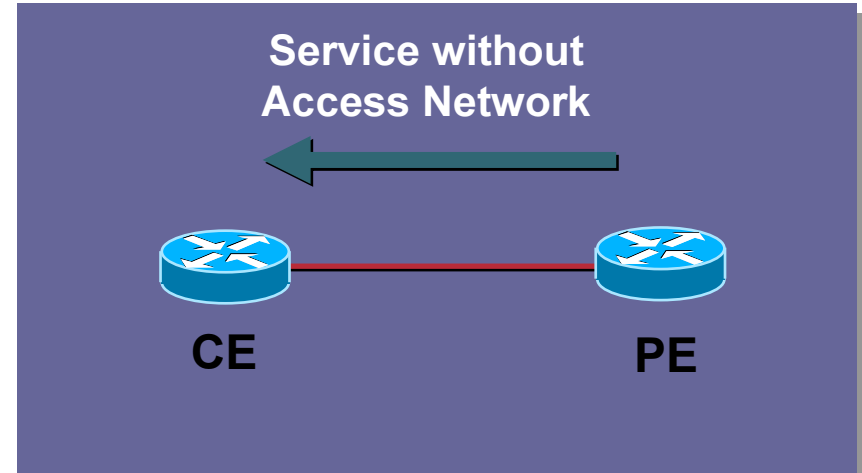

- SP enforces SLA using the output QoS policy on PE
- Output policy uses queuing, dropping and optionally, shaping

Traffic Leaving Service Provider Network

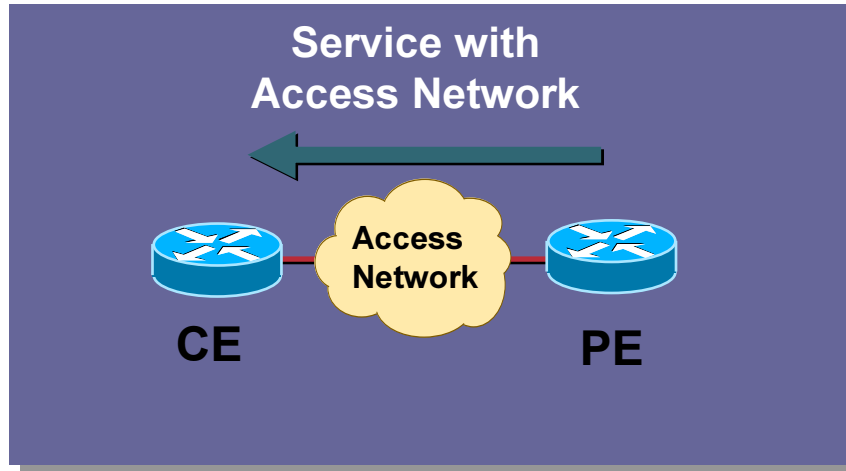

CE	Access Network	PE
Input Policy	Output Policy	Output Policy
<irrelevant>	Queuing (LLQ)	<optional>
	Dropping (WRED)	
	[Shaping]	

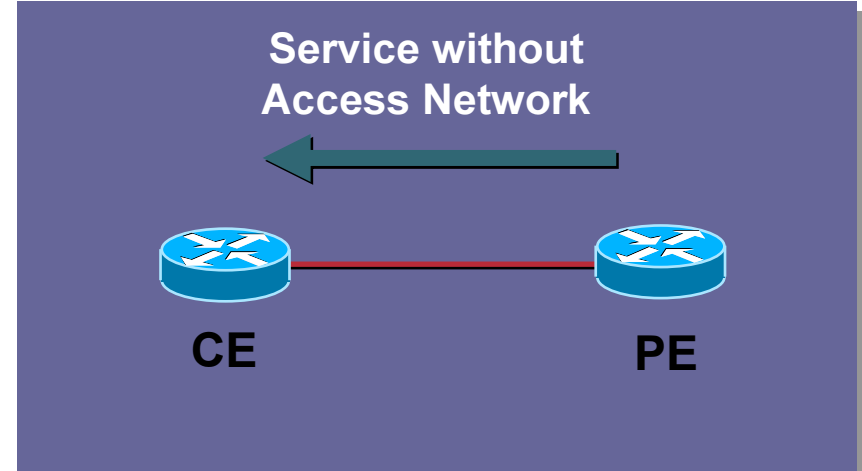

CE	PE
Input Policy	Input Policy
<irrelevant>	Queuing (LLQ)
	WRED
	[shaping]

Now the Easy Part...

- **QoS complexity resides at the edge**
- **Backbone is service agnostic**
- **Backbone is customer agnostic**
- **Backbone only deals with classes**
- **Over-provisioning sometimes touted as best alternative**

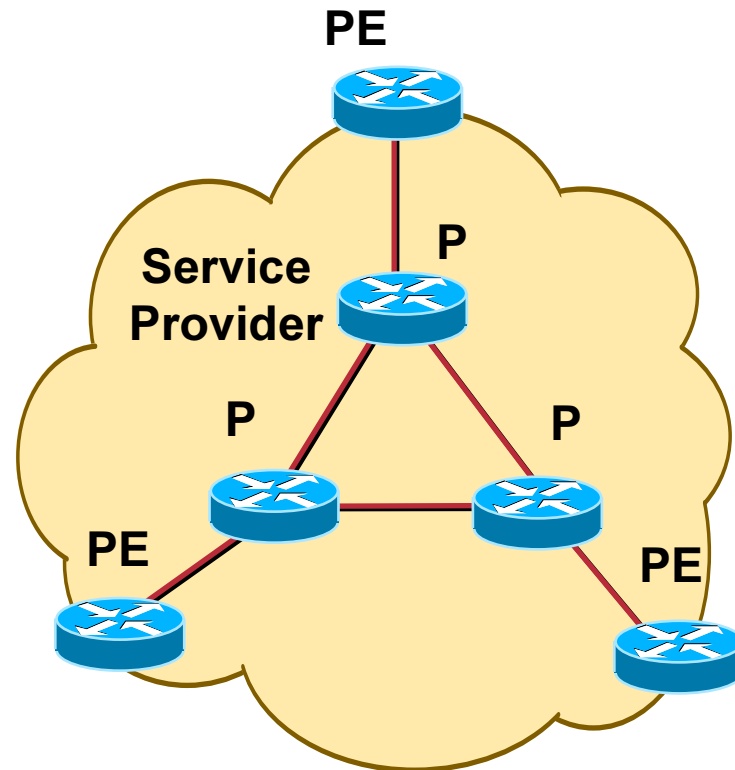

Limitations of Over-Provisioning

- Expensive
- DOS attacks
- Failures conditions
- Planning mistakes
- Unexpected traffic demand

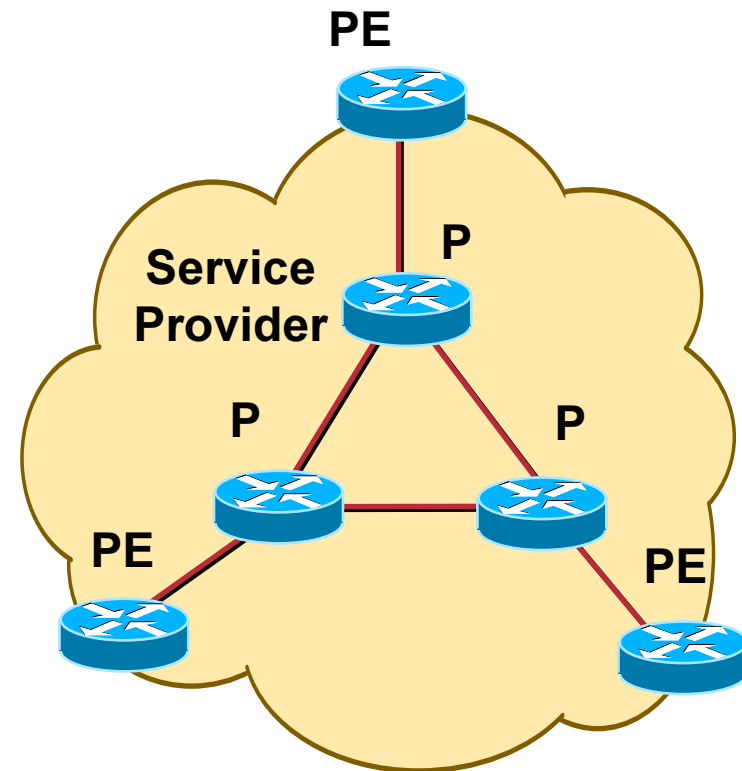

Benefits of DiffServ in the Backbone

- **Less bandwidth required**
- **Over-provisioning control per class**
- **Low maintenance design**
- **Low complexity design**
- **Can be tied to advanced traffic mgmt in control plane (MPLS TE)**

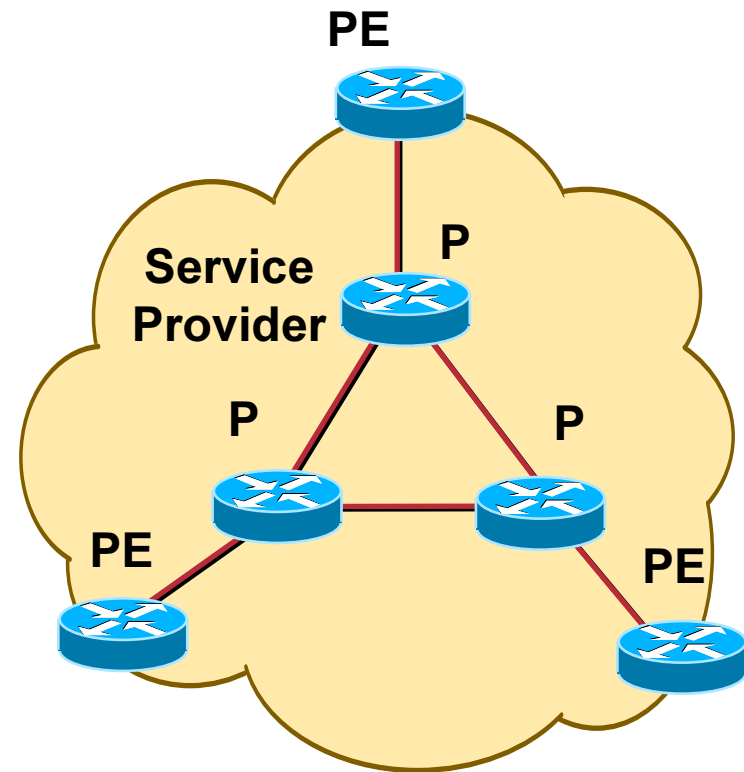

Backbone QoS Design Recommendations

- **Subset of classes may be used**
- **Typically, 2 or 3 classes (real time, business, BE)**

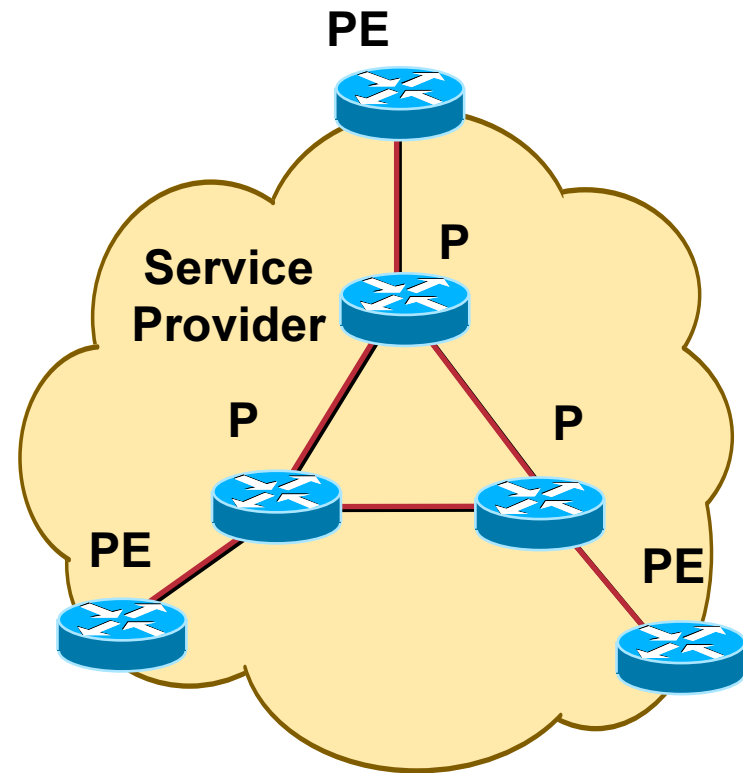

Traffic through Backbone Node

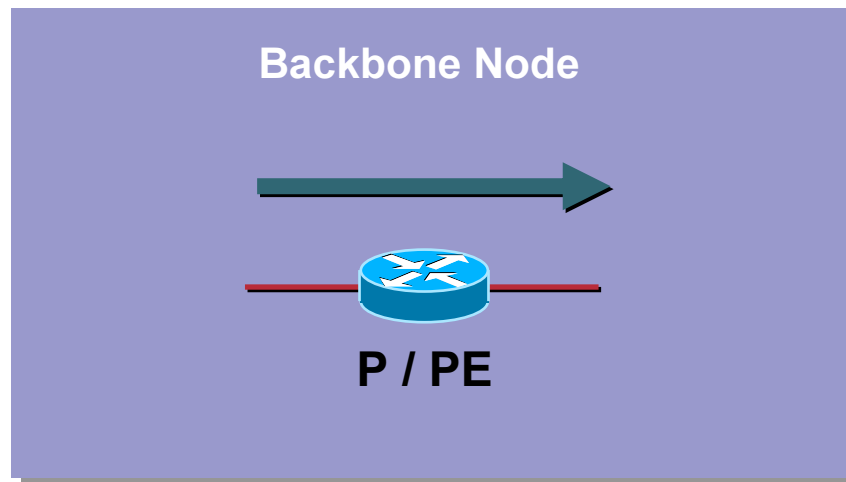

- **SP implements SLA using output QoS policy**
- **Output policy uses queuing and dropping**

Traffic through Backbone Node

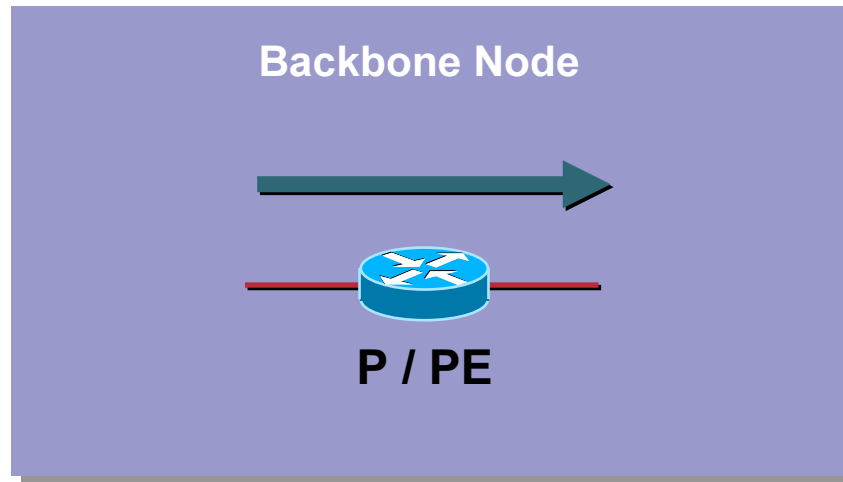

PE
Output Policy

LLQ

WRED

Further Enhancing the SLA with MPLS TE

- **Bandwidth optimization**
- **Stronger point-to-point guarantees**
- **Quick restoration (FRR)**
- **Bandwidth protection during failures**

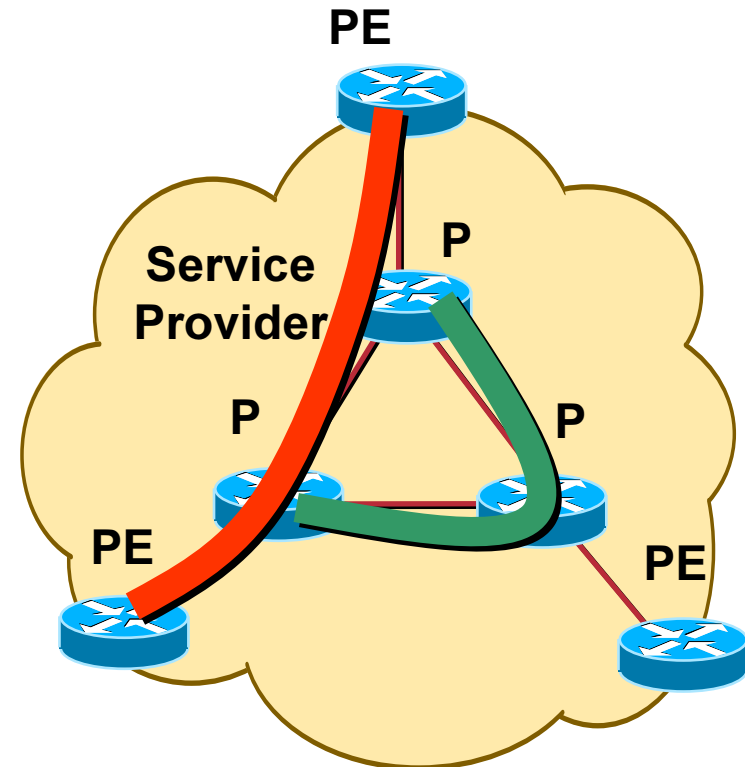

Summary

- IP QoS can provide more **sophisticated SLAs** than traditional Layer 2 services
- Service Providers can use **converged network** to implement Layer 3 and Layer 2 services with QoS
- MPLS TE can be used for **enhanced SLAs**
- Edge QoS design much more elaborate
- Multiple options for edge design (e.g. classes, managed vs. unmanaged, sub-rate)
- Backbone QoS design simple

References

- **QoS**

<http://www.cisco.com/go/qos>

- **MPLS**

<http://www.cisco.com/go/mpls>

- **Cisco IOS Software Release 12.4T New Feature Documentation**

<http://www.cisco.com/warp/public/732/releases/release124/124t/>

- **Account teams have internal test result and detailed designs**

CISCO SYSTEMS

