



Understanding Cisco IOS Naming Conventions

Academy Conference 2005

John Rullan, CCNP, CCAI

Objectives

- **Evolution of Cisco trains and releases**
- **Names of trains and releases**
- **Types of trains and releases**
- **Feature sets and images**
- **Cisco IOS tools**

History of Cisco IOS

- **Cisco IOS was born with the first Cisco router.**
- **Cisco IOS Software has evolved from a single platform routing operating system to an extraordinary operating system supporting an unprecedented array of features and technologies such as voice and video over IP networks, optical, wireless, SAN, etc. over a broad range of Internet and enterprise network hardware.**

Cisco IOS Trains and Releases: An Introduction

- **A Cisco IOS train is a vehicle for delivering releases with a common code base. Think of a train like a version.**
- **A Cisco IOS release is a copy of the code base of a train at a specific time. You can think of it as a snapshot of the code at the ‘moment’.**
- **Trains and releases classify types.**
- **A train may well ‘contain’ several releases, each release being a ‘snapshot’ of the code base of the train at the moment of the release.**

Origin of Cisco Trains

- Originally Cisco IOS releases were delivered in a single ‘train’.
- Early in Cisco’s history as new features, applications and platforms were being added the need for at least two trains emerged:

Major releases: A train for software fixes only—which was internally referred to as **mainline**

T- releases: A train for software fixes and new features—which was internally referred to as a **“T train”**

Train Types

- In recent years, the Internet boom required Cisco to add thousands of new features, hundreds of new applications, and a wide array of hardware products.
- Cisco IOS Software diversified to multiple trains, each of which supported different feature sets for different customer needs.
 - mainline** – Consolidates releases and fixes defects. Inherits features from parent T train, does not add additional features.
 - T** – Introduces new features and fixes defects.
 - S** – Consolidates mainline, E, and other S, which supports high-end backbone routers, and fixes defects.
 - E** – Targets enterprise core and SP edge, supports advanced QoS, voice, security, and firewall, and fixes defects.
 - B** – Supports broadband features and fixes defects.

Mainline and T Trains

- Mainline trains are built from previous generation T trains.
- Mainline trains are parents of same generation T trains.
- Only bug fixes are added to the mainline's maintenance releases.
- T trains maintenance releases inherit fixes from mainline.
- T trains also receive new features.

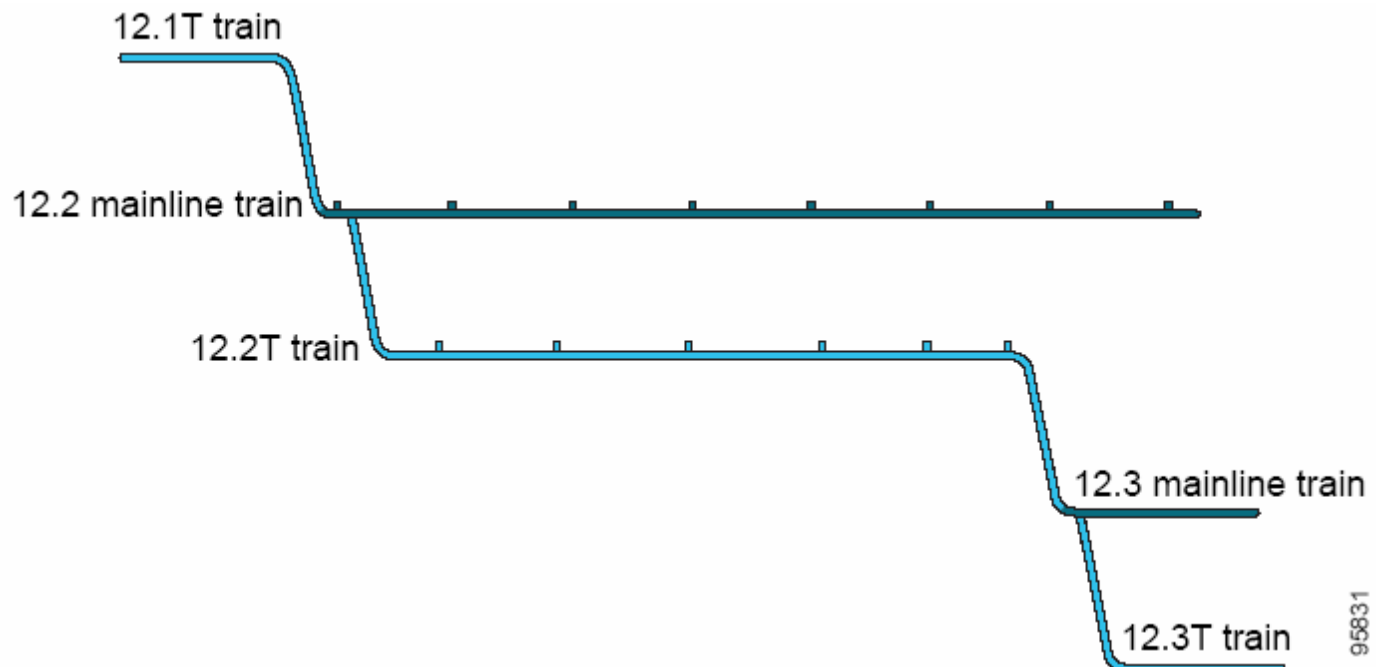

Trains Lifecycle Milestone

- **FCS** – First Customer Shipment (first maintenance release).
- **EoS** – End of Sale
- **EoE** – End of Engineering
- **EoL** – End of Life

Milestone	Available through Sales Channels	Bug Fixes	TAC Support	Download from Cisco.com
FCS	Yes	Yes*	Yes	Yes
EoS	No	Yes	Yes	Yes
EoE	No	No	Yes	Yes
EoL	No	No	No	No

Trains Lifecycle

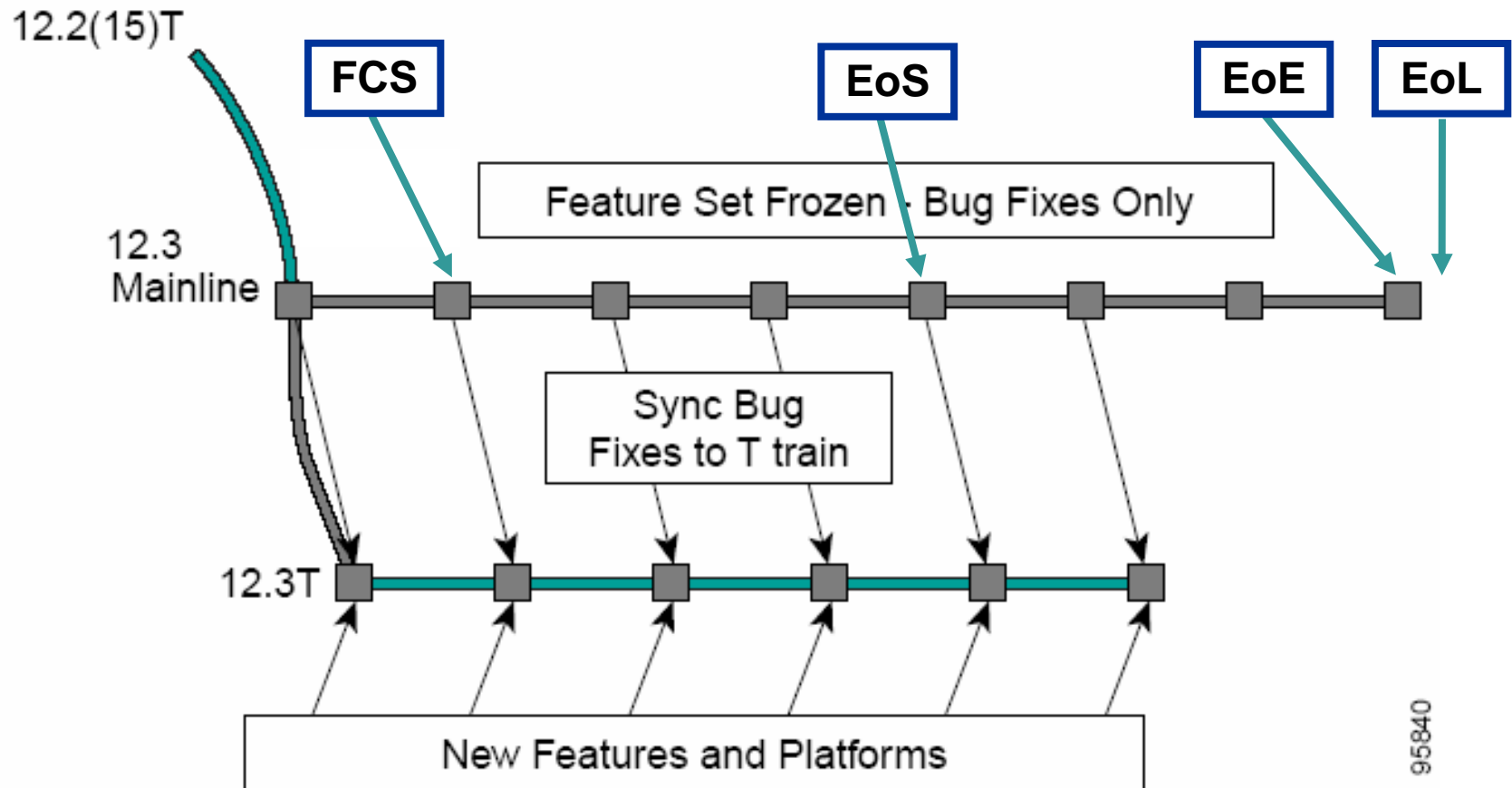

95840

- **Release** - is a snapshot in time of the code base of a train, remember that trains are vehicles for delivering releases with a common code base.

Release Types

- **Maintenance releases**
- **Rebuild releases**
- **General Deployment (GD) releases**
- **Special releases**

Maintenance Releases

- A scheduled revision of Cisco IOS Software that introduces new features or bug fixes, or both depending on the train.
- Has a number enclosed in parentheses.
- After major release (mainline) 12.2, Cisco started sharing a sequence of numbers among maintenance releases on the mainline, T, and S trains.
- The sequence number increments, higher numbered release on the T or S trains inherits fixes from the lower numbered release in the mainline.

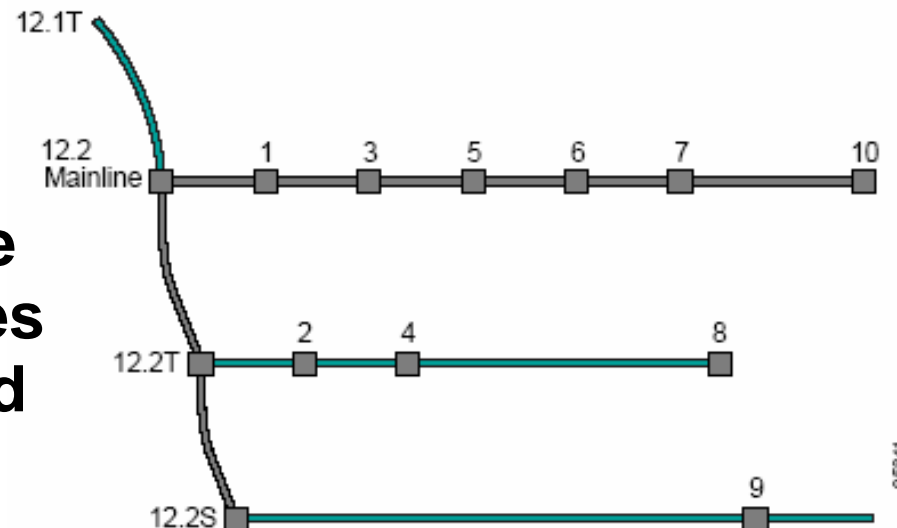

Rebuild Releases

- **Rebuilds are Cisco IOS releases that deliver fixes on an accelerated schedule.**
- **Rebuilds use a numeric suffix in the release name next to the train identifier letter when it is on B, S, T, or E train.**
- **Rebuilds use a lowercase alphanumeric suffix in a release name when it is on a mainline train.**

General Deployment (GD) Releases

- **GD is more a status achieved by a release than a release itself.**
- **A release obtains this status after meeting strict standards that assures its stability and quality.**
- **The release must be extensively deployed in diverse networks for an extended period of time.**
- **All subsequent revisions of a GD release are also regarded as a GD release.**

Special Releases

- Are similar to rebuilds but instead of quick fixes, special releases introduce new features or additional platform support to quickly meet market demands.
- A branch from a train code base.
- Does not conform to a strict naming convention. They use a double letter after the release number.
- The first letter could be a one-time release, the train identifier, or the technology identifier.
- The second letter could be a sequential revision or a one-time release.
- Special releases do not have an EoL, they are integrated back into the parent train.

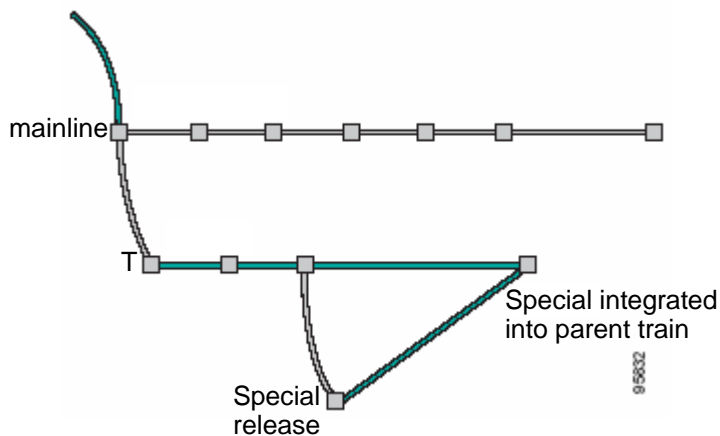

Identifier	Target Technology or Platform
X	Varies—one time release
Y	
Z	
A	Aggregation/Access Server/Dial
D	xDSL
H	SDH/SONET
J	Aironet Wireless Networking
M	Mobile Wireless
W	ATM/LAN Switching/Layer 3 Switching

Interim Builds

- **Interim build is a 'temporal' software given to a customer by the Cisco Technical Assistance Center (TAC) to address a specific issue.**
- **Interim builds are named with the maintenance release number plus a fractional decimal number.**

Cisco IOS Naming Convention Examples

Cisco.com

- **Maintenance release**

Maintenance release 3, T train no. 12.2

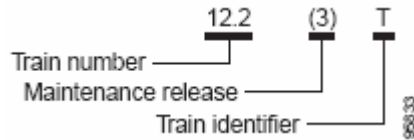

- **Rebuild release name – T train**

Rebuild 1 of the maintenance release 8, T train no. 12.2

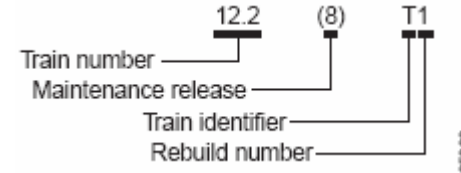

- **Rebuild release – mainline**

Rebuild 'a' of the maintenance release 1, mainline train no. 12.2

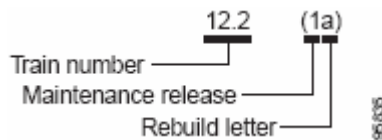

- **Interim build**

Interim build 1 of maintenance release 3, train 12.2

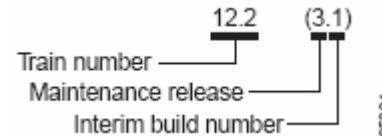

Cisco IOS Naming Convention Examples

- **Special release**

Special release: E-Train letter, X- One-time release

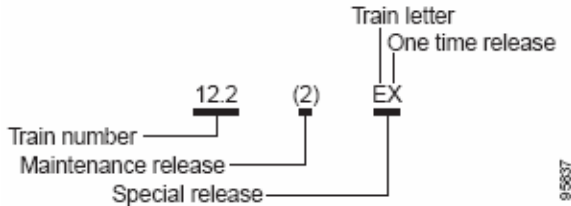

- **Special release**

Special release: J-Technology, A- Sequential revision

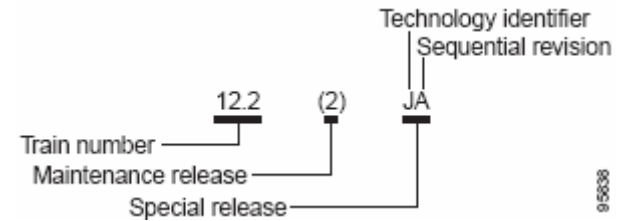

- **Special release**

Special release: X- One-time release, B- Sequential release

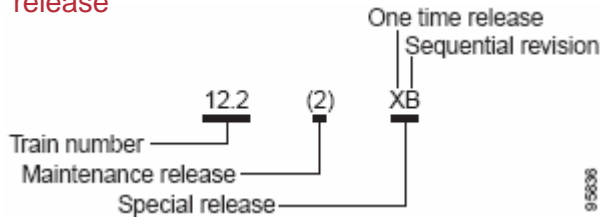

- **A feature set is a bundle of the features available for a release.**
- **Available feature set are defined by the Cisco IOS Packaging.**
- **Cisco IOS Packaging simplifies the feature set selection process by grouping features under a consistent naming scheme.**

Naming Conventions for Feature Sets

- **Base:** Entry level image (ie: IP Base, Enterprise Base).
- **Services:** Addition of IP Telephony Service, MPLS, NetFlow, VoIP, VoFR, and ATM (ie: SP Services, Enterprise Services).
- **Advanced:** Addition of VPN, Cisco IOS Firewall, 3DES encryption, Secure Shell, Cisco IOS IPsec and Intrusion Detection Systems (ie: Advanced Security, Advanced IP Services).
- **Enterprise:** Addition of multi-protocols, including IBM, IPX, AppleTalk (ie: Enterprise Base, Enterprise Services).

Cisco IOS Image Names

- A Cisco IOS image is a binary executable file of a feature set for a specific platform.
- The name of a Cisco IOS image represents the platform, feature set, format, and other information about the image file.

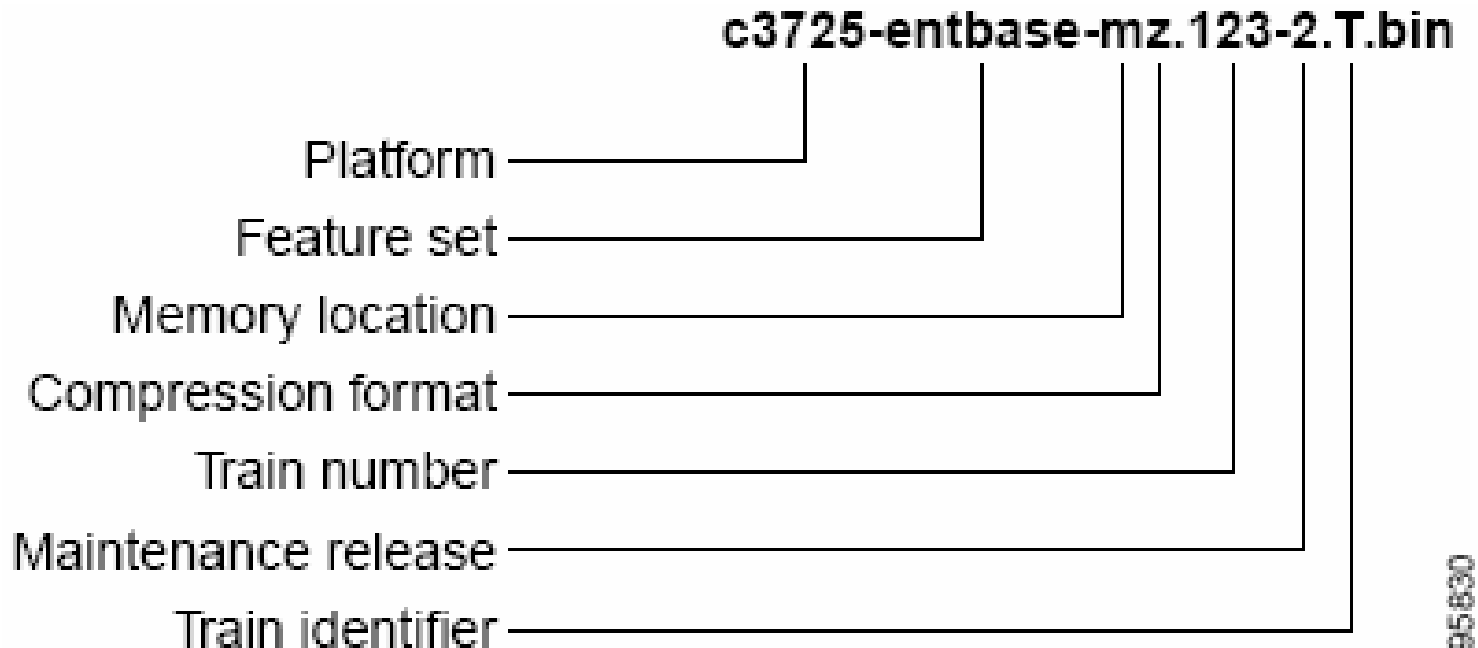

Major (Mainline) Release 12.3

- **May 2003, is the latest example of how Cisco software delivers benefits through innovation and integration. It is a consolidated release designed for Enterprise, Access, and Cisco channel partners.**
- **It delivers innovative, optimized features that enable easy access to Voice, Security, and Quality of Service (QoS), and the leading-edge functionality and hardware support introduced in Cisco IOS Software Release 12.2T.**

Cisco IOS Maintenance and New Technology

Cisco.com

- **Release 12.3** family (July 2003) delivers advanced technologies that drive business productivity by delivering Security, Voice, and Wireless innovations to Enterprise, Access, and Service Provider Aggregation customers.
- Cisco is issuing the Release 12.3T family as a series of individual releases, each of which include hundreds of new business-critical features, powerful new hardware support, and ongoing quality improvements.

The Cisco IOS Software 12.3 Release Overview

Cisco.com

- **Major Release 12.3 is a consolidation of all features and hardware support in the Release 12.2T family.**
- **As a release in the mainline train, major release 12.3 will receive software fixes on regular basis, but will not get new features or hardware support.**
- **It is important to note that the fixes applied to major release 12.3 are synchronized with subsequent instances of the child 12.3T.**

Cisco IOS 12.3 Packages

Cisco.com

- IP Base
- IP Voice
- Enterprise Base
- Advanced Security
- SP Services
- Advanced IP Services
- Enterprise Services
- Advanced Enterprise Services

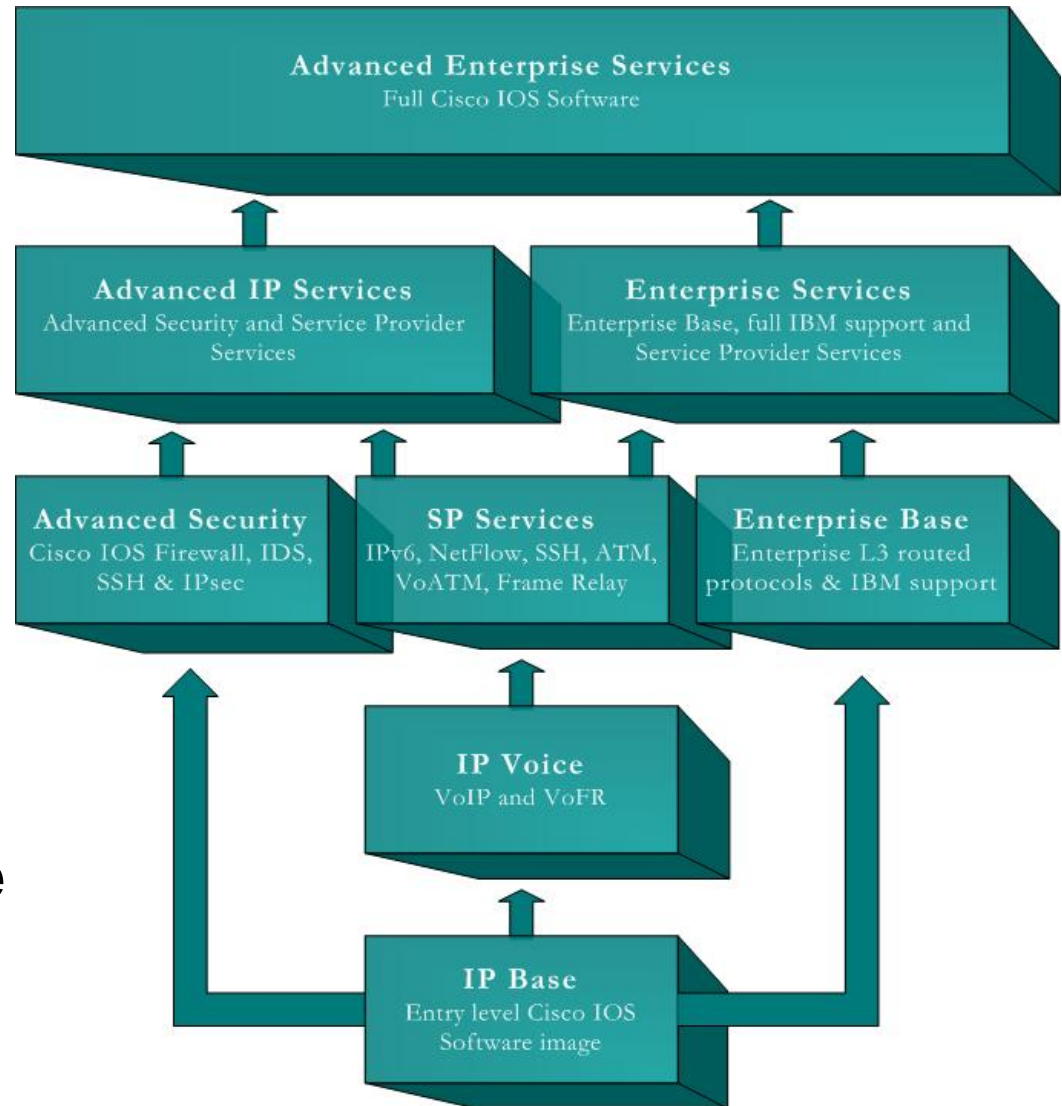

- **Cisco Feature Navigator** - Web-based application that quickly matches the right Cisco IOS Software release for the features and platform you want to run on your Network, it also compares Cisco IOS releases.
- **Cisco IOS Software Bug Toolkit** - Search for known bugs based on software release, feature set, and keywords
- **Cisco IOS Upgrade Planner** - Choose a hardware product, a maintenance release, or a software feature and automatically limit the other menu choices based on this selection, until you arrive at your preferred software.

- **Cisco Software Advisor** - Match Cisco IOS Software and Cisco Catalyst® O/S features to releases, and determine which software release supports a given hardware device. It also compares IOS releases.
- **Cisco Software Selector** - Determine the right Cisco IOS Software release and the hardware requirement to run the Cisco IOS Software.
- <http://www.cisco.com/public/support/tac/tools.shtml>
- <http://tools.cisco.com/ITDIT/CFN/jsp/index.jsp>

CISCO SYSTEMS

