

Configuring and Troubleshooting Frame Relay

Document ID: 16563

Interactive: This document offers customized analysis of your Cisco device.

Introduction

Before You Begin

Conventions

Prerequisites

Components Used

Background Theory

Configuring Basic Frame Relay

Network Diagram

Configurations

debug and show Commands

Configuring Hub and Spoke Frame Relay

Network Diagram

Configurations

show Commands

Connecting from Spoke to Spoke

Configurations

show Commands

Configuring Frame Relay Subinterfaces

Point-to-Point Subinterfaces

show Commands

Hub and Spoke Subinterfaces

show Commands

Configuring Dynamic and Static Mapping for Multipoint Subinterfaces

Network Diagram

Configurations

debug and show Commands

Configuring IP Unnumbered Frame Relay

Network Diagram

Configurations

show Commands

Configuring Frame Relay Backup

Frame Relay Backup over ISDN

Configuration Per DLCI Backup

Hub and Spoke with Dialer Profiles

Configuring Frame Relay Switching

Network Diagram

Configurations

show Commands

Configuring Frame Relay DLCI Prioritization

Implementation Considerations

Network Diagram

Configurations

debug and show Commands

Frame Relay Broadcast Queue

Traffic Shaping

Traffic Shaping Parameters

Generic Traffic Shaping

Frame Relay Traffic Shaping

Commonly Used Frame Relay Commands

show frame-relay pvc

show frame-relay map

Frame Relay and Bridging

Frame Relay and Memory

Troubleshooting Frame Relay

"Serial0 is down, line protocol is down"

"Serial0 is up, line protocol is down"

"Serial0 is up, line protocol is up"

Frame Relay Characteristics

IP Split Horizon Checking

Ping Your Own IP Address on a Multipoint Frame Relay

The Keyword broadcast

Reconfiguring a Subinterface

DLCI Limitations

IP/IPX/AT Address

RIP and IGRP

Keepalive

Serial Interfaces

OSPF and Multipoint

Sources

Related Information

Introduction

Frame Relay is an industry-standard, switched data link layer protocol that handles multiple virtual circuits using High-Level Data Link Control (HDLC) encapsulation between connected devices. In many cases, Frame Relay is more efficient than X.25, the protocol for which it is generally considered a replacement. The following figure illustrates a Frame Relay frame (ANSI T1.618).

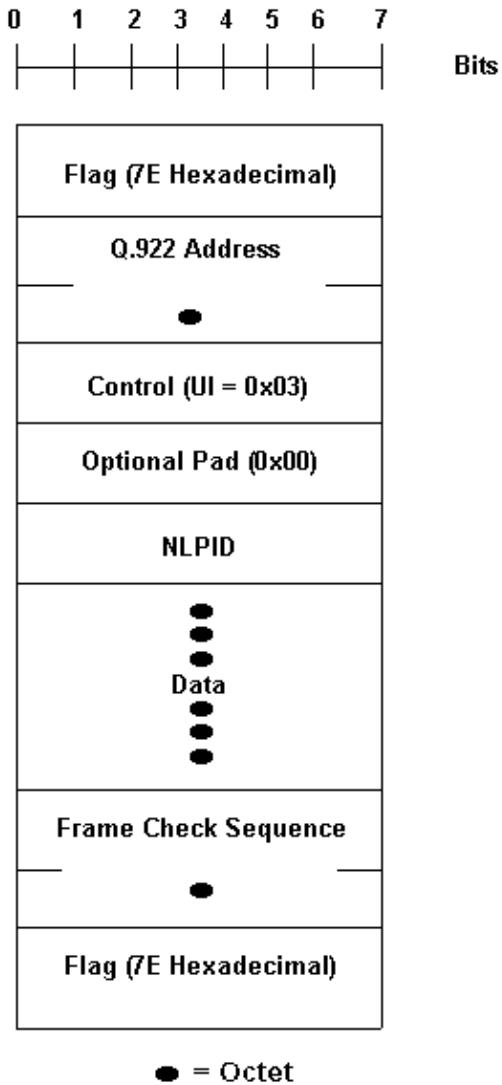

Note in the above figure, Q.922 addresses, as presently defined, are two octets and contain a 10-bit data-link connection identifier (DLCI). In some networks Q.922 addresses may optionally be increased to three or four octets.

The "flag" fields delimit the beginning and end of the frame. Following the leading "flag" field are two bytes of address information. Ten bits of these two bytes make up the actual circuit ID (called the DLCI, for data-link connection identifier).

The 10-bit DLCI value is the heart of the Frame Relay header. It identifies the logical connection that is multiplexed into the physical channel. In the basic (that is, not extended by the Local Management Interface [LMI]) mode of addressing, DLCIs have local significance; that is, the end devices at two different ends of a connection may use a different DLCI to refer to that same connection.

Before You Begin

Conventions

Refer to Cisco Technical Tips Conventions for more information on document conventions.

Prerequisites

For more information and definitions for the terms used in this document, please refer to the Frame Relay Glossary.

Components Used

This document is not restricted to specific software and hardware versions.

The information presented in this document was created from devices in a specific lab environment. All of the devices used in this document started with a cleared (default) configuration. If you are working in a live network, ensure that you understand the potential impact of any command before using it.

Background Theory

Frame Relay was originally conceived as a protocol for use over ISDN interfaces. Initial proposals to this effect were submitted to the International Telecommunication Union Telecommunication Standardization Sector (ITU-T) (formerly the Consultative Committee for International Telegraph and Telephone [CCITT]) in 1984. Work on Frame Relay was also undertaken in the ANSI-accredited T1S1 standards committee in the United States.

In 1990, Cisco Systems, StrataCom, Northern Telecom, and Digital Equipment Corporation formed a consortium to focus Frame Relay technology development and accelerate the introduction of inter operable Frame Relay products. They developed a specification conforming to the basic Frame Relay protocol being discussed in T1S1 and ITU-T, but extended it with features that provide additional capabilities for complex internetworking environments. These Frame Relay extensions are referred to collectively as the LMI. This is the "cisco" LMI in the router as opposed to the "ansi" or "q933a" LMI.

Frame Relay provides a packet-switching data communications capability that is used across the interface between user devices (such as routers, bridges, host machines) and network equipment (such as switching nodes). User devices are often referred to as data terminal equipment (DTE), while network equipment that interfaces to DTE is often referred to as data circuit-terminating equipment (DCE). The network providing the Frame Relay interface can be either a carrier-provided public network or a network of privately owned equipment serving a single enterprise.

Frame Relay differs significantly from X.25 in its functionality and format. In particular, Frame Relay is a more streamlined protocol, facilitating higher performance and greater efficiency.

As an interface between user and network equipment, Frame Relay provides a means for statistically multiplexing many logical data conversations (referred to as virtual circuits) over a single physical transmission link. This contrasts with systems that use only time-division-multiplexing (TDM) techniques for supporting multiple data streams. Frame Relay's statistical multiplexing provides more flexible and efficient use of available bandwidth. It can be used without TDM techniques or on top of channels provided by TDM systems.

Another important characteristic of Frame Relay is that it exploits the recent advances in wide-area network (WAN) transmission technology. Earlier WAN protocols, such as X.25, were developed when analog transmission systems and copper media were predominant. These links are much less reliable than the fiber media/digital transmission links available today. Over links such as these, link-layer protocols can forego time-consuming error correction algorithms, leaving these to be performed at higher protocol layers. Greater performance and efficiency is therefore possible without sacrificing data integrity. Frame Relay is designed with this approach in mind. It includes a cyclic redundancy check (CRC) algorithm for detecting corrupted bits (so the data can be discarded), but it does not include any protocol mechanisms for correcting bad data

(for example, by retransmitting it at this level of protocol).

Another difference between Frame Relay and X.25 is the absence of explicit, per-virtual-circuit flow control in Frame Relay. Now that many upper-layer protocols are effectively executing their own flow control algorithms, the need for this functionality at the link layer has diminished. Frame Relay, therefore, does not include explicit flow control procedures that duplicate those in higher layers. Instead, very simple congestion notification mechanisms are provided to allow a network to inform a user device that the network resources are close to a congested state. This notification can alert higher-layer protocols that flow control may be needed.

Configuring Basic Frame Relay

Once you have reliable connections to the local Frame Relay switch at both ends of the permanent virtual circuit (PVC), then it is time to start planning the Frame Relay configuration. In this first example, the Local Management Interface (LMI)-type defaults to "cisco" LMI on Spicey. An interface is by default a "multipoint" interface so, **frame-relay inverse-arp** is on (for point-to-point, there is no Inverse ARP). IP split horizon checking is disabled by default for Frame Relay encapsulation, so routing updates come in and out the same interface. The routers learn the data-link connection identifiers (DLCIs) they need to use from the Frame Relay switch via LMI updates. The routers then Inverse ARP for the remote IP address and create a mapping of local DLCIs and their associated remote IP addresses.

Network Diagram

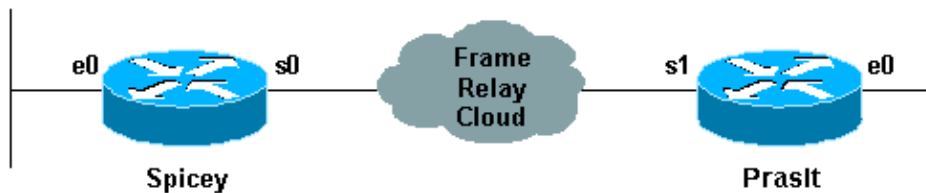

Configurations

- Spicey
- Prasit

```
Spicey
Spicey#show running-config
Building configuration...

Current configuration : 1705 bytes
!
version 12.1
service timestamps debug datetime msec
service timestamps log datetime msec
no service password-encryption
!
hostname Spicey
!
!
!
interface Ethernet0
 ip address 124.124.124.1 255.255.255.0
!
interface Serial0
 ip address 3.1.3.1 255.255.255.0
 encapsulation frame-relay
```

```
frame-relay interface-dlci 140
!
!
router rip
 network 3.0.0.0
 network 124.0.0.0
!
line con 0
 exec-timeout 0 0
 transport input none
line aux 0
line vty 0 4
 login
!
end
```

Prasit

```
Prasit#show running-config
Building configuration...
Current configuration : 1499 bytes
!
version 12.1
service timestamps debug datetime msec
service timestamps log datetime msec
no service password-encryption
!
hostname Prasit
!
!
!
interface Ethernet0
 ip address 123.123.123.1 255.255.255.0
!
!
interface Serial1
 ip address 3.1.3.2 255.255.255.0
 encapsulation frame-relay
 frame-relay interface-dlci 150
!
!
router rip
 network 3.0.0.0
 network 123.0.0.0
!
!
!
line con 0
 exec-timeout 0 0
 transport input none
line aux 0
line vty 0 4
 login
!
end
```

debug and show Commands

Before issuing **debug** commands, please see Important Information on Debug Commands.

- **show frame-relay map**
- **show frame-relay pvc**
- **show frame-relay lmi**

- ping <device name>
- show ip route

Spicey

```
Spicey#show frame-relay map
Serial0 (up): ip 3.1.3.2 dlci 140(0x8C,0x20C0), dynamic,
             broadcast,, status defined, active
```

```
Spicey#show frame-relay pvc
PVC Statistics for interface Serial0 (Frame Relay DTE)
      Active      Inactive      Deleted      Static
Local          1             0             0             0
Switched       0             0             0             0
Unused         0             0             0             0
```

```
DLCI = 140, DLCI USAGE = LOCAL, PVC STATUS = ACTIVE, INTERFACE = Serial0
input pkts 83          output pkts 87          in bytes 8144
out bytes 8408         dropped pkts 0          in FECN pkts0
in BECN pkts 0        out FECN pkts 0        out BECN pkts0
in DE pkts 0          out DE pkts 0
out bcast pkts 41     out bcast bytes 3652
pvc create time 01:31:50, last time pvc status changed 01:28:28
```

```
Spicey#show frame-relay lmi
LMI Statistics for interface Serial0 (Frame Relay DTE) LMI TYPE = CISCO
Invalid Unnumbered info 0          Invalid Prot Disc 0
Invalid dummy Call Ref 0          Invalid Msg Type 0
Invalid Status Message 0          Invalid Lock Shift 0
Invalid Information ID 0          Invalid Report IE Len 0
Invalid Report Request 0          Invalid Keep IE Len 0
Num Status Enq. Sent 550          Num Status msgs Rcvd 552
Num Update Status Rcvd 0          Num Status Timeouts 0
```

```
Spicey#ping 123.123.123.1
Type escape sequence to abort.
Sending 5, 100-byte ICMP Echos to 123.123.123.1, timeout is 2 seconds:
!!!!
Success rate is 100 percent (5/5), round-trip min/avg/max = 36/36/40 ms
```

```
Spicey#show ip route
Codes: C - connected, S - static, I - IGRP, R - RIP, M - mobile, B - BGP
       D - EIGRP, EX - EIGRP external, O - OSPF, IA - OSPF inter area
       N1 - OSPF NSSA external type 1, N2 - OSPF NSSA external type 2
       E1 - OSPF external type 1, E2 - OSPF external type 2, E - EGP
       i - IS-IS, L1 - IS-IS level-1, L2 - IS-IS level-2, ia - IS-IS
inter area
       * - candidate default, U - per-user static route, o - ODR
       P - periodic downloaded static route
```

```
Gateway of last resort is not set
 3.0.0.0/24 is subnetted, 1 subnets
C    3.1.3.0 is directly connected, Serial0
 124.0.0.0/24 is subnetted, 1 subnets
C    124.124.124.0 is directly connected, Ethernet0
R    123.0.0.0/8 [120/1] via 3.1.3.2, 00:00:08, Serial0
```

Prasit

```
Prasit#show frame-relay map
Serial1 (up): ip 3.1.3.1 dlci 150(0x96,0x2460), dynamic,
             broadcast,, status defined, active
```

```
Prasit#show frame-relay pvc
PVC Statistics for interface Serial1 (Frame Relay DTE)
      Active      Inactive      Deleted      Static
Local          1             0             0             0
Switched       0             0             0             0
```

```

Unused          0          0          0          0
DLCI = 150, DLCI USAGE = LOCAL, PVC STATUS = ACTIVE, INTERFACE = Serial1
input pkts 87          output pkts 83          in bytes 8408
out bytes 8144          dropped pkts 0          in FECN pkts 0
in BECN pkts 0          out FECN pkts 0          out BECN pkts 0
in DE pkts 0          out DE pkts 0
out bcast pkts 38          out bcast bytes 3464
pvc create time 01:34:29, last time pvc status changed 01:28:05

```

Prasit#**show frame-relay lmi**

```

LMI Statistics for interface Serial1 (Frame Relay DTE) LMI TYPE = CISCO
Invalid Unnumbered info 0          Invalid Prot Disc 0
Invalid dummy Call Ref 0          Invalid Msg Type 0
Invalid Status Message 0          Invalid Lock Shift 0
Invalid Information ID 0          Invalid Report IE Len 0
Invalid Report Request 0          Invalid Keep IE Len 0
Num Status Enq. Sent 569          Num Status msgs Rcvd 570
Num Update Status Rcvd 0          Num Status Timeouts 0

```

Prasit#**ping 124.124.124.1**

```

Type escape sequence to abort.
Sending 5, 100-byte ICMP Echos to 124.124.124.1, timeout is 2 seconds:
!!!!
Success rate is 100 percent (5/5), round-trip min/avg/max = 36/36/36 ms

```

Prasit#**show ip route**

```

Codes: C - connected, S - static, I - IGRP, R - RIP, M - mobile, B - BGP
       D - EIGRP, EX - EIGRP external, O - OSPF, IA - OSPF inter area
       N1 - OSPF NSSA external type 1, N2 - OSPF NSSA external type 2
       E1 - OSPF external type 1, E2 - OSPF external type 2, E - EGP
       i - IS-IS, L1 - IS-IS level-1, L2 - IS-IS level-2, ia - IS-IS
inter area
       * - candidate default, U - per-user static route, o - ODR
       P - periodic downloaded static route
Gateway of last resort is not set
 3.0.0.0/24 is subnetted, 1 subnets
C       3.1.3.0 is directly connected, Serial1
R       124.0.0.0/8 [120/1] via 3.1.3.1, 00:00:19, Serial1
       123.0.0.0/24 is subnetted, 1 subnets
C       123.123.123.0 is directly connected, Ethernet0

```

Configuring Hub and Spoke Frame Relay

In this example, the router learns which data-link connection identifiers (DLCIs) it uses from the Frame Relay switch and assigns them to the main interface. Then the router will Inverse ARP for the remote IP address.

Note: You will not be able to ping Prasit's serial IP address from Aton unless you explicitly add in Frame Relay maps on each end. If routing is configured correctly, traffic originating on the LANs should not have a problem. You will be able to ping if you use the Ethernet IP address as the source address in an extended ping.

When **frame-relay inverse-arp** is enabled, **broadcast** IP traffic will go out over the connection by default.

Network Diagram

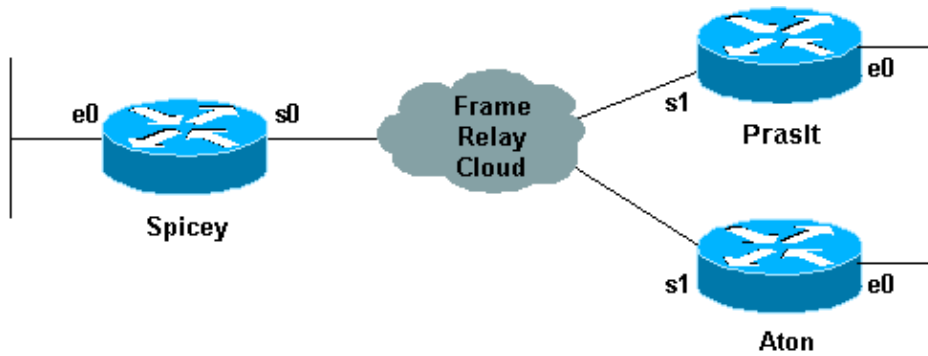

Configurations

- Spicey
- Prasit
- Aton

Spicey
<pre> spicey#show running-config Building configuration... ! version 12.1 service timestamps debug datetime msec service timestamps log datetime msec no service password-encryption ! hostname spicey ! ! ! ! interface Ethernet0 ip address 124.124.124.1 255.255.255.0 ! interface Serial0 ip address 3.1.3.1 255.255.255.0 encapsulation frame-relay frame-relay interface-dlci 130 frame-relay interface-dlci 140 ! ! router rip network 3.0.0.0 network 124.0.0.0 ! line con 0 exec-timeout 0 0 transport input none line aux 0 line vty 0 4 login ! end </pre>

Prasit
<pre> prasit#show running-config Building configuration... Current configuration : 1499 bytes </pre>

```
!  
version 12.1  
service timestamps debug datetime msec  
service timestamps log datetime msec  
no service password-encryption  
!  
hostname prasi  
!  
!  
!  
interface Ethernet0  
 ip address 123.123.123.1 255.255.255.0  
!  
interface Serial1  
 ip address 3.1.3.2 255.255.255.0  
 encapsulation frame-relay  
 frame-relay interface-dlci 150  
!  
!  
router rip  
 network 3.0.0.0  
 network 123.0.0.0  
!  
!  
line con 0  
 exec-timeout 0 0  
 transport input none  
line aux 0  
line vty 0 4  
 login  
!  
end
```

Aton

```
aton#show running-config  
Building configuration...  
Current configuration:  
!  
version 12.0  
service timestamps debug uptime  
service timestamps log uptime  
no service password-encryption  
!  
hostname aton  
!  
!  
interface Ethernet0  
 ip address 122.122.122.1 255.255.255.0  
!  
interface Serial1  
 ip address 3.1.3.3 255.255.255.0  
 encapsulation frame-relay  
 frame-relay interface-dlci 160  
!  
router rip  
 network 3.0.0.0  
 network 122.0.0.0  
!  
!  
line con 0  
 exec-timeout 0 0  
 transport input none  
line aux 0  
line vty 0 4
```

```
login
!  
end
```

show Commands

- **show frame-relay map**
- **show frame-relay pvc**
- **ping <device name>**

Spicey

```
spicey#show frame-relay map
```

```
Serial0 (up): ip 3.1.3.2 dlci 140(0x8C,0x20C0), dynamic,  
              broadcast,, status defined, active
```

```
Serial0 (up): ip 3.1.3.3 dlci 130(0x82,0x2020), dynamic,  
              broadcast,, status defined, active
```

```
spicey#show frame-relay pvc
```

```
PVC Statistics for interface Serial0 (Frame Relay DTE)
```

	Active	Inactive	Deleted	Static
Local	2	0	0	0
Switched	0	0	0	0
Unused	0	0	0	0

```
DLCI = 130, DLCI USAGE = LOCAL, PVC STATUS = ACTIVE, INTERFACE = Serial0  
input pkts 32          output pkts 40          in bytes 3370  
out bytes 3928        dropped pkts 0          in FECN pkts 0  
in BECN pkts 0        out FECN pkts 0        out BECN pkts 0  
in DE pkts 0          out DE pkts 0  
out bcast pkts 30     out bcast bytes 2888  
pvc create time 00:15:46, last time pvc status changed 00:10:42
```

```
DLCI = 140, DLCI USAGE = LOCAL, PVC STATUS = ACTIVE, INTERFACE = Serial0  
  
input pkts 282          output pkts 291          in bytes 25070  
out bytes 27876        dropped pkts 0          in FECN pkts 0  
in BECN pkts 0        out FECN pkts 0        out BECN pkts 0  
in DE pkts 0          out DE pkts 0  
out bcast pkts 223     out bcast bytes 20884  
pvc create time 02:28:36, last time pvc status changed 02:25:14
```

```
spicey#
```

```
spicey#ping 3.1.3.2
```

```
Type escape sequence to abort.
```

```
Sending 5, 100-byte ICMP Echos to 3.1.3.2, timeout is 2 seconds:
```

```
!!!!
```

```
Success rate is 100 percent (5/5), round-trip min/avg/max = 32/35/36 ms
```

```
spicey#ping 3.1.3.3
```

```
Type escape sequence to abort.
```

```
Sending 5, 100-byte ICMP Echos to 3.1.3.3, timeout is 2 seconds:
```

```
!!!!
```

```
Success rate is 100 percent (5/5), round-trip min/avg/max = 32/35/36 ms
```

Prasit

```
prasit#show frame-relay map
```

```
Serial1 (up): ip 3.1.3.1 dlci 150(0x96,0x2460), dynamic,  
              broadcast,, status defined, active
```

```
prasit#show frame-relay pvc
```

```
PVC Statistics for interface Serial1 (Frame Relay DTE)
```

	Active	Inactive	Deleted	Static
--	--------	----------	---------	--------

Local	1	0	0	0
Switched	0	0	0	0
Unused	0	0	0	0

DLCI = 150, DLCI USAGE = LOCAL, PVC STATUS = ACTIVE, INTERFACE = Serial1
input pkts 311 output pkts 233 in bytes 28562
out bytes 22648 dropped pkts 0 in FECN pkts 0
in BECN pkts 0 out FECN pkts 0 out BECN pkts 0
in DE pkts 0 out DE pkts 0
out bcast pkts 162 out bcast bytes 15748
pvc create time 02:31:39, last time pvc status changed 02:25:14

prasit#ping 3.1.3.1

Type escape sequence to abort.

Sending 5, 100-byte ICMP Echos to 3.1.3.1, timeout is 2 seconds:

!!!!

Success rate is 100 percent (5/5), round-trip min/avg/max = 36/36/36 ms

prasit#ping 3.1.3.3

Type escape sequence to abort.

Sending 5, 100-byte ICMP Echos to 3.1.3.3, timeout is 2 seconds:

.....

Success rate is 0 percent (0/5)

Aton

aton#show frame-relay map

Serial1 (up): ip 3.1.3.1 dlci 160(0xA0,0x2800), dynamic,
broadcast,, status defined, active

aton#show frame-relay pvc

PVC Statistics for interface Serial1 (Frame Relay DTE)

	Active	Inactive	Deleted	Static
Local	1	0	0	0
Switched	0	0	0	0
Unused	0	0	0	0

DLCI = 160, DLCI USAGE = LOCAL, PVC STATUS = ACTIVE, INTERFACE = Serial1

input pkts 35 output pkts 32 in bytes 3758
out bytes 3366 dropped pkts 0 in FECN pkts 0
in BECN pkts 0 out FECN pkts 0 out BECN pkts 0
in DE pkts 0 out DE pkts 0
out bcast pkts 27 out bcast bytes 2846
pvc create time 00:10:53, last time pvc status changed 00:10:53

aton#ping 3.1.3.1

Type escape sequence to abort.

Sending 5, 100-byte ICMP Echos to 3.1.3.1, timeout is 2 seconds:

!!!!

Success rate is 100 percent (5/5), round-trip min/avg/max = 32/35/36 ms

aton#ping 3.1.3.2

Type escape sequence to abort.

Sending 5, 100-byte ICMP Echos to 3.1.3.2, timeout is 2 seconds:

.....

Success rate is 0 percent (0/5)

Connecting from Spoke to Spoke

You cannot ping from one spoke to another spoke in a hub and spoke configuration using multipoint interfaces because there is no mapping for the other spokes' IP addresses. Only the hub's address is learned via the Inverse Address Resolution Protocol (IARP). If you configure a static map using the `frame-relay map` command for the IP address of a remote spoke to use the local data link connection identifier (DLCI), you can ping the addresses of other spokes.

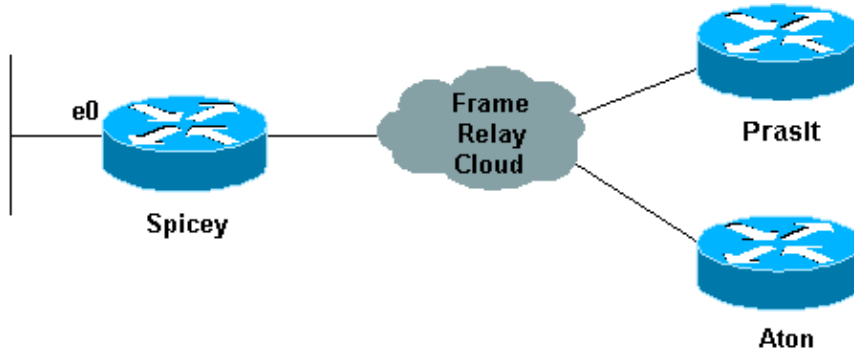

Configurations

Prasit
<pre>prasit#show running-config interface Ethernet0 ip address 123.123.123.1 255.255.255.0 ! interface Serial ip address 3.1.3.2 255.255.255.0 encapsulation frame-relay frame-relay map ip 3.1.3.3 150 frame-relay interface-dlci 150</pre>

show Commands

- `show frame-relay map`
- `ping <device name>`
- `show running-config`

Prasit

```
prasit#show frame-relay map
Serial1 (up): ip 3.1.3.1 dlci 150(0x96,0x2460), dynamic,
              broadcast,, status defined, active
Serial1 (up): ip 3.1.3.3 dlci 150(0x96,0x2460), static,
              CISCO, status defined, active

prasit#ping 3.1.3.3
Type escape sequence to abort.
Sending 5, 100-byte ICMP Echos to 3.1.3.3, timeout is 2 seconds:
!!!!
Success rate is 100 percent (5/5), round-trip min/avg/max = 68/70/80 ms

prasit#ping 122.122.122.1
Type escape sequence to abort.
Sending 5, 100-byte ICMP Echos to 122.122.122.1, timeout is 2 seconds:
!!!!
Success rate is 100 percent (5/5), round-trip min/avg/max = 64/67/76 ms
```

Aton

```
aton#show running-config
interface Ethernet0
ip address 122.122.122.1 255.255.255.0
!
interface Serial1
  ip address 3.1.3.3 255.255.255.0
  no ip directed-broadcast
  encapsulation frame-relay
  frame-relay map ip 3.1.3.2 160
  frame-relay interface-dlci 160

aton#show frame-relay map
Serial1 (up): ip 3.1.3.1 dlci 160(0xA0,0x2800), dynamic,
              broadcast,, status defined, active
Serial1 (up): ip 3.1.3.2 dlci 160(0xA0,0x2800), static,
              CISCO, status defined, active

aton#ping 3.1.3.2

Type escape sequence to abort
Sending 5, 100-byte ICMP Echos to 3.1.3.2, timeout is 2 seconds:
!!!!
Success rate is 100 percent (5/5), round-trip min/avg/max = 68/68/68 ms

aton#ping 123.123.123.1

Type escape sequence to abort.
Sending 5, 100-byte ICMP Echos to 123.123.123.1, timeout is 2 seconds:
!!!!
Success rate is 100 percent (5/5), round-trip min/avg/max = 64/67/80 ms
```

Configuring Frame Relay Subinterfaces

Frame Relay subinterfaces provide a mechanism for supporting partially meshed Frame Relay networks. Most protocols assume transitivity on a logical network; that is, if station A can talk to station B, and station B can talk to station C, then station A should be able to talk to station C directly. Transitivity is true on LANs, but not on Frame Relay networks unless A is directly connected to C.

Additionally, certain protocols, such as AppleTalk and transparent bridging, cannot be supported on partially meshed networks because they require "split horizon" in which a packet received on an interface cannot be transmitted out the same interface even if the packet is received and transmitted on different virtual circuits.

Configuring Frame Relay subinterfaces ensures that a single physical interface is treated as multiple virtual interfaces. This capability allows us to overcome split horizon rules. Packets received on one virtual interface can now be forwarded out another virtual interface, even if they are configured on the same physical interface.

Subinterfaces address the limitations of Frame Relay networks by providing a way to subdivide a partially meshed Frame Relay network into a number of smaller, fully meshed (or point-to-point) subnetworks. Each subnetwork is assigned its own network number and appears to the protocols as if it is reachable through a separate interface. (Note that point-to-point subinterfaces can be unnumbered for use with IP, reducing the addressing burden that might otherwise result).

Point-to-Point Subinterfaces

Network Diagram



Configurations

- Spicey
- Prasit

Spicey
<pre> Spicey#show running-config Building configuration... Current configuration : 1338 bytes ! version 12.1 service timestamps debug datetime msec service timestamps log datetime msec no service password-encryption ! hostname Spicey ! enable password ww ! ! ! ! interface Ethernet0 ip address 124.124.124.1 255.255.255.0 ! interface Serial0 no ip address encapsulation frame-relay ! interface Serial0.1 point-to-point ip address 3.1.3.1 255.255.255.0 frame-relay interface-dlci 140 ! ! router igrp 2 network 3.0.0.0 network 124.0.0.0 ! ! line con 0 exec-timeout 0 0 transport input none line aux 0 line vty 0 4 login ! end </pre>

Prasit
<pre> Prasit#show running-config Building configuration... Current configuration : 1234 bytes </pre>

```

!
version 12.1
service timestamps debug datetime msec
service timestamps log datetime msec
no service password-encryption
!
hostname Prasit
!
!
!
interface Ethernet0
 ip address 123.123.123.1 255.255.255.0
!
 interface Serial1
 no ip address
 encapsulation frame-relay
!
interface Serial1.1 point-to-point
 ip address 3.1.3.2 255.255.255.0
 frame-relay interface-dlci 150
!
router igrp 2
 network 3.0.0.0
 network 123.0.0.0
!
line con 0
 exec-timeout 0 0
 transport input none
line aux 0
line vty 0 4
 login
!
end

```

show Commands

- **show frame-relay map**
- **show frame-relay pvc**

Spicey

Spicey#**show frame-relay map**

Serial0.1 (up): point-to-point dlci, dlci 140(0x8C,0x20C0), broadcast status defined, active

Spicey#**show frame-relay pvc**

PVC Statistics for interface Serial0 (Frame Relay DTE)

	Active	Inactive	Deleted	Static
Local	1	0	0	0
Switched	0	0	0	0
Unused	0	0	0	0

DLCI = 140, DLCI USAGE = LOCAL, PVC STATUS = ACTIVE, INTERFACE = Serial0.1

input pkts 193	output pkts 175	in bytes 20450
out bytes 16340	dropped pkts 0	in FECN pkts 0
in BECN pkts 0	out FECN pkts 0	out BECN pkts 0
in DE pkts 0	out DE pkts 0	
out bcast pkts 50	out bcast bytes 3786	
pvc create time 01:11:27, last time pvc status changed 00:42:32		

Spicey#**ping 123.123.123.1**

Type escape sequence to abort.

```

Sending 5, 100-byte ICMP Echos to 123.123.123.1, timeout is 2 seconds:
!!!!
Success rate is 100 percent (5/5), round-trip min/avg/max = 36/36/36 ms

```

Prasit

```

Prasit#show frame-relay map
Serial1.1 (up): point-to-point dlci, dlci 150(0x96,0x2460), broadcast
          status defined, active

```

```

Prasit#show frame-relay pvc
PVC Statistics for interface Serial1 (Frame Relay DTE)

```

	Active	Inactive	Deleted	Static
Local	1	0	0	0
Switched	0	0	0	0
Unused	0	0	0	0

```

DLCI = 150, DLCI USAGE = LOCAL, PVC STATUS = ACTIVE, INTERFACE =
Serial1.1

```

input pkts	74	output pkts	89	in bytes	7210
out bytes	10963	dropped pkts	0	in FECN pkts	0
in BECN pkts	0	out FECN pkts	0	out BECN pkts	0
in DE pkts	0	out DE pkts	0		
out bcast pkts	24	out bcast bytes	4203		
pvc create time 00:12:25, last time pvc status changed 00:12:25					

```

Prasit#ping 124.124.124.1
Type escape sequence to abort.
Sending 5, 100-byte ICMP Echos to 124.124.124.1, timeout is 2 seconds:
!!!!
Success rate is 100 percent (5/5), round-trip min/avg/max = 36/36/36 ms

```

Hub and Spoke Subinterfaces

The following hub and spoke sample configuration shows two point-to-point subinterfaces and uses dynamic address resolution on one remote site. Each subinterface is provided with an individual protocol address and subnetmask, and the **interface-dlci** command associates the subinterface with a specified data-link connection identifier (DLCI). Addresses of remote destinations for each point-to-point subinterface are not resolved since they are point-to-point and traffic must be sent to the peer at the other end. The remote end (Aton) uses Inverse ARP for its mapping and the main hub responds accordingly with the IP address of the subinterface. This occurs because Frame Relay Inverse ARP is on by default for multipoint interfaces.

Network Diagram

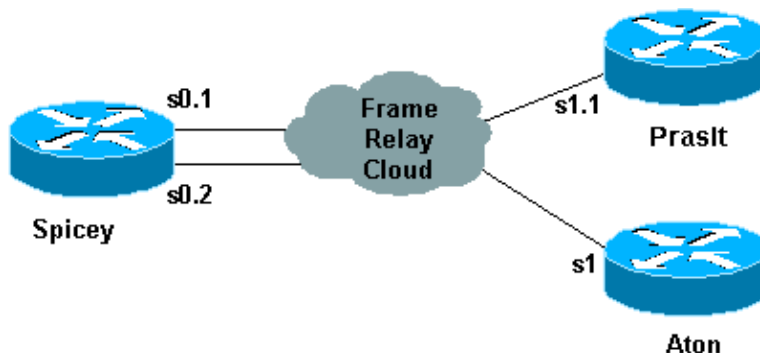

Configurations

- Spicey
- Prasit
- Aton

Spicey

```
Spicey#show running-config
Building configuration...
!
version 12.1
service timestamps debug datetime msec
service timestamps log datetime msec
no service password-encryption
!
hostname Spicey
!
!
!
!
interface Ethernet0
 ip address 124.124.124.1 255.255.255.0
!
interface Serial0
 no ip address
 encapsulation frame-relay
!
interface Serial0.1 point-to-point
 ip address 4.0.1.1 255.255.255.0
 frame-relay interface-dlci 140
!
interface Serial0.2 point-to-point
 ip address 3.1.3.1 255.255.255.0
 frame-relay interface-dlci 130
!
router igrp 2
 network 3.0.0.0
 network 4.0.0.0
 network 124.0.0.0
!
line con 0
 exec-timeout 0 0
 transport input none
line aux 0
line vty 0 4
 login
!
end
```

Prasit

```
Prasit#show running-config
Building configuration...

version 12.1
service timestamps debug datetime msec
service timestamps log datetime msec
no service password-encryption
!
hostname Prasit
!
interface Ethernet0
 ip address 123.123.123.1 255.255.255.0
```

```

!
interface Serial1
  no ip address
  encapsulation frame-relay
!
interface Serial1.1 point-to-point
  ip address 4.0.1.2 255.255.255.0
  frame-relay interface-dlci 150
!
router igrp 2
  network 4.0.0.0
  network 123.0.0.0
!
!
line con 0
  exec-timeout 0 0
  transport input none
line aux 0
line vty 0 4
  login
!
end

```

Aton

```

Aton#show running-config
Building configuration...

Current configuration:
!
version 12.0
service timestamps debug uptime
service timestamps log uptime
!
hostname Aton
!
!
!
interface Ethernet0
  ip address 122.122.122.1 255.255.255.0
!
interface Serial1
  ip address 3.1.3.3 255.255.255.0
  encapsulation frame-relay
  frame-relay interface-dlci 160
!
router igrp 2
  network 3.0.0.0
  network 122.0.0.0
!
line con 0
  exec-timeout 0 0
  transport input none
line aux 0
line vty 0 4
  login
!
end

```

show Commands

- **show frame-relay map**
- **show frame-relay pvc**

Spicey

Spicey#**show frame-relay map**

Serial0.2 (up): point-to-point dlci, dlci 130(0x82,0x2020), broadcast
status defined, active
Serial0.1 (up): point-to-point dlci, dlci 140(0x8C,0x20C0), broadcast
status defined, active

Spicey#**show frame-relay pvc**

PVC Statistics for interface Serial0 (Frame Relay DTE)

	Active	Inactive	Deleted	Static
Local	2	0	0	0
Switched	0	0	0	0
Unused	0	0	0	0

DLCI = 130, DLCI USAGE = LOCAL, PVC STATUS = ACTIVE, INTERFACE = Serial0.2

input pkts 11	output pkts 22	in bytes 1080
out bytes 5128	dropped pkts 0	in FECN pkts 0
in BECN pkts 0	out FECN pkts 0	out BECN pkts 0
in DE pkts 0	out DE pkts 0	
out bcst pkts 17	out bcst bytes 4608	
pvc create time 00:06:36, last time pvc status changed 00:06:36		

DLCI = 140, DLCI USAGE = LOCAL, PVC STATUS = ACTIVE, INTERFACE = Serial0.1

input pkts 33	output pkts 28	in bytes 3967
out bytes 5445	dropped pkts 0	in FECN pkts 0
in BECN pkts 0	out FECN pkts 0	out BECN pkts 0
in DE pkts 0	out DE pkts 0	
out bcst pkts 17	out bcst bytes 4608	
pvc create time 00:06:38, last time pvc status changed 00:06:38		

Spicey#**ping 122.122.122.1**

Type escape sequence to abort.

Sending 5, 100-byte ICMP Echos to 122.122.122.1, timeout is 2 seconds:

!!!!!

Success rate is 100 percent (5/5), round-trip min/avg/max = 32/35/36 ms

Spicey#**ping 123.123.123.1**

Type escape sequence to abort.

Sending 5, 100-byte ICMP Echos to 123.123.123.1, timeout is 2 seconds:

!!!!!

Success rate is 100 percent (5/5), round-trip min/avg/max = 36/36/36 ms

Prasit

Prasit#**show frame-relay map**

Serial1.1 (up): point-to-point dlci, dlci 150(0x96,0x2460), broadcast
status defined, active

Prasit#**show frame-relay pvc**

PVC Statistics for interface Serial1 (Frame Relay DTE)

	Active	Inactive	Deleted	Static
Local	1	0	0	0
Switched	0	0	0	0
Unused	0	0	0	0

DLCI = 150, DLCI USAGE = LOCAL, PVC STATUS = ACTIVE, INTERFACE =
Serial1.1

input pkts 45	output pkts 48	in bytes 8632
out bytes 6661	dropped pkts 0	in FECN pkts 0

```
in BECN pkts 0          out FECN pkts 0          out BECN pkts 0
in DE pkts 0           out DE pkts 0
out bcast pkts 31      out bcast bytes 5573
pvc create time 00:12:16, last time pvc status changed 00:06:23
```

```
Prasit#ping 124.124.124.1
Type escape sequence to abort.
Sending 5, 100-byte ICMP Echos to 124.124.124.1, timeout is 2 seconds:
!!!!
Success rate is 100 percent (5/5), round-trip min/avg/max = 36/36/36 ms
```

Aton

```
Aton#show frame-relay map
Serial1 (up): ip 3.1.3.1 dlci 160(0xA0,0x2800), dynamic,
              broadcast,, status defined, active
```

```
Aton#show frame-relay pvc
PVC Statistics for interface Serial1 (Frame Relay DTE)
```

	Active	Inactive	Deleted	Static
Local	1	0	0	0
Switched	0	0	0	0
Unused	0	0	0	0

```
DLCI = 160, DLCI USAGE = LOCAL, PVC STATUS = ACTIVE, INTERFACE = Serial1
input pkts 699          output pkts 634          in bytes 81290
out bytes 67008         dropped pkts 0           in FECN pkts 0
in BECN pkts 0         out FECN pkts 0         out BECN pkts 0
in DE pkts 0           out DE pkts 0
out bcast pkts 528     out bcast bytes 56074
pvc create time 05:46:14, last time pvc status changed 00:05:57
```

```
Aton#ping 124.124.124.1
Type escape sequence to abort.
Sending 5, 100-byte ICMP Echos to 124.124.124.1, timeout is 2 seconds:
!!!!
Success rate is 100 percent (5/5), round-trip min/avg/max = 36/36/36 ms
```

Configuring Dynamic and Static Mapping for Multipoint Subinterfaces

Dynamic address mapping uses Frame Relay Inverse ARP to request the next hop protocol address for a specific connection, given a data-link connection identifier (DLCI). Responses to Inverse ARP requests are entered in an address-to-DLCI mapping table on the router or access server; the table is then used to supply the next hop protocol address or the DLCI for outgoing traffic.

Since the physical interface is now configured as multiple subinterfaces, you must provide information that distinguishes a subinterface from the physical interface and associates a specific subinterface with a specific DLCI.

Inverse ARP is enabled by default for all protocols it supports, but can be disabled for specific protocol-DLCI pairs. As a result, you can use dynamic mapping for some protocols and static mapping for other protocols on the same DLCI. You can explicitly disable Inverse ARP for a protocol-DLCI pair if you know the protocol is not supported on the other end of the connection. Because Inverse ARP is enabled by default for all protocols that it supports, no additional command is required to configure dynamic address mapping on a subinterface. A static map links a specified next hop protocol address to a specified DLCI. Static mapping removes the need for Inverse ARP requests; when you supply a static map, Inverse ARP is automatically disabled for the specified protocol on the specified DLCI. You must use static mapping if the router at the other end either

does not support Inverse ARP at all or does not support Inverse ARP for a specific protocol that you want to use over Frame Relay.

Network Diagram

We've already seen how to configure a Cisco router to do Inverse ARP. The following example shows how to configure static maps in case you need them for multipoint interfaces or subinterfaces:

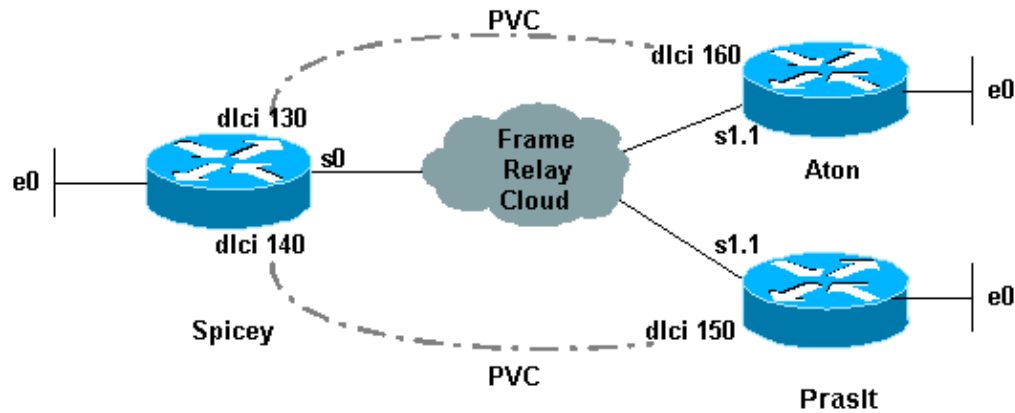

Configurations

- Aton
- Spicely
- Prasit

```
Aton
Aton#show running-config
Building configuration...
Current configuration:
!
version 12.0
service timestamps debug uptime
service timestamps log uptime
no service password-encryption
!
hostname Aton
!
!
interface Ethernet0
 ip address 122.122.122.1 255.255.255.0
!
interface Serial1
 no ip address
 encapsulation frame-relay
!
interface Serial1.1 multipoint
 ip address 4.0.1.3 255.255.255.0
 frame-relay map ip 4.0.1.1 160 broadcast
!
router igrp 2
 network 4.0.0.0
 network 122.0.0.0
!
line con 0
 exec-timeout 0 0
 transport input none
```

```
line aux 0
line vty 0 4
  login
!
end
```

Spicey

```
Spicey#show running-config
Building configuration...Current configuration : 1652 bytes!
version 12.1
service timestamps debug datetime msec
service timestamps log datetime msec
no service password-encryption
!
hostname Spicey
!
!
interface Ethernet0
ip address 124.124.124.1 255.255.255.0
!
interface Serial0
ip address 4.0.1.1 255.255.255.0
encapsulation frame-relay
frame-relay map ip 4.0.1.2 140 broadcast
frame-relay map ip 4.0.1.3 130 broadcast
!
router igrp 2
network 4.0.0.0
network 124.0.0.0
!
!
line con 0
exec-timeout 0 0
transport input none
line aux 0
line vty 0 4
  login
!
end
```

Prasit

```
Prasit#show running-config
Building configuration...
Current configuration : 1162 bytes
!
version 12.1
service timestamps debug datetime msec
service timestamps log datetime msec
no service password-encryption
!
hostname Prasit
!
!
!
interface Ethernet0
ip address 123.123.123.1 255.255.255.0
!
interface Serial1
no ip address
encapsulation frame-relay
!
interface Serial1.1 multipoint
ip address 4.0.1.2 255.255.255.0
```

```

frame-relay map ip 4.0.1.1 150 broadcast
!
router igrp 2
 network 4.0.0.0
 network 123.0.0.0
!
line con 0
 exec-timeout 0 0
 transport input none
line aux 0
line vty 0 4
 login
!
end

```

debug and show Commands

- **show frame-relay map**
- **show frame-relay pvc**

Aton

Aton#**show frame-relay map**

Serial1.1 (up): ip 4.0.1.1 dlci 160(0xA0,0x2800), static, broadcast, CISCO, status defined, active

Aton#**show frame-relay pvc**

PVC Statistics for interface Serial1 (Frame Relay DTE)

	Active	Inactive	Deleted	Static
Local	1	0	0	0
Switched	0	0	0	0
Unused	0	0	0	0

DLCI = 160, DLCI USAGE = LOCAL, PVC STATUS = ACTIVE, INTERFACE = Serial1.1

input pkts 16	output pkts 9	in bytes 3342
out bytes 450	dropped pkts 0	in FECN pkts 0
in BECN pkts 0	out FECN pkts 0	out BECN pkts 0
in DE pkts 0	out DE pkts 0	
out bcst pkts 9	out bcst bytes 450	
pvc create time 00:10:02, last time pvc status changed 00:10:02		

Aton#**ping 124.124.124.1**

Type escape sequence to abort.

Sending 5, 100-byte ICMP Echos to 124.124.124.1, timeout is 2 seconds:

!!!!!

Success rate is 100 percent (5/5), round-trip min/avg/max = 32/35/36 ms

Spicey

Spicey#**show frame-relay map**

Serial0 (up): ip 4.0.1.2 dlci 140(0x8C,0x20C0), static, broadcast, CISCO, status defined, active

Serial0 (up): ip 4.0.1.3 dlci 130(0x82,0x2020), static, broadcast, CISCO, status defined, active

Spicey#**show frame-relay pvc**

PVC Statistics for interface Serial0 (Frame Relay DTE)

	Active	Inactive	Deleted	Static
Local	2	0	0	0
Switched	0	0	0	0

```
Unused          0          0          0          0
```

```
DLCI = 130, DLCI USAGE = LOCAL, PVC STATUS = ACTIVE, INTERFACE = Serial0
```

```
input pkts 9          output pkts 48          in bytes 434
out bytes 11045        dropped pkts 0          in FECN pkts 0
in BECN pkts 0        out FECN pkts 0        out BECN pkts 0
in DE pkts 0          out DE pkts 0
out bcast pkts 48     out bcast bytes 11045
pvc create time 00:36:25, last time pvc status changed 00:36:15
```

```
DLCI = 140, DLCI USAGE = LOCAL, PVC STATUS = ACTIVE, INTERFACE = Serial0
```

```
input pkts 17         output pkts 26          in bytes 1390
out bytes 4195        dropped pkts 0          in FECN pkts 0
in BECN pkts 0        out FECN pkts 0        out BECN pkts 0
in DE pkts 0          out DE pkts 0
out bcast pkts 16     out bcast bytes 3155
pvc create time 00:08:39, last time pvc status changed 00:08:39
```

```
Spicey#ping 122.122.122.1
```

```
Type escape sequence to abort.
```

```
Sending 5, 100-byte ICMP Echos to 122.122.122.1, timeout is 2 seconds:
```

```
!!!!
```

```
Success rate is 100 percent (5/5), round-trip min/avg/max = 36/36/40 ms
```

```
Spicey#ping 123.123.123.1
```

```
Type escape sequence to abort.
```

```
Sending 5, 100-byte ICMP Echos to 123.123.123.1, timeout is 2 seconds:
```

```
!!!!
```

```
Success rate is 100 percent (5/5), round-trip min/avg/max = 32/35/36
```

Prasit

```
Prasit#show frame-relay map
```

```
Serial1.1 (up): ip 4.0.1.1 dlci 150(0x96,0x2460), static,
                broadcast,
                CISCO, status defined, active
```

```
Prasit#show frame-relay pvc
```

```
PVC Statistics for interface Serial1 (Frame Relay DTE)
```

	Active	Inactive	Deleted	Static
Local	1	0	0	0
Switched	0	0	0	0
Unused	0	0	0	0

```
DLCI = 150, DLCI USAGE = LOCAL, PVC STATUS = ACTIVE, INTERFACE = Serial1.1
```

```
input pkts 28          output pkts 19          in bytes 4753
out bytes 1490        dropped pkts 0          in FECN pkts 0
in BECN pkts 0        out FECN pkts 0        out BECN pkts 0
in DE pkts 0          out DE pkts 0
out bcast pkts 9      out bcast bytes 450
pvc create time 00:11:00, last time pvc status changed 00:11:00
```

```
Prasit#ping 124.124.124.1
```

```
Type escape sequence to abort.
```

```
Sending 5, 100-byte ICMP Echos to 124.124.124.1, timeout is 2 seconds:
```

```
!!!!
```

```
Success rate is 100 percent (5/5), round-trip min/avg/max = 36/36/36 ms
```

For more information on these commands, please see Frame Relay Commands.

Configuring IP Unnumbered Frame Relay

If you do not have the IP address space to use many subinterfaces, you can use IP unnumbered on each subinterface. If this is the case, you need to use static routes or dynamic routing so that your traffic is routed as usual, and you must use point-to-point subinterfaces.

Network Diagram

The example below illustrates this:



Configurations

- Spicey
- Prasit

```
Spicey
-----
Spicey#show running-config
Building configuration...
Current configuration : 1674 bytes
!
version 12.1
service timestamps debug datetime msec
service timestamps log datetime msec
no service password-encryption
!
hostname Spicey
!
!
!
interface Ethernet0
 ip address 124.124.124.1 255.255.255.0
!
interface Serial0
 no ip address
 encapsulation frame-relay
!
interface Serial0.1 point-to-point
 ip unnumbered Ethernet0
 frame-relay interface-dlci 140
!
router igrp 2
 network 124.0.0.0
!
line con 0
 exec-timeout 0 0
 transport input none
line aux 0
line vty 0 4
 login
!
end
```

Prasit

```
Prasit#show running-config
Building configuration...

Current configuration : 1188 bytes
!
version 12.1
service timestamps debug datetime msec
service timestamps log datetime msec
no service password-encryption
!
hostname Prasit
!
!
interface Ethernet0
 ip address 123.123.123.1 255.255.255.0
!
interface Serial1
 no ip address
 encapsulation frame-relay
!
interface Serial1.1 point-to-point
 ip unnumbered Ethernet0
 frame-relay interface-dlci 150
!
router igrp 2
 network 123.0.0.0
!
line con 0
 exec-timeout 0 0
 transport input none
line aux 0
line vty 0 4
 login
!
end
```

show Commands

- **show frame-relay map**
- **show frame-relay pvc**

Spicey

```
Spicey#show frame-relay map
Serial0.1 (up): point-to-point dlci, dlci 140(0x8C,0x20C0), broadcast
status defined, active
```

```
Spicey#show frame-relay pvc
```

```
PVC Statistics for interface Serial0 (Frame Relay DTE)
```

	Active	Inactive	Deleted	Static
Local	1	0	0	0
Switched	0	0	0	0
Unused	0	0	0	0

```
DLCI = 140, DLCI USAGE = LOCAL, PVC STATUS = ACTIVE, INTERFACE =
Serial0.1
```

input pkts 23	output pkts 24	in bytes 3391
out bytes 4952	dropped pkts 0	in FECN pkts 0
in BECN pkts 0	out FECN pkts 0	out BECN pkts 0

```
in DE pkts 0          out DE pkts 0
out bcast pkts 14     out bcast bytes 3912
pvc create time 00:04:47, last time pvc status changed 00:04:47
```

Spicey#**show ip route**

```
Codes: C - connected, S - static, I - IGRP, R - RIP, M - mobile, B - BGP
       D - EIGRP, EX - EIGRP external, O - OSPF, IA - OSPF inter area
       N1 - OSPF NSSA external type 1, N2 - OSPF NSSA external type 2
       E1 - OSPF external type 1, E2 - OSPF external type 2, E - EGP
       i - IS-IS, L1 - IS-IS level-1, L2 - IS-IS level-2, ia - IS-IS
inter area
       * - candidate default, U - per-user static route, o - ODR
       P - periodic downloaded static route
```

Gateway of last resort is not set

```
124.0.0.0/24 is subnetted, 1 subnets
C       124.124.124.0 is directly connected, Ethernet0
123.0.0.0/8 is variably subnetted, 2 subnets, 2 masks
I       123.0.0.0/8 [100/8576] via 123.123.123.1, 00:01:11, Serial0.1
I       123.123.123.0/32 [100/8576] via 123.123.123.1, 00:01:11,
Serial0.1
```

Spicey#**ping 123.123.123.1**

Type escape sequence to abort.

```
Sending 5, 100-byte ICMP Echos to 123.123.123.1, timeout is 2 seconds:
!!!!!
```

Success rate is 100 percent (5/5), round-trip min/avg/max = 36/36/36 ms

Prasit

Prasit#**show frame-relay map**

```
Serial1.1 (up): point-to-point dlci, dlci 150(0x96,0x2460), broadcast
status defined, active
```

Prasit#**show frame-relay pvc**

PVC Statistics for interface Serial1 (Frame Relay DTE)

	Active	Inactive	Deleted	Static
Local	1	0	0	0
Switched	0	0	0	0
Unused	0	0	0	0

```
DLCI = 150, DLCI USAGE = LOCAL, PVC STATUS = ACTIVE, INTERFACE =
Serial1.1
```

```
input pkts 24          output pkts 52          in bytes 4952
out bytes 10892        dropped pkts 0          in FECN pkts 0
in BECN pkts 0        out FECN pkts 0        out BECN pkts 0
in DE pkts 0          out DE pkts 0
out bcast pkts 41     out bcast bytes 9788
pvc create time 00:10:54, last time pvc status changed 00:03:51
```

Prasit#**show ip route**

```
Codes: C - connected, S - static, I - IGRP, R - RIP, M - mobile, B - BGP
       D - EIGRP, EX - EIGRP external, O - OSPF, IA - OSPF inter area
       N1 - OSPF NSSA external type 1, N2 - OSPF NSSA external type 2
       E1 - OSPF external type 1, E2 - OSPF external type 2, E - EGP
       i - IS-IS, L1 - IS-IS level-1, L2 - IS-IS level-2, ia - IS-IS
inter area
       * - candidate default, U - per-user static route, o - ODR
       P - periodic downloaded static route
```

Gateway of last resort is not set

```
124.0.0.0/8 is variably subnetted, 2 subnets, 2 masks
I       124.0.0.0/8 [100/8576] via 124.124.124.1, 00:00:18, Serial1.1
I       124.124.124.0/32 [100/8576] via 124.124.124.1, 00:00:18,
```

```

Serial1.1
  123.0.0.0/24 is subnetted, 1 subnets
C       123.123.123.0 is directly connected, Ethernet0

Prasit#ping 124.124.124.1
Type escape sequence to abort.
Sending 5, 100-byte ICMP Echos to 124.124.124.1, timeout is 2 seconds:
!!!!!!
Success rate is 100 percent (5/5), round-trip min/avg/max = 36/120/436 ms

```

Configuring Frame Relay Backup

Frame Relay Backup over ISDN

You may want to back up Frame Relay circuits using ISDN. There are several ways to do this. The first, and probably the best, is to use floating static routes that route traffic to a Basic Rate Interface (BRI) IP address and use an appropriate routing metric. You can also use a backup interface on the main interface or on a per-data-link connection identifier (DLCI) basis. It may not help much to back up the main interface because you could lose permanent virtual circuits (PVCs) without the main interface going down. Remember, the protocol is being exchanged with the local Frame Relay switch, not the remote router.

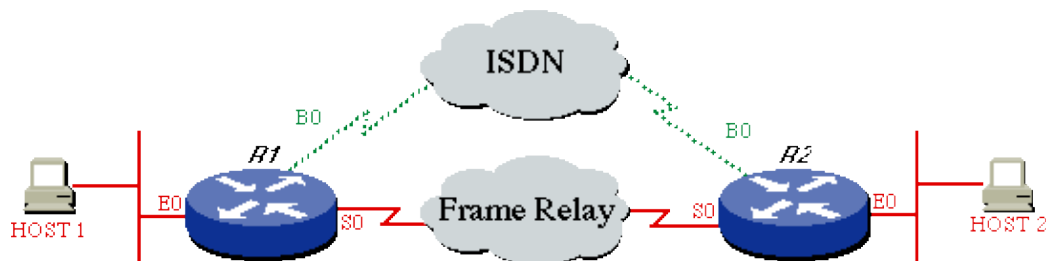

Configurations

- Router 1
- Router 2

Router 1
<pre> ROUTER1# ! hostname ROUTER1 ! username ROUTER2 password same isdn switch-type basic-dms100 ! interface Ethernet 0 ip address 172.16.15.1 255.255.255.248 ! interface serial 0 ip address 172.16.24.129 255.255.255.128 encapsulation FRAME-RELAY ! interface BRI0 description Backup ISDN for frame-relay ip address 172.16.12.1 255.255.255.128 encapsulation PPP dialer idle-timeout 240 dialer wait-for-carrier-time 60 dialer map IP 172.16.12.2 name ROUTER2 broadcast 7086639706 ppp authentication chap dialer-group 1 </pre>

```

    isdn spid1 0127280320 2728032
    isdn spid2 0127295120 2729512
!
router igrp 1
  network 172.16.0.0
!
ip route 172.16.15.16 255.255.255.248 172.16.12.2 150

!--- Floating static route.

!
access-list 101 deny   igrp 0.0.0.0 255.255.255.255 0.0.0.0 255.255.255.255
access-list 101 permit ip 0.0.0.0 255.255.255.255 0.0.0.0 255.255.255.255
dialer-list 1 LIST 101
!

```

Router 2

```

ROUTER2#
!
hostname ROUTER2
!
username ROUTER1 password same
  isdn switch-type basic-dms100
!
interface Ethernet 0
  ip address 172.16.15.17 255.255.255.248
!
interface Serial 0
  ip address 172.16.24.130 255.255.255.128
  encapsulation FRAME-RELAY
!
interface BRI0
  description ISDN backup interface for frame-relay
  ip address 172.16.12.2 255.255.255.128
  encapsulation PPP
  dialer idle-timeout 240
  dialer map IP 172.16.12.1 name ROUTER1 broadcast
  ppp authentication chap
  pulse-time 1
  dialer-group 1
  isdn spid1 0191933333 4445555
  isdn spid2 0191933334 4445556
!
router igrp 1
  network 172.16.0.0
!
ip route 172.16.15.0 255.255.255.248 172.16.12.1 150

!--- Floating static route.

!
access-list 101 deny   igrp 0.0.0.0 255.255.255.255 0.0.0.0 255.255.255.255
access-list 101 permit ip 0.0.0.0 255.255.255.255 162.27.9.0 0.0.0.255
dialer-list 1 LIST 101
!

```

show Commands

To verify if the ISDN is working, use the following **debug** commands. Before issuing **debug** commands, please see Important Information on Debug Commands.

- **debug isdn q931**

- debug ppp neg
- debug ppp auth

Try to make an ISDN call from the calling side to the central side without the backup commands. If this is successful, add the backup commands to the calling side.

Note: To test the backup, do not use the **shutdown** command on the serial interface but emulate a real serial line problem by pulling out the cable from the serial line.

Configuration Per DCLI Backup

Now let's assume that Spicey is the central side and that Prasit is the side making connections to the central side (Spicey). Take care that you only add the backup commands to the side that is calling the central side.

Note: Backup load is not supported on subinterfaces. As we do not track traffic levels on subinterfaces, no load is calculated.

Network Diagram

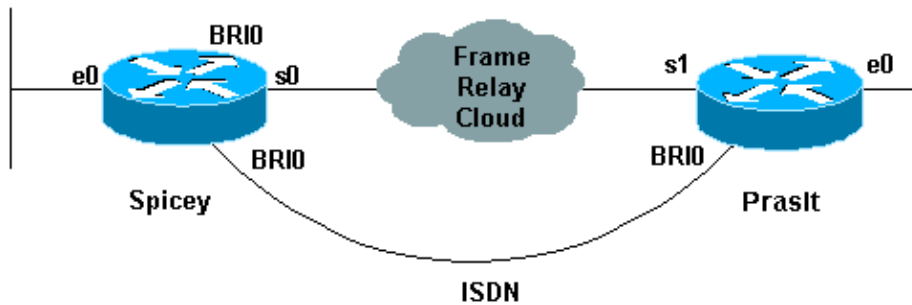

Configurations

- Spicey
- Prasit

Spicey
<pre> Spicey#show running-config Building configuration... Current configuration : 1438 bytes ! version 12.1 service timestamps debug datetime msec service timestamps log datetime msec no service password-encryption ! hostname Spicey ! ! username Prasit password 0 cisco ! ! ! isdn switch-type basic-net3 ! ! ! interface Ethernet0 ip address 124.124.124.1 255.255.255.0 </pre>

```

!
interface Serial0
  no ip address
  encapsulation frame-relay
!
interface Serial0.1 point-to-point
  ip address 4.0.1.1 255.255.255.0
  frame-relay interface-dlci 140
!
interface BRI0
  ip address 3.1.6.1 255.255.255.0
  encapsulation ppp
  dialer map ip 3.1.6.2 name Prasit broadcast
  dialer-group 1
  isdn switch-type basic-net3
  no peer default ip address
  no cdp enable
  ppp authentication chap
!
router igrp 2
  network 3.0.0.0
  network 4.0.0.0
  network 124.0.0.0
!
ip classless
  ip route 123.123.123.0 255.255.255.0 3.1.6.2 250
!
access-list 101 deny igrp any any
access-list 101 permit ip any any
dialer-list 1 protocol ip list 101
!
line con 0
  exec-timeout 0 0
  transport input none
line aux 0
line vty 0 4
  login
!
end

```

Prasit

```

Prasit#show running-config
Building configuration...

Current configuration : 1245 bytes
!
version 12.1
service timestamps debug datetime msec
service timestamps log datetime msec
no service password-encryption
!
hostname Prasit
!
username Spicey password 0 cisco
!
!
isdn switch-type basic-net3
!
!
!
interface Ethernet0
  ip address 123.123.123.1 255.255.255.0
!
interface Serial1

```

```

no ip address
encapsulation frame-relay
!
interface Serial1.1 point-to-point
backup delay 5 10
backup interface BRI0
ip address 4.0.1.2 255.255.255.0
frame-relay interface-dlci 150
!
interface BRI0
ip address 3.1.6.2 255.255.255.0
encapsulation ppp
dialer map ip 3.1.6.1 name Spicely broadcast 6106
dialer-group 1
isdn switch-type basic-net3
ppp authentication chap
!
router igrp 2
network 3.0.0.0
network 4.0.0.0
network 123.0.0.0
!
ip route 124.124.124.0 255.255.255.0 3.1.6.1 250
!
access-list 101 deny igrp any any
access-list 101 permit ip any any
dialer-list 1 protocol ip list 101
!
line con 0
exec-timeout 0 0
transport input none
line aux 0
line vty 0 4
login
!
end

```

show Commands

- **show frame-relay map**
- **show ip route**
- **show isdn history**
- **show isdn status**
- **show interface bri 0**
- **show isdn active**

Spicely

Spicely#**show frame-relay map**

Serial0.2 (up): point-to-point dlci, dlci 130(0x82,0x2020), broadcast status defined, active

Serial0.1 (up): point-to-point dlci, dlci 140(0x8C,0x20C0), broadcast status defined, active

Spicely#**show ip route**

Codes: C - connected, S - static, I - IGRP, R - RIP, M - mobile, B - BGP
D - EIGRP, EX - EIGRP external, O - OSPF, IA - OSPF inter area
N1 - OSPF NSSA external type 1, N2 - OSPF NSSA external type 2
E1 - OSPF external type 1, E2 - OSPF external type 2, E - EGP
i - IS-IS, L1 - IS-IS level-1, L2 - IS-IS level-2, ia - IS-IS
inter area
* - candidate default, U - per-user static route, o - ODR
P - periodic downloaded static route

Gateway of last resort is not set

```
3.0.0.0/24 is subnetted, 2 subnets C
3.1.3.0 is directly connected, Serial0.2 C
3.1.6.0 is directly connected, BRI0
4.0.0.0/24 is subnetted, 1 subnets C
4.0.1.0 is directly connected, Serial0.1
124.0.0.0/24 is subnetted, 1 subnets C
124.124.124.0 is directly connected, Ethernet0
123.0.0.0/8 is variably subnetted, 2 subnets, 2 masks I
123.0.0.0/8 [100/8576] via 4.0.1.2, 00:00:00, Serial0.1 S
123.123.123.0/24 [250/0] via 3.1.6.2 I
122.0.0.0/8 [100/8576] via 3.1.3.3, 00:00:37, Serial0.2
```

Spicey#

```
*Mar 1 00:59:12.527: %LINK-3-UPDOWN: Interface BRI0:1, changed state to up
*Mar 1 00:59:13.983: %LINEPROTO-5-UPDOWN: Line protocol on Interface
BRI0:1, changed state to up
*Mar 1 00:59:18.547: %ISDN-6-CONNECT: Interface BRI0:1 is now connected to 6105 Prasit
```

Spicey#**show isdn history**

ISDN CALL HISTORY

Call History contains all active calls, and a maximum of 100 inactive calls.
Inactive call data will be retained for a maximum of 15 minutes.

Call Charges Type	Calling Number	Called Number	Remote Name	Seconds Used	Seconds Left	Seconds Idle	Seconds Units/Currency
In	6105	6106	Prasit	31	90	29	

Spicey#

```
*Mar 1 01:01:14.547: %ISDN-6-DISCONNECT: Interface BRI0:1 disconnected
from 6105 Prasit, call lasted 122 seconds
*Mar 1 01:01:14.663: %LINK-3-UPDOWN: Interface BRI0:1, changed state to down
*Mar 1 01:01:15.663: %LINEPROTO-5-UPDOWN: Line protocol on Interface
BRI0:1, changed state to down
```

Prasit

Prasit#**show frame-relay map**

```
Serial1.1 (up): point-to-point dlci, dlci 150(0x96,0x2460), broadcast
status defined, active
```

Prasit#**ping 124.124.124.1**

```
Type escape sequence to abort.
Sending 5, 100-byte ICMP Echos to 124.124.124.1, timeout is 2 seconds:
!!!!
Success rate is 100 percent (5/5), round-trip min/avg/max = 36/36/40 ms
```

Prasit#**show ip route**

```
Codes: C - connected, S - static, I - IGRP, R - RIP, M - mobile, B - BGP
D - EIGRP, EX - EIGRP external, O - OSPF, IA - OSPF inter area
N1 - OSPF NSSA external type 1, N2 - OSPF NSSA external type 2
E1 - OSPF external type 1, E2 - OSPF external type 2, E - EGP
i - IS-IS, L1 - IS-IS level-1, L2 - IS-IS level-2, ia - IS-IS
inter area
* - candidate default, U - per-user static route, o - ODR
P - periodic downloaded static route
```

Gateway of last resort is not set

```

I   3.0.0.0/8 [100/10476] via 4.0.1.1, 00:00:55, Serial1.1
    4.0.0.0/24 is subnetted, 1 subnets
C   4.0.1.0 is directly connected, Serial1.1
    124.0.0.0/8 is variably subnetted, 2 subnets, 2 masks
S   124.124.124.0/24 [250/0] via 3.1.6.1
I   124.0.0.0/8 [100/8576] via 4.0.1.1, 00:00:55, Serial1.1
    123.0.0.0/24 is subnetted, 1 subnets
C   123.123.123.0 is directly connected, Ethernet0
I   122.0.0.0/8 [100/10576] via 4.0.1.1, 00:00:55, Serial1.1

```

The serial line goes down.

Prasit#

```

*Mar  1 01:23:50.531: %LINK-3-UPDOWN: Interface Serial1, changed state to down
*Mar  1 01:23:51.531: %LINEPROTO-5-UPDOWN: Line protocol on Interface
Serial1, changed state to down
*Mar  1 01:23:53.775: %LINK-3-UPDOWN: Interface BRI0:1, changed state to down
*Mar  1 01:23:53.791: %LINK-3-UPDOWN: Interface BRI0:2, changed state to down
*Mar  1 01:23:53.827: %LINK-3-UPDOWN: Interface BRI0, changed state to up
*Mar  1 01:23:57.931: %ISDN-6-LAYER2UP: Layer 2 for Interface BR0, TEI 64 changed to up

```

Prasit#**show ip route**

```

Codes: C - connected, S - static, I - IGRP, R - RIP, M - mobile, B - BGP
       D - EIGRP, EX - EIGRP external, O - OSPF, IA - OSPF inter area
       N1 - OSPF NSSA external type 1, N2 - OSPF NSSA external type 2
       E1 - OSPF external type 1, E2 - OSPF external type 2, E - EGP
       i - IS-IS, L1 - IS-IS level-1, L2 - IS-IS level-2, ia - IS-IS
inter area
       * - candidate default, U - per-user static route, o - ODR
       P - periodic downloaded static route

```

Gateway of last resort is not set

```

    3.0.0.0/24 is subnetted, 1 subnets
C   3.1.6.0 is directly connected, BRI0
    124.0.0.0/24 is subnetted, 1 subnets
S   124.124.124.0 [250/0] via 3.1.6.1
    123.0.0.0/24 is subnetted, 1 subnets
C   123.123.123.0 is directly connected, Ethernet0

```

Prasit#**show isdn status**

```

Global ISDN Switchtype = basic-net3
ISDN BRI0 interface
    dsl 0, interface ISDN Switchtype = basic-net3
Layer 1 Status:
    ACTIVE
Layer 2 Status:
    TEI = 64, Ces = 1, SAPI = 0, State = MULTIPLE_FRAME_ESTABLISHED
Layer 3 Status:
    0 Active Layer 3 Call(s)
Active dsl 0 CCBS = 0
The Free Channel Mask: 0x80000003
Total Allocated ISDN CCBS = 0

```

Prasit#**ping 124.124.124.1**

```

Type escape sequence to abort.
Sending 5, 100-byte ICMP Echos to 124.124.124.1, timeout is 2 seconds:
!
*Mar  1 01:25:47.383: %LINK-3-UPDOWN: Interface BRI0:1, changed state to up!!!
Success rate is 80 percent (4/5), round-trip min/avg/max = 36/36/36 ms
Prasit#
*Mar  1 01:25:48.475: %LINEPROTO-5-UPDOWN: Line protocol on Interface
BRI0:1, changed state to up

```

```
Prasit#
*Mar 1 01:25:53.407: %ISDN-6-CONNECT: Interface BRI0:1 is now connected
to 6106 Spicey
```

```
Prasit#show isdn status
Global ISDN Switchtype = basic-net3
ISDN BRI0 interface
    dsl 0, interface ISDN Switchtype = basic-net3
Layer 1 Status:
    ACTIVE
Layer 2 Status:
    TEI = 64, Ces = 1, SAPI = 0, State = MULTIPLE_FRAME_ESTABLISHED
Layer 3 Status:
    1 Active Layer 3 Call(s)
    CCB:callid=8003, sapi=0, ces=1, B-chan=1, calltype=DATA
Active dsl 0 CCBs = 1
The Free Channel Mask: 0x80000002
Total Allocated ISDN CCBs = 1
```

```
Prasit#show isdn active
```

```
-----
                                ISDN ACTIVE CALLS
-----
Call      Calling      Called      Remote   Seconds  Seconds  Seconds  Charges
Type      Number        Number      Name     Used     Left     Idle     Units/Currency
-----
Out              6106        Spicey     21      100      19       0
-----
```

```
Prasit#
*Mar 1 01:27:49.027: %ISDN-6-DISCONNECT: Interface BRI0:1 disconnected
from 6106 Spicey, call lasted 121 seconds
*Mar 1 01:27:49.131: %LINK-3-UPDOWN: Interface BRI0:1, changed state to down
*Mar 1 01:27:50.131: %LINEPROTO-5-UPDOWN: Line protocol on Interface
BRI0:1, changed state to down
*Mar 1 01:28:09.215: %LINK-3-UPDOWN: Interface Serial1, changed state to up
*Mar 1 01:28:10.215: %LINEPROTO-5-UPDOWN: Line protocol on Interface
Serial1, changed state to up
*Mar 1 01:28:30.043: %ISDN-6-LAYER2DOWN: Layer 2 for Interface BRI0,
TEI 64 changed to down
*Mar 1 01:28:30.047: %ISDN-6-LAYER2DOWN: Layer 2 for Interface BR0, TEI
64 changed to down
*Mar 1 01:28:30.371: %LINK-5-CHANGED: Interface BRI0, changed state to standby mode
*Mar 1 01:28:30.387: %LINK-3-UPDOWN: Interface BRI0:1, changed state to down
*Mar 1 01:28:30.403: %LINK-3-UPDOWN: Interface BRI0:2, changed state to down
Prasit#
```

The serial connection is back again..

```
Prasit#show isdn status
Global ISDN Switchtype = basic-net3
ISDN BRI0 interface
    dsl 0, interface ISDN Switchtype = basic-net3
Layer 1 Status:
    DEACTIVATED
Layer 2 Status:
    Layer 2 NOT Activated
Layer 3 Status:
    0 Active Layer 3 Call(s)
Active dsl 0 CCBs = 0
The Free Channel Mask: 0x80000003
Total Allocated ISDN CCBs = 0
```

```
Prasit#show interface bri 0
BRI0 is standby mode, line protocol is down
Hardware is BRI
```

```

Internet address is 3.1.6.2/24
MTU 1500 bytes, BW 64 Kbit, DLY 20000 usec,
  reliability 255/255, txload 1/255, rxload 1/255
Encapsulation PPP, loopback not set
Last input 00:01:00, output 00:01:00, output hang never
Last clearing of "show interface" counters 01:28:16
Input queue: 0/75/0/0 (size/max/drops/flushes); Total output drops: 0
Queueing strategy: weighted fair
Output queue: 0/1000/64/0 (size/max total/threshold/drops)
  Conversations 0/1/16 (active/max active/max total)
  Reserved Conversations 0/0 (allocated/max allocated)
5 minute input rate 0 bits/sec, 0 packets/sec
5 minute output rate 0 bits/sec, 0 packets/sec
  128 packets input, 601 bytes, 0 no buffer
  Received 0 broadcasts, 0 runts, 0 giants, 0 throttles
  0 input errors, 0 CRC, 0 frame, 0 overrun, 0 ignored, 0 abort
  132 packets output, 687 bytes, 0 underruns
  0 output errors, 0 collisions, 10 interface resets
  0 output buffer failures, 0 output buffers swapped out
  14 carrier transitions

```

```
Prasit#ping 124.124.124.1
```

```

Type escape sequence to abort.
Sending 5, 100-byte ICMP Echos to 124.124.124.1, timeout is 2 seconds:
!!!!
Success rate is 100 percent (5/5), round-trip min/avg/max = 36/36/36 ms

```

Hub and Spoke with Dialer Profiles

Here is an example of a hub and spoke per DLCI backup configuration. The spoke routers are calling the hub router. As you can see, we allow only one B channel per side by using the max-link option on the dialer pool on the hub side.

Note: Backup load is not supported on subinterfaces. As we do not track traffic levels on subinterfaces, no load is calculated.

Network Diagram

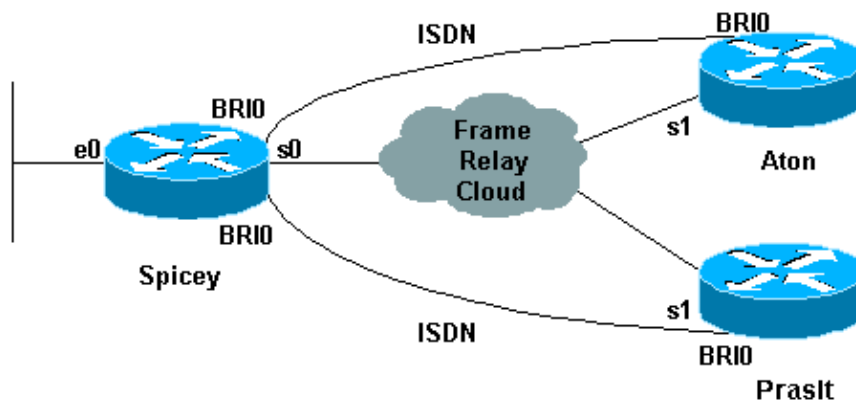

Configurations

- Aton
- Spicey
- Prasit

Aton

```
Aton#show running-config
Building configuration...

Current configuration:
!
version 12.0
service timestamps debug uptime
service timestamps log uptime
no service password-encryption
!
hostname Aton
!
!
username Spicey password 0 cisco
!
isdn switch-type basic-net3
!
!
!
interface Ethernet0
 ip address 122.122.122.1 255.255.255.0
!
!
interface Serial1
 no ip address
 encapsulation frame-relay
!
interface Serial1.1 point-to-point
 ip address 3.1.3.3 255.255.255.0
 backup delay 5 10
 backup interface BRI0
 frame-relay interface-dlci 160
!
interface BRI0
 ip address 155.155.155.3 255.255.255.0
 encapsulation ppp
 no ip route-cache
 no ip mroute-cache
 dialer map ip 155.155.155.2 name Spicey broadcast 6106
 dialer-group 1
 isdn switch-type basic-net3
 ppp authentication chap
!
router igrp 2
 network 3.0.0.0
 network 122.0.0.0
 network 155.155.0.0
!
ip route 124.124.124.0 255.255.255.0 155.155.155.2 250
!
access-list 101 deny igrp any any
access-list 101 permit ip any any
dialer-list 1 protocol ip list 101
!
line con 0
 exec-timeout 0 0
 transport input none
line aux 0
line vty 0 4
 login
!
end
```

Spicey

```
Spicey#show running-config
Building configuration...
Current configuration : 1887 bytes
!
version 12.1
service timestamps debug datetime msec
service timestamps log datetime msec
no service password-encryption
!
hostname Spicey
!
username Prasit password 0 cisco
username Aton password 0 cisco
!
isdn switch-type basic-net3
!
!
!
interface Ethernet0
 ip address 124.124.124.1 255.255.255.0
!
interface Serial0
 no ip address
 encapsulation frame-relay
!
interface Serial0.1 point-to-point
 ip address 4.0.1.1 255.255.255.0
 frame-relay interface-dlci 140
!
interface Serial0.2 point-to-point
 ip address 3.1.3.1 255.255.255.0
 frame-relay interface-dlci 130
!
interface BRI0
 no ip address
 encapsulation ppp
 no ip route-cache
 no ip mroute-cache
 dialer pool-member 2 max-link 1
 dialer pool-member 1 max-link 1
 isdn switch-type basic-net3
 no peer default ip address
 no cdp enable
 ppp authentication chap
!
interface Dialer1
 ip address 160.160.160.1 255.255.255.0
 encapsulation ppp
 no ip route-cache
 no ip mroute-cache
 dialer pool 1
 dialer remote-name Prasit
 dialer-group 1
 ppp authentication chap
!
interface Dialer2
 ip address 155.155.155.2 255.255.255.0
 encapsulation ppp
 no ip route-cache
 no ip mroute-cache
 dialer pool 2
 dialer remote-name Aton
 dialer-group 1
 ppp authentication chap
```

```

!
router igrp 2
 network 3.0.0.0
 network 4.0.0.0
 network 124.0.0.0
 network 155.155.0.0
 network 160.160.0.0
!
access-list 101 deny igrp any any
access-list 101 permit ip any any
dialer-list 1 protocol ip list 101
!
line con 0
 exec-timeout 0 0
 transport input none
line aux 0
line vty 0 4
 login
!
end

```

Prasit

```

Prasit#show running-config
Building configuration...

Current configuration : 1267 bytes
!
version 12.1
service timestamps debug datetime msec
service timestamps log datetime msec
no service password-encryption
!
hostname Prasit
!
username Spicey password 0 cisco
!
isdn switch-type basic-net3
!
!
!
interface Ethernet0
 ip address 123.123.123.1 255.255.255.0
!
interface Serial1
 no ip address
 encapsulation frame-relay
!
interface Serial1.1 point-to-point
 backup delay 5 10
 backup interface BRI0
 ip address 4.0.1.2 255.255.255.0
 frame-relay interface-dlci 150
!
interface BRI0
 ip address 160.160.160.2 255.255.255.0
 encapsulation ppp
 dialer map ip 160.160.160.1 name Spicey broadcast 6106
 dialer-group 1
 isdn switch-type basic-net3
 ppp authentication chap
!
router igrp 2
 network 4.0.0.0
 network 123.0.0.0

```

```

network 160.160.0.0
!
ip route 124.124.124.0 255.255.255.0 160.160.160.1 250
!
access-list 101 deny   igmp any any
access-list 101 permit ip any any
dialer-list 1 protocol ip list 101
!
line con 0
exec-timeout 0 0
transport input none
line aux 0
line vty 0 4
login
!
end

```

show Commands

- **show frame-relay map**
- **show ip route**
- **show frame map**
- **show frame-relay pvc**

Aton

Aton#**show frame-relay map**

```

Serial1.1 (up): point-to-point dlci, dlci 160(0xA0,0x2800), broadcast
status defined, active

```

Aton#**ping 124.124.124.1**

Type escape sequence to abort.

Sending 5, 100-byte ICMP Echos to 124.124.124.1, timeout is 2 seconds:

!!!!

Success rate is 100 percent (5/5), round-trip min/avg/max = 36/36/36 ms

Aton#**show ip route**

```

Codes: C - connected, S - static, I - IGRP, R - RIP, M - mobile, B - BGP
        D - EIGRP, EX - EIGRP external, O - OSPF, IA - OSPF inter area
        N1 - OSPF NSSA external type 1, N2 - OSPF NSSA external type 2
        E1 - OSPF external type 1, E2 - OSPF external type 2, E - EGP
        i - IS-IS, L1 - IS-IS level-1, L2 - IS-IS level-2, * - candidate default
        U - per-user static route, o - ODR, P - periodic downloaded static route
        T - traffic engineered route

```

Gateway of last resort is not set

```

I   155.155.0.0/16 [100/182571] via 3.1.3.1, Serial1.1
    3.0.0.0/24 is subnetted, 1 subnets
C   3.1.3.0 is directly connected, Serial1.1
I   4.0.0.0/8 [100/10476] via 3.1.3.1, Serial1.1
I   160.160.0.0/16 [100/182571] via 3.1.3.1, Serial1.1
    124.0.0.0/8 is variably subnetted, 2 subnets, 2 masks
S   124.124.124.0/24 [250/0] via 155.155.155.2
I   124.0.0.0/8 [100/8576] via 3.1.3.1, Serial1.1
I   123.0.0.0/8 [100/10576] via 3.1.3.1, Serial1.1
    122.0.0.0/24 is subnetted, 1 subnets
C   122.122.122.0 is directly connected, Ethernet0
Aton#

```

Serial 1 is going down.

Aton#

```
01:16:33: %LINK-3-UPDOWN: Interface Serial1, changed state to down
01:16:34: %LINEPROTO-5-UPDOWN: Line protocol on Interface Serial1,
changed state to down
01:16:37: %LINK-3-UPDOWN: Interface BRI0:1, changed state to down
01:16:37: %LINK-3-UPDOWN: Interface BRI0:2, changed state to down
01:16:37: %LINK-3-UPDOWN: Interface BRI0, changed state to up
01:16:41: %ISDN-6-LAYER2UP: Layer 2 for Interface BR0, TEI 64 changed to up
```

Aton#show ip route

```
Codes: C - connected, S - static, I - IGRP, R - RIP, M - mobile, B - BGP
       D - EIGRP, EX - EIGRP external, O - OSPF, IA - OSPF inter area
       N1 - OSPF NSSA external type 1, N2 - OSPF NSSA external type 2
       E1 - OSPF external type 1, E2 - OSPF external type 2, E - EGP
       i - IS-IS, L1 - IS-IS level-1, L2 - IS-IS level-2, * - candidate default
       U - per-user static route, o - ODR, P - periodic downloaded static route
       T - traffic engineered route
```

```
Gateway of last resort is not set
 155.155.0.0/24 is subnetted, 1 subnets
C   155.155.155.0 is directly connected, BRI0
 124.0.0.0/24 is subnetted, 1 subnets
S   124.124.124.0 [250/0] via 155.155.155.2
 122.0.0.0/24 is subnetted, 1 subnets
C   122.122.122.0 is directly connected, Ethernet0
```

Aton#ping 124.124.124.1

```
Type escape sequence to abort.
Sending 5, 100-byte ICMP Echos to 124.124.124.1, timeout is 2 seconds:
```

```
01:21:33: %LINK-3-UPDOWN: Interface BRI0:1, changed state to up!!!!
Success rate is 80 percent (4/5), round-trip min/avg/max = 36/36/36 ms
Aton#
```

```
01:21:34: %LINEPROTO-5-UPDOWN: Line protocol on Interface BRI0:1,
changed state to up
01:21:39: %ISDN-6-CONNECT: Interface BRI0:1 is now connected to 6106
Spicey
```

Aton#ping 124.124.124.1

```
Type escape sequence to abort.
Sending 5, 100-byte ICMP Echos to 124.124.124.1, timeout is 2 seconds:
!!!!
Success rate is 100 percent (5/5), round-trip min/avg/max = 32/123/296 ms
Aton#
```

Serial 1 becomes active again

Aton#

```
01:24:02: %ISDN-6-DISCONNECT: Interface BRI0:1 disconnected from 6106
Spicey, call lasted 149 seconds
01:24:02: %LINK-3-UPDOWN: Interface BRI0:1, changed state to down
01:24:03: %LINEPROTO-5-UPDOWN: Line protocol on Interface BRI0:1,
changed state to down
```

Aton#show frame map

```
Serial1.1 (down): point-to-point dlci, dlci 160(0xA0,0x2800), broadcast
status deleted
```

Aton#

```
01:26:35: %LINK-3-UPDOWN: Interface Serial1, changed state to up
01:26:36: %LINEPROTO-5-UPDOWN: Line protocol on Interface Serial1,
changed state to up
01:26:56: %ISDN-6-LAYER2DOWN: Layer 2 for Interface BRI0, TEI 64 changed
to down
01:26:56: %ISDN-6-LAYER2DOWN: Layer 2 for Interface BR0, TEI 64 changed
to down
01:26:56: %LINK-5-CHANGED: Interface BRI0, changed state to standby mode
```

```
01:26:56: %LINK-3-UPDOWN: Interface BRI0:1, changed state to down
01:26:56: %LINK-3-UPDOWN: Interface BRI0:2, changed state to down
```

```
Aton#show frame map
```

```
Serial1.1 (up): point-to-point dlci, dlci 160(0xA0,0x2800), broadcast
status defined, active
```

```
Aton#ping 124.124.124.1
```

```
Type escape sequence to abort.
```

```
Sending 5, 100-byte ICMP Echos to 124.124.124.1, timeout is 2 seconds:
```

```
!!!!
```

```
Success rate is 100 percent (5/5), round-trip min/avg/max = 36/36/36 ms
```

```
Aton#ping 124.124.124.1
```

```
Aton#show frame-relay pvc
```

```
PVC Statistics for interface Serial1 (Frame Relay DTE)
```

	Active	Inactive	Deleted	Static
Local	1	0	0	0
Switched	0	0	0	0
Unused	0	0	0	0

```
DLCI = 160, DLCI USAGE = LOCAL, PVC STATUS = ACTIVE, INTERFACE =
Serial1.1
```

```
input pkts 60          output pkts 69          in   bytes 9694
out bytes 10811        dropped pkts 0          in   FECN pkts 0
in BECN pkts 0        out FECN pkts 0        out BECN pkts 0
in DE pkts 0          out DE pkts 0
out bcast pkts 44     out   bcast bytes 7565
pvc create time 01:28:35, last time pvc status changed 00:02:19
```

Spicey

```
Spicey#show frame-relay map
```

```
Serial0.1 (up): point-to-point dlci, dlci 140(0x8C,0x20C0), broadcast
status defined, active
```

```
Serial0.2 (up): point-to-point dlci, dlci 130(0x82,0x2020), broadcast
status defined, active
```

```
Spicey#ping 122.122.122.1
```

```
Type escape sequence to abort.
```

```
Sending 5, 100-byte ICMP Echos to 122.122.122.1, timeout is 2 seconds:
```

```
!!!!
```

```
Success rate is 100 percent (5/5), round-trip min/avg/max = 32/35/36 ms
```

```
Spicey#ping 123.123.123.1
```

```
Type escape sequence to abort.
```

```
Sending 5, 100-byte ICMP Echos to 123.123.123.1, timeout is 2 seconds:
```

```
!!!!
```

```
Success rate is 100 percent (5/5), round-trip min/avg/max = 36/36/36 ms
```

```
Spicey#show ip route
```

```
Codes: C - connected, S - static, I - IGRP, R - RIP, M - mobile, B - BGP
D - EIGRP, EX - EIGRP external, O - OSPF, IA - OSPF inter area
N1 - OSPF NSSA external type 1, N2 - OSPF NSSA external type 2
E1 - OSPF external type 1, E2 - OSPF external type 2, E - EGP
i - IS-IS, L1 - IS-IS level-1, L2 - IS-IS level-2, ia - IS-IS
inter area
* - candidate default, U - per-user static route, o - ODR
P - periodic downloaded static route
```

```
Gateway of last resort is not set
```

```
155.155.0.0/24 is subnetted, 1 subnets
```

```
C 155.155.155.0 is directly connected, Dialer2
```

```
3.0.0.0/24 is subnetted, 1 subnets
```

```
C 3.1.3.0 is directly connected, Serial0.2
```

```
4.0.0.0/24 is subnetted, 1 subnets
```

```

C    4.0.1.0 is directly connected, Serial0.1
    160.160.0.0/24 is subnetted, 1 subnets
C    160.160.160.0 is directly connected, Dialer1
    124.0.0.0/24 is subnetted, 1 subnets
C    124.124.124.0 is directly connected, Ethernet0
I    123.0.0.0/8 [100/8576] via 4.0.1.2, 00:00:55, Serial0.1
I    122.0.0.0/8 [100/8576] via 3.1.3.3, 00:00:35, Serial0.2

```

Both serial lines from the calling sides are going down.

Spicey#

```

*Mar  1 01:21:30.171: %LINK-3-UPDOWN: Interface BRI0:1, changed state to up
*Mar  1 01:21:30.627: %DIALER-6-BIND: Interface BR0:1 bound to profile Di2
*Mar  1 01:21:31.647: %LINEPROTO-5-UPDOWN: Line protocol on Interface
BRI0:1, changed state to up
*Mar  1 01:21:36.191: %ISDN-6-CONNECT: Interface BRI0:1 is now connected
to 6104 Aton
*Mar  1 01:21:40.923: %LINK-3-UPDOWN: Interface BRI0:2, changed state to up
*Mar  1 01:21:41.359: %DIALER-6-BIND: Interface BR0:2 bound to profile Di1
*Mar  1 01:21:42.383: %LINEPROTO-5-UPDOWN: Line protocol on Interface
BRI0:2, changed state to up
*Mar  1 01:21:46.943: %ISDN-6-CONNECT: Interface BRI0:2 is now connected
to 6105 Prasit
*Mar  1 01:23:59.819: %DIALER-6-UNBIND: Interface BR0:1 unbound from
profile Di2
*Mar  1 01:23:59.831: %ISDN-6-DISCONNECT: Interface BRI0:1 disconnected
from 6104 Aton, call lasted 149 seconds
*Mar  1 01:23:59.927: %LINK-3-UPDOWN: Interface BRI0:1, changed state to down
*Mar  1 01:24:00.923: %LINEPROTO-5-UPDOWN: Line protocol on Interface
BRI0:1, changed state to down
*Mar  1 01:24:03.015: %DIALER-6-UNBIND: Interface BR0:2 unbound from
profile Di1
*Mar  1 01:24:03.023: %ISDN-6-DISCONNECT: Interface BRI0:2 disconnected
from 6105 Prasit, call lasted 142 seconds
*Mar  1 01:24:03.107: %LINK-3-UPDOWN: Interface BRI0:2, changed state to down
*Mar  1 01:24:04.107: %LINEPROTO-5-UPDOWN: Line protocol on Interface
BRI0:2, changed state to down

```

Spicey#**show frame map**

```

Serial0.1 (down): point-to-point dlci, dlci 140(0x8C,0x20C0), broadcast
status defined, inactive
Serial0.2 (down): point-to-point dlci, dlci 130(0x82,0x2020), broadcast
status defined, inactive

```

Spicey#

Both serial lines are available again.

Spicey#**show frame pvc**

PVC Statistics for interface Serial0 (Frame Relay DTE)

	Active	Inactive	Deleted	Static
Local	2	0	0	0
Switched	0	0	0	0
Unused	0	0	0	0

DLCI = 130, DLCI USAGE = LOCAL, PVC STATUS = ACTIVE, INTERFACE = Serial0.2

```

input pkts 54          output pkts 61          in   bytes 7014
out bytes 9975         dropped pkts 3          in   FECN pkts 0
in BECN pkts 0        out FECN pkts 0        out BECN pkts 0
in DE pkts 0          out DE pkts 0
out bcast pkts 40     out   bcast bytes 7803
pvc create time 01:28:14, last time pvc status changed 00:02:38

```

```
DLCI = 140, DLCI USAGE = LOCAL, PVC STATUS = ACTIVE, INTERFACE =  
Serial0.1
```

```
input pkts 56          output pkts 60          in    bytes 7604  
out bytes 10114       dropped pkts 2         in    FECN pkts 0  
in BECN pkts 0       out FECN pkts 0       out BECN  pkts 0  
in DE pkts 0         out DE pkts 0  
out bcast pkts 39    out    bcast bytes 7928  
pvc create time 01:28:15, last time pvc status changed 00:02:29
```

Prasit

```
Prasit#show frame-relay map
```

```
Serial1.1 (up): point-to-point dlci, dlci 150(0x96,0x2460), broadcast  
status defined, active
```

```
Prasit#ping 124.124.124.1
```

```
Type escape sequence to abort.
```

```
Sending 5, 100-byte ICMP Echos to 124.124.124.1, timeout is 2 seconds:
```

```
!!!!
```

```
Success rate is 100 percent (5/5), round-trip min/avg/max = 36/36/40 ms
```

```
Prasit#show ip route
```

```
Codes: C - connected, S - static, I - IGRP, R - RIP, M - mobile, B - BGP  
D - EIGRP, EX - EIGRP external, O - OSPF, IA - OSPF inter area  
N1 - OSPF NSSA external type 1, N2 - OSPF NSSA external type 2  
E1 - OSPF external type 1, E2 - OSPF external type 2, E - EGP  
i - IS-IS, L1 - IS-IS level-1, L2 - IS-IS level-2, ia - IS-IS  
inter area  
* - candidate default, U - per-user static route, o - ODR  
P - periodic downloaded static route
```

```
Gateway of last resort is not set
```

```
I 155.155.0.0/16 [100/182571] via 4.0.1.1, 00:00:41, Serial1.1  
I 3.0.0.0/8 [100/10476] via 4.0.1.1, 00:00:41, Serial1.1  
4.0.0.0/24 is subnetted, 1 subnets  
C 4.0.1.0 is directly connected, Serial1.1  
I 160.160.0.0/16 [100/182571] via 4.0.1.1, 00:00:41, Serial1.1  
124.0.0.0/8 is variably subnetted, 2 subnets, 2 masks  
S 124.124.124.0/24 [250/0] via 160.160.160.1  
I 124.0.0.0/8 [100/8576] via 4.0.1.1, 00:00:41, Serial1.1  
123.0.0.0/24 is subnetted, 1 subnets  
C 123.123.123.0 is directly connected, Ethernet0  
I 122.0.0.0/8 [100/10576] via 4.0.1.1, 00:00:42, Serial1.1  
Prasit#
```

Serial 1 goes down.

```
Prasit#
```

```
*Mar 1 01:16:08.287: %LINK-3-UPDOWN: Interface Serial1, changed state to down  
*Mar 1 01:16:09.287: %LINEPROTO-5-UPDOWN: Line protocol on Interface  
Serial1, changed state to down  
*Mar 1 01:16:11.803: %LINK-3-UPDOWN: Interface BRI0:1, changed state to down  
*Mar 1 01:16:11.819: %LINK-3-UPDOWN: Interface BRI0:2, changed state to down  
*Mar 1 01:16:11.855: %LINK-3-UPDOWN: Interface BRI0, changed state to up  
*Mar 1 01:16:15.967: %ISDN-6-LAYER2UP: Layer 2 for Interface BR0, TEI  
64 changed to up
```

```
Prasit#show ip route
```

```
Codes: C - connected, S - static, I - IGRP, R - RIP, M - mobile, B - BGP  
D - EIGRP, EX - EIGRP external, O - OSPF, IA - OSPF inter area  
N1 - OSPF NSSA external type 1, N2 - OSPF NSSA external type 2  
E1 - OSPF external type 1, E2 - OSPF external type 2, E - EGP  
i - IS-IS, L1 - IS-IS level-1, L2 - IS-IS level-2, ia - IS-IS
```

```
inter area
    * - candidate default, U - per-user static    route, o - ODR
    P - periodic downloaded static route
```

Gateway of last resort is not set

```
    160.160.0.0/24 is subnetted, 1 subnets
C   160.160.160.0 is directly connected, BRI0
    124.0.0.0/24 is subnetted, 1 subnets
S   124.124.124.0 [250/0] via 160.160.160.1
    123.0.0.0/24 is subnetted, 1 subnets
C   123.123.123.0 is directly connected, Ethernet0
```

Prasit#**ping 124.124.124.1**

Type escape sequence to abort.

Sending 5, 100-byte ICMP Echos to 124.124.124.1, timeout is 2 seconds:

```
*Mar  1 01:21:38.967: %LINK-3-UPDOWN: Interface BRI0:1, changed state to
up!!!!
```

Success rate is 80 percent (4/5), round-trip min/avg/max = 36/36/36 ms

Prasit#

```
*Mar  1 01:21:40.063: %LINEPROTO-5-UPDOWN: Line protocol on Interface
BRI0:1, changed state to up
```

```
*Mar  1 01:21:44.991: %ISDN-6-CONNECT: Interface BRI0:1 is now connected
to 6106 Spicey
```

Prasit#**ping 124.124.124.1**

Type escape sequence to abort.

Sending 5, 100-byte ICMP Echos to 124.124.124.1, timeout is 2 seconds:

```
!!!!
```

Success rate is 100 percent (5/5), round-trip min/avg/max = 36/36/36 ms

Prasit#

Serial 1 becomes active again.

Prasit#

```
*Mar  1 01:26:40.579: %LINK-3-UPDOWN: Interface Serial1, changed state to up
```

```
*Mar  1 01:26:41.579: %LINEPROTO-5-UPDOWN: Line protocol on Interface
Serial1, changed state to up
```

```
*Mar  1 01:27:01.051: %ISDN-6-LAYER2DOWN: Layer 2 for Interface BRI0,
TEI 64 changed to down
```

```
*Mar  1 01:27:01.055: %ISDN-6-LAYER2DOWN: Layer 2 for Interface BR0, TEI
64 changed to down
```

```
*Mar  1 01:27:01.363: %LINK-5-CHANGED: Interface BRI0, changed state to standby mode
```

```
*Mar  1 01:27:01.379: %LINK-3-UPDOWN: Interface BRI0:1, changed state to down
```

```
*Mar  1 01:27:01.395: %LINK-3-UPDOWN: Interface BRI0:2, changed state to down
```

Prasit#**show frame map**

```
Serial1.1 (up): point-to-point dlci, dlci 150(0x96,0x2460), broadcast
status defined, active
```

Prasit#**ping 124.124.124.1**

Type escape sequence to abort.

Sending 5, 100-byte ICMP Echos to 124.124.124.1, timeout is 2 seconds:

```
!!!!
```

Success rate is 100 percent (5/5), round-trip min/avg/max = 36/116/432 ms

Prasit#**show frame-relay pvc**

PVC Statistics for interface Serial1 (Frame Relay DTE)

	Active	Inactive	Deleted	Static
Local	1	0	0	0
Switched	0	0	0	0

```

Unused          0          0          0          0

DLCI = 150, DLCI USAGE = LOCAL, PVC STATUS = ACTIVE, INTERFACE =
Serial1.1

input pkts 58          output pkts 66          in   bytes 9727
out bytes 10022        dropped pkts 0          in   FECN pkts 0
in BECN pkts 0        out FECN pkts 0        out BECN   pkts 0
in DE pkts 0          out DE pkts 0
out bcast pkts 46     out   bcast bytes 7942
pvc create time 01:27:37, last time pvc status changed 00:01:59

```

Configuring Frame Relay Switching

Frame Relay switching is a means of switching packets based on the data-link connection identifier (DLCI). We can look on this as the Frame Relay equivalent of a Media Access Control (MAC) address. You perform switching by configuring your Cisco router or access server into a Frame Relay network. There are two parts to a Frame Relay network:

- Frame Relay data terminal equipment (DTE) – the router or access server.
- Frame Relay data circuit-terminating equipment (DCE) switch.

Note: In Cisco IOS Software release 12.1(2)T and later, the **frame route** command has been replaced by the **connect** command.

Let's look at a sample configuration. In the configuration below, we are using the router America as a Frame Relay switch. We are using Spicey as a hub router and Prasit and Aton as spoke routers. We have connected them as follows:

- Prasit serial 1 (s1) DTE is connected to America serial 1/4 (s1/4) DCE.
- Spicey serial 0 (s0) DTE is connected to America serial 1/5 (s1/5) DCE.
- Aton serial 1 (s1) DTE is connected to America serial 3/4 (s3/4) DCE.

Network Diagram

This document is based on the following configuration:

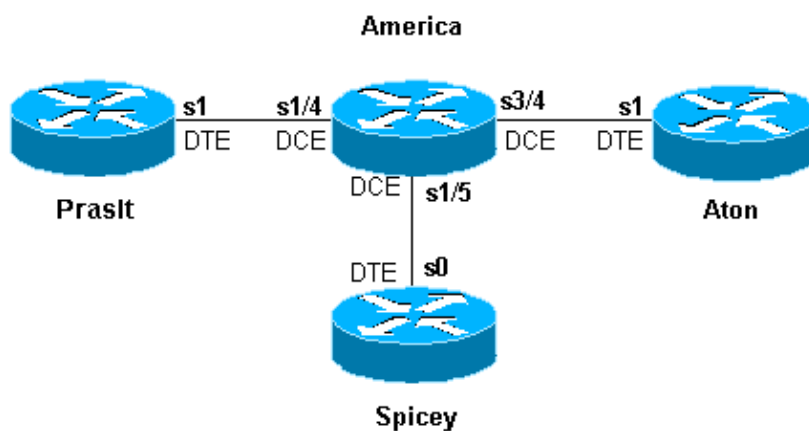

Configurations

- Spicey
- Prasit

- Aton
- America

Spicey

```
Spicey#show running-config
Building configuration...

!
version 12.1
service timestamps debug datetime msec
service timestamps log datetime msec
no service password-encryption
!
hostname Spicey
!
!
!
interface Ethernet0
 ip address 124.124.124.1 255.255.255.0
!
interface Serial0
 ip address 3.1.3.1 255.255.255.0
 encapsulation frame-relay
 frame-relay interface-dlci 130
 frame-relay interface-dlci 140
!
!
router rip
 network 3.0.0.0
 network 124.0.0.0
!
line con 0
!
exec-timeout 0 0
 transport input none
 line aux 0
 line vty 0 4
 login
!
end
```

Prasit

```
Prasit#show running-config
Building configuration...
Current configuration : 1499 bytes
!
 version 12.1
service timestamps debug datetime msec
service timestamps log datetime msec
no service password-encryption
!
hostname Prasit
!
!
!
interface Ethernet0
 ip address 123.123.123.1 255.255.255.0
!
interface Serial1
 ip address 3.1.3.2 255.255.255.0
 encapsulation frame-relay
 frame-relay interface-dlci 150
!
!
```

```
!  
router rip  
  network 3.0.0.0  
  network 123.0.0.0  
!  
!  
line con 0  
  exec-timeout 0 0  
  transport input none  
line aux 0  
line vty 0 4  
  login  
!  
end
```

Aton

```
Aton#show running-config  
Building configuration...  
Current configuration:  
!  
version 12.0  
service timestamps debug uptime  
service timestamps log uptime  
no service password-encryption  
!  
hostname Aton  
!  
!  
!  
interface Ethernet0  
  ip address 122.122.122.1 255.255.255.0  
!  
interface Serial1  
  ip address 3.1.3.3 255.255.255.0  
  encapsulation frame-relay  
  frame-relay interface-dlci 160  
!  
router rip  
  network 3.0.0.0  
  network 122.0.0.0  
!  
!  
line con 0  
  exec-timeout 0 0  
  transport input none  
line aux 0  
line vty 0 4  
  login  
!  
end
```

America

```
america#show running-config  
Building configuration...  
Current configuration:  
!  
!  
service timestamps debug datetime msec  
service timestamps log datetime msec  
no service password-encryption  
!  
hostname america  
!  
!
```

```

frame-relay switching
!
!
interface Serial1/4
description *** static DCE connection to s1 Prasit
no ip address
encapsulation frame-relay
clockrate 2000000
frame-relay intf-type dce
frame-relay route 150 interface Serial1/5 140
!
interface Serial1/5
description *** static DCE connection to s0 spicy
no ip address
encapsulation frame-relay
bandwidth 1000000
tx-queue-limit 100
frame-relay intf-type dce
frame-relay route 130 interface Serial3/4 160
frame-relay route 140 interface Serial1/4 150
transmitter-delay 10
!
interface Serial3/4
description *** static DCE connection to s1 Aton
encapsulation frame-relay
no ip mroute-cache
clockrate 2000000
frame-relay intf-type dce
frame-relay route 160 interface Serial1/5 130
!

```

show Commands

Use the following show commands to test that your network is operating properly:

- **show frame-relay map**
- **show frame-relay pvc**

The output shown below is a result of entering these commands on the devices we are using in this sample configuration.

Spicey

```

Spicey#show frame-relay map
Serial0 (up): ip 3.1.3.2 dlci 140(0x8C,0x20C0), dynamic,
             broadcast,, status defined, active
Serial0 (up): ip 3.1.3.3 dlci 130(0x82,0x2020), dynamic,
             broadcast,, status defined, active

```

```

Spicey#show frame-relay pvc

```

```

PVC Statistics for interface Serial0 (Frame Relay DTE)

```

	Active	Inactive	Deleted	Static
Local	2	0	0	0
Switched	0	0	0	0
Unused	0	0	0	0

```

DLCI = 130, DLCI USAGE = LOCAL, PVC STATUS = ACTIVE, INTERFACE = Serial0

```

input pkts 32	output pkts 40	in bytes 3370
out bytes 3928	dropped pkts 0	in FECN pkts 0
in BECN pkts 0	out FECN pkts 0	out BECN pkts 0
in DE pkts 0	out DE pkts 0	

```
out bcst pkts 30                out bcst bytes 2888
pvc create time 00:15:46, last time pvc status changed 00:10:42
```

```
DLCI = 140, DLCI USAGE = LOCAL, PVC STATUS = ACTIVE, INTERFACE = Serial0
```

```
input pkts 282                output pkts 291                in bytes 25070
out bytes 27876              dropped pkts 0                in FECN pkts 0
in BECN pkts 0              out FECN pkts 0              out BECN pkts 0
in DE pkts 0                out DE pkts 0
out bcst pkts 223           out bcst bytes 20884
pvc create time 02:28:36, last time pvc status changed 02:25:14
```

Prasit

```
Prasit#show frame-relay map
Serial1 (up): ip 3.1.3.1 dlci 150(0x96,0x2460), dynamic,
              broadcast,, status defined, active
```

```
Prasit#show frame-relay pvc
```

```
PVC Statistics for interface Serial1 (Frame Relay DTE)
```

	Active	Inactive	Deleted	Static
Local	1	0	0	0
Switched	0	0	0	0
Unused	0	0	0	

```
DLCI = 150, DLCI USAGE = LOCAL, PVC STATUS = ACTIVE, INTERFACE = Serial1
input pkts 311                output pkts 233                in bytes 28562
out bytes 22648              dropped pkts 0                in FECN pkts 0
in BECN pkts 0              out FECN pkts 0              out BECN pkts 0
in DE pkts 0                out DE pkts 0
out bcst pkts 162           out bcst bytes 15748
pvc create time 02:31:39, last time pvc status changed 02:25:14
```

Aton

```
Aton#show frame-relay map
Serial1 (up): ip 3.1.3.1 dlci 160(0xA0,0x2800), dynamic, broadcast, status defined, active
```

```
Aton#show frame-relay pvc
```

```
PVC Statistics for interface Serial1 (Frame Relay DTE)
```

	Active	Inactive	Deleted	Static
Local	1	0	0	0
Switched	0	0	0	0
Unused	0	0	0	0

```
DLCI = 160, DLCI USAGE = LOCAL, PVC STATUS = ACTIVE, INTERFACE = Serial
input pkts 35                output pkts 32                in bytes 3758
out bytes 3366              dropped pkts 0                in FECN pkt 0
in BECN pkts 0              out FECN pkts 0              out BECN pkts 0
in DE pkts 0                out DE pkts 0
out bcst pkts 27 out bcst bytes 2846
pvc create time 00:10:53, last time pvc status changed 00:10:53
```

Configuring Frame Relay DLCI Prioritization

Data-link connection identifier (DLCI) prioritization is the process whereby different traffic types are placed upon separate DLCIs so that a Frame Relay network can provide a different committed information rate for each traffic type. It can be used in conjunction with either custom queuing or priority queuing to provide bandwidth management control over the access link to the Frame Relay network. In addition, some Frame Relay service providers and Frame Relay switches (such as the Stratacom Internetwork Packet Exchange [IPX], IGX and BPX or AXIS switches) actually provide prioritization within the Frame Relay cloud based on this priority setting.

Implementation Considerations

When implementing DLCI prioritization, please note the following points:

- If a secondary DLCI goes down, you lose traffic destined for that queue only.
- If you lose the primary DLCI, the subinterface goes down and you lose all traffic.

Network Diagram

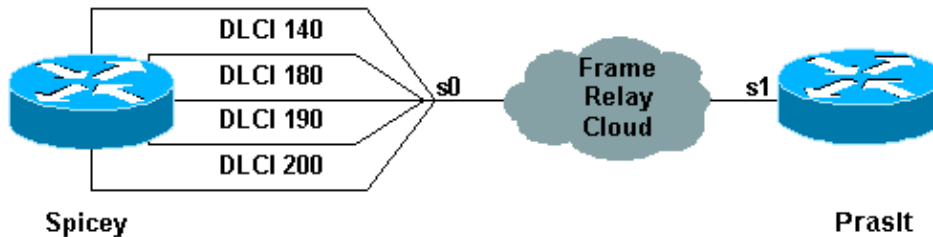

In order to use this setup, you need to have four DLCIs for the side that will use the DLCI prioritization. In this example, we have configured Spicey for priority queuing as follows:

- Ping is in the high-priority queue.
- Telnet is in the medium-priority queue.
- File Transfer Protocol (FTP) is in the normal-priority queue.
- All other IP traffic is in the low-priority queue.

Note: Make sure you configure the DLCIs to correspond with the priority list, or the system will not use the correct queue.

Configurations

- Spicey
- Prasit

```
Spicey
Spicey#show running-config
Building configuration...

Current configuration : 1955 bytes
!
version 12.1
service timestamps debug datetime msec
service timestamps log datetime msec
!
hostname Spicey
!
!
interface Ethernet0
 ip address 124.124.124.1 255.255.255.0
!
interface Serial0
 no ip address
 encapsulation frame-relay
 priority-group 1
!
interface Serial0.1 point-to-point
 ip address 4.0.1.1 255.255.255.0
```

```

frame-relay priority-dlci-group 1 140 180 190 200
frame-relay interface-dlci 140
!
router igrp 2
 network 4.0.0.0
 network 124.0.0.0
!
access-list 102 permit icmp any any
priority-list 1 protocol ip high list 102
priority-list 1 protocol ip medium tcp telnet
priority-list 1 protocol ip normal tcp ftp
priority-list 1 protocol ip low
!
line con 0
 exec-timeout 0 0
 transport input none
line aux 0
line vty 0 4
 login
!
end

```

Prasit

```

Prasit#show running-config
Building configuration...

!
version 12.1
service timestamps debug datetime msec
service timestamps log datetime msec
!
hostname Prasit
!
!
!
interface Ethernet0
 ip address 123.123.123.1 255.255.255.0
!
interface Serial1
 ip address 4.0.1.2 255.255.255.0
 encapsulation frame-relay
!
router igrp 2
 network 4.0.0.0
 network 123.0.0.0
!
line con 0
 exec-timeout 0 0
 transport input none
line aux 0
line vty 0 4
 login
!
end

```

debug and show Commands

Use the following **show** and **debug** commands to test that your network is operating properly. Before issuing **debug** commands, please see Important Information on Debug Commands.

- **show frame-relay pvc**
- **show frame-relay map**

- **show queueing priority**
- **debug priority**

The output shown below is a result of entering these commands on the devices we are using in this sample configuration.

Spicey

Spicey#**show frame-relay pvc**

PVC Statistics for interface Serial0 (Frame Relay DTE)

	Active	Inactive	Deleted	Static
Local	4	0	0	0
Switched	0	0	0	0
Unused	0	0	0	0

DLCI = 140, DLCI USAGE = LOCAL, PVC STATUS = ACTIVE, INTERFACE = Serial0.1

```

input pkts 106          output pkts 15          in bytes 6801
out bytes 1560         dropped pkts 0         in FECN pkts 0
in BECN pkts 0        out FECN pkts 0       out BECN pkts 0
in DE pkts 0          out DE pkts 0
out bcast pkts 0      out bcast bytes 0
pvc create time 00:29:22, last time pvc status changed 00:20:37
Priority DLCI Group 1, DLCI 140 (HIGH), DLCI 180 (MEDIUM)
DLCI 190 (NORMAL), DLCI 200 (LOW)

```

DLCI = 180, DLCI USAGE = LOCAL, PVC STATUS = ACTIVE, INTERFACE = Serial0.1

```

input pkts 0           output pkts 51         in bytes 0
out bytes 2434        dropped pkts 0         in FECN pkts 0
in BECN pkts 0       out FECN pkts 0       out BECN pkts 0
in DE pkts 0         out DE pkts 0
out bcast pkts 0     out bcast bytes 0
pvc create time 00:29:23, last time pvc status changed 00:14:48

```

DLCI = 190, DLCI USAGE = LOCAL, PVC STATUS = ACTIVE, INTERFACE = Serial0.1

```

input pkts 0           output pkts 13         in bytes 0
out bytes 3653        dropped pkts 0         in FECN pkts 0
in BECN pkts 0       out FECN pkts 0       out BECN pkts 0
in DE pkts 0         out DE pkts 0
out bcast pkts 13    out bcast bytes 3653
pvc create time 00:29:23, last time pvc status changed 00:14:28

```

DLCI = 200, DLCI USAGE = LOCAL, PVC STATUS = ACTIVE, INTERFACE = Serial0.1

```

input pkts 0           output pkts 42         in bytes 0
out bytes 2554        dropped pkts 0         in FECN pkts 0
in BECN pkts 0       out FECN pkts 0       out BECN pkts 0
in DE pkts 0         out DE pkts 0
out bcast pkts 10    out bcast bytes 500
pvc create time 00:29:24, last time pvc status changed 00:14:09

```

Spicey#**show frame-relay map**

```

Serial0.1 (up): point-to-point dlci, dlci 140(0x8C,0x20C0), broadcast
status defined, active
Priority DLCI Group 1, DLCI 140 (HIGH), DLCI 180 (MEDIUM)
DLCI 190 (NORMAL), DLCI 200 (LOW)

```

Spicey#**show queueing priority**

Current priority queue configuration:

```

List Queue Args
1 high protocol ip list 102

```

```
1      medium protocol ip          tcp port telnet
1      normal protocol ip          tcp port ftp
1      low    protocol ip
```

To verify the priority queue, use the **debug priority** command.

```
Spicey#debug priority
```

```
Priority output queueing debugging is on
```

```
Spicey#ping 123.123.123.1
```

```
Type escape sequence to abort.
```

```
Sending 5, 100-byte ICMP Echos to 123.123.123.1, timeout is 2 seconds:
```

```
!!!!!
```

```
Success rate is 100 percent (5/5), round-trip min/avg/max = 44/45/48 ms
```

```
Spicey#
```

```
*Mar 1 00:32:30.391: PQ: Serial0: ip (s=4.0.1.1, d=123.123.123.1) ->high
*Mar 1 00:32:30.395: PQ: Serial0: ip (s=4.0.1.1, d=123.123.123.1) ->high
*Mar 1 00:32:30.399: PQ: Serial0 output (Pk size/Q 104/0)
*Mar 1 00:32:30.439: PQ: Serial0: ip (s=4.0.1.1, d=123.123.123.1) ->high
*Mar 1 00:32:30.443: PQ: Serial0: ip (s=4.0.1.1, d=123.123.123.1) ->high
*Mar 1 00:32:30.447: PQ: Serial0 output (Pk size/Q 104/0)
*Mar 1 00:32:30.487: PQ: Serial0: ip (s=4.0.1.1, d=123.123.123.1) ->high
*Mar 1 00:32:30.491: PQ: Serial0: ip (s=4.0.1.1, d=123.123.123.1) ->high
*Mar 1 00:32:30.495: PQ: Serial0 output (Pk size/Q 104/0)
*Mar 1 00:32:30.535: PQ: Serial0: ip (s=4.0.1.1, d=123.123.123.1) ->high
*Mar 1 00:32:30.539: PQ: Serial0: ip (s=4.0.1.1, d=123.123.123.1) ->high
*Mar 1 00:32:30.543: PQ: Serial0 output (Pk size/Q 104/0)
*Mar 1 00:32:30.583: PQ: Serial0: ip (s=4.0.1.1, d=123.123.123.1) ->high
*Mar 1 00:32:30.587: PQ: Serial0: ip (s=4.0.1.1, d=123.123.123.1) ->high
*Mar 1 00:32:30.587: PQ: Serial0 output (Pk size/Q 104/0)Spicey#
```

```
Spicey#telnet 123.123.123.1
```

```
Trying 123.123.123.1 ... Open
```

```
User Access Verification
```

```
Password:
```

```
*Mar 1 00:32:59.447: PQ: Serial0: ip (tcp 23) -> medium
*Mar 1 00:32:59.451: PQ: Serial0: ip (tcp 23) -> medium
*Mar 1 00:32:59.451: PQ: Serial0 output (Pk size/Q 48/1)
*Mar 1 00:32:59.475: PQ: Serial0: ip (tcp 23) -> medium
*Mar 1 00:32:59.479: PQ: Serial0: ip (tcp 23) -> medium
*Mar 1 00:32:59.483: PQ: Serial0 output (Pk size/Q 44/1)
*Mar 1 00:32:59.487: PQ: Serial0: ip (tcp 23) -> medium
*Mar 1 00:32:59.487: PQ: Serial0: ip (tcp 23) -> medium
*Mar 1 00:32:59.491: PQ: Serial0 output (Pk size/Q 53/1)
*Mar 1 00:32:59.495: PQ: Serial0: ip (tcp 23) -> medium
*Mar 1 00:32:59.499: PQ: Serial0: ip (tcp 23) -> medium
*Mar 1 00:32:59.499: PQ: Serial0 output (Pk size/Q 44/1)
*Mar 1 00:32:59.511: PQ: Serial0: ip (tcp 23) -> medium
*Mar 1 00:32:59.511: PQ: Serial0: ip (tcp 23) -> medium
*Mar 1 00:32:59.515: PQ: Serial0 output (Pk size/Q 47/1)
*Mar 1 00:32:59.519: PQ: Serial0: ip (tcp 23) -> medium
*Mar 1 00:32:59.519: PQ: Serial0: ip (tcp 23) -> medium
*Mar 1 00:32:59.523: PQ: Serial0 output (Pk size/Q 47/1)
*Mar 1 00:32:59.527: PQ: Serial0: ip (tcp 23) -> medium
*Mar 1 00:32:59.527: PQ: Serial0: ip (tcp 23) -> medium
*Mar 1 00:32:59.531: PQ: Serial0 output (Pk size/Q 53/1)
*Mar 1 00:32:59.539: PQ: Serial0: ip (tcp 23) -> medium
*Mar 1 00:32:59.543: PQ: Serial0: ip (tcp 23) -> medium
*Mar 1 00:32:59.547: PQ: Serial0 output (Pk size/Q 47/1)
*Mar 1 00:32:59.751: PQ: Serial0: ip (tcp 23) -> medium
*Mar 1 00:32:59.755: PQ: Serial0: ip (tcp 23) -> medium
*Mar 1 00:32:59.755: PQ: Serial0 output (Pk size/Q 44/1)
Password:
```

Other IP traffic goes through the low queue.

```
Spicey#
*Mar 1 00:53:57.079: PQ: Serial0 output (Pk size/Q 13/0)
*Mar 1 00:53:58.851: PQ: Serial0: ip -> low
*Mar 1 00:53:58.907: PQ: Serial0: ip -> low
*Mar 1 00:53:58.907: PQ: Serial0 output (Pk size/Q 36/3)
*Mar 1 00:53:59.459: PQ: Serial0: ip -> low
*Mar 1 00:53:59.463: PQ: Serial0: ip -> low
*Mar 1 00:53:59.463: PQ: Serial0 output (Pk size/Q 50/3)
Spicey#
```

Prasit

```
Prasit#show frame-relay pvc
```

```
PVC Statistics for interface Serial11 (Frame Relay DTE)
```

	Active	Inactive	Deleted	Static
Local	1	0	0	0
Switched	0	0	0	0
Unused	0	0	0	0

```
DLCI = 150, DLCI USAGE = LOCAL, PVC STATUS = ACTIVE, INTERFACE = Serial11
```

```
input pkts 134          output pkts 119          in bytes 12029
out bytes 7801          dropped pkts 0           in FECN pkts 0
in BECN pkts 0         out FECN pkts 0         out BECN pkts 0
in DE pkts 0           out DE pkts 0
out bcast pkts 18      out bcast bytes 1260
pvc create time 00:21:15, last time pvc status changed 00:21:15
```

```
Prasit#show frame-relay map
```

```
Serial11 (up): ip 4.0.1.1 dlci 150(0x96,0x2460), dynamic,
              broadcast, status defined, active
```

```
Prasit#ping 124.124.124.1
```

```
Type escape sequence to abort.
```

```
Sending 5, 100-byte ICMP Echos to 124.124.124.1, timeout is 2 seconds:
```

```
!!!!!
```

```
Success rate is 100 percent (5/5), round-trip min/avg/max = 44/45/48
```

```
Here is the debug output shown on Spicey when you use the command above to ping to Spicey :
```

```
Spicey#
```

```
*Mar 1 00:33:26.755: PQ: Serial0 output (Pk size/Q 13/0)
*Mar 1 00:33:28.535: PQ: Serial0: ip (s=124.124.124.1, d=4.0.1.2) ->high
*Mar 1 00:33:28.539: PQ: Serial0: ip (s=124.124.124.1, d=4.0.1.2) ->high
*Mar 1 00:33:28.543: PQ: Serial0 output (Pk size/Q 104/0)
*Mar 1 00:33:28.583: PQ: Serial0: ip (s=124.124.124.1, d=4.0.1.2) ->high
*Mar 1 00:33:28.587: PQ: Serial0: ip (s=124.124.124.1, d=4.0.1.2) ->high
*Mar 1 00:33:28.587: PQ: Serial0 output (Pk size/Q 104/0)
*Mar 1 00:33:28.631: PQ: Serial0: ip (s=124.124.124.1, d=4.0.1.2) ->high
*Mar 1 00:33:28.635: PQ: Serial0: ip (s=124.124.124.1, d=4.0.1.2) ->high
*Mar 1 00:33:28.635: PQ: Serial0 output (Pk size/Q 104/0)
*Mar 1 00:33:28.679: PQ: Serial0: ip (s=124.124.124.1, d=4.0.1.2) ->high
*Mar 1 00:33:28.683: PQ: Serial0: ip (s=124.124.124.1, d=4.0.1.2) ->high
*Mar 1 00:33:28.683: PQ: Serial0 output (Pk size/Q 104/0)
*Mar 1 00:33:28.723: PQ: Serial0: ip (s=124.124.124.1, d=4.0.1.2) ->high
*Mar 1 00:33:28.727: PQ: Serial0: ip (s=124.124.124.1, d=4.0.1.2) ->high
*Mar 1 00:33:28.731: PQ: Serial0 output (Pk size/Q 104/0)
```

```
Prasit#telnet 124.124.124.1
```

```
Trying 124.124.124.1 ... Open
```

```
User Access Verification
Password:
Spicey>exit
```

```
[Connection to 124.124.124.1 closed by foreign host]
Prasit#
```

Here is the debug output shown on Spicey when you use the command above to **telnet** to Spicey from Prasit.

```
Spicey#
*Mar 1 00:33:54.499: PQ: Serial0: ip (tcp 23) -> medium
*Mar 1 00:33:54.499: PQ: Serial0: ip (tcp 23) -> medium
*Mar 1 00:33:54.503: PQ: Serial0 output (Pk size/Q 48/1)
*Mar 1 00:33:54.527: PQ: Serial0: ip (tcp 23) -> medium
*Mar 1 00:33:54.531: PQ: Serial0: ip (tcp 23) -> medium
*Mar 1 00:33:54.531: PQ: Serial0 output (Pk size/Q 56/1)
*Mar 1 00:33:54.547: PQ: Serial0: ip (tcp 23) -> medium
*Mar 1 00:33:54.551: PQ: Serial0: ip (tcp 23) -> medium
*Mar 1 00:33:54.555: PQ: Serial0 output (Pk size/Q 86/1)
*Mar 1 00:33:54.559: PQ: Serial0: ip (tcp 23) -> medium
*Mar 1 00:33:54.563: PQ: Serial0: ip (tcp 23) -> medium
*Mar 1 00:33:54.563: PQ: Serial0 output (Pk size/Q 47/1)
*Mar 1 00:33:54.571: PQ: Serial0: ip (tcp 23) -> medium
*Mar 1 00:33:54.575: PQ: Serial0: ip (tcp 23) -> medium
*Mar 1 00:33:54.575: PQ: Serial0 output (Pk size/Q 47/1)
*Mar 1 00:33:54.779: PQ: Serial0: ip (tcp 23) -> medium
*Mar 1 00:33:54.783: PQ: Serial0: ip (tcp 23) -> medium
*Mar 1 00:33:54.783: PQ: Serial0 output (Pk size/Q 44/1)
*Mar 1 00:33:56.755: PQ: Serial0 output (Pk size/Q 13/0)
*Mar 1 00:33:57.143: PQ: Serial0: ip (tcp 23) -> medium
*Mar 1 00:33:57.143: PQ: Serial0: ip (tcp 23) -> medium
*Mar 1 00:33:57.147: PQ: Serial0 output (Pk size/Q 44/1)
*Mar 1 00:33:57.447: PQ: Serial0: ip (tcp 23) -> medium
*Mar 1 00:33:57.447: PQ: Serial0: ip (tcp 23) -> medium
*Mar 1 00:33:57.451: PQ: Serial0 output (Pk size/Q 44/1)
*Mar 1 00:33:57.899: PQ: Serial0: ip (tcp 23) -> medium
*Mar 1 00:33:57.899: PQ: Serial0: ip (tcp 23) -> medium
*Mar 1 00:33:57.903: PQ: Serial0 output (Pk size/Q 53/1)
*Mar 1 00:33:59.491: PQ: Serial0: ip (tcp 23) -> medium
*Mar 1 00:33:59.495: PQ: Serial0: ip (tcp 23) -> medium
*Mar 1 00:33:59.495: PQ: Serial0 output (Pk size/Q 45/1)
*Mar 1 00:33:59.711: PQ: Serial0: ip (tcp 23) -> medium
*Mar 1 00:33:59.715: PQ: Serial0: ip (tcp 23) -> medium
*Mar 1 00:33:59.715: PQ: Serial0 output (Pk size/Q 45/1)
*Mar 1 00:33:59.951: PQ: Serial0: ip (tcp 23) -> medium
*Mar 1 00:33:59.951: PQ: Serial0: ip (tcp 23) -> medium
*Mar 1 00:33:59.955: PQ: Serial0 output (Pk size/Q 45/1)
*Mar 1 00:34:00.123: PQ: Serial0: ip (tcp 23) -> medium
*Mar 1 00:34:00.123: PQ: Serial0: ip (tcp 23) -> medium
*Mar 1 00:34:00.127: PQ: Serial0 output (Pk size/Q 45/1)
*Mar 1 00:34:00.327: PQ: Serial0: ip (tcp 23) -> medium
*Mar 1 00:34:00.327: PQ: Serial0: ip (tcp 23) -> medium
*Mar 1 00:34:00.331: PQ: Serial0 output (Pk size/Q 46/1)
*Mar 1 00:34:00.495: PQ: Serial0: ip (tcp 23) -> medium
*Mar 1 00:34:00.499: PQ: Serial0: ip (tcp 23) -> medium
*Mar 1 00:34:00.499: PQ: Serial0 output (Pk size/Q 44/1)
*Mar 1 00:34:00.543: PQ: Serial0: ip (tcp 23) -> medium
*Mar 1 00:34:00.543: PQ: Serial0: ip (tcp 23) -> medium
*Mar 1 00:34:00.547: PQ: Serial0 output (Pk size/Q 44/1)
```

Frame Relay Broadcast Queue

Broadcast queue is a major feature that is used in medium to large IP or IPX networks where routing and service access point (SAP) broadcasts must flow across the Frame Relay network. The broadcast queue is

managed independently of the normal interface queue, has its own buffers, and has a configurable size and service rate. This broadcast queue is not used for bridging spanning-tree updates (BPDUs) because of timing sensitivities. These packets will flow through the normal queues. The interface command to enable broadcast queue follows:

frame-relay broadcast-queue size byte-rate packet-rate

A broadcast queue is given a maximum transmission rate (throughput) limit measured in bytes per second and packets per second. The queue is serviced to ensure that only this maximum is provided. The broadcast queue has priority when transmitting at a rate below the configured maximum, and hence has a guaranteed minimum bandwidth allocation. The two transmission rate limits are intended to avoid flooding the interface with broadcasts. The actual limit in any second is the first rate limit that is reached. Given the transmission rate restriction, additional buffering is required to store broadcast packets. The broadcast queue is configurable to store large numbers of broadcast packets. The queue size should be set to avoid loss of broadcast routing update packets. The exact size depends on the protocol being used and the number of packets required for each update. To be safe, the queue size should be set so that one complete routing update from each protocol and for each data-link connection identifier (DLCI) can be stored. As a general rule, start with 20 packets per DLCI. The byte rate should be less than both of the following:

- $N/4$ times the minimum remote access rate (measured in bytes per second), where N is the number of DLCIs to which the broadcast must be replicated
- $1/4$ the local access rate (measured in bytes per second)

The packet rate is not critical if the byte rate is set conservatively. In general, the packet rate should be set assuming 250-byte packets. The defaults for the serial interfaces are 64 queue size, 256,000 bytes per second (2,048,000 bps), and 36 pps. The defaults for the High Speed Serial Interfaces (HSSI) are 256 queue size, 1,024,000 bytes per second (8,192,000 bps), and 144 pps.

Traffic Shaping

Traffic shaping uses a rate control mechanism called a token bucket filter. This token bucket filter is set as follows:

excess burst plus committed burst ($B_c + B_e$) = maximum speed for the virtual circuit (VC)

Traffic above the maximum speed is buffered in a traffic shaping queue which is equal to the size of the weighted fair queue (WFQ). The Token Bucket filter does not filter traffic, but controls the rate at which traffic is sent on the outbound interface. For more information on token bucket filters, please see the Policing and Shaping Overview.

This document provides an overview of generic traffic shaping and Frame Relay traffic shaping.

Traffic Shaping Parameters

We can use the following traffic shaping parameters:

- CIR = committed information rate (= mean time)
- EIR = excess information rate
- TB = token bucket (= $B_c + B_e$)
- B_c = committed burst size (= sustained burst size)
- B_e = excess burst size
- DE = discard eligibility
- T_c = measurement interval

- AR = access rate corresponding to the rate of the physical interface (so if you use a T1, the AR is approximately 1.5 Mbps).

Let's look at some of these parameters in more detail:

Access Rate (AR)

The maximum number of bits per second that an end station can transmit into the network is bounded by the access rate of the user–network interface. The line speed of the user network connection limits the access rate. You can establish this in your subscription to the service provider.

Committed Burst Size (Bc)

The maximum committed amount of data you can offer to the network is defined as Bc. Bc is a measure for the volume of data for which the network guarantees message delivery under normal conditions. It is measured during the committed rate Tc.

Excess Burst Size (Be)

The number of non–committed bits (outside of CIR) that are still accepted by the Frame Relay switch but are marked as eligible to be discarded (DE).

The token bucket is a 'virtual' buffer. It contains a number of tokens, enabling you to send a limited amount of data per time interval. The token bucket is filled with Bc bits per Tc. The maximum size of the bucket is Bc + Be. If the Be is very big and, if at T0 the bucket is filled with Bc + Be tokens, you can send Bc + Be bits at the access rate. This is not limited by Tc but by the time it takes to send the Be. This is a function of the access rate.

Committed Information Rate (CIR)

The CIR is the allowed amount of data which the network is committed to transfer under normal conditions. The rate is averaged over a increment of time Tc. The CIR is also referred to as the minimum acceptable throughput. Bc and Be are expressed in bits, Tc in seconds, and the access rate and CIR in bits per second.

Bc, Be, Tc and CIR are defined per data–link connection identifier (DLCI). Due to this, the token bucket filter controls the rate per DLCI. The access rate is valid per user–network interface. For Bc, Be and CIR incoming and outgoing values can be distinguished. If the connection is symmetrical, the values in both directions are the same. For permanent virtual circuits, we define incoming and outgoing Bc, Be and CIR at subscription time.

- Peak = DLCI's maximum speed. The bandwidth for that particular DLCI.
- $Tc = Bc / CIR$
- Peak = $CIR + Be/Tc = CIR (1 + Be/Bc)$

If the Tc is one second then:

- Peak = $CIR + Be = Bc + Be$
- EIR = Be

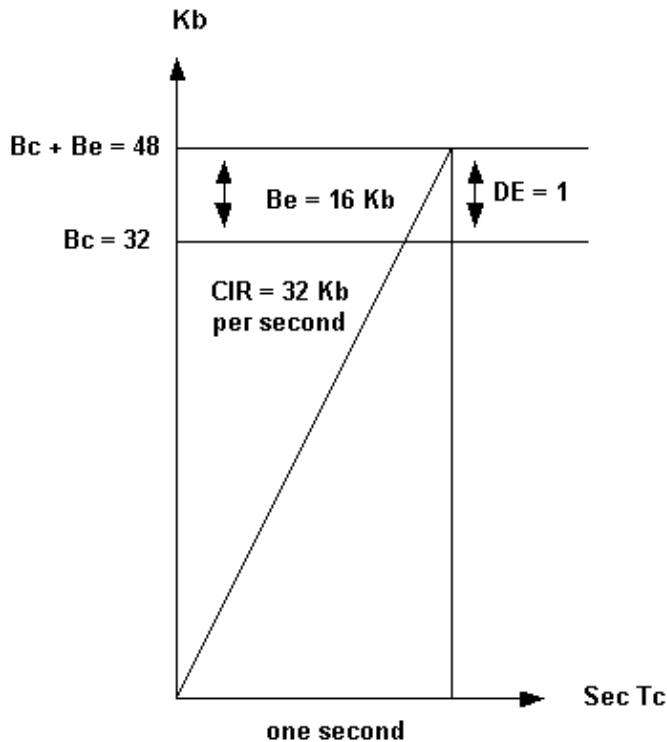

In the example we are using here, the router sends traffic between 48 Kbps and 32 Kbps depending on congestion in the network. Networks may mark frames above B_c with DE but have plenty of spare capacity to transport the frame. The reverse is also possible: they can have limited capacity, yet discard excessive frames immediately. Networks may mark frames above $B_c + B_e$ with DE, and possibly transport it, or just drop the frames as suggested by the International Telecommunication Union Telecommunication Standardization Sector specification ITU-T I.370. Traffic shaping throttles the traffic based on backward-explicit congestion notification (BECN) tagged packets from the switch network. If you receive 50 percent BECN, the router decreases the traffic by one eighth of the current transmitted bandwidth for that particular DLCI.

Example

The transmitted speed is 42 Kb. The router decreases the speed to 42 minus 42 divided by 8 ($42 - 42/8$), making 36.75 Kb. If the congestion decreases after the change, the router reduces the traffic further, dropping to one eighth of current transmitted bandwidth. The traffic is reduced until it reaches the configured CIR value. However, the speed can drop under the CIR when we can still see BECNs. You can specify a bottom limit, such as $CIR/2$. The network is no longer congested when all frames received from the network no longer have a BECN bit for a given time interval. 200 ms is the default value for this interval.

Generic Traffic Shaping

The Generic traffic shaping feature is a media and encapsulation-independent traffic shaping tool that helps reduce the flow of outbound traffic when there is congestion within the cloud, on the link, or at the receiving endpoint router. We can set it on interfaces or subinterfaces within a router.

Generic traffic shaping is useful in the following situations:

- When you have a network topology that consists of a high-speed (T1 line speed) connection at the central site and low speed (less than 56 kbps) connections at the branch or telecommuter sites. Because of the speed mismatch, a bottleneck often exists for traffic on the branch or telecommuter sites when the central site sends data at a faster rate that the remote sites can receive. This results in a

bottleneck in the last switch before the remote-point router.

- If you are a service provider that offers sub-rate services, this feature enables you to use the router to partition your T1 or T3 links, for example, into smaller channels. You can configure each subinterface with a token filter bucket that matches the service ordered by a customer.

On your Frame Relay connection, you may want the router to throttle traffic instead of sending it into the network. Throttling the traffic would limit packet loss in the service provider's cloud. The BECN-based throttling capability provided with this feature allows you to have the router dynamically throttle traffic based on receiving BECN tagged packets from the network. This throttling holds packets in the router's buffers to reduce the data flow from the router into the Frame Relay network. The router throttles traffic on a subinterface basis, and the rate is also increased when fewer BECN-tagged packets are received.

Commands for Generic Traffic Shaping

To define rate control, use this command:

```
traffic-shape rate bit-rate [burst-size [excess-burst-size]] [group access-list]
```

To throttle BECNs on a Frame Relay interface use this command:

```
traffic-shape adaptive [bit-rate]
```

To configure a Frame Relay subinterface to estimate the available bandwidth when it receives BECNs, use the **traffic-shape adaptive** command.

Note: You must enable traffic shaping on the interface with the **traffic-shape rate** command before you can use the **traffic-shape adaptive** command.

The bit rate specified for the **traffic-shape rate** command is the upper limit, and the bit rate specified for the **traffic-shape adaptive** command is the lower limit (usually the CIR value) at which traffic is shaped when the interface receives BECNs. The rate actually used is normally between these two rates. You should configure the **traffic-shape adaptive** command at both ends of the link, as it also configures the device at the flow end to reflect forward explicit congestion notification (FECN) signals as BECNs. This enables the router at the high-speed end to detect and adapt to congestion even when traffic is flowing primarily in one direction.

Example

The following example configures traffic shaping on interface 0.1 with an upper limit (usually Bc + Be) of 128 kbps and a lower limit of 64 kbps. This allows the link to run from 64 to 128 kbps, depending on the congestion level. If the central side has a upper limit of 256 kbps, you should use the lowest upper limit value.

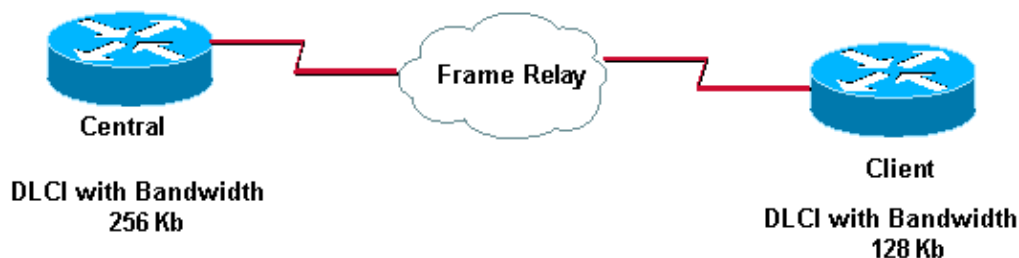

Here's what we have configured on these routers:

```

Central#
interface serial 0
  encapsulation frame-relay
interface serial 0.1
  traffic-shape rate 128000
  traffic-shape adaptive 64000

```

```

Client#
interface serial 0
  encapsulation frame-relay
interface serial 0.1
  traffic-shape rate 128000
  traffic-shape adaptive 64000

```

Frame Relay Traffic Shaping

With generic traffic shaping you can only specify one peak rate (upper limit) per physical interface and one CIR (lower limit) value per subinterface. With Frame Relay traffic shaping, you start a token bucket filter per Virtual Circuit.

The traffic shaping over Frame Relay feature provides the following capabilities:

- Rate enforcement on a per-VC basis: You can configure a peak rate to limit outbound traffic to either the CIR or some other defined value such as the excess information rate (EIR).
- Generalized BECN support on a per-VC basis: The router can monitor BECNs and throttle traffic based on BECN-marked packet feedback from the Frame Relay network.
- Priority queuing (PQ), custom queuing (CQ) or WFQ support at the VC level. This allows for finer granularity in the prioritisation and queuing of traffic, giving you more control over the traffic flow on an individual VC. The traffic shaping over Frame Relay feature applies to Frame Relay permanent virtual circuits (PVCs) and switched virtual circuits (SVCs).

Example

```

Interface Serial 0
no ip address
encapsulation frame-relay
frame-relay traffic-shaping
!
interface Serial0.100
ip address 1.1.1.1 255.255.255.252
frame-relay interface-dlci 100
frame-relay class fast
!
interface Serial0.200
ip address 1.1.1.5 255.255.255.252
frame-relay interface-dlci 200
frame-relay class slow
!
map-class frame-relay slow
frame-relay traffic-rate 64000 128000
!
map-class
frame-relay fast
frame-relay traffic-rate 16000 64000
!

```

In this example the router adds two token-buckets.

- One runs between 64000 (CIR) and 128000(Bc + Be).

- The other runs between 16000 (CIR) and 64000 (Bc + Be).

If incoming traffic from Ethernet is larger than the token bucket filter, the traffic is buffered up in the frame-relay traffic queue.

To view a flow chart showing packet flow when you implement Frame Relay traffic shaping, please see [Frame Relay Traffic Shaping Flowchart](#). To view a flow chart specifically using a token bucket filter, please see [Frame Relay Traffic Shaping – Token Bucket Flowchart](#).

Commonly Used Frame Relay Commands

This section describes two Cisco IOS® commands that are especially useful when configuring Frame Relay.

show frame-relay pvc

This command shows the status of the permanent virtual circuit (PVC), packets in and out, dropped packets if there is congestion on the line via forward explicit congestion notification (FECN) and backward explicit congestion notification (BECN), and so on. For a detailed description of the fields used with the **show frame-relay pvc** command, [click here](#).

If you have the output of a **show frame-relay pvc** command from your Cisco device, you can use Output Interpreter (registered customers only) to display potential issues and fixes.

You can use Output Interpreter (registered customers only) to display potential issues and fixes.

Sample output is shown below:

```
RouterA#show frame-relay pvc
PVC Statistics for interface Serial0 (Frame Relay DTE)
DLCI = 666, DLCI USAGE = UNUSED, PVC STATUS = DELETED, INTERFACE = Serial0
  input pkts 0          output pkts 0          in bytes 0
  out bytes 0          dropped pkts 0        in FECN pkts 0
  in BECN pkts 0      out FECN pkts 0      out BECN pkts 0
  in DE pkts 0         out DE pkts 0
  pvc create time 0:03:18  last time pvc status changed 0:02:27
  Num Pkts Switched 0
DLCI = 980, DLCI USAGE = LOCAL, PVC STATUS = ACTIVE, INTERFACE = Serial0
  input pkts 19         output pkts 87         in bytes 2787
  out bytes 21005      dropped pkts 0         in FECN pkts 0
  in BECN pkts 0      out FECN pkts 0       out BECN pkts 0
  in DE pkts 0         out DE pkts 0
  pvc create time 1:17:47  last time pvc status changed 0:58:27
```

The DLCI USAGE field contains one of the following entries:

- SWITCHED – the router or access server is used as a switch.
- LOCAL – the router or access server is used as data terminal equipment (DTE).
- UNUSED – the data-link connection identifier (DLCI) is not referenced by user-entered configuration commands on the router.

The PVC can have four possible states. These are shown by the PVC STATUS field as follows:

- ACTIVE – PVC is up and functioning normally.
- INACTIVE – PVC is not up end-to-end. This may be because either there is no mapping (or incorrect mapping) for the local DLCI in the frame-relay cloud or the remote end of the PVC is Deleted.

- DELETED – Either the Local Management Interface (LMI) is not exchanged between the router and the local switch, or the switch does not have DLCI configured on the local switch.
- STATIC – no keepalive configured on the frame-relay interface of the router.

show frame-relay map

Use this command to determine if **frame-relay inverse-arp** resolved a remote IP address to a local DLCI. This command is not enabled for point-to-point subinterfaces. It is useful for multipoint interfaces and subinterfaces only. Sample output is shown below:

```
RouterA#show frame-relay map
Serial0 (up): ip 157.147.3.65 dlci 980(0x3D4,0xF440), dynamic,
             broadcast,, status defined, active
```

For a detailed description of the fields used with the **show frame-relay map** command, please see Documentation on **frame relay** Commands.

If you have the output of a **show frame-relay map** command from your Cisco device, you can use Output Interpreter (registered customers only) to display potential issues and fixes.

You can use Output Interpreter (registered customers only) to display potential issues and fixes.

Frame Relay and Bridging

Configuration messages called bridge protocol data units (BPDUs) are used in the spanning-tree protocols supported in Cisco bridges and routers. These flow at regular intervals between bridges and constitute a significant amount of traffic because of their frequent occurrence. There are two types of spanning-tree protocols in transparent bridging. First introduced by the Digital Equipment Corporation (DEC), the algorithm was subsequently revised by the IEEE 802 committee and published in the IEEE 802.1d specification. The DEC Spanning-Tree Protocol issues BPDUs at one-second intervals, while the IEEE issues BPDUs at two-second intervals. Each packet is 41 bytes, which includes a 35-byte configuration BPDU message, a 2-byte Frame Relay header, 2-byte Ethertype, and a 2-byte FCS.

Frame Relay and Memory

Memory consumption for Frame Relay resources occurs in four areas:

1. Each data-link connection identifier (DLCI): 216 bytes
2. Each map statement: 96 bytes (or dynamically built map)
3. Each IDB (hardware interface + encaps Frame Relay): $5040 + 8346 = 13,386$ bytes
4. Each IDB (software subinterface): 2260 bytes

For example, a Cisco 2501 using two Frame Relay interfaces, each with four subinterfaces, with a total of eight DLCIs, and associated maps needs the following:

- 2-interface hardware IDB x 13,386 = 26,772
- 8-subinterface IDB x 2260 = 18,080 subinterfaces
- 8 DLCIs x 216 = 1728 DLCIs
- 8 map statements x 96 = 768 map statements or dynamics

The total is equal to 47,348 bytes of RAM used.

Note: The values used here are valid for Cisco IOS Release 11.1, 12.0 and 12.1 software.

Troubleshooting Frame Relay

This section contains portions of possible **show interface** command output you may encounter while troubleshooting. Explanations of the output are provided as well.

"Serial0 is down, line protocol is down"

This output means you have a problem with the cable, channel service unit/data service unit (CSU/DSU), or the serial line. You need to troubleshoot the problem with a loopback test. To do a loopback test, follow the steps below:

1. Set the serial line encapsulation to HDLC and keepalive to 10 seconds. To do so, issue the commands **encapsulation hdlc** and **keepalive 10** under the serial interface.
2. Place the CSU/DSU or modem in local loop mode. If the line protocol comes up when the CSU, DSU or modem is in local loopback mode (indicated by a "line protocol is up (looped)" message), it suggests that the problem is occurring beyond the local CSU/DSU. If the status line does not change states, there is possibly a problem in the router, connecting cable, CSU/DSU or modem. In most cases, the problem is with the CSU/DSU or modem.
3. Ping your own IP address with the CSU/DSU or modem looped. There should not be any misses. An extended ping of 0x0000 is helpful in resolving line problems since a T1 or E1 derives clock from data and requires a transition every 8 bits. B8ZS ensures that. A heavy zero data pattern helps to determine if the transitions are appropriately forced on the trunk. A heavy ones pattern is used to appropriately simulate a high zero load in case there is a pair of data inverters in the path. The alternating pattern (0x5555) represents a "typical" data pattern. If your pings fail or if you get cyclic redundancy check (CRC) errors, a bit error rate tester (BERT) with an appropriate analyzer from the telco is needed.
4. When you are finished testing, make sure you return the encapsulation to Frame Relay.

"Serial0 is up, line protocol is down"

This line in the output means that the router is getting a carrier signal from the CSU/DSU or modem. Check to make sure the Frame Relay provider has activated their port and that your Local Management Interface (LMI) settings match. Generally, the Frame Relay switch ignores the data terminal equipment (DTE) unless it sees the correct LMI (use Cisco's default to "cisco" LMI). Check to make sure the Cisco router is transmitting data. You will most likely need to check the line integrity using loop tests at various locations beginning with the local CSU and working your way out until you get to the provider's Frame Relay switch. See the previous section for how to perform a loopback test.

"Serial0 is up, line protocol is up"

If you did not turn keepalives off, this line of output means that the router is talking with the Frame Relay provider's switch. You should be seeing a successful exchange of two-way traffic on the serial interface with no CRC errors. Keepalives are necessary in Frame Relay because they are the mechanism that the router uses to "learn" which data-link connection identifiers (DLCIs) the provider has provisioned. To watch the exchange, you can safely use **debug frame-relay lmi** in almost all situations. The **debug frame-relay lmi** command generates very few messages and can provide answers to questions such as:

1. Is the Cisco Router talking to the local Frame Relay switch?
2. Is the router getting full LMI status messages for the subscribed permanent virtual circuits (PVCs) from the Frame Relay provider?
3. Are the DLCIs correct?

Here's some sample **debug frame-relay lmi** output from a successful connection:

```

*Mar 1 01:17:58.763: Serial0(out): StEnq, myseq 92, yourseen 64, DTE up
*Mar 1 01:17:58.763: datagramstart = 0x20007C, datagramsize = 14
*Mar 1 01:17:58.763: FR encap = 0x0001030800 75 95 01 01 01 03 02 5C 40
*Mar 1 01:17:58.767:
*Mar 1 01:17:58.815: Serial0(in): Status, myseq 92
*Mar 1 01:17:58.815: RT IE 1, length 1, type 1
*Mar 1 01:17:58.815: KA IE 3, length 2, yourseq 65, myseq 92
*Mar 1 01:18:08.763: Serial0(out): StEnq, myseq 93, yourseen 65, DTE up
*Mar 1 01:18:08.763: datagramstart = 0x20007C, datagramsize = 14
*Mar 1 01:18:08.763: FR encap = 0x0001030800 75 95 01 01 01 03 02 5D 41
*Mar 1 01:18:08.767:
*Mar 1 01:18:08.815: Serial0(in): Status, myseq 93
*Mar 1 01:18:08.815: RT IE 1, length 1, type 1
*Mar 1 01:18:08.815: KA IE 3, length 2, yourseq 66, myseq 93
*Mar 1 01:18:18.763: Serial0(out): StEnq, myseq 94, yourseen 66, DTE up
*Mar 1 01:18:18.763: datagramstart = 0x20007C, datagramsize = 14
*Mar 1 01:18:18.763: FR encap = 0x0001030800 75 95 01 01 00 03 02 5E 42
*Mar 1 01:18:18.767:
*Mar 1 01:18:18.815: Serial0(in): Status, myseq 94
*Mar 1 01:18:18.815: RT IE 1, length 1, type 0
*Mar 1 01:18:18.819: KA IE 3, length 2, yourseq 67, myseq 94
*Mar 1 01:18:18.819: PVC IE 0x7 , length 0x3 , dlci 980, status 0x2

```

Notice the status of "DLCI 980" in the output above. The possible values of the status field are explained below:

1. **0x0**–Added/inactive means that the switch has this DLCI programmed but for some reason (such as the other end of this PVC is down), it is not usable.
2. **0x2**–Added/active means the Frame Relay switch has the DLCI and everything is operational. You can start sending it traffic with this DLCI in the header.
3. **0x3**–0x3 is a combination of an active status (0x2) and the RNR (or r-bit) that is set (0x1). This means that the switch – or a particular queue on the switch – for this PVC is backed up, and you stop transmitting in case frames are spilled.
4. **0x4**–Deleted means that the Frame Relay switch doesn't have this DLCI programmed for the router. But it was programmed at some point in the past. This could also be caused by the DLCIs being reversed on the router, or by the PVC being deleted by the telco in the Frame Relay cloud. Configuring a DLCI (that the switch doesn't have) will show up as a 0x4.
5. **0x8**–New/inactive
6. **0x0a**–New/active

Frame Relay Characteristics

This section explains several Frame Relay characteristics of which you should be aware.

IP Split Horizon Checking

IP split horizon checking is disabled by default for Frame Relay encapsulation so routing updates will come in and out the same interface. The routers learn the data-link connection identifiers (DLCIs) they need to use from the Frame Relay switch via Local Management Interface (LMI) updates. The routers then use Inverse ARP for the remote IP address and create a mapping of local DLCIs and their associated remote IP addresses. Additionally, certain protocols such as AppleTalk, transparent bridging, and IPX cannot be supported on partially meshed networks because they require "split horizon," in which a packet received on an interface cannot be transmitted out the same interface, even if the packet is received and transmitted on different virtual circuits. Configuring Frame Relay subinterfaces ensures that a single physical interface is treated as multiple virtual interfaces. This capability allows us to overcome split horizon rules. Packets received on one virtual interface can now be forwarded out another virtual interface, even if they are configured on the same physical interface.

Ping Your Own IP Address on a Multipoint Frame Relay

You are not able to ping your own IP address on a multipoint Frame Relay interface. This is because Frame Relay multipoint (sub)interfaces are non-broadcast, (unlike Ethernet and point-to-point interfaces High-Level Data Link Control [HDLC]), and Frame Relay point-to-point sub-interfaces.

Furthermore, you are not able to ping from one spoke to another spoke in a hub and spoke configuration. This is because there is no mapping for your own IP address (and none were learned via Inverse ARP). But if you configure a static map (using the **frame-relay map** command) for your own IP address (or one for the remote spoke) to use the local DLCI, you can then ping your devices.

```
aton#ping 3.1.3.3
Type escape sequence to abort.
Sending 5, 100-byte ICMP Echos to 3.1.3.3, timeout is 2 seconds:
.....
Success rate is 0 percent (0/5)

aton#configure terminal
Enter configuration commands, one per line. End with CNTL/Z.
aton(config)#interface serial 1
aton(config-if)#frame-relay map ip 3.1.3.3 160
aton(config-if)#

aton#show frame-relay map
Serial1 (up): ip 3.1.3.1 dlci 160(0xA0,0x2800), dynamic,
              broadcast,, status defined, active
Serial1 (up): ip 3.1.3.2 dlci 160(0xA0,0x2800), static,
              CISCO, status defined, active
Serial1 (up): ip 3.1.3.3 dlci 160(0xA0,0x2800), static,
              CISCO, status defined, active
aton#ping 3.1.3.3

Type escape sequence to abort.
Sending 5, 100-byte ICMP Echos to 3.1.3.3, timeout is 2 seconds:
!!!!
Success rate is 100 percent (5/5), round-trip min/avg/max = 64/68/76 ms
aton#
aton#show running-config
!
interface Serial1
ip address 3.1.3.3 255.255.255.0
no ip directed-broadcast
encapsulation frame-relay
frame-relay map ip 3.1.3.2 160
frame-relay map ip 3.1.3.3 160
frame-relay interface-dlci 160
!
```

The Keyword broadcast

The **broadcast** keyword provides two functions: it forwards broadcasts when multicasting is not enabled, and it simplifies the configuration of Open Shortest Path First (OSPF) for non-broadcast networks that use Frame Relay.

The **broadcast** keyword might also be required for some routing protocols — for example, AppleTalk — that depend on regular routing table updates, especially when the router at the remote end is waiting for a routing update packet to arrive before adding the route.

By requiring selection of a designated router, OSPF treats a non-broadcast, multi-access network such as Frame Relay in much the same way as it treats a broadcast network. In previous releases, this required manual

assignment in the OSPF configuration using the **neighbor interface router** command. When the **frame-relay map** command is included in the configuration with the **broadcast** keyword, and the **ip ospf network** command (with the **broadcast** keyword) is configured, there is no need to configure any neighbors manually. OSPF now automatically runs over the Frame Relay network as a broadcast network. (See the **ip ospf network interface** command for more detail.)

Note: The OSPF broadcast mechanism assumes that IP class D addresses are never used for regular traffic over Frame Relay.

Example

The following example maps the destination IP address 172.16.123.1 to DLCI 100:

```
interface serial 0
  frame-relay map IP 172.16.123.1 100 broadcast
```

OSPF uses DLCI 100 to broadcast updates.

Reconfiguring a Subinterface

Once you create a specific type of subinterface, you cannot change it without a reload. For example, you cannot create a multipoint subinterface serial0.2, then change it to point-to-point. To change it, you need to either reload the router or create another subinterface. This is the way the Frame Relay code works in Cisco IOS® software.

DLCI Limitations

DLCI Address Space

Approximately 1000 DLCIs can be configured on a single physical link, given a 10-bit address. Because certain DLCIs are reserved (vendor-implementation-dependent), the maximum is about 1000. The range for a Cisco LMI is 16–1007. The stated range for ANSI/ITU is 16–992. These are the DLCIs carrying user-data.

However, when configuring Frame Relay VCs on subinterfaces, you need to consider a practical limit known as the IDB limit. The total number of interfaces and subinterfaces per system is limited by the number of interface descriptor blocks (IDBs) that your version of Cisco IOS supports. An IDB is a portion of memory that holds information about the interface such as counters, status of the interface, and so on. IOS maintains an IDB for each interface present on a platform and maintains an IDB for each subinterface. Higher speed interfaces require more memory than lower speed interfaces. Each platform contains different amounts of maximum IDBs and these limits may change with each Cisco IOS release.

For more information, see [Maximum Number of Interfaces and Subinterfaces for Cisco IOS Software Platforms: IDB Limits](#).

LMI Status Update

The LMI protocol requires that all permanent virtual circuit (PVC) status reports fit into a single packet and generally limits the number of DLCIs to less than 800, depending on the maximum transmission unit (MTU) size.

$$\text{Max DLCIs} \cong \frac{\text{MTU bytes} - 20 \text{ bytes}}{5 \frac{\text{bytes}}{\text{DLCI}}}$$

MTU = 4000 bytes

$$\frac{4000 - 20}{5} \cong 796$$

DLCIs, where 20 = Frame Relay and LMI Header

The default MTU on serial interfaces is 1500 bytes, yielding a maximum of 296 DLCIs per interface. You can increase the MTU to support a larger full status update message from the Frame Relay switch. If the full status update message is larger than the interface MTU, the packet is dropped, and the interface giant counter is incremented. When changing the MTU, ensure the same value is configured at the remote router and intervening network devices.

Please note that these numbers vary slightly, depending on the LMI type. The maximum DLCIs per router (not interface) platform guideline, based on extrapolation from empirical data established on a Cisco 7000 router platform, are listed below:

- Cisco 2500: 1 X T1/E1 link @ 60 DLCIs per interface = 60 total
- Cisco 4000: 1 X T1/E1 link @ 120 DLCIs per interface = 120 total
- Cisco 4500: 3 X T1/E1 links @ 120 DLCIs per interface = 360 total
- Cisco 4700: 4 X T1/E1 links @ 120 DLCIs per interface = 480 total
- Cisco 7000: 4 X T1/E1/T3/E3 links @ 120 DLCIs per interface = 480 total
- Cisco 7200: 5 X T1/E1/T3/E3 links @ 120 DLCIs per interface = 600 total
- Cisco 7500: 6 X T1/E1/T3/E3 links @ 120 DLCIs per interface = 720 total

Note: These numbers are guidelines only, and assume that all traffic is fast-switched.

Other Considerations

A practical DLCI limit also depends on whether the VCs are running a dynamic or static routing protocol. Dynamic routing protocols, and other protocols like IPX SAP that exchange database tables, send hellos and forwarding information messages which must be seen and processed by the CPU. As a general rule, using static routes will allow you to configure a larger number of VCs on a single Frame Relay interface.

IP/IPX/AT Address

If you are using subinterfaces, don't put an IP, IPX or AT address on the main interface. Assign DLCIs to their subinterfaces before you enable the main interface to ensure that **frame-relay inverse-arp** works properly. In case it does malfunction, follow the steps below:

1. Turn off Inverse Address Resolution Protocol (ARP) for that DLCI by using the **no frame-relay inverse-arp ip 16** and the **clear frame-relay-inarp** commands.
2. Fix your configuration.
3. Turn the **frame-relay inverse-arp** command on again.

RIP and IGRP

Routing Information Protocol (RIP) updates flow every 30 seconds. Each RIP packet can contain up to 25 route entries, for a total of 536 bytes; 36 bytes of this total are header information, and each route entry is 20 bytes. Therefore, if you advertise 1000 routes over a Frame Relay link configured for 50 DLCIs, the result is 1 MB of routing update data every 30 seconds, or 285 kbps of bandwidth consumed. On a T1 link, this bandwidth represents 18.7 percent of the bandwidth, with each update duration being 5.6 seconds. This amount of overhead is considerable, and it is borderline acceptable, but the committed information rate (CIR) would have to be in the region of the access speed. Obviously, anything less than a T1 would incur too much overhead. For example:

- $1000/25 = 40$ packets $\times 36 = 1440$ header bytes
- 1000×20 bytes = 20,000 bytes of route entries
- Total 21,440 bytes $\times 50$ DLCIs = 1072 MB of RIP updates every 30 seconds
- $1,072,000$ bytes / 30 sec $\times 8$ bits = 285 kbps

Interior Gateway Routing Protocol (IGRP) updates flow every 90 seconds (this interval is configurable). Each IGRP packet can contain 104 route entries, for a total of 1492 bytes, 38 of which are header information, and each route entry is 14 bytes. If you advertise 1000 routes over a Frame Relay link configured with 50 DLCIs, the request is approximately 720 KB of routing update data every 90 seconds, or 64 kbps of bandwidth consumed. On a T1 link, this bandwidth would represent 4.2 percent of the bandwidth, with each update duration being 3.7 seconds. This overhead is an acceptable amount:

- $1000/104 = 9$ packets $\times 38 = 342$ header bytes
- $1000 \times 14 = 14,000$ bytes of route entries
- Total = 14,342 bytes $\times 50$ DLCIs = 717 KB of IGRP updates every 90 seconds
- $717,000$ bytes / 90 $\times 8$ bits = 63.7 kbps

Routing Table Maintenance Protocol (RTMP) routing updates occur every 10 seconds (this interval is configurable). Each RTMP packet can contain up to 94 extended route entries, for a total of 564 bytes, 23 bytes of header information, and each route entry is 6 bytes. If you advertise 1000 AppleTalk networks over a Frame Relay link configured for 50 DLCIs, the result is approximately 313 KB of RTMP updates every 10 seconds, or 250 kbps of bandwidth consumed. To remain within an acceptable level of overhead (15 percent or less), a T1 rate is required. For example:

- $1000/94 = 11$ packets $\times 23$ bytes = 253 header bytes
- $1000 \times 6 = 6000$ bytes of route entries
- Total = 6253 $\times 50$ DLCIs = 313 KB of RTMP updates every 10 seconds
- $313,000 / 10$ sec $\times 8$ bits = 250 kbps

IPX RIP packet updates occur every 60 seconds (this interval is configurable). Each IPX RIP packet can contain up to 50 route entries for a total of 536 bytes, 38 bytes of header information, and each route entry is 8 bytes. If you advertise 1000 IPX routes over a Frame Relay link configured for 50 DLCIs, the result is 536 KB of IPX updates every 60 seconds, or 58.4 kbps of bandwidth consumed. To remain within an acceptable level of overhead (15 percent or less), a rate of 512 kbps is required. For example:

- $1000/50 = 20$ packets $\times 38$ bytes = 760 bytes of header
- $1000 \times 8 = 8000$ bytes of route entries
- Total = 8760 $\times 50$ DLCIs = 438,000 bytes of IPX updates every 60 seconds
- $438,000 / 60$ sec $\times 8$ bits = 58.4 kbps

IPX service access point (SAP) packet updates occur every 60 seconds (this interval is configurable). Each IPX SAP packet can contain up to seven advertisement entries for a total of 536 bytes, 38 bytes of header information, and each advertisement entry is 64 bytes. If you broadcast 1000 IPX advertisements over a

Frame Relay link configured for 50 DLCIs, you would end up with 536 KB of IPX updates every 60 seconds, or 58.4 kbps of bandwidth consumed. To remain within an acceptable level of overhead (15 percent or less), a rate of greater than 2 Mbps is required. Obviously, SAP filtering is required in this scenario. Compared to all other protocols mentioned in this section, IPX SAP updates require the most bandwidth:

- $1000/7 = 143$ packets X 38 bytes = 5434 bytes of header
- $1000 \times 64 = 64,000$ bytes of route entries
- Total = $69,434 \times 50$ DLCIs = 3,471,700 bytes of IPX service advertisements every 60 seconds
- $3,471,700 / 60 \text{ sec} \times 8 \text{ bits} = 462 \text{ kbps}$

Keepalive

In some cases, the keepalive on the Cisco device needs to be set slightly shorter (about 8 seconds) than the keepalive on the switch. You'll see the need for this if the interface keeps coming up and down.

Serial Interfaces

Serial interfaces, which are by default multipoint, are non-broadcast media, while point-to-point subinterfaces are broadcast. If you are using static routes, you can point to either the next hop or the serial subinterface. For multipoint, you need to point to the next hop. This concept is very important when doing OSPF over Frame Relay. The router needs to know that this is a broadcast interface for OSPF to work.

OSPF and Multipoint

OSPF and multipoint can be very troublesome. OSPF needs a Designated Router (DR). If you start losing PVCs, some routers may lose connectivity and try to become a DR even though other routers still see the old DR. This causes the OSPF process to malfunction.

Overhead associated with OSPF is not as obvious and predictable as that with traditional distance vector routing protocols. The unpredictability comes from whether or not the OSPF network links are stable. If all adjacencies to a Frame Relay router are stable, only neighbor hello packets (keepalives) will flow, which is comparatively much less overhead than that incurred with a distance vector protocol (such as RIP and IGRP). If, however, routes (adjacencies) are unstable, link-state flooding will occur, and bandwidth can quickly be consumed. OSPF also is very processor-intensive when running the Dijkstra algorithm, which is used for computing routes.

In earlier releases of Cisco IOS software, special care had to be taken when configuring OSPF over multiaccess nonbroadcast medias such as Frame Relay, X.25, and ATM. The OSPF protocol considers these media like any other broadcast media such as Ethernet. Nonbroadcast multiaccess (NBMA) clouds are typically built in a hub and spoke topology. PVCs or switched virtual circuits (SVCs) are laid out in a partial mesh and the physical topology does not provide the multiaccess that OSPF believes is there. For the case of point-to-point serial interfaces, OSPF always forms an adjacency between the neighbors. OSPF adjacencies exchange database information. In order to minimize the amount of information exchanged on a particular segment, OSPF elects one router to be a DR, and one router to be a backup designated router (BDR) on each multiaccess segment. The BDR is elected as a backup mechanism in case the DR goes down.

The idea behind this setup is that routers have a central point of contact for information exchange. The selection of the DR became an issue because the DR and BDR needed to have full physical connectivity with all routers that exist on the cloud. Also, because of the lack of broadcast capabilities, the DR and BDR needed to have a static list of all other routers attached to the cloud. This setup is achieved using the **neighbor** command:

neighbor ip-address [priority number] [poll-interval seconds]

In later releases of Cisco IOS software, different methods can be used to avoid the complications of configuring static neighbors and having specific routers becoming DRs or BDRs on the nonbroadcast cloud. Which method to use is influenced by whether the network is new or an existing design that needs modification.

A subinterface is a logical way of defining an interface. The same physical interface can be split into multiple logical interfaces, with each subinterface being defined as point-to-point. This scenario was originally created in order to better handle issues caused by split horizon over NBMA and vector based routing protocols.

A point-to-point subinterface has the properties of any physical point-to-point interface. As far as OSPF is concerned, an adjacency is always formed over a point-to-point subinterface with no DR or BDR election. OSPF considers the cloud a set of point-to-point links rather than one multiaccess network. The only drawback for the point-to-point is that each segment belongs to a different subnet. This scenario might not be acceptable because some administrators have already assigned one IP subnet for the whole cloud. Another workaround is to use IP unnumbered interfaces on the cloud. This scenario also might be a problem for some administrators who manage the WAN based on IP addresses of the serial lines.

Sources

1. International Telegraph and Telephone Consultative Committee, "ISDN Data Link Layer Specification for Frame Mode Bearer Services", CCITT Recommendation Q.922, 19 April 1991.
 2. American National Standard For Telecommunications – Integrated Services Digital Network – Core Aspects of Frame Protocol for Use with Frame Relay Bearer Service, ANSI T1.618–1991, 18 June 1991.
 3. Information technology – Telecommunications and Information Exchange between systems – Protocol Identification in the Network Layer, ISO/IEC TR 9577: 1990 (E) 1990–10–15.
 4. International Standard, Information Processing Systems – Local Area Networks – Logical Link Control, ISO 8802–2: 1989 (E), IEEE Std 802.2–1989, 1989–12–31.
 5. Internetworking Technology Overview, October 1994, Cisco Systems
 6. Finlayson, R., Mann, R., Mogul, J., and M. Theimer, "Reverse Address Resolution Protocol", STD 38, RFC 903, Stanford University, June 1984.
 7. Postel, J. and Reynolds, J., "Standard for the Transmission of IP Datagrams over IEEE 802 Networks", RFC 1042, USC/Information Sciences Institute, February 1988.
 8. RFC 1490–Multiprotocol encapsulation
 9. RFC 1315–Frame Relay MIB
 10. RFC 1293–Frame Relay Inverse ARP
 11. RFC 1144–TCP/IP header compression
 12. Frame Relay Forum (FRF) 1.1–User–Network Interface (UNI)
 13. FRF 2.1–Frame Relay Network–to–Network Interface (NNI)
 14. FRF 3.1–Multiprotocol encapsulation
 15. FRF 4–SVCs
 16. FRF 6–Frame Relay service customer network management (MIB)
 17. Gang of four LMI
 18. Q.922 Annex A
 19. ANSI T1.617 Annex D
 20. ANSI T1.618, T1.606
 21. ITU–T Q.933, Q.922
 22. OSPF Design Guide
 23. Configuration Notes for the Enhanced Implementation of Enhanced IGRP
-

Related Information

- [More Information on Frame Relay Commands](#)
 - [More Information on Configuring Frame Relay](#)
 - [More Information on Dial-Backup Configuration](#)
 - [More Information on Dial-Backup Commands](#)
 - [More Information on ISDN Debug Commands](#)
 - [More Information on PPP Debug Commands](#)
 - [More Information on ISDN Switch Types, Codes and Values](#)
 - [Technical Support & Documentation – Cisco Systems](#)
-

[Contacts & Feedback](#) | [Help](#) | [Site Map](#)

© 2007 – 2008 Cisco Systems, Inc. All rights reserved. [Terms & Conditions](#) | [Privacy Statement](#) | [Cookie Policy](#) | [Trademarks of Cisco Systems, Inc.](#)

Updated: Nov 02, 2005

Document ID: 16563
