



WAAS technology update
CISCO Expo Algeria 2008



Emmanuel Schupp
MEA,
Mgr, Business Development



Session Objectives

- **By this session's end, you should be able to:**
 - Identify Key Business Drivers for WAAS
 - Know the new CISCO WAAS capabilities

The WAN Is A Barrier To Consolidation

- Applications generally perform well in LAN environments as few barriers exist to application performance
 - High bandwidth
 - Low latency
 - Reliability
- WAN characteristics hinder performance and consolidation efforts
 - Already congested
 - Low bandwidth
 - Latency
 - Packet Loss

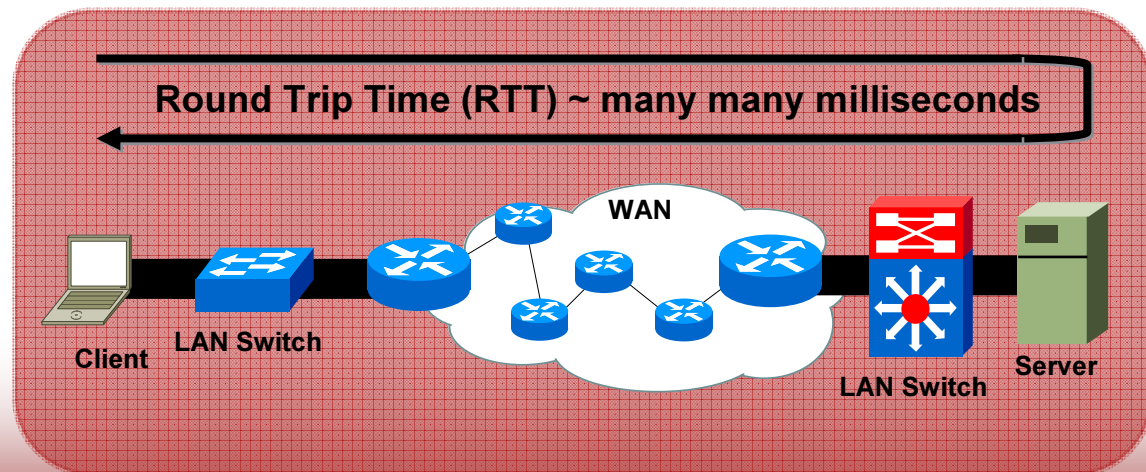
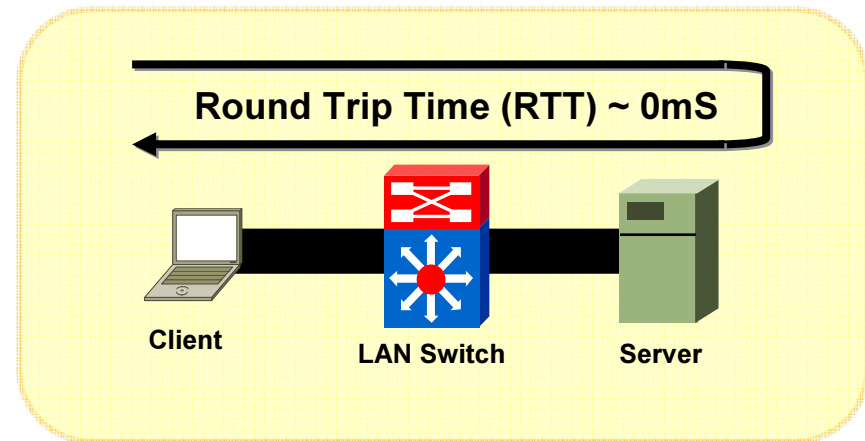

What's WAAS? 'Peer-to-Peer' WAN Optimization

TCP Optimization, Compression & Protocol Acceleration

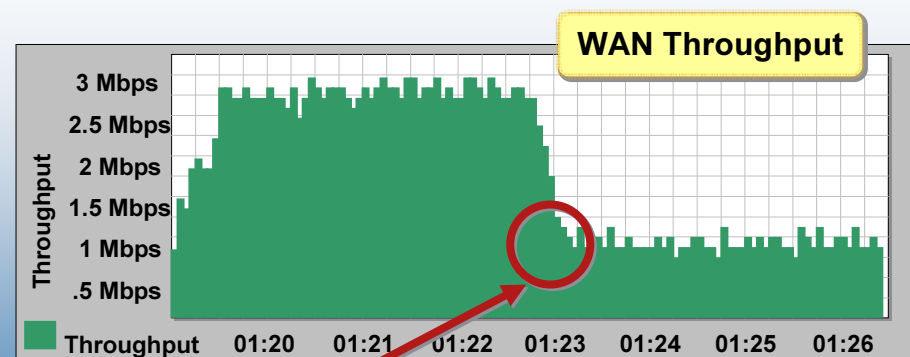
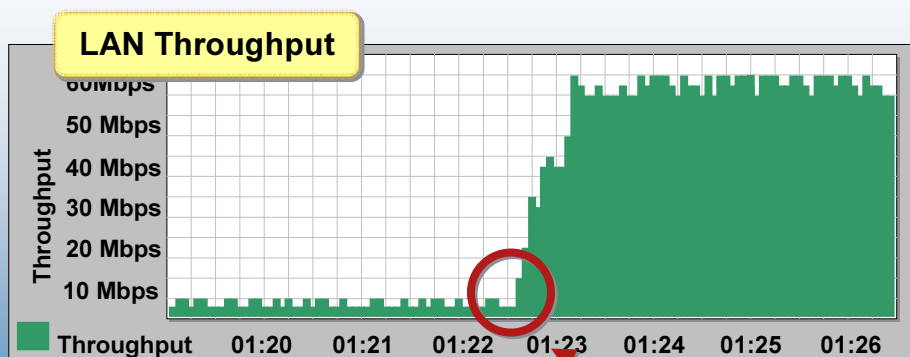
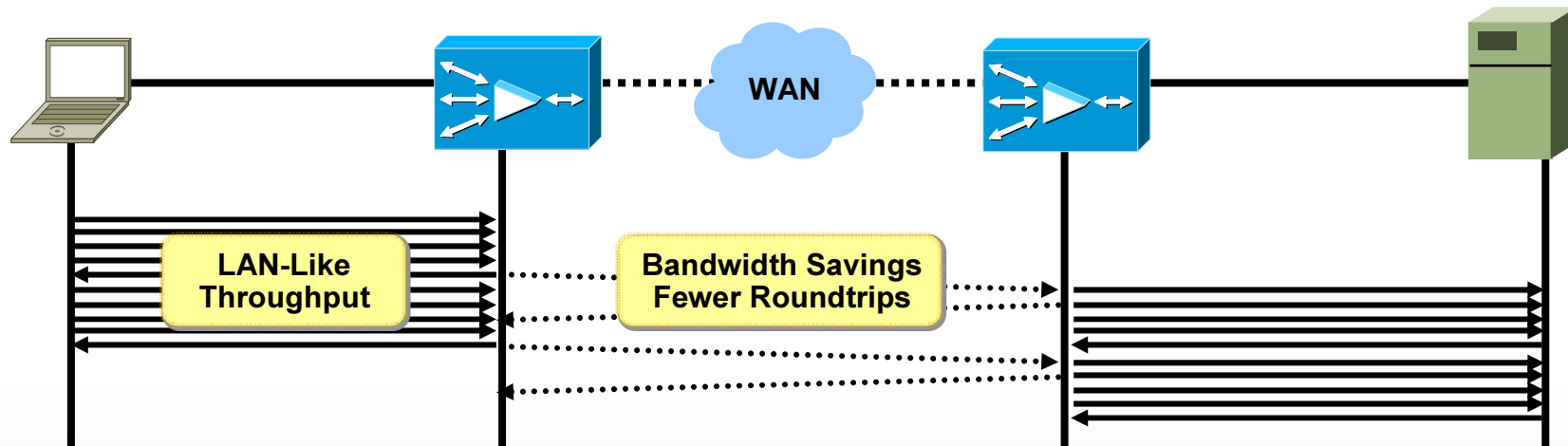

Optimization Enabled

Part of Cisco 'App Delivery Networks'

End-to-End Solution

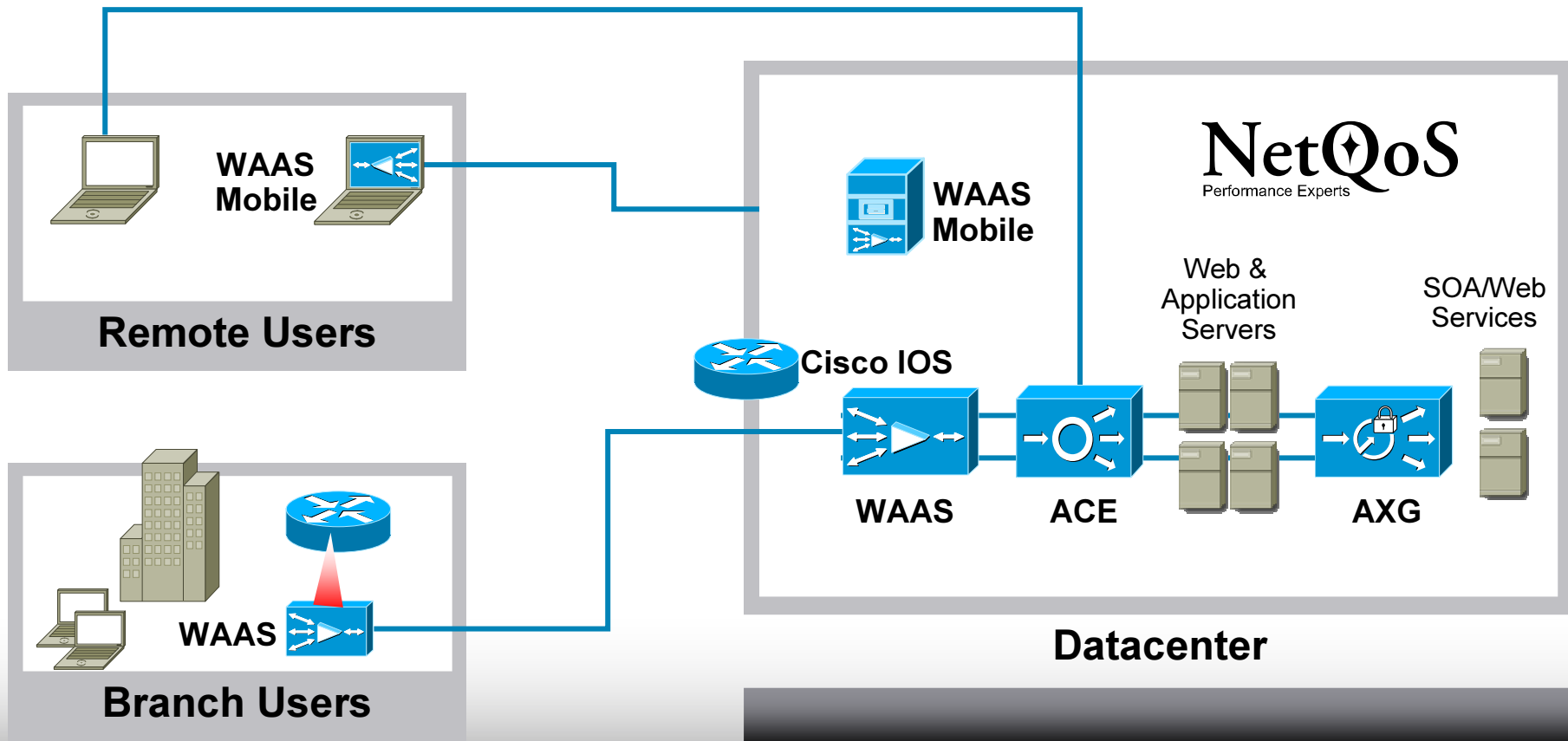

Delivering Value to Customers

Remote Application Performance

- Productivity improvement for business applications (email, office, ERP, CRM)

WAN Optimization

- Defer bandwidth upgrades
- Simplify VOIP deployment on WAN by recovering bandwidth from data apps

Branch Server Consolidation

- 4-6 servers per remote location (file, print, software distribution etc.)
- \$10K+ savings in opex per server

Eliminate RoBO Tape Backup

- Enables regulatory compliance
- Tape backup/restore in the branch is costly and tapes often get lost



3 Month ROI, \$1.3M annual productivity gain

5x improvement in app performance

“Our staff is elated with the 500 percent increase in application acceleration.”

Dave Brady, VP of IT



\$144K/year OpEx Saving. 6X faster medical image transfer

“Cisco WAAS is the most transparent and easiest solution to implement ... as it does not require us to overhaul our security infrastructure.”
Mark Drake, Network Engineer



1.3 Months ROI due to deferred WAN bandwidth upgrade

“We are seeing an average of 60% capacity improvement for our WAN bandwidth.”

Steve Rains, System Director, Information Technology



\$40K/year Savings

60x faster application response time

“WAAS clearly met our needs and is the most cost-effective solution among all alternatives that we evaluated.”

Paul Babcock, Manager of Network & Computer Operations

CISCO WAAS Progress Over Last 6months

- Customer count has increased 50% from 1500 to over 2250
- Unit count has increased 150% from 10,000 to over 25,000
- Already #1 or #2 in major geographies worldwide
- Cisco within a few million dollars of reaching the #1 market share
- Cisco traction acknowledged by the market
 - *With the WAAS Mobile client. again Cisco is showing that it is going to be as nimble as its smaller competitors in this space – IDC*
 - *This (WAAS Mobile) puts Cisco in the mobile client market which is currently a hot new market area for application delivery vendors – Current Analysis*
 - *We believe Cisco is getting traction in the WAN optimization market – Paul Mansky, Citigroup*

Partnerships with Key App Vendors

1. [cisco.com/go/optimizemyapp](http://www.cisco.com/go/optimizemyapp)
2. select “Application Solution Partners” tab
3. click on partner links

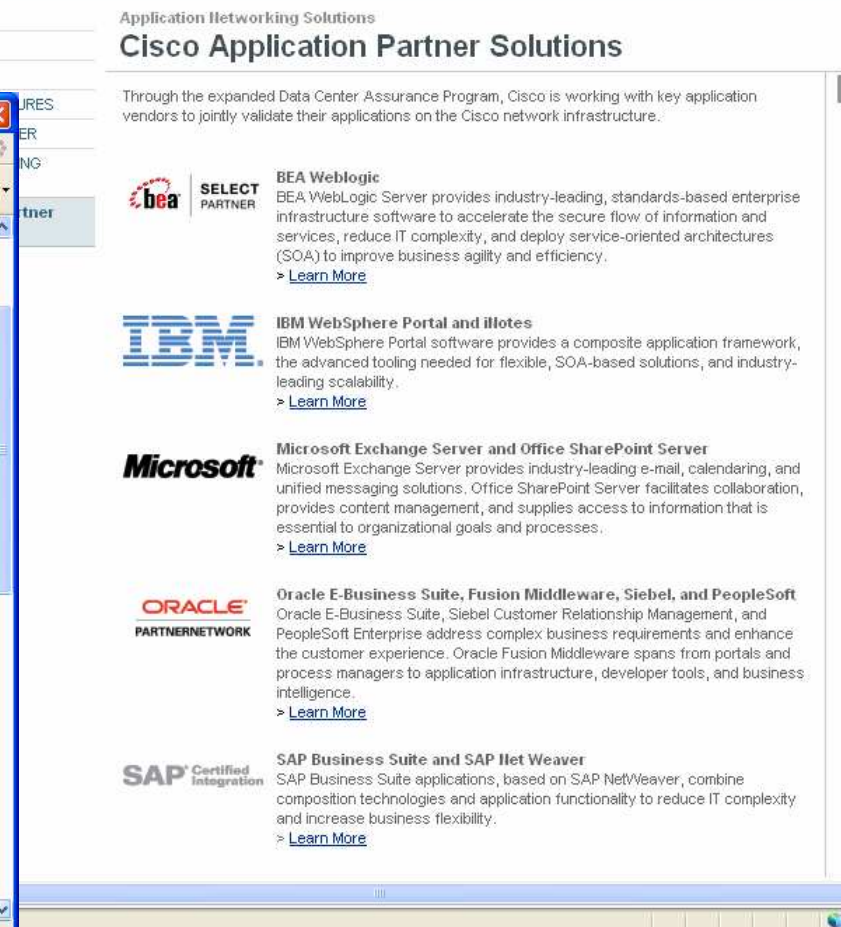
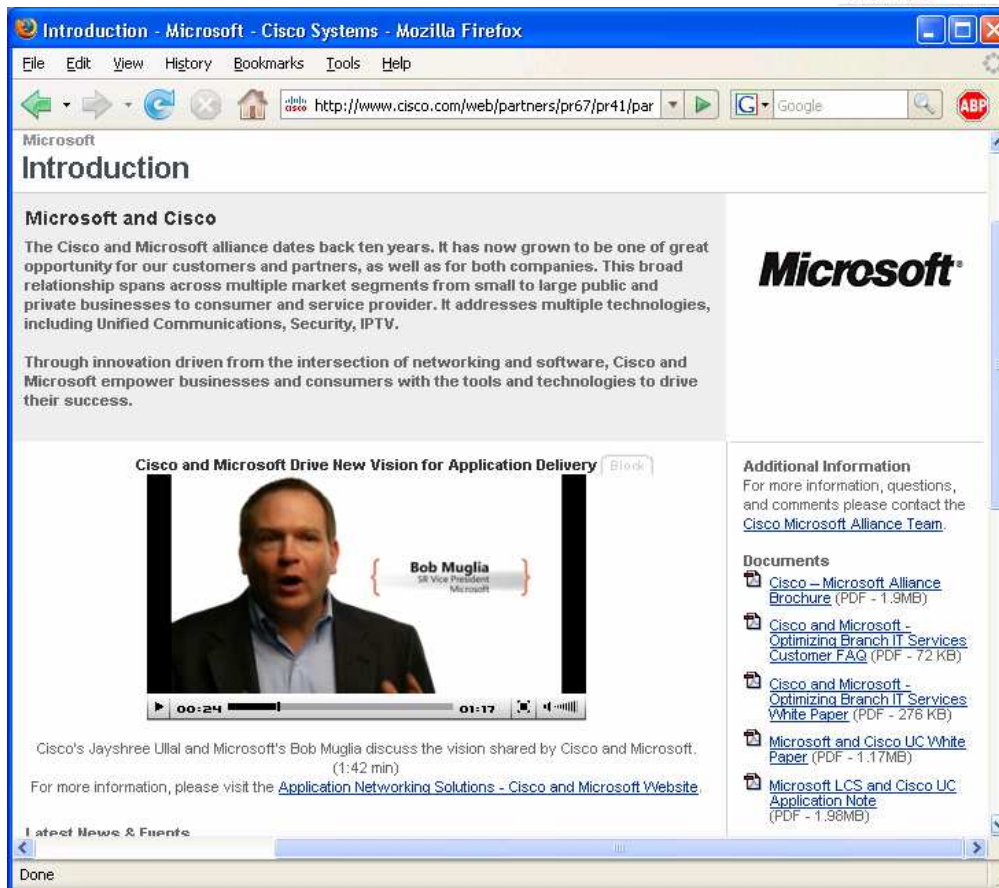

Branch IT Infrastructure: One example

Microsoft and Cisco Approach

Flexible, Optimized Branch IT

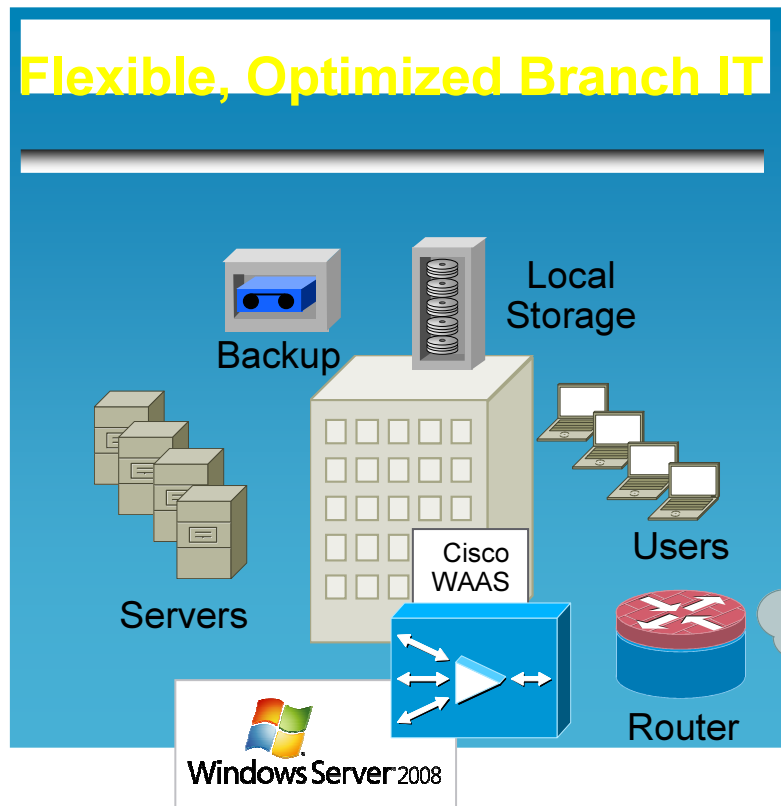

- ✓ Centralize what you can with Cisco WAAS
- ✓ Locally host Windows services on same WAAS device

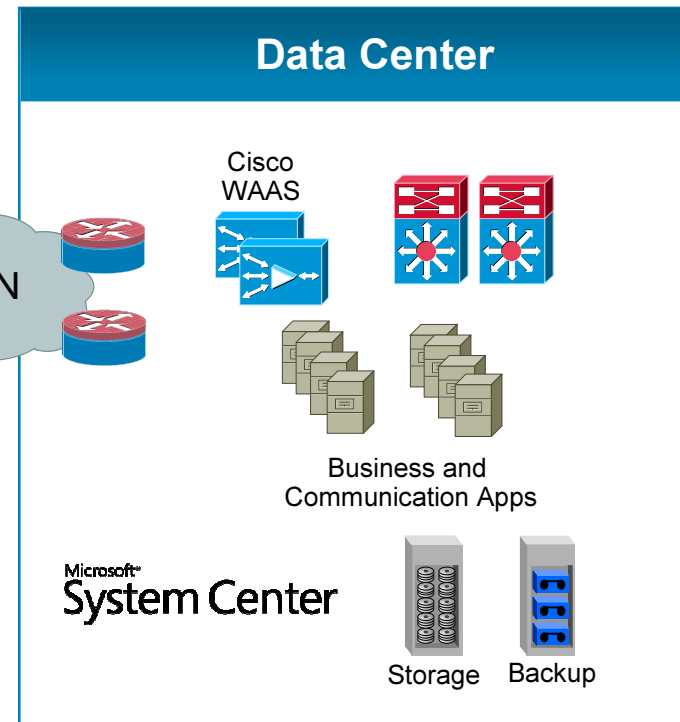

Windows on WAAS: Providing Best Mix of Distributed and Centralized IT Services

WAAS Virtual Blades – How it Works

- WAAS provides virtualized platform for local services
 - Windows Server 2008 Server Core pre-packaged with WAAS
- Key Benefits:
 1. Simple, Low Cost Branch Office
 2. Time to Service/Flexibility
 3. Fast Branch Applications

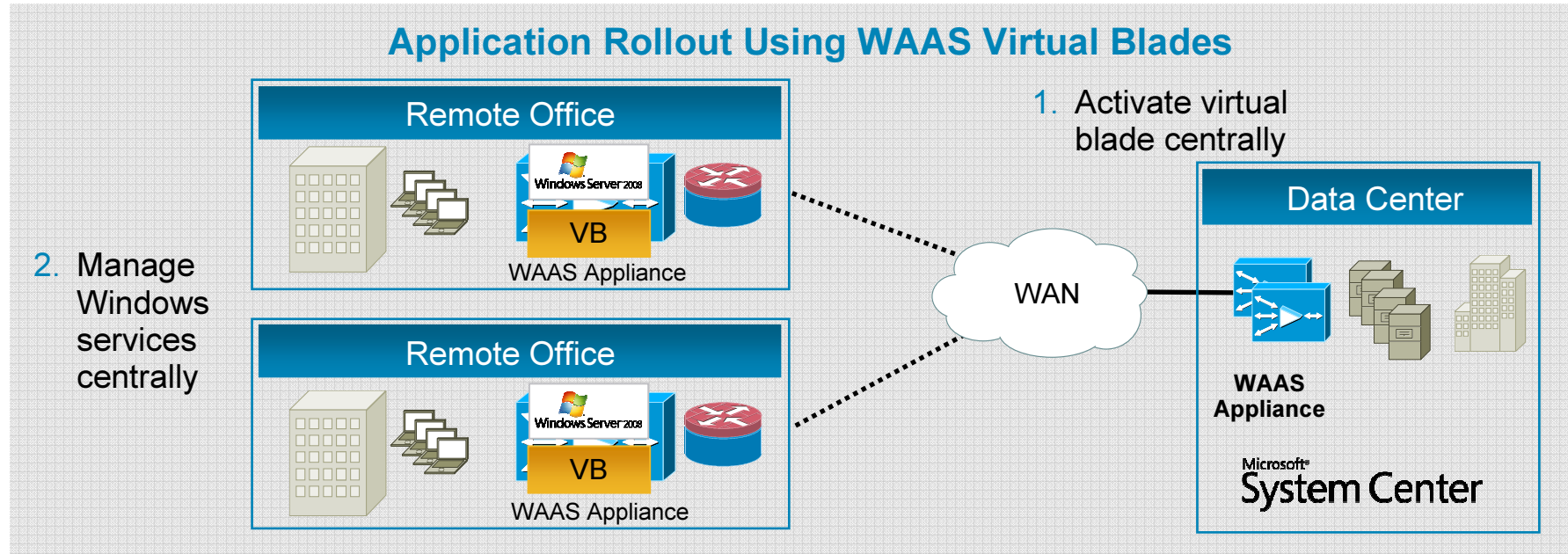

Cisco WAAS Mobile Overview

Available Now !

1. Where It Sits

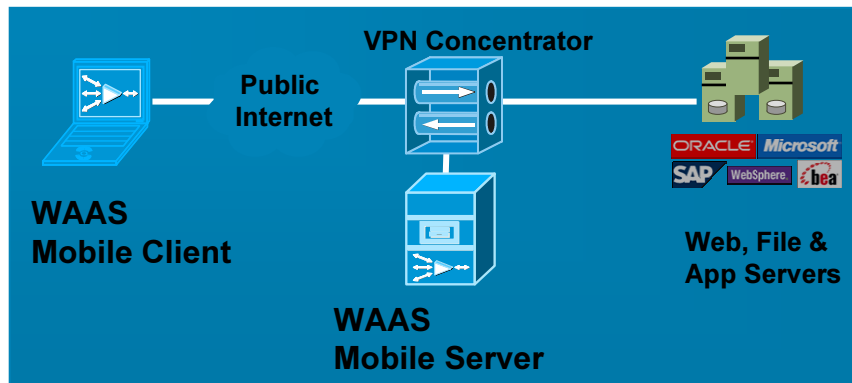

2. What It Does

Installs on Windows Desktop
Accelerates Mobile VPN connections over the Internet

3. Why It's Better

Purpose Built for the Windows PC/Laptop

- Not an appliance software ported to Windows OS
- Similar to Cisco's approach with VPN client
- Results in reliability & stability on the Windows PC

Industry-leading Performance

- Significantly higher throughput
- Better application performance
- Tested under a wide range of links

Lowest TCO

- Best reliability, stability and troubleshooting tools reduce cost of support
- Centralized policy based management reduces deployment and support cost
- Integration with software distribution tools reduces deployment costs

For more details see the [WAAS Mobile Launch Page](#)

New Branch Appliance – WAE-674

Available Now !

- **New branch platform (WAE-674) optimized for Virtual Blades is now shipping !**
 - Virtual Blade Software available in Davis
 - Separate license for Virtual Blades required
 - Services license depends on relationships with app vendor
- **Features**
 - ❖ Support for WAAS + Up to 3 Additional Virtual Blades
 - ❖ SCSI drives with RAID-5 & Hot Swap
 - ❖ Option to add redundant power & cooling
 - ❖ 600GB Usable Disk
 - ❖ Base memory 4 GB, option to upgrade to 8GB of Memory
 - ❖ Hardware Assist for Enterprise Class Virtual Blades
- **WAE-512/612 remain primary for WAN Optimization (WAAS only)**
 - WAE-674 for customers who consolidate Windows & other services
- **WAE-674 will officially be launched at Empowered Branch 4 @ Cisco Partner Summit in April 2008**



WAE-674

Replication Accelerator

Available May'08

- Special device mode for DC-2-DC replication and backup
 - On 4.0.x train - for WAE-7341 & WAE-7371
- Optimized for High Speed Links; Low Connections, Low Fan-out
- EMC SRDF and NetApp SnapMirror testing
 - EMC eLab planned

Case A:

- SRDF using EMC Symmetrix Native IP
- Cisco testing in May'08

Case B:

- SRDF using EMC Symmetrix FC → MDS FCIP
- Validation targeted for 2H CY2008

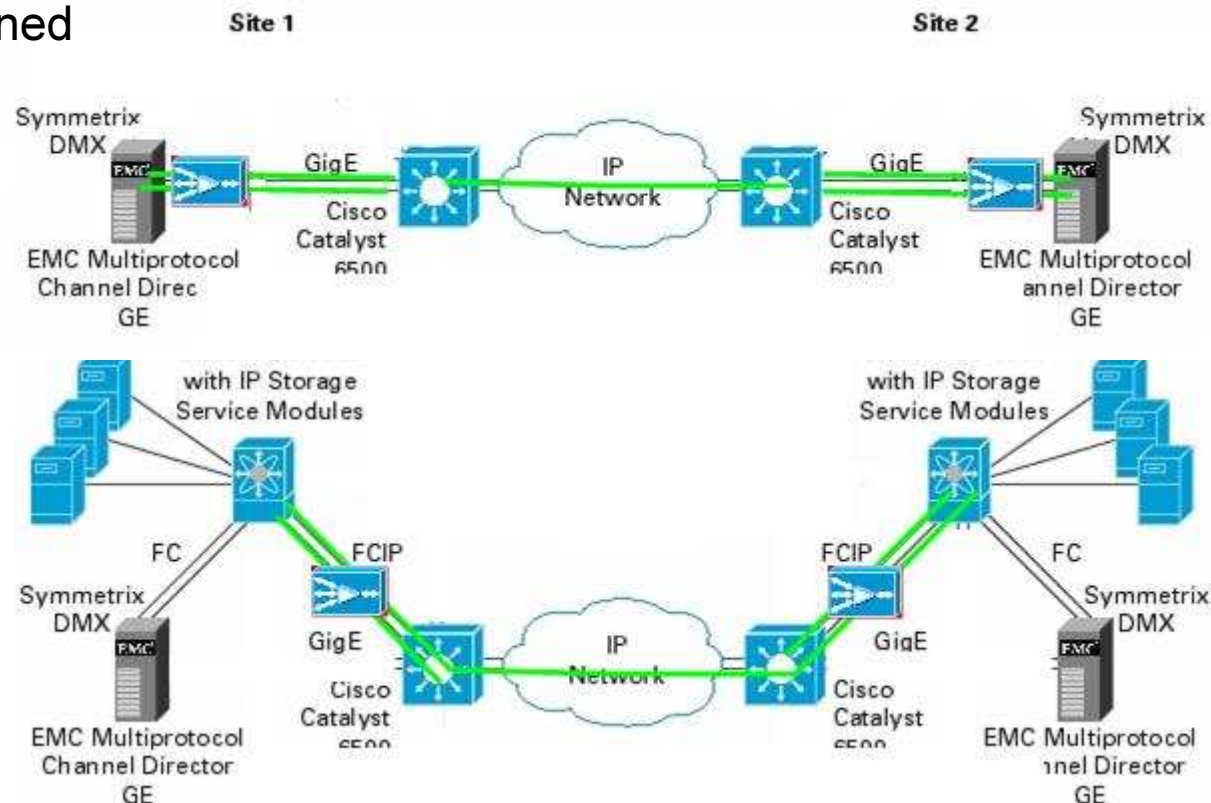

WAAS Management Enhancements

- **Improved Central Manager Navigation**
 - New Context-based Menus
 - Based on device group or device selection
 - Reorganized for more intuitive access
- **New Reporting capabilities**
 - Choose pre-defined reports or your own
 - Scheduled report generation and email
 - Report per device or device group

- **New RBAC capabilities**
 - Support for User Group authorization
 - New privileges, inc'l Read-only access
 - Reporting views
- **TFO Auto-Tuning**
 - Automates TFO settings for WAN links
- **CIFS Transparency**
 - Eliminates configuration of core/edge
- **Transparent Video Optimization**
 - Streams Auto-Detection & optimization
- **SOA-ready Monitoring**
 - Standard XML Web Service (SOAP)
 - Integration with external reporting and monitoring portals
- **Virtual Blade Management**
 - Centralized creation, deployment, management & monitoring for Virtual Blades



Centralized Print Acceleration

- Bi-directional Print Job Acceleration
 - Client-to-server print job spooling
 - Server-to-printer printing
 - No config needed – just turn on!
- Centralized print at near-LAN speed
 - Enable centralized Windows Print
 - Transparent to Windows AD

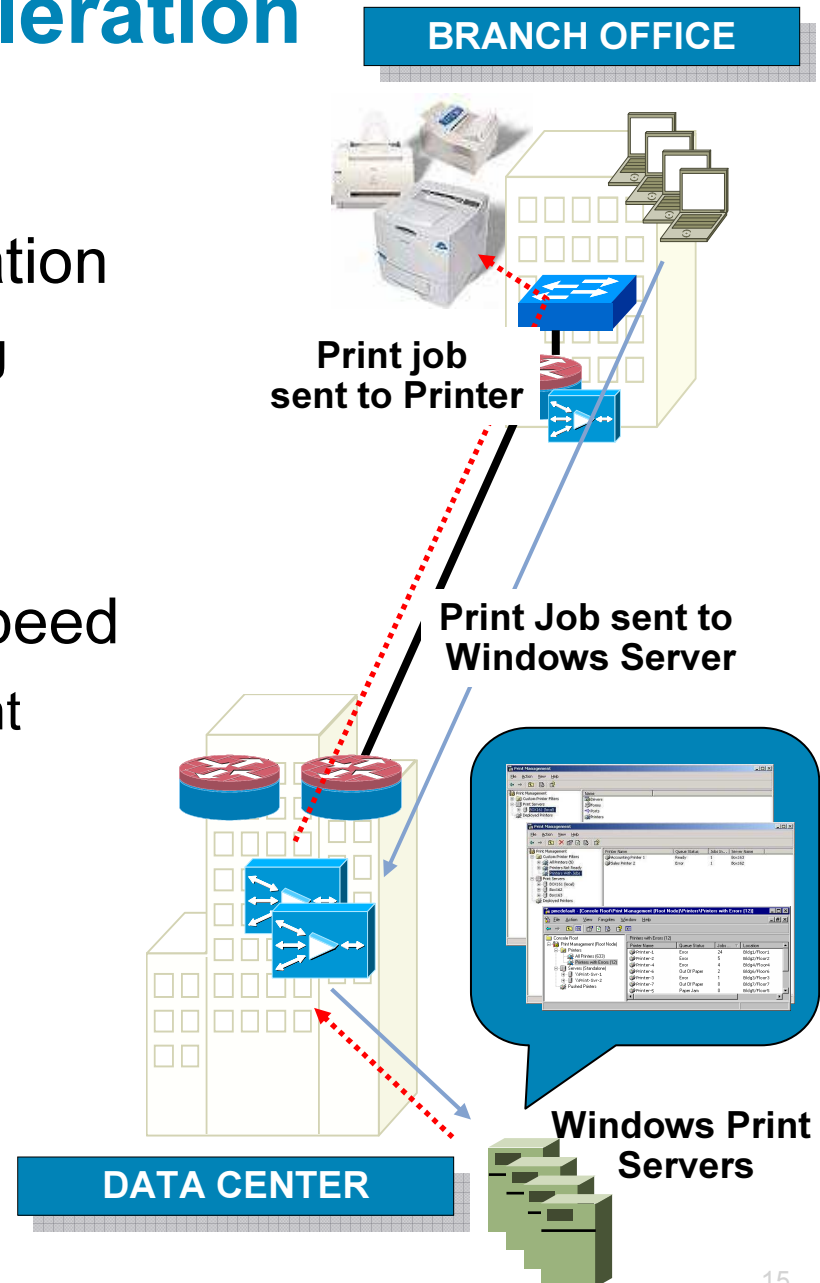

WAAS Product Execution – 6 feature releases 2 years + WAAS Mobile

| | |
|---|--|
| Sep 2006 | <ul style="list-style-type: none"> ▪ WAAS 4.0 on Appliances |
| Dec 2006 | <ul style="list-style-type: none"> ▪ WAAS on Router Network Module |
| April 2007 | <ul style="list-style-type: none"> ▪ “Quick Deployment” for WAAS <ul style="list-style-type: none"> ➢ Transparent Inline Mode & CIFS Server Auto-Discovery |
| Aug 2007 | <ul style="list-style-type: none"> ▪ Differentiators w on Security, Scalability, Application SLA <ul style="list-style-type: none"> ➢ Including a new GUI w real-time connection monitoring |
| Jan 2008 | <ul style="list-style-type: none"> ▪ WAAS certified by Microsoft, Oracle, SAP other major ISVs ▪ WAAS Mobile <ul style="list-style-type: none"> ➢ WAN Acceleration for Laptop users on a VPN connection |
| May 2008 | <ul style="list-style-type: none"> ▪ WAAS for DC to DC Replication |
| July 2008 (Release date to be confirmed at Delivery Commit in May 2008) | <ul style="list-style-type: none"> ▪ WAAS Davis Release <ul style="list-style-type: none"> ➢ Best in class GUI and Ease of Deployment ➢ More optimizations for MAPI, HTTP, CIFS, NFS, Windows Print ➢ SSL ➢ Live Video Streaming ➢ Windows on WAAS, Virtual Blades (for WAE-674 only) |

Value-Driven WAAS Sales Process

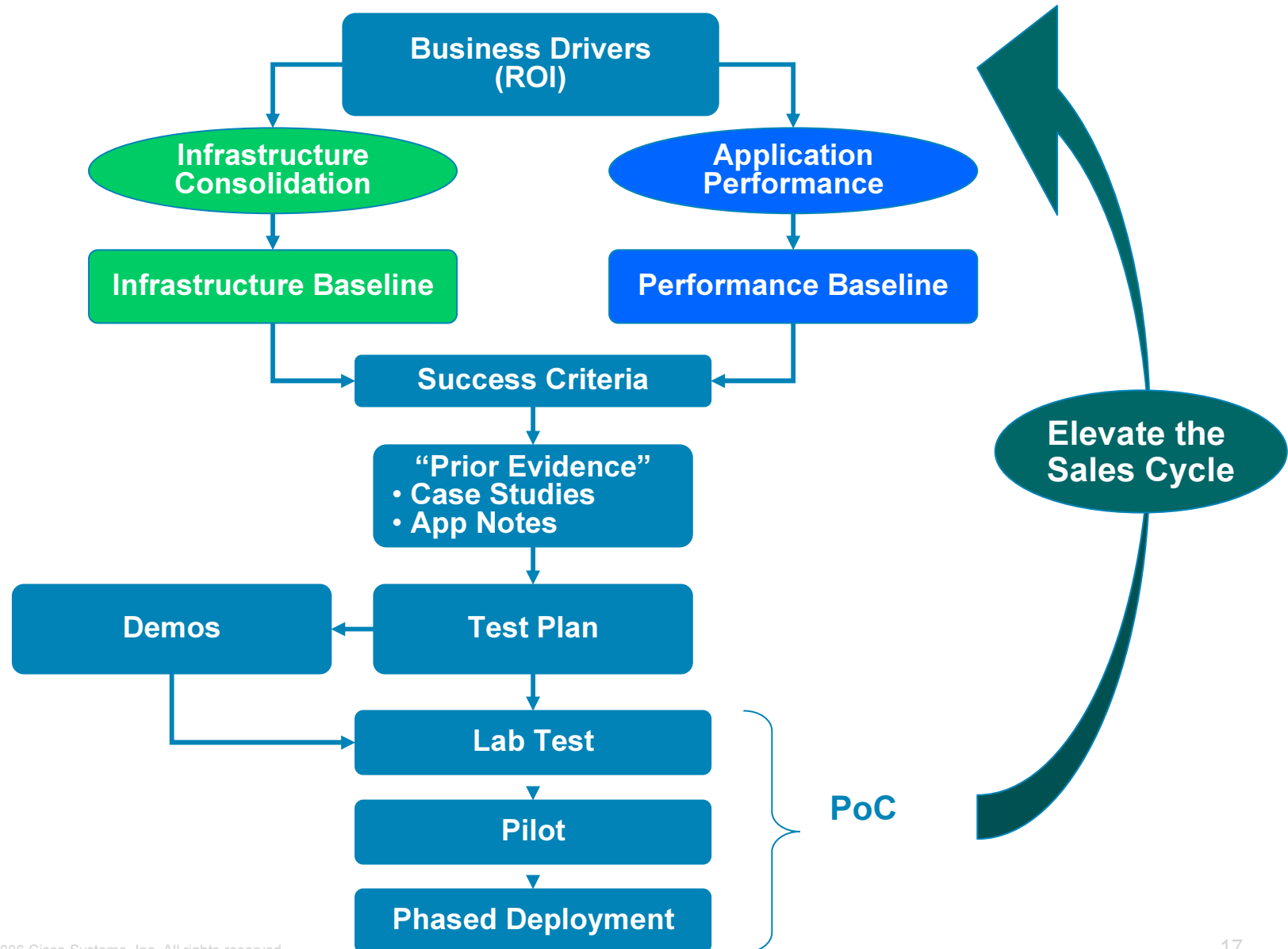

To Summarize...

- WAAS is a large market and a key component for CISCO:
 - Large investment by CISCO on the R&D
 - Strong technology partnerships with Software vendors
- Strong market traction :
 - Over 2,000 Customers; Over 25,000 Units
 - Cisco's advantages recognized
- Focused product execution :
 - Key releases have been announced
 - We have the right Technology
 - We have the right Partners