



## **User Guide for AsyncOS 14.2.1 for Cisco Secure Email Gateway - MD (Maintenance Deployment)**

**First Published:** 2022-10-03

**Last Modified:** 2022-05-26

### **Americas Headquarters**

Cisco Systems, Inc.  
170 West Tasman Drive  
San Jose, CA 95134-1706  
USA  
<http://www.cisco.com>  
Tel: 408 526-4000  
800 553-NETS (6387)  
Fax: 408 527-0883

THE SPECIFICATIONS AND INFORMATION REGARDING THE PRODUCTS IN THIS MANUAL ARE SUBJECT TO CHANGE WITHOUT NOTICE. ALL STATEMENTS, INFORMATION, AND RECOMMENDATIONS IN THIS MANUAL ARE BELIEVED TO BE ACCURATE BUT ARE PRESENTED WITHOUT WARRANTY OF ANY KIND, EXPRESS OR IMPLIED. USERS MUST TAKE FULL RESPONSIBILITY FOR THEIR APPLICATION OF ANY PRODUCTS.

THE SOFTWARE LICENSE AND LIMITED WARRANTY FOR THE ACCOMPANYING PRODUCT ARE SET FORTH IN THE INFORMATION PACKET THAT SHIPPED WITH THE PRODUCT AND ARE INCORPORATED HEREIN BY THIS REFERENCE. IF YOU ARE UNABLE TO LOCATE THE SOFTWARE LICENSE OR LIMITED WARRANTY, CONTACT YOUR CISCO REPRESENTATIVE FOR A COPY.

The Cisco implementation of TCP header compression is an adaptation of a program developed by the University of California, Berkeley (UCB) as part of UCB's public domain version of the UNIX operating system. All rights reserved. Copyright © 1981, Regents of the University of California.

NOTWITHSTANDING ANY OTHER WARRANTY HEREIN, ALL DOCUMENT FILES AND SOFTWARE OF THESE SUPPLIERS ARE PROVIDED "AS IS" WITH ALL FAULTS. CISCO AND THE ABOVE-NAMED SUPPLIERS DISCLAIM ALL WARRANTIES, EXPRESSED OR IMPLIED, INCLUDING, WITHOUT LIMITATION, THOSE OF MERCHANTABILITY, FITNESS FOR A PARTICULAR PURPOSE AND NON-INFRINGEMENT OR ARISING FROM A COURSE OF DEALING, USAGE, OR TRADE PRACTICE.

IN NO EVENT SHALL CISCO OR ITS SUPPLIERS BE LIABLE FOR ANY INDIRECT, SPECIAL, CONSEQUENTIAL, OR INCIDENTAL DAMAGES, INCLUDING, WITHOUT LIMITATION, LOST PROFITS OR LOSS OR DAMAGE TO DATA ARISING OUT OF THE USE OR INABILITY TO USE THIS MANUAL, EVEN IF CISCO OR ITS SUPPLIERS HAVE BEEN ADVISED OF THE POSSIBILITY OF SUCH DAMAGES.

Any Internet Protocol (IP) addresses and phone numbers used in this document are not intended to be actual addresses and phone numbers. Any examples, command display output, network topology diagrams, and other figures included in the document are shown for illustrative purposes only. Any use of actual IP addresses or phone numbers in illustrative content is unintentional and coincidental.

All printed copies and duplicate soft copies of this document are considered uncontrolled. See the current online version for the latest version.

Cisco has more than 200 offices worldwide. Addresses and phone numbers are listed on the Cisco website at [www.cisco.com/go/offices](http://www.cisco.com/go/offices).

The documentation set for this product strives to use bias-free language. For purposes of this documentation set, bias-free is defined as language that does not imply discrimination based on age, disability, gender, racial identity, ethnic identity, sexual orientation, socioeconomic status, and intersectionality. Exceptions may be present in the documentation due to language that is hardcoded in the user interfaces of the product software, language used based on standards documentation, or language that is used by a referenced third-party product.

Cisco and the Cisco logo are trademarks or registered trademarks of Cisco and/or its affiliates in the U.S. and other countries. To view a list of Cisco trademarks, go to this URL: <https://www.cisco.com/c/en/us/about/legal/trademarks.html>. Third-party trademarks mentioned are the property of their respective owners. The use of the word partner does not imply a partnership relationship between Cisco and any other company. (1721R)

© 2022 Cisco Systems, Inc. All rights reserved.



## CONTENTS

---

### CHAPTER 1

#### **Getting Started with Cisco Secure Email Gateway 1**

- What's New in AsyncOS 14.2.1 1
- Comparison of Web Interfaces, New Web Interface with Legacy Web Interface 1
- Where to Find More Information 4
  - Documentation 4
  - Training 5
  - Cisco Notification Service 5
  - Knowledge Base 5
  - Cisco Support Community 6
  - Cisco Customer Support 6
  - Third Party Contributors 6
  - Cisco Welcomes Your Comments 6
  - Registering for a Cisco Account 7
- Cisco Secure Email Gateway Overview 7
  - Supported Languages 8

---

### CHAPTER 2

#### **Accessing the Email Gateway 9**

- Web-based Graphical User Interface (GUI) 9
  - Browser Requirements 9
  - Accessing the GUI 10
    - Factory Default Username and Passphrase 10
    - Centralized Management 10
  - Enhanced User Experience using How-Tos Widget 11
    - Disabling How-Tos Widget on the Email Gateway 11
- Changing Configuration Settings 12
  - Configuration Changes 12

Commit or Abandoning Changes	12
Command Line Interface (CLI)	12
<hr/>	
<b>CHAPTER 3</b>	<b>Setup and Installation 13</b>
Installation Planning	13
Review Information That Impacts Planning Decisions	13
Plan to Place the Email Gateway at the Perimeter of Your Network	13
Register the Email Security Appliance in DNS	14
Installation Scenarios	15
Configuration Overview	15
Incoming	15
Outgoing	15
Ethernet Interfaces	15
Hardware Ports	16
Advanced Configurations	16
Firewall Settings (NAT, Ports)	16
Physically Connecting the Email Gateway to the Network	16
Configuration Scenarios	17
Segregating Incoming and Outgoing Mail	17
Preparing for System Setup	20
Determine Method for Connecting to the Email Gateway	21
Connecting to the Email Gateway	21
Determining Network and IP Address Assignments	22
Default IP Addresses for Management and Data Ports	22
Choosing Network Connections to Receive and Deliver Email	22
Binding Logical IP Addresses to Physical Ethernet Ports	22
Choosing Network Settings for Your Connections	22
Gathering the Setup Information	23
Using the System Setup Wizard	26
Accessing the Web-Based Graphical User Interface (GUI)	26
Factory Default Username and Passphrase	27
Accessing the Legacy Web Interface	28
Accessing New Web Interface in Dusk Mode	28
Defining Basic Configuration Using the Web-Based System Setup Wizard	28

Step 1: Start	29
Step 2: System	30
Step 3: Network	31
Step 4: Security	35
Step 5: Review	36
Setting up the Connection to Active Directory	36
Proceeding to the Next Steps	37
Accessing the Command Line Interface (CLI)	37
Factory Default Username and Passphrase	37
Running the Command Line Interface (CLI) System Setup Wizard	38
Change the Admin Passphrase	39
Accept the License Agreement	39
Set the Hostname	39
Assign and Configure Logical IP Interface(s)	40
Specify the Default Gateway	40
Enable the Web Interface	41
Configure the DNS Settings	41
Create a Listener	41
Enable Anti-Spam	48
Select a Default Anti-Spam Scanning Engine	49
Enable the Spam Quarantine	49
Enable Anti-Virus Scanning	49
Enable Outbreak Filters	49
Configure the Alert Settings and AutoSupport	50
Configure Scheduled Reporting	50
Configure Time Settings	50
Commit Changes	50
Test the Configuration	50
Immediate Alerts	51
Configuring your system as an Enterprise Gateway	51
Verifying Your Configuration and Next Steps	51
<b>CHAPTER 4</b>	
<b>Understanding the Email Pipeline</b>	<b>53</b>
Overview of the Email Pipeline	53

- Email Pipeline Flows **53**
- Incoming / Receiving **56**
  - Host Access Table (HAT), Sender Groups, and Mail Flow Policies **56**
  - Received: Header **57**
  - Default Domain **57**
  - Bounce Verification **57**
  - Domain Map **57**
  - Recipient Access Table (RAT) **57**
  - Alias Tables **57**
  - LDAP Recipient Acceptance **58**
  - SMTP Call-Ahead Recipient Validation **58**
- Work Queue / Routing **58**
  - Email Pipeline and Security Services **58**
  - LDAP Recipient Acceptance **59**
  - Masquerading or LDAP Masquerading **59**
  - LDAP Routing **59**
  - Message Filters **59**
  - Email Security Manager (Per-Recipient Scanning) **60**
    - Safelist/Blocklist Scanning **60**
    - Anti-Spam **60**
    - Anti-Virus **60**
    - Graymail Detection and Safe Unsubscribing **61**
    - File Reputation Scanning and File Analysis **61**
    - Content Filters **61**
    - Outbreak Filters **61**
  - Quarantines **61**
- Delivery **62**
  - Virtual gateways **62**
  - Delivery Limits **62**
  - Domain-Based Limits **62**
  - Domain-Based Routing **62**
  - Global Unsubscribe **63**
  - Bounce Limits **63**

---

<b>CHAPTER 5</b>	<b>Configuring the Gateway to Receive Email</b>	<b>65</b>
	Overview of Configuring the Gateway to Receive Email	65
	Working with Listeners	66
	Configuring Global Settings for Listeners	68
	Settings for Messages Containing Multiple Encodings	70
	Listening for Connection Requests by Creating a Listener Using Web Interface	71
	Partial Domains, Default Domains, and Malformed MAIL FROMs	75
	Listening for Connection Requests by Creating a Listener Using CLI	76
	Advanced HAT Parameters	77
	Enterprise Gateway Configuration	78
<b>CHAPTER 6</b>	<b>IP Reputation Filtering</b>	<b>81</b>
	Overview of Sender IP Reputation Filtering	81
	IP Reputation Service	81
	IP Reputation Score	82
	How Sender IP Reputation Filters Work	83
	Recommended Settings for Different Sender IP Reputation Filtering Approaches	83
	Editing IP Reputation Filtering Score Thresholds for a Listener	84
	Testing IP Reputation Filtering Using the IP Reputation Scores	85
	Entering Low IP Reputation Scores in the Message Subject	86
<b>CHAPTER 7</b>	<b>Defining Which Hosts Are Allowed to Connect Using the Host Access Table</b>	<b>89</b>
	Overview of Defining Which Hosts Are Allowed to Connect	89
	Default HAT Entries	90
	Defining Remote Hosts into Sender Groups	90
	Sender Group Syntax	91
	Sender Groups Defined by Network Owners, Domains, and IP Addresses	92
	Setting Policies Based on the HAT	93
	Defining Sender Groups by IP Reputation Score	94
	Sender Groups Defined by Querying DNS Lists	95
	Defining Access Rules for Email Senders Using Mail Flow Policies	95
	HAT Variable Syntax	96
	Using HAT Variables	97

---

Testing HAT Variables	98
Understanding Predefined Sender Groups and Mail Flow Policies	98
Handling Messages from a Group of Senders in the Same Manner	100
Creating a Sender Group for Message Handling	101
Adding a Sender to an Existing Sender Group	102
Rearranging the Order of the Rules to Perform for Incoming Connections	102
Searching for Senders	103
Defining Rules for Incoming Messages Using a Mail Flow Policy	103
Defining Default Values for Mail Flow Policies	108
Working with the Host Access Table Configuration	109
Exporting the Host Access Table Configuration to an External File	109
Importing the Host Access Table Configuration from an External File	109
Using a List of Sender Addresses for Incoming Connection Rules	110
SenderBase Settings and Mail Flow Policies	111
HAT Significant Bits Feature	111
HAT Configuration	112
Significant Bits HAT Policy Option	112
Injection Control Periodicity	112
Verifying Senders	113
Sender Verification: Host	113
Sender Verification: Envelope Sender	114
Partial Domains, Default Domains, and Malformed MAIL FROMs	115
Custom SMTP Code and Response	115
Sender Verification Exception Table	115
Implementing Sender Verification — Example Settings	116
Throttling Messages from Unverified Senders Using the SUSPECTLIST Sender Group	117
Implementing More Stringent Throttling Settings for Unverified Senders	117
Defining Messages to Send to Unverified Senders Using the ACCEPTED Mail Flow Policy	118
Excluding Unverified Senders from Sender Verification Rules Based on Sender's Email Address	118
Searching for Addresses within the Sender Verification Exception Table	118
Testing Your Settings for Messages from Unverified Senders	119
Sending a Test Message with a Malformed MAIL FROM Sender Address	119
Sending a Message from an Address That is Excluded from Sender Verification Rules	119



Sender Verification and Logging 120

Envelope Sender Verification 120

---

## CHAPTER 8

### Accepting or Rejecting Connections Based on Domain Name or Recipient Address 121

Overview of Accepting or Rejecting Connections Based on the Recipient's Address 121

Overview of the Recipient Access Table (RAT) 122

Accessing the RAT using the GUI 122

Accessing the RAT using the CLI 122

Editing the Default RAT Entry 122

Domains and Users 123

Adding Domains and Users For Which to Accept Messages 123

Defining Recipient Addresses 124

Bypassing LDAP Accept for Special Recipients 124

Bypassing Throttling for Special Recipients 125

Rearranging the Order of Domains and Users in the Recipient Access Table 125

Exporting the Recipient Access Table to an External File 126

Importing the Recipient Access Table from an External File 126

---

## CHAPTER 9

### Using Message Filters to Enforce Email Policies 127

Overview 127

Components of a Message Filter 128

Message Filter Rules 128

Message Filter Actions 128

Message Filter Example Syntax 129

Message Filter Processing 130

Message Filter Order 131

Message Header Rules and Evaluation 131

Message Bodies vs. Message Attachments 131

Thresholds for Matches in Content Scanning 132

Threshold Syntax 133

Threshold Scoring for Message Bodies and Attachments 133

Threshold Scoring Multipart/Alternative MIME Parts 133

Threshold Scoring for Content Dictionaries 134

AND Test and OR Tests in Message Filters 135

Message Filter Rules	135
Filter Rules Summary Table	136
Regular Expressions in Rules	146
Using Regular Expressions to Filter Messages	148
Guidelines for Using Regular Expressions	148
Regular Expression and Non-ASCII Character Sets	149
n Tests	149
Case-sensitivity	149
Writing Efficient Filters	149
PDFs and Regular Expressions	150
Smart Identifiers	150
Smart Identifier Syntax	151
Description and Examples of Message Filter Rules	152
True Rule	153
Valid Rule	154
Subject Rule	154
Envelope Recipient Rule	155
Envelope Recipient in Group Rule	155
Envelope Sender Rule	155
Envelope Sender in Group Rule	156
Sender Group Rule	156
Body Size Rule	156
Remote IP Rule	157
Receiving Listener Rule	158
Receiving IP Interface Rule	158
Date Rule	158
Header Rule	159
Random Rule	159
Recipient Count Rule	160
Address Count Rule	160
Body Scanning Rule	160
Body Scanning	161
Encryption Detection Rule	161
Attachment Type Rule	162

Attachment Filename Rule	162
DNS List Rule	163
IP Reputation Rule	164
Dictionary Rules	165
SPF-Status Rule	166
SPF-Passed Rule	168
S/MIME Gateway Message Rule	168
S/MIME Gateway Verified Rule	168
Workqueue-count Rule	168
SMTP Authenticated User Match Rule	169
Signed Rule	171
Signed Certificate Rule	171
Header Repeats Rule	173
URL Reputation Rules	175
URL Category Rule	176
Corrupt Attachment Rule	176
Message Language Rule	177
Macro Detection Rule	178
Forged Email Detection Rule	178
Duplicate Boundaries Verification Rule	179
Malformed MIME Header Detection Rule	180
Geolocation Rule	180
Domain Reputation Rule for ETF	180
Domain Reputation Rule for SDR	181
Message Filter Actions	183
Filter Actions Summary Table	183
Attachment Groups	190
Action Variables	192
Non-ASCII Character Sets and Message Filter Action Variables	194
Matched Content Visibility	194
Description and Examples of Message Filter Actions	195
Skip Remaining Message Filters Action	196
Drop Action	196
Bounce Action	197

Encrypt Action	197
S/MIME Sign or Encrypt on Delivery Action	197
S/MIME Sign or Encrypt Action	197
Notify and Notify-Copy Actions	198
Blind Carbon Copy Actions	200
Quarantine and Duplicate Actions	202
Alter Recipient Action	203
Alter Delivery Host Action	203
Alter Source Host (Virtual Gateway address) Action	204
Archive Action	204
Strip Header Action	205
Insert Header Action	205
Edit Header Text Action	206
Edit Body Text Action	206
HTML Convert Action	207
Bounce Profile Action	208
Bypass Anti-Spam System Action	208
Bypassing Graymail Actions	209
Bypass Anti-Virus System Action	209
Bypass File Reputation Filtering and File Analysis System Actions	210
Bypass Outbreak Filter Scanning Action	210
Add Message Tag Action	210
Add Log Entry Action	211
URL Reputation Actions	211
URL Category Actions	213
No Operation	214
Forged Email Detection Action	214
Attachment Scanning	214
Message Filters for Scanning Attachments	216
Image Analysis	217
Configuring the Image Analysis Scanning Engine	217
Tuning Image Analysis Settings	218
Configuring the Message Filter to Perform Actions Based on Image Analysis Results	219
Creating Content Filters to Strip Attachments Based on Image Analysis Verdicts	220

Configuring an Action Based on Image Analysis Verdicts	220
Notifications	221
Examples of Attachment Scanning Message Filters	221
Inserting Headers	222
Dropping Attachments by File Type	222
Dropping Attachments by Dictionary Matches	223
Quarantining Protected Attachments	224
Detecting Unprotected Attachments	224
Detecting Malicious Files in Messages Attachments Using Message Filter	224
Using the CLI to Manage Message Filters	225
Creating a New Message Filter	227
Deleting a Message Filter	227
Moving a Message Filter	227
Activating and Deactivating a Message Filter	227
Activating or Deactivating a Message Filter	230
Importing Pre-Policy Filters	230
Exporting Message Filters	231
Viewing Non-ASCII Character Sets	231
Displaying a Message Filter List	231
Displaying Message Filter Details	232
Configuring Filter Log Subscriptions	232
Changing Message Encoding	233
Sample Message Filters	235
Message Filter Examples	240
Open-Relay Prevention Filter	240
Policy Enforcement Filters	240
Notify Based on Subject Filter	241
BCC and Scan Mail Sent to Competitors	241
Block Specific User Filter	241
Archive and Drop Messages Filter	241
Large “To:” Header Filter	242
Blank “From:” Filter	242
IP Reputation Filter	243
Alter IP Reputation Filter	243

- Filename Regex Filter 243
- Show IP Reputation Score in Header Filter 243
- Insert Policy into Header Filter 243
- Too Many Recipients Bounce Filter 244
- Routing and Domain Spoofing 244
  - Using Virtual Gateways Filter 244
  - Same Listener for Deliver and Listener Filter 244
  - Single Listener Filter 245
  - Drop Spoofed Domain Filter (Single Listener) 245
  - Drop Spoofed Domain Filter (Multiple Listeners) 245
  - Another Drop Spoofed Domain Filter 246
  - Detect Looping Filter 246
  - Drop Message Attachments that match File SHA-256 Filter 247
  - Drop Messages if Attachment matches File SHA-256 Filter 247
- Configuring Scan Behavior 247
  - Configuring Message Handling Actions for Unscannable Messages 252
    - Delivering the Message 252
    - Sending Message to Policy Quarantine 253

---

**CHAPTER 10**

**Mail Policies 255**

- Overview of Mail Policies 255
- How to Enforce Mail Policies on a Per-User Basis 256
- Handling Incoming and Outgoing Messages Differently 257
- Matching Users to a Mail Policy 257
  - First Match Wins 258
  - Examples of Policy Matching 258
    - Example 1 259
    - Example 2 259
    - Example 3 259
- Message Splintering 260
  - Managed Exceptions 261
- Configuring Mail Policies 261
  - Configuring the Default Mail Policy for Incoming or Outgoing Messages 261
  - Creating a Mail Policy for a Group of Senders and Recipients 262

Defining Senders and Recipients for Mail Policies	263
Examples	264
Finding Which Policies Apply to a Sender or Recipient	265
Managed Exceptions	265
Setting Priority for Message Headers	266

---

**CHAPTER 11**
**Content Filters 269**

Overview of Content Filters	269
How Content Filters Work	269
How to Scan Message Content Using a Content Filter	270
Content Filter Conditions	270
Content Filter Actions	278
Action Variables	285
How to Filter Messages Based on Content	287
Creating a Content Filter	287
Enabling Content Filters for All Recipients by Default	288
Applying the Content Filter to Messages for a Certain User Group	289
Notes on Configuring Content Filters in the GUI	289

---

**CHAPTER 12**
**Configuring Email Gateway to Consume External Threat Feeds 293**

Overview of External Threat Feeds	293
How to Configure Email Gateway to Consume External Threat Feeds	294
Obtaining External Threat Feeds Feature Key	296
Enabling External Threat Feeds Engine on Email Gateway	297
Configuring an External Threat Feed Source	298
Configuring SecureX Threat Response Feeds Source	300
Handling Messages Containing Threats	304
Configuring a Sender Group for Handling Messages containing Threats	305
Configuring Content or Message Filters for Handling Messages Containing Threats	305
Detecting Malicious Domains in Messages Using Content Filter	306
Creating Domain Exception List	306
Detecting Malicious Domains in Messages Using Message Filter	307
Detecting Malicious URLs in Messages Using Content Filter	307
Detecting Malicious URLs in Messages Using Message Filter	309

	Detecting Malicious Files in Message Attachments Using Content Filter	310
	Creating File Hash List	311
	Detecting Malicious Files in Messages Attachments Using Message Filter	311
	Attaching Content Filter to Incoming Mail Policy	312
	External Threat Feeds and Clusters	312
	Monitoring External Threat Feeds Engine Updates	312
	Viewing Alerts	313
	Displaying Threat Details in Message Tracking	313
<hr/>		
<b>CHAPTER 13</b>	<b>Sender Domain Reputation Filtering</b>	<b>315</b>
	Overview of Sender Domain Reputation Filtering	315
	SDR Verdicts	316
	How to Filter Messages based on Sender Domain Reputation	318
	Enabling Sender Domain Reputation Filtering on Email Gateway	318
	Tuning Sender Domain Reputation Policy	319
	Configuring Message or Content Filter for Handling Messages based on Sender Domain Reputation	320
	Filtering Messages based on Sender Domain Reputation using Message Filter	321
	Filtering Messages based on Sender Domain Reputation using Content Filter	323
	Creating Domain Exception List	323
	Attaching Content Filter to Incoming Mail Policy	324
	Sender Domain Reputation Filtering and Clusters	324
	Displaying Sender Domain Reputation Details in Message Tracking	325
	Viewing Alerts	325
	Viewing Logs	325
	Examples of SDR Filtering Log Entries	326
	Sender Domain Reputation Request Timeout	326
	Sender Domain Reputation General Errors	326
<hr/>		
<b>CHAPTER 14</b>	<b>Integrating with Cisco SecureX Threat Response</b>	<b>327</b>
	Integrating your Email Gateway with Cisco SecureX Threat Response	327
	How to Integrate your Email Gateway with Cisco SecureX Threat Response	328
	Prerequisites	329
	Enabling Cisco Cloud Services Portal on Email Gateway	330
	Registering Email Gateway with Cisco Cloud Services Portal	331



Confirm Whether the Registration was Successful	331
Enabling Cisco SecureX Threat Response on Email Gateway	331
Reregistering Email Gateway with Cisco Cloud Services Portal	332
Performing Threat Analysis using Cisco SecureX Ribbon	333
Accessing the Cisco SecureX Ribbon	333
Adding Observable to Casebook for Threat Analysis using Cisco SecureX Ribbon and Pivot Menu	335
Performing Remedial Actions on Messages in Cisco SecureX Threat Response	336
Improving User Experience of Email Gateway using Cisco Success Network	337
Enabling CSN on Email Gateway	338
Disabling CSN on Email Gateway	338

**CHAPTER 15****Configuring Email Gateway to Safe Print Message Attachments 341**

Overview	341
How to Configure Email Gateway to Safe Print Message Attachments	342
Configuring Safe Print Settings on Email Gateway	342
Configuring Content Filter to Safe Print Message Attachments	343
Attaching Content Filter to Incoming Mail Policy	345
Safe Print Settings and Clusters	346
Monitoring Messages with Safe-Printed Attachments	346
Viewing Logs	346
Examples of Safe Print Log Entries	346
Unable to Create Temporary Directory	347
Unable to Create Safe-printed PDF Attachment	347
Corrupt File	347
Encrypted File	347
Timeout Error	347
Displaying Safe Print Details in Message Tracking	347

**CHAPTER 16****Integrating Email Gateway with Cisco Secure Awareness Cloud Service 349**

Overview	349
How to Integrate Email Gateway with Cisco Secure Awareness Cloud Service	350
Creating Cisco Secure Awareness Cloud Service Account	351
Configuring Firewall Settings to Access Cisco Secure Awareness Cloud Service	351
Creating Sender Group to Allow Simulated Phishing Messages in Email Gateway	352

Obtaining Authentication Token from Cisco Secure Awareness Cloud Service	353
Enabling Cisco Secure Awareness Cloud Service on Email Gateway	354
Create Custom Incoming Mail Policy for End Users Categorized as Repeat Clickers	355
Cisco Secure Awareness Cloud Service and Clusters	355
Viewing Logs	355
Viewing Alerts	357

---

**CHAPTER 17****Anti-Virus 361**

Anti-Virus Scanning Overview	361
Evaluation Key	362
Scanning Messages with Multiple Anti-Virus Scanning Engines	362
Sophos Anti-Virus Filtering	362
Virus Detection Engine	363
Virus Scanning	363
Detection Methods	363
Pattern Matching	363
Heuristics	364
Emulation	364
Virus Descriptions	364
Sophos Alerts	364
When a Virus is Found	364
McAfee Anti-Virus Filtering	365
Pattern-Matching Virus Signatures	365
Encrypted Polymorphic Virus Detection	365
Heuristics Analysis	365
When a Virus is Found	366
How to Configure the Email Gateway to Scan for Viruses	366
Enabling Virus Scanning and Configuring Global Settings	367
Configuring Virus Scanning Actions for Users	367
Message Scanning Settings	368
Message Handling Settings	368
Configuring Settings for Message Handling Actions	369
Configuring the Anti-Virus Policies for Different Groups of Senders and Recipients	372
Notes on Anti-Virus Configurations	373

Flow Diagram for Anti-Virus Actions	374
Sending an Email to the Email Gateway to Test Anti-Virus Scanning	375
Updating Virus Definitions	377
About Retrieving Anti-Virus Updates via HTTP	377
Configuring Update Server Settings	377
Monitoring and Manually Checking for Anti-Virus Updates	377
Manually Updating Anti-Virus Engines	377
Verifying Anti-Virus Files Have Updated on the Email Gateway	378

**CHAPTER 18****Managing Spam and Graymail 379**

Overview of Anti-Spam Scanning	379
Anti-Spam Solutions	380
How to Configure the Email Gateway to Scan Messages for Spam	380
IronPort Anti-Spam Filtering	382
Evaluation Key	382
Cisco Anti-Spam: an Overview	382
Configuring IronPort Anti-Spam Scanning	383
Configuring Intelligent Multi-Scan and Graymail Detection	384
Configuring Cisco Intelligent Multi-Scan	384
Managing Graymail	385
Overview of Graymail	386
Graymail Management Solution in Email Gateway	386
How Graymail Management Solution Works	387
Configuring Graymail Detection and Safe Unsubscribing	389
Troubleshooting Graymail Detection and Safe Unsubscribing	394
Configuring Global Settings for Intelligent Multi-Scan and Graymail Detection	394
Defining Anti-Spam Policies	395
Understanding Positive and Suspect Spam Thresholds	397
Configuration Examples: Actions for Positively Identified versus Suspected Spam	398
Unwanted Marketing Messages From Legitimate Sources	398
Using Custom Headers to Redirect URLs in Suspected Spam to the Cisco Web Security Proxy: Configuration Example	399
Enabling Different Anti-Spam Scanning Engines in Different Mail Policies: Configuration Example	400

- Protecting Email Gateway-Generated Messages From the Spam Filter 401
- Headers Added During Anti-Spam Scanning 402
- Reporting Incorrectly Classified Messages to Cisco 402
  - How to Report Incorrectly Classified Messages to Cisco 402
  - How to Report Incorrectly Classified Messages to Cisco 404
    - Using Cisco Email Security Plug-In 405
    - Forwarding Incorrectly Classified Message as an Attachment 405
  - How to Track Your Submissions 407
- Determining Sender IP Address In Deployments with Incoming Relays 407
  - Example Environments with Incoming Relays 408
  - Configuring the Email Gateway to Work with Incoming Relays 409
    - Enabling the Incoming Relays Feature 409
    - Adding an Incoming Relay 410
    - Message Headers for Relayed Messages 411
  - How Incoming Relays Affect Functionality 414
    - Incoming Relays and Filters 414
    - Incoming Relays, HAT, IP Reputation Score, and Sender Groups 415
    - Incoming Relays and Directory Harvest Attack Prevention 415
    - Incoming Relays and Trace 415
    - Incoming Relays and Email Security Monitor (Reporting) 415
    - Incoming Relays and Message Tracking 415
    - Incoming Relays and Logging 415
  - Configuring Logs to Specify Which Headers Are Used 416
- Monitoring Rules Updates 416
- Testing Anti-Spam 417
  - Sending an Email to the Email Gateway to Test Cisco Anti-Spam 418
    - Testing Anti-Spam Configuration: Example Using SMTP 418
  - Ways Not to Test Anti-Spam Efficacy 419

---

**CHAPTER 19**

**Outbreak Filters 421**

- Overview of Outbreak Filters 421
- How Outbreak Filters Work 421
  - Delaying, Redirecting, and Modifying Messages 422
  - Threat Categories 422

Virus Outbreaks	423
Phishing, Malware Distribution, and Other Non-Viral Threats	423
Cisco Security Intelligence Operations	423
Context Adaptive Scanning Engine	424
Delaying Messages	424
Redirecting URLs	425
Modifying Messages	426
Types of Rules: Adaptive and Outbreak	426
Outbreak Rules	426
Adaptive Rules	426
Outbreaks	427
Threat Levels	427
Guidelines for Setting Your Quarantine Threat Level Threshold	427
Containers: Specific and Always Rules	428
How the Outbreak Filters Feature Works	428
Message Scoring	429
Dynamic Quarantine	429
Outbreak Lifecycle and Rules Publishing	430
Managing Outbreak Filters	431
Configuring Outbreak Filters Global Settings	432
Enabling the Outbreak Filters Feature	433
Enabling Adaptive Rules	433
Enabling Alerts for Outbreak Filters	433
Enabling Logging of URLs and Message Tracking Details for URLs	433
Outbreak Filters Rules	434
Managing Outbreak Filter Rules	434
The Outbreak Filters Feature and Mail Policies	434
Setting a Quarantine Level Threshold	435
Maximum Quarantine Retention	435
Bypassing File Extension Types	436
Message Modification	436
The Outbreak Filters Feature and the Outbreak Quarantine	439
Monitoring the Outbreak Quarantine	439
Outbreak Quarantine and the Manage by Rule Summary View	440

Monitoring Outbreak Filters	441
Outbreak Filters Report	441
Outbreak Filters Overview and Rules Listing	441
Outbreak Quarantine	441
Alerts, SNMP Traps, and Outbreak Filters	441
Troubleshooting The Outbreak Filters Feature	442
Reporting Incorrectly Classified Messages to Cisco	442
Multiple Attachments and Bypassed Filetypes	442
Message and Content Filters and the Email Pipeline	442
<hr/>	
<b>CHAPTER 20</b>	<b>Protecting Against Malicious or Undesirable URLs</b> 443
URL-Related Protections and Controls	443
Which URLs Are Evaluated	444
Setting Up URL Filtering	444
Requirements for URL Filtering	444
Enable URL Filtering	445
About the Connection to Talos Intelligence Services	446
Certificates for URL Filtering Features	447
Web Interaction Tracking	447
Configuring Web Interaction Tracking	447
About the Connection to Cisco Aggregator Server	447
URL Filtering in Cluster Configurations	448
Creating Allowed Lists for URL Filtering	448
Importing a URL List	449
Customizing the Notification That End Users See If a Site Is Malicious	449
Taking Action Based on the Reputation or Category of URLs in Messages	450
Using URL-Related Conditions (Rules) and Actions	451
Filtering by URL Reputation or URL Category: Conditions and Rules	451
Modifying URLs in Messages: Using URL Reputation and URL Category Actions in Filters	452
Redirected URLs: What Does the End User Experience?	454
Handling Unscannable Messages for URL Filtering	454
Detecting Malicious URLs in Messages Using Content Filter	455
Detecting Malicious URLs in Messages Using Message Filter	456
Monitoring URL Filtering Results	457

Displaying URL Details in Message Tracking	457
Troubleshooting URL Filtering	458
Viewing Logs	458
Alert: Beaker Connector: Error Fetching Enrollment Certificate	459
Alert: Beaker Connector: Certificate Is Invalid	459
Unable to Connect to Talos Intelligence Services	459
Alert: Unable to Connect to the Cisco Aggregator Server	460
Alert: Unable to Retrieve Web Interaction Tracking Information from the Cisco Aggregator Server	460
Using the websecurityadvancedconfig Command	460
Message Tracking Search Does Not Find Messages with Specified Category	460
Malicious URLs and Marketing Messages Are Not Caught by Anti-Spam or Outbreak Filters	461
URLs in a Filtered Category Are Not Handled Correctly	461
End User Reaches Malicious Site via Rewritten URL	461
Manually Configuring a Certificate for Communication with Talos Intelligence Services	462
About URL Categories	462
URL Category Descriptions	462
Determining the Category of a URL	475
Reporting Uncategorized and Misclassified URLs	475
Future URL Category Set Changes	475
<b>CHAPTER 21</b>	
<b>File Reputation Filtering and File Analysis</b>	<b>477</b>
Overview of File Reputation Filtering and File Analysis	477
File Threat Verdict Updates	477
File Processing Overview	478
Supported Files for File Reputation and Analysis Services	479
Archive or Compressed File Processing	480
Privacy of Information Sent to the Cloud	481
Configuring File Reputation and Analysis Features	481
Requirements for Communication with File Reputation and Analysis Services	481
Configuring an On-premises File Reputation Server	482
Configuring an On-Premises File Analysis Server	482
Enabling and Configuring File Reputation and Analysis Services	483
Integrating the Appliance with AMP for Endpoints Console	487
Important! Changes Needed in File Analysis Setting	489

- (Public Cloud File Analysis Services Only) Configuring Appliance Groups 489
  - Updating Appliance Group Name for File Analysis Reporting 490
  - Which Appliances Are In the Analysis Group? 491
  - Viewing Alerts for File Analysis Grouping 491
- Configuring the Mail Policy for File Reputation Scanning and File Analysis 491
- Quarantining Messages with Attachments Sent for Analysis 494
- Using the File Analysis Quarantine 495
  - Edit File Analysis Quarantine Settings 495
  - Manually Processing Messages in the File Analysis Quarantine 496
- Centralized File Analysis Quarantine 497
- X-Headers for File Reputation and Analysis 497
- Sending Notifications to End Users about Dropped Messages or Attachments 497
- Advanced Malware Protection and Clusters 497
- Ensuring That You Receive Alerts About Advanced Malware Protection Issues 498
- Configuring Centralized Reporting for Advanced Malware Protection Features 498
- File Reputation and File Analysis Reporting and Tracking 499
  - Identifying Files by SHA-256 Hash 499
  - File Reputation and File Analysis Report Pages 499
  - Viewing File Reputation Filtering Data in Other Reports 500
  - About Message Tracking and Advanced Malware Protection Features 500
- Taking Action When File Threat Verdicts Change 501
- Troubleshooting File Reputation and Analysis 501
  - Log Files 502
  - Using Trace 502
  - Several Alerts About Failure to Connect to File Reputation or File Analysis Servers 502
  - API Key Error (On-Premises File Analysis) 503
  - API Key Error (Public Cloud File Analysis) 503
  - Files are Not Uploaded As Expected 504
  - Alerts about File Types That Can Be Sent for Analysis 504

---

**CHAPTER 22**

**Data Loss Prevention 505**

- Overview of Data Loss Prevention 505
  - Overview of the DLP Scanning Process 505
  - How Data Loss Prevention Works 506



System Requirements for Data Loss Prevention	507
How to Set Up Data Loss Prevention	507
Enabling Data Loss Prevention (DLP)	508
Policies for Data Loss Prevention	508
DLP Policy Description	509
Predefined DLP Policy Templates	509
Setting Up DLP Prevention Using a Wizard	509
Creating a DLP Policy Using a Predefined Template	511
Creating a Custom DLP Policy (Advanced)	512
About Defining Disallowed Content Using Content Matching Classifiers	513
Content Matching Classifier Examples	514
Creating a Content Matching Classifier for Custom DLP Policies	515
Classifier Detection Rules for Identifying Sensitive Content (Custom DLP Policies Only)	516
Regular Expressions for Identifying Identification Numbers	517
Using Custom Dictionaries of Sensitive DLP Terms (Custom DLP Policies Only)	518
Determiners of the Risk Factor of a Suspected Violation	520
Using Minimum Score for Entity-based Rules (Custom DLP Policies Only)	522
Viewing the Policies in Which Custom Content Classifiers are Used	523
Filtering Messages for DLP Policies	523
About Assessing Violation Severity	524
Adjusting the Severity Scale	524
Arranging the Order of the Email DLP Policies for Violation Matching	525
Associating DLP Policies with Outgoing Mail Policies	525
Associating DLP Policies with the Default Outgoing Mail Policy	525
Using Outgoing Mail Policies to Assign DLP Policies to Senders and Recipients	525
Important Information About Editing or Deleting DLP Policies	526
Message Actions	526
Defining Actions to Take for DLP Violations (Message Actions)	527
Viewing and Editing Message Actions	528
Drafting DLP Notifications	529
DLP Notification Template Variable Definitions	530
Displaying Sensitive DLP Data in Message Tracking	531
About Updating the DLP Engine and Content Matching Classifiers	532
Determining the Current Version of the DLP Engine	532

- Updating the DLP Engine and Content Matching Classifiers Manually 532
- Enabling Automatic Updates (Not Recommended) 533
- DLP Updates on Centralized (Clustered) Email Gateways 533
- Working with DLP Incident Messages and Data 533
- Troubleshooting Data Loss Prevention 534
  - DLP Fails to Detect Violations in Email Attachments 534

---

**CHAPTER 23**

**Cisco Email Encryption 535**

- Overview of Cisco Email Encryption 535
- How to Encrypt Messages with Cisco Secure Email Encryption Service 536
  - Encryption Workflow 536
- Encrypting Messages using the Email Gateway 537
  - Enabling Message Encryption on the Email Gateway 538
  - Configuring How the Key Service Handles Encrypted Messages 538
  - Configuring the Default Locale of the Envelope 541
  - Updating to the Latest Version of the PXE Engine 542
- Determining Which Messages to Encrypt 542
  - Using a TLS Connection as an Alternative to Encryption 542
  - Encrypting and Immediately Delivering Messages using a Content Filter 543
  - Encrypting a Message upon Delivery using a Content Filter 544
- Inserting Encryption Headers into Messages 545
  - Encryption Headers 546
  - Encryption Headers Examples 547
    - Enabling Envelope Key Caching for Offline Opening 548
    - Enabling JavaScript-Free Envelopes 548
    - Enabling Message Expiration 548
    - Disabling the Decryption Applet 548

---

**CHAPTER 24**

**S/MIME Security Services 549**

- Overview of S/MIME Security Services 549
- S/MIME Security Services in Email Gateway 549
  - Understanding How S/MIME Security Services Works 550
    - Scenario: Business-to-Business 550
    - Scenario: Business-to-Consumer 552

Signing, Encrypting, or Signing and Encrypting Outgoing Messages using S/MIME	553
S/MIME Signing and Encryption Workflow in Email Gateway	553
S/MIME Signing Workflow	553
S/MIME Encryption Workflow	553
How to Sign, Encrypt, or Sign and Encrypt Outgoing Messages using S/MIME	554
Setting Up Certificates for S/MIME Signing	555
Creating a Self-Signed S/MIME Certificate	555
Importing an S/MIME Signing Certificate	556
Setting Up Public Keys for S/MIME Encryption	557
Adding a Public Key for S/MIME Encryption	557
S/MIME Harvested Public Keys	558
Harvesting Public Keys	558
Managing S/MIME Sending Profiles	559
Create an S/MIME Sending Profile for Signing, Encrypting, or Signing and Encrypting Messages	560
Edit an S/MIME Sending Profile	561
Determining Which Messages to Sign, Encrypt, or Sign and Encrypt	561
Signing, Encrypting, or Signing and Encrypting and Immediately Delivering Messages using a Content Filter	562
Signing, Encrypting, or Signing and Encrypting a Message upon Delivery using a Content Filter	562
Verifying, Decrypting, or Decrypting and Verifying Incoming Messages using S/MIME	563
S/MIME Verification and Decryption Workflow in Email Gateway	563
S/MIME Verification Workflow	564
S/MIME Decryption Workflow	564
How to Verify, Decrypt, or Decrypt and Verify Incoming Messages Using S/MIME	564
Setting Up Certificates for Decrypting Messages	565
Setting Up Public Keys for Verifying Signed Messages	566
Adding a Public Key for S/MIME Verification	566
Harvesting Public Keys for S/MIME Verification	566
Enabling Public Key Harvesting	567
Adding a Harvested Public Key for S/MIME Verification	567
Enabling S/MIME Decryption and Verification	568
Configuring an Action for S/MIME Decrypted or Verified Message	568
S/MIME Certificate Requirements	569

Certificate Requirements for Signing	569
Certificate Requirements for Encryption	570
Managing Public Keys	570
Adding a Public Key	571
Importing Public Keys from an Existing Export File	571
Exporting Public Keys	572

---

**CHAPTER 25**
**Remediating Messages in Mailboxes 573**

Overview	573
Workflow	574
How the Email Gateway Performs Auto-Remedial Actions	575
Performing Remedial Actions on Messages in Mailboxes	576
Performing Remedial Actions on Messages in Microsoft Exchange Online Mailboxes	577
How to Configure Remedial Action on Messages in Microsoft Exchange Online Mailboxes	577
Performing Remedial Actions on Messages in Microsoft Exchange On-Premise Mailboxes	579
How to Configure Remedial Actions on Messages in Microsoft Exchange On-Premise Mailboxes	579
Performing Remedial Actions on Messages in Mailboxes on Hybrid Deployment	580
How to Perform Remedial Actions on Messages in Mailboxes on Hybrid Deployment	580
Configuring Mailbox Remediation on Email Gateway	582
Prerequisites	582
Prerequisites for Remediating Messages in Microsoft Exchange Online Mailboxes	582
Prerequisites for Remediating Messages in an On-Premise Account	583
Registering Your Email Gateway as an Application on Azure AD	584
Enabling Account Settings on Email Gateway	586
Creating an Account Profile	587
Creating a Chained Profile	588
Mapping Domains to the Account Profile	589
Configure Auto-Remedial Actions on Messages in the Mailboxes	590
Search and Remediate Messages in the Mailboxes	590
Upgrading to AsyncOS 13.0 and Later Releases	592
Monitoring Mailbox Remediation Results	592
Viewing Mailbox Remediation Details in Message Tracking	592
Troubleshooting Mailbox Remediation	592

Connection Errors	593
Viewing Logs	594
Alerts	595
Configured Remedial Actions Are Not Performed	595

---

**CHAPTER 26**
**Email Authentication 597**

Email Authentication Overview	597
DomainKeys and DKIM Authentication	597
DomainKeys and DKIM Authentication Workflow	598
DomainKeys and DKIM Signing in AsyncOS	598
Configuring DomainKeys and DKIM Signing	599
Signing Keys	600
Exporting and Importing Signing Keys	600
Public Keys	600
Domain Profiles	601
Exporting and Importing Domain Profiles	602
Enabling Signing for Outgoing Mail	602
Enabling Signing for Bounce and Delay Messages	602
Configuring DomainKeys/DKIM Signing (GUI)	603
Creating Domain Profiles for DomainKeys Signing	604
Creating a New Domain Profile for DKIM Signing	604
Creating or Editing a Signing Key	606
Exporting Signing Keys	607
Importing or Entering Existing Signing Keys	607
Deleting Signing Keys	608
Generating a DNS Text Record	609
Testing Domain Profiles	609
Exporting Domain Profiles	610
Importing Domain Profiles	610
Deleting Domain Profiles	610
Searching Domain Profiles	611
Editing DKIM Global Settings	611
Domain Keys and Logging	612
How to Verify Incoming Messages Using DKIM	612

DKIM Verification Checks Performed by AsyncOS	613
Managing DKIM Verification Profiles	613
Creating a DKIM Verification Profile	614
Exporting DKIM Verification Profiles	615
Importing DKIM Verification Profiles	615
Deleting DKIM Verification Profiles	615
Searching DKIM Verification Profiles	616
Configuring DKIM Verification on the Mail Flow Policy	616
DKIM Verification and Logging	617
Configuring an Action for DKIM Verified Mail	617
Overview of SPF and SIDF Verification	618
A Note About Valid SPF Records	618
Valid SPF Records	619
Valid SIDF Records	619
Testing Your SPF Records	619
How to Verify Incoming Messages Using SPF/SIDF	619
Enabling SPF and SIDF	620
Enabling SPF and SIDF via the CLI	621
The Received-SPF Header	623
Determining the Action to Take for SPF/SIDF Verified Mail	624
Verification Results	625
Using the spf-status Filter Rule in the CLI	625
spf-status Content Filter Rule in the GUI	626
Using the spf-passed Filter Rule	627
Testing the SPF/SIDF Results	627
Basic Granularity Test of SPF/SIDF Results	627
Greater Granularity Test of SPF/SIDF Results	628
DMARC Verification	628
DMARC Verification Workflow	629
How to Verify Incoming Messages Using DMARC	629
Managing DMARC Verification Profiles	630
Configure Global DMARC Settings	633
Configuring DMARC Verification on the Mail Flow Policy	634
Configure a Return Address for DMARC Feedback Reports	634

DMARC Aggregate Reports	635
Forged Email Detection	636
Setting Up Forged Email Detection	636
Monitoring Forged Email Detection Results	637
Displaying Forged Email Detection Details in Message Tracking	638

---

**CHAPTER 27**
**Text Resources 639**

Overview of Text Resources	639
Content Dictionaries	639
Text Resources	640
Message Disclaimer Stamping	640
Content Dictionaries	640
Dictionary Content	641
Word Boundaries and Double-byte Character Sets	642
Importing and Exporting Dictionaries as Text Files	642
Adding Dictionaries	643
Deleting Dictionaries	644
Importing Dictionaries	644
Exporting Dictionaries	645
Using and Testing the Content Dictionaries Filter Rules	645
Dictionary Match Filter Rule	645
Example Dictionary Entries	646
Testing Content Dictionaries	646
Understanding Text Resources	647
Importing and Exporting Text Resources as Text Files	647
Overview of Text Resource Management	648
Adding Text Resources	648
Deleting Text Resources	648
Importing Text Resources	649
Exporting Text Resources	649
Overview of HTML-Based Text Resources	650
Importing and Exporting HTML-Based Text Resources	650
Using Text Resources	651
Disclaimer Template	651

- Adding Disclaimer Text via a Listener 652
- Adding Disclaimers via Filters 652
- Disclaimers and Filter Action Variables 652
- Disclaimer Stamping and Multiple Encodings 654
- Notification Templates 656
- Anti-Virus Notification Templates 657
  - Custom Anti-Virus Notification Templates 657
- Bounce and Encryption Failure Notification Templates 659
  - Bounce and Encryption Failure Notification Variables 660
- Encryption Notification Templates 660

---

**CHAPTER 28**

- Validating Recipients Using an SMTP Server 663**
  - Overview of SMTP Call-Ahead Recipient Validation 663
  - SMTP Call-Ahead Recipient Validation Workflow 663
  - How to Validate Recipients Using an External SMTP Server 665
    - Configuring the Call-Ahead Server Profile 665
      - SMTP Call-Ahead Server Profile Settings 666
      - Call Ahead Server Responses 668
  - Enabling a Listener to Validate Incoming Mail Via the SMTP Server 668
  - Configuring LDAP Routing Query Settings 669
  - SMTP Call-Ahead Query Routing 669
  - Bypassing SMTP Call-Ahead Validation for Certain Users or Groups 670

---

**CHAPTER 29**

- Encrypting Communication with Other MTAs 671**
  - Overview of Encrypting Communication with Other MTAs 671
    - How to Encrypt SMTP Conversations using TLS 671
  - Working with Certificates 672
    - Deploying a Signed Certificate 673
    - Deploying Self-Signed Certificates 673
      - Certificates and Centralized Management 674
      - Intermediate Certificates 674
      - Creating a Self-Signed Certificate 674
    - About Sending a Certificate Signing Request (CSR) to a Certificate Authority 675
    - Uploading a Certificate Signed by a Certificate Authority 676



Importing a Certificate	676
Exporting a Certificate	677
Enabling TLS on a Listener's HAT	677
Assigning a Certificate to a Public or Private Listener for TLS Connections Using the GUI	678
Assigning a Certificate to a Public or Private Listener for TLS Connections Using the CLI	679
Logging	679
GUI Example: Changing the TLS setting for Listeners HAT	679
CLI Example: Changing the TLS Setting for Listeners HAT	679
Enabling TLS and Certificate Verification on Delivery	680
Sending Alerts When a Required TLS Connection Fails	682
Enabling TLS Connection Alerts	683
Logging	683
DNS-based Authentication of Named Entities	683
Overview of SMTP DNS-based Authentication of Named Entities	684
SMTP DANE Workflow	684
Creating TLSA Record	685
Enabling TLS for Delivery with DANE Support	686
Sending Alerts When DANE Fails	687
Enabling DANE Alerts	687
Managing Lists of Certificate Authorities	687
Viewing the Pre-Installed list of Certificate Authorities	688
Disabling the System Certificate Authority List	688
Importing a Custom Certificate Authority List	689
Exporting a Certificate Authorities List	689
Certificate Updates	690
Managing Trusted Root Certificates	690
Enabling a Certificate for HTTPS	690

---

**CHAPTER 30**
**Configuring Routing and Delivery Features** 693

Routing Email for Local Domains	693
SMTP Routes Overview	694
Default SMTP Route	694
Defining an SMTP Route	695
SMTP Routes Limits	695

SMTP Routes and DNS	695
SMTP Routes and Alerts	696
SMTP Routes, Mail Delivery, and Message Splintering	696
SMTP Routes and Outbound SMTP Authentication	696
Managing SMTP Routes to Send Outbound Email Using the GUI	696
Adding SMTP Routes	696
Exporting SMTP Routes	697
Importing SMTP Routes	697
Rewriting Addresses	698
Creating Alias Tables	699
Configuring an Alias Table from the Command Line	699
Exporting and Importing an Alias Table	700
Deleting Entries from the Alias Table	701
Example Alias Table	701
Example aliasconfig Command	703
Configuring Masquerading	706
Masquerading and altsrhost	707
Configuring Static Masquerading Tables	707
Sample Masquerading Table for a Private Listener	708
Importing a Masquerading Table	709
Example Masquerading	709
The Domain Map Feature	716
Importing and Exporting a Domain Map Table	721
Directing Bounced Email	722
Handling Undeliverable Email	723
Notes on Soft and Hard Bounces	723
Bounce Profile Parameters	724
Hard Bounces and the status Command	727
Conversational Bounces and SMTP Routes Message Filter actions	727
Example Bounce Profiles	727
Delivery Status Notification Format	728
Delay Warning Messages	728
Delay Warning Messages and Hard Bounces	728
Creating a New Bounce Profile	729

Editing the Default Bounce Profile	729
Example of a Minimalist Bounce Profile	729
Applying Bounce Profiles to Listeners	729
Controlling Email Delivery Using Destination Controls	730
Rate Limiting	731
TLS	731
Bounce Verification	731
Bounce Profile	731
Determining Which Interface is Used for Mail Delivery	731
Default Delivery Limits	732
Working with Destination Controls	732
Controlling the Version of Internet Protocol Addresses	732
Controlling the Number of Connections, Messages, and Recipients to a Domain	732
Controlling TLS	734
Controlling Bounce Verification Tagging	735
Controlling Bounces	735
Adding a New Destination Control Entry	735
Importing and Exporting Destination Control Configurations	735
Destination Controls and the CLI	738
Bounce Verification	739
Overview: Tagging and Bounce Verification	739
Handling Incoming Bounce Messages	740
Bounce Verification Address Tagging Keys	740
Accepting Legitimate Untagged Bounced Messages	740
Preventing a Bounced Message Storm Using Bounce Verification	741
Configuring Bounce Verification Address Tagging Keys	741
Configuring Bounce Verification Settings	742
Configuring Bounce Verification Using the CLI	742
Bounce Verification and Cluster Configuration	742
Set Email Delivery Parameters	742
Default Delivery IP Interface	743
Possible Delivery Feature	743
Default Maximum Concurrency	743
deliveryconfig Example	744

Configuring Mail Gateways for all Hosted Domains Using Virtual Gateway™ Technology	745
Overview	746
Setting Up Virtual Gateway Addresses	746
Creating New IP Interfaces for Use with Virtual Gateways	747
Mapping Messages to IP Interfaces for Delivery	749
Importing an altsrhost File	750
altsrhost Limits	750
Example Text File with Valid Mappings for the altsrhost Command	750
Adding an altsrhost Mapping through the CLI	751
Monitoring the Virtual Gateway Addresses	753
Managing Delivery Connections per Virtual Gateway Address	753
Using Global Unsubscribe	754
Adding a Global Unsubscribe Address Using The CLI	755
Exporting and Importing a Global Unsubscribe File	756
Review: Email Pipeline	757
<hr/>	
<b>CHAPTER 31</b>	<b>Integrating the Email Gateway with Cisco Advanced Phishing Protection</b>
	761
Overview of Cisco Advanced Phishing Protection	761
Benefits of Cisco Advanced Phishing Protection	762
Workflow	762
How to Integrate Email Gateway with the Cisco Advanced Phishing Protection Cloud Service	762
Prerequisites	763
Activating the Account for Cisco Advanced Phishing Protection Cloud Service	763
Installing Sensors on the Cisco Advanced Phishing Protection Cloud Service	763
Obtaining the Provisioning Key from the Cisco Advanced Phishing Protection Cloud Service	764
Registering the Cisco Advanced Phishing Protection Sensor on the Email Gateway	764
Enabling Advanced Phishing Protection on the Email Gateway	765
Obtaining API Access Keys from Cisco Advanced Phishing Protection Cloud Service	766
Configuring Incoming Mail Policies to Enable Forwarding of Message Metadata	767
Monitoring Message Metadata on the Cisco Advanced Phishing Protection Cloud Service	768
Advanced Phishing Protection and Clusters	769
Advanced Phishing Protection Report Page	769
Monitoring Message Metadata on the Cisco Advanced Phishing Protection Cloud Service	770
Displaying Messages Submitted to the Cisco Advanced Phishing Protection Cloud Service	770

---

**CHAPTER 32****LDAP Queries 771**

- Overview of LDAP Queries 771
  - Understanding LDAP Queries 772
  - Understanding How LDAP Works with AsyncOS 773
  - Configuring the Email Gateway to Work with an LDAP Server 774
  - Creating LDAP Server Profiles to Store Information About the LDAP Server 774
  - Testing LDAP Servers 776
  - Enabling LDAP Queries to Run on a Particular Listener 776
    - Configuring Global Settings for LDAP Queries 777
    - Example of Creating an LDAP Server Profile 777
    - Enabling LDAP Queries on a Public Listener 778
    - Enabling LDAP Queries on a Private Listener 779
  - Enhanced Support for Microsoft Exchange 5.5 779
- Working with LDAP Queries 781
  - Types of LDAP Queries 781
  - Base Distinguishing Name (DN) 782
  - LDAP Query Syntax 782
    - Tokens: 782
  - Secure LDAP (SSL) 783
  - Routing Queries 783
  - Allowing Clients to Bind to the LDAP Server Anonymously 783
    - Anonymous Authentication Setup 784
    - Anonymous Bind Setup for Active Directory 785
    - Notes for Active Directory Implementations 786
  - Testing LDAP Queries 786
  - Troubleshooting Connections to LDAP Servers 787
  - Using Acceptance Queries For Recipient Validation 788
    - Sample Acceptance Queries 788
    - Configuring Acceptance Queries for Lotus Notes 789
  - Using Routing Queries to Send Mail to Multiple Target Addresses 789
    - Sample Routing Queries 789
      - Routing: MAILHOST and MAILROUTINGADDRESS 790
  - Using Masquerading Queries to Rewrite the Envelope Sender 790

Sample Masquerading Queries	791
Masquerading “Friendly Names”	791
Using Group LDAP Queries to Determine if a Recipient is a Group Member	792
Sample Group Queries	792
Configuring a Group Query	793
Example: Using a Group Query to Skip Spam and Virus Checking	794
Using Domain-based Queries to Route to a Particular Domain	795
Creating a Domain-Based Query	796
Using Chain Queries to Perform a Series of LDAP Queries	797
Creating a Chain Query	797
Using LDAP For Directory Harvest Attack Prevention	798
Directory Harvest Attack Prevention within the SMTP Conversation	798
Directory Harvest Attack Prevention within the Work Queue	799
Configuring Directory Harvest Prevention in the Work Queue	800
Configuring AsyncOS for SMTP Authentication	800
Configuring SMTP Authentication	801
Specifying a Passphrase as Attribute	801
Configuring an SMTP Authentication Query	802
SMTP Authentication via Second SMTP Server (SMTP Auth with Forwarding)	803
SMTP Authentication with LDAP	803
Enabling SMTP Authentication on a Listener	804
Authenticating SMTP Sessions Using Client Certificates	807
Outgoing SMTP Authentication	807
Logging and SMTP Authentication	808
Configuring External LDAP Authentication for Users	808
User Accounts Query	809
Group Membership Queries	809
Authenticating End-Users of the Spam Quarantine	811
Sample Active Directory End-User Authentication Settings	811
Sample OpenLDAP End-User Authentication Settings	812
Spam Quarantine Alias Consolidation Queries	812
Sample Active Directory Alias Consolidation Settings	813
Sample OpenLDAP Alias Consolidation Settings	813
Sample User Distinguished Name Settings	814

Configuring AsyncOS To Work With Multiple LDAP Servers	814
Testing Servers and Queries	815
Failover	815
Configuring the Email Gateway for LDAP Failover	815
Load Balancing	816
Configuring the Email Gateway for Load Balancing	816

**CHAPTER 33**

<b>Authenticating SMTP Sessions Using Client Certificates</b>	<b>819</b>
Overview of Certificates and SMTP Authentication	819
How to Authenticate a User with a Client Certificate	820
How to Authenticate a User with an SMTP Authentication LDAP Query	820
How to Authenticate a User with an LDAP SMTP Authentication Query if the Client Certificate is Invalid	821
Checking the Validity of a Client Certificate	821
Authenticating a User Using an LDAP Directory	822
Authenticating an SMTP Connection Over TLS Using a Client Certificate	823
Establishing a TLS Connection from the Email Gateway	823
Updating a List of Revoked Certificates	824
Authenticating a User's SMTP Session With a Client Certificate	825
Authenticating a User's SMTP Session with the SMTP AUTH Command	825
Authenticating a User's SMTP Session with Either a Client Certificate or SMTP AUTH	826

**CHAPTER 34**

<b>Using Email Security Monitor</b>	<b>829</b>
Email Security Monitor Overview	829
Email Security Monitor and Centralized Management	830
Email Security Monitor Pages	830
Searching and Email Security Monitor	832
Viewing Details of Messages Included in Reports	832
My Dashboard Page	833
Overview Page	834
System Overview	834
Incoming and Outgoing Summary and Graph	835
Categorizing Email	836
How Messages are Categorized	837

Incoming Mail Page	837
Incoming Mail	838
Incoming Mail Details Listing	839
Reporting Pages Populated with Data: Sender Profile Pages	841
Sender Groups Report	842
Sender Domain Reputation Page	843
Outgoing Destinations	843
Outgoing Senders	843
Geo Distribution Page	844
Delivery Status Page	844
Retrying Delivery	845
Delivery Status Details Page	845
Internal Users Page	845
Internal User Details	846
Searching for a Specific Internal User	846
DLP Incidents Page	846
DLP Incidents Details	847
DLP Policy Detail Page	847
Content Filters Page	848
Content Filter Details	848
DMARC Verification Page	848
Macro Detection Page	848
External Threat Feeds Page	849
Outbreak Filters Page	849
Virus Types Page	851
URL Filtering Page	851
Web Interaction Tracking Page	852
Forged Email Matches Report	853
File Reputation and File Analysis Reports	853
Mailbox Auto Remediation Report	853
TLS Connections Page	853
Inbound SMTP Authentication Page	854
Rate Limits Page	855
System Capacity Page	855



System Capacity- Workqueue	856
System Capacity- Incoming Mail	857
System Capacity-Outgoing Mail	857
System Capacity-System Load	857
Note about Memory Page Swapping	858
System Capacity- All	858
System Status Page	858
System Status	859
Gauges	859
Rates	859
Counters	860
High Volume Mail Page	860
Message Filters Page	860
Safe Print Page	861
Retrieving CSV Data	861
Retrieving CSV Data Via Automated Processes	861
Email Security Monitor Pages on the New Web Interface	863
Searching and the Interactive Email Report Pages	865
Viewing Details of Messages Included in Reports	865
Time Range for Reports	866
My Favorite Reports Page	866
Modules That Cannot Be Added to the My Reports Page	867
Adding Reports on the My Favorite Reports Page	868
Mail Flow Summary Page	868
How Email Messages Are Categorized by the Email Gateways	871
Incoming and Outgoing Summary and Graph	871
Categorizing Email Messages on the Mail Flow Summary Page	872
Using Counters to Filter Data on the Trend Graphs	874
System Capacity Page	874
System Capacity- Workqueue	875
System Capacity- Incoming Mail	875
System Capacity-Outgoing Mail	875
System Capacity-System Load	876
Note about Memory Page Swapping	876

System Capacity- All	877
Reporting Data Availability	877
Advanced Malware Protection Page	877
Advanced Malware Protection – Summary	878
Advanced Malware Protection – AMP Reputation	878
Advanced Malware Protection – File Analysis	879
Advanced Malware Protection – File Retrospection	880
Advanced Malware Protection – Mailbox Auto Remediation	880
Identifying Files by SHA-256 Hash	881
Viewing File Reputation Filtering Data in Other Reports	881
Virus Filtering Page	881
Macro Detection Page	882
DMARC Verification Page	882
URL Filtering Page	883
Outbreak Filtering Page	883
Forged Email Detection Page	885
Sender Domain Reputation Page	885
External Threat Feeds Page	886
Mail Flow Details Page	886
Views Within the Mail Flow Details Page	887
Incoming Mails Table	889
Sender Profile Pages	892
Sender Details Table	893
Sender Groups Report	894
Outgoing Destinations	894
TLS Encryption Page	894
Inbound SMTP Authentication Page	895
Rate Limits Page	896
Connections by Country Page	896
User Mail Summary Page	897
User Mail Flow Details	898
Searching for a Specific Internal User	898
DLP Incident Summary Page	898
DLP Incident Details	899

DLP Policy Detail Page	899
Web Interaction Page	899
Remediation Report Page	901
Message Filters Page	902
High Volume Mail Page	902
Content Filters Page	903
Content Filter Details	903
Safe Print Page	903
Advanced Phishing Protection Report Page	903
Mail Policy Details Report Page	904
Reporting Overview	904
Scheduled or Archived Report Types	905
Notes on Reports	906
Setting the Return Address for Reports	906
Managing Reports	906
Scheduled Reports	906
Scheduling a Report to be Generated Automatically	907
Editing Scheduled Reports	907
Deleting Scheduled Reports	908
Archived Reports	908
Generating On-Demand Reports	908
Troubleshooting Email Reports	909
Link to Message Tracking Gives Unexpected Results	909
File Analysis Details in the Cloud Are Incomplete	909

---

**CHAPTER 35**
**Tracking Messages 911**

Message Tracking Overview	911
Enabling Message Tracking	911
Searching for Messages on the Legacy Interface	912
Searching for Email Messages on the New Web Interface	915
Working with Message Tracking Search Results	917
Message Tracking Details	918
Checking Message Tracking Data Availability	920
About Message Tracking and Upgrades	921

Troubleshooting Message Tracking 921

- Attachments Do Not Appear in Search Results 921
- Expected Messages Are Missing from Search Results 921

**CHAPTER 36**

**Policy, Virus, and Outbreak Quarantines 923**

- Overview of Policy, Virus, and Outbreak Quarantines 923
  - Quarantine Types 924
- Managing Policy, Virus, and Outbreak Quarantines 925
  - Disk Space Allocation for Policy, Virus, and Outbreak Quarantines 925
  - Retention Time for Messages in Quarantines 926
  - Default Actions for Automatically Processed Quarantined Messages 927
  - Checking the Settings of System-Created Quarantines 927
  - Configuring Policy, Virus, and Outbreak Quarantines 927
  - About Editing Policy, Virus, and Outbreak Quarantine Settings 929
  - Determining the Filters and Message Actions to Which a Policy Quarantine Is Assigned 929
  - About Deleting Policy Quarantines 930
  - Monitoring Quarantine Status, Capacity, and Activity 930
  - Policy Quarantine Performance 931
  - Alerts About Quarantine Disk-Space Usage 932
  - Policy Quarantines and Logging 932
  - About Distributing Message Processing Tasks to Other Users 932
    - Which User Groups Can Access Policy, Virus, and Outbreak Quarantines 932
  - About Policy, Virus, and Outbreak Quarantines in Cluster Configurations 933
  - About Centralized Policy, Virus, and Outbreak Quarantines 933
- Working with Messages in Policy, Virus, or Outbreak Quarantines 933
  - Viewing Messages in Quarantines 934
    - Quarantined Messages and International Character Sets 934
  - Finding Messages in Policy, Virus, and Outbreak Quarantines 934
  - Manually Processing Messages in a Quarantine 935
    - Sending a Copy of the Message 936
    - About Moving Messages Between Policy Quarantines 936
  - Messages in Multiple Quarantines 937
  - Message Details and Viewing Message Content 937
    - Viewing Matched Content 938

Downloading Attachments	939
Testing for Viruses	939
About Rescanning of Quarantined Messages	939
The Outbreak Quarantine	940
Rescanning Messages in an Outbreak Quarantine	940
Manage by Rule Summary Link	941
Reporting False Positives or Suspicious Messages to Cisco Systems	941

---

**CHAPTER 37**
**Spam Quarantine 943**

Overview of the Spam Quarantine	943
Local Versus External Spam Quarantine	943
Setting Up the Local Spam Quarantine	944
Enabling and Configuring the Spam Quarantine on the Legacy Web Interface	945
Configuring the IP Interface for Browser Access to the Spam Quarantine	946
Configuring Administrative User Access to the Spam Quarantine	947
Configuring a Mail Policy to Quarantine Spam	948
Limiting Which Recipients Have Mail Quarantined	948
Ensuring That Message Text Displays Correctly	948
Specifying a Default Encoding	948
Spam Quarantine Language	949
Using Safelists and Blocklists to Control Email Delivery Based on Sender	949
Message Processing of Safelists and Blocklists	949
Enabling Safelists and Blocklists on the Legacy Web Interface	950
External Spam Quarantine and Safelist/Blocklists	951
Adding Senders and Domains to Safelists and Blocklists (Administrators)	951
Syntax for Safelists and Blocklist Entries	955
Clearing All Safelists and Blocklists	956
About End-User Access to Safelists and Blocklists	956
Adding Entries to Safelists (End Users)	956
Adding Senders to Blocklists (End Users)	957
Synchronizing Safelists or Blocklists on Multiple Email Gateways (Deployments Without a Cisco Secure Email and Web Manager)	958
Backing Up and Restoring the Safelist/Blocklist	958
Troubleshooting Safelists and Blocklists	959

- Message from Safelisted Sender Was Not Delivered 959
- Configuring Spam Management Features for End Users 960
  - Authentication Options for End Users Accessing Spam Management Features 960
    - LDAP Authentication Process 961
    - IMAP/POP Authentication Process 961
  - Setting Up End-User Access to the Spam Quarantine via Web Browser 962
    - Configuring End-User Access to the Spam Quarantine 962
    - Determining the URL for End-User Access to the Spam Quarantine 963
    - Which Messages an End User Sees 964
  - Notifying End Users About Quarantined Messages 964
    - Recipient Email Mailing List Aliases and Spam Notifications 967
    - Testing Notifications 967
    - Troubleshooting Spam Notifications 967
- Managing Messages in the Spam Quarantine 968
  - Accessing the Spam Quarantine (Administrative Users) 968
  - Searching for Messages in the Spam Quarantine 969
    - Searching Very Large Message Collections 969
  - Viewing Messages in the Spam Quarantine 969
  - Delivering Messages in the Spam Quarantine 970
  - Deleting Messages from the Spam Quarantine 970
- Disk Space for the Spam Quarantine 970
- About Disabling the External Spam Quarantine 971
- Troubleshooting Spam Quarantine Features 971

---

**CHAPTER 38**

- Distributing Administrative Tasks 973**
  - Working with User Accounts 973
    - User Roles 974
    - Managing Users 975
      - Adding Users 976
      - Editing Users 976
      - Force Users To Change Their Passphrases 977
      - Deleting Users 977
    - Controlling Access to Sensitive Information in Message Tracking 977
  - Managing Custom User Roles for Delegated Administration 978

Account Privileges Page	979
Assigning Access Privileges	980
Mail Policies and Content Filters	980
DLP Policies	981
Email Reporting	982
Message Tracking	983
Trace	983
Quarantines	983
Encryption Profiles	983
Log Subscription	984
Defining a Custom User Role	984
Defining a Custom User Role When Adding a User Account	984
Updating Responsibilities for a Custom User Role	985
Editing a Custom User Role	985
Duplicating a Custom User Role	985
Deleting a Custom User Role	986
Passphrases	986
Changing Your Passphrase	986
Locking and Unlocking a User Account	987
Configuring Restrictive User Account and Passphrase Settings	987
External Authentication	988
Enabling LDAP Authentication	988
Enabling RADIUS Authentication	989
Enable SAML Authentication	991
Two-Factor Authentication	992
Enabling Two-Factor Authentication	992
Disabling Two-Factor Authentication	993
Configuring Access to the Email Gateway	993
Configuring IP-Based Network Access	993
Direct Connections	993
Connecting Through a Proxy	994
Important Precautions When Restricting Network Access	994
Creating the Access List	994
Configuring Session Timeouts	996

- Configuring the Web UI Session Timeout 996
- Configuring the CLI Session Timeout 996
- Displaying Messages to Administrative Users 997
  - Displaying a Message Before Login 997
  - Displaying a Message After Login 997
- Managing Secure Shell (SSH) Keys 997
  - Example: Install a New Public Key 998
  - Example: Edit SSH Server Configuration 998
  - Remote SSH Command Execution 1000
- Monitoring Administrative User Access 1000

**CHAPTER 39**

**System Administration 1001**

- Management of the Email Gateway 1002
  - Shutting Down or Rebooting the Email Gateway 1002
  - Suspending Email Receiving and Delivery 1002
  - Resuming Suspended Email Receiving and Delivery 1003
  - Resetting to Factory Defaults 1003
    - Next Steps 1004
  - Displaying the Version Information for AsyncOS 1004
- Email Gateway Licensing 1004
  - Feature Keys 1004
    - Adding and Managing Feature Keys 1004
    - Automating Feature Key Download and Activation 1005
    - Expired Feature Keys 1006
  - Smart Software Licensing 1006
    - Overview 1006
    - Enabling Smart Software Licensing 1009
    - Registering the Email Gateway with Cisco Smart Software Manager 1010
    - Requesting for Licenses 1011
    - Deregistering the Email Gateway from Smart Cisco Software Manager 1011
    - Reregistering the Email Gateway with Smart Cisco Software Manager 1012
    - Changing Transport Settings 1012
    - Renewing Authorization and Certificate 1012
    - Reserving Feature Licenses 1013



Alerts	1018
Updating Smart Agent	1019
Smart Licensing in Cluster Mode	1019
Virtual Email Gateway License	1020
Virtual Email Gateway License Expiration	1020
Managing the Configuration File	1021
Managing Multiple Email Gateways with XML Configuration Files	1021
Managing Configuration Files	1021
Saving and Exporting the Current Configuration File	1022
Mailing the Configuration File	1022
Loading a Configuration File	1023
Resetting the Current Configuration	1025
Viewing the Configuration File	1025
Configuration File Page	1026
Managing Disk Space	1026
(Virtual Email Gateways Only) Increasing Available Disk Space	1026
Viewing and Allocating Disk Space Usage	1027
Managing Disk Space for the Miscellaneous Quota	1027
Ensuring That You Receive Alerts About Disk Space	1027
Disk Space and Centralized Management	1028
Managing Security Services	1028
Manually Updating the Engines	1028
Rollback to Previous Version of Engine	1029
Viewing Logs	1029
Service Updates	1029
Setting Up to Obtain Upgrades and Updates	1030
Options for Distributing Upgrades and Updates	1030
Configuring Your Network to Download Upgrades and Updates from the Cisco Servers	1030
Configuring the Email Gateway for Upgrades and Updates in Strict Firewall Environments	1031
Upgrading and Updating from a Local Server	1031
Hardware and Software Requirements for Upgrading and Updating from a Local Server	1032
Hosting an Upgrade Image on a Local Server	1033
Updates Through a Proxy Server	1033
Configuring Server Settings for Downloading Upgrades and Updates	1034

- Configuring Automatic Updates **1036**
- Configuring the Email Gateway to Verify the Validity of Updater Server Certificate **1036**
- Configuring the Appliance to Trust Proxy Server Communication **1037**
- Upgrading AsyncOS **1038**
  - About Upgrading Clustered Systems **1038**
  - About Batch Commands for Upgrade Procedures **1038**
    - Notifications of Available Upgrades **1038**
  - Notifications of Available Upgrades **1039**
  - Preparing to Upgrade AsyncOS **1039**
  - Downloading and Installing the Upgrade **1039**
    - Viewing Status of, Canceling, or Deleting a Background Download **1041**
- Enabling Remote Power Cycling **1042**
- Reverting to a Previous Version of AsyncOS **1043**
  - Reversion Impact **1043**
    - Reverting AsyncOS on Virtual Email Gateways May Impact the License **1043**
  - Reverting AsyncOS **1044**
- Configuring the Return Address for Email Gateway Generated Messages **1044**
- Setting Thresholds for System Health Parameters **1045**
- Checking the Health of Email Gateway **1046**
- Alerts **1047**
  - Alert Severities **1047**
  - AutoSupport **1047**
  - Alert Delivery **1047**
    - Example Alert Message **1048**
  - Adding Alert Recipients **1048**
  - Configuring Alert Settings **1049**
    - Alert Settings **1049**
  - Viewing Recent Alerts **1050**
  - Alert Descriptions **1050**
    - Anti-Spam Alerts **1051**
    - Anti-Virus Alerts **1051**
    - Directory Harvest Attack Prevention (DHAP) Alerts **1052**
    - Hardware Alerts **1052**
    - Spam Quarantine Alerts **1053**

Safelist/Blocklist Alerts	1054
System Alerts	1055
Updater Alerts	1066
Outbreak Filter Alerts	1066
Clustering Alerts	1067
Changing Network Settings	1069
Changing the System Hostname	1070
Configuring Domain Name System (DNS) Settings	1070
Specifying DNS Servers	1070
Multiple Entries and Priority	1070
Using the Internet Root Servers	1071
Reverse DNS Lookup Timeout	1071
DNS Alert	1072
Clearing the DNS Cache	1072
Configuring DNS Settings via the Graphical User Interface	1072
Configuring TCP/IP Traffic Routes	1072
Configuring the Default Gateway	1073
Configuring SSL Settings	1073
Single Sign-On (SSO) Using SAML 2.0	1075
About Single Sign-On (SSO) and SAML 2.0	1075
SAML 2.0 SSO Workflow	1075
Guidelines and Limitations for SAML 2.0	1076
General	1076
Logout	1077
Limitations	1077
How to Configure SSO on your Email Gateway	1077
Prerequisites	1077
Configuring Email Gateway as a Service Provider	1078
Configuring the Identity Provider to Communicate with Email Gateway	1081
Configure Identity Provider Settings on Email Gateway	1083
Configuring OpenID Connect 1.0 on Email Gateway for AsyncOS APIs	1084
Overview	1084
Workflow	1085
Sample Access Token	1085

- Prerequisites **1086**
- Configuring OpenID Connect on Email Gateway **1086**
- System Time **1087**
  - Selecting a Time Zone **1087**
    - Selecting a GMT Offset **1088**
  - Editing Time Settings **1088**
    - (Recommended) Setting Email Gateway System Time Using the Network Time Protocol (NTP) **1088**
    - Setting Email Gateway System Time Manually **1089**
- Customizing Your View **1089**
  - Using Favorite Pages **1089**
  - Setting User Preferences **1089**
- General Settings **1090**
  - Overriding Internet Explorer Compatibility Mode **1090**
  - Collecting Usage Statistics of the Email Gateway on the New Web Interface **1091**
- Configuring Maximum HTTP Header Size **1091**
- Restarting and Viewing Status of Service Engines **1091**
- Receiving and Delivering Messages with Internationalised Domain Names (IDNs) **1092**
  - Prerequisites **1092**
  - Features Configurable using IDN Domains in Email Gateway **1092**

---

**CHAPTER 40**

- Managing and Monitoring Using the CLI **1095****
  - Overview of Managing and Monitoring Using the CLI **1095**
  - Reading the Available Components of Monitoring **1096**
    - Reading the Event Counters **1096**
    - Reading the System Gauges **1098**
    - Reading the Rates of Delivered and Bounced Messages **1100**
  - Monitoring Using the CLI **1101**
    - Monitoring the Email Status **1101**
      - Example **1102**
    - Monitoring Detailed Email Status **1102**
      - Example **1103**
    - Monitoring the Status of a Mail Host **1104**
      - Virtual Gateway **1105**
      - Example **1105**

Determining the Make-up of the Email Queue	1106
Example	1107
Displaying Real-time Activity	1107
Example	1107
Example	1108
Monitoring Inbound Email Connections	1108
Example	1109
Checking the DNS Status	1109
Example	1110
Resetting Email Monitoring Counters	1110
Example	1110
Identifying Active TCP/IP Services	1111
Managing the Email Queue	1111
Deleting Recipients in Queue	1111
Example	1111
Bouncing Recipients in Queue	1112
Example	1112
Redirecting Messages in Queue	1113
Example	1113
Showing Messages Based on Recipient in Queue	1114
Example	1114
Suspending Email Delivery	1114
Example	1115
Resuming Email Delivery	1115
Syntax	1115
Suspending Receiving Email	1115
Syntax	1115
Resuming Receiving Email	1116
Syntax	1116
Resuming Delivery and Receiving of Email	1116
Syntax	1116
Scheduling Email for Immediate Delivery	1116
Syntax	1116
Pausing the Work Queue	1117

- Locating and Archiving Older Messages 1118
  - Syntax 1118
  - Syntax 1118
- Tracking Messages Within the System 1119
- Monitoring System Health and Status Using SNMP 1120
  - MIB Files 1121
  - Hardware Objects 1121
    - Hardware Traps 1121
  - SNMP Traps 1122
    - Example: snmpconfig Command 1122

---

**CHAPTER 41**

**Improving Phishing Detection Efficacy using Service Logs 1125**

- Overview 1125
- Enabling Service Logs on Email Gateway 1125
- Disabling Service Logs on Email Gateway 1126
- Frequently Asked Questions 1126
  - What data do I share? 1126
  - What does Cisco do to make sure that the data I share is secure? 1127
  - Will sharing data impact the performance of my Cisco email gateways? 1128
  - Are there other ways I can share data? 1128

---

**CHAPTER 42**

**Other Tasks in the GUI 1129**

- The Graphical User Interface (GUI) 1129
  - Enabling the GUI on an Interface 1129
- System Information in the GUI 1130
- Gathering XML status from the GUI 1130

---

**CHAPTER 43**

**Advanced Network Configuration 1131**

- Media Settings on Ethernet Interfaces 1131
  - Using etherconfig to Edit Media Settings on Ethernet Interfaces 1131
    - Example of Editing Media Settings 1131
- Network Interface Card Pairing/Teaming 1132
  - NIC Pairing and VLANs 1133
  - NIC Pair Naming 1133

NIC Pairing and Existing Listeners	1133
Enabling NIC Pairing via the etherconfig Command	1133
Virtual Local Area Networks (VLANs)	1135
About Configuring VLANs	1135
Managing VLANs	1136
Creating a New VLAN via the etherconfig Command	1136
Creating an IP Interface on a VLAN via the interfaceconfig Command	1137
Configuring VLANs Using the Web Interface	1139
Direct Server Return	1139
Enabling Direct Server Return	1139
Enabling the Loopback Interface via the etherconfig Command	1140
Creating an IP Interface on Loopback via the interfaceconfig Command	1141
Creating a Listener on the New IP Interface	1142
Ethernet Interface's Maximum Transmission Unit	1143
Accept or Reject ARP Replies with a Multicast Address	1144

**CHAPTER 44****Logging 1145**

Overview	1145
Understanding Log Files and Log Subscriptions	1145
Log Types	1145
Log Type Characteristics	1150
Log Retrieval Methods	1153
Log Filenames and Directory Structure	1156
Log Rollover and Transfer Schedule	1156
Logs Enabled by Default	1157
Log Types	1157
Timestamps in Log Files	1158
Using Text Mail Logs	1158
Interpreting a Text Mail Log	1158
Examples of Text Mail Log Entries	1160
Message received based on Sender's Country of Origin	1166
Maximum URLs in Message Attachments Exceeds URL Scan Limit	1166
Maximum URLs in Message Body Exceeds URL Scan Limit	1167
Malicious Shortened URL redirected to Cisco Proxy Server	1167

Unable to Expand Shortened URL in Message	1167
Log Entry for Malicious URL in Message Attachment	1167
Message marked as Unscannable due to Extraction Failure	1168
Message marked as Unscannable due to RFC Violation	1168
Log Entries for Generated or Re-Written Messages	1168
Messages Sent to the Spam Quarantine	1169
Example of External Threat Feeds Mail Logs	1169
Examples of SDR Filtering Log Entries	1169
Cisco Advanced Phishing Protection Cloud Service Expired	1171
Reminder about Cisco Advanced Phishing Protection Cloud Service Expiry Date	1171
No API Access UID and API Access Secret Key	1171
Invalid API Access UID or API Access Secret Key	1171
Using Delivery Logs	1172
Examples of Delivery Log Entries	1173
Using Bounce Logs	1174
Examples of Bounce Log Entries	1175
Using Status Logs	1175
Reading Status Logs	1175
Using Domain Debug Logs	1178
Domain Debug Log Example	1179
Using Injection Debug Logs	1179
Injection Debug Log Example	1179
Using System Logs	1180
System Log Example	1180
Using CLI Audit Logs	1181
CLI Audit Log Example	1181
Using FTP Server Logs	1181
FTP Server Log Example	1181
Using HTTP Logs	1182
HTTP Log Example	1182
Using NTP Logs	1183
NTP Log Example	1183
Using Scanning Logs	1183
Scanning Log Example	1184



Using Anti-Spam Logs	1184
Anti-Spam Log Example	1184
Using Graymail Logs	1184
Graymail Log Example	1185
Using Anti-Virus Logs	1185
Anti-Virus Log Example	1185
Using AMP Engine Logs	1185
Examples of AMP Engine Log Entries	1186
Using Spam Quarantine Logs	1190
Spam Quarantine Log Example	1191
Using Spam Quarantine GUI Logs	1191
Spam Quarantine GUI Log Example	1191
Using LDAP Debug Logs	1192
LDAP Debug Log Example	1192
Using Safelist/Blocklist Logs	1193
Safelist/Blocklist Log Example	1193
Using Reporting Logs	1194
Reporting Log Example	1194
Using Reporting Query Logs	1195
Reporting Query Log Example	1195
Using Updater Logs	1196
Updater Log Example	1196
Updater Log Example	1197
Understanding Tracking Logs	1197
Using Authentication Logs	1197
Authentication Log Example	1198
Example of Two-Factor Authentication Login Failure due to incorrect passcode	1198
Example of Two-Factor Authentication Login Failure due to time-out	1198
Example of Two-Factor Authentication Login Success	1198
Using Configuration History Logs	1198
Configuration History Log Example	1199
Using External Threat Feeds Engine Logs	1199
Example of External Threat Feeds Engine Logs	1199
Using Consolidated Event Logs	1200

- Using CSN Logs **1207**
- Using Advanced Phishing Protection Logs **1208**
- Using Audit Logs **1208**
- Using CSA Logs **1211**
- Log Subscriptions **1212**
  - Configuring Log Subscriptions **1212**
    - Log Levels **1213**
  - Creating a Log Subscription in the GUI **1214**
    - Editing Log Subscriptions **1214**
  - Configuring Global Settings for Logging **1215**
    - Logging Message Headers **1216**
    - Configuring Global Settings for Logging Using the GUI **1216**
  - Rolling Over Log Subscriptions **1217**
    - Rollover By File Size **1217**
    - Rollover By Time **1217**
    - Rolling Over Log Subscriptions on Demand **1219**
  - Viewing Recent Log Entries in the GUI **1219**
  - Viewing Recent Log Entries in the CLI (tail Command) **1219**
    - Example **1220**
  - Configuring Host Keys **1221**

---

**CHAPTER 45**

**Centralized Management Using Clusters **1225****

- Overview of Centralized Management Using Clusters **1225**
- Cluster Requirements **1226**
- Cluster Organization **1226**
  - Initial Configuration Settings **1227**
- Creating and Joining a Cluster **1228**
  - The clusterconfig Command **1228**
    - Joining an Existing Cluster **1229**
    - Joining an Existing Cluster over SSH **1230**
    - Joining an Existing Cluster over CCS **1231**
    - Joining an Existing Cluster over SSH with Pre-Shared Keys **1233**
- Adding Groups **1234**
- Managing Clusters **1235**

Administering a Cluster from the CLI	1235
Copying and Moving Settings	1235
Experimenting with New Configurations	1236
Leaving a Cluster Permanently (Removal)	1237
Upgrading Machines in a Cluster	1237
CLI Command Support	1238
All Commands Are Cluster-aware	1238
The commit and clearchanges Commands	1238
New Operation Added	1238
Restricted Commands	1239
Administering a Cluster from the GUI	1240
Cluster Communication	1242
DNS and Hostname Resolution	1243
Clustering, Fully Qualified Domain Names, and Upgrading	1243
Cluster Communication Security	1243
Cluster Consistency	1244
Disconnect/Reconnect	1244
Interdependent Settings	1245
Loading a Configuration in Clustered Email Gateway	1247
Best Practices and Frequently Asked Questions	1248
Best Practices	1248
Copy vs Move	1249
Good CM Design Practices	1249
Best Practices for Accessing Spam or Policy Quarantines in Cluster Setup	1250
Procedures: Configuring an Example Cluster	1250
Summary of GUI Options for Using CM Settings Other Than the Cluster Default	1251
Setup and Configuration Questions	1252
General Questions	1252
Network Questions	1252
Planning and Configuration	1253
<hr/>	
<b>CHAPTER 46</b>	<b>Testing and Troubleshooting 1255</b>
Debugging Mail Flow Using Test Messages: Trace	1255
Using the Listener to Test the Email Gateway	1261

Example	1262
Troubleshooting the Network	1265
Testing the Network Connectivity of the Email Gateway	1265
Troubleshooting	1266
Troubleshooting the Listener	1270
Troubleshooting Email Delivery From the Appliance	1271
Troubleshooting Performance	1273
Web Interface Appearance and Rendering Issues	1274
Responding to Alerts	1274
Troubleshooting Alerts That Miscellaneous Disk Usage is Approaching the Quota	1274
Troubleshooting Hardware Issues	1274
Remotely Resetting Email Gateway Power	1275
Working with Technical Support	1275
Technical Support for Virtual Email Gateway	1276
Opening or Updating a Support Case From the Email Gateway	1276
Enabling Remote Access for Cisco Technical Support Personnel	1277
Enabling Remote Access to Email Gateways With an Internet Connection	1277
Enabling Remote Access to Email Gateways Without a Direct Internet Connection	1277
Disabling a Tech Support Tunnel	1278
Disabling Remote Access	1278
Checking the Status of the Support Connection	1279
Running a Packet Capture	1279
<hr/>	
<b>CHAPTER 47</b>	<b>Optimizing the Email Gateway for Outbound Mail Delivery Using D-Mode</b>
	1281
Feature Summary: D-Mode for Optimized Outbound Delivery	1281
Features Unique to D-Mode-Enabled Email Gateways	1281
Standard Features Disabled in D-Mode-Enabled Email Gateways	1282
Standard Features Applicable to D-Mode-Enabled Email Gateways	1282
Setting Up the Email Gateway for Optimized Outbound Mail Delivery	1283
Configuring Resource-Conserving Bounce Settings	1283
Example of Enabling Resource-Conserving Bounce Settings	1283
Sending Bulk Mail Using IronPort Mail Merge (IPMM)	1284
Overview of IronPort Mail Merge	1284
Benefits of the Mail Merge Function	1284

Using Mail Merge	1285
SMTP Injection	1285
Variable Substitution	1285
Reserved Variables	1285
Example Message 1	1286
Part Assembly	1286
Example Message 2, Part 1	1286
Example Message 2, Part 2	1287
IPMM and DomainKeys Signing	1287
Command Descriptions	1287
XMRG FROM	1287
XDFN	1287
XPRT	1287
Notes on Defining Variables	1288
Example IPMM Conversation	1288
Example Code	1290

**CHAPTER 48**

<b>Centralizing Services on a Cisco Secure Email and Web Manager (M-Series)</b>	<b>1291</b>
Overview of Cisco Secure Email and Web Manager Services	1291
Network Planning	1292
Working with an External Spam Quarantine	1292
Mail Flow and External Spam Quarantine	1292
Migrating from a Local Spam Quarantine to an External Quarantine	1293
Enabling an External Spam Quarantine and External Safelist/Blocklist	1294
Disabling the Local Spam Quarantine to Activate the External Quarantine	1295
Troubleshooting an External Spam Quarantine	1295
About Centralizing Policy, Virus, and Outbreak Quarantines	1295
Centralized Policy, Virus, and Outbreak Quarantines	1295
Restrictions and Limitations of Centralized Policy, Virus, and Outbreak Quarantines	1296
Requirements for Centralized Policy, Virus, and Outbreak Quarantines in Cluster Configurations	1296
About Migration of Policy, Virus, and Outbreak Quarantines	1296
Centralizing Policy, Virus, and Outbreak Quarantines	1297
About Disabling Centralized Policy, Virus, and Outbreak Quarantines	1298

Disabling Centralized Policy, Virus, and Outbreak Quarantines 1299

Troubleshooting Centralized Policy, Virus, and Outbreak Quarantines 1299

Configuring Centralized Reporting 1300

    Requirements for Advanced Malware Protection Reporting 1300

    Availability of Reporting Information after Changing to Centralized Reporting 1300

    About Disabling Centralized Reporting 1300

Configuring Centralized Message Tracking 1301

Using Centralized Services 1301

---

**APPENDIX A**

**FTP, SSH, and SCP Access 1303**

    IP Interfaces 1303

        How AsyncOS Selects Default IP Interface 1304

    Configuring FTP Access to the Email Gateway 1304

    Secure Copy (scp) Access 1306

    Accessing the Email Gateway via a Serial Connection 1307

        Pinout Details for the Serial Port in 80- and 90- Series Hardware 1307

        Pinout Details for the Serial Port in 70-Series Hardware 1308

---

**APPENDIX B**

**Assigning Network and IP Addresses 1309**

    Ethernet Interfaces 1309

    Selecting IP Addresses and Netmasks 1309

        Sample Interface Configurations 1310

        IP Addresses, Interfaces, and Routing 1310

        Summary 1311

    Strategies for Connecting Your Email Gateway 1311

---

**APPENDIX C**

**Example of Mail Policies and Content Filters 1313**

    Overview of Incoming Mail Policies 1313

        Accessing Mail Policies 1313

            Enabled, Disabled, and “Not Available” 1314

        Configuring the Default Anti-Spam Policies for Incoming Messages 1315

        Creating a Mail Policy for a Group of Sender and Recipients 1316

            Default, Custom, and Disabled 1319

        Creating Mail Policies for Different Groups of Senders and Recipients 1319

Creating Mail Policies for Different Groups of Senders and Recipients	1320
Finding Senders or Recipients in Mail Policies	1322
Managed Exceptions	1322
Filtering Messages Based on Content	1323
Quarantining Message with “Confidential” in the Subject	1323
Stripping MP3 Attachments from Messages	1324
Bouncing Messages Sent to a Former Employee	1324
Applying Individual Content Filters to Different Groups of Recipients	1325
Enabling Content Filters for All Recipients by Default	1326
Allowing MP3 Attachments for Recipients in Engineering	1326
Notes on Configuring Content Filters in the GUI	1327

---

**APPENDIX D****Firewall Information** 1331

Firewall Information 1331

Protecting Email Gateway from Network Attacks 1335

---

**APPENDIX E****End User License Agreement** 1337

Cisco Systems End User License Agreement 1337

Supplemental End User License Agreement for Cisco Systems Content Security Software 1343







## CHAPTER

# 1

# Getting Started with Cisco Secure Email Gateway

This chapter contains the following sections:

- [What's New in AsyncOS 14.2.1, on page 1](#)
- [Comparison of Web Interfaces, New Web Interface with Legacy Web Interface , on page 1](#)
- [Where to Find More Information, on page 4](#)
- [Cisco Secure Email Gateway Overview, on page 7](#)

## What's New in AsyncOS 14.2.1

*Table 1: Whats New in AsyncOS 14.2.1*

Feature	Description
Using only User-defined Passphrases to open Password-protected Attachments	<p>From this release onwards, you can choose to use only the user-defined passphrases created in your email gateway to open password-protected attachments in incoming and outgoing messages.</p> <p>You can configure this feature in any one of the following ways:</p> <ul style="list-style-type: none"><li>• Use the <b>Apply User-defined Passwords Only</b> checkbox in the Security Services &gt; Scan Behavior &gt; Edit Global Settings page of the web interface.</li><li>• Use the "Do you want to apply user-defined passwords only? y/n" statement under <code>scanconfig &gt; protectedattachmentconfig</code> sub command in the CLI.</li></ul> <p>For more information, see <a href="#">Configuring Scan Behavior, on page 247</a>.</p>

## Comparison of Web Interfaces, New Web Interface with Legacy Web Interface

The following table shows the comparison of the new web interface with the legacy interface:

Table 2: Comparison of New Web Interface with legacy interface

Web Interface Page or Element	New Web Interface	Legacy Web Interface
Landing Page	After you log in to the email gateway, the Mail Flow Summary page is displayed.	After you log in to the email gateway, the My Dashboard page is displayed.
Reports Drop-down	You can view reports for your email gateways from the Reports drop-down.	You can view reports for your email gateway from the <b>Monitor</b> menu.
My Reports Page	Choose <b>My Reports</b> from the Reports drop-down.	You can view the My Reports page from <b>Monitor &gt; My Dashboard</b> .
Mail Flow Summary Page	The <b>Mail Flow Summary</b> page includes trend graphs and summary tables for incoming and outgoing messages.	The <b>Incoming Mail</b> includes graphs and summary tables for the incoming and outgoing messages.
Advanced Malware Protection Report Pages	The following sections are available on the <b>Advanced Malware Protection</b> report page of the Reports menu: <ul style="list-style-type: none"> <li>• Summary</li> <li>• AMP File Reputation</li> <li>• File Analysis</li> <li>• File Retrospection</li> <li>• Mailbox Auto Remediation</li> </ul>	The email gateway has the following <b>Advanced Malware Protection</b> report pages under <b>Monitor</b> menu: <ul style="list-style-type: none"> <li>• Advanced Malware Protection</li> <li>• AMP File Analysis</li> <li>• AMP Verdict Updates</li> <li>• Mailbox Auto Remediation</li> </ul>
Outbreak Filters Page	The Past Year Virus Outbreaks and Past Year Virus Outbreak Summary are not available in the <b>Outbreak Filtering</b> report page of the new web interface.	The <b>Monitor &gt; Outbreak Filters</b> page displays the Past Year Virus Outbreaks and Past Year Virus Outbreak Summary.
Spam Quarantines (Administrative and End Users)	Click <b>Quarantine &gt; Spam Quarantine &gt; Search</b> in the new web interface.  The end users can access the spam quarantine using the URL:  <code>https://example.com:&lt;https-api-port&gt;/eq-login</code>  where <code>example.com</code> is the appliance hostname and <code>&lt;https-api-port&gt;</code> is the AsyncOS API HTTPS port opened on the firewall.	You can view spam quarantine from the <b>Monitor &gt; Spam Quarantine</b> menu.

Web Interface Page or Element	New Web Interface	Legacy Web Interface
Policy, Virus and Outbreak Quarantines	Click <b>Quarantine &gt; Other Quarantine</b> in the new web interface.  You can only view Policy, Virus and Outbreak Quarantines in the new web interface.	You can view, configure and modify the Policy, Virus and Outbreak Quarantines on the email gateway using the <b>Monitor &gt; Policy, Virus and Outbreak Quarantines</b> .
Select All Action for Messages in Quarantine	You can select multiple (or all) messages and perform a message action such as delete, delay, release, move, etc.	You cannot select multiple messages to perform a message action.
Maximum Download Limit for Attachments	The maximum limit for downloading attachments of a quarantined message is restricted to 25 MB.	-
Rejected Connections	To search for rejected connections, click <b>Tracking &gt; Search &gt; Rejected Connection</b> tab on the .	-
Query Settings	The Query Settings field of the Message Tracking feature is not available on the .	You can set the query timeout in the Query Settings field of the Message Tracking feature.
Message Tracking Data Availability	Click the gear icon on the upper right side of the page the web interface to access Message Tracking Data Availability page.	You can view the missing-data intervals for your email gateway.
Show Additional Details of Messages	You can view additional details of a message such as Verdict Charts, Last State, Sender Groups, Sender IP, IP Reputation Score and Policy Match details.	-
Verdict Charts and Last State Verdicts	Verdict Chart displays information of the various possible verdicts triggered by each engine in your email gateway.  Last State of the message determines the final verdict triggered after all the possible verdicts of the engine.	Verdict Charts and Last State Verdicts of the messages are not available.
Message Attachments and Host Names in Message Details	Message attachments and host names are not displayed in the Message Details section of the message on the email gateway.	Message attachments and host names are displayed in the Message Details section of the message.

Web Interface Page or Element	New Web Interface	Legacy Web Interface
Sender Groups, Sender IP, IP Reputation Score and Policy Match in Message Details	Sender Groups, Sender IP, IP Reputation Score, and Policy Match details of the message is displayed in the Message Details section, on the email gateway.	Sender Groups, Sender IP, IP Reputation Score, and Policy Match of the message is not available in the Message Details section of the message.
Direction of the Message (Incoming or Outgoing)	Direction of the message (incoming or outgoing) is displayed in the message tracking results page, on the email gateway.	Direction of the message (incoming or outgoing) is not displayed in the message tracking results page.

## Where to Find More Information

Cisco offers the following resources to learn more about your email gateway:

- [Documentation](#) , on page 4
- [Training](#), on page 5
- [Cisco Notification Service](#) , on page 5
- [Knowledge Base](#), on page 5
- [Cisco Support Community](#), on page 6
- [Cisco Customer Support](#), on page 6
- [Third Party Contributors](#), on page 6
- [Cisco Welcomes Your Comments](#), on page 6
- [Registering for a Cisco Account](#) , on page 7

## Documentation

You can access the online help version of this user guide directly from the appliance GUI by clicking Help and Support in the upper-right corner.

The documentation set for the Cisco Secure Email Gateway includes the following documents and books:

- Release Notes
- Quick Start Guide for your Cisco Email Security Appliance model
- Hardware Installation or Hardware installation and maintenance guide for your model or series
- *Cisco Content Security Virtual Appliance Installation Guide*
- *User Guide for AsyncOS for Cisco Secure Email Gateway* (this book)
- *CLI Reference Guide for AsyncOS for Cisco Secure Email Gateway*
- AsyncOS API for Cisco Secure Email Gateway - Getting Started Guide

Documentation for all Cisco Content Security products is available from:

Documentation For Cisco Content Security Products	Location
Hardware and virtual appliances	See the applicable product in this table.

Documentation For Cisco Content Security Products	Location
Cisco Email Security	<a href="http://www.cisco.com/c/en/us/support/security/email-security-appliance/tsd-products-support-series-home.html">http://www.cisco.com/c/en/us/support/security/email-security-appliance/tsd-products-support-series-home.html</a>
Cisco Web Security	<a href="http://www.cisco.com/c/en/us/support/security/web-security-appliance/tsd-products-support-series-home.html">http://www.cisco.com/c/en/us/support/security/web-security-appliance/tsd-products-support-series-home.html</a>
Cisco Content Security Management	<a href="http://www.cisco.com/c/en/us/support/security/content-security-management-appliance/tsd-products-support-series-home.html">http://www.cisco.com/c/en/us/support/security/content-security-management-appliance/tsd-products-support-series-home.html</a>
CLI reference guide for Cisco Content Security appliances	<a href="http://www.cisco.com/c/en/us/support/security/email-security-appliance/products-command-reference-list.html">http://www.cisco.com/c/en/us/support/security/email-security-appliance/products-command-reference-list.html</a>
Cisco IronPort Encryption	<a href="http://www.cisco.com/c/en/us/support/security/email-security-appliance/products-command-reference-list.html">http://www.cisco.com/c/en/us/support/security/email-security-appliance/products-command-reference-list.html</a>

## Training

More information about training is available from:

- <http://www.cisco.com/c/en/us/training-events/training-certifications/supplemental-training/email-and-web-security.html>
- <http://www.cisco.com/c/en/us/training-events/training-certifications/overview.html>

## Cisco Notification Service

Sign up to receive notifications relevant to your Cisco Content Security Appliances, such as Security Advisories, Field Notices, End of Sale and End of Support statements, and information about software updates and known issues.

You can specify options such as notification frequency and types of information to receive. You should sign up separately for notifications for each product that you use.

To sign up, visit <http://www.cisco.com/cisco/support/notifications.html>

A Cisco.com account is required. If you do not have one, see [Registering for a Cisco Account](#), on page 7.

## Knowledge Base

### Procedure

- 
- Step 1** Go to the main product page (<http://www.cisco.com/c/en/us/support/security/email-security-appliance/tsd-products-support-series-home.html>)
- Step 2** Look for links with **TechNotes** in the name.
-

## Cisco Support Community

The Cisco Support Community is an online forum for Cisco customers, partners, and employees. It provides a place to discuss general email and web security issues, as well as technical information about specific Cisco products. You can post topics to the forum to ask questions and share information with other Cisco users.

Access the Cisco Support Community on the Customer Support Portal at the following URLs:

- For email security and associated management:  
<https://supportforums.cisco.com/community/5756/email-security>
- For web security and associated management:  
<https://supportforums.cisco.com/community/5786/web-security>

## Cisco Customer Support

Cisco TAC: <http://www.cisco.com/c/en/us/support/web/tsd-cisco-worldwide-contacts.html>

Support site for legacy IronPort: <http://www.cisco.com/c/en/us/services/acquisitions/ironport.html>

For non-critical issues, you can also access customer support from the email gateway. For instructions, see the User Guide or online help.

## Third Party Contributors

See Open Source licensing information for your release on this page:

<http://www.cisco.com/c/en/us/support/security/email-security-appliance/products-release-notes-list.html> .

Some software included within Cisco AsyncOS is distributed under the terms, notices, and conditions of software license agreements of FreeBSD, Inc., Stichting Mathematisch Centrum, Corporation for National Research Initiatives, Inc., and other third party contributors, and all such terms and conditions are incorporated in Cisco license agreements.

The full text of these agreements can be found here:

[https://support.ironport.com/3rdparty/AsyncOS\\_User\\_Guide-1-1.html](https://support.ironport.com/3rdparty/AsyncOS_User_Guide-1-1.html).

Portions of the software within Cisco AsyncOS is based upon the RRDtool with the express written consent of Tobi Oetiker.

Portions of this document are reproduced with permission of Dell Computer Corporation. Portions of this document are reproduced with permission of McAfee, Inc. Portions of this document are reproduced with permission of Sophos Plc.

## Cisco Welcomes Your Comments

The Cisco Technical Publications team is interested in improving the product documentation. Your comments and suggestions are always welcome. You can send comments to the following email address:

[contentsecuritydocs@cisco.com](mailto:contentsecuritydocs@cisco.com)

Please include the product name, release number, and document publication date in the subject of your message.

## Registering for a Cisco Account

Access to many resources on Cisco.com requires a Cisco account.

If you do not have a Cisco.com User ID, you can register for one here: <https://idreg.cloudapps.cisco.com/idreg/register.do>

### Related Topics

- [Cisco Notification Service](#) , on page 5
- [Knowledge Base](#), on page 5

## Cisco Secure Email Gateway Overview

The AsyncOS™ operating system includes the following features:

- **Anti-Spam** at the gateway, through the unique, multi-layer approach of SenderBase Reputation Filters and Cisco Anti-Spam integration.
- **Anti-Virus** at the gateway with the Sophos and McAfee Anti-Virus scanning engines.
- **Outbreak Filters™**, Cisco's unique, preventive protection against new virus, scam, and phishing outbreaks that can quarantine dangerous messages until new updates are applied, reducing the window of vulnerability to new message threats.
- **Policy, Virus, and Outbreak Quarantines** provide a safe place to store suspect messages for evaluation by an administrator.
- **Spam Quarantine** either on-box or off, providing end user access to quarantined spam and suspected spam.
- **Email Authentication.** Cisco AsyncOS supports various forms of email authentication, including Sender Policy Framework (SPF), Sender ID Framework (SIDF), and DomainKeys Identified Mail (DKIM) verification of incoming mail, as well as DomainKeys and DKIM signing of outgoing mail.
- Cisco **Email Encryption.** You can encrypt outgoing mail to address HIPAA, GLBA and similar regulatory mandates. To do this, you configure an encryption policy on the email gateway and use a local key server or hosted key service to encrypt the message.
- **Email Security Manager**, a single, comprehensive dashboard to manage all email security services and applications on the email gateway. Email Security Manager can enforce email security based on user groups, allowing you to manage Cisco Reputation Filters, Outbreak Filters, Anti-Spam, Anti-Virus, and email content policies through distinct inbound and outbound policies.
- **On-box message tracking.** AsyncOS for Email includes an on-box message tracking feature that makes it easy to find the status of messages that the E email gateway processes.
- **Mail Flow Monitoring** of all inbound and outbound email that provides complete visibility into all email traffic for your enterprise.
- **Access control** for inbound senders, based upon the sender's IP address, IP address range, or domain.
- Extensive **message and content filtering** technology allows you to enforce corporate policy and act on specific messages as they enter or leave your corporate infrastructure. Filter rules identify messages based on message or attachment content, information about the network, message envelope, message headers, or message body. Filter actions allow messages to be dropped, bounced, archived, blind carbon copied, or altered, or to generate notifications.
- **Message encryption via secure SMTP over Transport Layer Security** ensures messages traveling between your corporate infrastructure and other trusted hosts are encrypted.

- **Virtual Gateway™** technology allows the email gateway to function as several email gateways within a single server, which allows you to partition email from different sources or campaigns to be sent over separate IP addresses. This ensures that deliverability issues affecting one IP address do not impact others.
- **Protection against malicious attachments and links** in email messages, provided by multiple services.
- Use **Data Loss Prevention** to control and monitor the information that leaves your organization.

AsyncOS supports RFC 2821-compliant Simple Mail Transfer Protocol (SMTP) to accept and deliver messages.

Most reporting, monitoring, and configuration commands are available through both the web-based GUI via HTTP or HTTPS. In addition, an interactive Command Line Interface (CLI) which you access from a Secure Shell (SSH) or direct serial connection is provided for the system.

You can also set up a Cisco Secure Email and Web Manager to consolidate reporting, tracking, and quarantine management for multiple E email gateways.

### Related Topics

- [Supported Languages, on page 8](#)

## Supported Languages

AsyncOS can display its GUI and CLI in any of the following languages:

- English
- French
- Spanish
- German
- Italian
- Korean
- Japanese
- Portuguese (Brazil)
- Chinese (traditional and simplified)
- Russian





## CHAPTER 2

# Accessing the Email Gateway

This chapter contains the following sections:

- [Web-based Graphical User Interface \(GUI\)](#) , on page 9
- [Changing Configuration Settings](#), on page 12
- [Command Line Interface \(CLI\)](#), on page 12

## Web-based Graphical User Interface (GUI)

You can administer the email gateway using both the web-based Graphical User Interface (GUI) and Command Line Interface (CLI). The GUI contains most of the functionality you need to configure and monitor the system. However, not all CLI commands are available in the GUI; some features are *only* available through the CLI.

- [Browser Requirements](#), on page 9
- [Accessing the GUI](#), on page 10

## Browser Requirements

To access the web-based UI, your browser must support and be enabled to accept JavaScript and cookies, and it must be able to render HTML pages containing Cascading Style Sheets (CSS).

Browser	Operating System
Internet Explorer 11.0	Microsoft Windows 7 and 10
Safari 7.0 and later	Mac OS X
Firefox 39.0 and later	Microsoft Windows 7 and 10, Mac OS X
Chrome 44.0 and later	Microsoft Windows 7 and 10, Mac OS X

Do not use multiple browser windows or tabs simultaneously to make changes to the email gateway. Do not use concurrent GUI and CLI sessions. Doing so will cause unexpected behavior and is not supported.

You may need to configure your browser's pop-up blocking settings in order to use the web interface because some buttons or links in the interface will cause additional windows to open.

## Accessing the GUI

To access the GUI on a brand new system, access the following URL:

<http://192.168.42.42/>

When the login page is displayed, log in to the system using the default username and passphrase.

### Related Topics

- [Factory Default Username and Passphrase, on page 10](#)
- [Centralized Management, on page 10](#)

## Factory Default Username and Passphrase

- Username: `admin`
- Passphrase: `ironport`

On brand new (not upgraded from previous releases of AsyncOS) systems, you will automatically be redirected to the System Setup Wizard.

During the initial system setup, you choose IP addresses for interfaces and whether to run HTTP and/or HTTPS services for those interfaces. When HTTP and/or HTTPS services have been enabled for an interface, you can use any supporting browser to view the GUI by entering the IP address or hostname of the IP interface as a URL in the location field (“address bar”) of the browser.

For example:

`http://192.168.1.1` or

`https://192.168.1.1` or

`http://mail3.example.com` or

`https://mail3.example.com`



---

**Note** If HTTPS has been enabled for an interface (and HTTP requests are *not* being redirected to the secure service), remember to access the GUI using the “`https://`” prefix.

---

### Related Topics

- [Adding Users , on page 976](#)

## Centralized Management

If you have created a cluster, you can browse machines in the cluster, create, delete, copy, and move settings among clusters, groups, and machines (that is, perform the equivalent of the `clustermode` and `clusterset` commands) from within the GUI.

For more information, see [Administering a Cluster from the GUI, on page 1240](#).

## Enhanced User Experience using How-Tos Widget

The How-Tos is a contextual widget that provides in-app assistance to users in the form of walkthroughs to accomplish complex tasks on your email gateway. To view a list of walkthroughs supported in this release, see [List of Walkthroughs](#).

You can access the walkthroughs by clicking the How-Tos widget on the web interface of your email gateway. By default, the How-Tos widget is enabled on your email gateway. The contents of the How-Tos widget are cloud-updateable.

For each walkthrough, there are recommended settings for specific configurable values categorized as follows:

- Conservative Settings - Cautious, configuration of not excessive limits
- Moderate Settings - Average, configuration within reasonable limits
- Aggressive Settings- Forceful, configuration of assertive limits



### Note

- The current set of walkthroughs is limited to the following users: admin, cloud-admin, and operator.
- If you are using Internet Explorer version 11 to access the web interface of your email gateway, you may not be able to view the How-Tos widget. Go to **System Administration > General Settings** page on your web interface and enable the Override IE Compatibility Mode option to view the How-Tos widget.

## Disabling How-Tos Widget on the Email Gateway

Use the `adminaccessconfig > how-tos` sub command in the CLI if you want to disable the How-Tos widget on your email gateway.

### Example: Disabling How-Tos widget on the Email Gateway

```
mail.example.com> adminaccessconfig
```

Choose the operation you want to perform:

- BANNER - Configure login message (banner) for appliance administrator login.
- WELCOME - Configure welcome message (post login message) for appliance administrator login.
- IPACCESS - Configure IP-based access for appliance administrative interface.
- CSRF - Configure web UI Cross-Site Request Forgeries protection.
- XSS - Configure Cross-Site Scripting Attack protection.
- HOSTHEADER - Configure option to use host header in HTTP requests.
- TIMEOUT - Configure GUI and CLI session inactivity timeout.
- MAXHTTPHEADERFIELDSIZE - Configure maximum HTTP header Field size.
- HOW-TOS - Configure How-Tos feature.

```
[ ]> how-tos
```

How-Tos consists of a list of generic walkthroughs to assist the users in completing a particular task (for example, "enabling and configuring a service engine on the appliance").

```
Would you like to enable How-Tos? [Y]> no
```

# Changing Configuration Settings

- [Configuration Changes](#), on page 12
- [Commit or Abandoning Changes](#), on page 12

## Configuration Changes

You can make configuration changes while email operations proceed normally.

## Commit or Abandoning Changes

You must explicitly save most configuration changes.

When changes are pending a commit, the Commit Changes button turns orange.

To clear or commit these changes, click **Commit Changes**.

## Command Line Interface (CLI)

The Command Line Interface is accessible via SSH on IP interfaces that have been configured with these services enabled, or via terminal emulation software on the serial port. By factory default, SSH is configured on the Management port. Use the `interfaceconfig` command to disable these services.

For more information about CLI commands and conventions, see the CLI Reference Guide for AsyncOS for Cisco Secure Email Gateway.



---

**Note** The factory default username and passphrase for accessing CLI is same as that of the web interface. See [Factory Default Username and Passphrase](#), on page 10.

---



## CHAPTER 3

# Setup and Installation

This chapter contains the following sections:

- [Installation Planning](#), on page 13
- [Physically Connecting the Email Gateway to the Network](#), on page 16
- [Preparing for System Setup](#), on page 20
- [Using the System Setup Wizard](#), on page 26
- [Verifying Your Configuration and Next Steps](#), on page 51

## Installation Planning

- [Review Information That Impacts Planning Decisions](#), on page 13
- [Plan to Place the Email Gateway at the Perimeter of Your Network](#), on page 13
- [Register the Email Security Appliance in DNS](#), on page 14
- [Installation Scenarios](#), on page 15

## Review Information That Impacts Planning Decisions

- If you are configuring a virtual email gateway, please see the *Cisco Content Security Virtual Appliance Installation Guide* before continuing with this chapter.
- If you are configuring an M-Series Cisco Secure Email and Web Manager, please see [Centralizing Services on a Cisco Secure Email and Web Manager \(M-Series\)](#), on page 1291.
- We recommend reviewing [Understanding the Email Pipeline](#), on page 53 before installing, as some features and functions may affect the placement of the email gateway within your infrastructure.

## Plan to Place the Email Gateway at the Perimeter of Your Network

Your email gateway is designed to serve as your SMTP gateway, also known as a mail exchange (MX). For best results, some features require the email gateway to be the first machine with an IP address that is directly accessible to the Internet (that is, it is an external IP address) for sending and receiving email.

The per-recipient reputation filtering, anti-spam, anti-virus, and Virus Outbreak Filter features (see [IronPort Anti-Spam Filtering](#), on page 382, [Sophos Anti-Virus Filtering](#), on page 362, and [Outbreak Filters](#), on page 421) are designed to work with a *direct flow* of messages from the Internet and from your internal network. You can configure the email gateway for policy enforcement ([Overview of Defining Which Hosts Are Allowed to Connect](#), on page 89) for all email traffic to and from your enterprise.

Ensure that the email gateway is both accessible via the public Internet and is the “first hop” in your email infrastructure. If you allow another MTA to sit at your network’s perimeter and handle all external connections, then the email gateway will not be able to determine the sender’s IP address. The sender’s IP address is needed to identify and distinguish senders in the Mail Flow Monitor, to query the IP Reputation Service for the sender’s IP Reputation Score, and to improve the efficacy of the Anti-Spam and Outbreak Filters features.



**Note** If you cannot configure the email gateway as the *first* machine receiving email from the Internet, you can still exercise some of the security services available on the email gateway. For more information, see [Determining Sender IP Address In Deployments with Incoming Relays](#), on page 407.

When you use the email gateway as your SMTP gateway:

- The Mail Flow Monitor feature (see [Using Email Security Monitor](#), on page 829) offers complete visibility into all email traffic for your enterprise from both internal and external senders.
- LDAP queries (see [LDAP Queries](#), on page 771) for routing, aliasing, and masquerading can consolidate your directory infrastructure and provide for simpler updates.
- Familiar tools like alias tables (see [Creating Alias Tables](#), on page 699), domain-based routing ([The Domain Map Feature](#), on page 716), and masquerading ([Configuring Masquerading](#), on page 706) make the transition from Open-Source MTAs easier.

## Register the Email Security Appliance in DNS

Malicious email senders actively search public DNS records to hunt for new victims. In order to utilize the full capabilities of Anti-Spam, Outbreak Filters, McAfee Antivirus and Sophos Anti-Virus, ensure that the email gateway is registered in DNS.

To register the email gateway in DNS, create an A record that maps the email gateway's hostname to its IP address, and an MX record that maps your public domain to the email gateway's hostname. You must specify a priority for the MX record to advertise the email gateway as either a primary or backup MTA for your domain.

In the following example, the email gateway (ironport.example.com) is a backup MTA for the domain example.com, since its MX record has a higher priority value (20). In other words, the higher the numeric value, the lower the priority of the MTA.

```
$ host -t mx example.com
example.com mail is handled (pri=10) by mail.example.com
example.com mail is handled (pri=20) by ironport.example.com
```

By registering the email gateway in DNS, you will attract spam attacks regardless of how you set the MX record priority. However, virus attacks rarely target backup MTAs. Given this, if you want to evaluate an anti-virus engine to its fullest potential, configure the email gateway to have an MX record priority of equal or higher value than the rest of your MTAs.

## Installation Scenarios

You can install your email gateway into your existing network infrastructure in several ways.

Most customers' network configurations are represented in the following scenarios. If your network configuration varies significantly and you would like assistance planning an installation, please contact Cisco Customer Support (see [Cisco Customer Support](#), on page 6).

- [Configuration Overview](#), on page 15
- [Incoming](#), on page 15
- [Outgoing](#), on page 15
- [Ethernet Interfaces](#), on page 15
- [Advanced Configurations](#), on page 16
- [Firewall Settings \(NAT, Ports\)](#), on page 16

## Configuration Overview

The following figure shows the typical placement of the email gateway in an enterprise network environment:



In some scenarios, the email gateway resides inside the network “DMZ,” in which case an additional firewall sits between the email gateway and the groupware server.

The following network scenarios are described:

- Behind the Firewall: two listeners configuration (*Figure - Behind the Firewall Scenario / 2 Listeners Configuration*)

Choose the configuration that best matches your infrastructure. Then proceed to the next section, [Preparing for System Setup](#), on page 20.

## Incoming

- Incoming mail is accepted for the local domains you specify.
- All other domains are rejected.
- External systems connect directly to the email gateway to transmit email for the local domains, and the email gateway relays the mail to the appropriate groupware servers (for example, Exchange™, Groupwise™, Domino™) via SMTP routes. (See [Routing Email for Local Domains](#), on page 693.)

## Outgoing

- Outgoing mail sent by internal users is routed by the groupware server to the email gateway.
- The email gateway accepts outbound email based on settings in the Host Access Table for the private listener. (For more information, see [Working with Listeners](#), on page 66.)

## Ethernet Interfaces

Only one of the available Ethernet interfaces on the email gateway is required in these configurations. However, you can configure two Ethernet interfaces and segregate your internal network from your external Internet network connection.

For more information about assigning multiple IP addresses to the available interfaces, see [Configuring Mail Gateways for all Hosted Domains Using Virtual Gateway™ Technology, on page 745](#) and [Assigning Network and IP Addresses, on page 1309](#).

## Hardware Ports

The number and type of ports on your hardware appliance depend on the model:

Ports	Type	C190	C390	C690	C690F	C195	C395	C695	C695F
Management	Ethernet	0	1	1	1	0	1	1	1
Data	Ethernet	2*	5	5	3	2*	5	5	3
Console	Serial	RJ-45	RJ-45	RJ-45	RJ-45	RJ-45	RJ-45	RJ-45	RJ-45
Remote Power Management (RPC)	Ethernet	Y	Y	Y	Y	Y	Y	Y	Y

\* For appliances without a dedicated management port, use the Data1 port for management purposes.

For more information about ports, see the *Hardware Installation Guide* for your appliance model.

### Related Topics

- [Configuring Network Interfaces, on page 31](#)
- [Accessing the Email Gateway via a Serial Connection, on page 1307](#)
- [Enabling Remote Power Cycling , on page 1042](#)

## Advanced Configurations

In addition to the configurations shown in Figure - Behind the Firewall Scenario / 2 Listeners Configuration and Figure One Listener Configuration, you can also configure:

- Multiple email gateways using the Centralized Management feature. See [Centralized Management Using Clusters, on page 1225](#)
- Redundancy at the network interface card level by “teaming” two of the Ethernet interfaces on email gateways using the NIC Pairing feature. See [Advanced Network Configuration, on page 1131](#)

## Firewall Settings (NAT, Ports)

SMTP and DNS services must have access to the Internet. Other services may also require open firewall ports. For details, see [Firewall Information, on page 1331](#).

# Physically Connecting the Email Gateway to the Network

- [Configuration Scenarios, on page 17](#)



## Configuration Scenarios

The typical configuration scenario for the email gateway is as follows:

- **Interfaces** - Only one of the three available Ethernet interfaces on the email gateway is required for most network environments. However, you can configure two Ethernet interfaces and segregate your internal network from your external Internet network connection.
- **Public Listener (incoming email)** - The public listener receives connections from many external hosts and directs messages to a limited number of internal groupware servers.
  - Accepts connections from external mail hosts based on settings in the Host Access Table (HAT). By default, the HAT is configured to ACCEPT connections from all external mail hosts.
  - Accepts incoming mail only if it is addressed for the local domains specified in the Recipient Access Table (RAT). All other domains are rejected.
  - Relays mail to the appropriate internal groupware server, as defined by SMTP Routes.
- **Private Listener (outgoing email)** - The private listener receives connections from a limited number of internal groupware servers and directs messages to many external mail hosts.
  - Internal groupware servers are configured to route outgoing mail to the Cisco C- or X-Series email gateway.
  - The email gateway accepts connections from internal groupware servers based on settings in the HAT. By default, the HAT is configured to RELAY connections from all internal mail hosts.

### Related Topics

- [Segregating Incoming and Outgoing Mail, on page 17](#)

## Segregating Incoming and Outgoing Mail

You can segregate incoming and outgoing email traffic over separate listeners and on separate IP addresses. You can use Internet Protocol version 4 (IPv4) and version 6 (IPv6) addresses. However, the System Setup Wizard on the email gateway supports initial configuration of the following configurations:

- 2 separate listeners on 2 logical IPv4 and 2 IPv6 addresses configured on *separate* physical interfaces
  - segregates incoming and outgoing traffic
  - you can assign an IPv4 and an IPv6 address to each listener
- 1 listener on 1 logical IPv4 address configured on one physical interface
  - combines both incoming and outgoing traffic
  - you can assign both an IPv4 and an IPv6 address to the listener

Configuration worksheets for both one and two listener configurations are included below (see [Gathering the Setup Information, on page 23](#)). Most configuration scenarios are represented by one of the following three figures.

Figure 1: Behind the Firewall Scenario / 2 Listeners Configuration

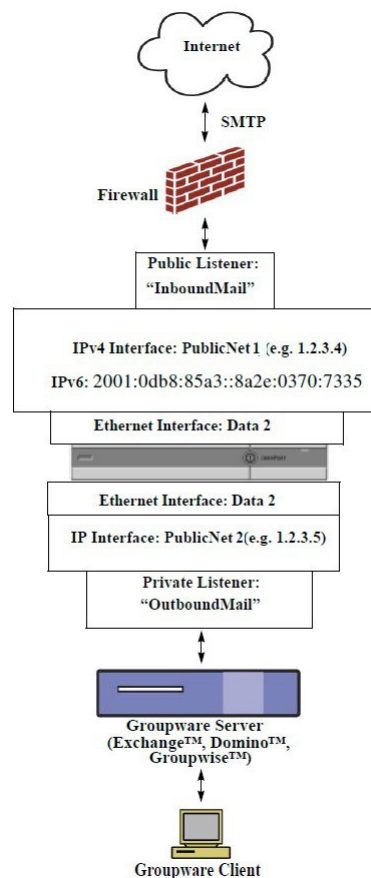
**Notes:**

- 2 Listeners
- 2 IPv4 addresses
- 2 IPv6 addresses
- 1 or 2 Ethernet interfaces (only 1 interface shown)
- SMTP routes configured

**Inbound Listener: “InboundMail” (public)**

- IPv4 address: 1.2.3.4
- IPv6 address: 2001:0db8:85a3::8a2e:0370:7334
- Listener on the Data2 interface listens on port 25
- HAT (accept ALL)
- RAT (accept mail for local domains; reject ALL)

**Outbound Listener: “OutboundMail” (private)**

- IP address: 1.2.3.5
- IPv6 address: 2001:0db8:85a3::8a2e:0370:7335
- Listener on the Data2 interface listens on port 25
- HAT (relay for local domains; reject ALL)

DNS can be configured to use Internet Root servers or internal DNS servers

SMTP routes direct mail to proper groupware server

Firewall ports opened for appropriate services to and from the email gateway

**Figure 2: One Listener Configuration**

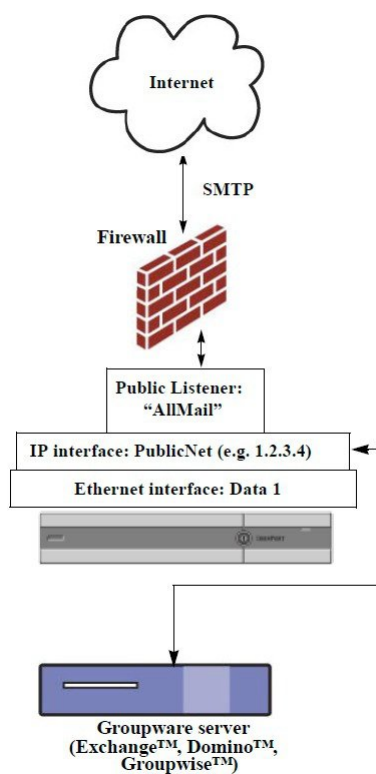

**Notes:**

- 1 Listener
- 1 IP addresses
- 1 Ethernet interface
- SMTP routes configured

**Inbound Listener: "InboundMail" (public)**

- IP address: 1.2.3.4
- Listener on the Data2 interface listens on port 25

- HAT (accept ALL) includes entries for Groupware servers in RELAYLIST
- RAT (accept mail for local domains; reject ALL)

DNS can be configured to use Internet Root servers or internal DNS servers

SMTP routes direct mail to proper groupware server

Firewall ports opened for appropriate services to and from the email gateway.

## Preparing for System Setup

- [Determine Method for Connecting to the Email Gateway, on page 21](#)
- [Determining Network and IP Address Assignments, on page 22](#)
- [Gathering the Setup Information, on page 23](#)

### Procedure

	Command or Action	Purpose
<b>Step 1</b>	Determine how you will connect to the email gateway.	See <a href="#">Determine Method for Connecting to the Email Gateway, on page 21</a>
<b>Step 2</b>	Determine network and IP address assignments. <ul style="list-style-type: none"> <li>• If you have already cabled your email gateway to your network, ensure that the default IP address for the email gateway does not conflict with other IP addresses on your network.</li> </ul>	See <a href="#">Determine Method for Connecting to the Email Gateway, on page 21</a> and <a href="#">Determining Network and IP Address Assignments, on page 22</a>
<b>Step 3</b>	Gather information about your system setup.	See <a href="#">Gathering the Setup Information, on page 23</a> .
<b>Step 4</b>	Review the latest product release notes for your email gateway.	Release notes are available from the link in <a href="#">Documentation</a> , on page 4.
<b>Step 5</b>	Unpack the email gateway, physically install it in a rack, and turn it on.	See Quickstart Guide for your email gateway. This guide is available from the link in <a href="#">Documentation</a> , on page 4.
<b>Step 6</b>	If you will run the setup wizard using the command line interface (CLI), access the CLI.	See <a href="#">Running the Command Line Interface (CLI) System Setup Wizard, on page 38</a>
<b>Step 7</b>	If you will run the setup wizard using the web interface:	<ol style="list-style-type: none"> <li>(Virtual appliances ONLY) Access the command-line interface and enable HTTP and/or HTTPS using the <code>interfaceconfig</code> command.</li> <li>Launch a web browser and enter the IP address of the email gateway.</li> </ol>
<b>Step 8</b>	If you are setting up a virtual email gateway, load your virtual email gateway license.	Use the <code>loadlicense</code> command. For more information, see the <i>Cisco Content Security</i>

	Command or Action	Purpose
		<i>Virtual Appliance Installation Guide</i> available from the link in <a href="#">Documentation</a> , on page 4.
<b>Step 9</b>	Configure basic settings for your system.	See <a href="#">Using the System Setup Wizard</a> , on page 26

## Determine Method for Connecting to the Email Gateway

To successfully set up the email gateway in your environment, you must gather important network information from your network administrator about how you would like to connect the email gateway to your network.

### Related Topics

- [Connecting to the Email Gateway, on page 21](#)

## Connecting to the Email Gateway

During the initial setup, you can connect to the email gateway in one of two ways:

**Table 3: Options for Connecting to the Email Gateway**

Ethernet	An Ethernet connection between a PC and the network and between the network and the Management port. The IPv4 address that has been assigned to the Management port by the factory is 192.168.42.42 . This is the easiest way to connect if it works with your network configuration.
Serial	A serial communications connection between the PC and the Serial Console port. If you cannot use the Ethernet method, a straight serial-to- serial connection between the computer and the email gateway will work until alternate network settings can be applied to the Management port. For pinout information, see <a href="#">Accessing the Email Gateway via a Serial Connection, on page 1307</a> . The communications settings for the serial port are:  <b>Bits per second:</b> 9600  <b>Data bits:</b> 8  <b>Parity:</b> None  <b>Stop bits:</b> 1  <b>Flow control:</b> Hardware



**Note** Keep in mind that the initial connection method is not final. This process applies only for the initial configuration. You can change network settings at a later time to allow different connection methods. (See [FTP, SSH, and SCP Access, on page 1303](#) for more information.) You can also create multiple user accounts with differing administrative privileges to access the email gateway. (For more information, see [Adding Users](#) , on page 976.)

## Determining Network and IP Address Assignments

You can use both IPv4 and IPv6 addresses.

- [Default IP Addresses for Management and Data Ports](#) , on page 22
- [Choosing Network Connections to Receive and Deliver Email](#) , on page 22
- [Binding Logical IP Addresses to Physical Ethernet Ports](#), on page 22
- [Choosing Network Settings for Your Connections](#), on page 22

### Default IP Addresses for Management and Data Ports

The IP address that is pre-configured on the Management port (the Data 1 port on C170 and C190 email gateways) is 192.168.42.42 .

### Choosing Network Connections to Receive and Deliver Email

Most users take advantage of the two Data Ethernet ports on the email gateway by connecting to two networks from the email gateway:

- The private network accepts and delivers messages to your internal systems.
- The public network accepts and delivers messages to the Internet.

Other users may want to use only one Data port serving both functions. Although the Management Ethernet port can support any function, it is preconfigured for access to the graphical user interface and the command line interface.

### Binding Logical IP Addresses to Physical Ethernet Ports

You can segregate incoming and outgoing email traffic over separate listeners and on separate IP addresses. You can use Internet Protocol version 4 (IPv4) and version 6 (IPv6) addresses. However, the System Setup Wizard on the email gateway supports initial configuration of the following configurations:

- 2 separate listeners on 2 logical IPv4 and 2 IPv6 addresses configured on *separate* physical interfaces
  - segregates incoming and outgoing traffic
  - you can assign an IPv4 and an IPv6 address to each listener
- 1 listener on 1 logical IPv4 address configured on one physical interface
  - combines both incoming and outgoing traffic
  - you can assign both an IPv4 and an IPv6 address to the listener

The email gateway can support both IPv4 and IPv6 addresses on single listener. The listener will accept mail on both the addresses. All settings on a listener apply to both IPv4 and IPv6 addresses.

### Choosing Network Settings for Your Connections

You will need the following network information about each Ethernet port that you choose to use:

- IP address (IPv4 or IPv6 or both)
- Netmask for IPv4 address in CIDR format
- Prefix for IPv6 address in CIDR format

In addition, you will need the following information about your overall network:

- IP address of the default router ( gateway) on your network

- IP address and hostname of your DNS servers (not required if you want to use Internet root servers)
- Hostname or IP address of your NTP servers (not required if you want to use Cisco's time servers)

See [Assigning Network and IP Addresses, on page 1309](#) for more information.



**Note** If you are running a firewall on your network between the Internet and the email gateway, it may be necessary to open specific ports for the email gateway to work properly. See [Firewall Information, on page 1331](#) for more information.

## Gathering the Setup Information

Now that you understand the requirements and strategies when making the necessary selections in the System Setup Wizard, use the following tables to gather information about your system setup while reading this section.

See [Assigning Network and IP Addresses, on page 1309](#) for more detailed information on network and IP addresses. See [Centralizing Services on a Cisco Secure Email and Web Manager \(M-Series\), on page 1291](#) if you are configuring a Cisco Secure Email and Web Manager.

**Table 4: System Setup Worksheet: 2 Listeners for Segregating Email Traffic**

<b>System Settings</b>		
Default System Hostname:		
Email System Alerts To:		
Deliver Scheduled Reports To:		
Time Zone Information:		
NTP Server:		
Admin Passphrase:		
SenderBase Network Participation:	Enable / Disable	
AutoSupport:	Enable / Disable	
Network Integration		
Gateway:		
DNS (Internet or Specify Own):		
Interfaces		
<b>Data 1 Port</b>		
IPv4 Address / Netmask:		
IPv6 Address / Prefix:		

<b>System Settings</b>		
Fully Qualified Hostname:		
Accept Incoming Mail:	<b>Domain</b>	<b>Destination</b>
Relay Outgoing Mail:	<b>System</b>	
<b>Data 2 Port</b>		
IPv4 Address / Netmask:		
IPv6 Address / Prefix:		
Fully Qualified Hostname:		
Accept Incoming Mail:	<b>Domain</b>	<b>Destination</b>
Relay Outgoing Mail:	<b>System</b>	
<b>Management Port</b>		
IP Address:		
Network Mask:		
IPv6 Address:		
Prefix:		
Fully Qualified Hostname:		
Accept Incoming Mail:	<b>Domain</b>	<b>Destination</b>
Relay Outgoing Mail:	<b>System</b>	
Message Security		
IP Reputation Filtering:	Enable / Disable	
Anti-Spam Scanning Engine	None / IronPort	
McAfee Anti-Virus Scanning Engine	Enable / Disable	
Sophos Anti-Virus Scanning Engine	Enable / Disable	
Outbreak Filters	Enable / Disable	

*Table 5: System Setup Worksheet: 1 Listener for All Email Traffic*

<b>System Settings</b>		
Default System Hostname:		



<b>System Settings</b>		
Email System Alerts To:		
Deliver Scheduled Reports To:		
Time Zone:		
NTP Server:		
Admin Passphrase:		
SenderBase Network Participation:	Enable / Disable	
AutoSupport:	Enable / Disable	
Network Integration		
Gateway:		
DNS (Internet or Specify Own):		
Interfaces		
<b>Data2 Port</b>		
IPv4 Address / Netmask:		
IPv6 Address / Prefix:		
Fully Qualified Hostname:		
Accept Incoming Mail:	<b>Domain</b>	<b>Destination</b>
Relay Outgoing Mail:	<b>System</b>	
<b>Data1 Port</b>		
IPv4 Address / Netmask:		
IPv6 Address / Prefix:		
Fully Qualified Hostname:		
Message Security		
IP Reputation Filtering:	Enable / Disable	
Anti-Spam Scanning Engine	None / IronPort	
McAfee Anti-Virus Scanning Engine	Enable / Disable	
Sophos Anti-Virus Scanning Engine	Enable / Disable	

<b>System Settings</b>		
Outbreak Filters	Enable / Disable	

## Using the System Setup Wizard

- [Accessing the Web-Based Graphical User Interface \(GUI\), on page 26](#)
- [Defining Basic Configuration Using the Web-Based System Setup Wizard , on page 28](#)
- [Setting up the Connection to Active Directory, on page 36](#)
- [Proceeding to the Next Steps, on page 37](#)
- [Accessing the Command Line Interface \(CLI\), on page 37](#)
- [Running the Command Line Interface \(CLI\) System Setup Wizard, on page 38](#)
- [Configuring your system as an Enterprise Gateway , on page 51](#)

You must use the System Setup Wizard for the initial setup in order to ensure a complete configuration. Later, you can configure custom options not available in the System Setup Wizard.

You can run the System Setup Wizard using a browser or the command line interface (CLI). For more information, see [Accessing the Web-Based Graphical User Interface \(GUI\), on page 26](#) or [Running the Command Line Interface \(CLI\) System Setup Wizard, on page 38](#)

Before you begin, complete the prerequisites at [Preparing for System Setup, on page 20](#).



---

**Caution** If you are setting up a virtual email gateway, you will have to use the `loadlicense` command to load your virtual email gateway license before running the System Setup Wizard. See the *Cisco Content Security Virtual Appliance Installation Guide* for more information.

---



---

**Caution** The System Setup Wizard will completely reconfigure your system. You should only use the System Setup Wizard the very first time you install the email gateway, or if you want to completely overwrite your existing configuration.

---



---

**Caution** The email gateway ships with a default IP address of 192.168.42.42 on the Management port of all hardware except C170 and C190 email gateways, which use the Data 1 port instead. Before connecting the email gateway to your network, ensure that no other device's IP address conflicts with this factory default setting. If you are configuring a Cisco Secure Email and Web Manager, see [Centralizing Services on a Cisco Secure Email and Web Manager \(M-Series\), on page 1291](#).

---

If you are connecting multiple factory-configured content security appliances to your network, add them one at a time, reconfiguring each appliance's default IP address as you go.

## Accessing the Web-Based Graphical User Interface (GUI)

The email gateway has a standard web-based graphical user interface, a new web-based interface for managing the Email Security Monitor feature (Monitoring, Tracking, and Quarantine), and a command-line interface.

To access the web-based Graphical User Interface (GUI), open your web browser and point it to 192.168.42.42.  
[New Web Interface Only] You can access the new web interface in any one of the following ways:



---

**Note** The new web interface of your email gateway uses AsyncOS API HTTP/HTTPS ports (6080/6443) and trailblazer HTTPS port (4431). You can use the `trailblazerconfig` command in the CLI to configure the trailblazer HTTPS ports. Make sure that the trailblazer HTTPS port is opened on the firewall.

---

- When `trailblazerconfig` CLI command is enabled, use the following URL -  
`https://example.com:<trailblazer-https-port>/ng-login`

where `example.com` is the email gateway host name and `<trailblazer-https-port>` is the trailblazer HTTPS port configured on the email gateway.

For more information on the `trailblazerconfig` CLI command, see the Cisco Secure Email Command Reference Guide.

- Log in to the legacy web interface and click **Secure Email Gateway is getting a new look. Try it!!** link to access the new web interface.

### Important Notes

- Make sure that AsyncOS API is enabled on the email gateway.
- Make sure that AsyncOS HTTPS API port is not enabled on multiple interfaces.
- You must login to the legacy web interface of the email gateway.
- If `trailblazerconfig` is enabled, the configured HTTPS port must be opened on the firewall. The default HTTPS port is 4431.

Also ensure that your DNS server can resolve the hostname that you specified for accessing the email gateway.

### Related Topics

- [Factory Default Username and Passphrase, on page 27](#)
- [Accessing New Web Interface in Dusk Mode, on page 28](#)

## Factory Default Username and Passphrase

If you install a new virtual or hardware email gateway, you must change the default passphrase to get complete access to set up the email gateway. When you log in to the email gateway for the first time, the web interface prompts you to change the default passphrase, and the CLI limits the access to the following commands till you change the default passphrase.

- Commit
- Interfaceconfig
- passphrase
- Loadconfig
- Systemsetup

- loadlicense (for virtual email gateways)
- feature key
- Ping
- Telnet
- netstat
- Username: `admin`
- Passphrase: `ironport`

For Example:

```
login: admin
passphrase: ironport
```



**Note** If your session times out, you will be asked to re-enter your username and passphrase. If your session times out while you are running the System Setup Wizard, you will have to start over again.

## Accessing the Legacy Web Interface

To access the legacy web interface from the new web interface, click on the gear icon  as shown in the following figure:

*Figure 3: Accessing the Legacy Web Interface from the*



The legacy web interface opens in a new browser window. You must log in again to access it.

If you want to log out of the appliance completely, you need to log out of both the new and legacy web interfaces of your email gateway.

## Accessing New Web Interface in Dusk Mode

Dusk Mode is a reversed color scheme that utilizes light-colored typography, UI elements, and iconography on dark backgrounds.

You can now access the new web interface of your email gateway using the dusk mode.

To switch to the dusk mode, click on the user icon on the top-right corner of the new web interface and select **Dusk Theme**.

## Defining Basic Configuration Using the Web-Based System Setup Wizard

### Procedure

**Step 1** Launch the System Setup Wizard

- Log in to the graphical user interface as described in [Accessing the Web-Based Graphical User Interface \(GUI\), on page 26](#).
- On brand new (not upgraded from previous releases of AsyncOS) systems, your browser will automatically be redirected to the System Setup Wizard.
- Otherwise, on the System Administration tab, click System Setup Wizard in the list of links on the left.

**Step 2** Start. See [Step 1: Start, on page 29](#).

- Read and accept the license agreement

**Step 3** System. See [Step 2: System, on page 30](#).

- Setting the hostname of the email gateway
- Configuring alert settings, report delivery settings, and AutoSupport
- Setting the system time settings, and NTP server
- Resetting the admin passphrase
- Enabling Service Logs

**Step 4** Network. See [Step 3: Network, on page 31](#).

- Defining the default router and DNS settings
- Enabling and configuring network interfaces, including:Configuring incoming mail (inbound listener)Defining SMTP routes (optional) Configuring outgoing mail (outbound listener) and defining systems allowed to relay mail through the email gateway (optional)

**Step 5** Security. Se [Step 4: Security, on page 35](#).

- Enabling IP Reputation Filtering
- Enabling the Anti-Spam service
- Enabling the Spam Quarantine
- Enabling the Anti-Virus service
- Enabling Advanced Malware Protection (file reputation and analysis services.)
- Enabling the Outbreak Filters service

**Step 6** Review. See [Step 5: Review, on page 36](#).

- Reviewing your setup and installing the configuration
- At the end of the process, you are prompted to

**Step 7** Commit the changes you have made.

Your changes will not take effect until they have been committed.

---

## Step 1: Start

Begin by reading the license agreement. Once you have read and agreed to the license agreement, check the box indicating that you agree and then click **Begin Setup** to proceed.

You can also view the text of the agreement here: <https://support.ironport.com/license/eula.html>

## Step 2: System

- [Setting the Hostname, on page 30](#)
- [Configuring System Alerts, on page 30](#)
- [Configuring Report Delivery, on page 30](#)
- [Setting the Time, on page 30](#)
- [Setting the Passphrase, on page 30](#)
- [Improving Phishing Detection Efficacy using Service Logs, on page 1125](#)
- [Enabling AutoSupport, on page 31](#)

### Setting the Hostname

Define the fully-qualified hostname for the email gateway. This name should be assigned by your network administrator.

### Configuring System Alerts

Cisco AsyncOS sends alert messages via email if there is a system error that requires the user's intervention. Enter the email address (or addresses) to which to send those alerts.

You must add at least one email address that receives System Alerts. Enter a single email address, or separate multiple addresses with commas. The email recipients initially receive all types of alerts at all levels, except for Directory Harvest Attack Prevention alerts. You can add more granularity to the alert configuration later. For more information, see [Alerts, on page 1047](#).

### Configuring Report Delivery

Enter the address to which to send the default scheduled reports. If you leave this value blank, the scheduled reports are still run. They will be archived on the email gateway rather than delivered.

### Setting the Time

Set the time zone on the email gateway so that timestamps in message headers and log files are correct. Use the drop-down menus to locate your time zone or to define the time zone via GMT offset (see [Selecting a GMT Offset, on page 1088](#) for more information).

You can set the system clock time manually later, or you can use the Network Time Protocol (NTP) to synchronize time with other servers on your network or the Internet. By default, one entry to the Cisco Systems time servers ( `time.ironport.com` ) to synchronize the time on your email gateway is already configured.

### Setting the Passphrase

Set the passphrase for the admin account. This is a required step. When changing the passphrase for the Cisco AsyncOS admin account, the new passphrase must be six characters or longer. Be sure to keep the passphrase in a secure location.

In addition to creating a login passphrase manually, you can also create a system-generated passphrase to log in to your email gateway.

### Enabling Service Logs

The 'Service Logs' are sent to the Cisco Talos Cloud service to improve Phishing detection.

If you enable Service Logs, the Cisco Email Security gateway collects limited personal data from customer emails and offers extensive useful threat detection capabilities that can be coupled with dedicated analysis systems to collect, trend, and correlate observed threat activity. Cisco uses the personal data to improve your

email gateway capabilities to analyze the threat landscape, provide threat classification solutions on malicious emails, and to protect your email gateway from new threats such as spam, virus, and directory harvest attacks.

See [Improving Phishing Detection Efficacy using Service Logs, on page 1125](#) for more information.

## Enabling AutoSupport

The AutoSupport feature (enabled by default) keeps the Cisco Customer Support team aware of issues with your email gateway so that we can provide better support to you. (For more information, see [AutoSupport, on page 1047](#).)

Click **Next** to continue.

## Step 3: Network

In Step 3, you define the default router (gateway) and configure the DNS settings, and then set up the email gateway to receive and or relay email by configuring the Data 1, Data 2, and Management interfaces.

- [Configuring DNS and Default Gateway, on page 31](#)
- [Configuring Network Interfaces, on page 31](#)
- [Accepting Mail, on page 32](#)
- [Relaying Mail \(Optional\), on page 33](#)
- [C170 and C190 Installations, on page 34](#)

### Configuring DNS and Default Gateway

Type the IP address of the default router (gateway) on your network. You can use an IPv4 address, an IPv6 address, or both.

Next, configure the DNS (Domain Name Service) settings. Cisco AsyncOS contains a high-performance internal DNS resolver/cache that can query the Internet's root servers directly, or the system can use DNS servers you specify. If you choose to use your own servers, you will need to supply the IP address and hostname of each DNS server. You can enter up to four DNS servers via the System Setup Wizard. Please note that DNS servers you enter will have an initial priority of 0. For more information, see [Configuring Domain Name System \(DNS\) Settings, on page 1070](#).



---

**Note** The email gateway requires access to a working DNS server in order to perform DNS lookups for incoming connections. If you cannot specify a working DNS server that is reachable by the email gateway while you are setting up the email gateway, a workaround is to either select “Use Internet Root DNS Servers” or to specify, temporarily, the IP address of the Management interface so that you can complete the System Setup Wizard.

---

### Configuring Network Interfaces

Your email gateway has network interfaces that are associated with the physical Ethernet ports on the machine.

To use an interface, mark the “Enable” checkbox and then specify an IP address, network mask, and fully qualified hostname. The IP address you enter should be the address intended for your inbound mail as reflected in your DNS records. Typically this address would have an MX record associated with it in DNS. You can use an IPv4 address, an IPv6 address, or both. If you use both, the interface will accept both types of connections.

Each interface can be configured to accept mail (incoming), relay email (outgoing), or appliance management. During setup, you are limited to one of each. On most email gateways, you would typically use one interface for incoming, one for outgoing, and one for appliance management. On the C170 and C190 email gateways, you would typically use one interface for both incoming and outgoing mail, and the other interface for management.

You must configure one interface to receive email.

Assign and configure a logical IP address to one of the physical Ethernet interfaces on the email gateway. If you decide to use both the Data 1 Ethernet port and the Data 2 Ethernet port, you need this information for both connections.

**For C390, and C690 appliances:** Cisco recommends using one of the physical Ethernet ports to connect directly to the Internet for the purposes of receiving inbound email through public listeners, and using another physical Ethernet port to connect directly to your internal network for the purposes of relaying outbound email through private listeners.

**For C190 appliances:** Typically, the System Setup Wizard will configure only one physical Ethernet port with one listener for both receiving inbound email and relaying outbound email.

See [Binding Logical IP Addresses to Physical Ethernet Ports, on page 22](#).

The following information is required:

- The **IP address** assigned by your network administrator. This can be an IPv4 address, an IPv6 address, or both.
- For IPv4 addresses: the **netmask** of the interface. AsyncOS only accepts a netmask in CIDR format. For example, /24 for the 255.255.255.0 subnet.  
For IPv6 addresses: the **prefix** in CIDR format. For example /64 for a 64-bit prefix.
- (optional) A fully-qualified hostname for the IP address.



---

**Note** IP addresses within the same subnet cannot be configured on separate physical Ethernet interfaces. See [Assigning Network and IP Addresses, on page 1309](#) for more detailed information on Network and IP Address configuration.

---

## Accepting Mail

When configuring your interfaces to accept mail, you define:

- the domain for which to accept mail
- destination (SMTP Route) for each domain, this is optional

Mark the checkbox for Accept Incoming Mail to configure the interface to accept mail. Enter the name of the domain for which to accept mail.

Enter the Destination. This is the SMTP Route or name of the machine(s) where you would like to route email for the domains specified.

This is the first SMTP Routes entry. The SMTP Routes table allows you to redirect all email for each domain (also known as a Recipient Access Table (RAT) entry) you enter to a specific mail exchange (MX) host. In typical installations, the SMTP Routes table defines the specific groupware (for example, Microsoft Exchange) server or the “next hop” in the email delivery for your infrastructure.



For example, you can define a route that specifies that mail accepted for the domain `example.com` and all of its subdomains `.example.com` is routed to the groupware server `exchange.example.com`.

You can enter multiple domains and destinations. Click **Add Row** to add another domain. Click the trash can icon to remove a row.



---

**Note** Configuring SMTP Routes in this step is optional. If no SMTP routes are defined, the system will use DNS to lookup and determine the delivery host for the incoming mail received by the listener. (See [Routing Email for Local Domains, on page 693.](#))

---

You must add at least one domain to the Recipient Access Table. Enter a domain — `example.com`, for example. To ensure that mail destined for any subdomain of `example.net` will match in the Recipient Access Table, enter `.example.net` as well as the domain name. For more information, see [Defining Recipient Addresses, on page 124.](#)

## Relaying Mail (Optional)

When configuring your interfaces to relay mail, you define the systems allowed to relay email through the email gateway.

These are entries in the RELAYLIST of the Host Access Table for a listener. See [Sender Group Syntax, on page 91](#) for more information.

Mark the check box for Relay Outgoing Mail to configure the interface to relay mail. Enter the hosts that may relay mail through the email gateway.

When you configure an interface to relay outbound mail, the System Setup Wizard turns on SSH for the interface as long as no public listeners are configured to use the interface.

In the following example, two interfaces with IPv4 addresses are created:

- 192.168.42.42 remains configured on the Management interface.
- 192.168.1.1 is enabled on the Data 1 Ethernet interface. It is configured to accept mail for domains ending in `.example.com` and an SMTP route is defined for `exchange.example.com`.
- 192.168.2.1 is enabled on the Data 2 Ethernet interface. It is configured to relay mail from `exchange.example.com`.

## C390, and C690 Installations

Figure 4: Network Interfaces: 2 Interfaces in Addition to Management (Segregated Traffic)

Enable Data 1 Interface	
<i>This interface is typically configured to accept mail.</i>	
IPv4 Address / Netmask:	1.1.1.1/24
IPv6 Address / Prefix:	2001:db8:1::4/64
Fully Qualified Hostname:	<input type="text"/> <i>Fully qualified hostname for this appliance</i>
Accept Incoming Mail:	<input type="checkbox"/> Accept mail on this interface
Relay Outgoing Mail:	<input type="checkbox"/> Relay mail on this interface
Enable Data 2 Interface	
<i>This interface is typically configured to relay mail.</i>	
IPv4 Address / Netmask:	1.1.1.2/24
IPv6 Address / Prefix:	2001:db8:1::4/64
Fully Qualified Hostname:	<input type="text"/> <i>Fully qualified hostname for this appliance</i>
Accept Incoming Mail:	<input type="checkbox"/> Accept mail on this interface
Relay Outgoing Mail:	<input type="checkbox"/> Relay mail on this interface
Enable Management Interface	
<i>This interface is typically configured for system administration.</i>	
IPv4 Address / Netmask:	1.1.1.2/24
IPv6 Address / Prefix:	2001:db8:1::4/64
Fully Qualified Hostname:	mail.example.com <i>Fully qualified hostname for this appliance</i>
Accept Incoming Mail:	<input type="checkbox"/> Accept mail on this interface
Relay Outgoing Mail:	<input type="checkbox"/> Relay mail on this interface

## C170 and C190 Installations

For C170 and C190 appliances, the Data 2 interface is typically configured for both incoming and outgoing mail while the Data 1 interface is used for appliance management.

When configuring a single IP address for all email traffic (nonsegregated traffic), step 3 of the System Setup Wizard will look like this:

Figure 5: Network Interfaces: 1 IP Address for Incoming and Outgoing (Nonsegregated) Traffic

Enable Data 2 Interface										
<i>This interface is typically used to accept and relay mail.</i>										
IP Address:	192.168.1.1									
Network Mask:	255.255.255.0									
Fully Qualified Hostname:	mail3.example.com <i>Fully qualified hostname for this appliance</i>									
Accept Incoming Mail:	<input checked="" type="checkbox"/> Accept mail on this interface									
<table border="1"> <thead> <tr> <th>Domain ?</th> <th>Destination</th> <th>Add Row</th> </tr> </thead> <tbody> <tr> <td>example.com</td> <td>exchange.example.com</td> <td><input type="button" value="Add Row"/></td> </tr> <tr> <td>example: company.com</td> <td><i>i.e. An Exchange or Notes server</i></td> <td><input type="button" value="Add Row"/></td> </tr> </tbody> </table>		Domain ?	Destination	Add Row	example.com	exchange.example.com	<input type="button" value="Add Row"/>	example: company.com	<i>i.e. An Exchange or Notes server</i>	<input type="button" value="Add Row"/>
Domain ?	Destination	Add Row								
example.com	exchange.example.com	<input type="button" value="Add Row"/>								
example: company.com	<i>i.e. An Exchange or Notes server</i>	<input type="button" value="Add Row"/>								
Relay Outgoing Mail:	<input checked="" type="checkbox"/> Relay mail on this interface									
<table border="1"> <thead> <tr> <th>System ?</th> <th>Add Row</th> </tr> </thead> <tbody> <tr> <td>exchange.example.com</td> <td><input type="button" value="Add Row"/></td> </tr> <tr> <td>example: company.com</td> <td><input type="button" value="Add Row"/></td> </tr> </tbody> </table>		System ?	Add Row	exchange.example.com	<input type="button" value="Add Row"/>	example: company.com	<input type="button" value="Add Row"/>			
System ?	Add Row									
exchange.example.com	<input type="button" value="Add Row"/>									
example: company.com	<input type="button" value="Add Row"/>									
Enable Data 1 Interface										
<i>This interface is typically used for system administration. (You are currently connected to this interface.)</i>										
IP Address:	192.168.42.42									
Network Mask:	255.255.255.0									
Fully Qualified Hostname:	mail.example.com <i>Fully qualified hostname for this appliance</i>									
Accept Incoming Mail:	<input type="checkbox"/> Accept mail on this interface									
Relay Outgoing Mail:	<input type="checkbox"/> Relay mail on this interface									

Click **Next** to continue.

## Step 4: Security

In step 4, you configure anti-spam and anti-virus settings. The anti-spam options include IP Reputation Filtering and selecting an anti-spam scanning engine. For anti-virus, you can enable Outbreak Filters and Sophos or McAfee anti-virus scanning.

- [Enabling IP Reputation Filtering, on page 35](#)
- [Enabling Anti-Spam Scanning, on page 35](#)
- [Enabling Anti-Virus Scanning, on page 35](#)
- [Enabling Advanced Malware Protection \(File Reputation and Analysis Services\) , on page 35](#)
- [Enabling Outbreak Filters, on page 36](#)

### Enabling IP Reputation Filtering

The IP Reputation Service can be used as a stand-alone anti-spam solution, but it is primarily designed to improve the effectiveness of a content-based anti-spam system such as Anti-Spam.

The IP Reputation Service provides an accurate, flexible way for users to reject or throttle suspected spam based on the connecting IP address of the remote host. The IP Reputation Service returns a score based on the probability that a message from a given source is spam. The IP Reputation Service is unique in that it provides a global view of email message volume and organizes the data in a way that makes it easy to identify and group related sources of email. Cisco strongly suggests that you enable IP Reputation Filtering.

Once enabled, IP Reputation Filtering is applied on the incoming (accepting) listener.

### Enabling Anti-Spam Scanning

Your email gateway may ship with a 30-day evaluation key for Anti-Spam software. During this portion of the System Setup Wizard, you can choose to enable Anti-Spam globally on the email gateway. You can also elect to not enable the service.

If you choose to enable the anti-spam service, you can configure AsyncOS to send spam and suspected spam messages to the local Spam Quarantine. The Spam Quarantine serves as the end-user quarantine for the email gateway. Only administrators can access the quarantine until end-user access is configured.

See [Managing Spam and Graymail, on page 379](#) for all of the Anti-Spam configuration options available on the email gateway. See [Policy, Virus, and Outbreak Quarantines, on page 923](#).

### Enabling Anti-Virus Scanning

Your email gateway may ship with a 30-day evaluation key for the Sophos Anti-Virus or McAfee Anti-Virus scanning engines. During this portion of the System Setup Wizard, you can choose to enable an anti-virus scanning engine globally on the email gateway.

If you choose to enable an anti-virus scanning engine, it is enabled for both the default incoming and default outgoing mail policies. The email gateway scans mail for viruses, but it does not repair infected attachments. The email gateway drops infected messages.

See [Anti-Virus, on page 361](#) for all of the anti-virus configuration options available on the email gateway.

### Enabling Advanced Malware Protection (File Reputation and Analysis Services)

Advanced Malware Protection obtains reputation information about attached files from a cloud-based service.

For more information, see [File Reputation Filtering and File Analysis, on page 477](#)

## Enabling Outbreak Filters

Your email gateway may ship with a 30-day evaluation key for Outbreak Filters. Outbreak Filters provide a “first line of defense” against new virus outbreaks by quarantining suspicious messages until traditional anti-virus security services can be updated with a new virus signature file.

See [Outbreak Filters, on page 421](#) for more information.

Click **Next** to continue.

## Step 5: Review

A summary of the configuration information is displayed. You can edit the System Settings, Network Integration, and Message Security information by clicking the **Previous** button or by clicking the corresponding **Edit** link in the upper-right of each section. When you return to a step to make a change, you must proceed through the remaining steps until you reach this review page again. All settings you previously entered will be remembered.

Once you are satisfied with the information displayed click **Install This Configuration**.

A confirmation dialog is displayed. Click **Install** to install the new configuration.

Your email gateway is now ready to send email.



---

**Note** Clicking **Install** will cause the connection to the current URL (<http://192.168.42.42>) to be lost if you changed the IP address of the interface you used to connect to the email gateway from the default. However, your browser will be redirected to the new IP address.

---

Once System Setup is complete, several alert messages are sent. See [Immediate Alerts, on page 51](#) for more information.

## Setting up the Connection to Active Directory

If the System Setup Wizard properly installs the configuration on the email gateway, the Active Directory Wizard appears. If you are running an Active Directory server on your network, use the Active Directory Wizard to configure an LDAP server profile for the Active Directory server and assign a listener for recipient validation. If you are not using Active Directory or want to configure it later, click Skip this Step. You can run the Active Directory Wizard on the **System Administration > Active Directory Wizard** page. You can also configure Active Directory and other LDAP profiles on the **System Administration > LDAP** page.

The Active Directory Wizard retrieves the system information needed to create an LDAP server profile, such as the authentication method, the port, the base DN, and whether SSL is supported. The Active Directory Wizard also creates LDAP accept and group queries for the LDAP server profile.

After the Active Directory Wizard creates the LDAP server profile, use the **System Administration > LDAP** page to view the new profile and make additional changes

### Procedure

---

- Step 1** On the Active Directory Wizard page, click **Run Active Directory Wizard**.
- Step 2** Enter the host name for the Active Directory server.

- Step 3** Enter a username and passphrase for the authentication request.
- Step 4** Click **Next** to continue.
- The Active Directory Wizard tests the connection to the Active Directory server. If successful, the Test Directory Settings page is displayed.
- Step 5** Test the directory settings by entering an email address that you know exists in the Active Directory and clicking **Test**. The results appear in the connection status field.
- Step 6** Click **Done**.
- 

## Proceeding to the Next Steps

After you successfully configure your email gateway to work with your Active Directory Wizard, or skip the process, the System Setup Next Steps page appears.

Click the links on the System Setup Next Steps page to proceed with the configuration of your email gateway.

## Accessing the Command Line Interface (CLI)

Access to the CLI varies depending on the management connection method you chose in [Connecting to the Email Gateway, on page 21](#). The factory default username and passphrase are listed next. Initially, only the admin user account has access to the CLI. You can add other users with differing levels of permission after you have accessed the command line interface for the first time via the admin account. (For information about adding users, see [Adding Users, on page 976](#).) The System Setup Wizard asks you to change the passphrase for the admin account. The passphrase for the admin account can also be reset directly at any time using the `passphrase` command.

To connect via Ethernet: Start an SSH session with the factory default IP address 192.168.42.42. SSH is configured to use port 22. Enter the username and passphrase below.

To connect via a Serial connection: Start a terminal session with the communication port on your personal computer that the serial cable is connected to. Use the settings for serial port outlined in [Connecting to the Email Gateway, on page 21](#). Enter the username and passphrase below.

Log in to the email gateway by entering the username and passphrase.

### Related Topics

- [Factory Default Username and Passphrase, on page 27](#)

## Factory Default Username and Passphrase

If you install a new virtual or hardware email gateway, you must change the default passphrase to get complete access to set up the email gateway. When you log in to the email gateway for the first time, the web interface prompts you to change the default passphrase, and the CLI limits the access to the following commands till you change the default passphrase.

- Commit
- Interfaceconfig
- passphrase

- Loadconfig
- Systemsetup
- loadlicense (for virtual email gateways)
- feature key
- Ping
- Telnet
- netstat
- Username: `admin`
- Passphrase: `ironport`

For Example:

```
login: admin
passphrase: ironport
```



---

**Note** If your session times out, you will be asked to re-enter your username and passphrase. If your session times out while you are running the System Setup Wizard, you will have to start over again.

---

## Running the Command Line Interface (CLI) System Setup Wizard

The CLI version of the System Setup Wizard basically mirrors the steps in the GUI version, with a few minor exceptions:

- The CLI version includes prompts to enable the web interface.
- The CLI version allows you to edit the default Mail Flow Policy for each listener you create.
- The CLI version contains prompts for configuring the global Anti-Virus and Outbreak Filters security settings.
- The CLI version does not prompt you to create an LDAP profile after the system setup is complete. Use the `ldapconfig` command to create an LDAP profile.

To run the System Setup Wizard, type `systemsetup` at the command prompt.

```
IronPort> systemsetup
```

The System Setup Wizard warns you that you will reconfigure your system. If this is the very first time you are installing the email gateway, or if you want to completely overwrite your existing configuration, answer “Yes” to this question.

```
WARNING: The system setup wizard will completely delete any existing
```

```
'listeners' and all associated settings including the 'Host Access Table' -
mail operations may be interrupted.
```

```
Are you sure you wish to continue? [Y]> Y
```



---

**Note** The remainder of the system setup steps are described below. Examples of the CLI System Setup Wizard dialogue will only be included for sections that deviate from the GUI System Setup Wizard described above in [Defining Basic Configuration Using the Web-Based System Setup Wizard](#) , on page 28.

---

### Related Topics

- [Change the Admin Passphrase, on page 39](#)
- [Accept the License Agreement, on page 39](#)
- [Set the Hostname , on page 39](#)
- [Assign and Configure Logical IP Interface\(s\), on page 40](#)
- [Specify the Default Gateway, on page 40](#)
- [Enable the Web Interface, on page 41](#)
- [Configure the DNS Settings, on page 41](#)
- [Create a Listener, on page 41](#)
- [Enable Anti-Spam, on page 48](#)
- [Select a Default Anti-Spam Scanning Engine, on page 49](#)
- [Enable the Spam Quarantine, on page 49](#)
- [Enable Anti-Virus Scanning, on page 49](#)
- [Enable Outbreak Filters , on page 49](#)
- [Configure the Alert Settings and AutoSupport, on page 50](#)
- [Configure Scheduled Reporting, on page 50](#)
- [Configure Time Settings, on page 50](#)
- [Commit Changes, on page 50](#)
- [Test the Configuration, on page 50](#)
- [Immediate Alerts, on page 51](#)

## Change the Admin Passphrase

First, you change the passphrase for the AsyncOS admin account. You must enter the old passphrase to continue. The new passphrase must be six characters or longer. Be sure to keep the passphrase in a secure location. Changes made to the passphrase are effective once the system setup process is finished.

In addition to creating a login passphrase manually, you can also create a system-generated passphrase to log in to your email gateway.

## Accept the License Agreement

Read and accept the software license agreement that is displayed.

## Set the Hostname

Next, you define the fully-qualified hostname for the email gateway. This name should be assigned by your network administrator.

## Assign and Configure Logical IP Interface(s)

The next step assigns and configures a logical IP interface on the physical Ethernet interface named Management (on C390, and C690 appliances) or Data 1 (on C190 appliances), and then prompts you to configure a logical IP interface on any other physical Ethernet interfaces available on the email gateway.

Each Ethernet interface can have multiple IP interfaces assigned to it. An IP interface is a logical construct that associates an IP address and hostname with a physical Ethernet interface. If you decided to use both the Data 1 and Data 2 Ethernet ports, you need the IP addresses and hostnames for both connections.

**For C390, and C690 appliances:** Cisco recommends using one of the physical Ethernet ports to connect directly to the Internet for the purposes of receiving inbound email through public listeners, and using another physical Ethernet port to connect directly to your internal network for the purposes of relaying outbound email through private listeners.

**For C190 appliances:** By default, the `systemsetup` command will configure only one physical Ethernet port with one listener for receiving inbound email and relaying outbound email.



---

**Note** When you configure an interface to relay outbound mail, the system turns on SSH for the interface as long as no public listeners are configured to use the interface.

---

The following information is required:

- A **name** (nickname) created by you to refer to the IP interface later. For example, if you are using one Ethernet port for your private network and the other for the public network, you may want to name them PrivateNet and PublicNet, respectively.



---

**Note** The names you define for interfaces are case-sensitive. AsyncOS will not allow you to create two identical interface names. For example, the names `Privatenet` and `PrivateNet` are considered as two *different* (unique) names.

---

- The **IP address** assigned by your network administrator. This can be an IPv4 or IPv6 address. You can assign both types of IP addresses to a single IP interface.
- The **netmask** of the interface. The netmask must be in CIDR format. For example, use `/24` for the `255.255.255.0` subnet.



---

**Note** IP addresses within the same subnet cannot be configured on separate physical Ethernet interfaces. See [Assigning Network and IP Addresses, on page 1309](#) for more detailed information on Network and IP Address configuration.

For C190 appliances, the Data 2 interface is configured first.

---

## Specify the Default Gateway

In the next portion of the `systemsetup` command, you type the IP address of the default router (gateway) on your network.



## Enable the Web Interface

In the next portion of the `systemsetup` command, you enable the web interface for the email gateway (for the Management Ethernet interface). You can also choose to run the web interface over secure HTTP ( `https` ). If you choose to use HTTPS, the system will use a demonstration certificate until you upload your own certificate.

## Configure the DNS Settings

Next, you configure the DNS (Domain Name Service) settings. Cisco AsyncOS contains a high-performance internal DNS resolver/cache that can query the Internet's root servers directly, or the system can use your own DNS servers. If you choose to use your own servers, you will need to supply the IP address and hostname of each DNS server. You can enter as many DNS servers as you need (each server will have a priority of 0.). By default, `systemsetup` prompts you to enter the addresses for your own DNS servers.

## Create a Listener

A “listener” manages inbound email processing services that will be configured on a particular IP interface. Listeners only apply to email entering the email gateway — either from your internal systems or from the Internet. Cisco AsyncOS uses listeners to specify criteria that messages must meet in order to be accepted and relayed to recipient hosts. You can think of a listener as an email listener (or even a “SMTP daemon”) running for IP addresses you specified above.

**For C390, and C690 appliances:** By default, the `systemsetup` command configures two listeners — one public and one private. (For more information on the types of listeners available, see [Configuring the Gateway to Receive Email, on page 65.](#))

**For C190 appliances:** By default, the `systemsetup` command configures one public listener for both receiving mail from the Internet and for relaying email from your internal network. See [Listener Example for C190 Appliances , on page 46.](#)

When you define a listener, you specify the following attributes:

- A **name** (nickname) created by you to refer to the listener later. For example, the listener that accepts email from your internal systems to be delivered to the Internet may be called `OutboundMail`.
- One of the IP interfaces (that you created earlier in the `systemsetup` command) on which to receive email.
- The name of the machine(s) to which you want to route email (public listeners only). (This is the first `smtproutes` entry. See [Routing Email for Local Domains, on page 693.](#))
- Whether or not to enable filtering based on IP Reputation Scores for public listeners. If enabled, you are also prompted to select between Conservative, Moderate, or Aggressive settings.
- Rate-limiting per host: the maximum number of recipients per hour you are willing to receive from a remote host (public listeners only).
- The recipient domains or specific addresses you want to accept email for (public listeners) or the systems allowed to relay email through the email gateway (private listeners). (These are the first Recipient Access Table and Host Access Table entries for a listener. See [Sender Group Syntax, on page 91](#) and [Adding Domains and Users For Which to Accept Messages, on page 123](#) for more information.)

### Related Topics

- [Public Listener, on page 42](#)
- [Private Listener, on page 44](#)
- [Listener Example for C190 Appliances , on page 46](#)

## Public Listener



**Note** The following examples of creating a public and private listener apply to C390, and C690 appliances only. For C190 appliances, skip to the next section, [Listener Example for C190 Appliances](#), on page 46.

In this example portion of the `systemsetup` command, a public listener named `InboundMail` is configured to run on the `PublicNet` IP interface. Then, it is configured to accept all email for the domain `example.com`. An initial SMTP route to the mail exchange `exchange.example.com` is configured. Rate limiting is enabled, and the maximum value of 4500 recipients per hour from a single host is specified for the public listener.



**Note** The value you enter for maximum recipients per hour you are willing to receive from a remote host is a completely arbitrary value, one that is usually relative to the size of the enterprise for which you are administering email. For example, a sender who sends 200 messages in an hour might be considered a “spammer” (sender of unsolicited bulk email), but if you are configuring the email gateway to handle all email for a 10,000 person company, 200 messages per hour from a remote host may be a reasonable value. Conversely, in a 50-person company, someone sending 200 messages in an hour to you may be an obvious spammer. You must choose an appropriate value when you enable rate-limiting on a public listener (throttle) inbound email for your enterprise. For more information on Default Host Access policies, see [Sender Group Syntax](#), on page 91.

The default host access policy for the listener is then accepted.

You are now going to configure how the appliance accepts mail by

creating a "Listener".

Please create a name for this listener (Ex: "InboundMail"):

```
[ ]> InboundMail
```

Please choose an IP interface for this Listener.

```
1. Management (192.168.42.42/24: mail3.example.com)
```

```
2. PrivateNet (192.168.1.1/24: mail3.example.com)
```

```
3. PublicNet (192.168.2.1/24: mail3.example.com)
```

```
[1]> 3
```

Enter the domains or specific addresses you want to accept mail for.

Hostnames such as "example.com" are allowed.

Partial hostnames such as ".example.com" are allowed.

Usernames such as "postmaster@" are allowed.

Full email addresses such as "joe@example.com" or "joe@[1.2.3.4]" are allowed.

Separate multiple addresses with commas.

```
[ ]> example.com
```

Would you like to configure SMTP routes for example.com? [Y]> **y**

Enter the destination mail server which you want mail for example.com to be delivered.  
Separate multiple entries with commas.

```
[ ]> exchange.example.com
```

Do you want to enable rate limiting for this listener? (Rate limiting defines the maximum  
number  
of recipients per hour you are willing to receive from a remote domain.) [Y]> **y**

Enter the maximum number of recipients per hour to accept from a remote domain.

```
[ ]> 4500
```

Default Policy Parameters

=====

Maximum Message Size: 100M

Maximum Number Of Connections From A Single IP: 1,000

Maximum Number Of Messages Per Connection: 1,000

Maximum Number Of Recipients Per Message: 1,000

Maximum Number Of Recipients Per Hour: 4,500

Maximum Recipients Per Hour SMTP Response:

```

452 Too many recipients received this hour

Use SenderBase for Flow Control: Yes

Virus Detection Enabled: Yes

Allow TLS Connections: No

Would you like to change the default host access policy? [N]> n

Listener InboundMail created.

Defaults have been set for a Public listener.

Use the listenerconfig->EDIT command to customize the listener.

*****

```

## Private Listener

In this example portion of the `systemsetup` command, a private listener named `OutboundMail` is configured to run on the PrivateNet IP interface. Then, it is configured to relay all email for all hosts within the domain `example.com`. (Note the dot at the beginning of the entry: `.example.com`)

The default value for rate limiting (not enabled) and the default host access policy for this listener are then accepted.

Note that the default values for a private listener differ from the public listener created earlier. For more information, see [Working with Listeners, on page 66](#).

```
Do you want to configure the appliance to relay mail for internal hosts? [Y]> y
```

```
Please create a name for this listener (Ex: "OutboundMail"):
```

```
[ ]> OutboundMail
```

```
Please choose an IP interface for this Listener.
```

1. Management (192.168.42.42/24: mail3.example.com)
2. PrivateNet (192.168.1.1/24: mail3.example.com)
3. PublicNet (192.168.2.1/24: mail3.example.com)

```
[1]> 2
```

Please specify the systems allowed to relay email through the appliance.

Hostnames such as "example.com" are allowed.

Partial hostnames such as ".example.com" are allowed.

IP addresses, IP address ranges, and partial IP addresses are allowed.

Separate multiple entries with commas.

```
[ ]> .example.com
```

Do you want to enable rate limiting for this listener?  
(Rate limiting defines the maximum number of recipients per hour you are willing  
to receive from a remote domain.) [N]> n

Default Policy Parameters

=====

Maximum Message Size: 100M

Maximum Number Of Connections From A Single IP: 600

Maximum Number Of Messages Per Connection: 10,000

Maximum Number Of Recipients Per Message: 100,000

Maximum Number Of Recipients Per Hour: Disabled

Use SenderBase for Flow Control: No

Virus Detection Enabled: Yes

Allow TLS Connections: No

Would you like to change the default host access policy? [N]> n

Listener OutboundMail created.

Defaults have been set for a Private listener.

Use the listenerconfig->EDIT command to customize the listener.

\*\*\*\*\*

## Listener Example for C190 Appliances



**Note** The following example of creating a listener applies to C170 and C190 appliances only.

In this example portion of the `systemsetup` command, a listener named `MailInterface` is configured to run on the MailNet IP interface. Then, it is configured to accept all email for the domain `example.com`. An initial SMTP route to the mail exchange `exchange.example.com` is configured. Then, the same listener is configured to relay all email for all hosts within the domain `example.com`. (Note the dot at the beginning of the entry: `.example.com`)

Rate limiting is enabled, and the maximum value of 450 recipients per hour from a single host is specified for the public listener.



**Note** The value you enter for maximum recipients per hour you are willing to receive from a remote host is a completely arbitrary value, one that is usually relative to the size of the enterprise for which you are administering email. For example, a sender who sends 200 messages in an hour might be considered a “spammer” (sender of unsolicited bulk email), but if you are configuring the email gateway to handle all email for a 10,000 person company, 200 messages per hour from a remote host may be a reasonable value. Conversely, in a 50-person company, someone sending 200 messages in an hour to you may be an obvious spammer. You must choose an appropriate value when you enable rate-limiting on a public listener (throttle) inbound email for your enterprise. For more information on Default Host Access policies, see [Sender Group Syntax, on page 91](#).

The default host access policy for the listener is then accepted.

You are now going to configure how the appliance accepts mail by creating a "Listener".

Please create a name for this listener (Ex: "MailInterface"):

```
[ ]> MailInterface
```

Please choose an IP interface for this Listener.

1. MailNet (10.1.1.1/24: mail3.example.com)
2. Management (192.168.42.42/24: mail3.example.com)

```
[1]> 1
```

Enter the domain names or specific email addresses you want to accept mail for.

Hostnames such as "example.com" are allowed.

Partial hostnames such as ".example.com" are allowed.

Username such as "postmaster@" are allowed.

Full email addresses such as "joe@example.com" or "joe@[1.2.3.4]" are allowed.

Separate multiple addresses with commas.

```
[ ]> example.com
```

Would you like to configure SMTP routes for example.com? [Y]> **y**

Enter the destination mail server where you want mail for example.com to be delivered.  
Separate multiple entries with commas.

```
[ ]> exchange.example.com
```

Please specify the systems allowed to relay email through the appliance.

Hostnames such as "example.com" are allowed.

Partial hostnames such as ".example.com" are allowed.

IP addresses, IP address ranges, and partial IP addresses are allowed.

Separate multiple entries with commas.

```
[ ]> .example.com
```

Do you want to enable rate limiting for this listener?  
(Rate limiting defines the maximum number of recipients per hour you are willing  
to receive from a remote domain.) [Y]> **y**

Enter the maximum number of recipients per hour to accept from a remote domain.

```
[ ]> 450
```

Default Policy Parameters

```
=====
```

```

Maximum Message Size: 10M

Maximum Number Of Connections From A Single IP: 50

Maximum Number Of Messages Per Connection: 100

Maximum Number Of Recipients Per Message: 100

Maximum Number Of Recipients Per Hour: 450

Maximum Recipients Per Hour SMTP Response:

    452 Too many recipients received this hour

Use SenderBase for Flow Control: Yes

Spam Detection Enabled: Yes

Virus Detection Enabled: Yes

Allow TLS Connections: No

Would you like to change the default host access policy? [N]>

Listener MailInterface created.

Defaults have been set for a Public listener.

Use the listenerconfig->EDIT command to customize the listener.

*****

```



---

**Note** Because the `systemsetup` command only configures one listener for both inbound and outbound mail for C170 and C190 appliances, all outgoing mail will be calculated in the Mail Flow Monitor feature (which is normally used for inbound messages). See [Using Email Security Monitor, on page 829](#)

---

## Enable Anti-Spam

Your email gateway ships with a 30-day evaluation key for the Anti-Spam software. During this portion of the `systemsetup` command, you can choose to accept the license agreements and enable Anti-Spam globally on the email gateway.

Anti-Spam scanning will then be enabled on the incoming mail policy.





---

**Note** If you do not accept the license agreement, Anti-Spam is not enabled on the email gateway.

---

See [Managing Spam and Graymail, on page 379](#) for all of the Anti-Spam configuration options available on the email gateway.

## Select a Default Anti-Spam Scanning Engine

If you have enabled more than one anti-spam scanning engine, you are prompted to select which engine will be enabled for use on the default incoming mail policy.

## Enable the Spam Quarantine

If you choose to enable an anti-spam service, you can enable the incoming mail policy to send spam and suspected spam messages to the local Spam Quarantine. Enabling the Spam Quarantine also enables the end-user quarantine on the email gateway. Only administrators can access the end-user quarantine until end-user access is configured.

See [Setting Up the Local Spam Quarantine, on page 944](#).

## Enable Anti-Virus Scanning

Your email gateway ships with a 30-day evaluation key for virus scanning engines. During this portion of the `systemsetup` command, you can choose to accept one or more license agreements and enable anti-virus scanning on the email gateway. You must accept a license agreement for each anti-virus scanning engine you want to enable on your email gateway.

After you accept the agreement, the anti-virus scanning engine you selected is enabled on the incoming mail policy. The email gateway scans incoming mail for viruses, but it does not repair infected attachments. The appliance drops infected messages.

See [Anti-Virus, on page 361](#) for the anti-virus configuration options available on the email gateway.

## Enable Outbreak Filters

This next step prompts you to enable Outbreak Filters. Your email gateway ships with a 30-day evaluation key for Outbreak Filters.

### Related Topics

- [Outbreak Filters, on page 49](#)

## Outbreak Filters

Outbreak Filters provide a “first line of defense” against new virus outbreaks by quarantining suspicious messages until traditional Anti-Virus security services can be updated with a new virus signature file. If enabled, Outbreak Filters will be enabled on the default Incoming Mail Policy.

If you choose to enable Outbreak Filters, enter a threshold value and whether you would like to receive Outbreak Filters alerts. For more information about Outbreak Filters and threshold values, see [Outbreak Filters, on page 421](#).

## Configure the Alert Settings and AutoSupport

Cisco AsyncOS sends alert messages to a user via email if there is a system error that requires the user's intervention. Add at least one email address that receives system alerts. Separate multiple addresses with commas. The email addresses that you enter initially receive all types of alerts at all levels, except for Directory Harvest Attack Prevention alerts. You can add more granularity to the alert configuration later using the `alertconfig` command in the CLI or the **System Administration > Alerts** page in the GUI. For more information, see section *Alerts* of chapter *Distributing Administrative Tasks* of the *Cisco Secure Email Gateway Guide*.

The AutoSupport feature keeps the Cisco Customer Support team aware of issues with your email gateway so that Cisco can provide industry-leading support to you. Answer “Yes” to send Cisco support alerts and weekly status updates. (For more information, see section *AutoSupport* of chapter *Distributing Administrative Tasks* of the *Cisco Secure Email Gateway Guide*.)

## Configure Scheduled Reporting

Enter an address to which to send the default scheduled reports. You can leave this value blank and the reports will be archived on the email gateway instead of sent via email.

## Configure Time Settings

Cisco AsyncOS allows you to use the Network Time Protocol (NTP) to synchronize time with other servers on your network or the Internet, or to manually set the system clock. You must also set the time zone on the email gateway so that timestamps in message headers and log files are correct. You can also use the Cisco Systems time servers to synchronize the time on your email gateway.

Choose the Continent, Country, and Timezone and whether to use NTP including the name of the NTP server to use.

## Commit Changes

Finally, the System Setup Wizard will ask you to `commit` the configuration changes you have made throughout the procedure. Answer “Yes” if you want to commit the changes.

When you have successfully completed the System Setup Wizard, the following message will appear and you will be presented with the command prompt:

```
Congratulations! System setup is complete. For advanced configuration, please refer to the
User Guide.
```

```
mail3.example.com>
```

The email gateway is now ready to send email.

## Test the Configuration

To test the Cisco AsyncOS configuration, you can use the `mailconfig` command immediately to send a test email containing the system configuration data you just created with the `systemsetup` command:

```
mail3.example.com> mailconfig
```

```
Please enter the email address to which you want to send
```

the configuration file. Separate multiple addresses with commas.

```
[ ]> user@example.com
```

The configuration file has been sent to user@example.com.

```
mail3.example.com>
```

Send the configuration to a mailbox to which you have access to confirm that the system is able to send email on your network.

## Immediate Alerts

The email gateway uses feature keys to enable features. The first time you create a listener in the `systemsetup` command, enable Anti-Spam, enable Sophos or McAfee Anti-Virus, or enable Outbreak Filters, an alert is generated and sent to the addresses you specified in [Step 2: System, on page 30](#).

The alert notifies you periodically of the time remaining on the key. For example:

```
Your "Receiving" key will expire in under 30 day(s).  
Please contact IronPort Customer Support.
```

```
Your "Sophos" key will expire in under 30 day(s).  
Please contact IronPort Customer Support.
```

```
Your "Outbreak Filters" key will expire in under 30 day(s).  
Please contact IronPort Customer Support.
```

For information on enabling a feature beyond the 30-day evaluation period, contact your Cisco sales representative. You can see how much time remains on a key via the **System Administration > Feature Keys** page or by issuing the `featurekey` command. (For more information, see [Feature Keys, on page 1004](#).)

## Configuring your system as an Enterprise Gateway

To configure your system as an Enterprise Gateway (accepting email from the Internet), complete this chapter first, and then see [Configuring the Gateway to Receive Email, on page 65](#) for more information.

## Verifying Your Configuration and Next Steps

Now that system setup is complete, your email gateway should be sending and receiving email. If you have enabled the anti-virus, anti-spam, and virus-outbreak filters security features, the system will also be scanning incoming and outgoing mail for spam and viruses.

The next step is to understand how to customize your email gateway's configuration. [Understanding the Email Pipeline, on page 53](#) provides a detailed overview of how email is routed through the system. Each feature is processed in order (from top to bottom) and is described in the remaining chapters of this guide.





## CHAPTER 4

# Understanding the Email Pipeline

---

This chapter contains the following sections:

- [Overview of the Email Pipeline, on page 53](#)
- [Email Pipeline Flows, on page 53](#)
- [Incoming / Receiving, on page 56](#)
- [Work Queue / Routing, on page 58](#)
- [Delivery, on page 62](#)

## Overview of the Email Pipeline

The Email Pipeline is the flow of email as it is processed by the email gateway. It has three phases:

- **Receipt** — As the email gateway connects to a remote host to receive incoming email, it adheres to configured limits and other receipt policies. For example, verifying that the host can send your users mail, enforcing incoming connection and message limits, and validating the message's recipient.
- **Work Queue** — The email gateway processes incoming and outgoing mail, performing tasks such as filtering, safelist/blocklist scanning, anti-spam and anti-virus scanning, Outbreak Filters, and quarantining.
- **Delivery** — As the email gateway connects to send outgoing email, it adheres to configured delivery limits and policies. For example, enforcing outbound connection limits and processing undeliverable messages as specified.

## Email Pipeline Flows

The following figures provide an overview of how email is processed through the system, from receipt to routing to delivery. Each feature is processed in order (from top to bottom). You can test most of the configurations of features in this pipeline using the trace command.

Figure 6: Email Pipeline — Receiving Email Connections

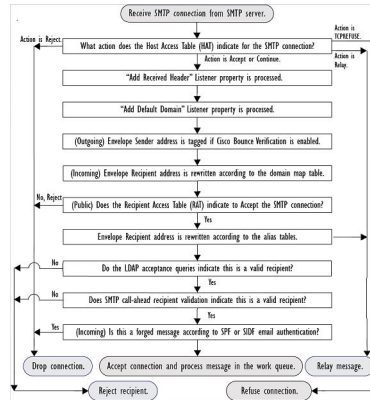

Figure 7: Email Pipeline — Work Queue

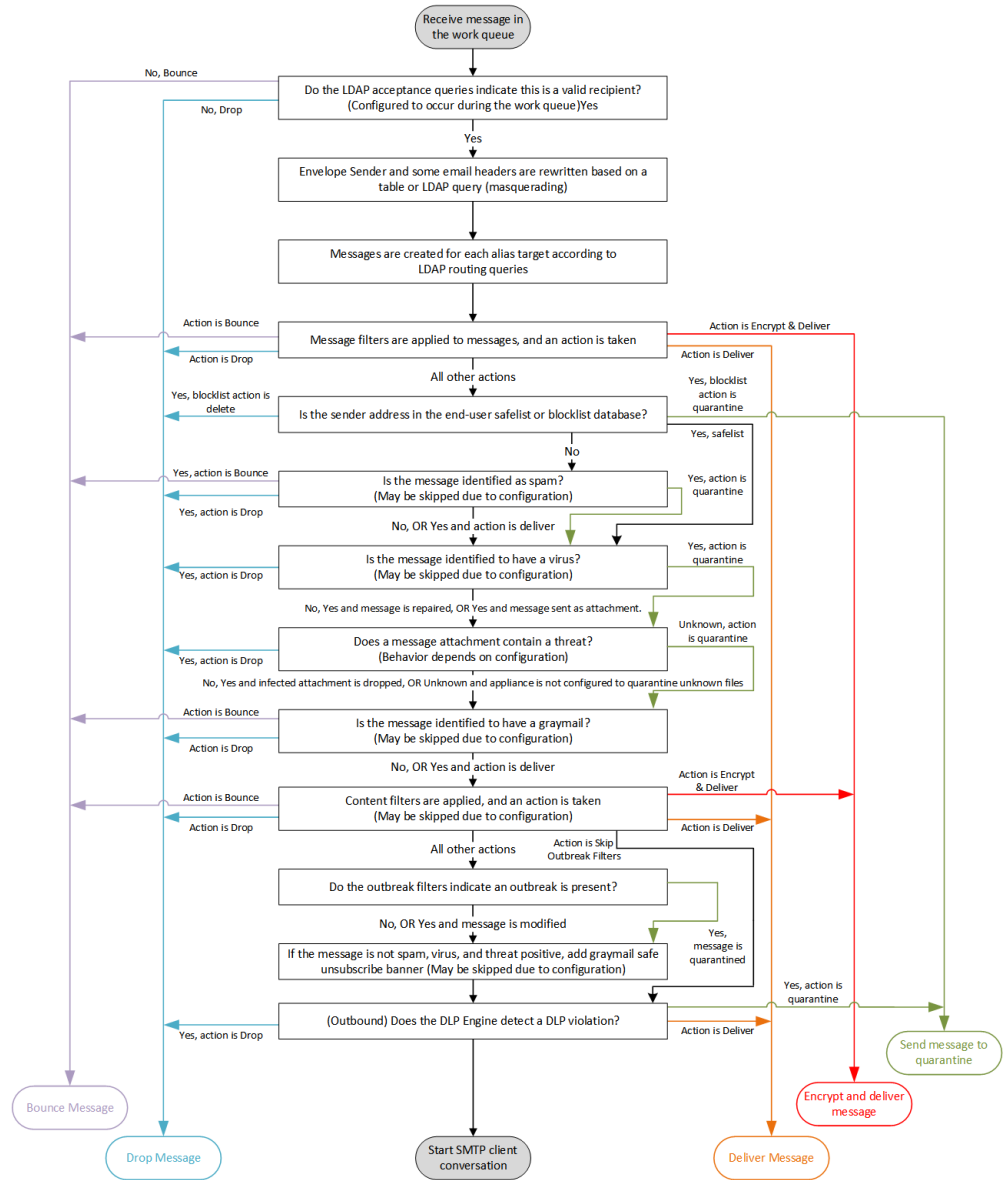
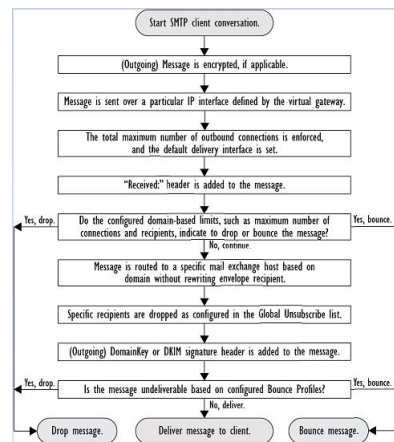

Figure 8: Email Pipeline — Delivering Email



## Incoming / Receiving

The receiving phase of the Email Pipeline involves the initial connection from the sender's host. Each message's domains can be set, the recipient is checked, and the message is handed off to the work queue.

### Related Topics

- [Host Access Table \(HAT\), Sender Groups, and Mail Flow Policies, on page 56](#)
- [Received: Header, on page 57](#)
- [Default Domain, on page 57](#)
- [Bounce Verification, on page 57](#)
- [Domain Map, on page 57](#)
- [Recipient Access Table \(RAT\), on page 57](#)
- [Alias Tables, on page 57](#)
- [LDAP Recipient Acceptance, on page 58](#)
- [SMTP Call-Ahead Recipient Validation, on page 58](#)

## Host Access Table (HAT), Sender Groups, and Mail Flow Policies

The HAT allows you to specify hosts that are allowed to connect to a listener (that is, which hosts you will allow to send email).

Sender Groups are used to associate one or more senders into groups, upon which you can apply message filters, and other Mail Flow Policies. Mail Flow Policies are a way of expressing a group of HAT parameters (access rule, followed by rate limit parameters and custom SMTP codes and responses).

Together, sender groups and mail flow policies are defined in a listener's HAT.

Host DNS verification settings for sender groups allow you to classify unverified senders prior to the SMTP conversation and include different types of unverified senders in your various sender groups.

While the connecting host was subject to Host DNS verification in sender groups — prior to the SMTP conversation — the domain portion of the envelope sender is DNS verified in mail flow policies, and the verification takes place during the SMTP conversation. Messages with malformed envelope senders can be



ignored. You can add entries to the Sender Verification Exception Table — a list of domains and email addresses from which to accept or reject mail despite envelope sender DNS verification settings.

Sender reputation filtering allows you to classify email senders and restrict access to your email infrastructure based on sender's trustworthiness as determined by the IP Reputation Service.

For more information, see [Understanding Predefined Sender Groups and Mail Flow Policies, on page 98](#).

## Received: Header

Using the `listenerconfig` command, you can configure a listener to not include the Received: header by default to all messages received by the listener.

For more information, see [Working with Listeners, on page 66](#).

## Default Domain

You can configure a listener to automatically append a default domain to sender addresses that do not contain fully-qualified domain names; these are also known as “bare” addresses (such as “joe” vs. “joe@example.com”).

For more information, see [Working with Listeners, on page 66](#).

## Bounce Verification

Outgoing mail is tagged with a special key, and so if that mail is sent back as a bounce, the tag is recognized and the mail is delivered. For more information, see [Bounce Verification, on page 731](#).

## Domain Map

For each listener you configure, you can construct a domain map table which rewrites the envelope recipient for each recipient in a message that matches a domain in the domain map table. For example, joe@old.com -> joe@new.com

For more information, see [The Domain Map Feature, on page 716](#).

## Recipient Access Table (RAT)

For inbound email only, the RAT allows you to specify a list of all local domains for which the email gateway will accept mail.

For more information, see [Overview of Accepting or Rejecting Connections Based on the Recipient's Address, on page 121](#).

## Alias Tables

Alias tables provide a mechanism to redirect messages to one or more recipients. Aliases are stored in a mapping table. When the envelope recipient (also known as the Envelope To, or RCPT TO ) of an email matches an alias as defined in an alias table, the envelope recipient address of the email will be rewritten.

For more information about Alias Tables, see [Creating Alias Tables, on page 699](#).

## LDAP Recipient Acceptance

You can use your existing LDAP infrastructure to define how the recipient email address of incoming messages (on a public listener) should be handled during the SMTP conversation or within the workqueue. For more information, see [Working with Listeners, on page 66](#). This allows the email gateway to combat directory harvest attacks (DHAP) in a unique way: the system accepts the message and performs the LDAP acceptance validation within the SMTP conversation or the work queue. If the recipient is not found in the LDAP directory, you can configure the system to perform a delayed bounce or drop the message entirely.

For more information, see [Working with LDAP Queries, on page 781](#).

## SMTP Call-Ahead Recipient Validation

When you configure your email gateway for SMTP call-ahead recipient validation, the email gateway suspends the SMTP conversation with the sending MTA while it “calls ahead” to the SMTP server to verify the recipient. When the email gateway queries the SMTP server, it returns the SMTP server’s response to the email gateway. The email gateway resumes the SMTP conversation and sends a response to the sending MTA, allowing the conversation to continue or dropping the connection based on the SMTP server response (and settings you configure in the SMTP Call-Ahead profile).

For more information, see [Validating Recipients Using an SMTP Server, on page 663](#)

## Work Queue / Routing

The Work Queue is where the received message is processed before moving to the delivery phase. Processing includes masquerading, routing, filtering, safelist/blocklist scanning, anti-spam and anti-virus scanning, file reputation scanning and analysis, Outbreak Filters, and quarantining.



---

**Note** Data loss prevention (DLP) scanning is only available for outgoing messages. For information on where DLP message scanning occurs in the Work Queue, see [Message Splintering, on page 260](#).

---

### Related Topics

- [Email Pipeline and Security Services, on page 58](#)
- [LDAP Recipient Acceptance, on page 58](#)
- [Masquerading or LDAP Masquerading, on page 59](#)
- [LDAP Routing, on page 59](#)
- [Message Filters, on page 59](#)
- [Email Security Manager \(Per-Recipient Scanning\), on page 60](#)
- [Quarantines, on page 61](#)

## Email Pipeline and Security Services

Note, as a general rule, changes to security services (anti-spam scanning, anti-virus scanning, and Outbreak Filters) do not affect messages already in the work queue. As an example:

If a message bypasses anti-virus scanning when it first enters the pipeline because of any of these reasons:

- anti-virus scanning was not enabled globally for the appliance, or
- the HAT policy was to skip anti-virus scanning, or
- there was a message filter that caused the message to bypass anti-virus scanning,

then the message will not be anti-virus scanned upon release from the quarantine, regardless of whether anti-virus scanning has been re-enabled. However, messages that bypass anti-virus scanning due to mail policies may be anti-virus scanned upon release from a quarantine, as the mail policy's settings may have changed while the message was in the quarantine. For example, if a message bypasses anti-virus scanning due to a mail policy and is quarantined, then, prior to release from the quarantine, the mail policy is updated to include anti-virus scanning, the message will be anti-virus scanned upon release from the quarantine.

Similarly, suppose you had inadvertently disabled anti-spam scanning globally (or within the HAT), and you notice this after mail is in the work queue. Enabling anti-spam at that point will not cause the messages in the work queue to be anti-spam scanned.

## LDAP Recipient Acceptance

You can use your existing LDAP infrastructure to define how the recipient email address of incoming messages (on a public listener) should be handled during the SMTP conversation or within the workqueue. For more information, see [Working with Listeners, on page 66](#). This allows the email gateway to combat directory harvest attacks (DHAP) in a unique way: the system accepts the message and performs the LDAP acceptance validation within the SMTP conversation or the work queue. If the recipient is not found in the LDAP directory, you can configure the system to perform a delayed bounce or drop the message entirely.

For more information, see [Working with LDAP Queries, on page 781](#).

## Masquerading or LDAP Masquerading

Masquerading is a feature that rewrites the envelope sender (also known as the sender, or MAIL FROM ) and the To:, From:, and/or CC: headers on email processed by a private or public listener according to a table you construct. You can specify different masquerading parameters for each listener you create in one of two ways: via a static mapping table, or via an LDAP query.

For more information about masquerading via a static mapping table, see [Configuring Masquerading, on page 706](#).

For more information about masquerading via an LDAP query, see [Working with LDAP Queries, on page 781](#).

## LDAP Routing

You can configure your email gateway to route messages to the appropriate address and/or mail host based upon the information available in LDAP directories on your network.

For more information, see [Working with LDAP Queries, on page 781](#).

## Message Filters

Message filters allow you to create special rules describing how to handle messages and attachments as they are received. Filter rules identify messages based on message or attachment content, information about the network, message envelope, message headers, or message body. Filter actions allow messages to be dropped, bounced, archived, quarantined, blind carbon copied, or altered.

For more information, see [Using Message Filters to Enforce Email Policies, on page 127](#).

Multi-recipient messages are “splintered” after this phase, prior to Email Security Manager. Splintering messages refers to creating splinter copies of emails with single recipients, for processing via Email Security Manager.

## Email Security Manager (Per-Recipient Scanning)

- [Safelist/Blocklist Scanning, on page 60](#)
- [Anti-Spam, on page 60](#)
- [Anti-Virus, on page 60](#)
- [Graymail Detection and Safe Unsubscribing, on page 61](#)
- [File Reputation Scanning and File Analysis , on page 61](#)
- [Content Filters, on page 61](#)
- [Outbreak Filters, on page 61](#)

### Safelist/Blocklist Scanning

End user safelists and blocklists are created by end users and stored in a database that is checked prior to anti-spam scanning. Each end user can identify domains, sub domains or email addresses that they wish to always treat as spam or never treat as spam. If a sender address is part of an end users safelist, anti-spam scanning is skipped, and if the sender address is listed in the blocklist, the message may be quarantined or dropped depending on administrator settings. For more information about configuring safelists and blocklists, see [Spam Quarantine, on page 943](#).

### Anti-Spam

Anti-spam scanning offers complete, Internet-wide, server-side anti-spam protection. It actively identifies and defuses spam attacks before they inconvenience your users and overwhelm or damage your network, allowing you to remove unwanted mail before it reaches your users’ inboxes, without violating their privacy.

Anti-spam scanning can be configured to deliver mail to the Spam Quarantine (either on- or off-box). Messages released from the Spam Quarantine proceed directly to the destination queue, skipping any further work queue processing in the email pipeline.

For more information, see [Managing Spam and Graymail, on page 379](#).

### Anti-Virus

Your email gateway includes integrated virus scanning engines. You can configure the email gateway to scan messages and attachments for viruses on a per-“mail policy” basis. You can configure the email gateway to take actions such as the following when a virus is found:

- attempt to repair the attachment
- drop the attachment
- modify the subject header
- add an additional X- header
- send the message to a different address or mailhost
- archive the message
- delete the message

Messages released from quarantines (see [Quarantines, on page 61](#)) are scanned for viruses. For more information about Anti-Virus scanning, see [Anti-Virus, on page 361](#).

## Graymail Detection and Safe Unsubscribing

You can configure the email gateway to detect graymail messages and perform secure unsubscribe on behalf of the end user. Available actions are similar to those for anti-virus scanning.

For more information, see [Managing Spam and Graymail, on page 379](#).

## File Reputation Scanning and File Analysis

You can configure the email gateway to scan message attachments for emerging and targeted threats. Available actions are similar to those for anti-virus scanning.

For more information, see [File Reputation Filtering and File Analysis, on page 477](#)

## Content Filters

You can create content filters to be applied to messages on a per-recipient or per-sender basis. Content filters are similar to message filters, except that they are applied later in the email pipeline — after a message has been “splintered” into a number of separate messages for each matching Email Security Manager policy. The functionality of content filters is applied after message filters processing and anti-spam and anti-virus scanning have been performed on a message.

For more information about Content Filters, see [Content Filters, on page 269](#).

## Outbreak Filters

Cisco’s Outbreak Filters feature includes special filters that act proactively to provide a critical first layer of defense against new outbreaks. Based on Outbreak Rules published by Cisco, messages with attachments of specific filetypes can be sent to a quarantine named Outbreak.

Messages in the Outbreak quarantine are processed like any other message in a quarantine. For more information about quarantines and the Work Queue, see [Quarantines, on page 61](#).

For more information, see [Outbreak Filters, on page 421](#).

## Quarantines

You can filter incoming or outgoing messages and place them into quarantines. Quarantines are special queues or repositories used to hold and process messages. Messages in quarantines can be delivered or deleted, based on how you configure the quarantine.

The following Work Queue features can send messages to quarantines:

- Spam filters
- Message Filters
- Anti-Virus
- Outbreak Filters
- Content Filters
- File Analysis (Advanced Malware Protection)

Messages delivered from quarantines are re-scanned for threats.

### Related Topics

- [Policy, Virus, and Outbreak Quarantines, on page 923](#)
- [Spam Quarantine, on page 943](#)

## Delivery

The delivery phase of the Email Pipeline focuses on the final phase of email processing, including limiting connections, bounces, and recipients.

### Related Topics

- [Virtual gateways, on page 62](#)
- [Delivery Limits, on page 62](#)
- [Domain-Based Limits, on page 62](#)
- [Domain-Based Routing, on page 62](#)
- [Global Unsubscribe, on page 63](#)
- [Bounce Limits, on page 63](#)

## Virtual gateways

The Virtual Gateway technology enables users to separate the email gateway into multiple Virtual Gateway addresses from which to send and receive email. Each Virtual Gateway address is given a distinct IP address, hostname and domain, and email delivery queue.

For more information, see [Configuring Mail Gateways for all Hosted Domains Using Virtual Gateway™ Technology, on page 745](#).

## Delivery Limits

Use the `deliveryconfig` command to set limits on delivery, based on which IP interface to use when delivering and the maximum number of concurrent connections the email gateway makes for outbound message delivery.

For more information, see [Set Email Delivery Parameters, on page 742](#).

## Domain-Based Limits

For each domain, you can assign a maximum number of connections and recipients that will never be exceeded by the system in a given time period. This “good neighbor” table is defined through the Mail Policies > Destination Controls page (or the `destconfig` command).

For more information, see [Controlling Email Delivery Using Destination Controls, on page 730](#).

## Domain-Based Routing

Use the Network > SMTP Routes page (or the `smtproutes` command) to redirect all email for a particular domain to a specific mail exchange (MX) host, without rewriting the envelope recipient.

For more information, see [Routing Email for Local Domains, on page 693](#).

## Global Unsubscribe

Use Global Unsubscribe to ensure that specific recipients, recipient domains, or IP addresses never receive messages from the email gateway. If Global Unsubscribe is enabled, the system will check all recipient addresses against a list of “globally unsubscribed” users, domains, email addresses, and IP Addresses. Matching emails are not sent.

For more information, see [Using Global Unsubscribe, on page 754](#).

## Bounce Limits

You use the Network > Bounce Profiles page (or the `bounceconfig` command) to configure how AsyncOS handles hard and soft conversational bounces for each listener you create. You create bounce profiles and then apply profiles to each listener using the Network > Listeners page (or the `listenerconfig` command). You can also assign bounce profiles to specific messages using message filters.

For more information about bounce profiles, see [Directing Bounced Email, on page 722](#).







## CHAPTER 5

# Configuring the Gateway to Receive Email

This chapter contains the following sections:

- [Overview of Configuring the Gateway to Receive Email, on page 65](#)
- [Working with Listeners, on page 66](#)
- [Configuring Global Settings for Listeners, on page 68](#)
- [Listening for Connection Requests by Creating a Listener Using Web Interface, on page 71](#)
- [Listening for Connection Requests by Creating a Listener Using CLI, on page 76](#)
- [Enterprise Gateway Configuration, on page 78](#)

## Overview of Configuring the Gateway to Receive Email

The email gateway functions as the gateway for your organization, servicing email connections, accepting messages, and relaying them to the appropriate systems. The email gateway can service email connections from the Internet to recipient hosts inside your network, and from systems inside your network to the Internet. Typically, email connection requests use Simple Mail Transfer Protocol (SMTP). The appliance services SMTP connections by default, and acts as the SMTP gateway, also known as a mail exchanger or “MX,” for the network.

The email gateway uses *listeners* to service incoming SMTP connection requests. A listener describes an email processing service that is configured on a particular IP interface. Listeners apply to email entering the appliance, from either the Internet or from systems within your network trying to reach the Internet. Use listeners to specify criteria that messages and connections must meet in order to be accepted and for messages to be relayed to recipient hosts. You can think of a listener as an “SMTP daemon” running on a specific port for each IP address specified. Also, listeners define how the email gateway communicates with systems that try to send email to the email gateway.

You can create the following types of listeners:

- **Public.** Listens for and accepts email messages coming in from the Internet. Public listeners receive connections from many hosts and direct messages to a limited number of recipients.
- **Private.** Listens for and accepts email messages coming from systems within the network, typically from internal groupware and email servers (POP/IMAP), intended for recipients outside the network in the Internet. Private listeners receive connections from a limited (known) number of hosts and direct messages to many recipients.

When you create a listener, you also must specify the following information:

- **Listener properties.** Define global properties that apply to all listeners, and properties specific to each listener. For example, you can specify the IP interface and port to use for a listener, and whether it is a public or private listener. For details on how to do this, see [Working with Listeners, on page 66](#).
- **Which hosts that are allowed to connect to the listener.** Define a set of rules that control incoming connections from remote hosts. For example, you can define remote hosts and whether or not they can connect to the listener. For details on how to do this, see [Defining Which Hosts Are Allowed to Connect Using the Host Access Table , on page 89](#).
- **(Public listeners only) The local domains for which the listener accepts messages.** Define which recipients are accepted by the public listener. For example, if your organization uses the domain `currentcompany.com` and it previously used `oldcompany.com` , then you might accept messages for both `currentcompany.com` and `oldcompany.com` . For details on how to do this, see [Accepting or Rejecting Connections Based on Domain Name or Recipient Address, on page 121](#).

The settings configured in the listener, including its Host Access Table and Recipient Access Table, affect how the listener communicates with an SMTP server during the SMTP conversation. This allows the email gateway to block a spamming host before the connection is closed.

**Figure 9: Relationship between Listeners, IP Interfaces, and Physical Ethernet Interfaces**

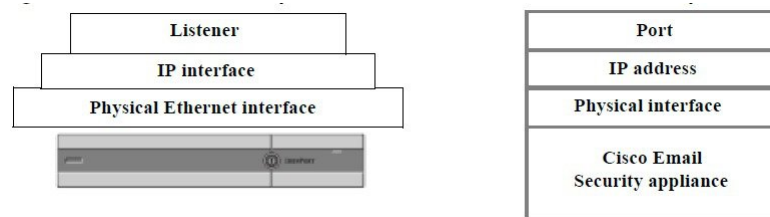

## Working with Listeners

Configure listeners on the Network > Listeners page in the GUI, or using the `listenerconfig` command in the CLI.

You can define global settings that apply to all listeners. For more information, see [Configuring Global Settings for Listeners, on page 68](#).

Consider the following rules and guidelines when working with and configuring listeners on the email gateway:

- You can define multiple listeners per configured IP interface, but each listener must use a different port.
- By default, listeners use SMTP as the mail protocol to service email connections. However, you can also configure the appliance to service email connections using Quick Mail Queuing Protocol (QMQP). Do this using the `listenerconfig` CLI command.
- Listeners support both Internet Protocol version 4 (IPv4) and version 6 (IPv6) addresses. You can use either protocol version or both on a single listener. The listener uses the same protocol version for mail delivery as the connecting host. For example, if the listener is configured for both IPv4 and IPv6 and connects to a host that uses IPv6, the listener uses IPv6. However, if the listener is configured to only use IPv6 addresses, it cannot connect to a host that is only using IPv4 addresses.
- At least one listener (with default values) is configured on the email gateway after running the System Setup Wizard. However, when you create a listener manually, AsyncOS does not use these default IP Reputation score values.

- **C170 and C190 appliances:** By default, the System Setup Wizard walks you through configuring one public listener for both receiving mail from the Internet and for relaying email from your internal network. That is, one listener can perform both functions.
- To help test and troubleshoot the email gateway, you can create a “sinkhole” type listener instead of a public or private listener. When you create a sinkhole listener, you choose whether messages are written to disk or not before they are deleted. (See the “Testing and Troubleshooting” chapter for more information.) Writing messages to disk before deleting them can help you measure the rate of receiving and the speed of the queue. A listener that doesn’t write messages to disk can help you measure the pure rate of receiving from your message generation systems. This listener type is only available through the `listenerconfig` command in the CLI.

*Figure - Public and Private Listeners on Email Gateway Models with More than Two Ethernet Interfaces* illustrates a typical email gateway configuration created by the System Setup Wizard on email gateway models that have more than two Ethernet interfaces. Two listeners are created: a public listener to serve inbound connections on one interface and a private listener to serve outbound connections on a second IP interface.

*Figure - Public Listener on Email Gateway Models with Only Two Ethernet Interfaces* illustrates a typical email gateway configuration created by the System Setup Wizard on email gateway models that have only two Ethernet interfaces. One public listener on a single IP interface is created to serve both inbound and outbound connections.

**Figure 10: Public and Private Listeners on Email Gateway Models with More than Two Ethernet Interfaces**

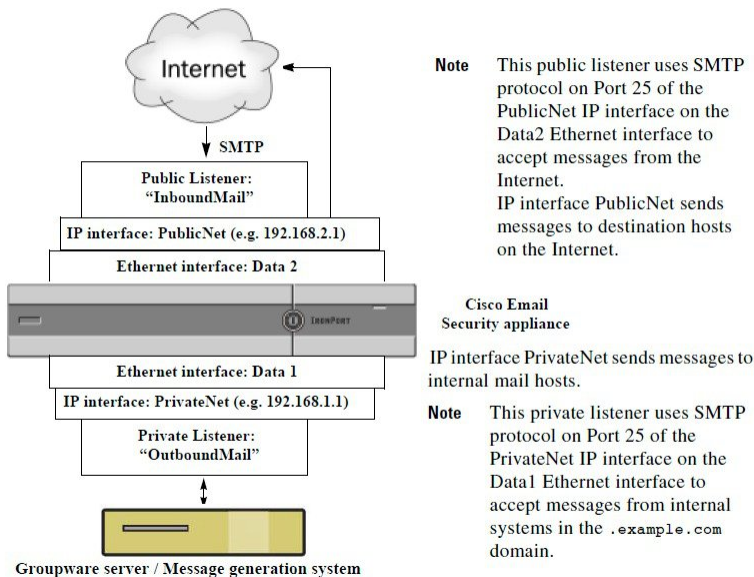
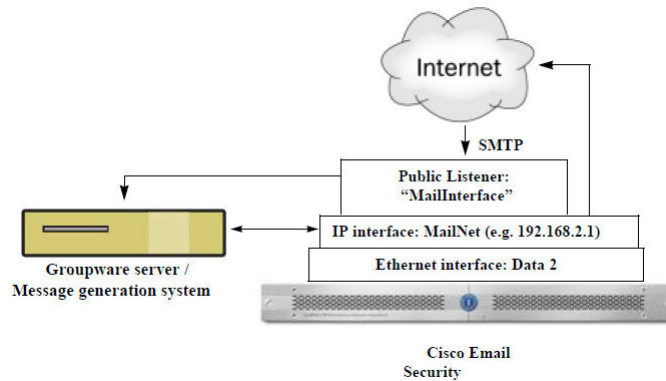

Figure 11: Public Listener on Email Gateway Models with Only Two Ethernet Interfaces



**Note** This public listener uses SMTP protocol on Port 25 of the PublicNet IP interface on the Data2 Ethernet interface to accept messages from the Internet and to relay messages from internal systems in the .example.com domain. IP interface MailNet sends messages to destination hosts on the Internet and to internal mail hosts

## Configuring Global Settings for Listeners

Global settings for the listeners affect all of the listeners that are configured on the email gateway. If the listener uses an interface that has both Internet Protocol version 4 (IPv4) and version 6 (IPv6) addresses, the listener settings apply to both IPv4 and IPv6 traffic

### Procedure

- Step 1** Choose **Network > Listeners**.
- Step 2** Click **Edit Global Settings**.
- Step 3** Make changes to the settings defined in the following table.

Table 6: Listener Global Settings

Global Setting	Description
Maximum Concurrent Connections	Set the maximum number of concurrent connections for listeners. The default value is 300 for the C3x0 and C6x0 models, and the default value is 50 for the C1x0 models. If the listener accepts both IPv4 and IPv6 connections, the number of connections is divided between the two. For example, if the maximum concurrent connections is 300, then the sum of IPv4 and IPv6 connections cannot exceed 300.
Maximum Concurrent TLS Connections	Set the maximum concurrent TLS connections across all listeners combined. The default value is 100. If the listener accepts both IPv4 and IPv6 TLS connections, the number of connections is divided between the two. For example, if the maximum concurrent connections is 100, then the sum of IPv4 and IPv6 TLS connections cannot exceed 100.

Global Setting	Description
Injection Counters Reset Period	<p>Allows you to adjust when the injection control counters are reset. For very busy systems maintaining counters for a very large number of different IP addresses, configuring the counters to be reset more frequently (for example, every 15 minutes instead of every 60 minutes) will ensure that the data does not grow to an unmanageable size and impact system performance.</p> <p>The current default value is 1 hour. You can specify periods ranging from as little as 1 minute (60 seconds) to as long as 4 hours (14,400 seconds).</p> <p>See <a href="#">Injection Control Periodicity</a> , on page 112.</p>
Timeout Period for Unsuccessful Inbound Connections	<p>Set the length of time AsyncOS will allow an unsuccessful inbound connection to remain intact before closing it.</p> <p>An unsuccessful connection can be an SMTP conversation in which SMTP or ESMTP commands continue to be issued without a successful message injection occurring. When the specified timeout is reached, the behavior is to send an error and disconnect:</p> <p>“421 Timed out waiting for successful message injection, disconnecting.”</p> <p>A connection is considered unsuccessful until it successfully injects a message.</p> <p>Only available for SMTP connections on public listeners. The default value is 5 minutes.</p>
Total Time Limit for All Inbound Connections	<p>Set the length of time AsyncOS will allow an inbound connection to remain intact before closing it.</p> <p>This setting is intended to preserve system resources by enforcing a maximum allowable connection time. Once about 80% of this maximum connection time is reached the following message is issued:</p> <p>“421 Exceeded allowable connection time, disconnecting.”</p> <p>The email gateway will attempt to disconnect when the connection exceeds 80% of the maximum connection time in order to prevent disconnecting mid-message. It is likely that a problem is occurring with the inbound connection if it is open long enough to reach 80% of the maximum connection time. Keep this threshold in mind when specifying the time limit.</p> <p>Only available for SMTP connections on public listeners. The default value is 15 minutes.</p>
Maximum size of subject	<p>Messages having subject size within the specified limit will be accepted and any other messages will be rejected. If you set this value to 0, no limit is applied.</p>

Global Setting	Description
HAT delayed rejections	<p>Configure whether to perform HAT rejection at the message recipient level. By default, HAT rejected connections will be closed with a banner message at the start of the SMTP conversation.</p> <p>When an email is rejected due to HAT “Reject” settings, AsyncOS can perform the rejection at the message recipient level (RCPT TO), rather than at the start of the SMTP conversation. Rejecting messages in this way delays the message rejection and bounces the message, allowing AsyncOS to retain more detailed information about the rejected messages. For example, you can see the mail from address and each recipient address of the message which is blocked. Delaying HAT rejections also makes it less likely that the sending MTA will perform multiple retries.</p> <p>When you enable HAT delayed rejection, the following behavior occurs:</p> <p>The MAIL FROM command is accepted, but no message object is created.</p> <p>All RCPT TO commands are rejected with text explaining that access to send e-mail is refused.</p> <p>If the sending MTA authenticates with SMTP AUTH, they are granted a RELAY policy and are allowed to deliver mail as normal.</p> <p>Only configurable from the CLI <code>listenerconfig --&gt; setup</code> command.</p>

**Step 4** Submit and commit your changes.

---

### What to do next

#### Related Topics

- [Settings for Messages Containing Multiple Encodings, on page 70](#)

## Settings for Messages Containing Multiple Encodings

You can define the behavior of the email gateway while modifying the message encoding for the following parameters:

- Headers
- Untagged non-ASCII headers
- Mismatched footer or heading encoding

To configure this behavior, use the `localeconfig` command in CLI.



---

**Note** This behavior cannot be configured using web interface.

---

For a sample CLI transcript, see [Disclaimer Stamping and Multiple Encodings, on page 654](#).

# Listening for Connection Requests by Creating a Listener Using Web Interface

## Procedure

- Step 1** Choose `Network > Listener`.
- Step 2** Click **Add Listener**.
- Step 3** Configure the settings defined in the following table.

**Table 7: Listener Settings**

Name	Unique nickname you supply for the listener, for future reference. The names you define for listeners are case-sensitive. AsyncOS will not allow you to create two identical listener names.
Type of Listener	Choose one of the following types of listeners: <ul style="list-style-type: none"> <li>• <b>Public.</b> Public listeners contain default characteristics for receiving email from the Internet.</li> <li>• <b>Private.</b> Private listeners are intended to be used for private (internal) networks.</li> </ul>
Interface	Choose a configured email gateway IP interface and TCP port on which to create the listener. Depending on the version of the IP address used by the interface, the listener accepts connections from IPv4 addresses, IPv6 addresses or from both versions. By default, SMTP uses port 25 and QMQP uses port 628.
Bounce Profile	Select a bounce profile (bounce profiles created via the <code>bounceconfig</code> command in the CLI are available in the list, see <a href="#">Creating a New Bounce Profile, on page 729</a> ).
Disclaimer Above	Select a disclaimer to attach above or below emails (disclaimers created via the Mail Policies > Text Resources page or the <code>textconfig</code> command in the CLI are available in the list, see the “Text Resources” chapter).
Disclaimer Below	Select a disclaimer to attach above or below emails (disclaimers created via the Mail Policies > Text Resources page or the <code>textconfig</code> command in the CLI are available in the list, see the “Text Resources” chapter).
SMTP Authentication Profile	Specify an SMTP Authentication profile.
Certificate	Specify a certificate for TLS connections to the listener (certificates added via the Network > Certificates page or the <code>certconfig</code> command in the CLI are available in the list, see <a href="#">Overview of Encrypting Communication with Other MTAs, on page 671</a> ).

- Step 4** (Optional) Configure settings for controlling parsing in SMTP “MAIL FROM” and “RCPT TO” commands as defined in the following table.

Setting	Description
Address Parser Type	<p>Choose how strictly the email gateway adheres to the RFC2821 standard using one of the following parser types:</p> <p><b>Strict Mode:</b></p> <ul style="list-style-type: none"> <li>• Strict mode tries to follow RFC 2821. In Strict mode, the address parser follows RFC 2821 rules with the following exceptions/enhancements:</li> <li>• Space is allowed after the colon, as in “MAIL FROM: &lt;joe@example.com&gt;”.</li> <li>• Underscores are allowed in the domain name.</li> <li>• “MAIL FROM” and “RCPT TO” commands are case-insensitive.</li> <li>• Periods are not treated specially (for example, RFC 2821 does not allow a username of “J.D.”).</li> </ul> <p>Some of the additional options below may be enabled which technically would violate RFC 2821.</p> <p><b>Loose Mode:</b></p> <p>The loose parser is basically the existing behavior from previous versions of AsyncOS. It does its best to “find” an email address and:</p> <ul style="list-style-type: none"> <li>• Ignores comments. It supports nested comments (anything found in parenthesis) and ignores them.</li> <li>• Does not require angle brackets around email addresses provided in “RCPT TO” and “MAIL FROM” commands.</li> <li>• Allows multiple nested angle brackets (it searches for the email address in the deepest nested level).</li> </ul>
Allow 8-bit User Names	If enabled, allow 8-bit characters in the username portion of the address without escaping.
Allow 8-bit Domain Names	If enabled, allow 8-bit characters in the domain portion of the address.



Setting	Description
Allow Partial Domains	<p>If enabled, will allow partial domains. Partial domains can be no domain at all, or a domain with no dots.</p> <p>The following addresses are examples of partial domains:</p> <ul style="list-style-type: none"> <li>• foo</li> <li>• foo@</li> <li>• foo@bar</li> </ul> <p>This option <i>must</i> be enabled in order for the Default Domain feature to work properly.</p> <p><b>Add Default Domain:</b> A default domain to use for email addresses without a fully qualified domain name. This option is disabled unless Allow Partial Domains is enabled in SMTP Address Parsing options. This affects how a listener modifies email that it relays by adding the “default sender domain” to sender and recipient addresses that do not contain fully-qualified domain names. (In other words, you can customize how a listener handles “bare” addresses).</p> <p>If you have a legacy system that sends email without adding (appending) your company’s domain to the sender address, use this to add the default sender domain. For example, a legacy system may automatically create email that only enters the string “ joe ” as the sender of the email. Changing the default sender domain would append “ @yourdomain.com ” to “ joe ” to create a fully-qualified sender name of joe@yourdomain.com .</p>
Source Routing	<p>Determines behavior if source routing is detected in the “MAIL FROM” and “RCPT TO” addresses. Source routing is a special form of an email address using multiple ‘@’ characters to specify routing (for example: @one.dom@two.dom:joe@three.dom). If set to “reject,” the address will be rejected. If “strip,” the source routing portion of the address will be deleted, and the message will be injected normally.</p>
Unknown Address Literals	<p>Determines behavior for when an address literal is received that the system cannot handle. Currently, this is everything except for IPv4. Thus, for example, for an IPv6 address literal, you can either reject it at the protocol level, or accept it and immediately hard bounce it.</p> <p>Recipient addresses containing literals will cause an immediate hard bounce. Sender addresses may get delivered. If the message cannot be delivered, then the hard bounce will hard bounce (double hard bounce).</p> <p>In the case of reject, both sender and recipient addresses will be rejected immediately at the protocol level.</p>
Reject These Characters in User Names	<p>Usernames that include characters (such as % or !, for example) entered here will be rejected.</p>

**Step 5** (Optional) Configure advanced settings for customizing the behavior of the listener as defined in the following table.

Setting	Description
Maximum Concurrent Connections	The maximum number of connections allowed.
TCP Listen Queue Size	The backlog of connections that AsyncOS will manage before the SMTP server accepts them.
CR and LF Handling	Choose how to handle messages that contain bare CR (carriage return) and LF (line feed) characters. <ul style="list-style-type: none"> <li>• <b>Clean.</b> Allows the message, but converts bare CR and LF characters to CRLF characters.</li> <li>• <b>Reject.</b> Rejects the message.</li> <li>• <b>Allow.</b> Allows the message.</li> </ul>
Add Received Header	Add a received header to all received email. A listener also modifies email that it relays by adding a Received: header on each message. If you do not want to include the Received: header, you can disable it using this option. <p><b>Note</b> The Received: header is not added to the message within the work queue processing. Rather, it is added when the message is enqueued for delivery</p> <p>Disabling the received header is a way to ensure that your network's topology is not exposed by revealing the IP addresses or hostnames of internal servers on any messages traveling outside your infrastructure. Please use caution when disabling the received header.</p>
Use SenderBase IP Profiling	Choose whether or not to enable SenderBase IP Profiling and configure the following setting: <ul style="list-style-type: none"> <li>• <b>SenderBase Timeout per Connection.</b> Define how long the appliance caches SenderBase information per SMTP connection.</li> </ul>

**Step 6** (Optional) Configure settings for controlling LDAP queries associated with this listener as defined in the following table.

Use these settings to enable LDAP queries on the listener. You must create the LDAP query first, before using this option. Each type of query has a separate subsection to configure. Click the type of query to expand the subsection.

For more information about creating LDAP queries, see [LDAP Queries, on page 771](#).

Query Type	Description
Accept Queries	<p>For Accept queries, select the query to use from the list. You can specify whether the LDAP Accept occurs during the work queue processing or during the SMTP conversation.</p> <p>For LDAP Accept during the work queue processing, specify the behavior for non-matching recipients: bounce or drop.</p> <p>For LDAP Accept during the SMTP conversation, specify how to handle mail if the LDAP server is unreachable. You can elect to allow messages or drop the connection with a code and custom response. Finally, select whether or not to drop connections if the Directory Harvest Attack Prevention (DHAP) threshold is reached during an SMTP conversation.</p> <p>Performing recipient validation in the SMTP conversation can potentially reduce the latency between multiple LDAP queries. Therefore, you might notice an increased load on your directory server when you enable conversational LDAP Accept.</p> <p>See <a href="#">Overview of LDAP Queries, on page 771</a> for more information.</p>
Routing Queries	<p>For routing queries, select the query from the list. See <a href="#">Overview of LDAP Queries, on page 771</a> for more information.</p>
Masquerade Queries	<p>For masquerade queries, select a query from the list, and select which address to masquerade, such as the From or CC header addresses.</p> <p>See <a href="#">Overview of LDAP Queries, on page 771</a> for more information.</p>
Group Queries	<p>For group queries, select the query from the list. See <a href="#">Overview of LDAP Queries, on page 771</a> for more information.</p>

**Step 7** Submit and commit your changes.

#### What to do next

#### Related Topics

[Partial Domains, Default Domains, and Malformed MAIL FROMs, on page 75](#)

## Partial Domains, Default Domains, and Malformed MAIL FROMs

If you enable envelope sender verification or disable allowing partial domains in SMTP Address Parsing options for a listener, the default domain settings for that listener will no longer be used.

These features are mutually exclusive.

# Listening for Connection Requests by Creating a Listener Using CLI

The following table lists some of the listenerconfig subcommands used in the tasks involved in creating and editing listeners.

**Table 8: Tasks for Creating Listeners**

Tasks for Creating Listeners	Command(s) and Subcommands
Create a new listener	listenerconfig -> new
Edit global settings for listeners	listenerconfig -> setup
Specify a bounce profile for the listener	bounceconfig, listenerconfig-> edit -> bounceconfig
Associate a disclaimer with the listener	textconfig, listenerconfig -> edit -> setup -> footer
Configure an SMTP Authentication	smtpauthconfig, listenerconfig -> smtpauth
Configure SMTP address parsing	textconfig, listenerconfig -> edit -> setup -> address
Configure a default domain for the listener	listenerconfig -> edit -> setup -> defaultdomain
Add a received header to email	listenerconfig -> edit -> setup -> received
Change bare CR and LF characters to CRLF	listenerconfig -> edit -> setup -> cleansmtp
Modify the Host Access Table	listenerconfig -> edit -> hostaccess
Accept email for local domains or specific users (RAT) (public listeners only)	listenerconfig -> edit -> rcptaccess
Encrypt conversations on listeners (TLS)	certconfig, listenerconfig -> edit
Choose the certificate (TLS)	listenerconfig -> edit -> certificate

For more information about listenerconfig command, see CLI Reference Guide for AsyncOS for Cisco Secure Email Gateway.

For information about email routing and delivery configurations, see [Configuring Routing and Delivery Features, on page 693](#).

**Related Topics**[Advanced HAT Parameters, on page 77](#)

## Advanced HAT Parameters

The following table defines the syntax of advanced HAT parameters. Note that for the numeric values below, you can add a trailing **k** to denote kilobytes or a trailing **M** to denote megabytes. Values with no letters are considered bytes. Parameters marked with an asterisk support the variable syntax shown in the following table.

**Table 9: Advanced HAT Parameter Syntax**

Parameter	Syntax	Values	Example Values
Maximum messages per connection	<code>max_msgs_per_session</code>	Number	1000
Maximum recipients per message	<code>max_rcpts_per_msg</code>	Number	10000 1k
Maximum message size	<code>max_message_size</code>	Number	1048576 20M
Maximum concurrent connections allowed to this listener	<code>max_concurrency</code>	Number	1000
SMTP Banner Code	<code>smtp_banner_code</code>	Number	220
SMTP Banner Text (*)	<code>smtp_banner_text</code>	String	Accepted
SMTP Reject Banner Code	<code>smtp_banner_code</code>	Number	550
SMTP Reject Banner Text (*)	<code>smtp_banner_text</code>	String	Rejected
Override SMTP Banner Hostname	<code>use_override_hostname</code>	on   off   default	default
	<code>override_hostname</code>	String	newhostname
Use TLS	<code>tls</code>	on   off   required	on
Use anti-spam scanning	<code>spam_check</code>	on   off	off
Use virus scanning	<code>virus_check</code>	on   off	off
Maximum Recipients per Hour	<code>max_rcpts_per_hour</code>	Number	5k

Parameter	Syntax	Values	Example Values
Maximum Recipients per Hour Error Code	max_rcpts_per_hour_code	Number	452
Maximum Recipients per Hour Text (*)	max_rcpts_per_hour_text	String	Too manyrecipients
Use SenderBase	use_sb	on   off	on
Define IP Reputation Score	sbrs[ <i>value1</i> : <i>value2</i> ]	-10.0- 10.0	sbrs[-10:-7.5]
Directory Harvest Attack Prevention: Maximum Invalid Recipients Per Hour	dhap_limit	Number	150

## Enterprise Gateway Configuration

In this configuration, the Enterprise Gateway configuration accepts email from the Internet and relays email to groupware servers, POP/IMAP servers, or other MTAs. At the same time, the enterprise gateway accepts SMTP messages from groupware servers and other email servers for relay to recipients on the Internet.

**Figure 12: Public and Private Listeners for an Enterprise Gateway**

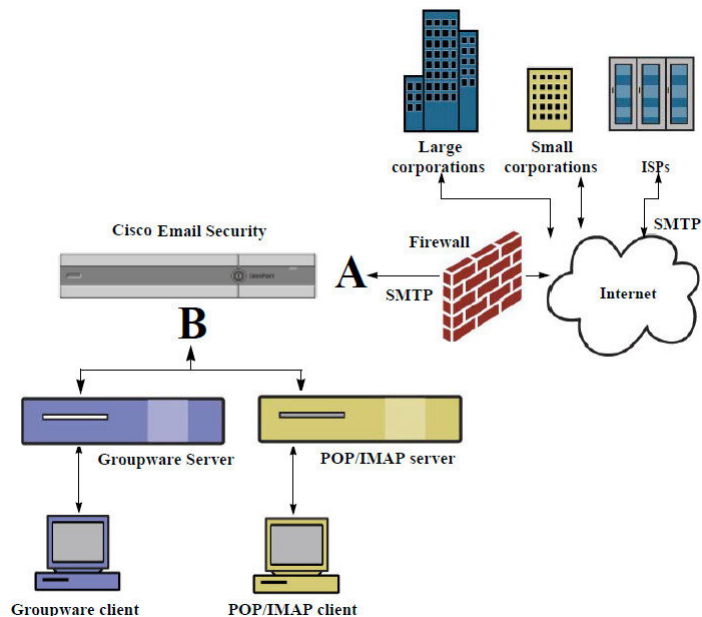

In this configuration, at least two listeners are required:

- One listener configured specifically to accept mail *from* the Internet
- One listener configured specifically to accept mail *from* your internal groupware and email servers (POP/IMAP)

By creating distinct public and private listeners for different public and private networks, you can distinguish among email for security, policy enforcement, reporting, and management. For example, email received on public listeners is scanned by your configured anti-spam engine and the anti-virus scanning engine by default, while email received on private listeners is not scanned.

*Figure - Public and Private Listeners for an Enterprise Gateway* shows one public listener (A) and one private listener (B) configured on the email gateway in this Enterprise Gateway configuration.







## CHAPTER 6

# IP Reputation Filtering

---

This chapter contains the following sections:

- [Overview of Sender IP Reputation Filtering, on page 81](#)
- [IP Reputation Service, on page 81](#)
- [Editing IP Reputation Filtering Score Thresholds for a Listener , on page 84](#)
- [Entering Low IP Reputation Scores in the Message Subject, on page 86](#)

## Overview of Sender IP Reputation Filtering

Sender IP reputation filtering is the first layer of spam protection, allowing you to control the messages that come through the email gateway based on senders' trustworthiness as determined by the Sender IP Reputation Service.

The email gateway can accept messages from known or highly reputable senders — such as customers and partners — and deliver them directly to the end user without any content scanning. Messages from unknown or less reputable senders can be subjected to content scanning, such as anti-spam and anti-virus scanning, and you can also throttle the number of messages you are willing to accept from each sender. Email senders with the worst reputation can have their connections rejected or their messages bounced based on your preferences.



---

**Note** File reputation filtering is a separate service. For information, see [File Reputation Filtering and File Analysis, on page 477](#)

---

## IP Reputation Service

The IP Reputation Service, using global data from the Talos Affiliate network, assigns a IP Reputation Score (IPRS) to email senders based on complaint rates, message volume statistics, and data from public blocked lists and open proxy lists. The IP Reputation Score helps to differentiate legitimate senders from spam sources. You can determine the threshold for blocking messages from senders with low reputation scores.

The Talos Security Network website (<https://talosintelligence.com>) provides a global overview of the latest email and web-based threats, displays current email traffic volume by country, and allows you to look up reputation scores based on IP address, URI or Domain.

## Related Topics

- [IP Reputation Score](#) , on page 82
- [How Sender IP Reputation Filters Work](#) , on page 83
- [Recommended Settings for Different Sender IP Reputation Filtering Approaches](#) , on page 83
- [Outbreak Filters](#), on page 421
- [Using Email Security Monitor](#), on page 829

# IP Reputation Score

The IP Reputation Score is a numeric value assigned to an IP address based on information from the IP Reputation Service. The IP Reputation Service aggregates data from over 25 public blocked lists and open proxy lists, and combines this data with global data from Talos to assign a score from -10.0 to +10.0, as follows:

Score	Meaning
-10.0	Most likely to be a source of spam
0	Neutral, or not enough information to make a recommendation
+10.0	Most likely to be a trustworthy sender

The lower (more negative) the score, the more likely that a message is spam. A score of -10.0 means that this message is “guaranteed” to be spam, while a score of 10.0 means that the message is “guaranteed” to be legitimate.

Using the IP Reputation Score, you configure the email gateway to apply mail flow policies to senders based on their trustworthiness. (You can also create message filters to specify “thresholds” for IP Reputation Scores to further act upon messages processed by the system. For more information, refer to “[IP Reputation Rule](#), on page 164” and “[Bypass Anti-Spam System Action](#), on page 208.”)

**Figure 13: The IP Reputation Service**

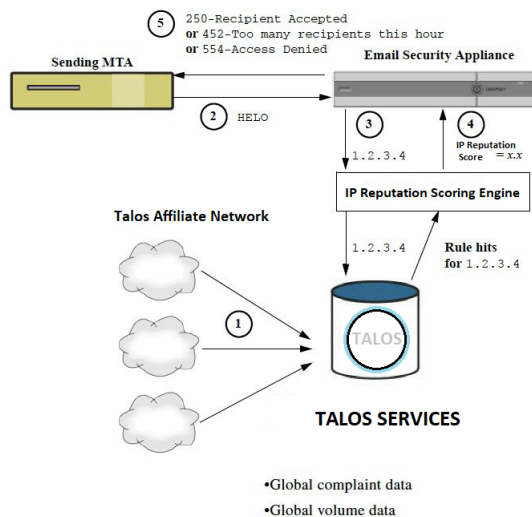

1. Talos affiliates send real-time, global data
2. Sending MTA opens connection with the email gateway

3. Email gateway checks global data for the connecting IP address
4. IP Reputation Service calculates the probability that this message is spam and assigns an IP Reputations Score
5. Cisco returns the response based on the IP Reputation Score

## How Sender IP Reputation Filters Work

Sender IP Reputation filter technology aims to shunt as much mail as possible from the remaining security services processing that is available on the email gateway. (See [Understanding the Email Pipeline, on page 53.](#))

When sender reputation filtering is enabled, mail from known bad senders is simply refused. Known good mail from global 2000 companies is automatically routed around the spam filters, reducing the chance of false positives. Unknown, or “grey” email is routed to the anti-spam scanning engine. Using this approach, Sender IP Reputation filters can reduce the load on the content filters by as much as 50%.

**Figure 14: Sender IP Reputation Filtering Example**

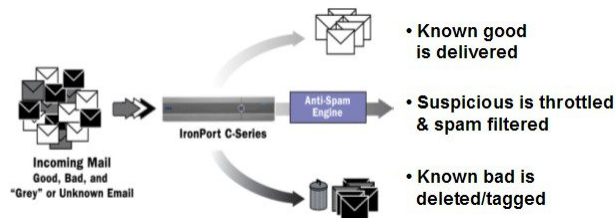

## Recommended Settings for Different Sender IP Reputation Filtering Approaches

Depending on the objectives of your enterprise, you can implement a conservative, moderate, or aggressive approach.

Approach	Characteristics	Allowed_List	Blocked_List	Suspectlist	Unknownlist
		Sender IP Reputation Score range:			
Conservative	Near zero false positives, better performance	7 to 10	-10 to -4	-4 to -2	-2 to 7
Moderate (Installation default)	Very few false positives, high performance	Sender IPReputation Scores are not used.	-10 to -3	-3 to -1	-1 to +10
Aggressive	Some false positives, maximum performance.  This option shunts the most mail away from Anti-Spam processing.	4 to 10	-10 to -2	-2 to -1	-1 to 4

Approach	Characteristics	Allowed_List	Blocked_List	Suspectlist	Unknownlist
All approaches		<b>Mail Flow Policy:</b>			
		Trusted	Blocked	Throttled	Accepted

## Editing IP Reputation Filtering Score Thresholds for a Listener

Use this procedure if you want to change the default IP Reputation Service score thresholds or add a sender group for reputation filtering.



**Note** Other settings related to IP Reputation Score thresholds, and Mail Flow Policy settings, are described in [Defining Which Hosts Are Allowed to Connect Using the Host Access Table](#) , on page 89

### Before You Begin

- If your email gateway is set to receive mail from a local MX/MTA, identify upstream hosts that may mask the sender's IP address. See [Determining Sender IP Address In Deployments with Incoming Relays](#) , on page 407 for more information.
- Understand IP Reputation Scores. See [Defining Sender Groups by IP Reputation Score](#), on page 94.
- Choose a filtering approach for your organization and note the recommended settings for that approach. See [Recommended Settings for Different Sender IP Reputation Filtering Approaches](#) , on page 83.

### Procedure

- 
- Step 1** Select **Mail Policies > HAT Overview**.
- Step 2** Select the public listener from the **Sender Groups (Listener)** menu.
- Step 3** Click the link for a sender group.  
For example, click the “SUSPECTLIST” link.
- Step 4** Click **Edit Settings**.
- Step 5** Enter the range of IP Reputation Scores for this sender group.  
For example, for “ALLOWED\_LIST,” enter the range 7.0 to 10.
- Step 6** Click **Submit**.
- Step 7** Repeat as needed for each sender group for this listener.
- Step 8** Commit changes.
- 

### What to do next

#### Related Topics

- [Testing IP Reputation Filtering Using the IP Reputation Scores](#), on page 85
- [Defining Which Hosts Are Allowed to Connect Using the Host Access Table](#) , on page 89

- [How to Configure the Email Gateway to Scan Messages for Spam, on page 380](#)

## Testing IP Reputation Filtering Using the IP Reputation Scores

Unless you regularly receive a large portion of spam, or you have set up “dummy” accounts to specifically receive spam for your organization, it may be difficult to immediately test the IP Reputation policies you have implemented. However, if you add entries for reputation filtering with IP Reputation Scores into a listener’s HAT as indicated in the following table, you will notice that a smaller percentage of inbound mail will be “unclassified.”

Test the policies using the `trace` command with an arbitrary IP Reputation scores. See [Debugging Mail Flow Using Test Messages: Trace, on page 1255](#). The `trace` command is available in the CLI as well as the GUI.

**Table 10: Suggested Mail Flow Policies for Implementing the IP Reputation Scores**

Policy Name	Primary Behavior (Access Rule)	Parameters	Value
\$BLOCKED	REJECT	None	
\$THROTTLED	ACCEPT	Maximum messages / session: Maximum recipients / message: Maximum message size: Maximum concurrent connections: Use Spam Detection: Use TLS: Maximum recipients / hour: Use SenderBase:	10 20 1 MB 10 ON OFF <b>20 (recommended)</b> ON
\$ACCEPTED (Public Listener)	ACCEPT	Maximum messages / session: Maximum recipients / message: Maximum message size: Maximum concurrent connections: Use Spam Detection: Use TLS: Use SenderBase:	1,000 1,000 100 MB 1,000 ON OFF ON

Policy Name	Primary Behavior (Access Rule)	Parameters	Value
\$TRUSTED	ACCEPT	Maximum messages / session: Maximum recipients / message: Maximum message size: Maximum concurrent connections: Use Spam Detection: Use TLS: Maximum recipients / hour: Use SenderBase:	1,000 1,000 100 MB 1,000 OFF OFF -1 ( <i>disabled</i> ) OFF



**Note** In the \$THROTTLED policy, the maximum recipients per hour from the remote host is set to 20 recipients per hour, by default. Note that this setting controls the maximum throttling available. You can increase the number of recipients to receive per hour if this parameter is too aggressive. For more information on Default Host Access policies, see [Understanding Predefined Sender Groups and Mail Flow Policies, on page 98](#).

## Entering Low IP Reputation Scores in the Message Subject

Although Cisco recommends throttling, an alternate way to use the IP Reputation Service is to modify the subject line of suspected spam messages. To do this, use the message filter shown in the following table. This filter uses the reputation filter rule and the strip-header and insert-header filter actions to replace the subject line of messages having a IP Reputation Score lower than -2.0 with a subject line that includes the actual IP Reputation Score represented as: **{Spam IP Reputation Score}**. Replace *listener\_name* in this example with the name of your public listener. (The period on its own line is included so that you can cut and paste this text directly into the command line interface of the filters command.)

**Table: Message Filter to Modify Subject Header with IP Reputation: Example 1**

```

iprs_filter:

if ((recv-inj == "listener_name
" AND subject != "\\{Spam -?[0-9.]+\\}")

{

    insert-header("X-IPRS", "$REPUTATION");

    if (reputation <= -2.0)

    {

        strip-header("Subject");
    }
  
```

```
insert-header("Subject", "$Subject \\{Spam $REPUTATION\\}");  
  
}  
  
}
```

**Related Topic**

- [Using Message Filters to Enforce Email Policies, on page 127](#)







## CHAPTER 7

# Defining Which Hosts Are Allowed to Connect Using the Host Access Table

This chapter contains the following sections:

- [Overview of Defining Which Hosts Are Allowed to Connect, on page 89](#)
- [Defining Remote Hosts into Sender Groups, on page 90](#)
- [Defining Access Rules for Email Senders Using Mail Flow Policies, on page 95](#)
- [Understanding Predefined Sender Groups and Mail Flow Policies, on page 98](#)
- [Handling Messages from a Group of Senders in the Same Manner, on page 100](#)
- [Working with the Host Access Table Configuration, on page 109](#)
- [Using a List of Sender Addresses for Incoming Connection Rules, on page 110](#)
- [SenderBase Settings and Mail Flow Policies, on page 111](#)
- [Verifying Senders, on page 113](#)

## Overview of Defining Which Hosts Are Allowed to Connect

For every configured listener, you must define a set of rules that control incoming connections from remote hosts. For example, you can define remote hosts and whether or not they can connect to the listener. AsyncOS allows you to define which hosts are allowed to connect to the listener using the Host Access Table (HAT).

The HAT maintains a set of rules that control incoming connections from remote hosts for a listener. Every configured listener has its own HAT. You configure HATs for both public and private listeners.

To control incoming connections from remote hosts, you define the following information:

- **Remote hosts.** Define the way in which a remote host attempts to connect to the listener. You group remote host definitions into *sender groups*. For example, you can define multiple remote hosts in a sender group by IP address and partial hostname. You can also define remote hosts by their IP Reputation score. For more information, see [Defining Remote Hosts into Sender Groups, on page 90](#).
- **Access rules.** You can define whether the defined remote hosts in the sender group are allowed to connect to the listener and under what conditions. You define access rules using *mail flow policies*. For example, you can define that a particular sender group is allowed to connect to the listener, but only allow a maximum number of messages per connection. For more information, see [Defining Access Rules for Email Senders Using Mail Flow Policies, on page 95](#)

Define which hosts are allowed to connect to the listener on the Mail Policies > HAT Overview page.

When a listener receives a TCP connection, it compares the source IP address against the configured sender groups. It evaluates the sender groups in the order listed on the HAT Overview page. When it finds a match, it applies the configured mail flow policy to the connection. If you have configured multiple conditions within a sender group, that sender group is matched if any of the conditions match.

When you create a listener, AsyncOS creates predefined sender groups and mail flow policies for the listener. You can edit the predefined sender groups and mail flow policies, and create new sender groups and mail flow policies. For more information, see [Understanding Predefined Sender Groups and Mail Flow Policies, on page 98](#).

You can export all information stored in a Host Access Table to a file, and you can import Host Access Table information stored in a file into the email gateway for a listener, overriding all configured Host Access Table information. For more information, see [Working with the Host Access Table Configuration, on page 109](#).

### Related Topics

- [Default HAT Entries, on page 90](#)

## Default HAT Entries

By default, the HAT is defined to take different actions depending on the listener type:

- **Public listeners.** The HAT is set to *accept* email from *all* hosts.
- **Private listeners.** The HAT is set up to *relay* email from the host(s) you specify, and reject all other hosts.

In the HAT Overview, the default entry is named “ALL.” You can edit the default entry by clicking the mail flow policy for the ALL sender group on the Mail Policies > HAT Overview page.



---

**Note** By rejecting all hosts other than the ones you specify, the `listenerconfig` and `systemsetup` commands prevent you from unintentionally configuring your system as an “open relay.” An open relay (sometimes called an “insecure relay” or a “third party” relay) is an SMTP email server that allows third-party relay of email messages. By processing email that is neither for nor from a local user, an open relay makes it possible for an unscrupulous sender to route large volumes of spam through your gateway.

---

## Defining Remote Hosts into Sender Groups

You can define the way in which remote hosts attempt to connect to a listener. You group remote host definitions into sender groups. A sender group is a list of remote hosts defined for the purpose of handling email from those senders in the same way.

A sender group is a list of senders identified by:

- IP address (IPv4 or IPv6)
- IP range
- Specific host or domain name
- IP Reputation Service “organization” classification
- IP Reputation Score (IPRS) range (or lack of score)
- DNS List query response

For more information on the list of acceptable addresses in sender groups, see [Sender Group Syntax, on page 91](#).

When an SMTP server attempts an SMTP connection with the email gateway, the listener evaluates the sender groups in order and assigns the connection to a sender group when it matches *any* criterion in the sender group, such as IP reputation score, domain, or IP address.



**Note** The system acquires and verifies the validity of the remote host’s IP address by performing a double DNS lookup. This consists of a reverse DNS (PTR) lookup on the IP address of the connecting host, followed by a forward DNS (A) lookup on the results of the PTR lookup. The system then checks that the results of the A lookup match the results of the PTR lookup. If the results do not match, or if an A record does not exist, the system only uses the IP address to match entries in the HAT.

Define sender groups on the Mail Policies > HAT Overview page.

**Related Topics**

- [Sender Group Syntax, on page 91](#)
- [Sender Groups Defined by Network Owners, Domains, and IP Addresses, on page 92](#)
- [Defining Sender Groups by IP Reputation Score, on page 94](#)
- [Sender Groups Defined by Querying DNS Lists, on page 95](#)

## Sender Group Syntax

*Table 11: Defining Remote Hosts in the HAT: Sender Group Syntax*

Syntax	Meaning
n:n:n:n:n:n:n	IPv6 address; does not need to include leading zeroes.
n:n:n:n:n:n:n-n:n:n:n:n:n:n:n n:n-n:n:n:n:n:n	Range of IPv6 addresses; does not need to include leading zeroes.
n.n.n.n	Full (complete) IPv4 Address
n.n.n. n.n.n. n.n. n.n. n.	Partial IPv4 address
n.n.n.n-n. n.n.n.n-n. n.n.n-n. n.n-n. n.n-n n-n. n-n	Range of IPv4 addresses

Syntax	Meaning
<code>yourhost.example.com</code>	A fully-qualified domain name
<code>.partialhost</code>	Everything within the partialhost domain
<code>n/c</code> <code>n.n/c</code> <code>n.n.n/c</code> <code>n.n.n.n/c</code>	IPv4 CIDR address block
<code>n:n:n:n:n:n:n/c</code>	IPv6 CIDR address block; does not need to include leading zeroes
<code>SBRs [n:n] SBRs [none]</code>	IP Reputation Score. For more information, see <a href="#">Defining Sender Groups by IP Reputation Score, on page 94</a> .
<code>SBO:n</code>	Network Owner Identification Number. For more information, see <a href="#">Defining Sender Groups by IP Reputation Score, on page 94</a> .
<code>dnslist [dnsserver.domain]</code>	DNS List query. For more information, see <a href="#">Sender Groups Defined by Querying DNS Lists, on page 95</a> .
ALL	Special keyword that matches ALL addresses. This applies only to the ALL sender group, and is always included (but not listed).

## Sender Groups Defined by Network Owners, Domains, and IP Addresses

Since the SMTP protocol has no built-in method for authenticating senders of email, senders of unsolicited bulk email have been successful at employing a number of tactics for hiding their identity. Examples include spoofing the Envelope Sender address on a message, using a forged HELO address, or simply rotating through different domain names. This leaves many mail administrators asking themselves the fundamental question, “Who is sending me all of this email?” To answer this question, the IP Reputation Service has developed a unique hierarchy for aggregating identity-based information based on the IP address of the connecting host — the one thing that is almost impossible for a sender to forge in a message.

An **IP Address** is defined as the IP address of the sending mail host. The email gateway supports both Internet Protocol version 4 (IPv4) and version 6 (IPv6) addresses.

A **Domain** is defined as an entity that uses hostnames with a given second-level domain name (for example, yahoo.com), as determined by a reverse (PTR) lookup on the IP address.

A **Network Owner** is defined as an entity (usually a company) that controls a block of IP addresses, as determined based on IP address space assignments from global registries such as ARIN (the American Registry for Internet Numbers) and other sources.

An **Organization** is defined as an entity that most closely controls a particular group of mail gateways within a network owner’s IP block, as determined by SenderBase. An Organization may be the same as the Network Owner, a division within that Network Owner, or a customer of that Network Owner.

### Related Topics

- [Setting Policies Based on the HAT, on page 93](#)

## Setting Policies Based on the HAT

The following table lists some examples of network owners and organizations.

**Table 12: Example of Network Owners and Organizations**

Example Type	Network Owner	Organization
Network Service Provider	Level 3 Communications	Macromedia Inc. AllOutDeals.com GreatOffers.com
Email Service Provider	GE	GE Appliances GE Capital GE Mortgage
Commercial Sender	The Motley Fool	The Motley Fool

As network owners can range dramatically in size, the appropriate entity to base your mail flow policy on is the organization. The IP Reputation Service has a unique understanding of the source of the email down to the organization level, which the email gateway leverages to automatically apply policies based on the organization. In the example above, if a user specified “Level 3 Communications” as a sender group in the Host Access Table (HAT), SenderBase will enforce policies based on the individual organizations controlled by that network owner.

For example, in the table above, if a user enters a limit of 10 recipients per hour for Level 3, the email gateway will allow up to 10 recipients per hour for Macromedia Inc., Alloutdeals.com *and* Greatoffers.com (a total of 30 recipients per hour for the Level 3 network owner). The advantage of this approach is that if one of these organizations begins spamming, the other organizations controlled by Level 3 will not be impacted. Contrast this to the example of “The Motley Fool” network owner. If a user sets rate limiting to 10 recipients per hour, the Motley Fool network owner will receive a total limit of 10 recipients per hour.

The Mail Flow Monitor feature is a way of defining the sender and providing you with monitoring tools to create mail flow policy decisions about the sender. To create mail flow policy decisions about a given sender, ask these questions:

- **Which IP addresses are controlled by this sender?**

The first piece of information that the Mail Flow Monitor feature uses to control the inbound email processing is the answer to this question. The answer is derived by querying the IP Reputation Service. The IP Reputation Service provides information about the relative size of the sender (either the network owner or the SenderBase organization). Answering this question assumes the following:

- Larger organizations tend to control more IP addresses, and send more legitimate email.

- **Depending on its size, how should the overall number of connections be allotted for this sender?**

- Larger organizations tend to control more IP addresses, and send more legitimate email. Therefore, they should be allotted more connections to your email gateway.
- The sources of high-volume email are often ISPs, NSPs, companies that manage outsourced email delivery, or sources of unsolicited bulk email. ISPs, NSPS, and companies that manage outsourced email delivery are examples of organizations that control many IP addresses, and should be allotted more connections to your email gateway. Senders of unsolicited bulk email usually do not control

many IP addresses; rather, they send large volumes of mail through a few number of IP addresses. They should be allotted fewer connections to your email gateway.

The Mail Flow Monitor feature uses its differentiation between network owners and SenderBase organizations to determine how to allot connections per sender, based on logic in SenderBase. See the “Using Email Security Monitor” chapter for more information on using the Mail Flow Monitor feature.

## Defining Sender Groups by IP Reputation Score

The email gateway can query the IPReputation Service to determine a IP reputation score. The IP Reputation Score is a numeric value assigned to an IP address, domain, or organization based on information from the IP Reputation Service. The scale of the score ranges from -10.0 to +10.0, as described in the following table.

**Table 13: Definition of the IP Reputation Score**

Score	Meaning
-10.0	Most likely to be a source of spam
0	Neutral, or not enough information to make a recommendation
+10.0	Most likely to be a trustworthy sender
none	No data available for this sender (typically a source of spam)

Using the IP Reputation Score, you configure the email gateway to apply mail flow policies to senders based on their trustworthiness. For example, all senders with a score less than -7.5 could be rejected. This is most easily accomplished via the GUI; see [Creating a Sender Group for Message Handling](#), on page 101. However, if you are modifying an exported HAT in a text file, the syntax for including IP Reputation Scores is described in the following table.

**Table 14: Syntax for IP Reputation Scores**

SBRS[ <i>n n</i> ]	IP Reputation Score. Senders are identified by querying the IP Reputation Service, and the scores are defined between the ranges.
SBRS[none]	Specify no IP (very new domains may not have IP Reputation Scores yet).



**Note** Network owners added to a HAT via the GUI use the syntax `SBO:n`, where *n* is the network owner’s unique identification number in the IP Reputation Service.

Use the **Network > Listeners** page or `listenerconfig -> setup` command in the CLI to enable a listener to query the IP Reputation Service. You can also define the timeout value that the email gateway should wait when querying the IP Reputation Service. Then, you can configure different policies to use look ups to the IP Reputation Service by using the values in the Mail Policies Pages in the GUI or the `listenerconfig -> edit -> hostaccess` commands in the CLI.



---

**Note** You can also create message filters to specify “thresholds” for IP Reputation Scores to further act upon messages processed by the system. For more information, see “IP Reputation Rule,” “Bypass Anti-Spam System Action,” and “Bypass Anti-Virus System Action” in the anti-spam and anti-virus chapters.

---

## Sender Groups Defined by Querying DNS Lists

You also have the ability in a listener’s HAT to define a sender group as matching a query to a specific DNS List sever. The query is performed via DNS at the time of the remote client’s connection. The ability to query a remote list also exists currently as a message filter rule (see “DNS List Rule” in the chapter on “Using Message Filters to Enforce Email Policies”), but only once the message content has been received in full.

This mechanism allows you to configure a sender within a group that queries a DNS List so that you can adjust your mail flow policies accordingly. For example, you could reject connections or limit the behavior of the connecting domain.



---

**Note** Some DNS Lists use variable responses (for example, “127.0.0.1” versus “127.0.0.2” versus “127.0.0.3”) to indicate various facts about the IP address being queried against. If you use the message filter DNS List rule (see “DNS List Rule” in the chapter on “Using Message Filters to Enforce Email Policies”), you can compare the result of the query against different values. However, specifying a DNS List server to be queried in the HAT only supports a Boolean operation for simplicity (that is, does the IP address appear in the list or not)

---



---

**Note** Be sure to include brackets in the query in the CLI. Brackets are not necessary when specifying a DNS List query in the GUI. Use the `dnslistconfig` command in the CLI to test a query, configure general settings for DNL queries, or flush the current DNS list cache.

---

Note that this mechanism can be used to identify “good” connections as well as “bad” connections. For example, a query to `query.bondedsender.org` will match on connecting hosts who have posted a financial bond with Cisco Systems’ Bonded Sender™ program to ensure the integrity of their email campaign. You could modify the default `ALLOWED_LIST` sender group to query the Bonded Sender program’s DNS servers (which lists these legitimate email senders who have willingly posted bonds) and adjust the mail flow policy accordingly.

## Defining Access Rules for Email Senders Using Mail Flow Policies

Mail flow policies allow you to control or limit the flow of email messages from a sender to the listener during the SMTP conversation. You control SMTP conversations by defining the following types of parameters in the mail flow policy:

- Connection parameters, such as maximum number of messages per connection.
- Rate limiting parameters, such as maximum number of recipients per hour.

- Modify custom SMTP codes and responses communicated during the SMTP conversation.
- Enable spam detection.
- Enable virus protection.
- Encryption, such as using TLS to encrypt the SMTP connection.
- Authentication parameters, such as using DKIM to verify incoming mail.

Ultimately, mail flow policies perform one of the following actions on connections from remote hosts:

- **ACCEPT.** Connection is accepted, and email acceptance is then further restricted by listener settings, including the Recipient Access Table (for public listeners).
- **REJECT.** Connection is initially accepted, but the client attempting to connect gets a 4XX or 5XX SMTP status code. No email is accepted.



**Note** You can also configure AsyncOS to perform this rejection at the message recipient level (RCPT TO), rather than at the start of the SMTP conversation. Rejecting messages in this way delays the message rejection and bounces the message, allowing AsyncOS to retain more detailed information about the rejected messages. This setting is configured from the CLI `listenerconfig > setup` command. For more information, see [Listening for Connection Requests by Creating a Listener Using CLI, on page 76](#).

- **TCPREFUSE.** Connection is refused at the TCP level.
- **RELAY.** Connection is accepted. Receiving for any recipient is allowed and is not constrained by the Recipient Access Table.
- **CONTINUE.** The mapping in the HAT is ignored, and processing of the HAT continues. If the incoming connection matches a later entry that is not CONTINUE, that entry is used instead. The CONTINUE rule is used to facilitate the editing of the HAT in the GUI. For more information, see [Creating a Sender Group for Message Handling, on page 101](#).

### Related Topics

- [HAT Variable Syntax, on page 96](#)

## HAT Variable Syntax

The following table defines a set of variables that can also be used in conjunction with the custom SMTP and Rate Limiting banners defined for a mail flow policy. Variable names are case-insensitive. (That is, \$group is equivalent to \$Group .)

**Table 15: HAT Variable Syntax**

Variable	Definition
\$Group	Replaced by the name of the sender group that was matched in the HAT. If the sender group has no name, “None” is displayed.



Variable	Definition
\$Hostname	Replaced by the remote hostname if and only if it has been validated by the email gateway. If the reverse DNS lookup of the IP address is successful but returns no hostname, then “None” is displayed. If the reverse DNS lookup fails (for example, if the DNS server cannot be reached, or no DNS server has been configured) then “Unknown” is displayed.
\$OrgID	Replaced by the SenderBase Organization ID (an integer value). If the email gateway cannot obtain a SenderBase Organization ID, or if the IP Reputation Service did not return a value, “None” is displayed.
\$RemoteIP	Replaced by the IP address of the remote client.
\$HATEntry	Replaced by the entry in the HAT that the remote client matched.

### Related Topics

- [Using HAT Variables, on page 97](#)
- [Testing HAT Variables, on page 98](#)

## Using HAT Variables



**Note** These variables can be used with the `smtp_banner_text` and `max_rcpts_per_hour_text` advanced HAT parameters described in the “Configuring the Gateway to Receive Email” chapter.

Using these variables, you could edit the custom SMTP banner response text for accepted connections in the \$TRUSTED policy in the GUI:

**Figure 15: Using HAT Variables**

Rate Limiting:	Max. Recipients Per Hour:	<input checked="" type="radio"/> Unlimited <input type="radio"/> <input type="text"/>
	Max. Recipients Per Hour Code:	<input type="text" value="452"/>
	Max. Recipients Per Hour Text:	<input type="text" value="Too many recipients received this hour from Host: \$hostname"/>

Or like this, in the CLI:

```
Would you like to specify a custom SMTP response? [Y]> y
```

```
Enter the SMTP code to use in the response. 220 is the standard code.
```

```
[220]> 200
```

```
Enter your custom SMTP response. Press Enter on a blank line to finish.
```

You've connected from the hostname: \$Hostname, IP address of: \$RemoteIP, matched the group: \$Group, \$HATEntry and the SenderBase Organization: \$OrgID.

## Testing HAT Variables

To test these variables, add the IP address of a known, trusted machine to the \$ALLOWED\_LIST sender group of a listener on the email gateway. Then, connect from that machine via telnet. You can see the variable substitution in the SMTP response. For example:

```
# telnet
IP_address_of_Email_Security_Appliance_port

220 hostname
ESMTP

200 You've connected from the hostname: hostname
, IP address of: IP-address_of_connecting_machine
, matched the group: ALLOWED_LIST, 10.1.1.1 the SenderBase Organization: OrgID
.
```

## Understanding Predefined Sender Groups and Mail Flow Policies

The following table lists the predefined sender groups and mail flow policies that are configured when a public listener is created.

**Table 16: Predefined Sender Groups and Mail Flow Policies for Public Listeners**

Predefined Sender Group	Description	Default Configured Mail Flow Policy
ALLOWED_LIST	Add senders you trust to the Allowed_list sender group. The \$TRUSTED mail flow policy is configured so that email from senders you trust has no rate limiting enabled, and the content from those senders is not scanned by the Anti-Spam or Anti-Virus software.	\$TRUSTED
BLOCKED_LIST	Senders in the Blocked_list sender group are rejected (by the parameters set in the \$BLOCKED mail flow policy). Adding senders to this group rejects connections from those hosts by returning a 5XX SMTP response in the SMTP HELO command.	\$BLOCKED

Predefined Sender Group	Description	Default Configured Mail Flow Policy
SUSPECTLIST	<p>The Suspectlist sender group contains a mail flow policy that throttles, or slows, the rate of incoming mail. If senders are suspicious, you can add them to the Suspectlist sender group, where the mail flow policy dictates that:</p> <ul style="list-style-type: none"> <li>• Rate limiting limits the maximum number of messages per session, the maximum number of recipients per message, the maximum message size, and the maximum number of concurrent connections you are willing to accept from a remote host.</li> <li>• The maximum recipients per hour from the remote host is set to 20 recipients per hour. Note that this setting is the maximum throttling available. You can increase the number of recipients to receive per hour if this parameter is too aggressive.</li> <li>• The content of messages will be scanned by the anti-spam scanning engine and the anti-virus scanning engine (if you have these feature enabled for the system).</li> <li>• The SenderBase Reputation Service will be queried for more information about the sender.</li> </ul>	\$THROTTLED
UNKNOWNLIST	<p>The Unknownlist sender group may be useful if you are undecided about the mail flow policy you should use for a given sender. The mail flow policy for this group dictates that mail is accepted for senders in this group, but the Anti-Spam software (if enabled for the system), the anti-virus scanning engine, and the IP Reputation Service should all be used to gain more information about the sender and the message content. Rate limits for senders in this group are also enabled with default values. For more information on virus scanning engines, see <a href="#">Virus Scanning, on page 363</a>. For more information on the IP Reputation Service, see <a href="#">IP Reputation Service, on page 81</a>.</p>	\$ACCEPTED
ALL	<p>Default sender group that applies to all other senders. For more information, see <a href="#">Default HAT Entries, on page 90</a>.</p>	\$ACCEPTED

The following table lists the predefined sender groups and mail flow policies that are configured when a private listener is created.

Table 17: Predefined Sender Groups and Mail Flow Policies for Private Listeners

Predefined Sender Group	Description	Default Configured Mail Flow Policy
RELAYLIST	<p>Add senders you know should be allowed to relay to the Relaylist sender group. The \$RELAYED mail flow policy is configured so that email from senders you are allowing to relay has no rate limiting, and the content from those senders is not scanned by the anti-spam scanning engine or anti-virus software.</p> <p><b>Note</b> The RELAYLIST sender group includes the systems allowed to relay email when the System Setup Wizard was run.</p>	\$RELAYED
ALL	<p>Default sender group that applies to all other senders. For more information, see <a href="#">Default HAT Entries, on page 90</a>.</p>	\$BLOCKED



**Note** When you run the System Setup Wizard on an email gateway model that has only two Ethernet ports, you are prompted to create only one listener. It creates a public listener that also includes a \$RELAYED mail flow policy that is used to relay mail for internal systems. For email gateway models that have more than two Ethernet ports, the RELAYLIST sender group and \$RELAYED mail flow policy only appear on private listeners.

## Handling Messages from a Group of Senders in the Same Manner

Use the Mail Policies > HAT Overview and Mail Flow Policy pages to configure how the listener handles messages from senders. Do this by creating, editing, and deleting sender groups and mail flow policies.

### Related Topics

- [Creating a Sender Group for Message Handling](#), on page 101
- [Adding a Sender to an Existing Sender Group](#), on page 102
- [Rearranging the Order of the Rules to Perform for Incoming Connections](#), on page 102
- [Searching for Senders](#), on page 103
- [Defining Access Rules for Email Senders Using Mail Flow Policies](#), on page 95
- [Defining Default Values for Mail Flow Policies](#), on page 108

# Creating a Sender Group for Message Handling

## Procedure

---

- Step 1** Navigate to the **Mail Policies > HAT Overview** page.
- Step 2** Choose the listener to edit in the Listener field.
- Step 3** Click **Add Sender Group**.
- Step 4** Type the name of the sender group.
- Step 5** Select the order in which to place it in the list of sender groups.
- Step 6** (Optional) Enter a comment, for example information about this sender group or its settings.
- Step 7** Select a mail flow policy to which to apply this sender group.
- Note** If you do not know the mail flow policy you would like to apply to this group (or if no mail flow policies exist yet), then use the default “CONTINUE (no policy)” mail flow policy.
- Step 8** (Optional) Select a DNS list.
- Step 9** (Optional) Include senders for which IP Reputation Score has no information. This is referred to as “none” and generally denotes a suspect.
- Step 10** (Optional) Enter a DNS list.
- Step 11** (Optional) Configure host DNS verification settings.
- For more information, see [Implementing More Stringent Throttling Settings for Unverified Senders](#), on page 117 .
- Step 12** Click **Submit** to create the sender group.
- Step 13** Click on the newly created sender group.
- Step 14** Click **Add Sender** to add senders to the sender group.
- **Add sender IP address** .Select **IP Addresses**, add an IPv4 address, IPv6 address, or a hostname, and submit the changes.  
A sender can include a range of IP addresses and partial hostnames.
  - **Add sender's country of origin**. Select **Geolocation**, select the country, and submit the changes.
- Step 15** Submit and commit your changes.
- 

## What to do next

### Related Topics

- [Editing IP Reputation Filtering Score Thresholds for a Listener](#) , on page 84

## Adding a Sender to an Existing Sender Group

### Procedure

---

**Step 1** From a domain, IP, or network owner profile page, click the Add to Sender Group link.

**Step 2** Choose the sender group from the list defined for each listener.

**Step 3** Submit and commit your changes.

**Note** When you add a domain to a sender group, two actual domains are listed in the GUI. For example, if you were adding the domain `example.net`, on the Add to Sender Group page, both `example.net` and `.example.net` are added. The second entry ensures that any host in the subdomain of `example.net` will be added to the sender group. For more information, see [Sender Group Syntax, on page 91](#).

If one or more of the senders you are adding to a sender group is a duplicate of a sender that is already present in that sender group, the duplicate senders will not be added and you will see a confirmation message.

**Step 4** Click **Save** to add the sender and return to the Incoming Mail Overview page.

---

### What to do next

#### Related Topics

- [Protecting Email Gateway-Generated Messages From the Spam Filter, on page 401](#)
- [How to Configure the Email Gateway to Scan Messages for Spam, on page 380](#)

## Rearranging the Order of the Rules to Perform for Incoming Connections

If you add a sender group to a listener, you may need to edit the sender group order.

The HAT is read from top to bottom for each host that attempts to connect to the listener. If a rule matches a connecting host, the action is taken for that connection immediately.

### Procedure

---

**Step 1** Navigate to the **Mail Policies > HAT Overview** page.

**Step 2** Choose the listener to edit in the Listener field.

**Step 3** Click **Edit Order**.

**Step 4** Type the new order for existing rows of sender groups in the HAT.

Cisco recommends maintaining the default order: RELAYLIST (certain hardware models only), followed by ALLOWED\_LIST, BLOCKED\_LIST, SUSPECTLIST, and UNKNOWNLIST.

**Step 5** Submit and commit your changes.

---

## Searching for Senders

You can find senders by entering text in the Find Senders field at the top of the HAT Overview page. Enter the text to search with and click Find.

## Defining Rules for Incoming Messages Using a Mail Flow Policy

Consider the following rules and guidelines before creating a mail flow policy:

- Defaults for the policy are “greyed out” while the “Use Default” radio button is selected. To overwrite the default values, enable the feature or setting by selecting the “On” radio button and making changes to the now accessible values. To define default values, see [Defining Default Values for Mail Flow Policies, on page 108](#).
- Some parameters depend on certain pre-configurations. (For example, the Directory Harvest Attack prevention setting requires that you have configured an LDAP Acceptance Query.)

### Procedure

- Step 1** Navigate to the **Mail Policies > Mail Flow Policies** page.
- Step 2** Click **Add Policy**.
- Step 3** Enter the information described in the following table.

**Table 18: Mail Flow Policy Parameters**

Parameter	Description
<b>Connections</b>	
Maximum message size	The maximum size of a message that will be accepted by this listener. The smallest possible maximum message size is 1 kilobyte.
Maximum concurrent connections from a single IP	The maximum number of concurrent connections allowed to connect to this listener from a single IP address.
Maximum messages per connection	The maximum number of messages that can be sent through this listener per connection from a remote host.
Maximum recipients per message	That maximum number of recipients per message that will be accepted from this host.
<b>SMTP Banner</b>	
Custom SMTP Banner Code	The SMTP code returned when a connection is established with this listener.
Custom SMTP Banner Text	The SMTP banner text returned when a connection is established with this listener. <b>Note</b> You can use some variables in this field. For more information, see <a href="#">HAT Variable Syntax, on page 96</a> .

Parameter	Description
Custom SMTP Reject Banner Code	The SMTP code returned when a connection is rejected by this listener.
Custom SMTP Reject Banner Text	The SMTP banner text returned when a connection is rejected by this listener.
Override SMTP Banner Host Name	By default, the email gateway will include the hostname associated with the interface of the listener when displaying the SMTP banner to remote hosts (for example: 220- <i>hostname</i> ESMTP ). You may choose to override this banner by entering a different hostname here. Additionally, you may leave the hostname field blank to choose <i>not</i> to display a hostname in the banner.
<b>Rate Limit for Hosts</b>	
Max. Recipients per Hour	The maximum number of recipients per hour this listener will receive from a remote host. The number of recipients per sender IP address is tracked globally. Each listener tracks its own rate limiting threshold; however, because all listeners validate against a single counter, it is more likely that the rate limit will be exceeded if the same IP address (sender) is connecting to multiple listeners.  <b>Note</b> You can use some variables in this field. For more information, see <a href="#">HAT Variable Syntax, on page 96</a> .
Max. Recipients per Hour Code	The SMTP code returned when a host exceeds the maximum number of recipients per hour defined for this listener.
Max. Recipients Per Hour Exceeded Text	The SMTP banner text returned when a host exceeds the maximum number of recipients per hour defined for this listener.
<b>Rate Limit for Sender</b>	
Max. Recipients per Time Interval	The maximum number of recipients during a specified time period that this listener will receive from a unique envelope sender, based on the mail-from address. The number of recipients is not tracked globally. Each listener tracks its own rate limiting threshold; however, because all listeners validate against a single counter, it is more likely that the rate limit will be exceeded if messages from the same mail-from address are received by multiple listeners.  Select whether to use the default maximum recipients, accept unlimited recipients, or specify another maximum number of recipients.  Use the Default Mail Flow Policy settings to specify the maximum number of recipients and the time interval that will be used by the other mail flow policies by default. The time interval can only be specified using the Default Mail Flow Policy.
Sender Rate Limit Exceeded Error Code	The SMTP code returned when an envelope exceeds the maximum number of recipients for the time interval defined for this listener.
Sender Rate Limit Exceeded Error Text	The SMTP banner text returned when an envelope sender exceeds the maximum number of recipients for the time interval defined for this listener.



Parameter	Description
Exceptions	If you want certain envelope senders to be exempt from the defined rate limit, select an address list that contains the envelope senders. See <a href="#">Using a List of Sender Addresses for Incoming Connection Rules, on page 110</a> for more information.
<b>Flow Control</b>	
Use SenderBase for Flow Control	Enable “look ups” to the IP Reputation Service for this listener.
Group by Similarity of IP Addresses: (significant bits 0-32)	Used to track and rate limit incoming mail on a per-IP address basis while managing entries in a listener’s Host Access Table (HAT) in large CIDR blocks. You define a range of significant bits (from 0 to 32) by which to group similar IP addresses for the purposes of rate limiting, while still maintaining an individual counter for each IP address within that range. Requires “Use SenderBase” to be disabled. For more information about HAT significant bits, see <a href="#">Configuring Routing and Delivery Features, on page 693</a> .
<b>Directory Harvest Attack Prevention (DHAP)</b>	
Directory Harvest Attack Prevention: Maximum Invalid Recipients Per Hour	The maximum number of invalid recipients per hour this listener will receive from a remote host. This threshold represents the total number of RAT rejections and SMTP call-ahead server rejections combined with the total number of messages to invalid LDAP recipients dropped in the SMTP conversation or bounced in the work queue (as configured in the LDAP accept settings on the associated listener). For more information on configuring DHAP for LDAP accept queries, see <a href="#">Working with LDAP Queries, on page 781</a> .
Directory Harvest Attack Prevention: Drop Connection if DHAP threshold is Reached within an SMTP Conversation	The email gateway will drop a connection to a host if the threshold of invalid recipients is reached.
Max. Invalid Recipients Per Hour Code:	Specify the code to use when dropping connections. The default code is 550.
Max. Invalid Recipients Per Hour Text:	Specify the text to use for dropped connections. The default text is “Too many invalid recipients.”
Drop Connection if DHAP threshold is reached within an SMTP Conversation	Enable to drop connections if the DHAP threshold is reached within an SMTP conversation.
Max. Invalid Recipients Per Hour Code	Specify the code to use when dropping connections due to DHAP within an SMTP conversation. The default code is 550.

Parameter	Description
Max. Invalid Recipients Per Hour Text:	Specify the text to use when dropping connections due to DHAP within an SMTP conversation.
<b>Spam Detection</b>	
Anti-spam scanning	Enable anti-spam scanning on this listener.
<b>Virus Detection</b>	
Anti-virus scanning	Enable the anti-virus scanning on this listener.
<b>Sender Domain Reputation Verification</b>	
Sender Domain Reputation Verification	Enable sender domain reputation verification.
<b>Encryption and Authentication</b>	
TLS	<p>Deny, Prefer, or Require Transport Layer Security (TLS) in SMTP conversations for this listener.</p> <p>If you select Preferred, you can make TLS mandatory for envelope senders from a specific domain or with a specific email address by selecting an Address List that specifies those domains and email addresses. When an envelope sender matching a domain or address in this list tries to send a message over a connection that does not use TLS, the email gateway rejects the connection and the sender will have to try again using TLS.</p> <p>The Verify Client Certificate option directs the email gateway to establish a TLS connection to the user's mail application if the client certificate is valid. If you select this option for the TLS Preferred setting, the email gateway still allows a non-TLS connection if the user doesn't have a certificate, but rejects a connection if the user has an invalid certificate. For the TLS Required setting, selecting this option requires the user to have a valid certificate in order for the email gateway to allow the connection.</p> <p>For information on creating an address list, see <a href="#">Using a List of Sender Addresses for Incoming Connection Rules, on page 110</a>.</p> <p>For information on using client certificates for TLS connections, see <a href="#">Establishing a TLS Connection from the Email Gateway, on page 823</a>.</p>
SMTP Authentication	Allows, disallow, or requires SMTP Authentication from remote hosts connecting to the listener. SMTP Authentication is described in detail in the "LDAP Queries" chapter.
If Both TLS and SMTP Authentication are enabled:	Require TLS to offer SMTP Authentication.

Parameter	Description
Domain Key/ DKIM Signing	Enable Domain Keys or DKIM signing on this listener (ACCEPT and RELAY only).
DKIM Verification	Enable DKIM verification.
<b>S/MIME Decryption and Verification</b>	
S/MIME Decryption/Verification	<ul style="list-style-type: none"> <li>• Enable S/MIME decryption or verification.</li> <li>• Choose whether to retain or remove the digital signature from the messages after S/MIME verification. For triple wrapped messages, only the inner signature is retained or removed.</li> </ul>
<b>S/MIME Public Key Harvesting</b>	
S/MIME Public Key Harvesting	Enable S/MIME public key harvesting.
Harvest Certificates on Verification Failure	Choose whether to harvest public keys if the verification of the incoming signed messages fail.
Store Updated Certificate	Choose whether to harvest updated public keys.
<b>SPF/SIDF Verification</b>	
Enable SPF/SIDF Verification	Enable SPF/SIDF signing on this listener. For more information, see <a href="#">Email Authentication, on page 597</a> .
Conformance Level	Set the SPF/SIDF conformance level. You can choose from SPF, SIDF or SIDF Compatible. For details, see <a href="#">Email Authentication, on page 597</a> .
Downgrade PRA verification result if 'Resent-Sender:' or 'Resent-From:' were used:	If you choose a conformance level of SIDF compatible, configure whether you want to downgrade Pass result of the PRA Identity verification to None if there are Resent-Sender: or Resent-From: headers present in the message. You may choose this option for security purposes.
HELO Test	Configure whether you want to perform a test against the HELO identity (Use this for SPF and SIDF Compatible conformance levels).
<b>DMARC Verification</b>	
Enable DMARC Verification	Enable DMARC verification on this listener. For more information, see <a href="#">DMARC Verification, on page 628</a> .
Use DMARC Verification Profile	Select the DMARC verification profile that you want to use on this listener.

Parameter	Description
DMARC Feedback Reports	<p>Enable sending of DMARC aggregate feedback reports.</p> <p>For more information about DMARC aggregate feedback report, see <a href="#">DMARC Aggregate Reports, on page 635</a>.</p> <p><b>Note</b> DMARC specification requires the feedback report messages to be DMARC compliant. Make sure that these messages are DKIM signed or you must publish appropriate SPF records.</p>
<b>Untagged Bounces</b>	
Consider Untagged Bounces to be Valid	<p>Applies only if bounce verification tagging (discussed in the “Configuring Routing and Delivery Features” chapter) is enabled. By default, the appliance considers untagged bounces invalid and either rejects the bounce or adds a custom header, depending on the Bounce Verification settings. If you choose to consider untagged bounces to be valid, the email gateway accepts the bounce message.</p>
<b>Envelope Sender DNS Verification</b>	
	See <a href="#">Verifying Senders, on page 113</a> .
<b>Exception Table</b>	
Use Exception Table	Use the sender verification domain exception table. You can only have one exception table, but you can enable it per mail flow policy. See <a href="#">Sender Verification Exception Table, on page 115</a> for more information.

**Note** If anti-spam or anti-virus scanning is enabled globally in the HAT, messages are flagged for anti-spam or anti-virus scanning as they are accepted by the email gateway. If anti-spam or anti-virus scanning is disabled after the message is accepted, the message will still be subject to scanning when it leaves the work queue.

**Step 4** Submit and commit your changes.

## Defining Default Values for Mail Flow Policies

### Procedure

- Step 1** Click **Mail Policies > Mail Flow Policies**.
- Step 2** Choose the listener to edit in the Listener field.
- Step 3** Click the **Default Policy Parameters** link below the configured mail flow policies.
- Step 4** Define the default values that all mail flow policies for this listener use.

For more information on the properties, see [Defining Rules for Incoming Messages Using a Mail Flow Policy, on page 103](#).

- Step 5** Submit and commit your changes.
- 

## Working with the Host Access Table Configuration

You can export all information stored in a Host Access Table to a file, and you can import Host Access Table information stored in a file into the email gateway for a listener, overwriting all existing Host Access Table information.

### Related Topics

- [Exporting the Host Access Table Configuration to an External File, on page 109](#)
- [Importing the Host Access Table Configuration from an External File, on page 109](#)

## Exporting the Host Access Table Configuration to an External File

### Procedure

---

- Step 1** Navigate to the Mail Policies > HAT Overview page.
- Step 2** Choose the listener to edit in the Listener menu.
- Step 3** Click **Export HAT**.
- Step 4** Enter a file name for the exported HAT. This is the name of the file that will be created in the configuration directory on the email gateway.
- Step 5** Submit and commit your changes.
- 

## Importing the Host Access Table Configuration from an External File

When you import a HAT, all of the existing HAT entries are removed from the current HAT.

### Procedure

---

- Step 1** Navigate to the Mail Policies > HAT Overview page.
- Step 2** Choose the listener to edit in the Listener menu.
- Step 3** Click **Import HAT**.
- Step 4** Select a file from the list.
- Note** The file to import must be in the configuration directory on the email gateway.
- Step 5** Click **Submit**. You will see a warning message, asking you to confirm that you wish to remove all of the existing HAT entries.
- Step 6** Click **Import**.
- Step 7** Commit your changes.

You can place “comments” in the file. Lines that begin with a ‘#’ character are considered comments and are ignored by AsyncOS. For example:

```
# File exported by the GUI at 20060530T215438
$BLOCKED
    REJECT {}
[ ... ]
```

## Using a List of Sender Addresses for Incoming Connection Rules

Mail flow policies allow you to use of an address list for certain settings that apply to a group of envelope senders, such as rate limiting exemptions and mandatory TLS connections. An address list can consist of email addresses, domains, partial domains, and IP addresses. You can use the **Mail Policies > Address Lists** page in the GUI or the `addresslistconfig` command in the CLI to create an address list. The Address Lists page displays all address lists on the email gateway, along with any mail flow policies that use an address list.

### Procedure

- Step 1** Select **Mail Policies > Address Lists**.
- Step 2** Click **Add Address List**.
- Step 3** Enter a name for the address list.
- Step 4** Enter a description of the address list.
- Step 5** (Optional) To enforce using full email addresses in the address list, select **Full Email Addresses only**.
- Step 6** Choose any one of the following options to create an address list:
  - Select **Full Email Addresses only** if you want to enforce using full email addresses in the address list.
  - Select **Domains only** if you want to enforce using domains in the address list.
  - Select **IP Addresses only** if you want to enforce using IP addresses in the address list.
- Step 7** Enter the addresses you want to include. You can use the following formats:
  - Full email address: `user@example.com`
  - Partial email address: `user@`

**Note** If you have selected **Allow only full Email Addresses**, you cannot use partial email addresses.

  - IP address in their email address: `@[1.2.3.4]`
  - All users in a domain: `@example.com`
  - All users in a partial domain: `@.example.com`

Note that domains and IP addresses must start with a @ character.

Separate email addresses with a comma. If you separate the addresses using a new line, AsyncOS automatically converts your entries into a comma-separated list.

**Step 8** Submit and commit your changes.

---

## SenderBase Settings and Mail Flow Policies

In order to classify connections to the email gateway and apply mail flow policies (which may or may not contain rate limiting), a listener uses the following methodology:

**Classification -> Sender Group -> Mail Flow Policy -> Rate Limiting**

For more information, see [Sender Groups Defined by Network Owners, Domains, and IP Addresses](#), on page 92.

The “Classification” stage uses the sending host’s IP address to classify an inbound SMTP session (received on a public listener) into a Sender Group. The Mail Flow Policy associated with that Sender Group may have parameters for rate limiting enabled. (Rate limiting limits the maximum number of messages per session, the maximum number of recipients per message, the maximum message size, and/or the maximum number of concurrent connections you are willing to accept from a remote host.)

Normally, in this process, recipients are counted against each sender in the corresponding named sender group. If mail is received from several senders in the same hour, the total recipients for all senders is compared against the limit.

There are some exceptions to this counting methodology:

- If the classification is done by Network Owner, then the IP Reputation Service will automatically divide a large block of addresses into smaller blocks.

Counting of recipients and recipient rate limiting is done separately for each of these smaller blocks (usually, but not always, the equivalent of a /24 CIDR block).

- If the HAT Significant Bits feature is used. In this case, a large block of addresses may be divided into smaller blocks by applying the significant bits parameter associated with the policy.

Note that this parameter relates to the **Mail Flow Policy -> Rate Limiting** phase. It is not the same as the “bits” field in the “network/bits” CIDR notation that may be used to classify IP addresses in a Sender Group.

By default, IP Reputation Service and IP Profiling support are *enabled* for public listeners and *disabled* for private listeners.

### Related Topics

- [HAT Significant Bits Feature](#), on page 111

## HAT Significant Bits Feature

Beginning with the 3.8.3 release of AsyncOS, you can track and rate limit incoming mail on a per-IP address basis while managing sender group entries in a listener’s Host Access Table (HAT) in large CIDR blocks. For example, if an incoming connection matched against the host “10.1.1.0/24,” a counter could still be generated for each individual address within that range, rather than aggregating all traffic into one large counter.



**Note** In order for the significant bits HAT policy option to take effect, you *must* not enable “User SenderBase” in the Flow Control options for the HAT (or, for the CLI, answer **no** to the question for enabling the SenderBase Information Service in the `listenerconfig -> setup` command: “Would you like to enable Reputation Filters and IP Profiling support?”). That is, the Hat Significant Bits feature and enabling SenderBase IP Profiling support are mutually exclusive.

In most cases, you can use this feature to define sender groups *broadly* — that is, large groups of IP addresses such as “10.1.1.0/24” or “10.1.0.0/16” — while applying mail flow rate limiting *narrowly* to smaller groups of IP addresses.

The HAT Significant Bits feature corresponds to these components of the system:

- [HAT Configuration](#) , on page 112
- [Significant Bits HAT Policy Option](#) , on page 112
- [Injection Control Periodicity](#) , on page 112

## HAT Configuration

There are two parts of HAT configuration: sender groups and mail flow policies. Sender group configuration defines how a sender's IP address is “classified” (put in a sender group). Mail flow policy configuration defines how the SMTP session from that IP address is controlled. When using this feature, an IP address may be “classified in a CIDR block” (e.g. 10.1.1.0/24) sender group while being controlled as an individual host (/32). This is done via the “significant\_bits” policy configuration setting.

## Significant Bits HAT Policy Option

The HAT syntax allows for the `significant_bits` configuration option. This feature appears in the GUI in the Mail Policies > Mail Flow Policies page.

When the option to use SenderBase for flow control is set to “OFF” or Directory Harvest Attack Prevention is enabled, the “significant bits” value is applied to the connecting sender’s IP address, and the resulting CIDR notation is used as the token for matching defined sender groups within the HAT. Any rightmost bits that are covered by the CIDR block are “zeroed out” when constructing the string. Thus, if a connection from the IP address 1.2.3.4 is made and matches on a policy with the `significant_bits` option set to 24, the resultant CIDR block would be 1.2.3.0/24. So by using this feature, the HAT sender group entry (for example, 10.1.1.0/24) can have a different number of network significant bits (24) from the significant bits entry in the policy assigned to that group (32, in the example).

For more information on `listenerconfig` command, see the CLI Reference Guide for AsyncOS for Cisco Secure Email Gateway.

## Injection Control Periodicity

A global configuration option exists to allow you to adjust when the injection control counters are reset. For very busy systems maintaining counters for a very large number of different IP addresses, configuring the counters to be reset more frequently (for example, every 15 minutes instead of every 60 minutes) will ensure that the data does not grow to an unmanageable size and impact system performance.

The current default value is 3600 seconds (1 hour). You can specify periods ranging from as little as 1 minute (60 seconds) to as long as 4 hours (14,400 seconds).



Adjust this period via the GUI, using the global settings (for more information, see [Configuring Global Settings for Listeners, on page 68](#)).

You can also adjust this period using the `listenerconfig -> setup` command in the CLI. For more information on `listenerconfig` command, see the CLI Reference Guide for AsyncOS for Cisco Secure Email Gateway.

## Verifying Senders

Spam and unwanted mail is frequently sent by senders whose domains or IP addresses cannot be resolved by DNS. DNS verification means that you can get reliable information about senders and process mail accordingly. Sender verification prior to the SMTP conversation (connection filtering based on DNS lookups of the sender's IP address) also helps reduce the amount of junk email processed through the mail pipeline on the email gateway.

Mail from unverified senders is not automatically discarded. Instead, AsyncOS provides sender verification settings that allow you to determine how the email gateway handles mail from unverified senders: you can configure your email gateway to automatically block all mail from unverified senders prior to the SMTP conversation or throttle unverified senders, for example.

The sender verification feature consists of the following components:

- **Verification of the connecting host.** This occurs prior to the SMTP conversation. For more information, see [Sender Verification: Host, on page 113](#).
- **Verification of the domain portion of the envelope sender.** This occurs during the SMTP conversation. For more information, see [Sender Verification: Envelope Sender, on page 114](#).

### Related Topics

- [Sender Verification: Host, on page 113](#)
- [Sender Verification: Envelope Sender, on page 114](#)
- [Implementing Sender Verification — Example Settings, on page 116](#)
- [Testing Your Settings for Messages from Unverified Senders, on page 119](#)
- [Sender Verification and Logging, on page 120](#)

## Sender Verification: Host

Senders can be unverified for different reasons. For example, the DNS server could be “down” or not responding, or the domain may not exist. Host DNS verification settings for sender groups allow you to classify unverified senders prior to the SMTP conversation and include different types of unverified senders in your various sender groups.

The email gateway attempts to verify the sending domain of the connecting host via DNS for incoming mail. This verification is performed prior to the SMTP conversation. The system acquires and verifies the validity of the remote host's IP address (that is, the domain) by performing a *double DNS lookup*. A double DNS lookup is defined as a reverse DNS (PTR) lookup on the IP address of the connecting host, followed by a forward DNS (A) lookup on the results of the PTR lookup. The email gateway then checks that the results of the A lookup match the results of the PTR lookup. If the PTR or A lookups fail, or the results do not match, the system uses only the IP address to match entries in the HAT and the sender is considered as not verified.

Unverified senders are classified into the following categories:

- Connecting host PTR record does not exist in the DNS.
- Connecting host PTR record lookup fails due to temporary DNS failure.

- Connecting host reverse DNS lookup (PTR) does not match the forward DNS lookup (A).

Using the sender group “Connecting Host DNS Verification” settings, you can specify a behavior for unverified senders (see [Throttling Messages from Unverified Senders Using the SUSPECTLIST Sender Group, on page 117](#)).

You can enable host DNS verification in the sender group settings for any sender group; however, keep in mind that adding host DNS verification settings to a sender group means *including* unverified senders in that group. That means that spam and other unwanted mail will be included. Therefore, you should only enable these settings on sender groups that are used to reject or throttle senders. Enabling host DNS verification on the ALLOWED\_LIST sender group, for example, would mean that mail from unverified senders would receive the same treatment as mail from your trusted senders in your ALLOWED\_LIST (including bypassing anti-spam/anti-virus checking, rate limiting, etc., depending on how the mail flow policy is configured).

## Sender Verification: Envelope Sender

With envelope sender verification, the domain portion of the envelope sender is DNS verified. (Does the envelope sender domain resolve? Is there an A or MX record in DNS for the envelope sender domain?) A domain does not resolve if an attempt to look it up in the DNS encounters a temporary error condition such as a timeout or DNS server failure. On the other hand, a domain does not exist if an attempt to look it up returns a definitive “domain does not exist” status. This verification takes place during the SMTP conversation whereas host DNS verification occurs before the conversation begins — it applies to the IP address of connecting SMTP server.

In more detail: AsyncOS performs an MX record query for the domain of the sender address. AsyncOS then performs an A record lookup based on the result of the MX record lookup. If the DNS server returns “NXDOMAIN” (there is no record for this domain), AsyncOS treats that domain as non-existent. This falls into the category of “Envelope Senders whose domain does not exist.” NXDOMAIN can mean that the root name servers are not providing any authoritative name servers for this domain.



---

**Note** Sender verification rejects a domain with no MX record if the DNS response is “NOERROR.”

---

However, if the DNS server returns “SERVFAIL,” it is categorized as “Envelope Senders whose domain does not resolve.” SERVFAIL means that the domain does exist but DNS is having transient problems looking up the record.

A common technique for spammers or other illegitimate senders of mail is to forge the MAIL FROM information (in the envelope sender) so that mail from unverified senders that is accepted will be processed. This can lead to problems as bounce messages sent to the MAIL FROM address are undeliverable. Using envelope sender verification, you can configure your email gateway to reject mail with malformed (but not blank) MAIL FROMs.

For each mail flow policy, you can:

- Enable envelope sender DNS verification.
- Offer custom SMTP code and response for malformed envelope sender. Malformed envelope senders are blocked if you have enabled envelope sender DNS verification.
- Offer custom response for envelope sender domains which do not resolve.
- Offer custom response for envelope sender domains which do not exist in DNS.

You can use the sender verification exception table to store [Sender Verification Exception Table, on page 115](#) a list of domains or addresses from which mail will be automatically allowed or rejected (see ). The sender

verification exception table can be enabled independently of Envelope Sender verification. So, for example, you can still reject special addresses or domains specified in the exception table without enabling envelope sender verification. You can also always allow mail from internal or test domains, even if they would not otherwise be verified.

Though most spam is from unverifiable senders, there are reasons why you might want to accept mail from an unverified sender. For example, not all legitimate email can be verified through DNS lookups — a temporary DNS server problem can stop a sender from being verified.

When mail from unverified senders is attempted, the sender verification exception table and mail flow policy envelope sender DNS verification settings are used to classify envelope senders during the SMTP conversation. For example, you may accept and throttle mail from sending domains that are not verified because they do not exist in DNS. Once that mail is accepted, messages with malformed MAIL FROMs are rejected with a customizable SMTP code and response. This occurs during the SMTP conversation.

You can enable envelope sender DNS verification (including the domain exception table) in the mail flow policy settings for any mail flow policy via the GUI or the CLI (`listenerconfig -> edit -> hostaccess -> < policy >`).

### Related Topics

- [Partial Domains, Default Domains, and Malformed MAIL FROMs, on page 115](#)
- [Custom SMTP Code and Response, on page 115](#)
- [Sender Verification: Envelope Sender, on page 114](#)

## Partial Domains, Default Domains, and Malformed MAIL FROMs

If you enable envelope sender verification or disable allowing partial domains in SMTP Address Parsing options for a listener (see the SMTP Address Parsing Options section in the “Configuring the Gateway to Receive Email” chapter), the default domain settings for that listener will no longer be used.

These features are mutually exclusive.

## Custom SMTP Code and Response

You can specify the SMTP code and response message for messages with malformed envelope senders, for envelope senders which do not exist in DNS, and for envelope senders which do not resolve via DNS queries (DNS server might be down, etc.).

In the SMTP response, you can include a variable, `EnvelopeSender`, which is expanded to the value of the envelope sender when the custom response is sent.

While typically a “Domain does not exist” result is permanent, it is possible for this to be a transient condition. To handle such cases, “conservative” users may wish to change the error code from the default 5XX to a 4XX code.

## Sender Verification Exception Table

The sender verification exception table is a list of domains or email addresses that will either be automatically allowed or rejected during the SMTP conversation. You can also specify an optional SMTP code and reject response for rejected domains. There is only one sender verification exception table per email gateway and it is enabled per mail flow policy.

The sender verification exception table can be used to list obviously fake but correctly formatted domains or email addresses from which you want to reject mail. For example, the correctly formatted MAIL FROM:

`pres@whitehouse.gov` could be listed in the sender verification exception table and set to be automatically rejected. You can also list domains that you want to automatically allow, such as internal or test domains. This is similar to envelope recipient (SMTP RCPT TO command) processing which occurs in the Recipient Access Table (RAT).

The sender verification exception table is defined in the GUI via the Mail Policies > Exception Table page (or the CLI, via the `exceptionconfig` command) and then is enabled on a per-policy basis via the GUI (see [Defining Messages to Send to Unverified Senders Using the ACCEPTED Mail Flow Policy, on page 118](#)) or the CLI (see the *CLI Reference Guide for AsyncOS for Cisco Secure Email Gateway*).

Entries in the sender verification exception table have the following syntax:

See [Excluding Unverified Senders from Sender Verification Rules Based on Sender's Email Address, on page 118](#) for more information about modifying the exception table.

## Implementing Sender Verification — Example Settings

This section provides an example of a typical conservative implementation of host and envelope sender verification.

For this example, when implementing host sender verification, mail from connecting hosts for which reverse DNS lookup does not match is throttled via the existing SUSPECTLIST sender group and THROTTLED mail flow policy.

A new sender group (UNVERIFIED) and a new mail flow policy (THROTTLEMORE) are created. Mail from connecting hosts which are not verified will be throttled (using the UNVERIFIED sender group and the more aggressive THROTTLEMORE mail flow policy) prior to the SMTP conversation.

Envelope sender verification is enabled for the ACCEPTED mail flow policy.

The following table shows the suggested settings for implementing sender verification:

**Table 19: Sender Verification: Suggested Settings**

Sender Group	Policy	Include
UNVERIFIED SUSPECTLIST	THROTTLEMORE THROTTLED	Prior to SMTP conversation: Connecting host PTR record does not exist in the DNS. Connecting host reverse DNS lookup (PTR) does not match the forward DNS lookup (A).
	ACCEPTED	Envelope Sender Verification during SMTP conversation: - Malformed MAIL FROM: - Envelope sender does not exist in DNS. - Envelope sender DNS does not resolve.

### Related Topics

- [Throttling Messages from Unverified Senders Using the SUSPECTLIST Sender Group, on page 117](#)
- [Implementing More Stringent Throttling Settings for Unverified Senders, on page 117](#)

- [Defining Messages to Send to Unverified Senders Using the ACCEPTED Mail Flow Policy](#), on page 118
- [Excluding Unverified Senders from Sender Verification Rules Based on Sender's Email Address](#), on page 118
- [Searching for Addresses within the Sender Verification Exception Table](#), on page 118

## Throttling Messages from Unverified Senders Using the SUSPECTLIST Sender Group

### Procedure

---

- Step 1** Select **Mail Policies > HAT Overview**.
- Step 2** Click **SUSPECTLIST** in the list of sender groups.
- Step 3** Click **Edit Settings**.
- Step 4** Select the **THROTTLED** policy from the list.
- Step 5** Check the “Connecting host reverse DNS lookup (PTR) does not match the forward DNS lookup (A)” checkbox under Connecting Host DNS Verification.
- Step 6** Submit and commit your changes.

Now, senders for which reverse DNS lookups fail will match the SUSPECTLIST sender group and will receive the default action from the THROTTLED mail flow policy.

---

## Implementing More Stringent Throttling Settings for Unverified Senders

### Procedure

---

- Step 1** Create a new mail flow policy (for this example, it is named THROTTLEMORE) and configure it with more stringent throttling settings.
- a) On the Mail Flow Policies page, click **Add Policy**
  - b) Enter a name for the mail flow policy, and select Accept as the Connection Behavior.
  - c) Configure the policy to throttle mail.
  - d) Submit and commit your changes.
- Step 2** Create a new sender group (for this example, it is named UNVERIFIED) and configure it to use the THROTTLEMORE policy:
- a) On the HAT Overview page, click **Add Sender Group**
  - b) Select the THROTTLEMORE policy from the list.
  - c) Check the “Connecting host PTR record does not exist in DNS” checkbox under Connecting Host DNS Verification.
  - d) Submit and commit your changes.
-

## Defining Messages to Send to Unverified Senders Using the ACCEPTED Mail Flow Policy

### Procedure

---

- Step 1** Select **Mail Policies > Mail Flow Policies**.
- Step 2** On the Mail Flow Policies page, click on the ACCEPTED mail flow policy.
- Step 3** Scroll down to the **Sender Verification** section.
- Step 4** In the **Envelope Sender DNS Verification** section, do the following:
- Select **On** to enable envelope sender DNS verification for this mail flow policy.
  - You may also define custom SMTP code and responses.
- Step 5** In the **Use Domain Exception Table** section, select **On** to enable the domain exception table.
- Step 6** Submit and commit your changes.
- 

## Excluding Unverified Senders from Sender Verification Rules Based on Sender's Email Address

### Procedure

---

- Step 1** Select **Mail Policies > Exception Table**.
- Note** The exception table applies globally to all mail flow policies with “Use Exception Table” enabled.
- Step 2** Click **Add Domain Exception** on the Mail Policies > Exception Table page.
- Step 3** Enter an email address. You can enter a specific address (pres@whitehouse.gov), a name (user@), a domain (@example.com or @.example.com), or an address with a bracketed IP address (user@[192.168.23.1]).
- Step 4** Specify whether to allow or reject messages from the address. When rejecting mail, you can also specify an SMTP code and custom response.
- Step 5** Submit and commit your changes.
- 

## Searching for Addresses within the Sender Verification Exception Table

### Procedure

---

- Step 1** Enter the email address in the Find Domain Exception section of the Exception Table page.
- Step 2** Click **Find**.
- If the address matches any of the entries in the table, the first matching entry is displayed.
-

## Testing Your Settings for Messages from Unverified Senders

Now that you have configured sender verification settings, you can verify the behavior of your email gateway.

Note that testing DNS-related settings is beyond the scope of this document.

### Related Topics

- [Sending a Test Message with a Malformed MAIL FROM Sender Address, on page 119](#)
- [Sending a Message from an Address That is Excluded from Sender Verification Rules, on page 119](#)

## Sending a Test Message with a Malformed MAIL FROM Sender Address

While it may be difficult to test the various DNS-related settings for your THROTTLED policy, you can test the malformed MAIL FROM setting.

### Procedure

---

**Step 1** Open a Telnet session to your email gateway.

**Step 2** Use SMTP commands to send a test message with a malformed MAIL FROM (something like “admin” without a domain).

**Note** If you have configured your email gateway to use a default domain or to specifically allow partial domains when sending or receiving email or if you have enabled address parsing (see the “Configuring the Gateway to Receive Email” chapter) you may not be able to create, send, and receive an email with a missing or malformed domain.

**Step 3** Verify that the message is rejected.

```
# telnet IP_address_of_Email_Security_Appliance port
220 hostname ESMTP
helo example.com
250 hostname
mail from: admin
553 #5.5.4 Domain required for sender address
```

Note that the SMTP code and response is the one you configured for the envelope sender verification settings for the THROTTLED mail flow policy.

---

## Sending a Message from an Address That is Excluded from Sender Verification Rules

To confirm that mail from the email address listed in the sender verification exception table is not subject to envelope sender verification:

### Procedure

---

**Step 1** Add the following address to the exception table with an “Allow” behavior: admin@zzzaazzz.com

**Step 2** Commit your changes.

**Step 3** Open a Telnet session to your email gateway.

**Step 4** Use SMTP commands to send a test message from the email address you entered in the sender verification exception table (admin@zzzaazzz.com).

**Step 5** Verify that the message is accepted.

```
# telnet IP_address_of_Email_Security_Appliance port
220 hostname ESMTP
helo example.com
250 hostname
mail from: admin@zzzaazzz.com
250 sender <admin@zzzaazzz.com> ok
```

If you remove that email address from the sender verification exception table, mail from that sender will be rejected because the domain portion of the envelope sender is not DNS verified.

## Sender Verification and Logging

The following log entries provide an example of Sender Verification verdicts.

### Related Topics

- [Envelope Sender Verification, on page 120](#)

## Envelope Sender Verification

Malformed Envelope Senders:

```
Thu Aug 10 10:14:10 2006 Info: ICID 3248 Address: <user> sender rejected, envelope sender
domain missing
```

Domain does not exist (NXDOMAIN):

```
Wed Aug 9 15:39:47 2006 Info: ICID 1424 Address: <user@domain.com> sender rejected, envelope
sender domain does not exist
```

Domain does not resolve (SERVFAIL):

```
Wed Aug 9 15:44:27 2006 Info: ICID 1425 Address: <user@domain.com> sender rejected, envelope
sender domain could not be resolved
```





## CHAPTER 8

# Accepting or Rejecting Connections Based on Domain Name or Recipient Address

---

This chapter contains the following sections:

- [Overview of Accepting or Rejecting Connections Based on the Recipient's Address, on page 121](#)
- [Overview of the Recipient Access Table \(RAT\), on page 122](#)
- [Accessing the RAT using the GUI, on page 122](#)
- [Accessing the RAT using the CLI, on page 122](#)
- [Editing the Default RAT Entry, on page 122](#)
- [Domains and Users, on page 123](#)

## Overview of Accepting or Rejecting Connections Based on the Recipient's Address

AsyncOS uses a Recipient Access Table (RAT) for each public listener to manage accept and reject actions for recipient addresses. Recipient addresses include these:

- Domains
- Email addresses
- Groups of email addresses

The System Setup Wizard guides the administrator in configuring at least one public listener (with default values) on the email gateway. Configuring a public listener during setup involves specifying default local domains or specific addresses to accept mail. These local domains or specific addresses are the first entries in the RAT for that public listener.

For each public listener, the default entry, “All Other Recipients”, rejects email from all recipients. The administrator defines all local domains for which the email gateway accepts messages. Optionally, you can also define specific users for whom the email gateway will accept or reject messages. AsyncOS allows you to define acceptable local domains and specific users using the Recipient Access Table (RAT).

You might need to configure a listener to accept messages for multiple domains. For example, if your organization uses the domain `currentcompanyname.com` and it previously used `oldcompanyname.com`, then you might accept messages for both `currentcompanyname.com` and `oldcompanyname.com`. In this case, include both local domains in the RAT for your public listener.

(Note: the Domain Map feature can map messages from one domain to another. See the Domain Map feature section of the “Configuring Routing and Delivery Features” chapter.)

## Overview of the Recipient Access Table (RAT)

The Recipient Access Table defines which recipients are accepted by a public listener. At a minimum, the table specifies the address and whether to accept or reject it.

The Recipient Access Table (RAT) page shows a listing of the entries in the RAT including the order, default action, and whether or not the entry has been configured to bypass LDAP accept queries.

## Accessing the RAT using the GUI

GUI

### Procedure

---

Navigate to **Mail Policies > Recipient Access Table (RAT)**.

---

## Accessing the RAT using the CLI

CLI

### Procedure

---

Use the `listenerconfig` command with the `edit > rcptaccess > new` subcommands.

---

## Editing the Default RAT Entry

### Before you begin

- Set up a public listener.
- Plan edits with caution, ensuring you do not create an *open relay* on the Internet. An open relay (sometimes called an “insecure relay” or a “third-party” relay) is an SMTP email server that allows third-party relay of email messages. By processing mail that is neither for — nor from — a local user, an open relay makes it possible for an unscrupulous sender to route large volumes of spam through your gateway. By default, the RAT *rejects* all recipients to prevent creation of an open relay.
- Note that you cannot delete the default entry from the RAT.

### Procedure

---

**Step 1** Navigate to **Mail Policies > Recipient Access Table (RAT)**.

**Step 2** Click **All Other Recipients**.

---

## Domains and Users

Modifying the Domains For Which to Accept Messages using the RAT

Use the Mail Policies > Recipient Access Table (RAT) page to configure the local domains and specific users for which the email gateway accepts messages. On this page, you can perform the following tasks:

- Add, delete, and modify entries in the RAT.
- Change the order of the entries.
- Export RAT entries to a text file.
- Import RAT entries from a text file. Importing from a text file overwrites the existing entries.

### Related Topics

- [Adding Domains and Users For Which to Accept Messages, on page 123](#)
- [Rearranging the Order of Domains and Users in the Recipient Access Table, on page 125](#)
- [Exporting the Recipient Access Table to an External File, on page 126](#)
- [Importing the Recipient Access Table from an External File, on page 126](#)

## Adding Domains and Users For Which to Accept Messages

### Procedure

---

- Step 1** Navigate to the **Mail Policies > Recipient Access Table (RAT)** page.
- Step 2** Choose the listener to edit in the Overview for Listener field.
- Step 3** Click **Add Recipient**.
- Step 4** Select an order for the entry.
- Step 5** Enter the recipient address.
- Step 6** Choose to accept or reject the recipient.
- Step 7** (Optional) Choose to bypass LDAP acceptance queries for the recipient.
- Step 8** (Optional) Use a custom SMTP response for this entry.
- a) Select Yes for Custom SMTP Response.
  - b) Enter an SMTP response code and text. Include the SMTP response to the RCPT TO command for the recipient.
- Step 9** (Optional) Choose to bypass throttling by selecting Yes for Bypass Receiving Control.
- Step 10** Submit and commit your changes.
- 

### What to do next

### Related Topics

- [Defining Recipient Addresses, on page 124](#)

- [Bypassing LDAP Accept for Special Recipients, on page 124](#)
- [Bypassing Throttling for Special Recipients, on page 125](#)

## Defining Recipient Addresses

The RAT allows you to define a recipient or group of recipients. Recipients can be defined by full email address, domain, partial domain, username, or IP address:

[IPv4 address]	Specific Internet Protocol version 4 (IPv4) address of the host. Note that the IP address must be between the “ [] ” characters.
[IPv6 address]	Specific Internet Protocol version 6 (IPv6) address of the host. Note that the IP address must be between the “ [] ” characters.
division.example.com	Fully-qualified domain name.
.partialhost	Everything within the “partialhost” domain.
user@domain	Complete email address.
user@	Anything with the given username.
<b>user@[IP_address ]</b>	Username at a specific IPv4 or IPv6 address. Note that the IP address must be between the “ [] ” characters.  Note that “ user@IP_address ” (without the bracket characters) is not a valid address. The system will append the brackets when it receives the message to create a valid address, which could affect whether a recipient is matched in the RAT.



**Note** When you add a domain to the Recipient Access Table in step 4 of the System Setup Wizard in the GUI (see [Step 3: Network, on page 31](#)), you might want to consider adding a second entry to specify subdomains. For example, if you type the domain `example.net`, you might also want to enter `.example.net`. The second entry ensures that mail destined for any subdomain of `example.net` will match in the Recipient Access Table. Note that *only* specifying `.example.com` in the RAT will accept for all subdomains of `.example.com` but *will not* accept mail for complete email address recipients *without* a subdomain (for example `joe@example.com`).

## Bypassing LDAP Accept for Special Recipients

If you configure LDAP acceptance queries, you may wish to bypass the acceptance query for certain recipients. This feature can be useful if there are recipients for whom you receive email which you do not want to be delayed or queued during LDAP queries, such as `customer@example.com`.

If you configure the recipient address to be rewritten in the work queue prior to the LDAP acceptance query, (such as aliasing or using a domain map), the rewritten address will not bypass LDAP acceptance queries. For example you use an alias table to map `customer@example.com` to `bob@example.com` and `sue@example.com`. If you configure bypassing LDAP acceptance for `customer@example.com`, an LDAP acceptance query is still run for `bob@example.com` and `sue@example.com` after the aliasing takes place.

To configure bypassing LDAP acceptance via the GUI, select **Bypass LDAP Accept Queries for this Recipient** when you add or edit the RAT entry.

To configure bypassing LDAP acceptance queries via the CLI, answer yes to the following question when you enter recipients using the `listenerconfig -> edit -> rcptaccess` command:

```
Would you like to bypass LDAP ACCEPT for this entry? [Y]> y
```

When you configure a RAT entry to bypass LDAP acceptance, be aware that the order of RAT entries affects how recipient addresses are matched. The RAT matches the recipient address with the first RAT entry that qualifies. For example, you have the following RAT entries: `postmaster@ironport.com` and `ironport.com`. You configure the entry for `postmaster@ironport.com` to bypass LDAP acceptance queries, and you configure the entry for `ironport.com` for ACCEPT. When you receive mail for `postmaster@ironport.com`, the LDAP acceptance bypass will occur only if the entry for `postmaster@ironport.com` is before the entry for `ironport.com`. If the entry for `ironport.com` is before the `postmaster@ironport.com` entry, the RAT matches the recipient address to this entry and applies the ACCEPT action.

## Bypassing Throttling for Special Recipients

For recipient entries, you can specify that the recipient bypasses throttling control mechanisms enabled on the listener.

This feature is useful if there are certain recipients for whom you do not want to limit messages. For example, many users will want to receive email for the address “`postmaster@domain`” on a listener, even if the sending domain is being throttled based on the receiving control defined in mail flow policies. Specifying this recipient to bypass receiving control in a listener’s RAT allows the listener to receive unlimited messages for the recipient “`postmaster@domain`” while retaining mail flow policies for other recipients in the same domain. Recipients will avoid being counted against the recipients-per-hour counter maintained by the system if the sending domain is being limited.

To specify certain recipients to bypass receiving control via the GUI, select Yes for the “Bypass Receiving Control” setting when adding or editing a RAT entry:

To specify certain recipients to bypass receiving control via the CLI, answer yes to the following question when you enter recipients using the `listenerconfig > edit > rcptaccess` command:

```
Would you like to bypass receiving control for this entry? [N]> y
```

## Rearranging the Order of Domains and Users in the Recipient Access Table

### Procedure

- 
- Step 1** Navigate to the **Mail Policies > Recipient Access Table (RAT)** page.
  - Step 2** Choose the listener to edit in the **Overview for Listener** field.
  - Step 3** Click **Edit Order**.
  - Step 4** Change the order by arranging the values in the **Order** column.
  - Step 5** Submit and commit your changes.
-

## Exporting the Recipient Access Table to an External File

### Procedure

---

- Step 1** Navigate to the **Mail Policies > Recipient Access Table (RAT)** page.
  - Step 2** Choose the listener to edit in the **Overview for Listener** field.
  - Step 3** Click **Export RAT**.
  - Step 4** Enter a file name for the exported entries.  
This is the name of the file that will be created in the configuration directory on the email gateway.
  - Step 5** Submit and commit your changes.
- 

## Importing the Recipient Access Table from an External File

When you import Recipient Access Table entries from a text file, all of the existing entries are removed from the Recipient Access Table.

### Procedure

---

- Step 1** Navigate to the **Mail Policies > Recipient Access Table (RAT)** page.
- Step 2** Choose the listener to edit in the **Overview for Listener** field.
- Step 3** Click **Import RAT**.
- Step 4** Select a file from the list.  
AsyncOS lists all text files in the configuration directory on the email gateway.
- Step 5** Click **Submit**.  
A warning message displays asking you to confirm that you want to remove all of the existing Recipient Access Table entries.
- Step 6** Click **Import**.
- Step 7** Commit your changes.  
You can place “comments” in the file. Lines that begin with a ‘#’ character are considered comments and are ignored by AsyncOS. For example:

#### Example:

```
# File exported by the GUI at 20060530T220526
.example.com ACCEPT
ALL REJECT
```

---



## CHAPTER 9

# Using Message Filters to Enforce Email Policies

The email gateway contains extensive content scanning and message filtering technology that allows you to enforce corporate policies and act on specific messages as they enter or leave your corporate networks.

This chapter contains information about the powerful combinations of features available for policy enforcement: a content scanning engine, message filters, attachment filters, and content dictionaries.

This chapter contains the following sections:

- [Overview, on page 127](#)
- [Components of a Message Filter, on page 128](#)
- [Message Filter Processing, on page 130](#)
- [Message Filter Rules, on page 135](#)
- [Message Filter Actions, on page 183](#)
- [Attachment Scanning, on page 214](#)
- [Detecting Malicious Files in Messages Attachments Using Message Filter , on page 224](#)
- [Using the CLI to Manage Message Filters, on page 225](#)
- [Message Filter Examples, on page 240](#)
- [Configuring Scan Behavior, on page 247](#)

## Overview

Message filters allow you to create special rules describing how to handle messages as they are received by the email gateway. A message filter specifies that a certain kind of email message should be given special treatment. Cisco message filters also allow you to enforce corporate email policy by scanning the content of messages for words you specify. This chapter contains the following sections:

- **Components of a message filter.** Message filters allow you to create special rules describing how to handle messages as they are received. Filter rules identify messages based on message or attachment content, information about the network, message envelope, message headers, or message body. Filter actions generate notifications or allow messages to be dropped, bounced, archived, blind carbon copied, or altered. For more information, see [Components of a Message Filter, on page 128](#).
- **Processing Message Filters.** When AsyncOS processes message filters, the content that AsyncOS scans, the order of the processing, and the actions taken are based on several factors, including the message filter order, any prior processing that may have altered the message content, the MIME structure of the message, the threshold score configured for content matching, and structure of the query. For more information, see [Message Filter Processing, on page 130](#).

- **Message Filter Rules.** Each filter has a rule that defines the collection of messages that the filter can act upon. You define those rules when you create a message filter. For more information, see [Message Filter Rules, on page 128](#).
- **Message Filter Actions.** Each filter has an action that is performed on a message if the rule evaluates to true. There are two types of actions that can be performed: final actions (such as delivering, dropping, or bouncing a message), or non-final actions (such as stripping or inserting a header) which permit the message to be further processed. For more information, see [Message Filter Actions, on page 128](#).
- **Attachment Scanning Message Filters.** Attachment scanning message filters allow you to strip attachments from messages that are inconsistent with your corporate policies, while still retaining the ability to deliver the original message. You can filter attachments based on their specific file type, fingerprint, or content. You can also scan image attachments using an image analyzer. The image analyzer uses algorithms that measure image attributes to determine the likelihood of inappropriate content. These algorithms can detect, for example, the shapes and color palette in an image. The analyzer can identify the type of shapes in an image and the percentage of any flesh-tone colors relative to the other colors in the image to help identify inappropriate content. Images with a high percentage of flesh-tone colors are more likely to be inappropriate. The algorithms do not discriminate in any way. For more information, see [Attachment Scanning, on page 214](#).
- **Using the CLI to Manage Message Filters.** The CLI accepts commands for working with message filters. For example, you might want to display, reorder, import or export a list of message filters. For more information, see [Using the CLI to Manage Message Filters, on page 225](#).
- **Message Filter Examples.** This section contains some real world examples of filters with a brief discussion of each. For more information, see [Message Filter Examples, on page 240](#).

## Components of a Message Filter

Message filters allow you to create special rules describing how to handle messages as they are received. A message filter is comprised of message filter rules and message filter actions.

### Related Topics

- [Message Filter Rules, on page 128](#)
- [Message Filter Actions, on page 128](#)
- [Message Filter Example Syntax, on page 129](#)

## Message Filter Rules

Message filter rules determine the messages that a filter will act on. Rules may be combined using the logical connectors AND, OR, and NOT to create more complex tests. Rule expressions may also be grouped using parentheses.

## Message Filter Actions

The purpose of message filters is to perform actions on selected messages.

The two types of actions are:

- *Final* actions — such as deliver, drop, and bounce — end the processing of a message, and permit no further processing through subsequent filters.
- *Non-final* actions perform an action which permits the message to be processed further.





**Note** Non-final message filter actions are cumulative. If a message matches multiple filters where each filter specifies a different action, then all actions are accumulated and enforced. However, if a message matches multiple filters specifying the same action, the prior actions are overridden and the final filter action is enforced.

### Related Topics

- [Filter Actions Summary Table, on page 183](#)
- [Action Variables, on page 192](#)
- [Matched Content Visibility, on page 194](#)
- [Description and Examples of Message Filter Actions, on page 195](#)

## Message Filter Example Syntax

The intuitive meaning of a filter specification is:

*if* the message matches the rule, *then* apply the actions in sequence. If the else clause is present, the actions within the else clause are executed in the event the message does not match the rule.

The name of the filter you specify makes it easier to manage filters when you are activating, deactivating, or deleting them.

Message filters use the following syntax:

Example Syntax	Purpose
expedite:	filter name
if (recv-listener == 'InboundMail' or recv-int == 'notmain')	rule specification
<pre>{   alt-src-host('outbound1');   skip-filters(); }</pre>	action specification
<pre>else {   alt-src-host('outbound2'); }</pre>	optional alternative action specification

Note that you can omit any alternative actions:

Example Syntax	Purpose
expedite2:	filter name
<pre>if ((not (recv-listener == 'InboundMail')) and (not (recv-int == 'notmain')))</pre>	rule specification

Example Syntax	Purpose
<pre>{   alt-src-host('outbound2');   skip-filters(); }</pre>	action specification

You can combine several filters in sequence within a single text file, one following the other.

You must enclose the values in filters in either single or double quotation marks. Single or double quotation marks must be equally paired on each side of the value; for example, the expressions `notify('customercare@example.com')` and `notify("customercare@example.com")` are both legal, but the expression `notify("customercare@example.com')` causes a syntax error.

Lines beginning with a ‘#’ character are considered comments and are ignored; however, they are not preserved by AsyncOS as can be verified by viewing a filter via `filters -> detail`.

## Message Filter Processing

When AsyncOS processes message filters, the content that AsyncOS scans, the order of the processing, and the actions taken are based on several factors:

- **Message filter order.** Message filters are maintained in an ordered list. When a message is processed, AsyncOS applies each message filter in the order it appears in the list. If a final action occurs, no further action is taken on the message. For more information, see [Message Filter Order, on page 131](#).
- **Prior processing.** Actions performed on AsyncOS messages may add or remove headers before the message filter is evaluated. AsyncOS processes the message filter process on the headers that are present in the message at the time of processing. For more information, see [Message Header Rules and Evaluation, on page 131](#).
- **The MIME structure of the message.** The MIME structure of the message determines which part of the message is treated as “body,” and which part of the message is treated as an “attachment”. Many message filters are configured to act on just the body or just the attachment part of the message. For more information, see [Message Bodies vs. Message Attachments, on page 131](#).
- **The threshold score configured for the regular expression.** When you match a regular expression, you configure a “score” to tally up the number of times a match must occur before a filter action is taken. This allows you to “weight” the responses to different terms. For more information, see [Thresholds for Matches in Content Scanning, on page 132](#).
- **The structure of the query.** When evaluating AND or OR tests within message filters, AsyncOS does not evaluate unneeded tests. In addition, it is important to note that the system does not evaluate the tests from left to right. Instead, when AND and OR tests are evaluated, the least expensive test is evaluated first. For more information, see [AND Test and OR Tests in Message Filters, on page 135](#).

### Related Topics

- [Message Filter Order, on page 131](#)
- [Message Header Rules and Evaluation, on page 131](#)
- [Message Bodies vs. Message Attachments, on page 131](#)
- [Thresholds for Matches in Content Scanning, on page 132](#)
- [AND Test and OR Tests in Message Filters, on page 135](#)

## Message Filter Order

Message filters are kept in an ordered list and numbered by their position in the list. When a message is processed, the message filters are applied in the associated numeric order. Therefore, filter number 30 will not have a chance to alter the source host of a message if filter number 9 has already executed a final action on (for example, bounced) the message. The position of a filter in the list can be changed via the system user interfaces. Filters imported via a file are ordered based on their relative order in the imported file.

After a final action, no further actions may be taken on the message.

Although a message may match a filter rule, the filter may not act upon that message for any of the following reasons:

- The filter is inactive.
- The filter is invalid.
- The filter has been superseded by an earlier filter that executed a final action for the message.

## Message Header Rules and Evaluation

Filters evaluate “processed” headers rather than the original message headers when applying header rules. Thus:

- If a header was added by a previous processing action, it can now be matched by any subsequent header rule.
- If a header was stripped by a previous processing action, it can no longer be matched by any subsequent header rule.
- If a header was modified by a previous processing action, any subsequent header rule will evaluate the modified header and not the original message header.

This behavior is common to both message filters and content filters.

## Message Bodies vs. Message Attachments

An email message is composed of multiple parts. Although RFCs define everything that comes after a message’s headers as a multipart “message body,” many users still conceptualize a message’s “body” and its “attachment” differently. When you use any of the Cisco message filters named *body-variable* or *attachment-variable*, the email gateway attempts to distinguish the parts that most users consider to be the “body” and the “attachment” in the same way that many MUAs attempt to render these parts differently.

For the purposes of writing *body-variable* or *attachment-variable* message filter rules, everything after the message headers is considered the message *body*, whose content is considered the first text part of the MIME parts that are within the body. Anything after the content, (that is, any additional MIME parts) is considered an *attachment*. AsyncOS evaluates the different MIME parts of the message, and identifies the parts of the file that is treated as an attachment.

For example, The following figure shows a message in the Microsoft Outlook MUA where the words “Document attached below.” appear as a plain text message *body* and the document “This is a Microsoft Word document.doc” appears as an *attachment*. Because many users conceptualize email this way (rather than as a multipart message whose first part is plain text and whose second part is a binary file), the Cisco uses the term “attachment” in message filters to create rules to differentiate and act on the .doc file part (in essence, the second MIME part) as opposed to the “body” of the message (the first, plain text part) — although, according to the language used in RFCs 1521 and 1522, a message’s *body* is comprised of all MIME parts.

Figure 16: Message with "Attachment"

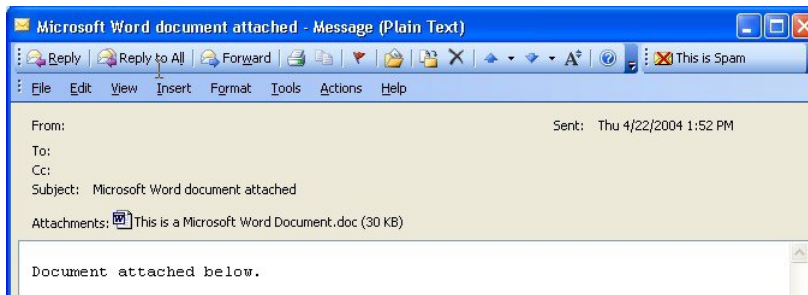

Because the email gateway makes this distinction between the *body* and the *attachment* in multipart messages, there are several cases you should be aware of when using the *body - variable* or *attachment-variable* message filter rules in order to achieve the expected behavior:

- If you have a message with a single text part—that is, a message containing a header of “Content-Type: text/plain” or “Content-Type: text/html” — the email gateway will consider the entire message as the body. If the content type is anything different, the email gateway considers it to be a single attachment.
- Some encoded files (uuencoded, for example) are included in the body of the email message. When this occurs, the encoded file is treated as an attachment, and it is extracted and scanned, while the remaining text is considered to be the body of the text.
- A single, non-text part is always considered an *attachment*. For example, a message consisting of only a.zip file is considered an attachment.

## Thresholds for Matches in Content Scanning

When you add filter rules that search for patterns in the message body or attachments, you can specify the minimum threshold for the number of times the pattern must be found. When AsyncOS scans the message, it totals the “score” for the number of matches it finds in the message and attachments. If the minimum threshold is not met, the regular expression does not evaluate to true. You can specify this threshold for the following filter rules:

- body-contains
- only-body-contains
- attachment-contains
- every-attachment-contains
- dictionary-match
- attachment-dictionary-match

You can also specify a threshold value for the `drop-attachments-where-contains` action.



---

**Note** You cannot specify thresholds for filter rules that scan headers or envelope recipients and senders.

---

### Related Topics

- [Threshold Syntax, on page 133](#)
- [Threshold Scoring for Message Bodies and Attachments, on page 133](#)
- [Threshold Scoring Multipart/Alternative MIME Parts, on page 133](#)

- [Threshold Scoring for Content Dictionaries, on page 134](#)

## Threshold Syntax

To specify a threshold for the minimum number of occurrences, specify the pattern and the minimum number of matches required to evaluate to true:

```
if(<filter rule>(<pattern>',<minimum threshold>)){
```

For example, to specify that the `body-contains` filter rule must find the value “Company Confidential” at least two times, use the following syntax:

```
if(body-contains('Company Confidential',2)){
```

By default, when AsyncOS saves a content scanning filter, it compiles the filter and assigns a threshold value of 1, if you have not assigned a value.

You can also specify a minimum number of pattern matches for values in a content dictionary. For more information about content dictionaries, see the “Text Resources” chapter.

## Threshold Scoring for Message Bodies and Attachments

An email message may be composed of multiple parts. When you specify threshold values for filter rules that search for patterns in the message body or attachments, AsyncOS counts the number of matches in the message parts and attachments to determine the threshold “score.” Unless the message filter specifies a specific MIME part (such as the `attachment-contains` filter rule), AsyncOS will total the matches found in all parts of the message to determine if the matches total the threshold value. For example, you have a `body-contains` message filter with a threshold of 2. You receive a message in which the body contains one match, and the attachment contains one match. When AsyncOS scores this message, it totals the two matches and determines that the threshold score has been met.

Similarly, if you have multiple attachments, AsyncOS totals the scores for each attachment to determine the score for matches. For example, you have an `attachment-contains` filter rule with a threshold of 3. You receive a message with two attachments, and each attachment contains two matches. AsyncOS would score this message with four matches and determine that the threshold score has been met.

## Threshold Scoring Multipart/Alternative MIME Parts

To avoid duplicate counting, if there are two representatives of the same content (plain text and HTML), AsyncOS does not total the matches from the duplicate parts. Instead, it compares the matches in each part and selects the highest value. AsyncOS would then add this value to the scores from other parts of the multipart message to create a total score.

For example, you configure a `body-contains` filter rule and set the threshold to 4. You then receive a message that contains both plain text, HTML and two attachments. The message would use the following structure:

```
multipart/mixed

    multipart/alternative

        text/plain

        text/html
```

```
application/octet-stream
```

```
application/octet-stream
```

The `body-contains` filter rule would determine the score for this message by first scoring the `text/plain` and `text/html` parts of the message. It would then compare the results of these scores and select the highest score from the results. Next, it would add this result to the score from each of the attachments to determine the final score. Suppose the message has the following number of matches:

```
multipart/mixed
```

```
multipart/alternative
```

```
text/plain (2 matches)
```

```
text/html (2 matches)
```

```
application/octet-stream (1 match)
```

```
application/octet-stream
```

Because AsyncOS compares the matches for the `text/plain` and `text/html` parts, it returns a score of 3, which does not meet the minimum threshold to trigger the filter rule.

## Threshold Scoring for Content Dictionaries

When you use a content dictionary, you can “weight” terms so that certain terms trigger filter actions more easily. For example, you may want not want to trigger a message filter for the term, “bank.” However, if the term, “bank” is combined with the term, “account,” and accompanied with an ABA routing number, you may want to trigger a filter action. To accomplish this, you can use a weighted dictionary to give increased importance to certain terms or a combination of terms. When a message filter that uses a content dictionary scores the matches for filter rule, it uses these weights to determine the final score. For example, suppose you create a content dictionary with the following contents and weights:

**Table 20: Sample Content Dictionary**

Term/Smart Identifier	Weight
ABA Routing Number	3
Account	2
Bank	1

When you associate this content dictionary with a `dictionary-match` or `attachment-dictionary-match` message filter rule, AsyncOS would add the weight for the term to the total “score” for each instance of the matching term found in the message. For example, if the message contains three instances of the term, “account” in the message body, AsyncOS would add a value of 6 to the total score. If you set the threshold value for the message filter to 6, AsyncOS would determine that the threshold score has been met. Or, if the message contained one instance of each term, the total value would be 6, and this score would trigger the filter action.

## AND Test and OR Tests in Message Filters

When evaluating AND or OR tests within message filters, AsyncOS does not evaluate unneeded tests. So, for example, if one side of an AND test is false, the system will not evaluate the other side. It is important to note that the system does not evaluate the tests from left to right. Instead, when AND and OR tests are evaluated, the least expensive test is evaluated first. For example, in the following filter, the `remote-ip` test will always be processed first because it has a lower cost than the `rcpt-to-group` test (generally LDAP tests are more expensive):

```
andTestFilter:

if (remote-ip == "192.168.100.100" AND rcpt-to-group == "GROUP")

    { ... }
```

Because the least expensive test is performed first, switching the order of the items in the test will have no effect. If you want to guarantee the order in which tests are performed, use nested if statements. This is also the best way to ensure that an expensive test is avoided whenever possible:

```
expensiveAvoid:

if (<simple tests>)

    { if (<expensive test>)

        { <action> }

    }
```

In a somewhat more complicated example, consider:

```
if (test1 AND test2 AND test3) { ... }
```

The system groups the expression from left to right, so this becomes:

```
if ((test1 AND test2) AND test3) { ... }
```

This means the first thing the system does is compare the cost of `(test1 AND test2)` against the cost of `test3`, evaluating the second AND first. If all three tests have the same cost, then `test3` will be performed first because `(test1 AND test2)` would be twice as expensive.

## Message Filter Rules

Each message filter contains a rule that defines the collection of messages that a filter can act upon. You define the filter rules, and then you define a filter action for messages that return true .

### Related Topics

- [Filter Rules Summary Table, on page 136](#)
- [Regular Expressions in Rules, on page 146](#)
- [Smart Identifiers, on page 150](#)

- [Description and Examples of Message Filter Actions, on page 195](#)

## Filter Rules Summary Table

The following table summarizes the rules you can use in message filters.

**Table 21: Message Filter Rules**

Rule	Syntax	Description
Subject Header	subject	Does the subject header match a certain pattern? See <a href="#">Subject Rule, on page 154</a> .
Body Size	body-size	Is the body size within some range? See <a href="#">Body Size Rule, on page 156</a> .
Envelope Sender	mail-from	Does the Envelope Sender (i.e., the Envelope From, <MAIL FROM>) match a given pattern? See <a href="#">Envelope Sender Rule, on page 155</a> .
Envelope Sender in Group	mail-from-group	Is the Envelope Sender (i.e., the Envelope From, <MAIL FROM>) in a given LDAP group? See <a href="#">Envelope Sender in Group Rule, on page 156</a> .
Sender Group	sendergroup	Which sender group was matched in a listener's Host Access Table (HAT)? See <a href="#">Sender Group Rule, on page 156</a> .
Envelope Recipient	rcpt-to	Does the Envelope Recipient, (i.e. the Envelope To, <RCPT TO>) match a given pattern? See <a href="#">Envelope Recipient Rule, on page 155</a> .  <b>Note</b> The <code>rcpt-to</code> rule is message-based. If a message has multiple recipients, only one recipient has to match the rule for the specified action to affect the message to all recipients.



Rule	Syntax	Description
Envelope Recipient in Group	<code>rcpt-to-group</code>	Is the Envelope Recipient, (i.e. the Envelope To, <RCPT TO>) in a given LDAP group? See <a href="#">Envelope Recipient in Group Rule, on page 155</a> .  <b>Note</b> The <code>rcpt-to-group</code> rule is message-based. If a message has multiple recipients, only one recipient has to be found in a group for The <code>rcpt</code> the specified action to affect the message to all recipients.
Remote IP	<code>remote-ip</code>	Was the message sent from a remote host that matches a given IP address or IP block? See <a href="#">Remote IP Rule, on page 157</a> .
Receiving Interface	<code>rcv-int</code>	Did the message arrive via the named receiving interface? See <a href="#">.Receiving IP Interface Rule, on page 158</a>
Receiving Listener	<code>rcv-listener</code>	Did the message arrive via the named listener? See <a href="#">Receiving Listener Rule, on page 158</a> .
Date	<code>date</code>	Is current time before or after a specific time and date? See <a href="#">Date Rule, on page 158</a> .
Header	<code>header(&lt;string&gt;)</code>	Does the message contain a specific header? Does the value of that header match a certain pattern? See <a href="#">Header Rule, on page 159</a> .
Random	<code>random(&lt;integer&gt;)</code>	Is a random number in some range? See <a href="#">Random Rule, on page 159</a> .
Recipient Count	<code>rcpt-count</code>	How many recipients is this email going to? See <a href="#">Recipient Count Rule, on page 160</a> .

## Filter Rules Summary Table

Rule	Syntax	Description
Address Count	<code>addr-count ()</code>	What is the cumulative number of recipients?  This filter differs from the <code>rcpt-count</code> filter rule in that it operates on the message body headers instead of the envelope recipients. See <a href="#">Address Count Rule, on page 160</a> .
SPF Status	<code>spf-status</code>	What was the SPF verification status? This filter rule allows you to query for different SPF verification results. You can enter a different action for each valid SPF/SIDF return value. See <a href="#">SPF-Status Rule, on page 166</a> .
SPF Passed	<code>spf-passed</code>	Did the SPF/SIDF verification pass? This filter rule generalizes the SPF/SIDF results as a Boolean value. See <a href="#">SPF-Passed Rule, on page 168</a> .
S/MIME Gateway Message	<code>smime-gateway</code>	Is the message S/MIME signed, encrypted, or signed and encrypted? See <a href="#">S/MIME Gateway Message Rule, on page 168</a>
S/MIME Gateway Verified	<code>smime-gateway-verified</code>	Is the S/MIME message successfully verified, decrypted, or decrypted and verified? See <a href="#">S/MIME Gateway Verified Rule, on page 168</a> .
Image verdict	<code>image-verdict</code>	What was the image scanning verdict? This filter rule allows you to query for different image analysis verdicts. See <a href="#">Image Analysis, on page 217</a> .
Workqueue count	<code>workqueue-count</code>	Is the work queue count equal to, less than, or greater than the specified value? See <a href="#">Workqueue-count Rule, on page 168</a> .

Rule	Syntax	Description
Body Scanning	<code>body-contains( &lt;regular expression&gt;)</code>	Does the message contain text or an attachment that matches a specified pattern? Does the pattern occur the minimum number of times you specified for the threshold value?  The engine scans delivery-status parts and associated attachments. See <a href="#">Body Scanning</a> , on page 161.
Body Scanning	<code>only-body-contains (&lt;regular expression&gt;)</code>	Does the message body contain text that matches a specified pattern? Does the pattern occur the minimum number of times you specified for the threshold value? Attachments are not scanned. See <a href="#">Body Scanning Rule</a> , on page 160.
Encryption Detection	<code>encrypted</code>	Is the message encrypted? See <a href="#">Encryption Detection Rule</a> , on page 161.
Attachment Filename	<code>attachment-filename</code>	Does the message contain an attachment with a filename that matches a specific pattern? See <a href="#">Attachment Filename Rule</a> , on page 162.
Attachment Type	<code>attachment-type</code>	Does the message contain an attachment of a particular MIME type? See <a href="#">Attachment Type Rule</a> , on page 162.

Rule	Syntax	Description
Attachment File Type	<code>attachment-filetype</code>	<p>Does the message contain an attachment of a file type that matches a specific pattern based on its fingerprint (similar to a UNIX <code>file</code> command)? If the attachment is an Excel or Word document, you can also search for the following embedded file types: <code>.exe</code>, <code>.dll</code>, <code>.bmp</code>, <code>.tiff</code>, <code>.pcx</code>, <code>.gif</code>, <code>.jpeg</code>, <code>png</code>, and Photoshop images.</p> <p>You must enclose the file type in quotes to create a valid filter. You can use single or double quotes. For example, to search for <code>.exe</code> attachments, use the following syntax:</p> <pre>if (attachment-filetype == "exe")</pre> <p>For more information, see <a href="#">Attachment Filenames and Single Compressed Files within Archive Files</a>, on page 163.</p>
Attachment MIME Type	<code>attachment-mimetype</code>	<p>Does the message contain an attachment of a specific MIME type? This rule is similar to the <code>attachment-type</code> rule, except only the MIME type given by the MIME attachment is evaluated. (The email gateway does not try to “guess” the type of the file by its extension if there is no explicit type given.) See <a href="#">Examples of Attachment Scanning Message Filters</a>, on page 221.</p>
Attachment File Hash List	<code>attachment-hashlist-match</code>	<p>Does the message contain an attachment that matches the specific file SHA-256 value in the file hash list? See <a href="#">Drop Message Attachments that match File SHA-256 Filter</a>, on page 247 and <a href="#">Drop Messages if Attachment matches File SHA-256 Filter</a>, on page 247.</p>

Rule	Syntax	Description
Attachment Protected	<code>attachment-protected</code>	Does the message contain an attachment that is password protected? See <a href="#">Quarantining Protected Attachments, on page 224</a> .
Attachment Unprotected	<code>attachment-unprotected</code>	<p>The attachment-unprotected filter condition returns true if the scanning engine detects an attachment that is unprotected. A file is considered unprotected if the scanning engine was able to read the attachment. A zip file is considered to be unprotected if any of its members is unprotected.</p> <p><b>Note</b> — The attachment-unprotected filter condition is not mutually exclusive of the attachment-protected filter condition. It is possible for both filter conditions to return true when scanning the same attachment. This can occur, for example, if a zip file contains both protected and unprotected members.</p> <p>See <a href="#">Detecting Unprotected Attachments, on page 224</a>.</p>
Attachment Scanning	<code>attachment-contains</code> ( <i>&lt;regular expression&gt;</i> )	<p>Does the message contain an attachment that contains text or another attachment that matches a specific pattern? Does the pattern occur the minimum number of times you specified for the threshold value?</p> <p>This rule is similar to the <code>body-contains()</code> rule, but it attempts to avoid scanning the entire “body” of the message. That is, it attempts to scan only that which the user would view as being an attachment. See <a href="#">Examples of Attachment Scanning Message Filters, on page 221</a>.</p>

Rule	Syntax	Description
Attachment Scanning	<code>attachment-binary-contains</code> ( <i>&lt;regular expression&gt;</i> )	Does the message contain an attachment with binary data that matches a specific pattern?  This rule is like the <code>attachment-contains ()</code> rule, but it searches specifically for patterns in the binary data.
Attachment Scanning	<code>every-attachment-contains</code> ( <i>&lt;regular expression&gt;</i> )	Do all of the attachments in this message contain text that matches a specific pattern? The text must exist in all attachments and the action performed is, in effect, a logical AND operation of an ' <code>attachment-contains ()</code> ' for each attachment. The body is not scanned. Does the pattern occur the minimum number of times you specified for the threshold value?  See <a href="#">Examples of Attachment Scanning Message Filters</a> , on page 221.
Attachment Size	<code>attachment-size</code>	Does the message contain an attachment whose size is within some range? This rule is similar to the <code>body-size</code> rule, but it attempts to avoid scanning the entire “body” of the message. That is, it attempts to scan only that which the user would view as being an attachment. The size is evaluated prior to any decoding. See <a href="#">Examples of Attachment Scanning Message Filters</a> , on page 221.
Public Blocked lists	<code>dnslist(&lt;query server&gt;)</code>	Does the sender’s IP address appear on a public blocked list server (RBL)? See <a href="#">DNS List Rule</a> , on page 163.
IP Reputation	<code>reputation</code>	What is the sender’s IP Reputation Score? See <a href="#">IP Reputation Rule</a> , on page 164.
No IP Reputation	<code>no-reputation</code>	Used to test if IP Reputation Score is “None.” See <a href="#">IP Reputation Rule</a> , on page 164.

Rule	Syntax	Description
Dictionary	<code>dictionary-match (&lt;dictionary_name&gt;)</code>	Does the message body contain any of the regular expressions or terms in the content dictionary named <i>dictionary_name</i> ? Does the pattern occur the minimum number of times you specified for the threshold value? See <a href="#">Dictionary Rules, on page 165</a> .
Attachment Dictionary Match	<code>attachment-dictionary-match (&lt;dictionary_name&gt;)</code>	Does the attachment contain any of the regular expressions in the content dictionary named <i>dictionary_name</i> ? Does the pattern occur the minimum number of times you specified for the threshold value? See <a href="#">Dictionary Rules, on page 165</a> .
Subject Dictionary Match	<code>subject-dictionary-match (&lt;dictionary_name&gt;)</code>	Does the Subject header contain any of the regular expressions or terms in the content dictionary named <i>dictionary name</i> ? See <a href="#">Dictionary Rules, on page 165</a> .
Header Dictionary Match	<code>header-dictionary-match (&lt;dictionary_name&gt;, &lt;header&gt;)</code>	Does the specified header (case insensitive) contain any of the regular expressions or terms in the content dictionary named <i>dictionary name</i> ? See <a href="#">Dictionary Rules, on page 165</a> .
Body Dictionary Match	<code>body-dictionary-match (&lt;dictionary_name&gt;)</code>	This filter condition returns true if the dictionary term matches content in the body of the message only. The filter searches for terms within the MIME parts not considered to be an attachment. and it returns true if the user-defined threshold is met (the default threshold value is one). See <a href="#">Dictionary Rules, on page 165</a> .
Envelope Recipient Dictionary Match	<code>rcpt-to-dictionary-match (&lt;dictionary_name&gt;)</code>	Does the envelope recipient contain any of the regular expressions or terms in the content dictionary named <i>dictionary name</i> ? See <a href="#">Dictionary Rules, on page 165</a> .

Rule	Syntax	Description
Envelope Sender Dictionary Match	mail-from-dictionary-match ( <i>&lt;dictionary_name&gt;</i> )	Does the envelope sender contain any of the regular expressions or terms in the content dictionary named <i>dictionary name</i> ? See <a href="#">Dictionary Rules</a> , on page 165.
SMTP Authenticated User Match	smtp-auth-id-matches ( <i>&lt;target&gt;</i> [, <i>&lt;sieve-char&gt;</i> ])	Does the address of the Envelope Sender and the address in message header match the authenticated SMTP user ID of the sender? See <a href="#">SMTP Authenticated User Match Rule</a> , on page 169.
True	true	Matches all messages. See <a href="#">True Rule</a> , on page 153.
Valid	valid	Returns false if the message contains unparsable/invalid MIME parts and true otherwise. See <a href="#">Valid Rule</a> , on page 154.
Signed	signed	Is the message is signed? See <a href="#">Signed Rule</a> , on page 171.
Signed Certificate	signed-certificate ( <i>&lt;field&gt;</i> [ <i>&lt;operator&gt;</i> <i>&lt;regular expression&gt;</i> ])	Does the message signer or X.509 certificate issuer match a certain pattern? See <a href="#">Signed Certificate Rule</a> , on page 171.
Header Repeats	header-repeats ( <i>&lt;target&gt;</i> , <i>&lt;threshold&gt;</i> [, <i>&lt;direction&gt;</i> ])	Returns true if at a given point in time, a specified number of messages: <ul style="list-style-type: none"> <li>• With same subject header are detected in last one hour.</li> <li>• From same envelope-sender are detected in last one hour.</li> </ul> See <a href="#">Header Repeats Rule</a> , on page 173.
URL Reputation	url-reputation url-no-reputation	Is the reputation score of any URL in the message within the specified range?  Is a reputation score for a URL unavailable?  See <a href="#">URL Reputation Rules</a> , on page 175 and <a href="#">Configuring Email Gateway to Consume External Threat Feeds</a> , on page 293.



Rule	Syntax	Description
URL Category	<code>url-category</code>	Does the category of any URL in the message match the specified categories?  See <a href="#">URL Category Rule</a> , on page 176.
Corrupt Attachment	<code>attachment-corrupt</code>	Does this message have an attachment that is corrupt?  See <a href="#">Corrupt Attachment Rule</a> , on page 176.
Message Language	<code>message-language</code>	Is the message (subject and body) in one of the selected languages?  See <a href="#">Message Language Rule</a> , on page 177.
Macro Detection	<code>macro-detection-rule (['file_type-1', 'file_type-2', ..., 'file_type-n'])</code>	Does the incoming or outgoing message contain macro-enabled attachments?  See <a href="#">Macro Detection Rule</a> , on page 178.
Forged Email Detection	<code>forged-email-detection ("&lt;dictionary_name&gt;", &lt;threshold&gt;)</code>	Is the sender address of the message forged? The rule checks if the From: header in the message is similar to any of the users in the content dictionary.  See <a href="#">Forged Email Detection Rule</a> , on page 178.
Duplicate Boundaries Verification	<code>duplicate_boundaries</code>	Does the message contain duplicate MIME boundaries?  See <a href="#">Duplicate Boundaries Verification Rule</a> , on page 179.
Malformed MIME Header Detection	<code>malformed-header</code>	Does the message contain malformed MIME headers?  See <a href="#">Malformed MIME Header Detection Rule</a> , on page 180.

Rule	Syntax	Description
Geolocation	<pre>geolocation-rule (['country_name-1', 'country_name-2', 'country_name-n'])</pre>	<p>Does the incoming message originate from the selected countries?</p> <p><b>Note</b> Enable the Anti-Spam engine on your appliance before you use the Geolocation message filter rule.</p> <p>See <a href="#">Geolocation Rule, on page 180</a>.</p>
Domain Reputation	<pre>Sender Domain Reputation: - sdr-reputation   (&lt;'sdr_verdict_range'&gt;,   &lt;'domain_exception_list'&gt;) - sdr-age (&lt;'unit'&gt;,   &lt;'operator'&gt;   &lt;'actual value'&gt;) - sdr-unscannable   (&lt;'domain_exception_list'&gt;)  External Threat Feeds: domain-external- threat-feeds (&lt;'external_threat_feed_source_name'&gt;, &lt;'header'&gt; , &lt;'domain_exception_list'&gt;)</pre>	<p>Does the sender domain match the specified criteria?</p> <ul style="list-style-type: none"> <li>• Sender Domain Reputation</li> <li>• External Threat Feeds</li> </ul> <p>See <a href="#">Domain Reputation Rule for ETF, on page 180</a> or <a href="#">Domain Reputation Rule for SDR, on page 181</a>.</p> <p>For more information, see the <a href="#">Configuring Email Gateway to Consume External Threat Feeds, on page 293</a> or <a href="#">Sender Domain Reputation Filtering, on page 315</a>.</p>

Each message injected into the email gateway is processed through all message filters in order, unless you specify a final action, which stops the message from being processed further. (See [Message Filter Actions, on page 128](#).) Filters may also apply to all messages, and rules may also be combined using logical connectors (AND, OR, NOT).

## Regular Expressions in Rules

Several of the atomic tests used to define rules use *regular expression matching*. Regular expressions can become complex. Use the following table as a guide for the applying of regular expressions within message filter rules:

**Table 22: Regular Expression in Rules**

Regular expression ( abc )	<p>Regular expressions in filter rules match a string if the sequence of directives in the regular expression match any part of the string.</p> <p>For example, the regular expression Georg matches the string George Of The Jungle , the string Georgy Porgy , the string La Meson Georgette as well as Georg .</p>
----------------------------	---

<p>Carat ( ^ )</p> <p>Dollar sign ( \$ )</p>	<p>Rules containing the dollar sign character (\$) only match the end of the string, and rules containing the caret symbol (^) only match the beginning of the string.</p> <p>For example, the regular expression <code>^Georg\$</code> only matches the string <code>Georg</code>.</p> <p>Searching for an empty header would look like this: <code>"^\$"</code></p>
<p>Letters, white space and the at sign ( @ ) character</p>	<p>Rules containing characters, white space, and the at sign character (@) only match themselves explicitly.</p> <p>For example, the regular expression <code>^George@admin\$</code> only matches the string <code>George@admin</code>.</p>
<p>Period character ( . )</p>	<p>Rules containing a period character (.) match any character (except a new line).</p> <p>For example, the regular expression <code>^...admin\$</code> matches the string <code>macadmin</code> as well as the string <code>sunadmin</code> but not <code>win32admin</code>.</p>
<p>Asterisk ( * ) directive</p>	<p>Rules containing an asterisk (*) match “zero or more matches of the previous directive.” In particular, the sequence of a period and an asterisk (.*) matches any sequence of characters (not containing a new line).</p> <p>For example, the regular expression <code>^P.*Piper\$</code> matches all of these strings: <code>PPiper</code>, <code>Peter Piper</code>, <code>P.Piper</code>, and <code>Penelope Penny Piper</code>.</p>
<p>Backslash special characters ( \ )</p>	<p>The backslash character <i>escapes</i> special characters. Thus the sequence <code>\.</code> only matches a literal period, the sequence <code>\\$</code> only matches a literal dollar sign, and the sequence <code>\^</code> only matches a literal caret symbol. For example, the regular expression <code>^ik\.ac\.uk\$</code> only matches the string <code>ik.ac.uk</code>.</p> <p><b>Important Note:</b> The backslash is also a special escape character for the parser. As a result, if you want to include backslash in your regular expression, you must use <i>two</i> backslashes — so that after parsing, only one “real” backslash remains, which is then passed to the regular expression system. So, if you wanted to match the example domain above, you would enter <code>^ik\\.ac\\.uk\$</code>.</p>
<p>Case-insensitivity ( (?i) )</p>	<p>The token (?i) that indicates the rest of the regular expression should be treated in case-insensitive mode. Placing this token at the beginning of a case-sensitive regular expression results in a completely insensitive match.</p> <p>For example, the regular expression “<code>(?i)viagra</code>” matches <code>Viagra</code>, <code>vIaGrA</code>, and <code>VIAGRA</code>.</p>
<p>Number of repetitions {min,max}</p>	<p>The regular expression notation that indicates the number of repetitions of the previous token is supported.</p> <p>For example, the expression “<code>fo{2,3}</code>” matches <code>foo</code> and <code>fooo</code> but not <code>fo</code> or <code>fofo</code>.</p> <p>This statement: <code>if(header('To') == "^.{500,}")</code> looks for a “To” header that has 500 or more characters in it.</p>

Or ( )	<p>Alternation, or the “or” operator. If A and B are regular expressions, the expression “A B” will match any string that matches either “A” or “B.”</p> <p>For example, the expression “foo bar” will match either foo or bar, but not foobar.</p>
--------	---

### Related Topics

- [Using Regular Expressions to Filter Messages, on page 148](#)
- [Guidelines for Using Regular Expressions, on page 148](#)
- [Regular Expression and Non-ASCII Character Sets, on page 149](#)
- [n Tests, on page 149](#)
- [Case-sensitivity, on page 149](#)
- [Writing Efficient Filters, on page 149](#)
- [PDFs and Regular Expressions, on page 150](#)

## Using Regular Expressions to Filter Messages

You can use filters to search for strings and patterns in non-ASCII encoded message content (both headers and bodies). Specifically, the system supports regular expression (regex) searching for non-ASCII character sets within:

- Message headers
- MIME attachment filename strings
- Message body:
  - Bodies without MIME headers (i.e. traditional email)
  - Bodies with MIME headers indicating encoding but no MIME parts
  - Multi-part MIME messages with encoding indicated
  - All of the above without the encoding specified in a MIME header

You can use regular expressions (regexes) to match on any part of the message or body, including matching attachments. The various attachment types include text, HTML, MS Word, Excel, and others. Examples of character sets of interest include gb2312, HZ, EUC, JIS, Shift-JIS, Big5, and Unicode. Message filter rules with regular expressions can be created through the content filter GUI, or using a text editor to generate a file that is then imported into the system. For more information, see [Using the CLI to Manage Message Filters, on page 225](#) and [Configuring Scan Behavior, on page 247](#).

## Guidelines for Using Regular Expressions

It is important to begin a regular expression with a caret (^) and end it with a dollar sign (\$) whenever you want to exactly match a string and not a prefix.



**Note** When matching an empty string, do not use “” as that actually matches *all* strings. Instead use “^\$” . For an example, see the second example in [Subject Rule, on page 154](#).

It is also important to remember that if you want to match a literal period, you must use an escaped period in the regular expression. For example, the regular expression sun.com matches the string thegodsunocommando, but the regular expression ^sun\.com\$ only matched the string sun.com.



```
(attachment-filename == "\\\.vss$") OR (attachment-filename == "\\\.vst$") OR
(attachment-filename == "\\\.vsw$") OR (attachment-filename == "\\\.ws$") OR
(attachment-filename == "\\\.wsc$") OR (attachment-filename == "\\\.wsf$") OR
(attachment-filename == "\\\.wsh$")) { bounce(); }
```

In this instance, AsyncOS will have to start the regular expression engine 30 times, once for each attachment type and the rcv-listener.

Instead, write the filter to look like this:

```
attachment-filter: if (rcv-listener == "Inbound") AND (attachment-filename == "\\.(
(386|exe|ad|ade|adp|asp|bas|bat|chm|cmd|com|cpl|crt|exe|hlp|hta|inf|ins|isp|js|jse|l
nk|mdb|mde|msc|msi|msp|mst|pcd|pif|reg|scr|sct|shb|shs|
url|vb|vbe|vbs|vss|vst|vsw|ws|wsc|wsf|wsh)$") {
```

The regular expression engine only has to start twice and the filter is arguably easier to maintain as you do not have to worry about adding “()”, spelling errors. In contrast to the above, this should show a decrease in CPU overhead.

## PDFs and Regular Expressions

Depending on how a PDF is generated, it may contain no spaces or line breaks. When this occurs, the scanning engine attempts to insert logical spaces and line breaks based on the location of the words on the page. For example, when a word is constructed using multiple fonts or font sizes, the PDF code is rendered in a way that makes it difficult for the scanning engine to determine word and line breaks. When you attempt to match a regular expression against a PDF file constructed in this way, the scanning engine may return unexpected results.

For example, you enter a word in a PowerPoint document that uses different fonts and different font sizes for each letter in the word. When a scanning engine reads a PDF generated from this application, it inserts logical spaces and line breaks. Because of the construction of the PDF, it may interpret the word “callout” as “call out” or “c a l lout.” Attempting to match either of these renderings against the regular expression, “callout,” would result in no matches.

## Smart Identifiers

When you use message rules that scan message content, you can use smart identifiers to detect certain patterns in the data.

Smart identifiers can detect the following patterns in data:

- Credit card numbers
- U.S. Social Security numbers
- Committee on Uniform Security Identification Procedures (CUSIP) numbers
- American Banking Association (ABA) routing numbers

To use smart identifiers in a filter, enter the following keywords in a filter rule that scans body or attachment content:

**Table 23: Smart Identifiers in Message Filters**

Key Word	Smart Identifier	Description
*credit	Credit card number	Identifies 14-, 15-, and 16- digit credit card numbers. NOTE: The smart identifier does not identify enRoute cards.

Key Word	Smart Identifier	Description
*aba	ABA routing number	Identifies ABA routing numbers.
*ssn	Social security number	Identifies U.S. social security numbers. The *ssn smart identifier identifies social security numbers with dashes, periods and spaces.
*cusip	CUSIP number	Identifies CUSIP numbers.

### Related Topics

- [Smart Identifier Syntax, on page 151](#)

## Smart Identifier Syntax

When you use a smart identifier in a filter rule, enter the smart-identifier keyword in quotes within a filter rule that scans the body or attachment file, as in the example below:

```
ID_Credit_Cards:

if(body-contains("*credit")){

notify("legaldept@example.com");

}
.
```

You can also use smart identifiers in content filters and as a part of content dictionaries.



**Note** You cannot combine a smart identifier key word with a normal regular expression or another key word. For example the pattern `*credit|*ssn` would not be valid.



**Note** To minimize on false positives using the \*SSN smart identifier, it may be helpful to use the \*ssn smart identifier along with other filter criteria. One example filter that can be used is the “only-body-contains” filter condition. This will only evaluate the expression to be true if the search string is present in all of the message body mime parts. For example, you could create the following filter:

```
SSN-nohtml: if only-body-contains("*ssn") { duplicate-quarantine("Policy");}
```



**Note** The email gateway detects a smart identifier with or without the keyword ('credit,' 'ssn,' 'cusip,' or 'aba') added as prefix in the message content.

For example: If a message contains a Social Security number in any of the following formats, the email gateway detects the Social Security number as a smart identifier:

('XXX-XX-XXXX' 'ssn XXX-XX-XXXX,' 'ssn: XXX-XX-XXXX,' and so on.)

**Example: Smart Identifier without Prefix**

Create the following filter to detect a smart identifier without the keyword present before the smart identifier.

```
ID_Credit_Cards:
if(body-contains("*credit", 1))
{
notify("legaldept@example.com");
}
```

Where

“credit” indicates the credit card number smart identifier,

“1” indicates the minimum number of matches required for the rule to evaluate to true.

**Example: Smart Identifier with Prefix**

Create the following filter to detect a smart identifier only if the keyword (('credit,' 'ssn,' 'cusip,' or 'aba') is present before the smart identifier.

```
ID_Credit_Cards:
if(body-contains("*credit", 1, "prefix"))
{
notify("legaldept@example.com");
}
```

Where

“credit” indicates the credit card number smart identifier,

“1” indicates the minimum number of matches required for the rule to evaluate to true,

“prefix” indicates the rule is true only if the smart identifier has a keyword prefixed to the smart identifier.

## Description and Examples of Message Filter Rules

The following section describes the various message filter rules in use and their examples.

### Related Topics

- [True Rule, on page 153](#)
- [Valid Rule, on page 154](#)
- [Subject Rule, on page 154](#)
- [Envelope Recipient Rule, on page 155](#)
- [Envelope Recipient in Group Rule, on page 155](#)
- [Envelope Sender Rule, on page 155](#)



- Envelope Sender in Group Rule, on page 156
- Sender Group Rule, on page 156
- Body Size Rule, on page 156
- Remote IP Rule, on page 157
- Receiving Listener Rule, on page 158
- Receiving IP Interface Rule, on page 158
- Date Rule, on page 158
- Header Rule, on page 159
- Random Rule, on page 159
- Recipient Count Rule, on page 160
- Address Count Rule, on page 160
- Body Scanning Rule, on page 160
- Body Scanning , on page 161
- Encryption Detection Rule, on page 161
- Attachment Type Rule, on page 162
- Attachment Filename Rule, on page 162
- DNS List Rule, on page 163
- IP Reputation Rule, on page 164
- Dictionary Rules, on page 165
- SPF-Status Rule, on page 166
- SPF-Passed Rule, on page 168
- S/MIME Gateway Message Rule, on page 168
- S/MIME Gateway Verified Rule, on page 168
- Workqueue-count Rule, on page 168
- SMTP Authenticated User Match Rule, on page 169
- Signed Rule, on page 171
- Header Repeats Rule, on page 173
- URL Reputation Rules , on page 175
- URL Category Rule , on page 176
- Corrupt Attachment Rule, on page 176
- Message Language Rule, on page 177
- Macro Detection Rule, on page 178
- Forged Email Detection Rule, on page 178
- Duplicate Boundaries Verification Rule, on page 179
- Malformed MIME Header Detection Rule, on page 180
- Geolocation Rule, on page 180
- Domain Reputation Rule for ETF, on page 180
- Domain Reputation Rule for SDR, on page 181

## True Rule

The true rule matches all messages. For example, the following rule changes the IP interface to external for all messages it tests.

```
externalFilter:
```

```
    if (true)
```

```

{
    alt-src-host('external');
}

```

## Valid Rule

The `valid` rule returns false if the message contains unparsable/invalid MIME parts and true otherwise. For example, the following rule drops all unparsable messages it tests.

```

not-valid-mime:
if not valid
{
drop();
}

```

## Subject Rule

The `subject` rule selects those messages where the value of the subject header matches the given regular expression.

For example, the following filter discards all messages with subjects that start with the phrase Make Money...

```

not-valid-mime:
if not valid
{
drop();
}

```

You can specify non-ASCII characters to search for in the value of the header.

When working with headers, remember that the current value of the header includes changes made during processing (such as with filter actions that add, remove, or modify message headings). See [Message Header Rules and Evaluation, on page 131](#) for more information.

The following filter returns true if the headers are empty or if the headers are missing from the message:

```

EmptySubject_To_filter:
if (header('Subject') != ".") OR
(header('To') != ".") {
drop();
}

```



---

**Note** This filter returns true for empty Subject and To headers, but it also returns true for missing headers. If the message does not contain the specified headers, the filter still returns true.

---

## Envelope Recipient Rule

The `rcpt-to` rule selects those messages where any Envelope Recipient matches the given regular expression. For example, the following filter drops all messages sent with an email address containing the string “scarface.”



**Note** The regular expression for the `rcpt-to` rule is case *insensitive* .

```
scarfaceFilter:
if (rcpt-to == 'scarface')
{
drop();
}
```



**Note** The `rcpt-to` rule is message-based. If a message has multiple recipients, only one recipient has to match the rule for the specified action to affect the message to all recipients.

## Envelope Recipient in Group Rule

The `rcpt-to-group` rule selects those messages where any Envelope Recipient is found to be a member of the LDAP group given. For example, the following filter drops all messages sent with an email address within the LDAP group “ExpiredAccounts.”

```
expiredFilter:
if (rcpt-to-group == 'ExpiredAccounts')
{
drop();
}
```



**Note** The `rcpt-to-group` rule is message-based. If a message has multiple recipients, only one recipient has to match the rule for the specified action to affect the message to all recipients.

## Envelope Sender Rule

The `mail-from` rule selects those messages where the Envelope Sender matches the given regular expression. For example, the following filter immediately delivers any message sent by `admin@yourdomain.com` .



**Note** The regular expression for the `mail-from` rule is case *insensitive* . Note that the period character is escaped in the following example.

```
kremFilter:
if (mail-from == '^admin@yourdomain\\.com$')
{
skip-filters();
}
```

## Envelope Sender in Group Rule

The `mail-from-group` rule selects those messages where the Envelope Sender is found to be in an LDAP group given on the right side of the operator (or, in the case of inequality, where the sender's email address is *not* in the given LDAP group). For example, the following filter immediately delivers any message sent by someone whose email address is in the LDAP group "KnownSenders."

```
SenderLDAPGroupFilter:
if (mail-from-group == 'KnownSenders')
{
skip-filters();
}
```

## Sender Group Rule

The `sendergroup` message filter selects a message based on which sender group was matched in a listener's Host Access Table (HAT). This rule uses '=' (for matching) or '!=' (for not matching) to test for matching a given regular expression (the right side of the expression). For example, the following message filter rule evaluates to `true` if the sender group of the message matches the regular expression `Internal`, and, if so, sends the message to an alternate mail host.

```
senderGroupFilter:
if (sendergroup == "Internal")
{
alt-mailhost("[172.17.0.1]");
}
```

## Body Size Rule

Body size refers to the size of the message, including both headers and attachments. The `body-size` rule selects those messages where the body size compares as directed to a given number. For example, the following filter bounces any message where the body size is greater than 5 megabytes.

```
BigFilter:
if (body-size > 5M)
{
bounce();
}
```

The `body-size` can be compared in the following ways:

Example	Comparison Type
<code>body-size &lt; 10M</code>	Less than
<code>body-size &lt;= 10M</code>	Less than or equal
<code>body-size &gt; 10M</code>	Greater than
<code>body-size &gt;= 10M</code>	Greater than or equal
<code>body-size == 10M</code>	Equal
<code>body-size != 10M</code>	Not equal

As a convenience, the size measurement may be specified with a suffix:

Quantity	Description
10b	ten bytes (same as 10)
13k	thirteen kilobytes
5M	five megabytes
40G	40 gigabytes (Note: The email gateway cannot accept messages larger than 100 megabytes.)

## Remote IP Rule

The `remote-ip` rule tests to see if the IP address of the host that sent that message matches a certain pattern. The IP address can be either Internet Protocol version 4 (IPv4) or Internet Protocol version 6 (IPv6). The IP address pattern is specified using the allowed hosts notation described in “Sender Group Syntax”, except for the `SBO`, `IPR`, `dnslist` notations and the special keyword `ALL`.

The allowed hosts notation can only identify sequences and numeric ranges of IP addresses (not hostnames). For example, the following filter bounces any message not injected from IP addresses of form `10.1.1.X` where `X` is `50`, `51`, `52`, `53`, `54`, or `55`.

```
notMineFilter:

if (remote-ip != '10.1.1.50-55')

{

bounce();

}
```

## Receiving Listener Rule

The `recv-listener` rule selects those messages received on the named listener. The listener name must be the nickname of one of the listeners currently configured on the system. For example, the following filter immediately delivers any message arriving from the listener named `expedite`.

```
expediteFilter:
if (recv-listener == 'expedite')
{
skip-filters();
}
```

## Receiving IP Interface Rule

The `recv-int` rule selects those messages received via the named interface. The interface name must be the nickname of one of the interfaces currently configured for the system. For example, the following filter bounces any message arriving from the interface named `outside`.

```
outsideFilter:
if (recv-int == 'outside')
{
bounce();
}
```

## Date Rule

The `date` rule checks the current time and date against a time and date you specify. The date rule is compares against a string containing a timestamp of the format `MM/DD/YYYY hh:mm:ss`. This is useful to specify actions to be performed before or after certain times in US format. (Note that there may be an issue if you are searching messages with non-US date formats.) the following filter bounces all messages from `campaign1@yourdomain.com` that are injected after 1:00pm on July 28th, 2003:

```
TimeOutFilter:
if ((date > '07/28/2003 13:00:00') and (mail-from ==
'campaign1@yourdomain\\.com'))
{
bounce();
}
```



---

**Note** Do not confuse the `date` rule with the `$Date` message filter action variable.

---

## Header Rule

The `header()` rule checks the message headers for a specific header, which must be specified quoted in parentheses (“*header name*”). This rule may be compared to a regular expression, much like the subject rule, or may be used without any comparison, in which case it will be “true” if the header is found in the message, and “false” if it is not found. For example, the following example checks to see if the header `X-Sample` is found, and if its value contains the string “`sample text`”. If a match is made, the message is bounced.

```
FooHeaderFilter:
if (header('X-Sample') == 'sample text')
{
bounce();
}
}
```

You can specify non-ASCII characters to search for in the value of the header.

The following example demonstrates the header rule without a comparison. In this case, if the header `X-DeleteMe` is found, it is removed from the message.

```
DeleteMeHeaderFilter:
if header('X-DeleteMe')
{
strip-header('X-DeleteMe');
}
}
```

When working with headers, remember that the current value of the header includes changes made during processing (such as with filter actions that add, remove, or modify message headings). See [Message Header Rules and Evaluation, on page 131](#) for more information.

## Random Rule

The `random` rule generates a random number from zero to N-1, where N is the integer value supplied in parenthesis after the rule. Like the `header()` rule, this rule may be used in a comparison, or may be used alone in a “unary” form. The rule evaluates to `true` in the unary form if the random number generated is non-zero. For example, both of the following filters are effectively equal, choosing Virtual Gateway address A half the time, and Virtual Gateway address B the other half of the time:

```
load_balance_a:
if (random(10) < 5)
{
alt-src-host('interface_a');
}
else
{
alt-src-host('interface_b');
}
load_balance_b:
```

```

if (random(2))
{
alt-src-host('interface_a');
}
else
{
alt-src-host('interface_b');
}

```

## Recipient Count Rule

The `rcpt-count` rule compares the number of recipients of a message against an integer value, in a similar way to the `body-size` rule. This can be useful for preventing users from sending email to large numbers of recipients at once, or for ensuring that such large mailing campaigns go out over a certain Virtual Gateway address. The following example sends any email with more than 100 recipients over a specific Virtual Gateway address:

```

large_list_filter:
if (rcpt-count > 100) {
alt-src-host('mass_mailing_interface');
}

```

## Address Count Rule

The `addr-count()` message filter rule takes one or more header strings, counts the number of recipients in each line and reports the cumulative number of recipients. This filter differs from the `rcpt-count` filter rule in that it operates on the message body headers instead of the envelope recipients. The following example shows the filter rule used to replace a long list of recipients with the alias, “undisclosed-recipients”:

```

count: if (addr-count("To", "Cc") > 30)
{
strip-header("To");
strip-header("Cc");
insert-header("To", "undisclosed-recipients");
}

```

## Body Scanning Rule

The `body-contains()` rule scans the incoming email and all its attachments for a particular pattern defined by its parameter. This includes delivery-status parts and associated attachments. The `body-contains()` rule does not perform multi-line matching. The scanning logic can be modified on the Scan Behavior page or using the `scanconfig` command in the CLI to define which MIME types should or should not be scanned. You can also specify a minimum number of matches that the scanning engine must find in order for the scan to evaluate to true.



By default, the system scans all attachments *except* for those with a MIME type of `video/*` , `audio/*` , `image/*` . The system scans archive attachments — `.zip` , `.bzip` , `.compress` , `.tar` , or `.gzip` attachments containing multiple files. You can set the number of “nested” archived attachments to scan (for example, a `.zip` contained within a `.zip` ).

For more information, see [Configuring Scan Behavior, on page 247](#).

## Body Scanning

When AsyncOS performs body scanning, it scans the body text and attachments for the regular expression. You can assign a minimum threshold value for the expression, and if the scanning engine encounters the regular expression the minimum number of times, the expression evaluates to `true` .

AsyncOS evaluates the different MIME parts of the message, and it scans any MIME part that is textual. AsyncOS identifies the text parts if the MIME type specifies text in the first part. AsyncOS determines the encoding based on the encoding specified in the message, and it converts the text to Unicode. It then searches for the regular expression in Unicode space. If no encoding is specified in the message, AsyncOS uses the encoding you specify on the Scan Behavior page or using the `scanconfig` command.

For more information about how AsyncOS evaluates MIME parts when scanning messages, see [Message Bodies vs. Message Attachments, on page 131](#).

If the MIME part is not textual, AsyncOS extract files from a `.zip` or `.tar` archive or decompresses compressed files. After extracting the data, a scanning engine identifies the encoding for the file and returns the data from the file in Unicode. AsyncOS then searches for the regular expression in Unicode space.

The following example searches the body text and attachment for the phrase “Company Confidential.” The example specifies a minimum threshold of two instances, so if the scanning engine finds two or more instances of the phrase, it bounces any matching messages, and notifies the legal department of the attempt:

ConfidentialFilter:

```
if (body-contains('Company Confidential',2)) {  
  notify ('legaldept@example.domain');  
  bounce();  
}
```

To scan only the body of the message, use `only-body-contains` :

disclaimer:

```
if (not only-body-contains('[d]isclaimer',1) ) {  
  notify('hresource@example.com');  
}
```

## Encryption Detection Rule

The `encrypted` rule examines the contents of a message for encrypted data. It does not attempt to decode the encrypted data, but merely examines the contents of the message for the existence of encrypted data. This can be useful for preventing users from sending encrypted email.



**Note** The encrypted rule can only detect encrypted data in the content of messages. It does not detect encrypted attachments.

The encrypted rule is similar to the `true` rule in that it takes no parameters and cannot be compared. This rule returns `true` if encrypted data is found and `false` if no encrypted data is found. Because this function requires the message to be scanned, it uses the scanning settings you define on the Scan Behavior page or using the `scanconfig` command. For more information about configuring these options, see [Configuring Scan Behavior, on page 247](#).

The following filter checks all email sent through the listener, and if a message contains encrypted data, the message is blind-carbon-copied to the legal department and then bounced:

```
prevent_encrypted_data:
if (encrypted) {
  bcc ('legaldept@example.domain');
  bounce();
}
```

## Attachment Type Rule

The `attachment-type` rule checks the MIME types of each attachment in a message to see if it matches the given pattern. The pattern must be of the same form used in the Scan Behavior page or the `scanconfig` command, as described in [Configuring Scan Behavior, on page 247](#), and so may have either side of the slash (/) replaced by an asterisk as a wildcard. If the message contains an attachment that matches this specified MIME type, this rule returns “true.”

Because this function requires the message to be scanned, it obeys all of the options described in [Configuring Scan Behavior, on page 247](#).

See [Attachment Scanning, on page 214](#) for more information on message filter rules you can use to manipulate attachments to messages.

The following filter checks all email sent through the listener, and if a message contains an attachment with a MIME type of `video/*`, the message is bounced:

```
bounce_video_clips:
if (attachment-type == 'video/*') {
  bounce();
}
```

## Attachment Filename Rule

The `attachment-filename` rule checks the filenames of each attachment in a message to see if it matches the given regular expression. This comparison is case-sensitive. The comparison is, however sensitive to whitespace so if the filename has encoded whitespace at the end, the filter will skip the attachment. If one of the message’s attachments matches the filename, this rule returns “true.”

Please note the following points:

- Each attachment's filename is captured from the MIME headers. The filename in the MIME header may contain trailing spaces.
- If an attachment is an archive, the email gateway will harvest the filenames from inside the archive, and apply scan configuration rules (see [Configuring Scan Behavior, on page 247](#)) accordingly.
  - If the attachment is a single compressed file (despite the file extension), it is not considered an archive and the filename of the compressed file is not harvested. This means that the file is not processed by the `attachment-filename` rule. An example of this type of file is an executable file (.exe) compressed with `gzip`.
  - For attachments consisting of a single compressed file, such as `foo.exe.gz`, use regular expression to search for specific file types within compressed files. See [Attachment Filenames and Single Compressed Files within Archive Files, on page 163](#).

See [Attachment Scanning, on page 214](#) for more information on message filter rules you can use to manipulate attachments to messages.

The following filter checks all email sent through the listener, and if a message contains an attachment with a filename `*.mp3`, the message is bounced:

```
block_mp3s:

if (attachment-filename == '(?i)\\.mp3$') {

bounce();

}
```

### Related Topics

- [Attachment Filenames and Single Compressed Files within Archive Files, on page 163](#)

## Attachment Filenames and Single Compressed Files within Archive Files

This example shows how to match single compressed files in archives such as those created by `gzip`:

```
quarantine_gzipped_exe_or_pif:

if (attachment-filename == '(?i)\\. (exe|pif) ($|.gz$)') {

quarantine("Policy");

}
```

## DNS List Rule

The `dnslist()` rule queries a public DNS List server that uses the DNSBL method (sometimes called “ip4r lookups”) of querying. The IP address of the incoming connection is reversed (so an IP of 1.2.3.4 becomes 4.3.2.1) and then added as a prefix to the server name in the parenthesis (a period to separate the two is added if the server name does not start with one). A DNS query is made, and the system is returned with either a DNS failure response (indicating the connection's IP address was not found in the server's list) or an IP address (indicating that the address was found). The IP address returned is *usually* of the form `127.0.0. x` where `x` can be almost any number from 0 to 255 (IP address ranges are not allowed). Some servers actually return different numbers based on the reason for the listing, while others return the same result for all matches.

Like the `header()` rule, `dnslist()` can be used in either a unary or binary comparison. By itself, it simply evaluates to `true` if a response is received and `false` if no response is received (for example, if the DNS server is unreachable).

The following filter immediately delivers a message if the sender has been bonded with the Cisco Bonded Sender information services program:

```
allowedlist_bondedsender:

if (dnslist('query.bondedsender.org')) {

skip-filters();

}
```

Optionally, you can compare the result to a string using the equality (`==`) or inequality (`!=`) expressions.

The following filter drops a message that results in a “127.0.0.2” response from the server. If the response is anything else, the rule returns “false” and the filter is ignored.

```
blockedlist:

if (dnslist('dnsbl.example.domain') == '127.0.0.2') {

drop();

}
```

## IP Reputation Rule

The `reputation` rule checks the IP Reputation Score against another value. All the comparison operators are allowed, such as `>`, `==`, `<=`, and so forth. If the message does not have a IP Reputation Score at all (because one was never checked for it, or because the system failed to get a response from the IP Reputation Service query server), any comparison against a reputation fails (the number will not be greater than, less than, equal to, or not equal to any value). You can check for a IP Reputation score of “none” using the `no-reputation` rule described below. The following example adjusts the “Subject:” line of a message to be prefixed by “\*\*\* BadRep \*\*\*” if the reputation score returned from the IP Reputation Service is below a threshold of `-7.5`.

```
note_bad_reps:

if (reputation < -7.5) {
strip-header ('Subject');
insert-header ('Subject', '*** BadRep $Reputation *** $Subject');
}
```

For more information, see the “Sender Reputation Filtering” chapter. See also [Bypass Anti-Spam System Action, on page 208](#)

Values for the IP Reputation rule are `-10` through `10`, but the value `NONE` may also be returned. To check specifically for the value `NONE`, use the `no-reputation` rule.

```
none_rep:

if (no-reputation) {

strip-header ('Subject');

insert-header ('Subject', '*** Reputation = NONE *** $Subject');
```

```
}
```

## Dictionary Rules

The `dictionary-match(< dictionary_name >)` rule evaluates to `true` if the message body contains any of the regular expressions or terms in the content dictionary named “*dictionary\_name* .” If the dictionary does not exist, the rule evaluates to `false` . For more information on defining dictionaries (including their case sensitivity and word boundary settings), see the “Text Resources” chapter.

The following filter blind carbon copies the administrator when the Cisco scans a message that contains any words within the dictionary named “secret\_words.”

```
copy_codenames:
if (dictionary-match ('secret_words')) {
bcc('administrator@example.com');
}
```

The following example sends the message to the Policy quarantine if the message body contains any words within the dictionary named “secret\_words.” Unlike the `only-body-contains` condition, the `body-dictionary-match` condition does not require that all the content parts individually match the dictionary. The scores of each content part (taking into account multipart/alternative parts) are added together.

```
quarantine_data_loss_prevention:
if (body-dictionary-match ('secret_words'))
{
quarantine('Policy');
}
```

In the following filter, a subject that matches a term in the specified dictionary is quarantined:

```
quarantine_policy_subject:
if (subject-dictionary-match ('gTest'))
{
quarantine('Policy');
}
```

This example matches an email address in the “to” header and blind copies an administrator:

```
headerTest:
if (header-dictionary-match ('competitorsList', 'to'))
{
bcc('administrator@example.com');
}
```

The `attachment-dictionary-match(<dictionary_name>)` rule works like the `dictionary-match` rule above, except that it looks for matches in the attachment.

The following filter sends the message to the Policy quarantine if the message attachment contains any words found within the dictionary named “secret\_words.”

```
quarantine_codenames_attachment:
if (attachment-dictionary-match ('secret_words'))
{
quarantine('Policy');
}
```

The `header-dictionary-match(<dictionary_name>, <header>)` rule works like the `dictionary-match` rule above, except that it looks for matches in the header specified in `<header>`. The header name is case insensitive, so, for example, “subject” and “Subject” both work.

The following filter sends the message to the Policy quarantine if the message’s “cc” header contains any words found within the dictionary named “ex\_employees.”

```
quarantine_codenames_attachment:
if (header-dictionary-match ('ex_employees', 'cc'))
{
quarantine('Policy');
}
```

You can use wild cards within the dictionary terms. You do not have to escape the period in email addresses.

## SPF-Status Rule

When you receive SPF/SIDF verified mail, you may want to take different actions depending on the results of the SPF/SIDF verification. The `spf-status` rule checks against different SPF verification results. For more information, see [Verification Results, on page 625](#).



---

**Note** If you have configured an SPF verification message filter rule without an SPF identity and if a message contains different SPF identities with different verdicts, the rule is triggered if one of the verdicts in the message matches the rule.

---

You can check against the SPF/SIDF verification results using the following syntax:

```
if (spf-status == "Pass")
```

If you want a single condition to check against multiple status verdicts, you can use the following syntax:

```
if (spf-status == "PermError, TempError")
```

You can also check the verification results against the HELO, MAIL FROM, and PRA identities using the following syntax:

```
if (spf-status("pra") == "Fail")
```

The following example shows the spf-status filter in use:

```
skip-spam-check-for-verified-senders:

if (sendergroup == "TRUSTED" and spf-status == "Pass"){

skip-spamcheck();

}

quarantine-spf-failed-mail:

if (spf-status("pra") == "Fail") {

if (spf-status("mailfrom") == "Fail"){

# completely malicious mail

quarantine("Policy");

} else {

if(spf-status("mailfrom") == "SoftFail") {

# malicious mail, but tempting

quarantine("Policy");

}

}

} else {

if(spf-status("pra") == "SoftFail"){

if (spf-status("mailfrom") == "Fail"

or spf-status("mailfrom") == "SoftFail"){

# malicious mail, but tempting

quarantine("Policy");

}

}

}

stamp-mail-with-spf-verification-error:

if (spf-status("pra") == "PermError, TempError"

or spf-status("mailfrom") == "PermError, TempError"

or spf-status("helo") == "PermError, TempError"){

# permanent error - stamp message subject
```

```
strip-header("Subject");

insert-header("Subject", "[POTENTIAL PHISHING] $Subject"); }

.
```

## SPF-Passed Rule

The following example shows an `spf-passed` rule used to quarantine emails that are not marked as `spf-passed`:

```
quarantine-spf-unauthorized-mail:

if (not spf-passed) {

quarantine("Policy");

}
```



---

**Note** Unlike the `spf-status` rule, the `spf-passed` rule reduces the SPF/SIDF verification values to a simple Boolean. The following verification results are treated as not passed in the `spf-passed` rule: None, Neutral, Softfail, TempError, PermError, and Fail. To perform actions on messages based on more granular results, use the `spf-status` rule.

---

## S/MIME Gateway Message Rule

The S/MIME Gateway Message rule checks if a message is S/MIME signed, encrypted, or signed and encrypted. The following message filter checks if the message is an S/MIME message and quarantines it if the verification or decryption using S/MIME fails.

```
quarantine_smime_messages:
if (smime-gateway-message and not smime-gateway-verified) {
quarantine("Policy");
}
```

For more information, see [S/MIME Security Services, on page 549](#).

## S/MIME Gateway Verified Rule

The S/MIME Gateway Message Verified rule checks if a message is successfully verified, decrypted, or decrypted and verified. The following message filter checks if the message is an S/MIME message and quarantines it if the verification or decryption using S/MIME fails.

```
quarantine_smime_messages:
if (smime-gateway-message and not smime-gateway-verified) {
quarantine("Policy");
}
```

For more information, see [S/MIME Security Services, on page 549](#).

## Workqueue-count Rule

The `workqueue-count` rule checks the `workqueue-count` against a specified value. All the comparison operators are allowed, such as `>`, `==`, `<=`, and so forth.



The following filter checks the workqueue count, and skips spam check if the queue is greater than the specified number.

```
wqfull:
if (workqueue-count > 1000) {
skip-spamcheck();
}
```

For more information on SPF/SIDF, see [Overview of SPF and SIDF Verification, on page 618](#).

## SMTP Authenticated User Match Rule

If your email gateway uses SMTP authentication to send messages, the `smtp-auth-id-matches (<target> [, < sieve-char >])` rule can check a message's headers and Envelope Sender against the sender's SMTP authenticated user ID to identify outgoing messages with spoofed headers. This filter allows the system to quarantine or block potentially spoofed messages.

The `smtp-auth-id-matches` rule compares the SMTP authenticated ID against the following targets:

Target	Description
*EnvelopeFrom	Compares the address of the Envelope Sender (also known as MAIL FROM) in the SMTP conversation
*FromAddress	Compares the addresses parsed out of the From header. Since multiple addresses are permitted in the From: header, only one has to match.
*Sender	Compares the address specified in the Sender header.
*Any	Matches messages that were created during an authenticated SMTP session regardless of identity.
*None	Matches messages that were not created during an authenticated SMTP session. This is useful when authentication is optional (preferred).

The filter performs matches loosely. It is not case-sensitive. If the optional `sieve-char` parameter is supplied, the last portion of an address that follows the specified character will be ignored for the purposes of comparison. For example, if the `+` character is included as a parameter, the filter ignores the portion of the address `joe+folder@example.com` that follows the `+` character. If the address was `joe+smith+folder@example.com`, only the `+folder` portion is ignored. If the SMTP authenticated user ID string is a simple username and not a fully-qualified e-mail address, only the username portion of the target will be examined to determine a match. The domain must be verified in a separate rule.

Also, you can use the `$SMTPAuthID` variable to insert the SMTP authenticated user ID into headers.

The following table shows examples of comparisons between the SMTP authenticated ID and email addresses and whether they would match using the `smtp-auth-id-matches` filter rule:

SMTP Auth ID	Sieve Char	Comparison Address	Matches?
someuser		otheruser@example.com	No
someuser		someuser@example.com	Yes

SMTP Auth ID	Sieve Char	Comparison Address	Matches?
someuser		someuser@another.com	Yes
SomeUser		someuser@example.com	Yes
someuser		someuser+folder@example.com	No
someuser	+	someuser+folder@example.com	Yes
someuser@example.com		someuser@forged.com	No
someuser@example.com		someuser@example.com	Yes
SomeUser@example.com		someuser@example.com	Yes

The following filter checks all messages created during an authenticated SMTP session to verify that the addresses in the From header and the Envelope Sender match the SMTP authenticated user ID. If the addresses and the ID match, the filter verifies the domain. If they do not match, the email gateway quarantines the message.

Msg\_Authentication:

```

if (smtp-auth-id-matches("*Any"))
{
# Always include the original authentication credentials in a
# special header.
insert-header("X-Auth-ID", "$SMTPAuthID");
if (smtp-auth-id-matches("*FromAddress", "+") and
smtp-auth-id-matches("*EnvelopeFrom", "+"))
{
# Username matches. Verify the domain
if header('from') != "(?i)@(:example\\.com|alternate\\.com)" or
mail-from != "(?i)@(:example\\.com|alternate\\.com)"
{
# User has specified a domain which cannot be authenticated
quarantine("forged");
}
} else {
# User claims to be an completely different user
quarantine("forged");
}
}

```

```
}
```

## Signed Rule

The signed rule checks messages for a signature. The rule returns a boolean value to indicate if the message is signed or not. This rule evaluates whether the signature is encoded according to ASN.1 DER encoding rules and that it conforms to the CMS SignedData Type structure (RFC 3852, Section 5.1.). It does not aim to validate whether the signature matches the content, nor does it check the validity of the certificate.

The following example shows a `signed` rule used to insert headers into a signed message:

```
signedcheck: if signed { insert-header("X-Signed", "True"); }
```

The following example shows a signed rule used to drop attachments from unsigned messages from a certain sender group:

```
Signed: if ((sendergroup == "NOTTRUSTED") AND NOT signed) {
  html-convert();
  if (attachment_size > 0)
  {
    drop_attachments("");
  }
}
```

## Signed Certificate Rule

The signed-certificate rule selects those S/MIME messages where the X.509 certificate issuer or message signer matches the given regular expression. This rule only supports X.509 certificates.

The rule's syntax is `signed-certificate (<field> [<operator> <regular expression>])`, where:

- `<field>` is either the quoted string "issuer" or "signer",
- `<operator>` is either `==` or `!=`,
- and `<regular expression>` is the value for matching the "issuer" or "signer."

If the message is signed using multiple signatures, the rule returns true if any of the issuers or signers match the regular expression. The short form of this rule, `signed-certificate("issuer")` and `signed-certificate("signer")`, returns true if the S/MIME message contains an issuer or signer.

### Related Topics

- [Signer, on page 172](#)
- [Issuer, on page 172](#)
- [Escaping in Regular Expressions, on page 172](#)
- [\\$CertificateSigners Action Variable, on page 172](#)
- [Examples 1, on page 173](#)

## Signer

For message signers, the rule extracts the sequence of `rfc822Name` names from the X.509 certificate's `subjectAltName` extension. If there is no `subjectAltName` field in the signing certificate, or this field does not have any `rfc822Name` names, the `signed-certificate("signer")` rule evaluates to false. In the rare cases of multiple `rfc822Name` names, the rule tries to match all of the names to the regular expression and evaluates as true on the first match.

## Issuer

The issuer is a non-empty distinguished name in the X.509 certificate. AsyncOS extracts the issuer from the certificate and converts it to an LDAP-UTF8 Unicode string. For example:

- C=US,S=CA,O=IronPort
- C=US,CN=Bob Smith

Since X.509 certificates require the issuer field, `signed-certificate("issuer")` evaluates whether the S/MIME message contains an X.509 certificate.

## Escaping in Regular Expressions

LDAP-UTF8 defines a mechanism for escaping that you can use in your regular expressions. For a detailed discussion on escaping characters in LDAP-UTF8, consult Lightweight Directory Access Protocol (LDAP): String Representation of Distinguished Names, accessible from <http://www.ietf.org/rfc/rfc4514.txt>.

The escaping rules for the `signed-certificate` rule's regular expressions differ from the escaping rules defined in LDAP-UTF8 by limiting escaping to only the characters that require escaping. LDAP-UTF8 allows optional escaping for characters that can be represented without escaping. For example, the following two strings are considered correct for "Example, Inc." using the LDAP-UTF8 escaping rules:

- Example\, Inc.
- Example\\, Inc\.

However, the `signed-certificate` rule only matches Example\, Inc. The regular expression does not allow escaping the space and period for matching because these characters do not require escaping, even though it is permitted in LDAP-UTF8. When creating a regular expression for the `signed-certificate` rule, do not escape a character if it can be represented without escaping.

## \$CertificateSigners Action Variable

The action variable `$CertificateSigners` is a comma separated list of signers obtained from the `subjectAltName` element of the signing certificate. Multiple email addresses of a single signer will be included in the list with duplicates removed.

For example, Alice signs a message with her two certificates. Bob signs the message with his single certificate. All certificates are issued by a single corporate authority. After the message passes the S/MIME scan, the extracted data contain three items:

```
[
{
'issuer': 'CN=Auth,O=Example\, Inc.',
'signer': ['alice@example.com', 'al@private.example.com']
},
{
```

```
'issuer': 'CN=Auth,O=Example\, Inc.',
'signer': ['alice@example.com', 'al@private.example.com']
},
{
'issuer': 'CN=Auth,O=Example\, Inc.',
'signer': ['bob@example.com', 'bob@private.example.com']
}
]
```

The `$CertificateSigners` variable expands to:

```
"alice@example.com, al@private.example.com, bob@example.com, bob@private.example.com"
```

## Examples 1

The following example inserts a new header if the certificate issuer is from the US:

```
Issuer: if signed-certificate("issuer") == "(?i)C=US" {
insert-header("X-Test", "US issuer");
}
```

The following example notifies an administrator if the signer is not from example.com:

```
NotOurSigners: if signed-certificate("signer") AND
signed-certificate("signer") != "example\\.com$" {
notify("admin@example.com");
}
```

The following example adds a header if the message has an X.509 certificate:

```
AnyX509: if signed-certificate ("issuer") {
insert-header("X-Test", "X.509 present");
}
```

The following example adds a header if the message's certificate does not have a signer:

```
NoSigner: if not signed-certificate ("signer") {
insert-header("X-Test", "Old X.509?");
}
```

## Header Repeats Rule

The Header Repeats rule evaluates to true if at a given point in time, a specified number of messages:

- With same subject are detected in the last one hour.
- From same envelope sender are detected in the last one hour.

You can use this rule to detect high volume emails. For example, political campaigns through certain websites may send out emails to organizations in high volumes. Anti-spam engines treat such emails as clean, and do not stop the delivery of these emails.

The syntax of this rule is `header-repeats (<target>, <threshold> [, <direction>])`, where:

- `<target>` is subject or mail-from . AsyncOS counts the repetition of values of the target.
- `<threshold>` is the number of messages with identical values for a given target, received in the last one hour, beyond which the rule evaluates to true.
- `<direction>` is incoming , outgoing , or both. If direction is not specified in this rule, incoming or outgoing messages are counted for rule evaluation.

Every time when a Header Repeats rule evaluates to true , a System Alert is sent. See [System Alerts, on page 1055](#).



---

**Note** If the header field includes comma or semi-colon separated values, the rule considers the complete string for tracking. This rule ignores messages with empty subject header.

---

The Header Repeats rule maintains a moving sum of messages with up to one minute's precision. As a result, after the set threshold has reached, there can be a delay of one minute before this rule is triggered.

#### Related Topics

- [Using Header Repeats Rule with Other Rules, on page 174](#)
- [Examples, on page 175](#)

### Using Header Repeats Rule with Other Rules

You can use the Header Repeats rule with other rules using AND or OR operators. For example, you can categorize an allowed list for a subset of messages using the following filter:

```
f1: if (recv_listener == 'Gray') AND (header-repeats('subject', X, 'incoming') { drop();}
```

When you use a Header Repeats rule with another rule using AND or OR operators, the Header Repeats rule is evaluated last, and only if needed. If a Header Repeats rule is not evaluated for a given message, subject or mail-from is not counted to compare with the supplied threshold.

As Header Repeats rule is evaluated last and only if needed, the behavior of this rule may vary when used with other rules using an OR operator. The following sample filter uses an OR condition of Signed and Header Repeats rule.

```
f1: if signed OR (header-repeats('subject', 10)) { drop();}
```

In this example, if the first nine messages processed by this filter are signed messages with identical subject, the Header Repeats rule will not process these messages. If the tenth message is an unsigned message with identical subject header as the previous nine messages, the filter will not perform the configured action, even though the threshold has reached.

## Examples

In the following example, at any given point in time, if the filter detects X or more incoming messages with identical subject in the last one hour, the subsequent messages with identical subject are sent to Policy quarantine.

```
f1 : if header-repeats('subject', X, 'incoming') { quarantine('Policy');}
```

In the following example, at any given point in time, if the filter detects X or more outgoing messages from same envelope sender in the last one hour, the subsequent messages from the same envelope sender are dropped and discarded.

```
f2 : if header-repeats('mail-from', X, 'outgoing') {drop();}
```

In the following example, at any given point in time, if the filter detects X or more incoming or outgoing messages with identical subject in the last one hour, the administrator is notified for every subsequent message with identical subject.

```
f3: if header-repeats('subject', X) {notify('admin@xyz.com');}
```

## URL Reputation Rules

Use a URL reputation rule to define message actions based on the reputation score of any URL in the message. For important details, see [Filtering by URL Reputation or URL Category: Conditions and Rules](#), on page 451 in [Protecting Against Malicious or Undesirable URLs](#), on page 443

For these rules:

- `msg_filter_name` : is the name of this message filter.
- `allowedlist` is the name of a defined URL list (via the `urllistconfig` command.) Specifying an allowed list is optional.

### To take action when the reputation service provides a score:

Use the `url-reputation` rule.

Filter syntax when using a `url-reputation` rule is:

```
<msg_filter_name>:  
  
if url-reputation('<min_score>', '<max_score>', '<allowedlist>',  
'<include_attachments>', '<include_message_body_subject>')  
  
{<action>}
```

Where:

- `min_score` and `max_score` are the minimum and maximum scores in the range for which the action should apply. The values that you specify are included in the range.

Minimum and maximum scores must be between -10.0 and 10.0 .

- `include_attachments` to scan for URLs in the message attachments. A value of '1' indicates that URL scanning for message attachments is enabled and a value of '0' indicates that URL scanning for message attachments is not enabled.

- `include_message_body_subject` to scan for URLs in the message body and subject. A value of '1' indicates that URL scanning for message body and subject is enabled and a value of '0' indicates that URL scanning for message body and subject is not enabled.

#### To take action when the reputation service does not provide a score:

Use the `url-no-reputation` rule.

Filter syntax when using a `url-no-reputation` rule is:

```
<msg_filter_name>:
if url_no_reputation('<allowedlist>',
'<include_attachments>', '<include_message_body_subject>')
{<action>}
```

## URL Category Rule

Use URL categories to define message actions based on the category of URLs in the message. For important details, see [Filtering by URL Reputation or URL Category: Conditions and Rules](#), on page 451 in [Protecting Against Malicious or Undesirable URLs](#), on page 443.

Filter syntax when using a `url-category` rule is:

```
<msg_filter_name>: if url-category ([ '<category-name1>', '<category-name2>', ...,
'<category-name3>', '<url_allowed_list>', '<include_attachments>', '<include_message_body_subject>')
<action>
```

Where:

- `msg_filter_name` is the name of this message filter.
- `action` is any message filter action.
- `category-name` is the URL category. Separate multiple categories with commas. To obtain correct category names, look at a URL Category condition or action in a Content Filter. For descriptions and examples of the categories, see [About URL Categories](#), on page 462.
- `url_allowed_list` is the name of a defined URL list (via the `urllistconfig` command.)
- `include_attachments` to scan for URLs in message attachments. A value of '1' indicates that URL scanning for message attachments is enabled and a value of '0' indicates that URL scanning for message attachments is not enabled.
- `include_message_body_subject` to scan for URLs in the message body and subject. A value of '1' indicates that URL scanning for the message body and subject is enabled and a value of '0' indicates that URL scanning for the message body and subjects is not enabled.

## Corrupt Attachment Rule

The Corrupt Attachment rule evaluates to true if a message contains corrupt attachment. A corrupt attachment is an attachment that the scanning engine cannot scan and identified as corrupt.

#### Related Topics

- [Example](#), on page 177



## Example

In the following example, if the filter detects a corrupt attachment in a message, the message is quarantined to Policy Quarantine.

```
quar_corrupt_attach: if (attachment-corrupt) { quarantine("Policy"); }
```

## Message Language Rule

You may want to take different message actions based on the message language. For example, you may want to:

- Add a disclaimer in Russian to the messages that are in Russian
- Drop the messages whose language could not be determined

Use the message-language rule to take message actions depending on the language of the message subject and body.



---

**Note** This rule will not check for the language in attachments and headers.

---

## How Does Language Detection Work

The email gateway uses the built-in language detection engine to detect the language in a message. The email gateway extracts the subject and the message body and passes it to the language detection engine.

The language detection engine determines the probability of each language in the extracted text and passes it back to the email gateway. The email gateway considers the language with the highest probability as the language of the message. The email gateway considers the language of the message as ‘undetermined’ in one of the following scenarios:

- If the detected language is not supported by the email gateway
- If the email gateway is unable to detect the language of the message
- If the total size of the extracted text sent to the language detection engine is less than 50 bytes.

## Message Filter Syntax

```
<msg_filter_name>: if (message-language <operator> "<language1>, <language2>, ..., <language n>") {<action>}
```

Where:

- `msg_filter_name` is the name of this message filter.
- `operator` is `==` or `!=`.
- `language` is the value of message language that you want to specify in this message filter. Separate multiple entries with commas. For a list of supported message languages and values, look at the Message Language condition in a content filter. Values are enclosed with brackets ([ and ]).
- `action` is any message filter action.

## Examples

The following example shows how to drop the messages whose language could not be determined:

```
DropMessagesWithUndeterminedLanguage: if (message-language == "unknown") { drop(); }
```

The following example shows how to add a disclaimer in Russian to the messages in Russian:

```
ussianDisclaimerRule: if (message-language == "ru") { add-heading("RussianDisclaimer");
```

## Macro Detection Rule

You can use the Macro Detection rule to detect macro-enabled attachments in messages for the specified file types.



---

**Note** If an archive or embedded file contains macros, the parent file is dropped from the message.

---

### Macro Detection Syntax

```
<msg_filter_name>: if (macro-detection-rule (['file_type-1', 'file_type-2',...
,'file_type-n'])) {<action>}
```

Where:

- `msg_filter_name` is the name of this message filter.
- `file_type` can be any one of the following supported file types:
  - Adobe Portable Document Format
  - Microsoft Office Files
  - OLE File types
- `action` is any message filter action.

### Examples

The following example shows how to drop a message that contains a macro-enabled Microsoft Office attachment:

```
Drop_Messages_With_Macro-enabled_Office_Files: if (macro-detection-rule (['Microsoft Office
Files'])) { drop(); }
```

In the following example, if a message containing a macro-enabled attachment in a PDF format is sent to a specific user, the message is dropped:

```
Strip_Macro_enabled_PDF: if (rcpt-to == "joe@example.com") {
drop-macro-enabled-attachments(['Adobe Portable Document Format']); }
```

## Forged Email Detection Rule

You may want to detect fraudulent messages with forged sender address (From: header) and perform actions on such messages.

Use the forged-email-detection rule to detect such messages. While configuring this rule, you must specify a content dictionary and the threshold value (1 through 100) for considering a message as potentially forged.

The forged-email-detection rule compares the From: header with the users in the content dictionary. During this process, depending on the similarity, the email gateway assigns similarity score to each of the users in the dictionary. The following are some examples:

- If the From: header is <john.simons@example.com> and the content dictionary contains a user 'John Simons,' the email gateway assigns a similarity score of 82 to the user.
- If the From: header is <john.simons@diff-example.com> and the content dictionary contains a user 'John Simons,' the email gateway assigns a similarity score of 100 to the user.

The higher the similarity score, the higher the probability that the message is forged. If the similarity score is greater than or equal to the specified threshold value, the filter action is triggered.

For more information, see [Forged Email Detection, on page 636](#).

### Message Filter Syntax

```
<filter_name>: if (forged-email-detection("<content_dictionary>", threshold)) {<action>;}
```

Where:

- filter\_name is the name of the message filter
- content\_dictionary is the name of content dictionary
- threshold is the threshold value (1 through 100) for considering a message as potentially forged

### Example

The following message filter compares the From: header in the message with the terms in dictionary and if the similarity score of a user in the content dictionary is greater than or equal to 70, the message filter strips the From: header and replaces it with the Envelope Sender.

```
FED_CF: if (forged-email-detection("Execs", 70)) { fed("from", ""); }
```

## Duplicate Boundaries Verification Rule

You can use the duplicate\_boundaries rule to detect messages that contain duplicate MIME boundaries.



---

**Note** Attachment-based rules (for example, attachment-contains ) or actions (for example, drop-attachments-where-contains ) will not work on malformed messages (with duplicate MIME boundaries).

---

### Message Filter Syntax

```
<filter_name>: if (duplicate_boundaries){<action>;}
```

### Example

The following message filter will quarantine all the messages that contain duplicate MIME boundaries.

```
DuplicateBoundaries: if (duplicate_boundaries) { quarantine("Policy"); }
```

## Malformed MIME Header Detection Rule

You can use the malformed-header rule to detect messages that contain malformed MIME headers.

### Message Filter Syntax

```
<filter_name>: if (malformed-header) {<action>;}
```

### Example

The following example shows how to quarantine all the messages with malformed MIME headers:

```
quarantine_malformed_headers: if (malformed-header)
{
quarantine("Policy");
}
```

## Geolocation Rule

You can use the Geolocation rule to handle incoming messages from particular countries that you select.

### Geolocation Syntax

```
<msg_filter_name>: if (geolocation-rule (['country_name-1', 'country_name-2',...
,'country_name-n'])) {<action>}
```

Where:

- `msg_filter_name` is the name of this message filter.
- `country_name` can be name of any country that you select.
- `action` is any message filter action.

### Example

The following example shows how to quarantine an incoming message from Country1 and Country2:

```
Quarantine_Incoming_Messages_from_Country1_and_Country2: if (geolocation-rule
(['Country1', 'Country2'])) {quarantine("Policy");}
```

## Domain Reputation Rule for ETF

As an example, use the following message filter rule syntax to detect malicious domains in messages using the ETF engine, and take appropriate actions on such messages.

### Syntax:

```
quarantine_msg_based_on ETF: if (domain-external-threat-feeds (['etf_source1'],
['mail-from', 'from'], <'domain_exception_list'>)) { quarantine("Policy"); }
```

Where

- `'domain-external-threat-feeds'` is the Domain reputation message filter rule.
- `'etf_source1'` is the ETF source(s) used to detect malicious domain(s) in the header(s) of a message.
- `'mail-from', 'from'` are the required header(s) used to check for the reputation of the domain.

- 'domain\_exception\_list' is the name of a domain exception list. If a domain exception list is not present it is displayed as "".

### Example

In the following example, if the domain in the 'Errors To:' custom header is detected as malicious by the ETF engine, the message is quarantined.

```
Quarantining_Messages_with_Malicious_Domains: if domain-external-threat-feeds
(['threat_feed_source'], ['Errors-To'], "") {quarantine("Policy");}
```

## Domain Reputation Rule for SDR

You can use the Domain Reputation rule to filter messages based on SDR, and take appropriate actions on such messages:

- Sender Domain Verdict
- Sender Domain Age
- Sender Domain Unscannable

### Filtering Messages based on Sender Domain Verdict



---

**Note** The recommended blocking threshold is "Poor." For more information about SDR, contact Cisco Talos at <https://www.talosintelligence.com>.

---

#### Syntax:

```
drop_msg_based_on_sdr_verdict:
if sdr-reputation (['awful', 'poor'], "<domain_exception_list>")
{drop();}
```

#### Where:

- 'drop\_msg\_based\_on\_sdr\_verdict' is the name of the message filter.
- 'sdr-reputation' is the Domain Reputation message filter rule.
- 'awful', 'poor' is the range of the sender domain verdict used to filter messages based on SDR.
- 'domain\_exception\_list' is the name of a domain exception list. If a domain exception list is not present it is displayed as "".
- 'drop' is the action applied on the message.

### Example

In the following message, if the SDR verdict is 'Unknownr', the message is quarantined.

```
quarantine_unknown_sdr_verdicts:
if sdr-reputation (['unknown'], "")
{quarantine("Policy")}
```

## Filtering Messages based on Sender Domain Age



**Note** The Sender Domain Age option will be removed in the next AsyncOS release.

### Syntax:

```
<msg_filter_name>
if sdr-age (<'unit'>, <'operator'> <'actual value'>)
{<action>}
```

### Where:

- 'sdr-reputation' is the Domain Reputation message filter rule.
- 'sdr\_age' is the age of the sender domain used to filter messages based on SDR.
- 'unit' is the number of 'days,' 'years,' 'months,' or 'weeks' option used to filter messages based on the sender domain age.
- 'operator' are the following comparison operators used to filter messages based on the sender domain age:
  - -> (Greater than)
  - ->= (Greater than or equal to)
  - -< (Lesser than)
  - -<= (Lesser than or equal to)
  - -== (Equal to)
  - -!= (Not equal to)
  - - Unknown
- 'actual value' is the number used to filter messages based on the sender domain age.

### Examples

In the following message, if the age of the sender domain is unknown, the message is dropped.

```
Drop_Messages_Based_On_SDR_Age: if (sdr-age ("unknown", "")) {drop();}
```

In the following message, if the age of the sender domain is less than one month, the message is dropped.

```
Drop_Messages_Based_On_SDR_Age: if (sdr-age ("months", <, 1, "")) { drop(); }
```

## Filtering Messages based on Sender Domain Unscannable

### Syntax:

```
<msg_filter_name>
if sdr-unscannable (<'domain_exception_list'>)
{<action>}
```

### Where:

- 'sdr-unscannable' is the Domain Reputation message filter rule.

'domain\_exception\_list' is the name of a domain exception list. If a domain exception list is not present it is displayed as "".

### Example

In the following message, if the message failed the SDR check, the message is quarantined.

```
Quarantine_Messages_Based_On_Sender_Domain_Unscannable: if (sdr-unscannable (""))
{quarantine("Policy");}
```

## Message Filter Actions

The purpose of message filters is to perform actions on selected messages.

The two types of actions are:

- *Final* actions — such as deliver , drop , and bounce — end the processing of a message, and permit no further processing through subsequent filters.
- *Non-final* actions perform an action which permits the message to be processed further.



**Note** Non-final message filter actions are cumulative. If a message matches multiple filters where each filter specifies a different action, then all actions are accumulated and enforced. However, if a message matches multiple filters specifying the same action, the prior actions are overridden and the final filter action is enforced.

### Related Topics

- [Filter Actions Summary Table, on page 183](#)
- [Action Variables, on page 192](#)
- [Matched Content Visibility, on page 194](#)
- [Description and Examples of Message Filter Actions, on page 195](#)

## Filter Actions Summary Table

Message filters can apply the following actions to an email message as shown in the following table:

**Table 24: Message Filter Actions**

Action	Syntax	Description
Alter source host	alt-src-host	Change the source hostname and IP interface (Virtual Gateway address) to send the message. See <a href="#">Alter Source Host (Virtual Gateway address) Action, on page 204</a> .
Alter recipient	alt-rcpt-to	Change a recipient of the message. See <a href="#">Alter Recipient Action, on page 203</a> .

## Filter Actions Summary Table

Action	Syntax	Description
Alter mailhost	alt-mailhost	Change the destination mail host for the message. See <a href="#">Alter Delivery Host Action</a> , on page 203.
Notify	notify	Report this message to another recipient. See <a href="#">Notify and Notify-Copy Actions</a> , on page 198.
Notify Copy	notify-copy	Perform just like the notify action, but also sends a copy as with the bcc-scan action. See <a href="#">Notify and Notify-Copy Actions</a> , on page 198.
Blind carbon copy	bcc	Copy this message (message replication) anonymously to another recipient. See <a href="#">Blind Carbon Copy Actions</a> , on page 200.
Blind carbon copy with scan	bcc-scan	Copy this message anonymously to another recipient, and process that message through the work queue as if it were a new message. See <a href="#">Blind Carbon Copy Actions</a> , on page 200.
Archive	archive	Archive this message into an mbox-format file. See <a href="#">Archive Action</a> , on page 204.
Quarantine	quarantine ( <i>quarantine_name</i> )	Flag this message to be sent to the quarantine named <i>quarantine_name</i> . See <a href="#">Quarantine and Duplicate Actions</a> , on page 202.
Duplicate (Quarantine)	duplicate-quarantine ( <i>quarantine_name</i> )	Send a copy of the message to the specified quarantine. See <a href="#">Quarantine and Duplicate Actions</a> , on page 202.
Remove headers	strip-header	Remove specified headers from the message before delivering. See <a href="#">Strip Header Action</a> , on page 205.
Insert headers	insert-header	Insert a header and value pair into the message before delivering. See <a href="#">Insert Header Action</a> , on page 205.
Edit header text	edit-header-text	Replace specified header text with a text string you specify in the filter condition. See <a href="#">Edit Header Text Action</a> , on page 206.



Action	Syntax	Description
Edit body text	edit-body-text()	Strip a regular expression from a message body and replaces it with text that you specify. You might want to use this filter if you want to remove and replace specific content, such as a URL within a message body. See <a href="#">Edit Body Text Action, on page 206</a> .
Convert HTML	html-convert()	Strip HTML tags from message bodies and leaves the plain text content of the message. You might want to use this filter if you want to convert all HTML text in a message to plain text. <a href="#">HTML Convert Action, on page 207</a> .
Assign bounce profile	bounce-profile	Assign a specific bounce profile to the message. See <a href="#">Bounce Profile Action, on page 208</a> .
Bypass Anti-Spam System	skip-spamcheck	Ensure that the anti-spam systems in the Cisco system are <i>not</i> applied to this message. See <a href="#">Bypass Anti-Spam System Action, on page 208</a> .
Bypass Graymail Actions	skip-marketingcheck	Bypass actions on marketing emails. See <a href="#">Bypassing Graymail Actions, on page 209</a> .
	skip-socialcheck	Bypass actions on social network emails. See <a href="#">Bypassing Graymail Actions, on page 209</a> .
	skip-bulkcheck	Bypass actions on bulk emails. See <a href="#">Bypassing Graymail Actions, on page 209</a> .
Bypass Anti-Virus System	skip-viruscheck	Ensure that the anti-virus systems in the Cisco system are <i>not</i> applied to this message. See <a href="#">Bypass Anti-Virus System Action, on page 209</a> .
Bypass File Reputation Filtering and File Analysis	skip-ampcheck	Ensure that File Reputation Filtering and File Analysis are <i>not</i> applied to this message. See <a href="#">Bypass File Reputation Filtering and File Analysis System Actions, on page 210</a> .
Skip Outbreak Filter Scanning	skip-vofcheck	Ensure that this message is not processed by the Outbreak Filters scanning. See <a href="#">Bypass Anti-Virus System Action, on page 209</a> .

## Filter Actions Summary Table

Action	Syntax	Description
Drop Attachments by Name	<code>drop-attachments-by-name</code>	Drop all attachments on messages that have a filename that match the given regular expression. Archive file attachments (zip, tar), Microsoft Office attachments (doc, docx), and Email attachments (winmail.dat) will be dropped if they contain a file that matches. See <a href="#">Examples of Attachment Scanning Message Filters, on page 221</a> .
Drop Attachments by Type	<code>drop-attachments-by-type</code>	Drop all attachments on messages that have a MIME type, determined by either the given MIME type or the file extension. Archive file attachments (zip, tar) will be dropped if they contain a file that matches. See <a href="#">Examples of Attachment Scanning Message Filters, on page 221</a> .
Drop Attachments by File Type	<code>drop-attachments-by-filetype</code>	Drop all attachments on messages that match the given “fingerprint” of the file. Archive file attachments (zip, tar) will be dropped if they contain a file that matches. For more information, see <a href="#">Examples of Attachment Scanning Message Filters, on page 221</a> .
Drop Attachments by MIME Type	<code>drop-attachments-by-mimetype</code>	Drop all attachments on messages that have a given MIME type. This action does not attempt to ascertain the MIME type by file extension and so it also does not examine the contents of archives. See <a href="#">Examples of Attachment Scanning Message Filters, on page 221</a> .
Drop Attachments based on File Hash List	<code>drop-attachments-by-hash</code>	Drop all message attachments in messages that match the specific file SHA-256 value in the file hash list. See <a href="#">Drop Message Attachments that match File SHA-256 Filter, on page 247</a> and <a href="#">Drop Messages if Attachment matches File SHA-256 Filter, on page 247</a> .
Drop Attachments by Size	<code>drop-attachments-by-size</code>	Drop all attachments on the message that, in raw encoded form, are equal to or greater than the size (in bytes) given. Note that for archive or compressed files, this action does not examine the uncompressed size, but rather the size of the actual attachment prior to any decoding. See <a href="#">Examples of Attachment Scanning Message Filters, on page 221</a> .

Action	Syntax	Description
Drop Attachments by Content	<code>drop-attachments-where-contains</code>	<p>Drop all attachments on message that contain the regular expression. Does the pattern occur the minimum number of times you specified for the threshold value? Archive files (zip, tar) will be dropped if any of the files they contain match the regular expression pattern. See <a href="#">Examples of Attachment Scanning Message Filters, on page 221</a>.</p> <p>The optional comment serves as the means to modify the text used to replace the attachment that was dropped. Attachment footers simply append to the message.</p>
Drop Attachments with Macro	<code>drop-macro-enabled-attachments</code>	<p>Drops all macro-enabled attachments of the specified file type.</p> <p><b>Note</b> If an archive or embedded file contains macros, the parent file is dropped from the message.</p> <p><b>Syntax</b></p> <pre>drop-macro-enabled-attachments (['file_type-1', 'file_type-2', ..., 'file_type-n'], "custom_replacement_message")</pre> <p>Where:</p> <ul style="list-style-type: none"> <li>• <code>file_type</code> can be any one of the following supported file types: <ul style="list-style-type: none"> <li>• Adobe Portable Document Format</li> <li>• Microsoft Office Files</li> <li>• OLE File types</li> </ul> </li> <li>• <b>custom replacement</b> message is an optional message to replace the default system generated message added to the bottom of the message body when an attachment is dropped.</li> </ul> <p>See <a href="#">Macro Detection Rule, on page 178</a></p>

## Filter Actions Summary Table

Action	Syntax	Description
Drop Attachments by Dictionary Matches	<code>drop-attachments-where-dictionary-match</code>	Strip attachments based on matches to dictionary terms. If the terms in the MIME parts considered to be an attachment match a dictionary term (and the user-defined threshold is met), the attachment is stripped from the email. See <a href="#">Examples of Attachment Scanning Message Filters, on page 221</a> .
Add Footer	<code>add-footer (Footer-name)</code>	Add disclaimer text as a footer to the message. See “Message Disclaimer Stamping” in the “Text Resources” chapter for more information.
Add Heading	<code>add-heading (heading-name)</code>	Add disclaimer text as a heading to the message. See “Message Disclaimer Stamping” in the “Text Resources” chapter for more information.
Encrypt on Delivery	<code>encrypt-deferred</code>	Encrypt message on delivery, which means that the message continues to the next stage of processing, and when all processing is complete, the message is encrypted and delivered.
S/MIME Sign/Encrypt on Delivery	<code>smime-gateway-deferred (“sending_profile”)</code>	Performs an S/MIME signing or encryption of the message using the specified sending profile during the delivery. See <a href="#">S/MIME Sign or Encrypt on Delivery Action, on page 197</a> .
S/MIME Sign/Encrypt	<code>smime-gateway (“sending_profile”)</code>	Performs an S/MIME signing or encryption using the specified sending profile and delivers the message, skipping any further processing. See <a href="#">S/MIME Sign or Encrypt Action, on page 197</a> .
Add Message Tag	<code>tag-message (tag-name)</code>	Add a custom term into the message to use with DLP policy filtering. You can configure a DLP policy to limit scanning to messages with the message tag. The message tag is not visible to recipients. See <a href="#">Add Message Tag Action, on page 210</a> and the “Data Loss Prevention” chapter.
Add Log Entry	<code>log-entry</code>	Adds customized text into the Text Mail logs at the INFO level. The text can include action variables. The log entry appears in message tracking. For more information, see <a href="#">Add Log Entry Action, on page 211</a> .

Action	Syntax	Description
Replace URL with text, based on URL reputation	<ul style="list-style-type: none"> <li>• url-reputation-replace</li> <li>• url-no-reputation-replace</li> </ul>	Modify URLs or their behavior based on the reputation of the URL.
Defang URL based on URL reputation	<ul style="list-style-type: none"> <li>• url-reputation-defang</li> <li>• url-no-reputation-defang</li> </ul>	Use a separate action to handle the case in which the reputation service does not provide a score for a URL.
Redirect URL to a Cisco security proxy, based on URL reputation	<ul style="list-style-type: none"> <li>• url-reputation-proxy-redirect</li> <li>• url-no-reputation-proxy-redirect</li> </ul>	See <a href="#">URL Reputation Actions</a> , on page 211.
Replace URL with text, based on URL Category	url-category-replace	Modify URLs or their behavior based on the category of the URL.
Defang URL based on URL category	url-category-defang	See <a href="#">URL Category Actions</a> , on page 213.
Redirect URL to Cisco security proxy, based on URL category	url-category-proxy-redirect	
Forged Email Detection	fed	Strips the From: header from the forged message and replaces it with the Envelope Sender. See <a href="#">Forged Email Detection Action</a> , on page 214.
No Operation	no-op	No action is performed. See <a href="#">No Operation</a> , on page 214.
*Skip Remaining Message Filters	skip-filters	Ensure that this message is not processed by any other message filters and continues through the email pipeline. See <a href="#">Skip Remaining Message Filters Action</a> , on page 196.
*Drop message	drop	Drop and discard the message. See <a href="#">Drop Action</a> , on page 196.
*Bounce message	bounce	Send the message back to the sender. See <a href="#">Bounce Action</a> , on page 197.
*Encrypt and Deliver Now	encrypt	Use Cisco Email Encryption to encrypt outgoing messages. See <a href="#">Encrypt Action</a> , on page 197.
* <i>Final Actions</i>		

## Related Topics

- [Attachment Groups, on page 190](#)

## Attachment Groups

You can specify a particular file type (“exe” files for example) or common groups of attachments in the `attachment-filetype` and `drop-attachments-by-filetype` rules. AsyncOS divides the attachments into the groups listed in the following table.

If you create a message filter that uses the `!=` operator to match a message that does not contain an attachment with a specific file type, the filter will not perform any action on the message if there is at least one attachment with the file type you want to filter out. For example, the following filter drops any message with an attachment that is not an `.exe` file type:

```
exe_check: if (attachment-filetype != "exe") {
drop();
}
```

If a message has multiple attachments, the email gateway does not drop the message if at least one of the attachments is an `.exe` file, even if the other attachments not `.exe` files.

**Table 25: Attachment Groups**

Attachment Group Name	Scanned File Types
Document	<ul style="list-style-type: none"> <li>• doc</li> <li>• docx</li> <li>• mdb</li> <li>• mpp</li> <li>• ole</li> <li>• pdf</li> <li>• ppt</li> <li>• pptx</li> <li>• rtf</li> <li>• wps</li> <li>• x-wmf</li> <li>• xls</li> <li>• xlsx</li> </ul>
Executable	<ul style="list-style-type: none"> <li>• exe</li> <li>• java</li> <li>• msi</li> <li>• pif</li> </ul> <p><b>Note</b> Filtering the Executable group will also scan <code>.dll</code> and <code>.scr</code> files, but you cannot filter these file types individually.</p>

Attachment Group Name	Scanned File Types
Compressed	<ul style="list-style-type: none"> <li>• ace (ACE Archiver compressed file)</li> <li>• arc (SQUASH Compressed archive)</li> <li>• arj (Robert Jung ARJ compressed archive)</li> <li>• binhex</li> <li>• bz (Bzip compressed file)</li> <li>• bz2 (Bzip compressed file)</li> <li>• cab (Microsoft cabinet file)</li> <li>• gzip* (Compressed file - UNIX gzip)</li> <li>• lha (Compressed Archive [LHA/LHARC/LZH])</li> <li>• rar (Compressed archive)</li> <li>• sit (Compressed archive - Macintosh file [Stuffit])</li> <li>• tar* (Compressed archive)</li> <li>• unix (UNIX compress file)</li> <li>• zip* (Compressed archive - Windows)</li> <li>• zoo (ZOO Compressed Archive File)</li> </ul> <p>* These file types can be “body-scanned”</p>
Text	<ul style="list-style-type: none"> <li>• txt</li> <li>• html</li> <li>• xml</li> </ul>
Image	<ul style="list-style-type: none"> <li>• bmp</li> <li>• cur</li> <li>• gif</li> <li>• ico</li> <li>• jpeg</li> <li>• pcx</li> <li>• png</li> <li>• psd</li> <li>• psp</li> <li>• tga</li> <li>• tiff</li> </ul>

Attachment Group Name	Scanned File Types
Media	<ul style="list-style-type: none"> <li>• aac</li> <li>• aiff</li> <li>• asf</li> <li>• avi</li> <li>• flash</li> <li>• midi</li> <li>• mov</li> <li>• mp3</li> <li>• mpeg</li> <li>• ogg</li> <li>• ram</li> <li>• snd</li> <li>• wav</li> <li>• wma</li> <li>• wmv</li> </ul>

## Action Variables

The `bcc()` , `bcc-scan()` , `notify()` , `notify-copy()` , `add-footer()` , `add-heading()` , and `insert-headers()` actions have parameters that may use certain variables that will be automatically replaced with information from the original message when the action is executed. These special variables are called *action variables*. Your email gateway supports the following set of action variables:

**Table 26: Message Filter Action Variables**

Variable	Syntax	Description
All Headers	<code>\$AllHeaders</code>	Returns the message headers.
Body Size	<code>\$BodySize</code>	Returns the size, in bytes, of the message.
Certificate Signers	<code>\$CertificateSigners</code>	Returns the signers from the <code>subjectAltName</code> element of a signing certificate. See <a href="#">\$CertificateSigners Action Variable, on page 172</a> for more information.
Date	<code>\$Date</code>	Returns the current date, using the format MM/DD/YYYY.
Dropped File Name	<code>\$dropped_filename</code>	Returns only the most recently dropped filename.
Dropped File Names	<code>\$dropped_filenames</code>	Displays list of dropped files (similar to <code>\$filenames</code> ).
Dropped File Types	<code>\$dropped_filetypes</code>	Displays list of dropped file types (similar to <code>\$filetypes</code> ).
Envelope Sender	<code>\$EnvelopeFrom</code>	Returns the Envelope Sender (Envelope From, <MAIL FROM>) of the message.



Variable	Syntax	Description
Envelope Recipients	<code>\$EnvelopeRecipients</code>	Returns all Envelope Recipients (Envelope To, <RCPT TO>) of the message.
File Names	<code>\$filenames</code>	Returns a comma-separated list of the message's attachments' filenames.
File Sizes	<code>\$filesizes</code>	Returns a comma-separated list of the message's attachments' file sizes.
File Types	<code>\$filetypes</code>	Returns a comma-separated list of the message's attachments' file types.
Filter Name	<code>\$FilterName</code>	Returns the name of the filter being processed.
GMTimeStamp	<code>\$GMTimeStamp</code>	Returns the current time and date, as would be found in the Received: line of an email message, using GMT.
HAT Group Name	<code>\$Group</code>	Returns the name of the sender group the sender matched on when injecting the message. If the sender group had no name, the string ">Unknown<" is inserted.
Matched Content	<code>\$MatchedContent</code>	Returns the content that triggered a scanning filter rule (including filter rules such as body-contains and content dictionaries).
Mail Flow Policy	<code>\$Policy</code>	Returns the name of the HAT policy applied to the sender when injecting the message. If no predefined policy name was used, the string ">Unknown<" is inserted.
Header	<code>\$Header['string']</code>	Returns the value of the quoted header, if the original message contains a matching header. Note that double quotes may also be used.
Hostname	<code>\$Hostname</code>	Returns the hostname of the email gateway.
Internal Message ID	<code>\$MID</code>	Returns the Message ID, or "MID" used internally to identify the message. Not to be confused with the RFC822 "Message-Id" value (use \$Header to retrieve that).
Receiving Listener	<code>\$RecvListener</code>	Replaced by the nickname of the listener that received the message.
Receiving Interface	<code>\$RecvInt</code>	Returns the nickname of the interface that received the message.
Remote IP Address	<code>\$RemoteIP</code>	Returns the IP address of the system that sent the message to the email gateway.
Remote Host Address	<code>\$remotehost</code>	Returns the hostname of the system that sent the message to the email gateway.

Variable	Syntax	Description
IP Reputation Score	<code>\$Reputation</code>	Returns the IP Reputation score of the sender. If there is no reputation score, it is replaced with “None”.
Subject	<code>\$Subject</code>	Returns the subject of the message.
Time	<code>\$Time</code>	Returns the current time, in the local time zone.
Timestamp	<code>\$Timestamp</code>	Returns the current time and date, as would be found in the Received: line of an email message, in the local time zone.

### Related Topics

- [Non-ASCII Character Sets and Message Filter Action Variables, on page 194](#)

## Non-ASCII Character Sets and Message Filter Action Variables

The system supports the expansion of action variables that contain ISO-2022 style character codings (the style of encoding used in header values) and also supports international text in the notification. These will be merged together to generate a notification that will then be sent as a UTF-8, quoted printable message.

## Matched Content Visibility

When you configure a quarantine action for messages that match Attachment Content conditions, Message Body or Attachment conditions, Message body conditions, or the Attachment content conditions, you can view the matched content in the quarantined message. When you display the message body, the matched content is highlighted in yellow. You can also use the `$MatchedContent` action variable to include the matched content in the message subject.

When you view messages in the local quarantine that have triggered message or content filter rules, the GUI may display content that did not actually trigger the filter action (along with content that triggered the filter action). The GUI display should be used as a guideline for locating content matches, but does not necessarily reflect an exact list of content matches. This occurs because the GUI uses less strict content matching logic than is used in the filters. This issue applies only to the highlighting in the message body. The table that lists the matched strings in each part of the message along with the associated filter rule is correct.

Figure 17: Matched Content Viewed in the Policy Quarantine

The screenshot shows a web interface for viewing matched content in a policy quarantine. The interface is divided into several sections:

- Matched Content:** A table with columns for Attachment Name, Matched Content, and Condition. The attachment 'FP1.1.txt' is listed with a list of email addresses and a condition of 'DLP Classifier: Contact Information'.
- Headers:** A text area displaying email headers such as 'X-IronPort-AV: E=Sophos;...', 'Received: from d2.vmw023-bsd04.ibqa...', and 'Subject: DLPTTEST'.
- Message:** A text area containing the word 'Test'.
- Message Parts:** A table listing the parts of the message, including '[message body]' and 'FP1.1.txt'.

Attachment Name	Matched Content	Condition
FP1.1.txt	<ul style="list-style-type: none"> <li>MS 38930 USA Facilities 662-646-0523 jsamuelson@acmecorp.com 7/17/06</li> <li>4929132070312710 Acme Corp Irene Gibbs 808 Sumner Street Greenwood</li> <li>MS 38930 USA Publishing 662-646-0522 igibbs@acmecorp.com 2/1/07</li> <li>4485231592071860 Acme Corp Kathy Lopez 808 Sumner Street</li> <li>Greenwood MS 38930 USA Marketing 662-646-0541 klopez@acmecorp.com</li> <li>2/1/07 4716298862510192 Acme Corp Marty Smith 808 Sumner Street</li> <li>Greenwood MS 38930 USA Engineering 662-646-0542</li> </ul>	DLP Classifier: Contact Information

Name	Size	Details
[message body]	6	ASCII text, with CRLF line terminators
FP1.1.txt	1K	ASCII text

## Description and Examples of Message Filter Actions

The following section describes the various message filter actions in use and their examples.

- [Skip Remaining Message Filters Action, on page 196](#)
- [Drop Action, on page 196](#)
- [Bounce Action, on page 197](#)
- [Encrypt Action, on page 197](#)
- [Notify and Notify-Copy Actions, on page 198](#)
- [Blind Carbon Copy Actions, on page 200](#)
- [Quarantine and Duplicate Actions, on page 202](#)
- [Alter Recipient Action, on page 203](#)
- [Alter Delivery Host Action, on page 203](#)
- [Alter Source Host \(Virtual Gateway address\) Action, on page 204](#)
- [Archive Action, on page 204](#)
- [Strip Header Action, on page 205](#)
- [Insert Header Action, on page 205](#)
- [Edit Header Text Action, on page 206](#)
- [Edit Body Text Action, on page 206](#)
- [HTML Convert Action, on page 207](#)
- [Bounce Profile Action, on page 208](#)

- [Bypass Anti-Spam System Action](#), on page 208
- [Bypassing Graymail Actions](#), on page 209
- [Bypass Anti-Virus System Action](#), on page 209
- [Bypass File Reputation Filtering and File Analysis System Actions](#), on page 210
- [Bypass Anti-Virus System Action](#), on page 209
- [Add Message Tag Action](#), on page 210
- [Add Log Entry Action](#), on page 211
- [URL Reputation Actions](#), on page 211
- [URL Category Actions](#), on page 213
- [No Operation](#), on page 214
- [Forged Email Detection Action](#), on page 214

## Skip Remaining Message Filters Action

The `skip-filters` action ensures that the message skips any further processing from message filters and continues through the email pipeline. The message that incurs the `skip-filters` action will be subject to anti-spam scanning and anti-virus scanning, if it is available on the email gateway. The `skip-filters` action is the default final action for message filters.

The following filter notifies `customercare@example.com` and then immediately delivers any message addressed to `boss@admin`.

```
bossFilter:
if(rcpt-to == 'boss@admin$')
{
notify('customercare@example.com');
skip-filters();
}
```

## Drop Action

The `drop` action discards a message without any delivery. The message is not returned to the sender, not sent to the intended recipient, nor processed further in any way.

The following filter first notifies `george@whitehouse.gov` and then discards any message where the subject begins with `SPAM`.

```
spamFilter:
if(subject == '^SPAM.*')
{
notify('george@whitehouse.gov');
drop();
}
```

## Bounce Action

The `bounce` action sends the message back to the sender (Envelope Sender) without further processing. The following filter returns (bounces) any message from an email address that ends in `@yahoo\\.com`.

```
yahooFilter:
if(mail-from == '@yahoo\\.com$')
{
bounce();
}
```

## Encrypt Action

The `encrypt` action uses the configured encryption profile to deliver encrypted messages to email recipients. The following filter encrypts messages if they contain the term `[encrypt]` in the subject:

```
Encrypt_Filter:
if ( subject == '\\[encrypt\\]' )
{
encrypt('My_Encryption_Profile');
}
```



---

**Note** You must have a Cisco Encryption Appliance in your network or a hosted key service configured to use this filter action. You must also have configured an encryption profile to use this filter action.

---

## S/MIME Sign or Encrypt on Delivery Action

The `smime-gateway-deferred` action performs an S/MIME signing or encryption of the message using the specified sending profile during the delivery. This means that the message continues to the next stage of processing, and when all processing is complete, the message is signed or encrypted and delivered.

The following filter performs an S/MIME encryption on all the outgoing messages from a particular sender during the delivery:

```
smime-deferred:if(mail-from == "user@example.com"){smime-gateway-deferred("smime-encrypt");}
```

## S/MIME Sign or Encrypt Action

The `smime-gateway` action performs an S/MIME signing or encryption using the specified sending profile and delivers the message, skipping any further processing.

The following filter performs an S/MIME signing on all the outgoing messages from a particular sender and delivers them immediately:

```
smime-deliver-now:if(mail-from == "user@example.com"){smime-gateway("smime-sign");}
```

## Notify and Notify-Copy Actions

The `notify` and `notify-copy` actions send an email summary of the message to the specified email address. The `notify-copy` action also sends a copy of the original message, similar to the `bcc-scan` action. The notification summary contains:

- The contents of the Envelope Sender and Envelope Recipient (`MAIL FROM` and `RCPT TO`) directives from the mail transfer protocol conversation for the message.
- The message headers of the message.
- The name of the message filter that matched the message.

You can specify the recipient, subject line, from address, and notification template. the following filter selects messages with sizes larger than 4 megabytes, sends a notification email of each matching message to `admin@example.com`, and finally discards the message:

```
bigFilter:
if(body-size >= 4M)
{
notify('admin@example.com');
drop();
}
```

Or

```
bigFilterCopy:
if(body-size >= 4M)
{
notify-copy('admin@example.com');
drop();
}
```

The Envelope Recipient parameter may be any valid email address (for example, `admin@example.com` in the example above), or alternatively, may be the action variable `$EnvelopeRecipients` (see [Action Variables, on page 192](#)), which specifies all Envelope Recipients of the message:

```
bigFilter:
if(body-size >= 4M)
{
notify('$EnvelopeRecipients');
drop();
}
```

```
}

```

The `notify` action also supports up to three additional, optional arguments that allow you to specify the subject header, the Envelope Sender, and a pre-defined text resource to use for the notification message. These parameters must appear in order, so a subject must be provided if the Envelope Sender is to be set or a notification template specified.

The subject parameter may contain action variables (see [Action Variables, on page 192](#)) that will be replaced with data from the original message. By default, the subject is set to `Message Notification`.

The Envelope Sender parameter may be any valid email address, or alternatively, may be the action variable `$(EnvelopeFrom)`, which will set the return path of the message to the same as the original message

The notification template parameter is the name of an existing notification template. For more information, see [Notifications, on page 221](#).

This example extends the previous one, but changes the subject to look like `[bigFilter] Message too large`, sets the return path to be the original sender, and uses the “message.too.large” template:

```
bigFilter:
if (body-size >= 4M)
{
notify('admin@example.com', '[$FilterName] Message too large',
'$EnvelopeFrom', 'message.too.large');
drop();
}

```

You can also use the `$(MatchedContent)` action variable to notify senders or administrators that a content filter was triggered. The `$(MatchedContent)` action variable displays the content that triggered the filter. For example, the following filter sends a notification to an administrator if the email contains ABA account information.

```
ABA_filter:
if (body-contains ('*aba')){
notify('admin@example.com', '[$MatchedContent]Account Information Displayed');
}

```

## Related Topics

- [Notification Template, on page 199](#)

## Notification Template

You can use the [Text Resources](#) page or the `textconfig` CLI command to configure custom notification templates as text resources for use with the `notify()` and `notify-copy()` actions. If you do not create a custom notification template, a default template is used. The default template includes message headers, but the custom notification template does not include message headers by default. To include message headers in the custom notification, include the `$(AllHeaders)` action variable.

For more information, see the “Text Resources” chapter.

In the following example, when a large message triggers the filter shown below, an email is sent to the intended recipients explaining that the message was too large:

```
bigFilter:
if (body-size >= 4M)
{
notify('$EnvelopeRecipients', '[${FilterName}] Message too large',
'$EnvelopeFrom', 'message.too.large');
drop();
}
```

## Blind Carbon Copy Actions

The `bcc` action sends an anonymous copy of the message to a specified recipient. This is sometimes referred to as message replication. Because no mention of the copy is made in the original message and the anonymous copy will never successfully bounce back to the recipient, the original sender and recipients of the message will not necessarily know that the copy was sent.

The following filter sends a blind carbon copy to `mom@home.org` for each message addressed to sue from johnny :

```
momFilter:
if ((mail-from == '^johnny$') and (rcpt-to == '^sue$'))
{
bcc('mom@home.org');
}
```

The `bcc` action also supports up to three additional, optional arguments that allow you to specify the subject header and Envelope Sender to use on the copied message, as well as an alt-mailhost. These parameters must appear in order, so a subject must be provided if the Envelope Sender is to be set.

The subject parameter may contain action variables (see [Action Variables, on page 192](#)) that will be replaced with data from the original message. By default, this is set to the subject of the original message (the equivalent of `Subject`).

The Envelope Sender parameter may be any valid email address, or alternatively, may be the action variable `$EnvelopeFrom`, which will set the return path of the message to the same as the original message.

This example expands the previous one by setting the subject to be `[Bcc] <original subject>`, and the return path set to `badbounce@home.org`:

```
momFilter:
if ((mail-from == '^johnny$') and (rcpt-to == '^sue$'))
```



```
{
  bcc('mom@home.org', '[Bcc] $Subject', 'badbounce@home.org');
}
```

The alt-mailhost is the fourth parameter:

```
momFilterAltM:
if ((mail-from == '^johnny$') and (rcpt-to == '^sue$'))
{
  bcc('mom@home.org', '[Bcc] $Subject', '$EnvelopeFrom',
    'momaltmailserver.example.com');
}
```



---

**Caution** The `Bcc()`, `notify()`, and `bounce()` filter actions can allow viruses through your network. The blind carbon copy filter action creates a new message which is a full copy of the original message. The notify filter action creates a new message that contains the headers of the original message. While it is rare, headers can contain viruses. The bounce filter action creates a new message which contains the first 10k of the original message. In all three cases, the new message will not be processed by anti-virus or anti-spam scanning.

---

To send to multiple hosts, you can call the `bcc()` action multiple times:

```
multiplealthosts:
if (recv-listener == "IncomingMail")
{
  insert-header('X-ORIGINAL-IP', '$remote_ip');
  bcc ('$EnvelopeRecipients', '$Subject', '$EnvelopeFrom', '10.2.3.4');
  bcc ('$EnvelopeRecipients', '$Subject', '$EnvelopeFrom', '10.2.3.5');
  bcc ('$EnvelopeRecipients', '$Subject', '$EnvelopeFrom', '10.2.3.6');
}
```

### Related Topics

- [BCC and Scan Mail Sent to Competitors, on page 241](#)

### The bcc-scan() Action

The `bcc-scan` action functions similarly to the `bcc` action, except that the message that is sent is treated as a brand new message and is therefore sent through the entire email pipeline.

```

momFilter:

if ((mail-from == '^johnny$') and (rcpt-to == '^sue$'))
{

bcc-scan('mom@home.org');

}

```

## Quarantine and Duplicate Actions

The `quarantine('quarantine_name')` action flags a message for inclusion into a queue called a quarantine. For more information about quarantines, see the “Quarantines” chapter. The `duplicate-quarantine('quarantine_name')` action immediately places a copy of the message into the specified quarantine and the original message continues through the email pipeline. The quarantine name is case sensitive.

When flagged for quarantine, the message continues through the rest of the email pipeline. When the message reaches the end of the pipeline, if the message has been flagged for one or more quarantines then it enters those queues. Otherwise, it is delivered. Note that if the message does not reach the end of the pipeline, it is not placed in a quarantine.

Accordingly, if a message filter contains a `quarantine()` action followed by a `bounce()` or `drop()` action, the message will not enter the quarantine, since the final action prevents the message from reaching the end of the pipeline. The same is true if a message filter includes a quarantine action, but the message is later dropped by anti-spam or anti-virus scanning, or a content filter. The `skip-filters()` action causes the message to skip any remaining message filters, but content filters may still apply. For example, if a message filter flags a message for quarantine and also includes the `skip-filters()` action, the message skips all remaining message filters and will be quarantined, unless another action in the email pipeline causes the message to be dropped.

In the following example, the message is sent to the Policy quarantine if the message contains any words within the dictionary named “secret\_word.”

```

quarantine_codenames:

if (dictionary-match('secret_words'))
{

quarantine('Policy');

}

```

In the following example, suppose a company has an official policy to drop all .mp3 file attachments. If an inbound message has a .mp3 attachment, the attachment is stripped and the remaining message (original body and remaining attachments) is sent to the original recipient. Another copy of the original message with all attachments will be quarantined (sent to the Policy quarantine). If it is necessary to receive the blocked attachment(s), the original recipient would then request that the message be released from the quarantine.

```

strip_all_mp3s:

if (attachment-filename == '(?i)\\.mp3$') {

duplicate-quarantine('Policy');

}

```

```
drop-attachments-by-name('( ?i)\\.mp3$');
}
```

## Alter Recipient Action

The `alt-rcpt-to` action changes all recipients of the message to the specified recipient upon delivery.

The following filter sends all messages with an Envelope Recipient address that contain `.freelist.com` and changes all recipients for the message to `system-lists@myhost.com`:

```
freelistFilter:
if(rcpt-to == '\\.freelist\\.com$')
{
alt-rcpt-to('system-lists@myhost.com');
}
```

## Alter Delivery Host Action

The `alt-mailhost` action changes the IP address for all recipients of the selected message to the numeric IP address or hostname given.



---

**Note** The `alt-mailhost` action prevents a message classified as spam by an anti-spam scanning engine from being quarantined. The `alt-mailhost` action overrides the `quarantine` action and sends it to the specified mail host.

---

The following filter redirects recipient addresses to the host `example.com` for all messages.

```
localRedirectFilter:
if(true)
{
alt-mailhost('example.com');
}
```

Thus, a message directed to `joe@anywhere.com` is delivered to the mailhost at `example.com` with the Envelope To address `joe@anywhere.com`. Note that any additional routing information specified by the `smtproutes` command still affects the routing of the message. (See [Routing Email for Local Domains](#), on page 693.)



---

**Note** The `alt-mailhost` action does not support specifying a port number. To do this, add an SMTP route instead.

---

The following filter redirects all messages to 192.168.12.5 :

```
local2Filter:
if(true)
{
alt-mailhost('192.168.12.5');
}
```

## Alter Source Host (Virtual Gateway address) Action

The `alt-src-host` action changes the source host for the message to the source specified. The source host consists of the IP interface or group of IP interfaces that the messages should be delivered from. If a group of IP interfaces is selected, the system round-robins through all of the IP interfaces within the group as the source interface when delivering email. In essence, this allows multiple Virtual Gateway addresses to be created on a single email gateway. For more information, see [Configuring Mail Gateways for all Hosted Domains Using Virtual Gateway™ Technology, on page 745](#).

The IP interface may only be changed to an IP interface or interface group currently configured in the system. the following filter creates a Virtual Gateway using the outbound (delivery) IP interface `outbound2` for all messages received from a remote host with the IP address 1.2.3.4 .

```
externalFilter:
if(remote-ip == '1.2.3.4')
{
alt-src-host('outbound2');
}
```

The following filter uses the IP interface group `Group1` for all messages received from a remote host with the IP address 1.2.3.4 .

```
groupFilter:
if(remote-ip == '1.2.3.4')
{
alt-src-host('Group1');
}
```

## Archive Action

The `archive` action saves a copy of the original message, including all message headers and recipients into an mbox-format file on the email gateway. The action takes a parameter that is the name of the log file in which to save the message. The system automatically creates a log subscription with the specified filename when you create the filter, or you can also specify an existing filter log file. After the filter and the filter log file are created, the filter log options may then be edited with the `filters -> logconfig` subcommand.



**Note** The `logconfig` command is a subcommand of `filters`. See [Using the CLI to Manage Message Filters, on page 225](#) for a full description of how to use this subcommand.

The `mbox` format is a standard UNIX mailbox format, and there are many utilities available to make viewing the messages easier. Most UNIX systems allow you to type “`mail -f mbox.filename`” to view the files. The `mbox` format is in plain text, so you can use a simple text editor to view the contents of the messages.

In the following example, a copy of the message is saved to a log named `joesmith` if the Envelope Sender matches `joesmith@yourdomain.com`:

```
logJoeSmithFilter:
if(mail-from == '^joesmith@yourdomain\\.com$')
{
archive('joesmith');
}
```

## Strip Header Action

The `strip-header` action examines the message for a particular header and removes those lines from the message before delivering it. When there are multiple headers, all instances of the header are removed (for example, the “Received:” header.)

In the following example, all messages have the header `X-DeleteMe` removed before transmission:

```
stripXDeleteMeFilter:
if (true)
{
strip-header('X-DeleteMe');
}
```

When working with headers, remember that the current value of the header includes changes made during processing (such as with filter actions that add, remove, or modify message headings). See [Message Header Rules and Evaluation, on page 131](#) for more information.

## Insert Header Action

The `insert-header` action inserts a new header into a message. AsyncOS does not verify the compliance to standards of the header you insert; you are responsible for ensuring that the resulting message complies with Internet standards for email.

The following example inserts a header named `X-Company` with the value set to `My Company Name` if the header is not already found in the message:

```
addXCompanyFilter:
```

```
if (not header('X-Company'))
{
insert-header('X-Company', 'My Company Name');
}
```

The `insert-header()` action allows the use of non-ASCII characters in the text of the header, while restricting the header name to be ASCII (to comply with standards). The transport encoding will be quoted-printable to maximize the readability.



---

**Note** The `strip-headers` and `insert-header` actions can be used in combination to rewrite any message headers in the original message. In some case, it is valid to have multiple instances of the same header (for example, `Received:` ) where in other cases, multiple instances of the same header could confuse a MUA (for example, multiple `Subject:`  headers.)

---

When working with headers, remember that the current value of the header includes changes made during processing (such as with filter actions that add, remove, or modify message headings). See [Message Header Rules and Evaluation, on page 131](#) for more information.

## Edit Header Text Action

The `edit-header-text` action allows you to rewrite specified header text using the regular expression substitution function. The filter matches the regular expression within the header and replaces it with a regular expression you specify.

For example, an email contains the following subject header:

```
Subject: SCAN Marketing Messages
```

The following filter removes the “SCAN” text, and leaves the text, “Marketing Messages”, in the header:

```
Remove_SCAN: if true
{
edit-header-text ('Subject', '^SCAN\s*', '');
}
```

After the filter processes the message, it returns the following header:

```
Subject: Marketing Messages
```

## Edit Body Text Action

The `edit-body-text()` message filter is similar to the `Edit-Header-Text()` filter, but it operates across the body of the message instead of one of the headers.

The `edit-body-text()` message filter uses the following syntax where the first parameter is the regular expression to search for and the second parameter is the replacement text:

```
Example: if true {
```

```
edit-body-text("parameter 1","parameter 2");
}
```

The `edit-body-text()` message filter only works on the message body parts. For more information about whether a given MIME part is considered a message “body” or a message “attachment”, see [Message Bodies vs. Message Attachments, on page 131](#).

The following example shows a URL removed from a message and replaced with the text, ‘URL REMOVED’:

```
URL_Replaced: if true {
edit-body-text("(?i)(?:https?|ftp)://[^\s">]+", "URL REMOVED");
}
```

The following example shows a social security number removed from the body of a message and replaced with the text, “XXX-XX-XXXX”:

```
ssn: if true {
edit-body-text("(?!000) (?:[0-6]\\d{2}|7(?:[0-6]\\d|7[012])) ([
-]?) (?!00)\\d\\d\\d\\1(?!0000)\\d{4}",
"XXX-XX-XXXX");
}
```



---

**Note** You cannot use smart identifiers with the `edit-body-text()` filter at this time.

---

## HTML Convert Action

While RFC 2822 defines a text format for email messages, there are extensions (such as MIME) to provide the transport of other content within an RFC 2822 message. AsyncOS can now use the `html-convert()` message filter to convert HTML to plain text using the following syntax:

```
Convert_HTML_Filter:
if (true)
{
html-convert();
}
```

The Cisco message filters make a determination on whether a given MIME part is considered a message “body” or a message “attachment”. The `html-convert()` filter only works on the message body parts. For more information about message bodies and attachments, see [Message Bodies vs. Message Attachments, on page 131](#).

Depending on the format, the `html-convert()` filter uses different methods to strip the HTML from within the documents.

If the message is plain text (`text/plain`), the message passes through the filter unchanged. If the message is a simple HTML message (`text/html`), all the HTML tags are stripped out of the message and the resulting body replaces the HTML message. The lines are not reformatted, and the HTML is not rendered in plain text. If the structure is MIME (with a multipart/alternative structure) and it contains both a `text/plain` part and `text/html` part with the same content, the filter removes the `text/html` part of the message and leaves the `text/plain` part of the message. For all other MIME types (such as `multipart/mixed`), all HTML body parts are stripped of their tags and reinserted into the message.

When encountered in a message filter, the `html-convert()` filter action only tags the message to be processed but does not immediately make a change to the message structure. The changes to the message only take effect after all processing is complete. This allows the other filter actions to process the original message body prior to modification.

## Bounce Profile Action

The `bounce-profile` action assigns a previously-configured bounce profile to the message. (See [Directing Bounced Email, on page 722](#).) If the message is undeliverable, the bounce options configured via the bounce profile are used. Using this feature overrides the bounce profile assigned to the message from the listener's configuration (if one is assigned).

The following filter example assigns the bounce profile “fastbounce” to all email sent with the header

```
X-Bounce-Profile: fastbounce :
```

```
fastbounce:
if (header ('X-Bounce-Profile') == 'fastbounce') {
bounce-profile ('fastbounce');
}
```

## Bypass Anti-Spam System Action

The `skip-spamcheck` action instructs the system to allow the message to bypass any content-based anti-spam filtering configured on the system. This action does nothing to the message if no content-based anti-spam filtering is configured, or if the message was never flagged to be scanned for spam in the first place.

The following example allows messages that have a high IP Reputation Score to bypass the content-based anti-spam filtering feature:

```
allowed_list_on_reputation:
if (reputation > 7.5)
{
skip-spamcheck();
}
```



### Related Topics

- [How Incoming Relays Affect Functionality](#) , on page 414
- [Protecting Email Gateway-Generated Messages From the Spam Filter](#), on page 401

## Bypassing Graymail Actions

If you do not want to apply graymail actions on certain messages, you can bypass them using the following message filter actions:

Message Filter Action	Description
skip-marketingcheck	Bypass actions on marketing emails
skip-socialcheck	Bypass actions on social network emails
skip-bulkcheck	Bypass actions on bulk emails

The following example specifies that messages received on the listener “private\_listener” must bypass graymail actions on social network emails.

```
internal_mail_is_safe:
if (recv-listener == 'private_listener')
{
skip-socialcheck();
}
```

## Bypass Anti-Virus System Action

The `skip-viruscheck` action instructs the system to allow the message to bypass any virus protection system configured on the system. This action does nothing to the message if there is no anti-virus system configured, or if the message was never flagged to be scanned for viruses in the first place.

The following example specifies that messages received on the listener “private\_listener” should bypass the anti-spam and the anti-virus systems.

```
internal_mail_is_safe:
if (recv-listener == 'private_listener')
{
skip-spamcheck();
skip-viruscheck();
}
```

## Bypass File Reputation Filtering and File Analysis System Actions

The `skip-ampcheck` action instructs the system to allow message to bypass File Reputation Filtering and File Analysis configured on the system. This action does nothing to the message if File Reputation Filtering and File Analysis is not configured, or if the message was never flagged to be scanned for File Reputation Filtering and File Analysis in the first place.

The following example specifies that messages with PDF attachments should bypass File Reputation Filtering and File Analysis.

```
skip_amp_scan:
if (attachment-filetype == 'pdf')
{
skip-ampcheck();
}
```

## Bypass Outbreak Filter Scanning Action

The `skip-vofcheck` action instructs the system to allow the message to bypass the Outbreak Filters scanning. This action does nothing to the message if Outbreak Filters scanning is not enabled.

The following example specifies that messages received on the listener “private\_listener” should bypass Outbreak Filter scanning.

```
internal_mail_is_safe:

if (recv-listener == 'private_listener') Outbreak Filters
{

skip-vofcheck();

}
```

## Add Message Tag Action

The `tag-message` action inserts a custom term into an outgoing message to use with DLP policy filtering. You can configure a DLP policy to limit scanning to messages with the message tag. The message tag is not visible to recipients. The tag name can contain any combination of characters from the set `[a-zA-Z0-9_-.]`.

For information on configuring a DLP policy to filter messages, see the “Data Loss Prevention” chapter.

The following example inserts a message tag into a message with “[Encrypt]” in the subject. You can then create a DLP policy that will encrypt messages with this message tag before delivering them if Cisco Email Encryption is available:

```
Tag_Message:

if (subject == '^\[Encrypt\]')
{

tag-message('Encrypt-And-Deliver');

}
```

## Add Log Entry Action

The `log-entry` action inserts customized text into the Text Mail logs at the `INFO` level. The text can include action variables. You can use this action to insert useful text for debugging purposes and information on why a message filter performed a certain action. The log entry also appears in message tracking.

The following example inserts a log entry explaining that message was bounced because it possibly contained confidential company information:

```
CompanyConfidential:

if (body-contains('Company Confidential'))
{
log-entry('Message may have contained confidential information.');
```

```
bounce();

}
```

## URL Reputation Actions

Use the reputation score of URLs in messages to modify the URLs or their behavior. For important details and examples, see [Modifying URLs in Messages: Using URL Reputation and URL Category Actions in Filters](#), on page 452 in [Protecting Against Malicious or Undesirable URLs](#), on page 443

No rule is needed with these actions.

In URL Reputation actions:

- `msg_filter_name`: is the name of this message filter.
- `min_score` and `max_score` are the minimum and maximum scores in the range for which the action should apply. The applicable range includes the values that you specify.

Minimum and maximum scores must be between `-10.0` and `10.0`.

- To specify an action when the reputation service does not provide a score, use the corresponding "no-reputation" version of the action, as shown in the following subsections.
- `allowedlist` is the name of a defined URL list (via the `urllistconfig` command.) Specifying an allowed list is optional.
- In place of `Preserve_signed`, enter 0 or 1:
  - 1 - Apply this action to unsigned messages only
  - 0 - Apply this action to all messages

If you do not specify a `preserve_signed` value, the action is applied to unsigned messages only.

### Related Topics

- [Replace URL with Text, Based on URL Reputation](#), on page 212
- [Defang URL, Based on URL Reputation](#), on page 212
- [Redirect URL to Cisco Security Proxy, Based on URL Reputation](#), on page 212

## Replace URL with Text, Based on URL Reputation

### To take action when the reputation service provides a score:

Use the `url-reputation-replace` action.

The syntax of a filter using the `url-reputation-replace` action is:

```
<msg_filter_name>:
if <condition>
{url-reputation-replace(<min_score>, <max_score>,'<replace_text>', '< allowedlist>',<
Preserve_signed> );}
```

Where `replace_text` is the text with which to replace the URL.

### To take action when the reputation service does not provide a score:

Use the `url-no-reputation-replace` action.

The syntax of a filter using the `url-no-reputation-replace` action is:

```
<msg_filter_name>:
if <condition>
{url-no-reputation-replace ('<replace_text>', '<allowedlist>', <Preserve_signed>);}
```

Where `replace_text` is the text with which to replace the URL.

## Defang URL, Based on URL Reputation

### To take action when the reputation service provides a score:

Use the `url-reputation-defang` action.

The syntax of a filter using the `url-reputation-defang` action is:

```
<msg_filter_name>:
if <condition>
{url-reputation-defang (<min_score>, <max_score>, '<allowedlist>', <Preserve_signed>);}
```

### To take action when the reputation service does not provide a score:

Use the `url-no-reputation-defang` action.

The syntax of a filter using the `url-no-reputation-defang` action is:

```
<msg_filter_name>:
if <condition>
{url-no-reputation-defang ('<allowedlist>', <Preserve_signed>);}
```

## Redirect URL to Cisco Security Proxy, Based on URL Reputation

### To take action when the reputation service provides a score:

Use the `url-reputation-proxy-redirect` action.

The syntax of a filter using the `url-reputation-proxy-redirect` action is:

```
<msg_filter_name>:
if <condition>
{url-reputation-proxy-redirect (<min_score>, <max_score>, '<allowedlist>',
<Preserve_signed>);}

```

#### To take action when the reputation service does not provide a score:

Use the `url-no-reputation-proxy-redirect` action.

The syntax of a filter using the `url-no-reputation-proxy-redirect` action is:

```
<msg_filter_name>:
if <condition>
{url-no-reputation-proxy-redirect ('<allowedlist>', <Preserve_signed>);}

```

## URL Category Actions

Use the categories of URLs in messages to modify the URLs or their behavior. For important details, see [Modifying URLs in Messages: Using URL Reputation and URL Category Actions in Filters](#), on page 452 in [Protecting Against Malicious or Undesirable URLs](#), on page 443

No rule is needed with these actions.

In all URL Category actions:

- `msg_filter_name` : is the name of the message filter.
- `category-name` is the URL category. Separate multiple categories with commas. To obtain correct category names, look at a URL Category condition or action in a Content Filter. For descriptions and examples of the categories, see [About URL Categories](#), on page 462.
- `url_allowed_list` is the name of a defined URL list (via the `urllistconfig` command.)
- `unsigned-only` : Enter 0 or 1.
  - 1 - Apply this action to unsigned messages only
  - 0 - Apply this action to all messages

#### Related Topics

- [Replace URL with Text, Based on URL Category](#), on page 213
- [Defang URL, Based on URL Category](#), on page 214
- [Redirect URL to Cisco Security Proxy, Based on URL Category](#), on page 214

### Replace URL with Text, Based on URL Category

The syntax of a filter using the `url-category-replace` action is

```
<msg_filter_name>:
if <condition>
url-category-replace(['<category-name1>', '<category-name2>', ...,
'<category-name3>'], '<replacement-text>', '<url_allowed_list>', <unsigned-only>);

```

Where `replacement-text` is the text that you want to use to replace the URL.

## Defang URL, Based on URL Category

The syntax of a filter using the `url-category-defang` action is:

```
<msg_filter_name>:
if <condition>
url-category-defang(['<category-name1>', '<category-name2>', ..., '<category-name3>'],
'<url_allowed_list>', <unsigned-only>);
```

## Redirect URL to Cisco Security Proxy, Based on URL Category

The syntax of a filter using the `url-category-proxy-redirect` action is:

```
<msg_filter_name>:
if <condition>
url-category-proxy-redirect(['<category-name1>', '<category-name2>', ..., '<category-name3>'],
'<url_allowed_list>', <unsigned-only>);
```

## No Operation

The No Operation action performs a no-op, or no operation. You can use this action in a message filter if you do not want to use any of the other actions such as Notify, Quarantine, or Drop. For example, to understand the behavior of a new message filter that you created, you can use the No Operation action. After the message filter is operational, you can monitor the behavior of the new message filter using the Message Filters report page, and fine-tune the filter to match your requirements.

The following example shows how to use No Operation action in a message filter.

```
new_filter_test: if header-repeats ('subject', X, 'incoming') {no-op();}
```

## Forged Email Detection Action

Strips the From: header from the forged message and replaces it with the Envelope Sender.

The following message filter compares the From: header in the message with the terms in dictionary and if the matching score of a term in the content dictionary is greater than or equal to 70, the message filter strips the From: header and replaces it with the Envelope Sender.

```
FED_CF: if (forged-email-detection("Execs", 70)) { fed("from", ""); }
```

## Attachment Scanning

The email gateway uses Content Scanner to strip attachments from messages that are inconsistent with your corporate policies, while still retaining the ability to deliver the original message.

You can filter attachments based on their specific file type, fingerprint, or based on the content of the attachment. Using the fingerprint to determine the exact type of attachment prevents users from renaming a malicious attachment extension (for example, `.exe`) to a more commonly used extension (for example, `.doc`) in the hope that the renamed file would bypass attachment filters.

When you scan attachments for content, the Content Scanner extracts data from attachment files to search for the regular expression. It examines both data and metadata in the attachment file. If you scan an Excel or

Word document, the attachment scanning engine can also detect the following types of embedded files: .exe, .dll, .bmp, .tiff, .pcx, .gif, .jpeg, .png, and Photoshop images.

The Content Scanner in your email gateway can perform content scanning on the following archive file formats:

- ACE Archive
- ALZ Archive
- Apple Disk Image
- ARJ Archive
- bzip2 Archive
- EGG Archive
- GNU Zip
- ISO Disk Image
- Java Archive
- LZH
- Microsoft Cabinet Archive
- RAR Multi-Part File
- RedHat Package Manager Archive
- Roshal Archive (RAR)
- Unix AR Archive
- UNIX Compress Archive
- UNIX cpio
- UNIX Tar
- XZ Archive
- Zip Archive
- 7-Zip
- ARC



---

**Note** You can view the details of the Content Scanner-related files using the **Security Services > Scan Behavior** page in web interface or using the `contentscannerstatus` command in CLI. These files are automatically updated using update server. If you want to manually update these files, see [Configuring Scan Behavior, on page 247](#).

---

#### Related Topics

- [Message Filters for Scanning Attachments, on page 216](#)

- [Image Analysis, on page 217](#)
- [Configuring the Image Analysis Scanning Engine, on page 217](#)
- [Configuring the Message Filter to Perform Actions Based on Image Analysis Results, on page 219](#)
- [Notifications, on page 221](#)
- [Examples of Attachment Scanning Message Filters, on page 221](#)

## Message Filters for Scanning Attachments

The message filter actions described in the following table are *non-final* actions. (Attachments are dropped and the message processing continues.)

The optional comment is text that is added to the message, much like a footer, and it can contain Message Filter Action Variables (see [Examples of Attachment Scanning Message Filters, on page 221](#)).

**Table 27: Message Filter Actions for Attachment Filtering**

Action	Syntax	Description
Drop Attachments by Name	<pre>drop-attachments-by-name (&lt;regular expression &gt;[, &lt;optional comment &gt;])</pre>	Drops all attachments on messages that have a filename that matches the given regular expression. Archive file attachments (zip, tar) will be dropped if they contain a file that matches. See <a href="#">Examples of Attachment Scanning Message Filters, on page 221</a> .
Drop Attachments by Type	<pre>drop-attachments-by-type (&lt;MIME type &gt;[, &lt;optional comment &gt;])</pre>	Drops all attachments on messages that have a MIME type, determined by either the given MIME type or the file extension. Archive file attachments (zip, tar) will be dropped if they contain a file that matches.
Drop Attachments by File Type	<pre>drop-attachments-by-filetype (&lt;fingerprint name &gt;[, &lt;optional comment &gt;])</pre>	Drops all attachments on messages that match the given “fingerprint” of the file. Archive file attachments (zip, tar) will be dropped if they contain a file that matches.
Drop Attachments by MIME Type	<pre>drop-attachments-by-mimetype (&lt;MIME type &gt;[, &lt;optional comment &gt;])</pre>	Drops all attachments on messages that have a given MIME type. This action does not attempt to ascertain the MIME type by file extension and so it also does not examine the contents of archives.
Drop Attachments by Size	<pre>drop-attachments-by-size (&lt;number &gt;[, &lt;optional comment &gt;])</pre>	Drops all attachments on the message that, in raw encoded form, are equal to or greater than the size (in bytes) given. Note that for archive or compressed files, this action does not examine the uncompressed size, but rather the size of the actual attachment itself.



Action	Syntax	Description
Attachment Scanning	<pre>drop-attachments-where-contains (&lt;regular expression &gt;[, &lt;optional comment &gt;])</pre>	Drops all attachments on message that contain the regular expression. Archive files (zip, tar) will be dropped if any of the files they contain match the regular expression pattern.
Drop Attachments by Dictionary Matches	<pre>drop-attachments-where-dictionary -match(&lt;dictionary name&gt;)</pre>	This filter action strips attachments based on matches to dictionary terms. If the terms in the MIME parts considered to be an attachment match a dictionary term (and the user-defined threshold is met), the attachment is stripped from the email. See <a href="#">Examples of Attachment Scanning Message Filters</a> , on page 221.

## Image Analysis

Some messages contain images that you may wish to scan for inappropriate content. Use the image analysis engine to search for inappropriate content in email.

The image analyzer uses algorithms that measure image attributes to determine the likelihood of inappropriate content. These algorithms can detect, for example, the shapes and color palette in an image. The analyzer can identify the type of shapes in an image and the percentage of any flesh-tone colors relative to the other colors in the image to help identify inappropriate content. Images with a high percentage of flesh-tone colors are more likely to be inappropriate. The algorithms do not discriminate in any way.

Image analysis is not designed to supplement or replace your Anti-Virus and Anti-Spam scanning engines. Its purpose is to enforce acceptable use by identifying inappropriate content in email. Use the image analysis scanning engine to quarantine and analyze mail and to detect trends.

After you configure your email gateway for image analysis, you can use image analysis filter rules to perform actions on suspect or inappropriate emails. Image scanning allows you to scan the following types of attached files: BMP, JPG, TIF, PNG, GIF, TGA, and PCX.

When you scan image attachments, Cisco fingerprinting determines the file type, and the image analyzer uses algorithms to analyze the image content. If the image is embedded in another file, the Content Scanner extracts the file. The image analysis verdict is computed on the message as a whole. If the message does not include any images, the message receives a score of "0" which maps to a "clean" verdict. Therefore, a message without any images will receive a "clean" verdict.

## Configuring the Image Analysis Scanning Engine

To enable image analysis from the GUI:

### Procedure

- 
- Step 1** Go to **Security Services > IronPort Image Analysis**.
  - Step 2** Click **Enable**.
- A success message displays, and the verdict settings display.

The image analysis filter rule allows you to determine the actions to take based on the following verdicts:

- **Clean:** The image is free of inappropriate content. The image analysis verdict is computed on the message as a whole, so a message without any images will receive a "clean" verdict if scanned.
- **Suspect:** The image may contain inappropriate content.
- **Inappropriate:** The image contains inappropriate content.

These verdicts represent a numeric value assigned by the image analyzer algorithm to determine probability of inappropriate content.

The following values are recommended:

- Clean: 0 to 49
- Suspect: 50 to 74
- Inappropriate: 75 to 100

### What to do next

You can fine-tune image scanning by configuring the sensitivity setting, which helps reduce the number of false positives. For example, if you find that you are getting false positives, you can decrease the sensitivity setting. Or, conversely, if you find that the image scanning is missing inappropriate content, you may want to set the sensitivity higher. The sensitivity setting is a value between 0 (no sensitivity) and 100 (highly sensitive). The default sensitivity setting of 65 is recommended.

### Related Topics

- [Tuning Image Analysis Settings, on page 218](#)

## Tuning Image Analysis Settings

### Procedure

- Step 1** Go to **Security Services > IronPort Image Analysis**.
- Step 2** Click **Edit Settings**.
- Step 3** Configure the settings for image analysis sensitivity. The default sensitivity setting of 65 is recommended.
- Step 4** Configure the settings for Clean, Suspect, and Inappropriate verdicts.  
When you configure the value ranges, ensure that you do not overlap values and that you use whole integers.
- Step 5** Optionally, configure AsyncOS to bypass scanning images that do not meet a minimum size requirement (recommended). By default, this setting is configured for 100 pixels. Scanning images that are smaller than 100 pixels can sometimes result in false positives.

You can also enable image analysis settings from the CLI using the `imageanalysisconfig` command:

### What to do next

### Related Topics

- [Viewing the Verdict Score of a Particular Message, on page 219](#)

## Viewing the Verdict Score of a Particular Message

To see the verdict score for a particular message, you can view the mail logs. The mail logs display the image name or file name, the score for a particular message attachment. In addition, the log displays information about whether the images in a file were scannable or unscannable. Note that information in the log describes the result for each message attachment, rather than each image. For example, if the message had a zip attachment that contained a JPEG image, the log entry would contain the name of the zip file rather than the name of the JPEG. Also, if the zip file included multiple images then the log entry would include the maximum score of all the images. The unscannable notation indicates whether any of the images were unscannable.

The log does not contain information about how the scores translate to a particular verdict (clean, suspect or inappropriate). However, because you can use mail logs to track the delivery of specific messages, you can determine by the actions performed on the messages whether the mail contained inappropriate or suspect images.

For example, the following mail log shows attachments dropped by message filter rules as a result of Image Analysis scanning:

```
Thu Apr 3 08:17:56 2009 Debug: MID 154 IronPort Image Analysis: image 'Unscannable.jpg'
is unscannable.

Thu Apr 3 08:17:56 2009 Info: MID 154 IronPort Image Analysis: attachment
'Unscannable.jpg' score 0 unscannable

Thu Apr 3 08:17:56 2009 Info: MID 6 rewritten to MID 7 by
drop-attachments-where-image-verdict filter 'f-001'

Thu Apr 3 08:17:56 2009 Info: Message finished MID 6 done
```

## Configuring the Message Filter to Perform Actions Based on Image Analysis Results

Once you enable image analysis, you must create a message filter to perform different actions for different message verdicts. For example, you may wish to deliver messages with a clean verdict, but quarantine messages that are determined to have inappropriate content.



---

**Note** Cisco recommends you do not drop or bounce messages with inappropriate or suspect verdicts. Instead, send copies of violations to a quarantine for later review and better understanding of trend analysis.

---

The following filter shows messages tagged if the content is inappropriate or suspect:

```
image_analysis: if image-verdict == "inappropriate" {
strip-header("Subject");
insert-header("Subject", "[inappropriate image] $Subject");
}
else {
if image-verdict == "suspect" {
```

```
strip-header("Subject");

insert-header("Subject", "[suspect image] $Subject");

}

}
```

### Related Topics

- [Creating Content Filters to Strip Attachments Based on Image Analysis Verdicts](#) , on page 220

## Creating Content Filters to Strip Attachments Based on Image Analysis Verdicts

After you enable image analysis, you can create a content filter to strip attachments based on image analysis verdicts, or you can configure a filter to perform different actions for different message verdicts. For example, you might decide to quarantine messages that contain inappropriate content.

To strip attachments based on image analysis verdicts:

### Procedure

---

- Step 1** Click Mail Policies > Incoming Content Filters.
  - Step 2** Click Add Filter.
  - Step 3** Enter a name for the content filter.
  - Step 4** Under Actions, click **Add Action**.
  - Step 5** Under Strip Attachment by File Info, click **Image Analysis Verdict is**:
  - Step 6** Select from the following image analysis verdicts:
    - Suspect
    - Inappropriate
    - Suspect or Inappropriate
    - Unscannable
    - Clean
- 

## Configuring an Action Based on Image Analysis Verdicts

To configure an action based on image analysis verdicts:

### Procedure

---

- Step 1** Click Mail Policies > Incoming Content Filters.
- Step 2** Click Add Filter.
- Step 3** Enter a name for the content filter.
- Step 4** Under Conditions, click **Add Condition**.

- Step 5** Under Attachment File Info, click **Image Analysis Verdict**.
- Step 6** Choose from one of the following verdicts:
- Suspect
  - Inappropriate
  - Suspect or Inappropriate
  - Unscannable
  - Clean
- Step 7** Click **Add Action**.
- Step 8** Select an action to perform on messages based on the image analysis verdict.
- Step 9** Submit and commit your changes.
- 

## Notifications

Using the Text Resources page in the GUI or the `textconfig` CLI command to configure custom notification templates as text resources is another useful tool when used in conjunction with attachment filtering rules. The notification template supports non-ASCII characters (you are prompted to choose an encoding while creating the template).

In the following example, the `textconfig` command was first used to create a notification template named `strip.mp3` that will be inserted into to the body of the notification message. Then, an attachment filtering rule is created so that when an `.mp3` file has been stripped from a message, a notification email is sent to the intended recipients explaining that the `.mp3` file has been deleted.

```
drop-mp3s:
if (attachment-type == '*/mp3')
{ drop-attachments-by-filetype('Media');
notify ('$EnvelopeRecipients', 'Your mp3 has been removed', '$EnvelopeFrom',
'strip.mp3');
}
```

For more information, see [Notify and Notify-Copy Actions, on page 198](#).

## Examples of Attachment Scanning Message Filters

The following examples shows actions performed on attachments:

- [Inserting Headers, on page 222](#)
- [Dropping Attachments by File Type, on page 222](#)
- [Dropping Attachments by Dictionary Matches, on page 223](#)
- [Quarantining Protected Attachments, on page 224](#)
- [Detecting Unprotected Attachments, on page 224](#)

## Inserting Headers

In these examples, AsyncOS inserts headers when the attachments contain specified content.

In the following example, all of the attachments on the message are scanned for a keyword. If the keyword is present in all of the attachments, a custom X-Header is inserted:

```
attach_disclaim:
if (every-attachment-contains('[DD]isclaimer') ) {
insert-header("X-Example-Approval", "AttachOK");
}
```

In the following example, the attachment is scanned for a pattern in the binary data. The filter uses the `attachment-binary-contains` filter rule to search for a pattern that indicates that the PDF document is encrypted. If the pattern is present in the binary data, a custom header is inserted:

```
match_PDF_Encrypt:
if (attachment-filetype == 'pdf' AND
attachment-binary-contains('/Encrypt')){
strip-header ('Subject');
insert-header ('Subject', '[Encrypted] $Subject');
}
```

## Dropping Attachments by File Type

In the following example, the “executable” group of attachments ( `.exe` , `.dll` , and `.scr` ) is stripped from messages and text is added to the message, listing the filenames of the dropped files (using the `$dropped_filename` action variable). Note that the `drop-attachments-by-filetype` action examines attachments and strips them based on the fingerprint of the file, and not just the three-letter filename extension. Note also that you can specify a single file type (“mpeg”) or you can refer to all of the members of the file type (“Media”):

```
strip_all_exes: if (true) {
drop-attachments-by-filetype ('Executable', "Removed attachment:
$dropped_filename");
}
```

In the following example, the same “executable” group of attachments ( `.exe` , `.dll` , and `.scr` ) are stripped from messages whose Envelope Sender is not within the domain `example.com`.

```
strip_inbound_exes: if (mail-from != "@example\\.com$") {
drop-attachments-by-filetype ('Executable');
```

```
}

```

In the following example, a specific member of a file type (“wmf”) as well as a the same “executable” group of attachments ( `.exe` , `.dll` , and `.scr` ) are stripped from messages whose Envelope Sender is not within the domain `example.com` .

```
strip_inbound_exes_and_wmf: if (mail-from != "@example\\.com$") {
drop-attachments-by-filetype ('Executable');
drop-attachments-by-filetype ('x-wmf');
}
```

In the following example, the “executable” pre-defined group of attachments is extended to include more attachment names. (Note that this action will *not* examine the attachments’ file type.)

```
strip_all_dangerous: if (true) {
drop-attachments-by-filetype ('Executable');
drop-attachments-by-name('(?!i)\\. (cmd|pif|bat)$');
}
```

The `drop-attachments-by-name` action supports non-ASCII characters.



---

**Note** The `drop-attachments-by-name` action matches the regular expression against the filename captured from the MIME header. The filename captured from the MIME header may contain trailing spaces.

---

In the following example, a message is dropped if the attachment is not an `.exe` executable file type. However, the filter will not perform any action on the message if there is at least one attachment with the file type you want to filter out. For example, the following filter drops any message with an attachment that is not an `.exe` file type:

```
exe_check: if (attachment-filetype != "exe") {
drop();
}
```

If a message has multiple attachments, the email gateway does not drop the message if at least one of the attachments is an `.exe` file, even if the other attachments not `.exe` files.

## Dropping Attachments by Dictionary Matches

This `drop-attachments-where-dictionary-match` action strips attachments based on matches to dictionary terms. If the terms in the MIME parts considered to be an attachment match a dictionary term (and the user-defined threshold is met), the attachment is stripped from the email. The following example shows attachment drops if words in the “secret\_words” dictionary are detected in the attachment. Note that the threshold for the matches is set to one:

```
Data_Loss_Prevention: if (true) {
  drop-attachments-where-dictionary-match("secret_words", 1);
}
```

## Quarantining Protected Attachments

The `attachment-protected` filter tests whether any attachment in the message is password protected. You might use this filter on incoming mail to ensure that the attachments are scannable. According to this definition, a zip file containing one encrypted member along with unencrypted members will be considered protected. Similarly, PDF file that has no open password will not be considered protected, even though it may restrict copying or printing with a password. The following example shows protected attachments sent to a policy quarantine:

```
quarantine_protected:
  if attachment-protected
  {
    quarantine("Policy");
  }
```

## Detecting Unprotected Attachments

The `attachment-unprotected` filter tests whether any attachment in the message is *not* password protected. This message filter complements the `attachment-protected` filter. You might use this filter on outgoing mail to detect outgoing mail that is unprotected. The following example shows AsyncOS detecting unprotected attachments on an outgoing listener and quarantining the messages:

```
quarantine_unprotected:
  if attachment-unprotected
  {
    quarantine("Policy");
  }
```

# Detecting Malicious Files in Messages Attachments Using Message Filter

As an example, use the following message filter rule syntax to detect files in message attachments categorized as malicious by the ETF engine, and take appropriate actions on such messages.

### Syntax:

```
Strip_malicious_files: if (file-hash-etf-rule (['etf_source1'], <'file_hash_exception_list'>))
```



```
{ file-hash-etf-strip-attachment-action (['etf_source1'], <'file_hash_exception_list>,
"file stripped from message attachment"); }
```

**Where:**

- 'file-hash-etf-rule' is the Attachment File Info message filter rule
- 'etf\_source1' is the ETF source(s) used to detect malicious files in the messages based on the file hash.
- 'file\_hash\_exception\_list' is the name of a file hash exception list. If a file hash exception list is not present, it is displayed as "".
- 'file-hash-etf-strip-attachment-action' is the name of the action that you want to apply on messages that contain malicious files.

In the following example, if a message contains a message attachment detected as malicious by the ETF engine, the attachment is stripped.

```
Strip_Malicious_Attachment: if (true) {file-hash-etf-strip-attachment-action
(['threat_feed_source'], "", "Malicious message attachment has been stripped from
the message.");}
```

## Using the CLI to Manage Message Filters

You can use the CLI to add, delete, activate and de-activate, import and export, and set logging options for message filters. The table below shows a summary of the commands and subcommands. The table below shows a summary of the commands and subcommands.

**Table 28: Message Filters Subcommands**

Syntax	Description
filters	The main command. This command is interactive; it asks you for more information (for example, new , delete , import ).
new	Creates a new filter. If no location is given, it is appended to the current sequence. Otherwise, the filter will be inserted into the specific place in the sequence. For more information, see <a href="#">Creating a New Message Filter, on page 227</a> .
delete	Deletes a filter by name or by sequence number. For more information, see <a href="#">Deleting a Message Filter, on page 227</a> .
move	Rearranges the existing filters. For more information, see <a href="#">Creating a New Message Filter, on page 227</a> .
set	Sets filter to active or inactive state. For more information, see <a href="#">Creating a New Message Filter, on page 227</a> .
import	Replaces the current set of filters with a new set stored in a file (in the /configuration directory of the email gateway). For more information, see <a href="#">Creating a New Message Filter, on page 227</a> .
export	Exports the current set of filters to a file (in the /configuration directory of the email gateway). For more information, see <a href="#">Exporting Message Filters, on page 231</a> .

Syntax	Description
<code>list</code>	Lists information about a filter or filters. For more information, see <a href="#">Displaying a Message Filter List, on page 231</a> .
<code>detail</code>	Prints detailed information about a specific filter, including the body of the filter rule itself. For more information, see <a href="#">Displaying Message Filter Details, on page 232</a> .
<code>logconfig</code>	Enters the <code>logconfig</code> submenu of filters, allowing you to edit the log subscriptions from <code>archive()</code> filter actions. For more information, see <a href="#">Configuring Filter Log Subscriptions, on page 232</a> .



**Note** You must issue the `commit` command for filters to take effect.

Three types of parameters are:

**Table 29: Filter Management Parameters**

<i>seqnum</i>	An integer representing a filter based on its position in the list of filters. A <i>seqnum</i> of 2 represents the second filter in the list, for example.
<i>filename</i>	The colloquial name of a filter.
<i>range</i>	A range may be used to represent more than one filter, and appears in the form of <i>X Y</i> , where <i>X</i> and <i>Y</i> are the first and last <i>seqnums</i> that identify the extent. For example, <i>2-4</i> represents filters in the second, third, and fourth positions. Either <i>X</i> or <i>Y</i> may be left off to represent an open-ended list. For example, <i>-4</i> represents the first four filters, and <i>2-</i> represents all filters except the first. You can also use the keyword <code>all</code> to represent all the filters in the filter list.

### Related Topics

- [Creating a New Message Filter, on page 227](#)
- [Deleting a Message Filter, on page 227](#)
- [Moving a Message Filter, on page 227](#)
- [Activating and Deactivating a Message Filter, on page 227](#)
- [Importing Pre-Policy Filters, on page 230](#)
- [Exporting Message Filters, on page 231](#)
- [Viewing Non-ASCII Character Sets, on page 231](#)
- [Displaying a Message Filter List, on page 231](#)
- [Displaying Message Filter Details, on page 232](#)
- [Configuring Filter Log Subscriptions, on page 232](#)
- [Changing Message Encoding, on page 233](#)
- [Sample Message Filters, on page 235](#)

## Creating a New Message Filter

```
new [seqnum|filename|last]
```

Specifies the position at which to insert the new filter(s). If omitted, or given the keyword `last`, the filters entered in are appended to the list of filters. No gaps in the sequence numbers are allowed; you are not allowed to enter a *seqnum* outside the boundaries of the current list. If you enter an unknown *filename*, you are prompted to enter a valid *filename*, *seqnum*, or `last`.

After a filter has been entered, you may manually enter the filter script. When you are finished typing, end the entry by typing a period ( `.` ) on a line by itself.

The following conditions can cause errors:

- Sequence number beyond the current range of sequence numbers.
- Filter with a non-unique *filename*.
- Filter with a *filename* that is a reserved word.
- Filter with a syntax error.
- Filter with actions referring to non-existent system resources such as interfaces.

## Deleting a Message Filter

```
delete [seqnum|filename|range]
```

Deletes the filter(s) identified.

The following conditions can cause errors:

- No filter with a given filter name.
- No filter with a given sequence number.

## Moving a Message Filter

```
move [seqnum|filename|rangeseqnum|last]
```

Moves the filters identified by the first parameter to the position identified by the second parameter. If the second parameter is the keyword `last`, the filters are moved to the end of the list of filters. If more than one filter is being moved, their ordering remains the same in relation to one another.

The following conditions can cause errors:

- No filter with a given filter name.
- No filter with a given sequence number.
- Sequence number beyond the current range of sequence numbers.
- Movement would result in no change of sequence.

## Activating and Deactivating a Message Filter

A given message filter is either *active* or *inactive* and it is also either *valid* or *invalid*. A message filter is only used for processing if it is both *active* and *valid*. You change an existing filter from active to inactive (and

back again) using the CLI. A filter is invalid if it refers to a listener or interface which does not exist (or has been removed).



**Note** You can determine if a filter is inactive by its syntax; AsyncOS changes the colon after the filter name to an exclamation point for inactive filters. If you use this syntax when entering or importing a filter, AsyncOS marks the filter as inactive.

For example, the following benign filter named “filterstatus” is entered. It is then made inactive using the `filter -> set` subcommand. Note that when the details of the filter are shown, the colon has been changed to an exclamation point (and is bold in the following example).

```
mail3.example.com> filters

Choose the operation you want to perform:
- NEW - Create a new filter.
- IMPORT - Import a filter script from a file.

[]> new

Enter filter script. Enter '.' on its own line to end.

filterstatus: if true(skip-filters!);}
.

1 filters added.

Choose the operation you want to perform:
- NEW - Create a new filter.
- DELETE - Remove a filter.
- IMPORT - Import a filter script from a file.
- EXPORT - Export filters to a file
- MOVE - Move a filter to a different position.
- SET - Set a filter attribute.
- LIST - List the filters.
- DETAIL - Get detailed information on the filters.
- LOGCONFIG - Configure log subscriptions used by filters.
- ROLLOVERNOW - Roll over a filter log file.

[]> list

Num Active Valid Name
1 Y Y filterstatus

Choose the operation you want to perform:
```

```
- NEW - Create a new filter.
- DELETE - Remove a filter.
- IMPORT - Import a filter script from a file.
- EXPORT - Export filters to a file
- MOVE - Move a filter to a different position.
- SET - Set a filter attribute.
- LIST - List the filters.
- DETAIL - Get detailed information on the filters.
- LOGCONFIG - Configure log subscriptions used by filters.
- ROLLOVERNOW - Roll over a filter log file.

[]> set

Enter the filter name, number, or range:

[all]> all

Enter the attribute to set:

[active]> inactive

1 filters updated.

Choose the operation you want to perform:

- NEW - Create a new filter.
- DELETE - Remove a filter.
- IMPORT - Import a filter script from a file.
- EXPORT - Export filters to a file
- MOVE - Move a filter to a different position.
- SET - Set a filter attribute.
- LIST - List the filters.
- DETAIL - Get detailed information on the filters.
- LOGCONFIG - Configure log subscriptions used by filters.
- ROLLOVERNOW - Roll over a filter log file.

[]> detail

Enter the filter name, number, or range:

[]> all

Num Active Valid Name
1 N Y filterstatus
```

```
filterstatus! if (true) {
skip-filters();
}
```

Choose the operation you want to perform:

- NEW - Create a new filter.
  - DELETE - Remove a filter.
  - IMPORT - Import a filter script from a file.
  - EXPORT - Export filters to a file
  - MOVE - Move a filter to a different position.
  - SET - Set a filter attribute.
  - LIST - List the filters.
  - DETAIL - Get detailed information on the filters.
  - LOGCONFIG - Configure log subscriptions used by filters.
  - ROLLOVERNOW - Roll over a filter log file.
- [ ]>

### Related Topics

- [Activating or Deactivating a Message Filter, on page 230](#)

## Activating or Deactivating a Message Filter

```
set [seqnum|filename|range] active|inactive
```

Sets the filters identified to have the given state. Legal states are:

- active: Set the state of the selected filters to be active.
- inactive: Set the state of the selected filters to be inactive.

The following conditions can cause errors:

- No filter with a given *filename* .
- No filter with a given sequence number.



---

**Note** A filter which is inactive may also be noted in its syntax; the colon after the label (name of the filter) is changed to an exclamation point (!). A filter entered manually from the CLI, or imported, that contains this syntax, will automatically be marked inactive. For example, mailfrompm! instead of mailfrompm: is displayed.

---

## Importing Pre-Policy Filters

```
import filename
```

The name of the file containing filters to be processed. This file must reside in the configuration directory of the FTP/SCP root directory on the appliance, if you enabled FTP/SCP access for the interface with the `interfaceconfig` command. It is ingested and parsed, and any errors are reported. The filters imported replace all filters existing in the current filter set. See [FTP, SSH, and SCP Access, on page 1303](#) for more information. Consider exporting the current filter list (see [Exporting Message Filters, on page 231](#)) and then editing that file before importing.

When importing message filters, you are prompted to select the encoding used.

The following conditions can cause errors:

- File does not exist.
- Filter with a non-unique filter name.
- Filter with a *filtname* that is a reserved word.
- Filter with a syntax error.
- Filter with actions referring to non-existent system resources such as interfaces.

## Exporting Message Filters

```
export filename[seqnum] filtname|range]
```

Output a formatted version of the existing filter set to a file in the configuration directory of the FTP/SCP root directory on the email gateway. See [FTP, SSH, and SCP Access, on page 1303](#) for more information.

When exporting message filters, you are prompted to select the encoding used.

The following conditions can cause errors:

- No filter with a given filter name.
- No filter with a given sequence number.

## Viewing Non-ASCII Character Sets

The system displays filters containing non-ASCII characters in the CLI in UTF-8. If your terminal/display does not support UTF-8, the filter will be unreadable.

The best way to manage non-ASCII characters in filters is to edit the filter in a text file and then import that text file (see [Importing Pre-Policy Filters, on page 230](#)) into the email gateway.

## Displaying a Message Filter List

```
list [seqnum] filtname|range]
```

Shows summarized information about the identified filters in a tabular form without printing the filter body. The information displayed includes:

- Filter name
- Filter sequence number
- Filter's active/inactive state
- Filter's valid/invalid state

The following conditions can cause errors:

- Illegal range format.

## Displaying Message Filter Details

```
detail [seqnum|filename|range]
```

Provides full information about the identified filters, including the body of the filter and any additional state information.

## Configuring Filter Log Subscriptions

```
logconfig
```

Enters a submenu that allows you to configure the filter log options for the mailbox files generated by the `archive()` action. These options are very similar to those used by the regular `logconfig` command, but the logs may only be created or deleted by adding or removing filters that reference them.

Each filter log subscription has the following default values, which can be modified using the `logconfig` subcommand:

- Retrieval method - FTP Poll
- File size - 10MB
- Max number of files - 10

For more information, see the “Logging” chapter.

```
mail3.example.com> filters
```

```
Choose the operation you want to perform:
```

- NEW - Create a new filter.
- DELETE - Remove a filter.
- IMPORT - Import a filter script from a file.
- EXPORT - Export filters to a file
- MOVE - Move a filter to a different position.
- SET - Set a filter attribute.
- LIST - List the filters.
- DETAIL - Get detailed information on the filters.
- LOGCONFIG - Configure log subscriptions used by filters.
- ROLLOVERNOW - Roll over a filter log file.

```
[> logconfig
```

```
Currently configured logs:
```

1. "joesmith" Type: "Filter Logs" Retrieval: FTP Poll

```
Choose the operation you want to perform:
```

- EDIT - Modify a log setting.



```
[> edit

Enter the number of the log you wish to edit.

[> 1

Choose the method to retrieve the logs.

1. FTP Poll
2. FTP Push
3. SCP Push

[1]> 1

Please enter the filename for the log:

[joesmith.mbox]>

Please enter the maximum file size:

[10485760]>

Please enter the maximum number of files:

[10]>

Currently configured logs:

1. "joesmith" Type: "Filter Logs" Retrieval: FTP Poll

Enter "EDIT" to modify or press Enter to go back.

[>
```

## Changing Message Encoding

You can use the `localeconfig` command to set the behavior of AsyncOS regarding modifying the encoding of message headings and footers during message processing:

```
example.com> localeconfig
```

```
Behavior when modifying headers: Use encoding of message body
Behavior for untagged non-ASCII headers: Impose encoding of message body
Behavior for mismatched footer or heading encoding: Try both body and footer or heading
encodings
Behavior when decoding errors found: Disclaimer is displayed as inline content and the
message body is added as an attachment.
```

```
Choose the operation you want to perform:
- SETUP - Configure multi-lingual settings.
[> setup
```

```
If a header is modified, encode the new header in the same encoding as the message body?
(Some MUAs incorrectly handle headers encoded in a different encoding than the body.
However, encoding a modified header in the same encoding as the message body may cause
certain
characters in the modified header to be lost.) [Y]>
```

```
If a non-ASCII header is not properly tagged with a character set and is being used or
modified,
```

impose the encoding of the body on the header during processing and final representation of the message?  
 (Many MUAs create non-RFC-compliant headers that are then handled in an undefined way. Some MUAs handle headers encoded in character sets that differ from that of the main body in an incorrect way.  
 Imposing the encoding of the body on the header may encode the header more precisely. This will be used to interpret the content of headers for processing, it will not modify or rewrite the header unless that is done explicitly as part of the processing.) [Y]>

Disclaimers (as either footers or headings) are added in-line with the message body whenever possible.  
 However, if the disclaimer is encoded differently than the message body, and if imposing a single encoding will cause loss of characters, it will be added as an attachment. The system will always try to use the message body's encoding for the disclaimer. If that fails, the system can try to edit the message body to use an encoding that is compatible with the message body as well as the disclaimer. Should the system try to re-encode the message body in such a case? [Y]>

If the disclaimer that is added to the footer or header of the message generates an error when decoding the message body, it is added at the top of the message body. This prevents you to rewrite a new message content that must merge with the original message content and the header/footer-stamp. The disclaimer is now added as an additional MIME part that displays only the header disclaimer as an inline content, and the rest of the message content is split into separate email attachments. Should the system try to ignore such errors when decoding the message body? [N]>

Behavior when modifying headers: Use encoding of message body  
 Behavior for untagged non-ASCII headers: Impose encoding of message body  
**Behavior for mismatched footer or heading encoding: Try both body and footer or heading encodings**  
 Behavior when decoding errors found: Disclaimer is displayed as inline content and the message body is added as an attachment.

Choose the operation you want to perform:  
 - SETUP - Configure multi-lingual settings.  
 [ ]>

The first prompt determines whether or not a message header's encoding should be changed to match that of the message body if the header is changed (via a filter, for example).

The second prompt controls whether or not the email gateway should impose the encoding of the message body on the header if the header is not properly tagged with a character set.

The third prompt is used to configure how disclaimer stamping (and multiple encodings) in the message body works. Please see "Disclaimer Stamping and Multiple Encodings" in the "Text Resources" chapter for more information.

The fourth prompt is used to configure the behaviour of disclaimer stamping, if an error is generated during the decoding of the message body. If you select 'Yes', the decoding errors are ignored and the disclaimer is stamped. If you select 'No', the disclaimer text is added as an attachment to the message.

## Sample Message Filters

In the following example, the filter command is used to create three new filters:

- The first filter is named **big\_messages**. It uses the `body-size` rule to drop messages larger than 10 megabytes.
- The second filter is named **no\_mp3s**. It uses the `attachment-filename` rule to drop messages that contain attachments with the filename extension of `.mp3`.
- The third filter is named **mailfrompm**. It uses `mail-from` rule examines all mail from `postmaster@example.com` and `blind-carbon copies administrator@example.com`.

Using the `filter -> list` subcommand, the filters are listed to confirm that they are active and valid, and then the first and last filters are switched in position using the `move` subcommand. Finally, the changes are committed so that the filters take effect.

```
mail3.example.com> filters

Choose the operation you want to perform:

- NEW - Create a new filter.

- IMPORT - Import a filter script from a file.

[ ]> new

Enter filter script. Enter '.' on its own line to end.

big_messages:

if (body-size >= 10M) {

drop();

}

.

1 filters added.

Choose the operation you want to perform:

- NEW - Create a new filter.

- DELETE - Remove a filter.

- IMPORT - Import a filter script from a file.

- EXPORT - Export filters to a file

- MOVE - Move a filter to a different position.

- SET - Set a filter attribute.

- LIST - List the filters.

- DETAIL - Get detailed information on the filters.

- LOGCONFIG - Configure log subscriptions used by filters.

- ROLLOVERNOW - Roll over a filter log file.

[ ]> new
```

Enter filter script. Enter '.' on its own line to end.

no\_mp3s:

```
if (attachment-filename == '(?i)\\.mp3$') {  
  drop();  
}
```

.

1 filters added.

Choose the operation you want to perform:

- NEW - Create a new filter.
- DELETE - Remove a filter.
- IMPORT - Import a filter script from a file.
- EXPORT - Export filters to a file
- MOVE - Move a filter to a different position.
- SET - Set a filter attribute.
- LIST - List the filters.
- DETAIL - Get detailed information on the filters.
- LOGCONFIG - Configure log subscriptions used by filters.
- ROLLOVERNOW - Roll over a filter log file.

[> new

Enter filter script. Enter '.' on its own line to end.

mailfrompm:

```
if (mail-from == "^postmaster$")  
{ bcc ("administrator@example.com");}
```

.

1 filters added.

Choose the operation you want to perform:

- NEW - Create a new filter.
- DELETE - Remove a filter.
- IMPORT - Import a filter script from a file.
- EXPORT - Export filters to a file
- MOVE - Move a filter to a different position.
- SET - Set a filter attribute.

- LIST - List the filters.
- DETAIL - Get detailed information on the filters.
- LOGCONFIG - Configure log subscriptions used by filters.
- ROLLOVERNOW - Roll over a filter log file.

```
[> list
```

```
Num Active Valid Name
```

```
1 Y Y big_messages
```

```
2 Y Y no_mp3s
```

```
3 Y Y mailfrompm
```

```
Choose the operation you want to perform:
```

- NEW - Create a new filter.
- DELETE - Remove a filter.
- IMPORT - Import a filter script from a file.
- EXPORT - Export filters to a file
- MOVE - Move a filter to a different position.
- SET - Set a filter attribute.
- LIST - List the filters.
- DETAIL - Get detailed information on the filters.
- LOGCONFIG - Configure log subscriptions used by filters.
- ROLLOVERNOW - Roll over a filter log file.

```
[> move
```

```
Enter the filter name, number, or range to move:
```

```
[> 1
```

```
Enter the target filter position number or name:
```

```
[> last
```

```
1 filters moved.
```

```
Choose the operation you want to perform:
```

- NEW - Create a new filter.
- DELETE - Remove a filter.
- IMPORT - Import a filter script from a file.
- EXPORT - Export filters to a file
- MOVE - Move a filter to a different position.

```
- SET - Set a filter attribute.
- LIST - List the filters.
- DETAIL - Get detailed information on the filters.
- LOGCONFIG - Configure log subscriptions used by filters.
- ROLLOVERNOW - Roll over a filter log file.

[]> list

Num Active Valid Name
1 Y Y no_mp3s
2 Y Y mailfrompm
3 Y Y big_messages

Choose the operation you want to perform:
- NEW - Create a new filter.
- DELETE - Remove a filter.

- IMPORT - Import a filter script from a file.
- EXPORT - Export filters to a file
- MOVE - Move a filter to a different position.
- SET - Set a filter attribute.
- LIST - List the filters.
- DETAIL - Get detailed information on the filters.
- LOGCONFIG - Configure log subscriptions used by filters.
- ROLLOVERNOW - Roll over a filter log file.

[]> move

Enter the filter name, number, or range to move:

[]> 2

Enter the target filter position number or name:

[]> 1

1 filters moved.

Choose the operation you want to perform:
- NEW - Create a new filter.
- DELETE - Remove a filter.
- IMPORT - Import a filter script from a file.
```

- EXPORT - Export filters to a file
- MOVE - Move a filter to a different position.
- SET - Set a filter attribute.
- LIST - List the filters.
- DETAIL - Get detailed information on the filters.
- LOGCONFIG - Configure log subscriptions used by filters.
- ROLLOVERNOW - Roll over a filter log file.

```
[> list
```

```
Num Active Valid Name
```

```
1 Y Y mailfrompm
```

```
2 Y Y no_mp3s
```

```
3 Y Y big_messages
```

```
Choose the operation you want to perform:
```

- NEW - Create a new filter.
- DELETE - Remove a filter.
- IMPORT - Import a filter script from a file.
- EXPORT - Export filters to a file
- MOVE - Move a filter to a different position.
- SET - Set a filter attribute.
- LIST - List the filters.
- DETAIL - Get detailed information on the filters.
- LOGCONFIG - Configure log subscriptions used by filters.
- ROLLOVERNOW - Roll over a filter log file.

```
[>
```

```
mail3.example.com> commit
```

```
Please enter some comments describing your changes:
```

```
[> entered and enabled 3 filters: no_mp3s, mailfrompm, big_messages
```

```
Do you want to save the current configuration for rollback? [Y]> n
```

```
Changes committed: Fri May 23 11:42:12 2014 GMT
```

# Message Filter Examples

This section contains some real world examples of filters with a brief discussion of each.

## Related Topics

- [Open-Relay Prevention Filter, on page 240](#)
- [Policy Enforcement Filters, on page 240](#)
- [Routing and Domain Spoofing, on page 244](#)
- [Drop Message Attachments that match File SHA-256 Filter, on page 247](#)
- [Drop Messages if Attachment matches File SHA-256 Filter, on page 247](#)

## Open-Relay Prevention Filter

This filter bounces messages with addresses using %, extra @, and ! characters in email addresses:

```

• user%otherdomain@validdomain
• user@otherdomain@validdomain:
• domain!user@validdomain

sourceRouted:

if (rcpt-to == "(%|@|!)(.*)@") {

bounce();

}

```

The email gateways are not susceptible to these third party relay hacks that are often used to exploit traditional Sendmail/Qmail systems. As many of these symbols (for example %) can be part of a perfectly legal email address, email gateways will accept these as valid addresses, verify them against the configured recipient lists, and pass them on to the next internal server. The email gateways do not relay these messages to the world.

These filters are put in place to protect users who may have open-source MTAs that are misconfigured to allow relay of these types of messages.



---

**Note** You can also configure a listener to handle these types of addresses. See [Listening for Connection Requests by Creating a Listener Using Web Interface, on page 71](#) for more information.

---

## Policy Enforcement Filters

- [Notify Based on Subject Filter, on page 241](#)
- [BCC and Scan Mail Sent to Competitors, on page 241](#)
- [Block Specific User Filter, on page 241](#)
- [Archive and Drop Messages Filter, on page 241](#)
- [Large “To:” Header Filter, on page 242](#)



- [Blank “From:” Filter, on page 242](#)
- [IP Reputation Filter, on page 243](#)
- [Alter IP Reputation Filter, on page 243](#)
- [Filename Regex Filter, on page 243](#)
- [Show IP Reputation Score in Header Filter, on page 243](#)
- [Insert Policy into Header Filter, on page 243](#)
- [Too Many Recipients Bounce Filter, on page 244](#)

## Notify Based on Subject Filter

This filter sends notification based on whether the subject contains specific words:

```
search_for_sensitive_content:

if (Subject == "(?i)plaintiff|lawsuit|judge" ) {

    notify ("admin@company.com");

}
```

## BCC and Scan Mail Sent to Competitors

This filter scans and blind copies messages that are sent to competitors. Note that you could use a dictionary and the `header-dictionary-match()` rule to specify a more flexible list of competitors (see [Dictionary Rules, on page 165](#)):

```
competitorFilter:

if (rcpt-to == '@competitor1.com|@competitor2.com') {

    bcc-scan('legal@example.com');

}
```

## Block Specific User Filter

Use this filter to block email from a specific address:

```
block_harrasing_user:

if (mail-from == "ex-employee@hotmail\\.com") {

    notify ("admin@company.com");

    drop ();

}
```

## Archive and Drop Messages Filter

Log and drop only the messages that have matching filetypes:

```

drop_attachments:
if (mail-from != "user@example.com") AND (attachment-filename ==
'(?i)\.(asp|bas|bat|cmd|cpl|exe|hta|ins|isp|js)$')
{
archive("Drop_Attachments");
insert-header("X-Filter", "Dropped by: $FilterName MID: $MID");
drop-attachments-by-name("\.(asp|bas|bat|cmd|cpl|exe|hta|ins|isp|js)$");
}

```

## Large "To:" Header Filter

Find messages with very large "To" headers.

Use the `archive()` line for verification of proper action, with `drop()` enabled or disabled for extra safety:

```

toTooBig:
if(header('To') == "^.{500,}") {
archive('tooTooBigdropped');
drop();
}

```

## Blank "From:" Filter

Identify blank "From" headers,

This filter can alleviate various forms of blank "from" addresses:

```

blank_mail_from_stop:
if (recv-listener == "InboundMail" AND header("From") == "^$|<\s*>") {
drop ();
}

```

If you also want to drop messages with a blank envelope from, use this filter:

```

blank_mail_from_stop:
if (recv-listener == "InboundMail" AND (mail-from == "^$|<\s*>" OR header ("From") ==
"^$|<\s*>"))
{
drop ();
}

```

```
}

```

## IP Reputation Filter

IP Reputation filter:

```
note_bad_reps:
if (reputation < -2) {
strip-header ('Subject');

insert-header ('Subject', '***BadRep $Reputation *** $Subject');
}
```

## Alter IP Reputation Filter

Alter the IP Reputation Score threshold for certain domains:

```
mod_ipr:
if ( (rcpt-count == 1) AND (rcpt-to == "@domain\\.com$") AND (reputation < -2) ) {
drop ();
}
```

## Filename Regex Filter

This filter specifies a range of size for the body of the message, and looks for an attachment that matches the regular expression (this matches files named “readme.zip”, “readme.exe”, “attach.exe”, and so forth.):

```
filename_filter:
if ((body-size >= 9k) AND (body-size <= 20k)) {
if (body-contains ("(?i)(readme|attach|information)\\. (zip|exe)$")) {
drop ();

}

}
```

## Show IP Reputation Score in Header Filter

Remember to log the headers (see the “Logging” chapter) so they appear in the mail log:

```
Check_ipr:

if (true) {

insert-header('X-ipr', '$Reputation');

}
```

## Insert Policy into Header Filter

Show which mail flow policy accepted the connection:

```
Policy_Tracker:
if (true) {
insert-header ('X-HAT', 'Sender Group $Group, Policy $Policy applied.');
```

## Too Many Recipients Bounce Filter

Bounce all outbound email messages with more than 50 recipients from more than two unique domains:

```
bounce_high_rcpt_count:
if ( (rcpt-count > 49) AND (rcpt-to != "@example\\.com$") ) {
bounce-profile ("too_many_rcpt_bounce"); bounce ();
}
```

## Routing and Domain Spoofing

- [Using Virtual Gateways Filter, on page 244](#)
- [Same Listener for Deliver and Listener Filter, on page 244](#)
- [Single Listener Filter, on page 245](#)
- [Drop Spoofed Domain Filter \(Single Listener\), on page 245](#)
- [Drop Spoofed Domain Filter \(Multiple Listeners\), on page 245](#)
- [Another Drop Spoofed Domain Filter, on page 246](#)
- [Detect Looping Filter, on page 246](#)

## Using Virtual Gateways Filter

Segment traffic using virtual gateways. Assuming you have two Interfaces on the system, 'public1' and 'public2', and the default delivery interface is 'public1'. This would force all of your outbound traffic over the second interface; since bounces and other similar types of mail do not go through filters, they will be delivered from public1:

```
virtual_gateways:
if (rcv-listener == "OutboundMail") {
alt-src-host ("public2");
}
```

## Same Listener for Deliver and Listener Filter

Use the same listener for delivery and receiving. This filter will allow you to send any messages received on the public listener "listener1" out the interface "listener1" (you will have to set up a unique filter for each public listener configured):

```

same_listener:
if (recv-inj == 'listener1') {
alt-src-host('listener1');
}

```

## Single Listener Filter

Make the filter work on a single listener. For example, specify a specific listener for message filter processing instead of being performed system wide.

```

textfilter-new:
if (recv-inj == 'inbound' and body-contains("some spammy message")) {
alt-rcpt-to ("spam.quarantine@spam.example.com");
}

```

## Drop Spoofed Domain Filter (Single Listener)

Drop email with a spoofed domain (pretending to be from an internal address; works with a single listener). IP addresses below represent fictional domain for `mycompany.com` :

```

DomainSpoofed:
if (mail-from == "mycompany\\.com$") {
if ((remote-ip != "1.2.") AND (remote-ip != "3.4.")) {
drop();
}
}

```

## Drop Spoofed Domain Filter (Multiple Listeners)

As above, but works with multiple listeners:

```

domain_spoof:
if ((recv-listener == "Inbound") and (mail-from == "@mycompany\\.com")) {
archive('domain_spoof');
drop ();
}

```

## Another Drop Spoofed Domain Filter

Summary: Anti domain spoof filter:

```
reject_domain_spoof:
if (recv-listener == "MailListener") {
insert-header("X-Group", "$Group");
if ((mail-from == "@ttest\\.mycompany\\.com") AND (header("X-Group") != "RELAYLIST")) {
notify("me@here.com");
drop();
strip-header("X-Group");
}
}
```

## Detect Looping Filter

This filter is used to detect, stop, and determine what is causing a mail loop. This filter can help determine a configuration issue on the Exchange server or elsewhere.

```
External_Loop_Count:
if (header("X-ExtLoop1")) {
if (header("X-ExtLoopCount2")) {
if (header("X-ExtLoopCount3")) {
if (header("X-ExtLoopCount4")) {
if (header("X-ExtLoopCount5")) {
if (header("X-ExtLoopCount6")) {
if (header("X-ExtLoopCount7")) {
if (header("X-ExtLoopCount8")) {
if (header("X-ExtLoopCount9")) {
notify ('joe@example.com');
drop();
}
else {insert-header("X-ExtLoopCount9", "from
$RemoteIP");}}
else {insert-header("X-ExtLoopCount8", "from $RemoteIP");}}
else {insert-header("X-ExtLoopCount7", "from $RemoteIP");}}
else {insert-header("X-ExtLoopCount6", "from $RemoteIP");}}
```

```

else {insert-header("X-ExtLoopCount5", "from $RemoteIP");}
else {insert-header("X-ExtLoopCount4", "from $RemoteIP");}
else {insert-header("X-ExtLoopCount3", "from $RemoteIP");}
else {insert-header("X-ExtLoopCount2", "from $RemoteIP");}
else {insert-header("X-ExtLoop1", "1");
}

```



---

**Note** By default, AsyncOS automatically detects mail loops and will drop messages after 100 loops.

---

## Drop Message Attachments that match File SHA-256 Filter

Use this filter to drop all message attachments in messages that match the specific file SHA-256 value in the file hash list

```

File_Hash_Message_Filter: if (true)
{ drop-attachments-by-hash("SHA-256_hash_list"); }

```

## Drop Messages if Attachment matches File SHA-256 Filter

Use this filter to drop all messages if the message attachments match the specific file SHA-256 value in the file hash list.

```

File_Hash_Message_Filter: if (attachment-hashlist-match("SHA-256_hash_list"))
{ drop(); }

```

## Configuring Scan Behavior

You can control the behavior of body and attachment scanning, such as the attachment types to be skipped during a scan by configuring the scanning parameters. Use the Scan Behavior page or the `scanconfig` command to configure these parameters. Scan behavior settings are global settings, meaning that they affect the behavior of all the scans.



---

**Note** If you want to scan a MIME type that may be included in a zip or compressed file, you must include list 'compressed' or 'zip' or 'application/zip' in the scan list.

---

### Procedure

---

- Step 1** Click **Security Services > Scan Behavior**.
- Step 2** Define the attachment type mapping. Do one of the following:
- Add a new attachment type mapping. Click **Add Mapping**.

- Import a list of attachment type mappings using a configuration file. Click **Import List**, and import the desired configuration file from the configuration directory.

**Note** To perform this step, the configuration file must be present in the configuration directory of your email gateway. See [Managing the Configuration File, on page 1021](#).

- Click **Edit** to modify an existing attachment type mapping.

**Step 3** Configure the global settings. Do the following:

- Under Global Settings, click **Edit Global Settings**.
- Edit the required fields:

Field	Description
<b>Action for attachments with MIME types / fingerprints in table above</b>	Choose whether to scan or skip attachments types defined in the attachment type mapping.
<b>Maximum depth of attachment recursion to scan</b>	Specify the level up to which the recursive attachments are to be scanned.
<b>Maximum attachment size to scan</b>	Specify the maximum size of attachments to scan.
<b>Attachment Metadata scan</b>	Specify whether to scan or skip metadata of the attachments.
<b>Attachment scanning timeout</b>	Specify the scanning time-out period.
<b>Assume attachment matches pattern if not scanned for any reason</b>	Specify whether to consider unscanned attachments as match to the search pattern.
<b>Action when message cannot be deconstructed to remove specified attachments</b>	Specify the action to be taken when a message could not be deconstructed to remove specified attachments.
<b>Bypass all filters in case of a content or message filter error</b>	Specify whether to bypass all filters in case of a content or message filter error.
<b>Encoding to use when none is specified</b>	Specify the encoding to be used if no encoding is specified.
<b>Convert opaque-signed messages to clear-signed (S/MIME unpacking)</b>	Specify whether to convert opaque-signed messages to clear-signed (S/MIME unpacking).
<b>Safe Print Settings</b>	
Maximum File Size	Enter the maximum attachment size for a safe-printed attachment.  <b>Note</b> If the 'Maximum File Size' value exceeds the 'Maximum Message Size to Scan' value configured for Outbreak Filters on your email gateway, then the message and the message attachment is not scanned by Outbreak Filters in the email pipeline.



Field	Description
Maximum Page Count	Enter the maximum number of pages that you want to safe print in a message attachment.
Document Quality	<p>Select the <b>Use Default Value (70)</b> option to use the recommended image quality value for a safe-printed attachment.</p> <p><b>Note</b> You can also select the <b>Enter Custom Value</b> option and enter a custom image quantity value for a safe-printed attachment.</p>
File Type Selection	Select the required file types from the appropriate file groups (for example, “Microsoft Documents”) that you can use to safe print a message attachment.
Watermark	<p>Select <b>Enabled</b> option to add a watermark to a safe-printed attachment.</p> <p><b>Note</b> You can enter a custom text for the watermark in the <b>Enter Custom Text:</b> field.</p>
Cover Page	<p>Select <b>Enabled</b> option to add a cover page to a safe-printed attachment.</p> <p><b>Note</b> You can enter a custom text for the cover page in the <b>Enter Custom Text</b> field.</p>
For more information, see <a href="#">How to Configure Email Gateway to Safe Print Message Attachments, on page 342</a> .	
<b>Scanning of Password-protected Attachments</b>	

Field	Description
Enable Scanning of Password-Protected Attachments:	<p>Select the <b>Enabled</b> option under <b>Inbound Mail Traffic</b> or <b>Outbound Mail Traffic</b> to allow the Content Scanner in your email gateway to scan the contents of password-protected attachments in incoming or outgoing messages.</p> <p><b>Note</b> Suppose the DLP scanning engine is enabled in your email gateway. In that case, if the password extraction is successful, the password-protected attachment contents are scanned by the DLP engine per the configured DLP policies.</p> <p><b>Important</b></p> <ul style="list-style-type: none"> <li>• Suppose the Content Scanner can extract the password from the body of the message and scan the attachment contents successfully. In that case, the password and attachment is sent to Cisco AMP Threat Grid, if configured in your email gateway and the file is recommended for file analysis.</li> <li>• The Content Scanner extracts the password from the body of the message with the best effort. The extracted password is not stored in your email gateway after the scanning is complete.</li> </ul>

Field	Description
Probable User-defined Password for Analysis:	<p>Select the <b>Enabled</b> option to create a user-defined passphrase to open password-protected attachments in incoming or outgoing messages.</p> <p>Click <b>Add Row</b> if you want to add more than one user-defined passphrase.</p> <p><b>Notes:</b></p> <ul style="list-style-type: none"> <li>• You can create a user-defined passphrase up to 128 characters only. .</li> <li>• You can create up to a maximum of five user-defined passphrases.</li> <li>• You can change the priority of the user-defined passphrase by entering the required user-defined passphrase in the <b>Password</b> field that corresponds to the required priority.</li> <li>• [For Inbound Mail only] The passphrases extracted from the message body take precedence over the user-defined passphrases used to open the password-protected attachments for incoming messages.</li> <li>• [For Outbound Mail only] The user-defined passphrases take precedence over the passphrases extracted from the message body used to open the password-protected attachments for outgoing messages.</li> </ul> <p>[Optional] <b>Apply User-defined Passwords Only</b> checkbox: Select this checkbox if you want to open password-protected attachments in incoming and outgoing messages using only user-defined passphrases. When you select this checkbox, the email gateway does not use the passphrases extracted from the email body to open the password-protected attachments.</p> <p><b>Note</b> If you do not enable the 'Probable User-defined Password for Analysis' option button, the 'Apply User-defined Passwords Only' checkbox is disabled by default.</p>
<b>Actions for Unscannable Messages due to decoding errors found during URL Filtering Actions</b>	Specify the actions to take when a message cannot be scanned by the Content Scanner due to decoding errors found during URL filtering actions.

Field	Description
<b>Action for unscannable messages due to extraction failures</b>	Specify the actions to take when a message cannot be scanned by the Content Scanner because of an attachment extraction failure.
<b>Action for unscannable messages due to RFC violations</b>	Specify the actions to take when a message cannot be scanned by the Content Scanner because of an RFC violation.

c) Click **Submit**.

**Step 4** (Optional) Manually update the Content Scanner files. Under **Current Content Scanner files**, click **Update Now**.

Usually, these files are automatically updated using update server.

**Note** You can also use the `contentsscannerupdate` in CLI to manually update these files.

**Step 5** Commit the changes.

## Configuring Message Handling Actions for Unscannable Messages

The Content Scanner in your email gateway can now handle messages that are not scanned due to the following reasons:

- File extraction failure
- RFC violation
- Decoding errors found during URL Filtering actions

You can configure any one of the following message handling actions on messages that are not scanned by the Content Scanner:

- Drop the message
- Deliver the message as it is
- Send the message to the policy quarantine

You can click on the **Edit Global Settings** button in the Security Services > Scan Behavior page of the web interface, to enable and configure message handling actions on messages that are not scanned by the Content Scanner.

### Delivering the Message

You can perform the following additional actions, if you choose to deliver the message:

- Modify the message subject
- Add a custom header to the message
- Modify the message recipient

- Send message to alternate destination host



**Note** These actions are not mutually exclusive; you can combine some or all of them differently within different incoming or outgoing policies for different processing needs for groups of users.

### Modifying Message Subject

You can alter the text of messages that are not scanned by the Content Scanner by prepending or appending certain text strings to help users easily identify and sort identified messages.



**Note** White space is not ignored in the “Modify message subject” field. Add spaces after (if prepending) or before (if appending) the text you enter in this field to separate your added text from the original subject of the message. For example, add the text [WARNING: UNSCANNABLE EXTRACTION FAILURE] with a few trailing spaces if you are prepending.

The default text that is added to the subject of the message that is not scanned by the Content Scanner:

Reason	Default Text Added to Subject
Extraction failure	[WARNING: UNSCANNABLE EXTRACTION FAILED]
RFC Violation	[WARNING: UNSCANNABLE RFC NON-COMPLIANT]
Decoding errors found during URL Filtering actions	[WARNING: DECODING ERRORS WHEN APPLYING URL FILTERING ACTIONS]

### Adding Custom Header to Message

You can define an additional, custom header to add to all messages that are not scanned by the Content Scanner. Click **Yes** and define the header name and text.

### Modifying Message Recipient

You can modify the message recipient, causing the message that is not scanned by the Content Scanner to be delivered to a different address. Click **Yes** and enter the new recipient address.

### Sending Message to Alternate Destination Host

You can choose to send the notification to a different recipient or destination host for messages that are not scanned by the Content Scanner. Click **Yes** and enter an alternate address or host.

For example, you can route messages that are not scanned by the Content Scanner to an administrator’s mailbox or a special mail server for subsequent examination. In the case of a multi-recipient message, only a single copy is sent to the alternative recipient.

## Sending Message to Policy Quarantine

When flagged for quarantine, the message that is not scanned by the Content Scanner continues through the rest of the email pipeline. When the message reaches the end of the pipeline, if the message has been flagged

for one or more quarantines then it enters those queues. Note that if the message does not reach the end of the pipeline, it is not placed in a quarantine.

For example, a content filter can cause a message to be dropped or bounced, in which case the message will not be quarantined.



---

**Note** If a policy quarantine is not defined in your email gateway, you cannot send the message to the quarantine.

---

You can perform the following additional actions, if you choose to send the message to the policy quarantine:

- Modify the message subject
- Add a custom header to the message

### Modifying Message Subject Header

You can alter the text of messages that are sent to the policy quarantine by prepending or appending certain text strings to help users easily identify and sort identified messages.



---

**Note** White space is not ignored in the “Modify message subject” field. Add spaces after (if prepending) or before (if appending) the text you enter in this field to separate your added text from the original subject of the message. For example, add the text [WARNING: UNSCANNABLE EXTRACTION FAILURE] with a few trailing spaces if you are prepending.

---

The default text that is added to the subject of the message that is sent to the policy quarantine:

Reason	Default Text Added to Subject
Extraction failure	[WARNING: UNSCANNABLE EXTRACTION FAILED]
RFC Violation	[WARNING: UNSCANNABLE RFC NON-COMPLIANT]
Decoding errors found during URL Filtering actions	[WARNING: DECODING ERRORS WHEN APPLYING URL FILTERING ACTIONS]

### Adding Custom Header to Message

You can define an additional, custom header to add to all messages that are sent to the policy quarantine. Click **Yes** and define the header name and text.



## CHAPTER 10

# Mail Policies

---

This chapter contains the following sections:

- [Overview of Mail Policies, on page 255](#)
- [How to Enforce Mail Policies on a Per-User Basis, on page 256](#)
- [Handling Incoming and Outgoing Messages Differently, on page 257](#)
- [Matching Users to a Mail Policy, on page 257](#)
- [Message Splintering, on page 260](#)
- [Configuring Mail Policies, on page 261](#)
- [Setting Priority for Message Headers, on page 266](#)

## Overview of Mail Policies

The email gateway enforces your organization's policies for messages sent to and from your users through the use of mail policies. These are sets of rules that specify the types of suspect, sensitive, or malicious content that your organization may not want entering or leaving your network. This content may include:

- spam
- legitimate marketing messages
- graymail
- viruses
- phishing and other targeted mail attacks
- confidential corporate data
- personally identifiable information

You can create multiple policies that satisfy the disparate security needs of the different user groups within your organization. The email gateway uses the rules defined in these policies to scan each message and, if necessary, perform an action to protect your user. For example, policies can prevent the delivery of suspected spam messages to executives while allowing their delivery to IT staff but with a modified subject to warn them of the content, or drop dangerous executable attachments for all users except those in the System Administrator group.

# How to Enforce Mail Policies on a Per-User Basis

## Procedure

	Command or Action	Purpose
<b>Step 1</b>	Enable the content-scanning features that you want the email gateway to use for incoming or outgoing messages.	The features you can enable and configure one or more of the following: <ul style="list-style-type: none"> <li>• <a href="#">Anti-Virus</a>, on page 361</li> <li>• <a href="#">File Reputation Filtering and File Analysis</a>, on page 477 (incoming messages only)</li> <li>• <a href="#">Managing Spam and Graymail</a>, on page 379</li> <li>• <a href="#">Graymail Detection and Safe Unsubscribe</a>. See <a href="#">Managing Spam and Graymail</a>, on page 379.</li> <li>• <a href="#">Outbreak Filters</a>, on page 421</li> <li>• <a href="#">Data Loss Prevention</a>, on page 505 (outgoing messages only)</li> <li>• <a href="#">Content Filters</a>, on page 269</li> </ul>
<b>Step 2</b>	(Optional) Create content filters for actions to take on messages that contain specific data.	See <a href="#">Content Filters</a> , on page 269
<b>Step 3</b>	(Optional) Define an LDAP group query in order to specify users to whom the mail policy rules apply.	See <a href="#">Using Group LDAP Queries to Determine if a Recipient is a Group Member</a> , on page 792.
<b>Step 4</b>	(Optional) Define the default mail policies for incoming or outgoing messages.	See <a href="#">Configuring the Default Mail Policy for Incoming or Outgoing Messages</a> , on page 261.
<b>Step 5</b>	Define the group of users for whom you want to set up user-specific mail policies.	Create an incoming or outgoing mail policy. See <a href="#">Configuring Mail Policies</a> , on page 261 for more information.
<b>Step 6</b>	Configure the content security features and the content filter actions the email gateway takes on messages.	Configure the different content security features for the mail policy. <ul style="list-style-type: none"> <li>• <a href="#">Content Filters: Applying the Content Filter to Messages for a Certain User Group</a>, on page 289</li> <li>• <a href="#">Anti-Virus: Configuring Virus Scanning Actions for Users</a>, on page 367</li> <li>• <a href="#">File Reputation Filtering and File Analysis: File Reputation Filtering and File Analysis</a>, on page 477</li> <li>• <a href="#">Anti-Spam: Defining Anti-Spam Policies</a>, on page 395</li> </ul>



	Command or Action	Purpose
		<ul style="list-style-type: none"> <li>• <a href="#">Graymail Detection and Safe Unsubscribe: Configuring the Incoming Mail Policy for Graymail Detection and Safe Unsubscribing, on page 390</a></li> <li>• <a href="#">Outbreak Filters: The Outbreak Filters Feature and the Outbreak Quarantine, on page 439</a></li> <li>• <a href="#">Data Loss Prevention: Using Outgoing Mail Policies to Assign DLP Policies to Senders and Recipients, on page 525.</a></li> </ul>

## Handling Incoming and Outgoing Messages Differently

The email gateway uses two different sets of mail policies for message content security:

- *Incoming mail policies* for messages are messages received from connections that match an ACCEPT HAT policy in any listener.
- *Outgoing mail policies* for messages are messages from connections that match a RELAY HAT policy in any listener. This includes any connection that was authenticated with SMTP AUTH.

Having separate sets of policies allow you to define different security rules for messages sent to your users and messages sent from your users. You manage these policies using the **Mail Policies > Incoming Mail Policies** or **Outgoing Mail Policies** pages in the GUI, or the `policyconfig` command in the CLI.



**Note** Some features can be applied only to incoming or to outgoing mail policies. For example, Data Loss Prevention scanning can only be performed on outgoing messages. Advanced Malware Protection (File Reputation scanning and File Analysis) is available in Incoming Mail Policies and Outgoing Mail Policies.

In certain installations, “internal” mail being routed through the Cisco appliance may be considered *outgoing*, even if all the recipients are addressed to internal addresses. For example, by default for C170 and C190 appliances, the system setup wizard will configure only one physical Ethernet port with one listener for receiving inbound email and relaying outbound email.

## Matching Users to a Mail Policy

As messages are received by the email gateway, the email gateway attempts to match each message recipient and sender to a mail policy in the Incoming or Outgoing Mail Policies table, depending on whether it is an incoming or outgoing message.

Matches are based on the recipient’s address, the sender’s address, or both:

- *Recipient address* matches the Envelope Recipient address

When matching recipient addresses, the recipient addresses entered are the final addresses after processing by preceding parts of the email pipeline. For example, if enabled, the default domain, LDAP routing or

masquerading, alias table, domain map, and message filters features can rewrite the Envelope Recipient address and may affect whether the message matches a mail policy.

- *Sender address* matches:
  - Envelope Sender (RFC821 MAIL FROM address)
  - Address found in the RFC822 From: header
  - Address found in the RFC822 Reply-To: header

Addresses may be matched on either a full email address, user, domain, or partial domain, and addresses may also match LDAP group membership.

### Related Topics

- [First Match Wins, on page 258](#)
- [Examples of Policy Matching, on page 258](#)

## First Match Wins

Each user (sender or recipient) is evaluated for each mail policy defined the appropriate mail policy table in a top-down fashion.

For each user, the first matching policy wins. If a user does not match any specific policy, user will automatically match the default policy of the table.

If a match is made based on a sender address, all remaining recipients of a message will match that policy. (This is because there can be only one sender per message.)

The envelope sender and the envelope recipient have a higher priority over the sender header when you match a message to a mail policy. If you configure a mail policy to match a specific user, the messages are automatically classified into the mail policy based on the envelope sender and the envelope recipient.

## Examples of Policy Matching

The following examples help show how the policy tables are matched in a top-down fashion.

Given the following Incoming Mail Email Security Policy table shown in the following table, incoming messages will match different policies.

**Table 30: Policy Matching Example**

Order	Policy Name	Users	
		Sender	Recipient
1	special_people	ANY	joe@example.com ann@example.com
2	from_lawyers	@lawfirm.com	ANY
3	acquired_domains	ANY	@newdomain.com @anotherexample.com

Order	Policy Name	Users	
4	engineering	ANY	PublicLDAP.ldapgroup:engineers
5	sales_team	ANY	jim@john@larry@
6	Default Policy	ANY	ANY

### Related Topics

- [Example 1, on page 259](#)
- [Example 2, on page 259](#)
- [Example 3, on page 259](#)

## Example 1

A message from sender `bill@lawfirm.com` sent to recipient `jim@example.com` matches:

- Policy #2 when the user description matches the sender ( `@lawfirm.com` ) and the recipient ( `ANY` ).
- Policy #2 when the envelope sender is `bill@lawfirm.com`.
- Policy #5 when the header sender is `bill@lawfirm.com` but the envelope sender does not match `@lawfirm.com`.

## Example 2

Sender `joe@yahoo.com` sends an incoming message with three recipients: `john@example.com`, `jane@newdomain.com`, and `bill@example.com` :

- The message for recipient `jane@newdomain.com` will receive the anti-spam, anti-virus, outbreak filters, and content filters defined in policy #3.
- The message for recipient `john@example.com` will receive the settings defined in policy #5.
- Because the recipient `bill@example.com` does not match the engineering LDAP query, the message will receive the settings defined by the default policy.

This example shows how messages with multiple recipients can incur *message splintering* . See [Message Splintering, on page 260](#) for more information.

## Example 3

Sender `bill@lawfirm.com` (`bill@lawfirm.com` is used for envelope sender) sends a message to recipients `ann@example.com` and `larry@example.com` :

- The recipient `ann@example.com` will receive the anti-spam, anti-virus, outbreak filters, and content filters defined in policy #1.
- The recipient `larry@example.com` will receive the anti-spam, anti-virus, outbreak filters, and content filters defined in policy #2, because the sender ( `@lawfirm.com` ) and the recipient ( `ANY` ) matches.

# Message Splintering

Intelligent message splintering is the mechanism that allows for differing recipient-based content security rules to be applied independently to message with multiple recipients.

Each recipient is evaluated for each policy in the appropriate mail policy table (Incoming or Outgoing) in a top-down fashion.

Each policy that matches a message creates a new message with those recipients. This process is defined as *message splintering* :

- If some recipients match different policies, the recipients are grouped according to the policies they matched, the message is split into a number of messages equal to the number of policies that matched, and the recipients are set to each appropriate “splinter.”
- If all recipients match the same policy, the message is not splintered. Conversely, a maximum splintering scenario would be one in which a single message is splintered for each message recipient.
- Each message splinter is then processed by anti-spam, anti-virus, Advanced Malware Protection (incoming messages only), DLP scanning (outgoing messages only), Outbreak Filters, and content filters independently in the email pipeline.

The following table illustrates the point at which messages are splintered in the email pipeline.

Work Queue	Message Filters (filters)	Email Security Manager Scanning (Per Recipient)	↓ Message for all recipients
	<b>Anti-Spam</b> ( <code>antispamconfig</code> , <code>antispamupdate</code> )		Messages are splintered immediately <i>after</i> message filter processing but <i>before</i> anti-spam processing:
	<b>Anti-Virus</b> ( <code>antivirusconfig</code> , <code>antivirusupdate</code> )		Message for all recipients matching policy 1
	<b>File Reputation and Analysis (Advanced Malware Protection)</b> ( <code>ampconfig</code> )		Message for all recipients matching policy 2
	<b>Graymail Management</b>		Message for all other recipients (matching the default policy)
	<b>Content Filters</b> ( <code>policyconfig -&gt; filters</code> )		<b>Note</b> DLP scanning is only performed on outgoing messages.
	<b>Outbreak Filters</b> ( <code>outbreakconfig</code> , <code>outbreakflush</code> , <code>outbreakstatus</code> , <code>outbreakupdate</code> )		
	<b>Data Loss Prevention</b> ( <code>policyconfig</code> )		



---

**Note** New MIDs (message IDs) are created for each message splinter (for example, MID 1 becomes MID 2 and MID 3). For more information, see the “Logging” chapter. In addition, the `trace` function shows which policies cause a message to be split.

---

Policy matching and message splintering in Email Security Manager policies obviously affect how you manage the message processing available on the email gateway.

#### Related Topics

- [Managed Exceptions, on page 261](#)

## Managed Exceptions

Because the iterative processing of each splinter message impacts performance, Cisco recommends configuring your content security rules on a *managed exception* basis. In other words, evaluate your organization’s needs and try to configure the feature so that the majority of messages will be handled by the default mail policy and the minority of messages will be handled by a few additional “exception” policies. In this manner, message splintering will be minimized and you are less likely to impact system performance from the processing of each splinter message in the work queue.

## Configuring Mail Policies

Mail policies map different user groups to specific security settings, such as Anti-Spam or Anti-Virus.

#### Related Topics

- [Configuring the Default Mail Policy for Incoming or Outgoing Messages , on page 261](#)
- [Creating a Mail Policy for a Group of Senders and Recipients, on page 262](#)
- [Finding Which Policies Apply to a Sender or Recipient, on page 265](#)

## Configuring the Default Mail Policy for Incoming or Outgoing Messages

The default mail policies apply to messages that are not covered by any other mail policy. If no other policies are configured, the default policies apply to all messages.

#### Before You Begin

Understand how you can define the individual security services for the mail policy. See [How to Enforce Mail Policies on a Per-User Basis, on page 256](#).

#### Procedure

---

- Step 1** Depending on your requirements, choose one of the following:
- **Mail Policies > Incoming Mail Policies**
  - **Mail Policies > Outgoing Mail Policies.**

- Step 2** Click the link for the security service you want to configure for the Default mail policy.
- Note** For default security service settings, the first setting on the page defines whether the service is enabled for the policy. You can click “Disable” to disable the service altogether.
- Step 3** Configure the settings for the security service.
- Step 4** Click **Submit**.
- Step 5** Submit and commit your changes.
- 

## Creating a Mail Policy for a Group of Senders and Recipients

### Before You Begin

- Understand how you can define the individual security services for the mail policy. See [How to Enforce Mail Policies on a Per-User Basis, on page 256](#).
- Remember that each recipient is evaluated for each policy in the appropriate table (incoming or outgoing) in a top-down fashion. See [First Match Wins, on page 258](#) for more information.
- (Optional) Define the delegated administrators who will be responsible for managing the mail policy. Delegated administrators can edit a policy’s Anti-Spam, Anti-Virus, Advanced Malware Protection, and Outbreak Filters settings and enable or disable content filters for the policy. Only operators and administrators can modify a mail policy’s name or its senders, recipients, or groups. Custom user roles that have full access to mail policies are automatically assigned to mail policies.

### Procedure

---

- Step 1** Choose **Mail Policies > Incoming Mail Policies** or **Mail Policies > Outgoing Mail Policies**.
- Step 2** Click **Add Policy**.
- Step 3** Enter a name for the mail policy.
- Step 4** (Optional) Click the Editable by (Roles) link and select the custom user roles for the delegated administrators who will be responsible for managing the mail policy.
- Step 5** Define users for the policy. For instructions to define users, see [Defining Senders and Recipients for Mail Policies, on page 263](#).
- Step 6** Click **Submit**.
- Step 7** Click the link for the content security service you want to configure for the mail policy.
- Step 8** From the drop-down list, select the option to customize the settings for the policy instead of using the default settings.
- Step 9** Customize the security service settings.
- Step 10** Submit and commit your changes.
- 

### What to do next

#### Related Topics

- [Defining Senders and Recipients for Mail Policies, on page 263](#)
- [How to Configure the Email Gateway to Scan Messages for Spam, on page 380](#)

## Defining Senders and Recipients for Mail Policies

You can define senders and recipients to whom the policy applies in the following ways:

- Full email address: `user@example.com`
- Partial email address: `user@`
- All users in a domain: `@example.com`
- All users in a partial domain: `@.example.com`
- By matching an LDAP Query



---

**Note** Entries for users are case-insensitive in both the GUI and CLI in AsyncOS. For example, if you enter the recipient `Joe@` for a user, a message sent to `joe@example.com` will match.

---

While defining senders and recipients for mail policies, keep in mind that:

- You must specify at least one sender and recipient.
- You can set the policy to match if,
  - The message is from any sender, one or more of the specified senders, or none of the specified senders.
  - The message is sent to any recipient, one or more of the specified recipients, or all of the specified recipients and none of the specified recipients.

### Procedure

---

**Step 1** Under **Users** section, click **Add User**.

**Step 2** Define the senders for the policy. Choose one of the following options:

- **Any Sender.** The policy is matched if the message is from any sender.
- **Following Senders.** The policy is matched if the message is from one or more of the specified senders. Select this option and enter sender details in the text box or choose an LDAP group query.
- **Following Senders are Not.** The policy is matched if the message is not from none of the specified senders. Select this option and enter sender details in the text box or choose an LDAP group query.

To understand how sender conditions are set while choosing the above fields, see [Examples, on page 264](#).

**Step 3** Define the recipients for the policy. Choose one of the following options:

- **Any Recipient.** The policy is matched if the message is sent to any recipient.
- **Following Recipients.** The policy is matched if the message is sent to the specified recipients. Select this option, enter the recipient details in the text box or choose an LDAP group query.

You can choose whether policy is matched if the message is sent to one or more of the specified recipients or all of the specified recipients. Choose one of the following options from the drop-down list: **If one more conditions match** or **Only if all conditions match**.

- **Following Recipients are Not.** The policy is matched if the message is sent to none of the specified recipients. Select this option, enter the recipient details in the text box or choose an LDAP group query.

**Note** You can configure this option only if you have selected **Following Recipients** and chosen **Only if all conditions match** from the drop-down list.

To understand how recipient conditions are set while choosing the above fields, see [Examples, on page 264](#).

**Step 4** Click **Submit**.

**Step 5** Review the selected conditions on the **Users** section.

### What to do next

#### Related Topics

- [Creating a Mail Policy for a Group of Senders and Recipients, on page 262](#)
- [Examples, on page 264](#)

## Examples

The following table describes how conditions are set when you choose various options on the Add User page.

Sender			Recipient			Condition
Any Sender	Following Senders	Following Senders are Not	Any Recipient	Following Recipients	Following Recipients are Not	
Selected	-	-	-	Selected (Default) <b>Only if all conditions match</b> option is selected  Values: user1@, user2@	-	<b>Sender:</b> Any  <b>Recipient:</b> user1@[AND]user2@
-	Selected  Values: u1@a.com, u2@a.com	-	-	Selected (Default) <b>Only if all conditions match</b> option is selected  Values: u1@b.com, u2@b.com	Selected  Values: u3@b.com, u4@b.com	<b>Sender:</b> u1@a.com[OR]u2@a.com  <b>Recipient:</b> [u1@b.com[AND]u2@b.com] [AND] [[NOT] [u3@b.com[AND]u4@b.com]]



-	-	Selected Values: u1@a.com, u2@a.com	-	Selected <b>If one or more conditions match option is also selected</b> Values: u1@b.com, u2@b.com	-	<b>Sender:</b> [NOT] [u1@a.com[OR]u2@a.com] <b>Recipient:</b> u1@b.com [OR] u2@b.com
---	---	--	---	--	---	--

### Related Topics

- [Defining Senders and Recipients for Mail Policies, on page 263](#)

## Finding Which Policies Apply to a Sender or Recipient

Use the Find Policies section at the top of the Mail Policies page to search for users already defined in incoming or outgoing mail policies.

For example, type bob@example.com and click the Find Policies button to display results showing which policies contain defined users that will match the policy.

Click the name of the policy to edit the users for that policy.

Note that the default policy will always be shown when you search for any user, because, by definition, if a sender or recipient does not match any other configured policies, it will *always* match the default policy.

### Related Topics

- [Managed Exceptions, on page 261](#)

## Managed Exceptions

Using the steps shown in the two examples above, you can begin to create and configure policies on a *managed exception* basis. In other words, after evaluating your organization's needs you can configure policies so that the majority of messages will be handled by the default policy. You can then create additional "exception" policies for specific users or user groups, managing the differing policies as needed. In this manner, message splintering will be minimized and you are less likely to impact system performance from the processing of each splinter message in the work queue.

You can define policies based on your organizations' or users' tolerance for spam, viruses, and policy enforcement. The following table outlines several example policies. "Aggressive" policies are designed to minimize the amount of spam and viruses that reach end-users mailboxes. "Conservative" policies are tailored to avoid false positives and prevent users from missing messages, regardless of policies.

Table 31: Aggressive and Conservative Email Security Manager Settings

	Aggressive Settings	Conservative Settings
<b>Anti-Spam</b>	Positively identified spam: Drop Suspected spam: Quarantine Marketing mail: Deliver and prepend “[Marketing]” to the subject messages	Positively identified spam: Quarantine Suspected spam: Deliver and prepend “[Suspected Spam]” to the subject of messages Marketing mail: Disabled
<b>Anti-Virus</b>	Repaired messages: Deliver Encrypted messages: Drop Unscannable messages: Drop Infectious messages: Drop	Repaired messages: Deliver Encrypted messages: Quarantine Unscannable messages: Quarantine Infectious messages: Drop
<b>Advanced Malware Protection (File Reputation Filtering and File Analysis)</b>	Unscanned attachments: Drop Messages with Malware Attachments: Drop Messages with pending File Analysis: Quarantine	Unscanned attachments: Deliver and prepend “[WARNING: ATTACHMENT UNSCANNED]” to the subject of messages. Messages with Malware Attachments: Drop Messages with pending File Analysis: Deliver and prepend “[WARNING: ATTACHMENT(S) MAY CONTAIN MALWARE]” to the subject of messages.
<b>Virus Filters</b>	Enabled, no specific filename extensions or domains allowed to bypass Enable message modification for all messages	Enabled with specific filename extensions or domains allowed to bypass Enable message modification for unsigned messages

## Setting Priority for Message Headers

You can set the priority for a message header to match the incoming and outgoing messages in your email gateway.



### Important

You can set the priority in which the email gateway checks for message headers in the incoming and outgoing messages. The email gateway first checks for the message header with the highest priority for all the mail policies. If there is no header match in any of the mail policies, the email gateway looks for the next message header in the priority list for all the mail policies. If none of the message headers match in any of the mail policies, the default mail policy settings are used.

### Procedure

**Step 1** Go to **Mail Policies > Mail Policy Settings**.

By default, the Envelope Sender header is set to a priority 1. You can click on the Envelope Sender link to change the priority.

- Step 2** Click **Add Priority** and check the appropriate header name (for example, Header “From”) check box to add a new priority.
- Step 3** Click **Submit** and commit your changes.
-





# CHAPTER 11

## Content Filters

This chapter contains the following sections:

- [Overview of Content Filters](#) , on page 269
- [How Content Filters Work](#), on page 269
- [Content Filter Conditions](#), on page 270
- [Content Filter Actions](#), on page 278
- [How to Filter Messages Based on Content](#), on page 287

## Overview of Content Filters

Use content filters to customize handling of messages beyond the standard routine handling by the other content security features such as anti-virus scanning or DLP. For example, you can use a content filter if the content warrants quarantining for later examination, or because corporate policy requires certain messages to be encrypted before delivery.

## How Content Filters Work

Content filters are similar to message filters, except that they are applied later in the email pipeline — after message filtering, after a message has been “splintered” into a number of separate messages for each matching mail policy, (see [Message Splintering](#), on page 260 for more information), and after the message has undergone anti-spam and anti-virus scanning.

A content filter scans either incoming or outgoing messages. You cannot define a filter that scans both types of messages. The email gateway has a separate “primary list” of content filters for each type of message. The primary list also determines in which order the appliance runs the content filters. However, each individual mail policy determines which particular filters will be executed when a message matches the policy.

Content filters scan messages on a per-user (sender or recipient) basis.

Content filters have the following components:

- *conditions* that determine when the email gateway uses a content filter to scan a message (optional)
- *actions* that the email gateway takes on a message (required)
- *action variables* that the email gateway can add to a message when modifying it (optional)

**Related Topics**

- [How to Scan Message Content Using a Content Filter, on page 270](#)
- [Content Filter Conditions, on page 270](#)
- [Content Filter Actions, on page 278](#)
- [Action Variables, on page 285](#)

## How to Scan Message Content Using a Content Filter

**Procedure**

	Command or Action	Purpose
<b>Step 1</b>	(Optional) Define the supporting features for the content filter.	Create any of the following items that you want to use with your content filter: <ul style="list-style-type: none"> <li>• Encryption Profile</li> <li>• Disclaimer template</li> <li>• Notification template</li> <li>• Policy quarantine</li> <li>• URL allowed lists</li> </ul>
<b>Step 2</b>	Define the incoming or outgoing content filter.	A content filter may be comprised of: <ul style="list-style-type: none"> <li>• <a href="#">Content Filter Conditions, on page 270</a> (optional)</li> <li>• <a href="#">Content Filter Actions, on page 278</a></li> <li>• <a href="#">Action Variables, on page 285</a> (optional)</li> </ul> <a href="#">Creating a Content Filter, on page 287</a>
<b>Step 3</b>	Define the group of users for whom you want to set up content security rules.	Create an incoming or outgoing mail policy.
<b>Step 4</b>	Assign the content filter to the group of user whose incoming or outgoing messages you want to use the filter for.	See <a href="#">Mail Policies, on page 255</a>

## Content Filter Conditions

A condition is a “trigger” that determines whether the email gateway uses the filter on a message that matches the associated mail policy. Specifying conditions for a content filter is optional. Content filters without a condition are applied to all messages that match the associated mail policy.

In the content filter conditions, when you add filter rules that search for certain patterns in the message body or attachments, you can specify the minimum threshold for the number of times the pattern must be found. When AsyncOS scans the message, it totals the “score” for the number of matches it finds in the message and attachments. If the minimum threshold is not met, the regular expression does not evaluate to true. You can specify this threshold for text, smart identifiers, or content dictionary terms.

Multiple conditions may be defined for each filter. When multiple conditions are defined, you can choose whether the conditions are tied together as a logical OR (“Any of the following conditions...”) or a logical AND (“All of the following conditions”).

**Table 32: Content Filter Conditions**

Condition	Description
(no conditions)	Specifying conditions in content filters is optional. If no conditions are specified, a true rule is implied. The true rule matches all messages, and the actions are always performed.
Message Body or Attachments	<p><b>Contains text:</b> Does the message body contain text or an attachment that matches a specific pattern?</p> <p><b>Contains smart identifier:</b> Does content in the message body or attachment match a smart identifier?</p> <ul style="list-style-type: none"> <li>• Credit card numbers</li> <li>• U.S. Social Security numbers</li> <li>• CUSIP (Committee on Uniform Security Identification Procedures) numbers</li> <li>• ABA (American Banking Association) routing numbers</li> </ul> <p><b>Contains smart identifier prefix:</b> Does content in the message body or attachment match a smart identifier with a prefix ('credit,' 'ssn,' 'cusip,' or 'aba')?</p> <p><b>Contains term in content dictionary:</b> Does the message body contain any of the regular expressions or terms in the content dictionary named <i>&lt;dictionary name&gt;</i>?</p> <p>For this option to be enabled, the dictionary must already have been created. See <a href="#">Content Dictionaries, on page 639</a>.</p> <p><b>Note</b> The dictionary-related conditions are only available if you have one or more dictionaries enabled. For information about creating content dictionaries, see <a href="#">Content Dictionaries, on page 639</a>.</p> <p><b>Number of matches required.</b> Specify the number of matches required for the rule to evaluate to true. You can specify this threshold for text, smart identifiers, or content dictionary terms.</p> <p>This includes delivery-status parts and associated attachments.</p>

Condition	Description
Message Body	<p><b>Contains text:</b> Does the message body contain text that matches a specific pattern?</p> <p><b>Contains smart identifier:</b> Does content in the message body match a smart identifier? Smart identifiers can detect the following patterns:</p> <ul style="list-style-type: none"> <li>• Credit card numbers</li> <li>• U.S. Social Security numbers</li> <li>• CUSIP (Committee on Uniform Security Identification Procedures) numbers</li> <li>• ABA (American Banking Association) routing numbers</li> </ul> <p><b>Contains smart identifier prefix:</b> Does content in the message body match a smart identifier with a prefix ('credit,' 'ssn,' 'cusip,' or 'aba')?</p> <p><b>Contains term in content dictionary:</b> Does the message body contain any of the regular expressions or terms in the content dictionary named <i>&lt;dictionary name&gt;</i>?</p> <p>For this option to be enabled, the dictionary must already have been created. See <a href="#">Content Dictionaries, on page 639</a>.</p> <p><b>Note</b> The dictionary-related conditions are only available if you have one or more dictionaries enabled. For information about creating content dictionaries, see <a href="#">Content Dictionaries, on page 639</a>.</p> <p><b>Number of matches required.</b> Specify the number of matches required for the rule to evaluate to true. You can specify this threshold for text or smart identifiers.</p> <p>This rule applies to the body of the message only. It does not include attachments or headers.</p>
URL Category	See <a href="#">Filtering by URL Reputation or URL Category: Conditions and Rules</a> , on page 451 and <a href="#">About URL Categories, on page 462</a> .
Message Size	Is the body size within a specified range? Body size refers to the size of the message, including both headers and attachments. The body-size rule selects those messages where the body size compares as directed to a specified number.
Macro Detection	Does the incoming or outgoing message contain macro-enabled attachments?  You can use the Macro Detection condition to detect macro-enabled attachments in messages for the selected file type(s).



Condition	Description
Attachment Content	<p><b>Contains text.</b> Does the message contain an attachment that contains text or another attachment that matches a specific pattern? This rule is similar to the <code>body-contains()</code> rule, but it attempts to avoid scanning the entire “body” of the message. That is, it attempts to scan only that which the user would view as being an attachment.</p> <p><b>Contains a smart identifier.</b> Does content in the message attachment match the specified smart identifier?</p> <p><b>Contains smart identifier prefix:</b> Does content in the message attachment match a smart identifier with a prefix ('credit,' 'ssn,' 'cusip,' or 'aba')?</p> <p><b>Contains terms in content dictionary.</b> Does the attachment contain any of the regular expressions or terms in the content dictionary named <i>&lt;dictionary name&gt;</i>?</p> <p>To search for dictionary terms, the dictionary must already have been created. See <a href="#">Content Dictionaries, on page 639</a>.</p> <p><b>Note</b> The dictionary-related conditions are only available if you have one or more dictionaries enabled. For information about creating content dictionaries, see <a href="#">Content Dictionaries, on page 639</a>.</p> <p><b>Number of matches required.</b> Specify the number of matches required for the rule to evaluate to true. You can specify this threshold for text, smart identifier, or content dictionary matches.</p>

Condition	Description
Attachment File Info	<p><b>Filename.</b> Does the message have an attachment with a filename that matches a specific pattern?</p> <p><b>Filename contains term in content dictionary.</b> Does the message have an attachment with a filename that contains any of the regular expressions or terms in the content dictionary named <i>&lt;dictionary name&gt;</i> ?</p> <p>For this option to be enabled, the dictionary must already have been created. See <a href="#">Content Dictionaries, on page 639</a>.</p> <p><b>Note</b> The dictionary-related conditions are only available if you have one or more dictionaries enabled. For information about creating content dictionaries, see <a href="#">Content Dictionaries, on page 639</a>.</p> <p><b>File type.</b> Does the message have an attachment of a file type that matches a specific pattern based on its fingerprint (similar to a UNIX file command)?</p> <p><b>MIME type.</b> Does the message have an attachment of a specific MIME type? This rule is similar to the attachment-type rule, except only the MIME type given by the MIME attachment is evaluated. (The email gateway does not try to “guess” the type of the file by its extension if there is no explicit type given.)</p> <p><b>File Hash List.</b> Does the message have an attachment that matches a specific file SHA-256 value? Select the required file hash list from the drop-down list.</p> <p><b>Note</b> You can only select a file hash list that contains the SHA-256 file hash type.</p> <p><b>Image Analysis.</b> Does the message have an image attachment that matches the image verdict specified? Valid image analysis verdicts include: <i>Suspect, Inappropriate, Suspect or Inappropriate, Unscannable</i> , or <i>Clean</i>.</p> <p><b>External Threat Feeds:</b> Does the file match the threat information from the selected external threat feed source(s)?</p> <p><b>Select a File Hash Exception List:</b> (Optional) Select the list of allow listed file hashes that you do not want the email gateway to detect for threats.</p> <p>For more information, see <a href="#">Configuring Email Gateway to Consume External Threat Feeds, on page 293</a>.</p> <p><b>Attachment is Corrupt.</b> Does this message have an attachment that is corrupt?</p> <p><b>Note</b> A corrupt attachment is an attachment that the scanning engine cannot scan and identified as corrupt.</p>
Attachment Protection	<p><b>Contains an attachment that is password-protected or encrypted.</b></p> <p>(For example, use this condition to identify attachments that are potentially unscannable.)</p> <p><b>Contains an attachment that is NOT password-protected or encrypted.</b></p>

Condition	Description
Subject Header	<p><b>Subject Header:</b> Does the subject header match a certain pattern?</p> <p><b>Contains terms in content dictionary:</b> Does the subject header contain any of the regular expressions or terms in the content dictionary <i>&lt;dictionary name&gt;</i> ?</p> <p>To search for dictionary terms, the dictionary must already have been created. See <a href="#">Content Dictionaries, on page 639</a>.</p> <p><b>Note</b> The dictionary-related conditions are only available if you have one or more dictionaries enabled. For information about creating content dictionaries, see <a href="#">Content Dictionaries, on page 639</a>.</p>
Other Header	<p><b>Header name:</b> Does the message contain a specific header?</p> <p><b>Header value:</b> Does the value of that header match a certain pattern?</p> <p><b>Header value contains terms in the content dictionary.</b> Does the specified header contain any of the regular expressions or terms in the content dictionary named <i>&lt;dictionary name&gt;</i> ?</p> <p>To search for dictionary terms, the dictionary must already have been created. See <a href="#">Content Dictionaries, on page 639</a></p> <p><b>Note</b> The dictionary-related conditions are only available if you have one or more dictionaries enabled. For information about creating content dictionaries, see <a href="#">Content Dictionaries, on page 639</a>.</p> <p>For an example showing how this option can be used, see <a href="#">Using Custom Headers to Redirect URLs in Suspected Spam to the Cisco Web Security Proxy: Configuration Example</a> , on page 399.</p>
Envelope Sender	<p><b>Envelope Sender.</b> Does the Envelope Sender (i.e., the Envelope From, &lt;MAIL FROM&gt;) match a given pattern?</p> <p><b>Matches LDAP group.</b> Is the Envelope Sender, i.e., the Envelope From, &lt;MAIL FROM&gt;) in a given LDAP group?</p> <p><b>Contains term in content dictionary.</b> Does the envelope sender contain any of the regular expressions or terms in the content dictionary named <i>&lt;dictionary name&gt;</i> ?</p> <p>To search for dictionary terms, the dictionary must already have been created. See <a href="#">Content Dictionaries, on page 639</a>.</p> <p><b>Note</b> The dictionary-related conditions are only available if you have one or more dictionaries enabled. For information about creating content dictionaries, see <a href="#">Content Dictionaries, on page 639</a>.</p>

Condition	Description
Envelope Recipient	<p><b>Envelope Recipient.</b> Does the Envelope Recipient, (i.e. the Envelope To, &lt;RCPT TO&gt;) match a given pattern?</p> <p><b>Matches LDAP group.</b> Is the Envelope Recipient, (i.e. the Envelope To, &lt;RCPT TO&gt;) in a given LDAP group?</p> <p><b>Contains term in content dictionary.</b> Does the envelope recipient contain any of the regular expressions or terms in the content dictionary named <i>&lt;dictionary name&gt;</i> ?</p> <p>To search for dictionary terms, the dictionary must already have been created. See <a href="#">Content Dictionaries, on page 639</a>.</p> <p><b>Note</b>      The dictionary-related conditions are only available if you have one or more dictionaries enabled. For information about creating content dictionaries, see <a href="#">Content Dictionaries, on page 639</a>.</p> <p>                 The Envelope Recipient rule is message-based. If a message has multiple recipients, only one recipient has to be found in a group for the specified action to affect the message to all recipients.</p> <p>Is the Envelope Sender (i.e., the Envelope From, &lt;MAIL FROM&gt;) in a given LDAP group?</p>
Receiving Listener	Did the message arrive via the named listener? The listener name must be the name of a listener currently configured on the system.
Remote IP	Was the message sent from a remote host that matches a given IP address or IP block? The Remote IP rule tests to see if the IP address of the host that sent that message matches a certain pattern. This can be an Internet Protocol version 4 (IPv4) or version 6 (IPv6) address. The IP address pattern is specified using the allowed hosts notation described in <a href="#">Sender Group Syntax, on page 91</a> , except for the SBO, IPR, dnslist notations and the special keyword ALL.
Reputation Score	What is the sender's IP Reputation Score? The Reputation Score rule checks the IP Reputation Score against another value.
DKIM Authentication	Did DKIM authentication pass, partially verify, return temporarily unverifiable, permanently fail, or were no DKIM results returned?

Condition	Description
Forged Email Detection	<p>Is the sender address of the message forged? The rule checks if the From: header in the message is similar to any of the users in the content dictionary.</p> <p>Select a content dictionary and enter the threshold value (1 through 100) for considering a message as potentially forged.</p> <p>The Forged Email Detection condition compares the From: header with the users in the content dictionary. During this process, depending on the similarity, the email gateway assigns similarity score to each of the users in the dictionary. The following are some examples:</p> <ul style="list-style-type: none"> <li>• If the From: header is &lt;john.simons@example.com&gt; and the content dictionary contains a user 'John Simons,' the email gateway assigns a similarity score of 82 to the user.</li> <li>• If the From: header is &lt;john.simons@diff-example.com&gt; and the content dictionary contains a user 'John Simons,' the email gateway assigns a similarity score of 100 to the user.</li> </ul> <p>The higher the similarity score, the higher the probability that the message is forged. If the similarity score is greater than or equal to the specified threshold value, the filter action is triggered.</p> <p>If you want to skip the Forged email detection filter for messages from specific senders, choose the address list from the <b>Exception List</b> drop-down list.</p> <p><b>Note</b> You can choose only the address lists that are created using the full email addresses. For more information, refer to <a href="#">Using a List of Sender Addresses for Incoming Connection Rules, on page 110</a>.</p> <p>For more information, see <a href="#">Forged Email Detection, on page 636</a>.</p>
SPF Verification	<p>What was the SPF verification status? This filter rule allows you to query for different SPF verification results. For more information about SPF verification, see the “Email Authentication” chapter.</p> <p><b>Note</b> If you have configured an SPF verification content filter condition without an SPF identity and if a message contains different SPF identities with different verdicts, the condition is triggered if one of the verdicts in the message matches the condition.</p>
S/MIME Gateway Message	<p>Is the message S/MIME signed, encrypted, or signed and encrypted? For more information, see <a href="#">S/MIME Security Services, on page 549</a></p>
S/MIME Gateway Verified	<p>Is the S/MIME message successfully verified, decrypted, or decrypted and verified? For more information, see <a href="#">S/MIME Security Services, on page 549</a></p>

Condition	Description
Message Language	<p>Is the message (subject and body) in one of the selected languages? This condition will not check for the language in attachments and headers.</p> <p><b>How does language detection work?</b></p> <p>The email gateway uses the built-in language detection engine to detect the language in a message. The email gateway extracts the subject and the message body and passes it to the language detection engine.</p> <p>The language detection engine determines the probability of each language in the extracted text and passes it back to the email gateway. The email gateway considers the language with the highest probability as the language of the message. The email gateway considers the language of the message as ‘undetermined’ in one of the following scenarios:</p> <ul style="list-style-type: none"> <li>• If the detected language is not supported by email gateway</li> <li>• If the email gateway is unable to detect the language of the message</li> <li>• If the total size of the extracted text sent to the language detection engine is less than 50 bytes.</li> </ul>
Duplicate Boundaries Verification	<p>Does the message contain duplicate MIME boundaries?</p> <p>If you want to take actions on messages that contain duplicate MIME boundaries, use this condition.</p> <p><b>Note</b> Attachment-based conditions (for example, Attachment Content) or actions (for example, Strip Attachment by Content) will not work on malformed messages (with duplicate MIME boundaries).</p>
Geolocation	<p>Does the message originate from the selected countries?</p> <p>You can use the Geolocation condition to handle incoming messages from particular countries that you select.</p> <p><b>Note</b> Enable the Anti-Spam engine on your email gateway before you use the Geolocation content filter.</p>
Domain Reputation	<p>Does the sender domain match the specified criteria?</p> <ul style="list-style-type: none"> <li>• Sender Domain Reputation</li> <li>• External Threat Feeds</li> </ul> <p>For more information, see <a href="#">Configuring Email Gateway to Consume External Threat Feeds, on page 293</a> or <a href="#">Sender Domain Reputation Filtering, on page 315</a></p>

## Content Filter Actions

The action is what the email gateway does with a message that matches the content filter’s condition. Many different types of actions are available, including modifying the message, quarantining it, or dropping it. A “final action” performed on a message, delivering or dropping it, forces the Email Security appliance to perform the action immediately and forgo all further processing, such as Outbreak Filter or DLP scanning.

At least one action must be defined for each content filter.

Actions are performed in order on messages, so consider the order of actions when defining multiple actions for a content filter.

When you configure a quarantine action for messages that match Attachment Content conditions, Message Body or Attachment conditions, Message body conditions, or the Attachment content conditions, you can view the matched content in the quarantined message. When you display the message body, the matched content is highlighted in yellow. You can also use the `$MatchedContent` action variable to include the matched content in the message subject. For more information, see the Text Resources chapter.

Only one final action may be defined per filter, and the final action must be last action listed. Bounce, deliver, and drop are final actions. When entering actions for content filters, the GUI and CLI will force final actions to be placed last.

See also [Action Variables, on page 285](#).

**Table 33: Content Filter Actions**

Action	Description
Quarantine	<p><b>Quarantine.</b> Flags the message to be held in one of the policy quarantine areas.</p> <p><b>Duplicate message:</b> Sends a copy of the message to the specified quarantine and continues processing the original message. Any additional actions apply to the original message.</p>
Encrypt on Delivery	<p>The message continues to the next stage of processing. When all processing is complete, the message is encrypted and delivered.</p> <p><b>Encryption rule:</b> Always encrypts the message or only encrypts it if an attempt to send it over a TLS connection first fails. See <a href="#">Using a TLS Connection as an Alternative to Encryption, on page 542</a> for more information.</p> <p><b>Encryption Profile.</b> Once processing is complete, encrypts the message using the specified encryption profile, then delivers the message. This action is for use with a Cisco Encryption Appliance or a hosted key service.</p> <p><b>Subject.</b> Subject for the encrypted message. By default, the value is <code>\$Subject</code>.</p>

Action	Description
Strip Attachment by Content	<p><b>Attachment contains.</b> Drops all attachments on messages that contain the regular expression. Archive files (zip, tar) will be dropped if any of the files they contain match the regular expression pattern.</p> <p><b>Contains smart identifier.</b> Drops all attachments on a message that contains the specified smart identifier.</p> <p><b>Attachment contains terms in the content dictionary.</b> Does the attachment contain any of the regular expressions or terms in the content dictionary named <i>&lt;dictionary name&gt; ?</i></p> <p><b>Number of matches required.</b> Specify the number of matches required for the rule to evaluate to true. You can specify this threshold for text, smart identifier, or content dictionary matches.</p> <p><b>Replacement message.</b> The optional comment serves as the means to modify the text used to replace the attachment that was dropped. Attachment footers simply append to the message.</p>



Action	Description
Strip Attachment by File Info	<p><b>File name.</b> Drops all attachments on messages that have a filename that match the given regular expression. Archive file attachments (zip, tar) will be dropped if they contain a file that matches.</p> <p><b>File size.</b> Drops all attachments on the message that, in raw encoded form, are equal to or greater than the size (in bytes) given. Note that for archive or compressed files, this action does not examine the uncompressed size, but rather the size of the actual attachment itself.</p> <p><b>File type.</b> Drops all attachments on messages that match the given “fingerprint” of the file. Archive file attachments (zip, tar) will be dropped if they contain a file that matches.</p> <p><b>MIME type.</b> Drops all attachments on messages that have a given MIME type.</p> <p><b>File Hash List.</b> Drops all attachments on messages that match the file SHA-256 value in the selected file hash list. Select the required file hash list from the drop-down list.</p> <p><b>Note</b> You can only select a file hash list that contains the SHA-256 file hash type.</p> <p><b>Image Analysis Verdict.</b> Drops attachments for image attachments that match the image verdict specified. Valid image analysis verdicts include: <i>Suspect</i>, <i>Inappropriate</i>, <i>Suspect or Inappropriate</i>, <i>Unscannable</i> , or <i>Clean</i> .</p> <p><b>External Threat Feeds.</b> Drops all message attachments on messages whose files are categorized as malicious by the ETF engine.</p> <p><b>Select a File Hash Exception List.</b> (Optional) Select the list of allow listed file hashes that you do not want the Cisco Email Security Gateway to detect for threats.</p> <p>For more information, see <a href="#">Configuring Email Gateway to Consume External Threat Feeds, on page 293</a>.</p> <p><b>Replacement message.</b> The optional comment serves as the means to modify the text used to replace the attachment that was dropped. Attachment footers simply append to the message.</p>

Action	Description
Strip Attachment with Macro	<p>Drops all macro-enabled attachments of the specified file type.</p> <p><b>Note</b> If an archive or embedded file contains macros, the parent file is dropped from the message.</p> <p><b>Custom Replacement Message (Optional):</b> By default, a system generated message is added to the bottom of the message body when an attachment is dropped.</p> <p>The following is a sample system generated message when a macro-enabled attachment is dropped from the message:</p> <p><b>A MIME attachment of type &lt;application/vnd.ms-excel&gt; was removed here by a drop-macro-enabled-attachments filter rule on the host &lt;mail.example.com&gt;.</b></p> <p>The custom message that you enter in the <b>Custom Replacement Message</b> field replaces the system-generated message.</p>
URL Reputation	<p>See <a href="#">Modifying URLs in Messages: Using URL Reputation and URL Category Actions in Filters</a>, on page 452 and <a href="#">Creating Allowed Lists for URL Filtering</a>, on page 448.</p> <p>Use “No Score” to specify an action for URLs for which a reputation cannot be determined.</p> <p><b>Note</b> The email gateway considers a message signed if it is encrypted using S/MIME or it contains an S/MIME signature.</p>
URL Category	<p>See <a href="#">Modifying URLs in Messages: Using URL Reputation and URL Category Actions in Filters</a>, on page 452 and <a href="#">About URL Categories</a>, on page 462.</p> <p><b>Note</b> The email gateway considers a message signed if it is encrypted using S/MIME or it contains an S/MIME signature.</p>
Add Disclaimer Text	<p><b>Above.</b> Add disclaimer above message (heading).</p> <p><b>Below.</b> Add disclaimer below message (footer).</p> <p><b>Note:</b> You must have already created disclaimer text in order to use this content filter action.</p> <p>See <a href="#">Disclaimer Template</a>, on page 651 for more information.</p>
Bypass Outbreak Filter Scanning	Bypass Outbreak Filter scanning for this message.
Bypass DKIM Signing	Bypass DKIM signing for this message.
Send Copy (Bcc:)	<p><b>Email addresses.</b> Copies the message anonymously to the specified recipients.</p> <p><b>Subject.</b> Add a subject for the copied message.</p> <p><b>Return path (optional).</b> Specify a return path.</p> <p><b>Alternate mail host (optional).</b> Specify an alternate mail host.</p>

Action	Description
Notify	<p><b>Notify.</b> Reports this message to the specified recipients. You can optionally notify the sender and recipients.</p> <p><b>Subject.</b> Add a subject for the copied message.</p> <p><b>Return path (optional).</b> Specify a return path.</p> <p><b>Use template.</b> Select a template from the templates you created.</p> <p><b>Include original message as an attachment.</b> Adds the original message as an attachment.</p>
Change Recipient to	<p><b>Email address.</b> Changes the recipient of the message to the specified email address.</p>
Send to Alternate Destination Host	<p><b>Mail host.</b> Changes the destination mail host for the message to the specified mail host.</p> <p><b>Note</b> This action prevents a message classified as spam by an anti-spam scanning engine from being quarantined. This action overrides the quarantine and sends it to the specified mail host.</p>
Deliver from IP Interface	<p><b>Send from IP interface.</b> Send from the specified IP Interface. The Deliver from IP Interface action changes the source host for the message to the source specified. The source host consists of the IP interface that the messages should be delivered from.</p>
Strip Header	<p><b>Header name.</b> Remove the specified header from the message before delivering.</p>
Add/Edit Header	<p><b>Inserts a new header into the message or modifies an existing header.</b></p> <p><b>Header name.</b> Name of new or existing header.</p> <p><b>Specify value of new header.</b> Inserts a value for the new header into the message before delivering.</p> <p><b>Prepend to the Value of Existing Header.</b> Prepends the value to the existing header before delivering.</p> <p><b>Append to the Value of Existing Header.</b> Appends the value to the existing header before delivering.</p> <p><b>Search &amp; Replace from the Value of Existing Header.</b> Enter a search term to find the value you want to replace in the existing header in the <b>Search for</b> field. Enter the value you want to insert into the header in the <b>Replace with</b> field. You can use a regular expression to search for the value. Leave the <b>Replace with</b> field empty if you want to delete the value from the header.</p>
Forged Email Detection	<p>Strips the From: header from the forged message and replaces it with the Envelope Sender.</p> <p>See <a href="#">Forged Email Detection, on page 636</a>.</p>

Action	Description
Add Message Tag	Inserts a custom term into the message to use with DLP policy filtering. You can configure a DLP policy to limit scanning to messages with the message tag. The message tag is not visible to recipients. For information on using messages tags in a DLP policy, see <a href="#">Policies for Data Loss Prevention, on page 508</a> .
Add Log Entry	Inserts customized text into the IronPort Text Mail logs at the INFO level. The text can include action variables. The log entry also appears in message tracking.
S/MIME Sign/Encrypt on Delivery	Performs an S/MIME signing or encryption of the message during the delivery. This means that the message continues to the next stage of processing, and when all processing is complete, the message is signed or encrypted and delivered.  <b>S/MIME Sending Profile:</b> Performs an S/MIME signing or encryption using the specified S/MIME sending profile. See <a href="#">Managing S/MIME Sending Profiles, on page 559</a> .
Encrypt and Deliver Now (Final Action)	Encrypts and delivers the message, skipping any further processing.  <b>Encryption rule:</b> Always encrypts the message or only encrypts it if an attempt to send it over a TLS connection first fails. See <a href="#">Using a TLS Connection as an Alternative to Encryption, on page 542</a> for more information.  <b>Encryption Profile.</b> Encrypts the message using the specified encryption profile, then delivers the message. This action is for use with a Cisco Encryption Appliance or a hosted key service.  <b>Subject.</b> Subject for the encrypted message. By default, the value is <b>\$Subject</b> .
S/MIME Sign/Encrypt (Final Action)	Performs an S/MIME signing or encryption and delivers the message, skipping any further processing.  <b>S/MIME Sending Profile:</b> Performs an S/MIME signing or encryption using the specified S/MIME sending profile. See <a href="#">Managing S/MIME Sending Profiles, on page 559</a> .
Bounce (Final Action)	Sends the message back to the sender.
Skip Remaining Content Filters (Final Action)	Delivers the message to the next stage of processing, skipping any further content filters. Depending on configuration, this may mean deliver the message to recipient(s), quarantine, or begin Outbreak Filters scanning.
Drop (Final Action)	Drops and discards the message.

Action	Description
Safe Print	<p>Use the 'Safe Print' content filter action to safe print a message attachment.</p> <p>You can use the Safe Print content filter action in any one of the following ways:</p> <ul style="list-style-type: none"> <li>• <b>Safe print matching attachments:</b> Use this option to safe print all message attachments that match a configured content filter condition.</li> <li>• <b>Safe print all attachments:</b> Use this option to safe print all message attachments when the configured content filter condition is true</li> </ul> <p>Select <b>Yes</b> to strip a message attachment that is marked as unscannable.</p> <p><b>Note</b> By default, a system generated message is added as an attachment text file when an attachment is unscannable. You can enter a custom message in the <b>Custom Replacement Message</b> field.</p> <p>For more information, see <a href="#">How to Configure Email Gateway to Safe Print Message Attachments</a>, on page 342.</p>

#### Related Topics

- [Action Variables](#), on page 285

## Action Variables

Headers added to messages processed by content filters can contain variables that will be automatically replaced with information from the original message when the action is executed. These special variables are called *action variables*. Your email gateway supports the following set of action variables:

**Table 34: Action Variables**

Variable	Syntax	Description
All Headers	<code>\$AllHeaders</code>	Replaced by the message headers.
Body Size	<code>\$BodySize</code>	Replaced by the size, in bytes, of the message.
Date	<code>\$Date</code>	Replaced by the current date, using the format MM/DD/YYYY.
Dropped File Name	<code>\$dropped_filename</code>	Returns only the most recently dropped filename.
Dropped File Names	<code>\$dropped_filenames</code>	Same as <code>\$filenames</code> , but displays list of dropped files.
Dropped File Types	<code>\$dropped_filetypes</code>	Same as <code>\$filetypes</code> , but displays list of dropped file types.

Variable	Syntax	Description
Envelope Sender	<code>\$envelopefrom</code> or <code>\$envelopesender</code>	Replaced by the Envelope Sender (Envelope From, <MAIL FROM>) of the message.
Envelope Recipients	<code>\$EnvelopeRecipients</code>	Replaced by all Envelope Recipients (Envelope To, <RCPT TO>) of the message.
File Names	<code>\$filenames</code>	Replaced with a comma-separated list of the message's attachments' filenames.
File Sizes	<code>\$filesizes</code>	Replaced with a comma-separated list of the message's attachment's file sizes.
File Types	<code>\$filetypes</code>	Replaced with a comma-separated list of the message's attachments' file types.
Filter Name	<code>\$FilterName</code>	Replaced by the name of the filter being processed.
GMTTimeStamp	<code>\$GMTTimeStamp</code>	Replaced by the current time and date, as would be found in the Received: line of an email message, using GMT.
HAT Group Name	<code>\$Group</code>	Replaced by the name of the sender group the sender matched on when injecting the message. If the sender group had no name, the string ">Unknown<" is inserted.
Mail Flow Policy	<code>\$Policy</code>	Replaced by the name of the HAT policy applied to the sender when injecting the message. If no predefined policy name was used, the string ">Unknown<" is inserted.
Matched Content	<code>\$MatchedContent</code>	Replaced by the value (or values) that triggered a content-scanning filter. Matched content can be a content dictionary match, a smart identifier, or a match to a regular expression.
Header	<code>\$Header['string']</code>	Replaced by the value of the quoted header, if the original message contains a matching header. Note that double quotes may also be used.
Hostname	<code>\$Hostname</code>	Replaced by the hostname of the email gateway.
Internal Message ID	<code>\$MID</code>	Replaced by the Message ID, or "MID" used internally to identify the message. Not to be confused with the RFC822 "Message-Id" value (use \$Header to retrieve that).
Receiving Listener	<code>\$RecvListener</code>	Replaced by the nickname of the listener that received the message.
Receiving Interface	<code>\$RecvInt</code>	Replaced by the nickname of the interface that received the message.

Variable	Syntax	Description
Remote IP Address	<code>RemoteIP</code>	Replaced by the IP address of the system that sent the message to the email gateway.
Remote Host Address	<code>remotehost</code>	Replaced by the hostname of the system that sent the message to the email gateway.
SenderBase Reputation Score	<code>Reputation</code>	Replaced by the SenderBase Reputation score of the sender. If there is no reputation score, it is replaced with “None”.
Subject	<code>Subject</code>	Replaced by the subject of the message.
Time	<code>Time</code>	Replaced by the current time, in the local time zone.
Timestamp	<code>Timestamp</code>	Replaced by the current time and date, as would be found in the Received: line of an email message, in the local time zone.

## How to Filter Messages Based on Content

### Related Topics

- [Creating a Content Filter, on page 287](#)
- [Enabling Content Filters for All Recipients by Default, on page 288](#)
- [Applying the Content Filter to Messages for a Certain User Group, on page 289](#)
- [Notes on Configuring Content Filters in the GUI, on page 289](#)

## Creating a Content Filter

### Before You Begin

- If you want to encrypt a message that matches the content filter, create an encryption profile.
- If you want to add a disclaimer to a matching message, create a disclaimer template to use for generating disclaimers.
- If you want to send a notification message to a user due to a matching message, create a notification template for generating notifications.
- If you want to quarantine a message, you create a new policy quarantine for these messages or use an existing one.

### Procedure

**Step 1** Click **Mail Policies > Incoming Mail Policies**

or

**Mail Policies > Outgoing Mail Policies.**

- Step 2** Click **Add Filter**.
- Step 3** Enter a name and description for the filter.
- Step 4** (X-REF) Click the **Editable By (Roles)** link, select the Policy Administrator and click **OK**.  
Delegated administrators who belong to the Policy Administrator user role will be able to edit this content filter and use it in their mail policies.
- Step 5** (Optional) Add a condition for triggering the filter.
- Click Add Condition.
  - Select the condition type.
  - Define the condition's rules.
  - Click **OK**.
  - Repeat these steps for any additional conditions you want to add to the filter. When you define more than one condition for a content filter, you can define whether *all* of the defined actions (that is, a logical AND) or *any* of the defined actions (logical OR) need to apply in order for the content filter to be considered a match.
- Note** If you do not add a condition, the email gateway will perform the content filter's action to any message that matches one of the mail policies associated with the filter.
- Step 6** Add an action for the email gateway to take on a message that matches the filter's condition.
- Click Add Action.
  - Select the action type.
  - Define the action.
  - Click **OK**.
  - Repeat the previous steps for any additional actions you want the email gateway to take.
  - For multiple actions, arrange the actions in the order that you want the email gateway to apply them to the message. There can only be one "final" action per filter, and AsyncOS automatically moves the final action to the end of the order.
- Step 7** Submit and commit your changes.

---

#### What to do next

- You can enable the content filter in a default incoming or outgoing mail policy.
- You can enable the content filter in a mail policy for a specific group of users.

## Enabling Content Filters for All Recipients by Default

---

#### Procedure

- Step 1** Click **Mail Policies > Incoming Mail Policies**  
or  
**Mail Policies > Outgoing Mail Policies**.
- Step 2** Click the link for the Content Filters security service in the default policy row.



**Step 3** On the Content Filtering security service page, change the value Content Filtering for Default Policy from “Disable Content Filters” to “Enable Content Filters (Customize settings).”

The content filters defined in the primary list (which were created in [Overview of Content Filters](#), on page 269) are displayed on this page. When you change the value to “Enable Content Filters (Customize settings),” the checkboxes for each filter become enabled.

**Step 4** Check the **Enable** checkbox for each content filter you want to enable.

**Step 5** Submit and commit your changes.

---

## Applying the Content Filter to Messages for a Certain User Group

### Before You Begin

- Create an incoming or outgoing mail policy for the group of users whose messages for which you want to use the content filter. See [Creating a Mail Policy for a Group of Senders and Recipients](#), on page 262 for more information.

### Procedure

---

**Step 1** Click **Mail Policies > Incoming Mail Policies**

or

**Mail Policies > Outgoing Mail Policies.**

**Step 2** Click the link for the Content Filters security service (the Content Filters column) for the mail policy to which you want to apply the content filter.

**Step 3** On the Content Filtering security service page, change the value for Content Filtering for Policy: Engineering from “Enable Content Filtering (Inherit default policy settings)” to “Enable Content Filtering (Customize settings).”

**Step 4** Select the checkboxes for the content filters you want to use.

**Step 5** Submit and commit your changes.

---

## Notes on Configuring Content Filters in the GUI

- It is not necessary to specify a condition when creating a content filter. When no action is defined, any actions defined will always apply in the rule. (Specifying no condition is equivalent to using the true() message filter rule — all messages will be matched if the content filter is applied to a policy.)
- If you do not assign a custom user role to a content filter, the content filter is public and can be used by any delegated administrator for their mail policies. See the “Common Administrative Tasks” chapter for more information on delegated administrators and content filters.
- Administrators and operators can view and edit all content filters on the email gateway, even when the content filters are assigned to custom user roles.
- When entering text for filter rules and actions, the following meta characters have special meaning in regular expression matching: . ^ \$ \* + ? { [ ] \ | ( )

If you do not wish to use regular expression you should use a '\' (backslash) to escape any of these characters. For example: "\\*Warning\\*"

- You can test message splintering and content filters by creating “benign” content filters. For example, it is possible to create a content filter whose only action is “deliver.” This content filter will not affect mail processing; however, you can use this filter to test how Email Security Manager policy processing affects other elements in the system (for example, the mail logs).
- Conversely, using the “primary list” concept of the Incoming or Outgoing Content Filters, it is possible to create very powerful, wide-sweeping content filters that will immediately affect message processing for all mail handled by the email gateway. The process for this is to:
  - Use the Incoming or Outgoing Content Filters page to create a new content filter whose order is 1.
  - Use the Incoming or Outgoing Mail Policies page to enable the new content filter for the default policy.
  - Enable the content filter for all remaining policies.
- The Bcc: and Quarantine actions available in Content Filters can help you determine the retention settings of quarantines you create. (See [Policy, Virus, and Outbreak Quarantines, on page 923](#)) You can create filters that would simulate mail flow into and out of your policy quarantines so that messages are not released too quickly from the system (that is, the quarantine areas do not fill their allotted disk space too quickly).
- Because it uses the same settings as the Scan Behavior page or the **scanconfig** command, the “Entire Message” condition does not scan a message’s headers; choosing the “Entire Message” will scan only the message body and attachments. Use the “Subject” or “Header” conditions to search for specific header information.
- Configuring users by LDAP query will only appear in the GUI if you have LDAP servers configured on the email gateway (that is, you have configured the appliance to query specific LDAP servers with specific strings using the **ldapconfig** command).
- Some sections of the content filter rule builder will not appear in the GUI if the resource has not been preconfigured. For example, notification templates and message disclaimers will not appear as options if they have not been configured previously using the Text Resources page or the **textconfig** command in the CLI.
- Content filters features will recognize, can contain, and/or scan for text in the following character encodings:
  - Unicode (UTF-8)
  - Unicode (UTF-16)
  - Western European/Latin-1 (ISO 8859-1)
  - Western European/Latin-1 (Windows CP1252)
  - Traditional Chinese (Big 5)
  - Simplified Chinese (GB 2312)
  - Simplified Chinese (HZ GB 2312)
  - Korean (ISO 2022-KR)
  - Korean (KS-C-5601/EUC-KR)
  - Japanese (Shift-JIS (X0123))
  - Japanese (ISO-2022-JP)
  - Japanese (EUC)

You can mix and match multiple character sets within a single content filter. Refer to your web browser's documentation for help displaying and entering text in multiple character encodings. Most browsers can render multiple character sets simultaneously.

- On the Incoming or Outgoing Content Filters summary pages, use the links for “Description,” “Rules,” and “Policies” to change the view presented for the content filters:
  - The **Description** view shows the text you entered in the description field for each content filter. (This is the default view.)
  - The **Rules** view shows the rules and regular expressions build by the rule builder page.
  - The **Policies** shows the policies for which each content filter is enabled.





## CHAPTER 12

# Configuring Email Gateway to Consume External Threat Feeds

---

This chapter contains the following sections:

- [Overview of External Threat Feeds, on page 293](#)
- [How to Configure Email Gateway to Consume External Threat Feeds , on page 294](#)
- [Obtaining External Threat Feeds Feature Key , on page 296](#)
- [Enabling External Threat Feeds Engine on Email Gateway, on page 297](#)
- [Configuring an External Threat Feed Source, on page 298](#)
- [Configuring SecureX Threat Response Feeds Source, on page 300](#)
- [Handling Messages Containing Threats, on page 304](#)
- [Configuring a Sender Group for Handling Messages containing Threats , on page 305](#)
- [Configuring Content or Message Filters for Handling Messages Containing Threats, on page 305](#)
- [Attaching Content Filter to Incoming Mail Policy, on page 312](#)
- [External Threat Feeds and Clusters, on page 312](#)
- [Monitoring External Threat Feeds Engine Updates, on page 312](#)
- [Viewing Alerts, on page 313](#)
- [Displaying Threat Details in Message Tracking, on page 313](#)

## Overview of External Threat Feeds

The External Threat Feeds (ETF) framework allows the email gateway to consume external threat information in:

- STIX format communicated over TAXII protocol.
- JavaScript Object Notation (JSON) format from the Cisco SecureX Threat Response portal.

The ability to consume external threat information in the email gateway, helps an organization to:

- Proactively respond to cyber threats such as, malware, ransomware, phishing attacks, and targeted attacks.
- Subscribe to local and third-party threat intelligence sources.
- Improve the efficacy of the email gateway.

You need a valid feature key to use the ETF feature on your email gateway. For information on how to obtain a feature key, contact your Cisco sales representative.

STIX (Structured Threat Information eXpression) is the industry standard, structured language to represent cyber threat information. A STIX source consists of an indicator that contains a pattern used to detect malicious or suspicious cyber activity.

TAXII (Trusted Automated eXchange of Indicator Information) defines a set of specifications to exchange cyber threat information via services (TAXII servers) across different organizations or product lines.

The following versions of STIX/TAXII are supported for this release - STIX 1.1.1 and 1.2 with TAXII 1.1.

The Cisco SecureX Threat Response portal allows you to create custom feeds for the continuous gathering of observables and to consume them in your email gateway using the feed URL. A feed is a simple list of observables in JSON format. The feeds are created and managed in the **Intelligence > Feeds** page in the SecureX Threat Response portal.

Following is a list of STIX and SecureX Threat Response Indicators of Compromise (IOCs) supported for this release:

- File Hash Watchlist (describes a set of hashes for suspected malicious files)
- IP Watchlist (describes a set of suspected malicious IP addresses)
- Domain Watchlist (describes a set of suspected malicious domains)
- URL Watchlist (describes a set of suspected malicious URLs)

## How to Configure Email Gateway to Consume External Threat Feeds

Perform these steps in order:

Steps	Do This	More Information
Step 1	Obtain an External Threat Feeds feature key.	<a href="#">Obtaining External Threat Feeds Feature Key</a> , on page 296
Step 2	Enable the ETF engine on your email gateway.	<a href="#">Enabling External Threat Feeds Engine on Email Gateway</a> , on page 297
Step 3	Configure an ETF source to allow your email gateway to fetch threat feeds in STIX format from a TAXII server.	<a href="#">Configuring an External Threat Feed Source</a> , on page 298

Steps	Do This	More Information
<p>[Applicable for SecureX Threat Response Feeds Setup only] Step 4</p>	<p>[On SecureX Threat Response portal]: Create a feed URL.</p> <p><b>Note</b> When you create a feed URL, make sure to select the output of the feed URL as ‘Observables’ only.</p>	<p>For more information on how to create a feed URL, see the SecureX Threat Response Help page at:</p> <ul style="list-style-type: none"> <li>• <a href="https://visibility.amp.cisco.com/help/create-feed-url">https://visibility.amp.cisco.com/help/create-feed-url</a> [applicable for Americas users]</li> <li>• <a href="https://visibility.eu.amp.cisco.com/help/create-feed-url">https://visibility.eu.amp.cisco.com/help/create-feed-url</a> [applicable for European Union (EU) users]</li> <li>• <a href="https://visibility.apjc.amp.cisco.com/help/create-feed-url">https://visibility.apjc.amp.cisco.com/help/create-feed-url</a> [applicable for APJC users]</li> </ul>
<p>[Applicable for SecureX Threat Response Feeds Setup only] Step 5</p>	<p>[On SecureX Threat Response portal]: View and copy the details of the feed URL created in step 4 in your system.</p> <p><b>Note</b> The details of the feed URL are used to create the SecureX Threat Response feeds source.</p>	<p>For more information on how to view the details of feed URL created in step 4, see the SecureX Threat Response Help page at:</p> <ul style="list-style-type: none"> <li>• <a href="https://visibility.amp.cisco.com/help/intelligence-view-feeds">https://visibility.amp.cisco.com/help/intelligence-view-feeds</a> [applicable for Americas users]</li> <li>• <a href="https://visibility.eu.amp.cisco.com/help/intelligence-view-feeds">https://visibility.eu.amp.cisco.com/help/intelligence-view-feeds</a> [applicable for European Union (EU) users]</li> <li>• <a href="https://visibility.apjc.amp.cisco.com/help/intelligence-view-feeds">https://visibility.apjc.amp.cisco.com/help/intelligence-view-feeds</a> [applicable for APJC users]</li> </ul>
<p>[Applicable for SecureX Threat Response Feeds Setup only] Step 6</p>	<p>Configure a SecureX Threat Response Feeds source to allow your email gateway to fetch SecureX Threat Response feeds from the SecureX Threat Response portal.</p>	<p><a href="#">Configuring SecureX Threat Response Feeds Source, on page 300</a></p>
<p>Step 7</p>	<p>Handle messages that contain threats using:</p> <ul style="list-style-type: none"> <li>• HAT</li> <li>• Content or Message filters</li> </ul>	<p><a href="#">Handling Messages Containing Threats, on page 304</a></p>

Steps	Do This	More Information
Step 8	Attach the content filters that you configured to detect malicious domains, URLs, or file hashes in messages to an incoming mail policy.	<a href="#">Attaching Content Filter to Incoming Mail Policy, on page 312</a>

## Obtaining External Threat Feeds Feature Key

### Managing Email Gateways using the Classic Licensing Mode

If you are an existing user using the Classic Licensing mode and you do not have an External Threat Feeds feature key, follow the given steps to contact the Cisco Global Licensing Operations (GLO) team to obtain the feature key:

#### Procedure

- 
- Step 1** Send an email to the GLO team ([licensing@cisco.com](mailto:licensing@cisco.com)) with the message subject as "Request for External Threat Feeds Feature Key."
- Step 2** Provide your Product Authorization Key (PAK) file and Purchase order (PO) details in the email.
- The GLO team provisions the feature key manually and sends you an email with the license key to install on your email gateway.
-



### What to do next

**Note**

- If you are an existing user using the hardware or virtual email gateway models and you can obtain feature keys or software licenses directly from the Cisco server, you are automatically provided with an External Threat Feeds feature key.
- If you are an existing user using the virtual email gateway models and are not able to obtain feature keys or licenses directly from the Cisco server, perform the following steps to obtain an External Threat Feeds feature key:
  1. Log in to the License Registration Portal (LRP) using your LRP user account credentials.
  2. Select Get License.
  3. Select Migration.
  4. Select Security Products
  5. Select Email Security (ESA)
  6. Enter the VLN Number and generate the license file.

The generated license file includes the ETF feature. You need to install the new license file in your email gateway to use the ETF feature.

**Note**

If you are not able to log in to your LRP account, contact the GLO team ([licensing@cisco.com](mailto:licensing@cisco.com)) to generate the license file.

### Managing Email Gateways using the Smart Software Licensing Mode

If you are an existing or new user using the Smart Licensing mode on your email gateways, you are automatically provided with an External Threat Feeds feature key.

## Enabling External Threat Feeds Engine on Email Gateway

### Before you begin

Make sure that you have a valid feature key to you use the ETF feature on your email gateway.

### Procedure

- Step 1** Click **Security Services > External Threat Feeds**.
- Step 2** Click **Enable**.
- Step 3** Scroll to the bottom of the license agreement page and click **Accept** to accept the agreement.

**Note** If you do not accept the license agreement, ETF is not enabled on your Cisco Email Security Gateway.

- Step 4** Check **Enable External Threat Feeds**.
- Step 5** (Optional) Select **Yes** to add a custom header to all messages that are not scanned for threats by the ETF engine because of an ETF engine lookup failure.
- Step 6** Submit and commit your changes.

---

### What to do next

Configure an ETF source. See [Configuring an External Threat Feed Source, on page 298](#).

## Configuring an External Threat Feed Source

An ETF source is used to download information about a collection of threats that is available on a TAXII server. You need to configure an ETF source to allow your email gateway to fetch threat feeds in STIX format from a TAXII server.



---

**Note** You can configure a maximum of eight ETF sources in your email gateway.

---

You can configure an ETF source using the Poll service that consists of a ‘polling path’ and a ‘collection name.’

### Before you begin

- Make sure that you have enabled the ETF engine on your email gateway.
- Make sure that you open ports - 80 HTTP and 443 HTTPS on your firewall to allow your gateway to consume external threat feeds. For more information, see [Firewall Information, on page 1331](#).

### Procedure

---

- Step 1** Click **Mail Policies > External Threat Feeds Manager**.
- Step 2** Click **Add Source**.
- Step 3** Enter the required parameters described in the following table to configure an ETF source.

Parameter Source Details	Description
Source Name	Enter a name for the ETF source.
Description	Enter a description for the ETF source.
<b>TAXII Details</b>	
Hostname	Enter the hostname of a fully qualified domain name or an IP address of a TAXII server.
Polling Path	Enter the polling path that identifies the polling service in a TAXII server, for example, /taxii-data.

Parameter Source Details	Description
Collection Name	Enter the name of a collection of threat feeds that is hosted on a TAXII server, for example, guest.Abuse_ch.
Polling Interval	Enter a polling interval to define the frequency of fetching threat feeds from a TAXII server. The minimum value is 15 minutes and the default value is 60 minutes.
Age of Threat Feeds	Enter the maximum age of a threat feed that can be fetched from a TAXII server. The value for the age must be between one through 365 days.
Time Span for Poll Segment	<p>Enter the time span for each poll segment.</p> <p>The minimum time span for a poll segment is 1 day. The maximum time span for a poll segment is the value entered in the 'Age of Threat Feeds' field.</p> <p>You can use the 'Time Span for Poll Segment' option in the following scenarios:</p> <ul style="list-style-type: none"> <li>• If there is no known limitation on the age of threat feeds for a TAXII server, use the value entered in the 'Age of Threat Feeds' option.</li> <li>• If there is a known limitation on the age of threat feeds for a TAXII server, use the known limit value.</li> <li>• If you do not know the known limitation on the age of threat feeds for a TAXII server, use the default value of 30 days.</li> <li>• If the value you enter in the 'Age of Threat Feeds' option is not supported by the TAXII server, you can split the age of threat feeds into different poll segments based on the time span entered.</li> </ul> <p>For example, if the age of the threat feeds is 100 days and the TAXII server has a fixed limit on the age of threat feeds (for example, '40 days'), enter 40 as the time span for poll segment</p> <p><b>Note</b> If the time span for the poll segment is a small value (for example, '5 days') the polling of the threat feed source can take a long time to complete, and this may impact the performance of your gateway.</p>
Use HTTPS	Select <b>Yes</b> if you want to connect to a TAXII server using HTTPS.



Parameter Source Details	Description
Configure Credentials	Select <b>Yes</b> , if you want to access a TAXII server using the user credentials that you created in the TAXII server.  Enter the username and password.
<b>Proxy Details</b>	
Use Global Proxy	Select <b>Yes</b> , if you want the email gateway to connect to a TAXII server through a proxy server.  You can configure a proxy server in any one of the following ways: <ul style="list-style-type: none"> <li>• Security Services &gt; Service Updates page in the web interface</li> <li>• <code>updateconfig</code> command in the CLI</li> </ul> If you select <b>No</b> , the email gateway directly connects to a TAXII server.

**Step 4** Submit and commit your changes.

---

After you configure an ETF source, your email gateway begins to fetch threat feeds from a TAXII source.

#### What to do next

- You can also configure an ETF source using the `threatfeedsconfig > sourceconfig` subcommand in the CLI.
- (Optional) Click **Suspend Polling** (  ) icon in the Mail Policies > External Threat Feeds Manager page to suspend the polling service for a configured ETF source.
- (Optional) Click **Resume Polling** (  ) icon in the Mail Policies > External Threat Feeds Manager page to resume the polling service for a configured ETF source.
- (Optional) Click **Poll Now** in the Mail Policies > External Threat Feeds Manager page to fetch the threat feeds from the last successful polling interval immediately.
- See [Handling Messages Containing Threats, on page 304](#).

## Configuring SecureX Threat Response Feeds Source

A SecureX Threat Response feeds source is used to download information about a collection of threats available on the SecureX Threat Response portal. You need to configure a SecureX Threat Response feeds source to allow your email gateway to fetch threat feeds from the SecureX Threat Response portal.



**Note** You can configure a maximum of eight SecureX Threat Response feeds sources in your email gateway.

### Before you begin

Make sure that you have met the following prerequisites:

- Enabled the ETF engine on your email gateway.
- Opened ports - 80 HTTP and 443 HTTPS on your firewall to allow your gateway to consume SecureX Threat Response feeds. For more information, see [Firewall Information, on page 1331](#).
- Created a user account in Cisco SecureX with admin access rights. To create a new user account, go to **Cisco SecureX login** page using the URL <https://securex.us.security.cisco.com/login> and click **Create a SecureX Sign-on Account** in the login page. If you are unable to create a new user account, contact Cisco TAC for assistance.
- Created a feed URL in the SecureX Threat Response portal. For more information, see the SecureX Threat Response Help page at:
  - <https://visibility.amp.cisco.com/help/create-feed-url> [applicable for Americas users]
  - <https://visibility.eu.amp.cisco.com/help/create-feed-url> [applicable for European Union (EU) users]
  - <https://visibility.apjc.amp.cisco.com/help/create-feed-url> [applicable for APJC users]
- Viewed and copied the details of the feed URL created in the SecureX Threat Response portal in your system. For more information, see the SecureX Threat Response Help page at:
  - <https://visibility.amp.cisco.com/help/intelligence-view-feeds> [applicable for Americas users]
  - <https://visibility.eu.amp.cisco.com/help/intelligence-view-feeds> [applicable for European Union (EU) users]
  - <https://visibility.apjc.amp.cisco.com/help/intelligence-view-feeds> [applicable for APJC users]

### Procedure

- Step 1** Click **Mail Policies** > **External Threat Feeds Manager**.
- Step 2** Click **Add Source**.
- Step 3** Enter the required parameters described in the following table to configure a SecureX Threat Response feeds source.

Parameter Source Details	Description
Source Name	Enter a name for the SecureX Threat Response feeds source.
Description	Enter a description for the SecureX Threat Response feeds source.

Parameter Source Details	Description
<p><b>TAXII Details</b></p> <p>The SecureX Threat Response feeds source is different from a typical TAXII feeds source. However, to enable polling of observables from the SecureX Threat Response server, you must map the SecureX Threat Response feed URL to the following TAXII source parameters.</p> <ul style="list-style-type: none"> <li>• Hostname</li> <li>• Polling Path</li> <li>• Collection Name</li> </ul> <p><b>For Example:</b> The following is a sample SecureX Threat Response feed URL created in the SecureX Threat Response portal.</p> <pre>&lt;https://private.intel.amp.cisco.com/ctia/feed/feed-d78e1eba-cbe6-5e13-8d47-197b344e41c9/view.txt?s=e8f3f519-9170-4b76-8b58-bda0be540ff3&gt;</pre> <p>You can map the sample SecureX Threat Response feed URL details to the following TAXII source parameters:</p> <ul style="list-style-type: none"> <li>• <b>Hostname</b> - consists of the “<i>private.intel.amp.cisco.com</i>” part of the SecureX Threat Response feed URL.</li> <li>• <b>Polling Path</b> -: consists of the “<i>/ctia/feed/feed-d78e1eba-cbe6-5e13-8d47-197b344e41c9/view</i>” part of the SecureX Threat Response feed URL.</li> </ul> <p><b>Note</b> Do not include the “.txt” part of the SecureX Threat Response feed URL in the Polling Path.</p> <ul style="list-style-type: none"> <li>• <b>Collection Name</b> - consists of “<i>e8f3f519-9170-4b76-8b58-bda0be540ff3</i>” part of the SecureX Threat Response feed URL.</li> </ul> <p>Using the above example, you can configure the ‘Hostname,’ ‘Polling Path,’ and ‘Collection Name’ parameters. For more information, on how to configure these parameters, see below.</p>	
<p>Hostname</p>	<p>Enter the hostname of the SecureX Threat Response feed URL based on your SecureX Threat Response server region.</p> <p>The following are the hostnames that you can choose based on your SecureX Threat Response server region:</p> <ul style="list-style-type: none"> <li>• <i>private.intel.amp.cisco.com</i> [applicable for Americas users]</li> <li>• <i>private.intel.eu.amp.cisco.com</i> [applicable for EU users]</li> <li>• <i>private.intel.apjc.amp.cisco.com</i> [applicable for APJC users]</li> </ul>



Parameter Source Details	Description
Polling Path	Enter the polling path that identifies the polling service in the SecureX Threat Response server.  For Example: <code>/ctia/feed/feed-d78e1eba-cbe6-5e13-8d47-197b344e41c9/view</code>
Collection Name	Enter the name of a collection of SecureX Threat Response feeds that is hosted on a SecureX Threat Response server.  For Example: <code>e8f3f519-9170-4b76-8b58-bda0be540ff3</code>
Polling Interval	Enter a polling interval to define the frequency of fetching SecureX Threat Response feeds from the SecureX Threat Response server. The minimum value is 15 minutes and the default value is 60 minutes.  <b>Note</b> The maximum limit of a full poll is 100 mb and if the size of the feed observables is more than the maximum limit, the email gateway displays an error message in the ETF logs.
Age of Threat Feeds, Time Span for Poll Segment	These parameters are not required to configure a SecureX Threat Response feeds source because polling of observables from the SecureX Threat Response server is not based on time intervals. A full poll method is used to obtain the observables.
Use HTTPS	Select <b>Yes</b> if you want to use the HTTPS proxy server to connect your email gateway with the SecureX server.  <b>Note</b> This parameter is used only when you enable and configure a proxy server on your email gateway.
Configure Credentials	This parameter is not required to configure a SecureX Threat Response feeds source.
<b>Proxy Details</b>	

Parameter Source Details	Description
Use Global Proxy	<p>Select <b>Yes</b>, if you want the email gateway to connect to the SecureX Threat Response server through a proxy server.</p> <p>You can configure a proxy server in any one of the following ways:</p> <ul style="list-style-type: none"> <li>• Security Services &gt; Service Updates page in the web interface</li> <li>• <code>updateconfig</code> command in the CLI</li> </ul> <p>If you select <b>No</b>, the email gateway directly connects to the SecureX Threat Response server.</p>

**Step 4** Submit and commit your changes.

After you configure a SecureX Threat Response feeds source, your email gateway begins to fetch threat feeds from a SecureX Threat Response source.

#### What to do next

- You can also configure a SecureX Threat Response feeds source using the `threatfeedsconfig > sourceconfig` sub command in the CLI.
- (Optional) Click **Suspend Polling** (  ) icon in the Mail Policies > External Threat Feeds Manager page to suspend the polling service for a configured SecureX Threat Response feeds source.
- (Optional) Click **Resume Polling** (  ) icon in the Mail Policies > External Threat Feeds Manager page to resume the polling service for a configured SecureX Threat Response feeds source.
- (Optional) Click **Poll Now** in the Mail Policies > External Threat Feeds Manager page to fetch the SecureX Threat Response feeds from the last successful polling interval immediately.
- See [Handling Messages Containing Threats, on page 304](#).

## Handling Messages Containing Threats

You can handle messages that contain threats in your email gateway using:

- HAT
- Content or Message filters

#### Related Topics

- [Configuring a Sender Group for Handling Messages containing Threats , on page 305](#).
- [Configuring Content or Message Filters for Handling Messages Containing Threats, on page 305](#).



# Configuring a Sender Group for Handling Messages containing Threats

You can configure an existing sender group to handle messages that originate from malicious IPs using the verdict obtained from the ETF engine.

## Procedure

---

- Step 1** Go to **Mail Policies > HAT Overview** page.
  - Step 2** Click an existing sender group that you want to configure to handle messages that contain threats.
  - Step 3** Click **Edit Settings**.
  - Step 4** Select the required ETF source to filter malicious IP addresses.
  - Step 5** (Optional) Click **Add Row** to add another ETF source.
  - Step 6** Submit and commit your changes.
- 

# Configuring Content or Message Filters for Handling Messages Containing Threats

You can configure one or more of the following content or message filters, to take appropriate actions on messages that contain threats based on the verdicts obtained from the ETF engine:

- URL Reputation - to detect URLs categorized as malicious by the ETF engine.
- Domain Reputation - to detect domains categorized as malicious by the ETF engine.
- Attachment by File Info - to detect files categorised as malicious by the ETF engine based on the file hash.

## Related Topics

- [Detecting Malicious Domains in Messages Using Content Filter, on page 306.](#)
- [Detecting Malicious Domains in Messages Using Message Filter, on page 307](#)
- [Detecting Malicious URLs in Messages Using Content Filter, on page 307](#)
- [Detecting Malicious URLs in Messages Using Message Filter, on page 309](#)
- [Detecting Malicious Files in Message Attachments Using Content Filter, on page 310.](#)
- [Detecting Malicious Files in Messages Attachments Using Message Filter , on page 224.](#)

## Detecting Malicious Domains in Messages Using Content Filter

Use the 'Domain Reputation' content filter to detect domains categorized as malicious in messages by the ETF engine and take appropriate actions on such messages.

### Before you begin

- Optional) Create an address list that contains only domains. To create one, go to **Mail Policies > Address Lists** page in the web interface or use the `addresslistconfig` command in the CLI. For more information, see [Mail Policies, on page 255](#).
- (Optional) Create a Domain Exception List. For more information, see [Creating Domain Exception List](#).

### Procedure

- 
- Step 1** Go to **Mail Policies > Incoming Content Filters**.
  - Step 2** Click **Add Filter**.
  - Step 3** Enter a name and description for the content filter.
  - Step 4** Click **Add Condition**.
  - Step 5** Click **Domain Reputation**.
  - Step 6** Select **External Threat Feeds**.
  - Step 7** Select the ETF source(s) to detect malicious domain(s) in the header(s) of a message.
  - Step 8** Select the required headers to check for the reputation of the domain.
  - Step 9** (Optional) Select the list of allow listed domains that you do not want the email gateway to detect for threats for this content filter.
  - Step 10** Click **OK**.
  - Step 11** Click **Add Action** to configure an appropriate action to take on messages that contain malicious domains.
  - Step 12** Submit and commit your changes.
- 

## Creating Domain Exception List

A Domain Exception List consists of a list of addresses that contain only domains. You can use a Domain Exception List if you want the email gateway to skip the domain check for all configured Domain Reputation content or message filters.

### Procedure

- 
- Step 1** Go to **Security Services > Domain Reputation**.
  - Step 2** Click **Edit Settings** under Domain Exception List.
  - Step 3** Select the required address list that contains domains only.
  - Step 4** Submit and commit your changes.
-

**What to do next**

You can also create a Domain Exception List using the `domainrepconfig` command in the CLI. For more information, see the *CLI Reference Guide for AsyncOS 12.0 for Cisco Email Security Appliances*.

## Detecting Malicious Domains in Messages Using Message Filter

As an example, use the following message filter rule syntax to detect malicious domains in messages using the ETF engine, and take appropriate actions on such messages.

**Syntax:**

```
quarantine_msg_based_on ETF: if (domain-external-threat-feeds (['etf_source1'],
  ['mail-from', 'from'], <'domain_exception_list'>)) { quarantine("Policy"); }
```

**Where**

- `'domain-external-threat-feeds'` is the Domain reputation message filter rule.
- `'etf_source1'` is the ETF source(s) used to detect malicious domain(s) in the header(s) of a message.
- `'mail-from', 'from'` are the required header(s) used to check for the reputation of the domain.
- `'domain_exception_list'` is the name of a domain exception list. If a domain exception list is not present it is displayed as "".

**Example**

In the following example, if the domain in the 'Errors To:' custom header is detected as malicious by the ETF engine, the message is quarantined.

```
Quarantining_Messages_with_Malicious_Domains: if domain-external-threat-feeds
(['threat_feed_source'], ['Errors-To'], "") { quarantine("Policy"); }
```

## Detecting Malicious URLs in Messages Using Content Filter

Use the 'URL Reputation' content filter to detect URLs in messages categorized as malicious by the ETF engine and take appropriate actions on such messages.

You can configure the 'URL Reputation' content filter for ETF in any one of the following ways:

- Use the 'URL Reputation' condition with any appropriate action.
- Use the 'URL Reputation' action with any or no condition.
- Use the 'URL Reputation' condition and action.

The following procedure is used to detect malicious URLs using the 'URL Reputation' condition and action:

**Note**

- If you only want to use the 'URL Reputation' condition with any appropriate action, do not follow steps 11-20 of the procedure.
- If you only want to use the 'URL Reputation' action with any or no condition., do not follow steps 4-10 of the procedure.

**Before you begin**

- Make sure that you enable URL filtering on your email gateway. To enable URL filtering, go to *Security Services > URL Filtering* page in the web interface. For more information, see [Protecting Against Malicious or Undesirable URLs, on page 443](#).
- Make sure that you enable Outbreak Filters on your email gateway. To enable Outbreak Filters, go to *Security Services > Outbreak Filters* page in the web interface. For more information, see [Outbreak Filters, on page 421](#).
- Make sure that you enable Anti-Spam engine on your email gateway. To enable the Anti-Spam engine, go to *Security Services > Anti-Spam* page in the web interface. For more information, see [Managing Spam and Graymail, on page 379](#).
- (Optional) Create a URL list. To create one, go to *Mail Policies > URL Lists* page in the web interface. For more information, see [Protecting Against Malicious or Undesirable URLs, on page 443](#).

**Procedure**

- 
- Step 1** Go to **Mail Policies > Incoming Content Filters**.
- Step 2** Click **Add Filter**.
- Step 3** Enter a name and description for the content filter.
- Step 4** Click **Add Condition**.
- Step 5** Click **URL Reputation**.
- Step 6** Select **External Threat Feeds**.
- Step 7** Select the ETF source(s) to detect malicious URLs.
- Step 8** (Optional) Select the list of allow listed URLs that you do not want the email gateway to detect for threats.
- Step 9** Select the required **Check URLs within** option to detect malicious URLs in the message body and subject and/or message attachments.
- Step 10** Click **OK**.
- Step 11** Click **Add Action**.
- Step 12** Click **URL Reputation**.
- Step 13** Select **External Threat Feeds**.
- Step 14** Make sure that you select the same ETF source(s) that you selected in the condition (Step 7).
- Step 15** (Optional) Select the same list of allow listed URLs that you selected in Step 8.
- Step 16** Select the required **Check URLs within** option to detect malicious URLs in the 'message body and subject' and/or 'message attachments'
- Step 17** Select the required action that you want to perform on the URLs within the message body and subject and/or message attachments.
- Note** In Step 16, if you choose the 'Check URLs within' option as 'Attachments', you can only strip the attachment from the message.
- Step 18** Select whether you want to take actions on all messages or unsigned messages.
- Step 19** Click **OK**.
- Step 20** Submit and commit your changes.

**Note** If you have configured URL Reputation content filters for Web Based Reputation Score (WBRS) and ETF on your email gateway, it is recommended to set the order of the WBRS URL Reputation content filter higher than the order of the ETF URL Reputation filter, to improve the performance of your email gateway.

## Detecting Malicious URLs in Messages Using Message Filter

As an example, use the 'URL Reputation' message filter rule syntax to detect malicious URLs in messages using the ETF engine, and to defang the URL.

### Syntax:

```
defang_url_in_message: if (url-external-threat-feeds (['etf_source1'],
<'URL_allowedlist'>,
<'message_attachments'> , <'message_body_subject'> ,))
{ url-etf-defang(['etf_source1'], "", 0); } <'URL_allowedlist'> ,
<'Preserve_signed'>}
```

### Where

- 'url-external-threat-feeds' is the URL Reputation rule.
- 'etf\_source1' is the ETF source(s) used to detect malicious URLs in the messages or message attachments.
- 'URL\_allowedlist' is the name of a URL allowed list. If a URL allowed list is not present, it is displayed as "".
- 'message\_attachments' is used to check for malicious URLs in the message attachments. A value of '1' is used to detect malicious URLs in the message attachments.
- 'message\_body\_subject' is used to check for malicious URLs in the message body and subject. A value of '1' is used to detect malicious URLs in the message body and subject.



**Note** A value of "1,1" is used to detect malicious URLs in the message body, subject, and message attachments.

- 'url-etf-defang' is one of the actions that you can take on messages that contain malicious URLs.

The following examples are the ETF-based actions that you can apply on messages that contain malicious URLs:

- url-etf-strip(['etf\_source1'], "None", 1)
- url-etf-defang-strip(['etf\_source1'], "None", 1, "Attachment removed")
- url-etf-defang-strip(['etf\_source1'], "None", 1)
- url-etf-proxy-redirect(['etf\_source1'], "None", 1)
- url-etf-proxy-redirect-strip(['etf\_source1'], "None", 1)
- url-etf-proxy-redirect-strip(['etf\_source1'], "None", 1, " Attachment removed")

- url-etf-replace(['etf\_source1'], "", "None", 1)
  - url-etf-replace(['etf\_source1'], "URL removed", "None", 1)
  - url-etf-replace-strip(['etf\_source1'], "URL removed ", "None", 1)
  - url-etf-replace-strip(['etf\_source1'], "URL removed\*", "None", 1, "Attachment removed")
- 'Preserve\_signed' is represented by '1' or '0'. '1' indicates that this action applies to unsigned messages only and '0' indicates that this action applies to all messages.

In the following example, if a URL in the message attachment is detected as malicious by the ETF engine, the attachment is stripped.

```
Strip_Malicious_URLs: if (true) {url-etf-strip(['threat_feed_source'], "", 0);}
```

## Detecting Malicious Files in Message Attachments Using Content Filter

Use the 'Attachment File Info' content filter to detect files in message attachments categorized as malicious by the ETF engine, and take appropriate actions on such messages.



---

**Note** The ETF engine performs a lookup based on the file hash of a file.

---

You can configure the 'Attachment File Info' content filter for ETF in any one of the following ways:

- Use the 'Attachment File Info' condition with any appropriate action.
- Use the 'Strip Attachment by File Info' action with any or no condition.
- Use the 'Attachment File Info' condition and 'Strip Attachment by File Info' action.

The following procedure is used to detect malicious files in message attachments using the 'Attachment by File Info' condition and 'Strip Attachment by File Info' action:



- 
- Note**
- If you only want to use the 'Attachment File Info' condition with any appropriate action, do not follow steps 10-15 of the procedure.
  - If you only want to use the 'Strip Attachment by File Info' action with any or no condition., do not follow steps 4-9 of the procedure.
- 

### Before you begin

(Optional) Create a File Hash Exception List. To create one, go to Mail Policies > File Hash Lists page in the web interface. For more information, see [Creating File Hash List, on page 311](#).

### Procedure

---

- Step 1** Go to **Mail Policies > Incoming Content Filters**.
  - Step 2** Click **Add Filter**.
  - Step 3** Enter a name and description for the content filter.
  - Step 4** Click **Add Condition**.
  - Step 5** Click **Attachment File Info**.
  - Step 6** Select **External Threat Feeds**.
  - Step 7** Select the ETF source(s) to detect malicious files using file hashes.
  - Step 8** (Optional) Select the list of file hashes that you do not want the email gateway to detect for threats.
  - Step 9** Click **OK**.
  - Step 10** Click **Add Action**.
  - Step 11** Click **Strip Attachment by File Info**.
  - Step 12** Select **External Threat Feeds**.
  - Step 13** Make sure that you select the same ETF source(s) that you selected in the condition (Step 7).
  - Step 14** (Optional) Select the same list of file hashes that you selected in Step 8.
  - Step 15** Submit and commit your changes.
- 

## Creating File Hash List

### Procedure

---

- Step 1** Go to **Mail Policies > File Hash Lists**.
  - Step 2** Click **Add File Hash List**.
  - Step 3** Check the required file hash type - 'SHA256' or 'MD5' or all of the above.
  - Step 4** Enter the file hashes (that you selected in Step 3) separated by commas or in new lines.
  - Step 5** Submit and commit your changes.
- 

## Detecting Malicious Files in Messages Attachments Using Message Filter

As an example, use the following message filter rule syntax to detect files in message attachments categorized as malicious by the ETF engine, and take appropriate actions on such messages.

### Syntax:

```
Strip_malicious_files: if (file-hash-ETF-rule (['etf_source1'], <'file_hash_exception_list'>))
{ file-hash-ETF-strip-attachment-action (['etf_source1'], <'file_hash_exception_list'>,
"file stripped from message attachment"); }
```

### Where:

- 'file-hash-ETF-rule' is the Attachment File Info message filter rule

- `'etf_source1'` is the ETF source(s) used to detect malicious files in the messages based on the file hash.
- `'file_hash_exception_list'` is the name of a file hash exception list. If a file hash exception list is not present, it is displayed as `""`.
- `'file-hash-etf-strip-attachment-action'` is the name of the action that you want to apply on messages that contain malicious files.

In the following example, if a message contains a message attachment detected as malicious by the ETF engine, the attachment is stripped.

```
Strip_Malicious_Attachment: if (true) {file-hash-etf-strip-attachment-action
(['threat_feed_source'], "", "Malicious message attachment has been stripped from
the message.");}
```

## Attaching Content Filter to Incoming Mail Policy

You can attach one or more of the content filters that you configured to detect malicious domains, URLs, or file hashes in messages to an incoming mail policy.

### Procedure

- 
- Step 1** Go to **Mail Policies > Incoming Mail Policies**.
  - Step 2** Click the link below **Content Filters** of a particular mail policy.
  - Step 3** Select **Enable Content Filters (Customize Settings)**.
  - Step 4** Select the Content Filters that you created for detecting malicious domains, URLs or file hashes.
  - Step 5** Submit and commit your changes.
- 

### What to do next

After you attach the content filter to an incoming mail policy, your email gateway begins to take actions on messages based on the verdicts received from the ETF engine.

## External Threat Feeds and Clusters

If you use centralized management, you can enable the ETF engine and mail policies at the cluster, group, and machine level.

## Monitoring External Threat Feeds Engine Updates

If you have enabled service updates, the ETF engine updates are retrieved from the Cisco update servers. However, in some scenarios (for example, you have disabled automatic service updates or automatic service update is not working), you might want to manually check for ETF engine updates.

You can manually update the ETF engine in any one of the following ways:



- Go to **Security Services > External Threat Feeds** page in the web interface, and click **Update Now**.
- Use the `threatfeedupdate` command in the CLI.

To know the details of the existing ETF engine, see the ‘External Threat Feeds Engine Updates’ section in the Security Services > External Threat Feeds page in the web interface or use the `threatfeedstatus` command in CLI.

## Viewing Alerts

The following table lists the alerts generated by the ETF engine, including a description of the alert and the alert severity.

Component/Alert Name	Message and Description	Parameters
ETF ENGINE ALERT	Unable to fetch the observables from the source: \$source_name after 3 failed attempts. Reason for failure: \$reason	‘source’ - The name of the TAXII source. ‘reason’ - The reason why the polling failed.
	Information. Sent when polling feeds from a TAXII source fails.	
ETF ENGINE ALERT	The storage limit of \$count observables exceeded for the observable type: \$type.	\$count - The allowed number of observables per type. \$ type - The type of the observable.
	Information. Sent when the number of permitted observables exceeded.	

## Displaying Threat Details in Message Tracking

You can view the message details that contain threats corresponding to the selected IOCs from the selected ETF source(s).

### Before you begin

- Make sure that you enable the Message Tracking feature on the email gateway. To enable Message Tracking, go to **Security Services > Centralized Services > Message Tracking** page in the web interface.
- Content or Message filters for detecting threats in messages are operational.

### Procedure

- 
- Step 1** Go to **Monitor > Message Tracking**.
  - Step 2** Click **Advanced**.
  - Step 3** Check **External Threat Feeds** under Message Event.

- Step 4** Select the required IOC(s) to track messages containing threats corresponding to the selected IOCs.
- Step 5** (Optional) Select **All External Threat Feed Sources** to view the messages that contain threats based on the available and deleted ETF source(s) configured in the email gateway.
- Step 6** (Optional) Select **Current External Threat Feed Sources** and choose the required ETF source(s) to view the messages that contain threats based on the available ETF source(s) configured in the email gateway.
- Step 7** (Optional) Enter the name of a particular ETF source in the 'External Threat Feed Sources' field to view messages that contain threats based on this ETF source.
- Step 8** Click **Search**.
-



## CHAPTER 13

# Sender Domain Reputation Filtering

This chapter contains the following sections:

- [Overview of Sender Domain Reputation Filtering, on page 315](#)
- [How to Filter Messages based on Sender Domain Reputation, on page 318](#)
- [Enabling Sender Domain Reputation Filtering on Email Gateway, on page 318](#)
- [Tuning Sender Domain Reputation Policy , on page 319](#)
- [Configuring Message or Content Filter for Handling Messages based on Sender Domain Reputation, on page 320](#)
- [Attaching Content Filter to Incoming Mail Policy, on page 324](#)
- [Sender Domain Reputation Filtering and Clusters, on page 324](#)
- [Displaying Sender Domain Reputation Details in Message Tracking, on page 325](#)
- [Viewing Alerts, on page 325](#)
- [Viewing Logs, on page 325](#)

## Overview of Sender Domain Reputation Filtering

Cisco Talos Sender Domain Reputation (SDR) is a cloud service that provides a reputation verdict for email messages based on the domains provided in the email envelope and header. Examples may include domains from - HELO/EHLO strings, envelope and header "From" addresses, "Reply-to" addresses, and "List-Unsubscribe" headers.

The domain-based reputation analysis enables a higher spam catch rate by looking beyond the reputation of shared IP addresses, hosting or infrastructure providers, and derives verdicts based on features that are associated with fully qualified domain names (FQDNs) and other sender information in the Simple Mail Transfer Protocol (SMTP) conversation and message headers.

The Sender Domain Age option is replaced with Sender Maturity from AsyncOS 14.2.x release onwards. Sender Maturity is an important feature to establish sender reputation. Sender Maturity is automatically generated for spam classification based on multiple sources of information and can differ from "Whois-based domain age." Sender Maturity is set to a limit of 30 days, and beyond this limit, a domain is considered mature as an email sender, and no further details are provided.

From this release onwards, an additional Sender Domain Reputation check is performed after the sender header of the message is received. Messages with a Threat Level that matches the configured SDR reject level (in your email gateway) are rejected.



---

**Note** From this release onwards, the 'SDR Domain Age' configured filters are automatically updated to the 'SDR Sender Maturity' filters. The filters with an invalid value for Sender Maturity are marked as 'inactive' after the upgrade. Make sure you review and modify the message and content filters accordingly.

---



---

**Note** The Sender Maturity functionality uses the current time of your email gateway to display the Sender Maturity information in the logs and to match the required filter conditions. Make sure your email gateway is configured with the correct time based on your time zone.

---

After you upgrade to AsyncOS 14.2.x release, the legacy SDR verdicts in the content or message filters, reporting, and message tracking are replaced with the new SDR verdicts as follows:

- Untrusted
- Questionable
- Neutral
- Favorable
- Trusted
- Unknown

For more information about the recommended actions, you can take for each new SDR verdict, see [SDR Verdicts, on page 316](#).

For more information, see the Cisco Talos Sender Domain Reputation (SDR) white paper in the Security Track of the Cisco Customer Connection program at <http://www.cisco.com/go/ccp>.



---

**Note**

- You must create a Cisco Customer Connection account to access the SDR white paper.
- Like Cisco IPAS disputes, submit SDR disputes by opening a support request with the Cisco Technical Assistance Center (TAC).

---

## SDR Verdicts

The following table lists the SDR verdict names, descriptions, and recommended actions:

Table 35: SDR Verdicts

Verdict Name	Description	Recommended Action
Untrusted	The worst reputation verdict.  Safest recommended blocking threshold. Expect to see false-negatives (FN) if the blocking threshold is set to only this verdict, which prioritizes delivery over security.	Block the message.
Questionable	This verdict has a low and relatively safe false-positive (FP) rate and might not be safe for all organizations.  Not blocking on this verdict prioritizes delivery over security, but it results in false-negatives.	Scan the message with the other engines configured on your email gateway. Block only after review. For more information, see <a href="#">Tuning Sender Domain Reputation Policy</a> , on page 319.
Neutral	The most common verdict, assigned to legitimate and mixed-use domains, associated with weak indicators that prevent a favorable verdict.	Scan the message with the other engines configured on your email gateway.
Favorable	The sender is using a fair domain that is not a new domain. The sender is following sender best practices, including, but not limited to using SPF, DKIM-signing, employing DMARC, and not sending spam.	Scan the message with the other engines configured on your email gateway.
Trusted	A rare verdict that indicates the sender is using a certified domain, where messages are authenticated by DKIM (aligned on the "From:" header domain).	Allow the message.  For more information on how to bypass subsequent engines, use Message Filter rules such as "skip-spamcheck," "skip-viruscheck," and so on, see the "Message Filter Actions" section in the <a href="#">Using Message Filters to Enforce Email Policies</a> , on page 127.
Unknown	The sender is using domains that SDR does not recognize or cannot use to establish a reputation.	Scan the message with the other engines configured on your email gateway.

# How to Filter Messages based on Sender Domain Reputation

Steps	Do This	More Information
Step 1	Enable SDR filtering on Cisco Email Security Gateway.  <b>Note</b> After you upgrade to AsyncOS 12.0, SDR queries are enabled by default.	<a href="#">Enabling Sender Domain Reputation Filtering on Email Gateway, on page 318</a>
Step 2	[Optional] Perform a review of the SDR configuration in your email gateway to establish an appropriate SDR policy	<a href="#">Tuning Sender Domain Reputation Policy , on page 319</a>
Step 3	Configure a message or content filter to handle messages based on SDR.	<a href="#">Configuring Message or Content Filter for Handling Messages based on Sender Domain Reputation, on page 320</a>
Step 4	Attach the content filter that you configured to filter messages based on SDR to an incoming mail policy.	<a href="#">Attaching Content Filter to Incoming Mail Policy, on page 324</a>

## Enabling Sender Domain Reputation Filtering on Email Gateway



**Note** After you upgrade to AsyncOS 12.0, SDR queries are enabled by default.

### Procedure

- Step 1** Go to **Security Services > Domain Reputation**.
- Step 2** Click **Enable**.
- Step 3** Check **Enable Sender Domain Reputation Filtering**.
- Step 4** (Optional) Check **Include Additional Attributes** if you want the SDR service to check for SDR based on additional attributes of the message.
- If you enable this option, the following additional attributes of the message are included in the SDR check to improve the efficacy:
- Username part of the email address present in the 'Envelope From:', 'From:', and 'Reply-To:' headers.
  - Display name in the 'From:' and 'Reply-To:' headers.

- Step 5** (Optional) Enter the number of elapsed seconds before the SDR query times out.
- Note** Modifying the SDR query timeout value may impact the performance of mail processing.
- Step 6** (Optional) Check **Match Domain Exception List based on Domain in Envelope From**: if you want the email gateway to skip the SDR check based on the domain in the Envelope From: header only.
- Step 7** Move the **Range Slider** to choose the required SDR verdict range to accept or reject messages at the SMTP conversation level.
- Note** After you upgrade to AsyncOS 14.x and later, the range slider by default points to the Untrusted verdict. All messages with the Untrusted verdict are dropped at the SMTP conversation level.
- Note** You cannot select the Favorable verdict to reject messages because the verdict indicates that the sender uses a certified domain.
- Step 8** Click **Submit** .
- Step 9** (Optional) Click **I Agree** if you want to accept the SDR Include Additional Attributes Agreement message.
- Note** The SDR Include Additional Attributes Agreement message appears only when you select the Include Additional Attributes option.
- Step 10** Click **Commit** to commit your changes.

---

### What to do next

Configure a content or message filter to handle messages based on SDR. See [Configuring Message or Content Filter for Handling Messages based on Sender Domain Reputation, on page 320](#).

Review the SDR configuration in your email gateway to establish an appropriate SDR policy. See [Tuning Sender Domain Reputation Policy , on page 319](#).

## Tuning Sender Domain Reputation Policy

SDR recommends default behaviors for each verdict. However, if optimal tuning of false-positives and false-negatives is essential to your organization, follow the given steps to tune the SDR policy based on your security requirements.

### Procedure

---

- Step 1** Enable SDR on your email gateway without configuring any SDR policy actions for 10 days.
- Step 2** Use the Message Tracking functionality to review messages based on the SDR verdict.
- For more information, see [Displaying Sender Domain Reputation Details in Message Tracking, on page 325](#). You can search for messages that received a verdict of 'Untrusted' or 'Questionable.'
- Step 3** Review the messages obtained from the Message Tracking search (performed in step 2) for any false positives or false negatives.

False positives are messages that require to be delivered to the recipient's mailbox but received a verdict of 'Questionable' or especially 'Untrusted.' False-negatives are messages that have not received an 'Untrusted' verdict but are expected to be blocked based on the message attributes related to SDR.

**Step 4** [If false-positives are present because the message received an 'Untrusted' verdict] Open a support ticket with Cisco TAC before you proceed to configure SDR policy to block messages based on the 'Untrusted' verdict.

**Note** In most use-cases, Cisco Talos expects you to block messages with an 'Untrusted' verdict.

**Step 5** Use the recommended safe 'Untrusted' threshold if false-positives are present in the messages that received a "Questionable" verdict.

**Note** If you do not use the 'Untrusted' threshold, you can block messages based on the more aggressive 'Questionable' threshold. For more information, see [Configuring Message or Content Filter for Handling Messages based on Sender Domain Reputation, on page 320](#).

**Note** The 'Questionable' verdict is associated with large volume senders that send spam messages but might also deliver legitimate (mostly low-priority) bulk email. It is appropriate to block messages after review based on your security requirements.

## Configuring Message or Content Filter for Handling Messages based on Sender Domain Reputation

You can use the 'Domain Reputation' message or content filter in any one of the following ways to filter messages based on SDR, and take appropriate actions on such messages:

- Sender Domain Verdict
- Sender Maturity
- Sender Domain Unscannable



**Note** The Sender Domain Age option is replaced with Sender Maturity from AsyncOS 14.2.x release onwards. Sender Maturity is already incorporated into the SDR verdict. It is generally not recommended to filter messages based on Sender Maturity, except for special use-cases.

### Related Topics

- [Tuning Sender Domain Reputation Policy , on page 319](#)
- [Filtering Messages based on Sender Domain Reputation using Message Filter, on page 321](#)
- [Filtering Messages based on Sender Domain Reputation using Content Filter, on page 323](#)



# Filtering Messages based on Sender Domain Reputation using Message Filter

## Filtering Messages based on Sender Domain Verdict



**Note** The recommended blocking threshold is "Untrusted." For more information about SDR verdicts, see [SDR Verdicts, on page 316](#) and for tuning SDR policy, see [Tuning Sender Domain Reputation Policy, on page 319](#)

### Syntax:

```
drop_msg_based_on_sdr_verdict:
if sdr-reputation (['untrusted', 'questionable'], "<domain_exception_list>")
{drop();}
```

### Where:

- 'drop\_msg\_based\_on\_sdr\_verdict' is the name of the message filter.
- 'sdr-reputation' is the Domain Reputation message filter rule.
- 'untrusted', 'questionable' is the range of the sender domain verdict used to filter messages based on SDR.
- 'domain\_exception\_list' is the name of a domain exception list. If a domain exception list is not present it is displayed as "".
- 'drop' is the action applied on the message.

### Example

In the following message, if the SDR verdict is 'Unknown', the message is quarantined.

```
quarantine_unknown_sdr_verdicts:
if sdr-reputation (['unknown'], "")
{quarantine("Policy")}
```

## Filtering Messages based on Sender Maturity



**Note** The Sender Domain Age option is replaced with Sender Maturity from AsyncOS 14.2.x release onwards. Sender Maturity is already incorporated into the SDR verdict. It is generally not recommended to filter messages based on Sender Maturity, except for special use-cases. Sender Maturity is set to a limit of 30 days, and beyond this limit, a domain is considered mature as an email sender, and no further details are provided.

### Syntax:

```
<msg_filter_name>
if sdr-maturity (<'unit'>, <'operator'> <'actual value'>)
{<action>}
```

### Where:

- 'sdr-maturity' is the Sender Maturity message filter rule.

- `'unit'` is the number of 'days,' 'years,' 'months,' or 'weeks' option used to filter messages based on the sender maturity.
- `'operator'` are the following comparison operators used to filter messages based on the sender maturity:
  - `->` (Greater than)
  - `->=` (Greater than or equal to)
  - `-<` (Lesser than)
  - `-<=` (Lesser than or equal to)
  - `-==` (Equal to)
  - `-!=` (Not equal to)
  - `- Unknown`
- `'actual value'` is the number used to filter messages based on the sender maturity.

### Examples

In the following message, if the maturity of the sender domain is unknown, the message is dropped.

```
Drop_Messages_Based_On_SDR_Maturity: if (sdr-maturity ("unknown", "")) {drop();}
```

In the following message, if the maturity of the sender domain is less than one month, the message is dropped.

```
Drop_Messages_Based_On_SDR_Maturity: if (sdr-maturity ("months", <, 1, "")) { drop(); }
```

### Filtering Messages based on Sender Domain Unscannable

#### Syntax:

```
<msg_filter_name>
if sdr-unscannable (<'domain_exception_list'>)
{<action>}
```

#### Where:

- `'sdr-unscannable'` is the Domain Reputation message filter rule.
- `'domain_exception_list'` is the name of a domain exception list. If a domain exception list is not present it is displayed as "".

#### Example

In the following message, if the message failed the SDR check, the message is quarantined.

```
Quarantine_Messages_Based_On_Sender_Domain_Unscannable: if (sdr-unscannable (""))
{quarantine("Policy");}
```

# Filtering Messages based on Sender Domain Reputation using Content Filter

## Before you begin

- (Optional) Create an address list that contains only domains. To create one, go to *Mail Policies > Address Lists* page in the web interface or use the `addresslistconfig` command in the CLI. For more information, see [Mail Policies, on page 255](#).
- (Optional) Create a Domain Exception List. For more information, see [Creating Domain Exception List, on page 323](#).

## Procedure

---

- Step 1** Go to **Mail Policies > Incoming Content Filters**.
- Step 2** Click **Add Filter**.
- Step 3** Enter a name and description for the content filter.
- Step 4** Click **Add Condition**.
- Step 5** Click **Domain Reputation**.
- Step 6** Choose any one of the following conditions to filter messages based on SDR:
- Select **Sender Domain Reputation Verdict** to choose a verdict range to filter messages based on the verdict received from the SDR service.  
**Note** The recommended blocking threshold is "Untrusted." For more information about SDR Verdicts, see [SDR Verdicts, on page 316](#).
  - Select **Sender Maturity**, choose the comparison operator, enter a number, and choose the time period to filter messages based on the maturity of the sender domain.  
**Note** The Sender Domain Age option is replaced with Sender Maturity from AsyncOS 14.2.x release onwards. Sender Maturity is already incorporated into the SDR verdict. It is generally not recommended to filter messages based on Sender Maturity, except for special use-cases. Sender Maturity is set to a limit of 30 days, and beyond this limit, a domain is considered mature as an email sender, and no further details are provided.
  - Select **Sender Domain Reputation Unscannable** to filter messages that failed the SDR check.
- Step 7** (Optional) Select the list of allow listed domains that you do not want the email gateway to filter messages based on SDR.
- Step 8** Click **Add Action** to configure an appropriate action to take on messages based on SDR.
- Step 9** Submit and commit your changes.
- 

## Creating Domain Exception List

A domain exception list consists of a list of addresses that contain only domains. You can use a domain exception list to skip the SDR check for all incoming messages, irrespective of the mail policies configured on your Cisco Email Security Gateway.



---

**Note** If you want to skip SDR content filter actions on incoming messages for specific mail policies, you need to select the domain exception list in the Domain Reputation content filter.

---

### Criteria for using Domain Exception List

By default, to skip the SDR check, the domains in the `Envelope From:`, `From:`, and `Reply-To:` headers of the message must be the same and match the domain configured in the domain exception list. If you want to skip the SDR check based on the domain in the `Envelope From:` header only, select the 'Match Domain Exception List based on Domain in Envelope From:' option in the Domain Reputation settings page.

### Procedure

---

- Step 1** Go to **Security Services > Domain Reputation**.
  - Step 2** Click **Edit Settings** under Domain Exception List.
  - Step 3** Select the required address list that contains domains only.
  - Step 4** Submit and commit your changes.
- 

### What to do next

You can also create a Domain Exception List using the `domainrepconfig` command in the CLI. For more information, see the *CLI Reference Guide for AsyncOS for Cisco Email Security Appliances*.

## Attaching Content Filter to Incoming Mail Policy

You can attach the content filter that you configured to filter messages based on SDR to an incoming mail policy.

### Procedure

---

- Step 1** Go to **Mail Policies > Incoming Mail Policies**.
  - Step 2** Click the link below Content Filters.
  - Step 3** Make sure to select '**Enable Content Filters (Customize Settings)**'.
  - Step 4** Select the content filter that you created for filtering messages based on SDR.
  - Step 5** Submit and commit your changes.
- 

## Sender Domain Reputation Filtering and Clusters

If you use centralized management, you can enable SDR filtering and mail policies at the cluster, group, and machine level.

# Displaying Sender Domain Reputation Details in Message Tracking

You can use Message Tracking to view the message details based on SDR.

## Before you begin

- Make sure that you enable the Message Tracking feature on the email gateway. To enable Message Tracking, go to **Security Services > Message Tracking** page in the web interface.



**Note** You can track messages based on SDR verdicts even when you do not configure SDR-based content or message filters in your email gateway.

## Procedure

- Step 1** Go to **Monitor > Message Tracking**.
- Step 2** Click **Advanced**.
- Step 3** Check **Sender Domain Reputation** under Message Event.
- Step 4** Select the required SDR verdict(s) to view messages based on the verdict received from the SDR service.
- Step 5** (Optional) Check **Unscannable** to view messages when the SDR check failed.
- Step 6** (Optional) Select the required SDR threat categories to view messages based on the threat category.
- Step 7** Click **Search**.

## Viewing Alerts

The following table lists the system alert generated for SDR, including a description of the alert and the alert severity.

Component/Alert Name	Message and Description	Parameters
MAIL.IMH.SENDER_DOMAIN_LOOKUP_FAILURE_ALERTS	The SDR lookup failed. Reason - <\$reason>  Warning. Sent when a SDR query fails.	'reason' - The reason why the SDR query failed.

## Viewing Logs

The SDR filtering information is posted to the Mail Logs. Most information is at the Info or Debug level.

## Examples of SDR Filtering Log Entries

The SDR filtering information is posted to the Mail Logs. Most information is at the Info or Debug level.

- [Sender Domain Reputation Request Timeout, on page 326](#)
- [Sender Domain Reputation General Errors, on page 326](#)

### Sender Domain Reputation Request Timeout

In this example, the log shows a message that was not filtered based on SDR because of a request timeout error when communicating with the SDR service.

```
Mon Jul 2 09:00:13 2018 Info: New SMTP ICID 4 interface Management (192.0.2.10) address
224.0.0.10 reverse dns host unknown verified no
Mon Jul 2 09:00:13 2018 Info: ICID 4 ACCEPT SG UNKNOWNLIST match ipr[none] ipr not enabled
country not enabled
Mon Jul 2 09:00:13 2018 Info: Start MID 4 ICID 4
Mon Jul 2 09:00:13 2018 Info: MID 4 ICID 4 From: <sender1@example.com>
Mon Jul 2 09:00:13 2018 Info: MID 4 ICID 4 RID 0 To: <recipient1@example.com >
Mon Jul 2 09:00:13 2018 Info: MID 4 Message-ID '<000001cba32e5f24ff2e05d6efd8a05@com>'
Mon Jul 2 09:00:13 2018 Info: MID 4 Subject 'Message 001'
Mon Jul 2 09:00:13 2018 Info: MID 4 SDR: Message was not scanned for Sender Domain Reputation.
Reason: Request timed out.
```

#### Solution

When an SDR request times out, the message is marked as unscannable, and the configured actions are applied to the message.

### Sender Domain Reputation General Errors

In this example, the log shows a message that was not filtered based on SDR because of an unknown error.

```
Mon Jul 2 09:00:13 2018 Info: New SMTP ICID 4 interface Management (192.0.2.10) address
224.0.0.10 reverse dns host unknown verified no
Mon Jul 2 09:00:13 2018 Info: ICID 4 ACCEPT SG UNKNOWNLIST match ipr[none] ipr not enabled
country not enabled
Mon Jul 2 09:00:13 2018 Info: Start MID 4 ICID 4
Mon Jul 2 09:00:13 2018 Info: MID 4 ICID 4 From: <sender1@example.com >
Mon Jul 2 09:00:13 2018 Info: MID 4 ICID 4 RID 0 To: <recipient1@example.com >
Mon Jul 2 09:00:13 2018 Info: MID 4 Message-ID '<000001cba32e5f24ff2e05d6efd8a05@com>'
Mon Jul 2 09:00:13 2018 Info: MID 4 Subject 'Test mail'
Mon Jul 2 09:00:13 2018 Info: MID 4 SDR: Message was not scanned for Sender Domain Reputation.
Reason: Unknown error.
```

#### Solution

When an unknown error occurs, the message is marked as unscannable, and the configured actions are applied to the message.



## CHAPTER 14

# Integrating with Cisco SecureX Threat Response

This chapter contains the following sections:

- [Integrating your Email Gateway with Cisco SecureX Threat Response, on page 327](#)
- [How to Integrate your Email Gateway with Cisco SecureX Threat Response, on page 328](#)
- [Reregistering Email Gateway with Cisco Cloud Services Portal, on page 332](#)
- [Performing Threat Analysis using Cisco SecureX Ribbon, on page 333](#)
- [Performing Remedial Actions on Messages in Cisco SecureX Threat Response, on page 336](#)
- [Improving User Experience of Email Gateway using Cisco Success Network, on page 337](#)

## Integrating your Email Gateway with Cisco SecureX Threat Response

Cisco SecureX is a security platform embedded with every Cisco security product. It is cloud-native with no new technology to deploy. Cisco SecureX simplifies the demands of threat protection by providing a platform that unifies visibility, enables automation, and strengthens your security across network, endpoints, cloud, and applications. By connecting technology in an integrated platform, Cisco SecureX delivers measurable insights, desirable outcomes, and unparalleled cross-team collaboration. Cisco SecureX enables you to expand your capabilities by connecting your security infrastructure.

Integrating the Email Gateway with Cisco SecureX Threat Response contains the following sections:

- [How to Integrate your Email Gateway with Cisco SecureX Threat Response, on page 328](#)
- [Performing Threat Analysis using Cisco SecureX Ribbon, on page 333](#)

You can integrate your email gateway with Cisco SecureX Threat Response, and perform the following actions in Cisco SecureX Threat Response:

- View and send the email data from multiple email gateways in your organization.
- Identify, investigate and remediate threats observed in the email reports, sender and target relationships, search for multiple email addresses and subject lines and message tracking.
- Block compromised users or users violating outgoing email policies.
- Resolve the identified threats rapidly and provide recommended actions to take against the identified threats.

- Document the threats to save the investigation and enable collaboration of information among other devices.
- Block malicious domains, track suspicious observances, initiate an approval workflow or to create an IT ticket to update email policy.

You can access Cisco SecureX Threat Response using the following URL:

<https://securex.us.security.cisco.com/login>

Cisco Secure Email Gateway provides advanced threat protection capabilities to detect, block, and remediate threats faster, prevent data loss, and secure important information in transit with end-to-end encryption. For more information on observables that can be enriched by the ESA module, go to

<https://securex.us.security.cisco.com/settings/modules/available>, navigate to the module to integrate with Cisco SecureX and click **Learn More**.

## How to Integrate your Email Gateway with Cisco SecureX Threat Response

*Table 36: How to Integrate your Email Gateway with Cisco SecureX Threat Response*

	Do This	More Info
Step 1	Review the prerequisites.	<a href="#">Prerequisites, on page 329</a>
Step 2	<p>[Applicable only for users using the Classic Licensing mode].</p> <p><b>Note</b> If you are using the Smart Licensing mode [token registration only and not Specific or Permanent License Reservation (SLR or PLR)], you can skip this step because Cisco Cloud Services Portal is automatically enabled on your email gateway.</p> <p>Enable the Cisco Cloud Services portal on your email gateway.</p>	<a href="#">Enabling Cisco Cloud Services Portal on Email Gateway, on page 330</a>
Step 3	On Cisco SecureX, add your email gateway as a device, register it, and generate a registration token.	For more information, go to <a href="https://securex.us.security.cisco.com/help/settings-devices">https://securex.us.security.cisco.com/help/settings-devices</a>



	Do This	More Info
Step 4	<p>[Applicable only for users using the Classic Licensing mode].</p> <p><b>Note</b> If you are using the Smart Licensing mode, you can skip this step because your email gateway is automatically registered with Cisco Cloud Services Portal.</p> <p>Register your email gateway with the Cisco Cloud Services portal.</p>	<a href="#">Registering Email Gateway with Cisco Cloud Services Portal, on page 331</a>
Step 5	Confirm whether the registration was successful.	<a href="#">Confirm Whether the Registration was Successful, on page 331</a>
Step 6	Enable Cisco SecureX Threat Response on your email gateway	<a href="#">Enabling Cisco SecureX Threat Response on Email Gateway, on page 331</a>
Step 7	On Cisco SecureX, add Cisco Secure Email Gateway Module.	For more information, go to <a href="https://securex.us.security.cisco.com/settings/modules/available">https://securex.us.security.cisco.com/settings/modules/available</a> , navigate to the required Cisco Secure Email Gateway module to integrate with Cisco SecureX, click <b>Add New Module</b> , and see the instructions on the page.

## Prerequisites



- Note** If you already have a Cisco Threat Response user account, you do not need to create a Cisco SecureX user account. You can log in to Cisco SecureX using your Cisco Threat Response user account credentials.
- Make sure that you create a user account in Cisco SecureX with admin access rights. To create a new user account, go to **Cisco SecureX login** page using the URL <https://securex.us.security.cisco.com/login> and click **Create a SecureX Sign-on Account** in the login page. If you are unable to create a new user account, contact Cisco TAC for assistance.
  - Ensure that the configured DNS server can resolve the hostname you specified for accessing the email gateway.
  - [Only if you are not using a proxy server .] Make sure that you open HTTPS (In and Out) 443 port on the firewall for the following FQDNs to register your email gateway with Cisco SecureX Threat Response:
    - [api-sse.cisco.com](https://api-sse.cisco.com) (applicable for NAM users only)
    - [api.eu.sse.itd.cisco.com](https://api.eu.sse.itd.cisco.com) (applicable for European Union (EU) users only)
    - [api.apj.sse.itd.cisco.com](https://api.apj.sse.itd.cisco.com) (applicable for APJC users only)

- est.sco.cisco.com (applicable for APJC, EU, and NAM users)

For more information, see [Firewall Information, on page 1331](#).

- [For users with smart licensing registered on the email gateway] Make sure you have already linked your smart account (created in Cisco Smart Software Manager portal) to Cisco Security Services Exchange. For more information, see the following documentation at:
  - [Applicable for NAM users] [https://admin.sse.itd.cisco.com/assets/static/online-help/index.html#!t\\_link\\_accounts.html](https://admin.sse.itd.cisco.com/assets/static/online-help/index.html#!t_link_accounts.html)
  - [Applicable for European Union (EU) users] [https://admin.eu.sse.itd.cisco.com/assets/static/online-help/index.html#!t\\_link\\_accounts.html](https://admin.eu.sse.itd.cisco.com/assets/static/online-help/index.html#!t_link_accounts.html)
  - [Applicable for APJC users] [https://admin.apj.sse.itd.cisco.com/assets/static/online-help/index.html#!t\\_link\\_accounts.html](https://admin.apj.sse.itd.cisco.com/assets/static/online-help/index.html#!t_link_accounts.html)

## Enabling Cisco Cloud Services Portal on Email Gateway

### Procedure

- 
- Step 1** Log in to your email gateway.
  - Step 2** Select **Networks > Cloud Service Settings**.
  - Step 3** Click **Enable**.
  - Step 4** Check the **Enable Cisco Cloud Services** check box.
  - Step 5** Choose the required Cisco Secure server to connect your email gateway to the Cisco Cloud Services portal.
  - Step 6** Submit and commit your changes.
  - Step 7** Wait for few minutes, and check whether the **Register** button appears on the Cloud Services Settings page.
- 

In a clustered configuration, you can only register your logged-in email gateway with the Cisco Cloud Services portal in the machine mode. If you have already registered your email gateway with the Cisco Cloud Services portal in the standalone mode, make sure to deregister the email gateway manually before you join it to a cluster.



---

**Note** To enable Cisco Cloud Services portal using the CLI, use the `cloudserviceconfig` command.

---

### What to do next

Register your email gateway with the Cisco Cloud Services portal. For more information, go to <https://securex.us.security.cisco.com/settings/modules/available>, navigate to the module to integrate with Cisco SecureX, click **Add New Module**, and see the instructions on the page.

## Registering Email Gateway with Cisco Cloud Services Portal

### Procedure

---

- Step 1** Go to **Networks > Cloud Service Settings**.
- Step 2** Enter the registration token under Cloud Services Settings and click **Register**.
- 



**Note** To register your email gateway with or the Cisco Cloud Services portal using the CLI, use the `cloudserviceconfig` command.

---

### What to do next

[Confirm Whether the Registration was Successful, on page 331](#)

## Confirm Whether the Registration was Successful

- On Security Services Exchange, confirm successful registration by reviewing the status in Security Services Exchange.
- On Cisco SecureX, navigate to the **Devices** page and view the ESA that has been registered with Security Services Exchange.



**Note** If you want to switch to another Cisco SecureX Threat Response server (for example, 'Europe - api.eu.sse.itd.cisco.com'), you must first deregister your email gateway from Cisco SecureX Threat Response and follow steps mentioned in [How to Integrate your Email Gateway with Cisco SecureX Threat Response, on page 328](#).

After you have integrated your email gateway with Cisco SecureX Threat Response, you do not need to integrate your Cisco Secure Manager Email and Web Gateway with Cisco SecureX Threat Response.

After successful registration of your email gateway on Security Services Exchange, add the ESA Email module on Cisco SecureX. For more information, go to <https://securex.us.security.cisco.com/settings/modules/available>, navigate to the module to integrate with Cisco SecureX, click **Add New Module**, and see the instructions on the page.

---

## Enabling Cisco SecureX Threat Response on Email Gateway

### Procedure

---

- Step 1** Log in to your email gateway.
- Step 2** Select **Networks > Cloud Service Settings**.

- Step 3** Check the **Enable** check box under SecureX.
- Step 4** Submit and commit your changes.

## Reregistering Email Gateway with Cisco Cloud Services Portal

You can reregister your email gateway with the Cisco Cloud Services portal based on any one of the following scenarios:

- If you are unable to view or manage the devices (email gateways) added to the Cisco Cloud Services portal when you automatically register your email gateway with the Cisco Cloud Services portal.
- If your Smart Account and Cisco Cloud Services Account are not linked when you automatically register your email gateway with the Cisco Cloud Services portal.

You can also use the `cloudserviceconfig > reregister` sub command in the CLI to reregister your email gateway with the Cisco Cloud Services portal.

### Before you begin

Make sure you have met the following prerequisites:

- Enabled Smart Software Licensing on your email gateway.
- Registered your email gateway with Cisco Smart Software Manager.

### Procedure

- Step 1** Go to **Networks > Cloud Service Settings** page on your email gateway.
- Step 2** Click **Reregister**.
- Note** After you click Reregister, you can choose whether you want to perform the task in either steps 3 or 4 or both depending on your requirement.
- Step 3** [Optional] Choose the appropriate Cisco Secure server to connect your email gateway to the Cisco Cloud Services portal if your email gateway was automatically registered with an incorrect Cisco Secure server.
- Step 4** [Optional] Enter the registration token obtained from the Cisco Cloud Services portal, if your email gateway was automatically registered with an incorrect Smart Account.
- Step 5** Click **Submit**, the ‘Confirm reregistration’ dialog box appears only if you do not enter a registration token in step 4.
- Step 6** Click **Submit** in the ‘Confirm reregistration’ dialog box to allow Cisco Cloud Services to use the token auto-generated from the Cisco Cloud Services portal with the Smart Account information to reregister your email gateway with the Cisco Cloud Services portal

# Performing Threat Analysis using Cisco SecureX Ribbon



---

**Note** When you upgrade from Cisco Secure Email Gateway 13.5.1 or earlier versions, **Casebook** will be part of the Cisco SecureX Ribbon.

---

Cisco SecureX supports a distributed set of capabilities that unify visibility, enable automation, accelerate incident response workflows, and improve threat hunting. These distributed capabilities are presented in the form of applications (apps) and tools in the Cisco SecureX Ribbon.

This topic contains the following sections:

- [Accessing the Cisco SecureX Ribbon, on page 333](#)
- [Adding Observable to Casebook for Threat Analysis using Cisco SecureX Ribbon and Pivot Menu, on page 335](#)

You will find the Cisco SecureX Ribbon at the bottom pane of the page, and it persists as you move between the dashboard and other security products in your environment. Cisco SecureX Ribbon consists of the following icons and elements:

- Expand/Collapse Ribbon
- Home
- Casebook App
- Incidents App
- Orbital App
- Enrichment Search Box
- Find Observables
- Settings

For more information on Cisco SecureX Ribbon, see <https://securex.us.security.cisco.com/help/ribbon>.

## Accessing the Cisco SecureX Ribbon

### Before you begin

Make sure that you meet all the prerequisites that are mentioned in [Prerequisites, on page 329](#).



---

**Note** Suppose you have already configured **Casebook** for Cisco Secure Email Gateway 13.5.1 or earlier versions. You need to create a new **Client ID** and **Client Secret** in Cisco SecureX API client with additional scopes, as mentioned in the following procedure.

---



You can drag the Cisco SecureX Ribbon, positioned at the bottom pane of the page, from right using button.

### Procedure

---

- Step 1** Log in to the new web interface of your email gateway. For more information, see [Accessing the Web-Based Graphical User Interface \(GUI\), on page 26](#).
- Step 2** Click the Cisco SecureX Ribbon.
- Step 3** Create a **Client ID** and **Client Secret** in **SecureX API Clients**. For more information to generate API Client credentials, see [Creating an API Client](#).

While creating a client ID and client password, make sure that you choose the following scopes:

- casebook
- enrich:read
- global-intel:read
- inspect:read
- integration:read
- profile
- private-intel
- response
- registry/user/ribbon
- telemetry:write
- users:read
- orbital (if you have access)

- Step 4** Enter the client ID and client password obtained in step 3 in the **Login to use SecureX Ribbon** dialog box in your email gateway.
- Step 5** Select the required Cisco SecureX server in the **Login to use SecureX Ribbon** dialog box.
- Step 6** Click **Authenticate**.

**Note** If you want to edit the client ID, client password, and Cisco SecureX server, right-click on the Cisco SecureX Ribbon, and add the details.

---

### What to do next

[Adding Observable to Casebook for Threat Analysis using Cisco SecureX Ribbon and Pivot Menu, on page 335](#)

# Adding Observable to Casebook for Threat Analysis using Cisco SecureX Ribbon and Pivot Menu

## Before you begin

Make sure that you obtain the client ID and client password to access the Cisco SecureX Ribbon and pivot menu widgets on your email gateway. For more information, see [Accessing the Cisco SecureX Ribbon, on page 333](#).



## Procedure

**Step 1** Log in to the new web interface of your email gateway. For more information, see [Accessing the Web-Based Graphical User Interface \(GUI\), on page 26](#).

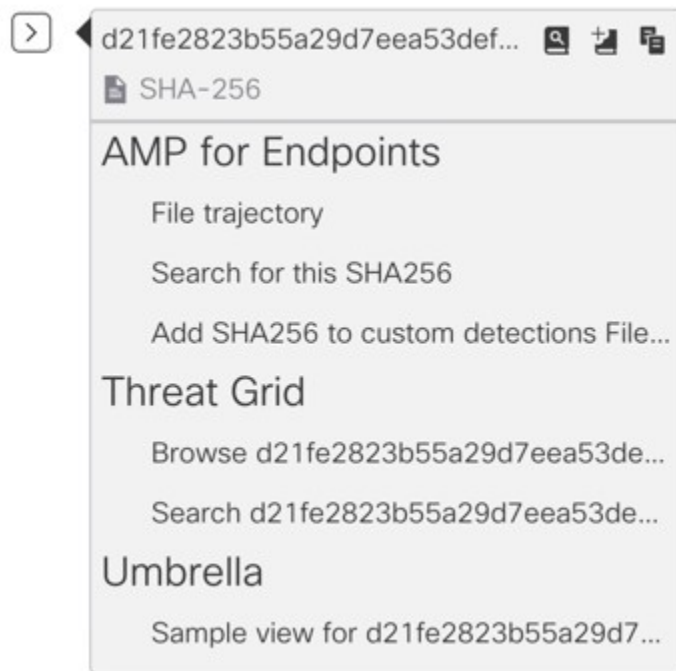
**Step 2** Navigate to the **Email Reporting** page, click the pivot menu  button next to the required observable (for example, bit.ly).





Perform the following:

- Click  button to add an observable to active case.
- Click  button to add the observable to new case.

## Note

Use the pivot menu  button to pivot an observable to other devices registered on the portal (for example, AMP for Endpoints) to investigate for threat analysis.

**Step 3** Hover over  icon and click  button to open the **Casebook**. Check whether the observable is added to a new or an existing case.

**Step 4** (Optional) Click  button to add a title, description, or notes to the **Casebook**.



**Note** You can search for observables for threat analysis in two different ways:

- Click the **Enrichment**  search box from the Cisco SecureX Ribbon and search for the observables.
- Click the **Casebook** icon inside the Cisco SecureX Ribbon and search for the observables in the search

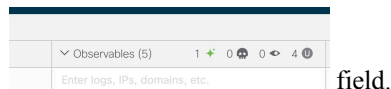

field.

For more information on Cisco SecureX Ribbon, see <https://securex.us.security.cisco.com/help/ribbon>.

## Performing Remedial Actions on Messages in Cisco SecureX Threat Response

In Cisco SecureX Threat Response, you can now investigate and apply the following remedial actions on messages processed by your email gateway:

- Delete
- Forward
- Forward and Delete

### Before you begin

Make sure you have met the following prerequisites before you perform remedial actions on messages in Cisco SecureX Threat Response:

- Enabled and registered your email gateway with the Cisco SecureX server. For more information, see [How to Integrate your Email Gateway with Cisco SecureX Threat Response, on page 328](#).
- Added your email gateway module to Cisco SecureX and specified the Remediation Forwarding Address in Cisco SecureX. For more information, go to <https://securex.us.security.cisco.com/settings/modules/available>, navigate to the required Cisco Secure Email Gateway module to integrate with Cisco SecureX, click Add New Module, and see the instructions on the page.
- Enabled and configured the remediation profiles in the System Administration > Account Settings page in your email gateway. For more information, see [Remediating Messages in Mailboxes, on page 573](#).



## Procedure

- 
- Step 1** Log in to Cisco SecureX with your user credentials.
- Step 2** Perform an investigation for threat analysis by entering required IOCs (for example, URLs, Email MessageID, and so on) in the Investigate panel and click **Investigate**. For more information, see the Investigate topic in the Help section at <https://visibility.amp.cisco.com/help/investigate>.
- Step 3** Select the required message based on the investigation results using the corresponding **Cisco Message ID** or **Email MessageID**. For more information, see the Investigate topic in the Help section at <https://visibility.amp.cisco.com/help/investigate>.
- Step 4** Click the pivot menu  button next to the Cisco Message ID or Email MessageID and select the required remedial action (for example, 'Forward'). For more information, see the Investigate topic in the Help section at <https://visibility.amp.cisco.com/help/investigate>
- 

# Improving User Experience of Email Gateway using Cisco Success Network

## Overview

You can use the Cisco Success Network (CSN) feature to send your email gateway and feature usage details to Cisco. These details are used by Cisco to identify the email gateway version and the features activated but not enabled on your email gateway.

The ability to send your email gateway and feature usage details to Cisco helps an organization to:

- Improve the effectiveness of the product in user networks by performing analytics on collected telemetry data and suggesting users with recommendations using a digital campaign.
- Improve user experience with email gateway.

The following table shows a sample data of email gateway and feature usage details sent to Cisco:

Statistics	Sample Data
<b>Email Gateway Details</b>	
UID	4215XXXXXXXXXXXXXXXXXX-XXXXXXXXXXXX
Model	C100V
sIVAN	Email Gateway (for a smart license) or null (for a classic license)
Deployment	Cluster/Standalone.
userAccountID	Enter SLPIID (in smart license) or VLNID (in classic license).
Version	1X.X.X-XXX

Statistics	Sample Data
Install Date	1582535814000 (milli-seconds since epoch)
Feature Information	
Name	Email Gateway Feature
Enabled	Yes
Status	In Compliance
Expiry Date	1831591683 (seconds since epoch)
Feature ID	a4deXXXX-XXXX-XXXX-XXXX-XXXXXXXXXXXXXX

**Related Topics**

- [Enabling CSN on Email Gateway, on page 338](#)
- [Disabling CSN on Email Gateway, on page 338](#)

## Enabling CSN on Email Gateway

**Before you begin**

Make sure that you enable and register your email gateway with the Cisco Cloud Service Portal. For more information, see [How to Integrate your Email Gateway with Cisco SecureX Threat Response, on page 328](#).

**Procedure**

- 
- Step 1** Go to **Security Services > Cloud Service Settings**.
  - Step 2** Click **Edit Global Settings**.
  - Step 3** Check the **Enable** checkbox under Cisco Success Network.
  - Step 4** Submit and commit your changes.
- 

## Disabling CSN on Email Gateway

**Procedure**

- 
- Step 1** Go to **Security Services > Cloud Service Settings**.
  - Step 2** Click **Edit Global Settings**.
  - Step 3** Uncheck the the **Enable** checkbox under Cisco Success Network.

**Step 4** Submit and commit your changes.

---





## CHAPTER 15

# Configuring Email Gateway to Safe Print Message Attachments

---

This chapter contains the following sections:

- [Overview](#) , on page 341
- [How to Configure Email Gateway to Safe Print Message Attachments](#), on page 342
- [Configuring Safe Print Settings on Email Gateway](#), on page 342
- [Configuring Content Filter to Safe Print Message Attachments](#), on page 343
- [Attaching Content Filter to Incoming Mail Policy](#), on page 345
- [Safe Print Settings and Clusters](#), on page 346
- [Monitoring Messages with Safe-Printed Attachments](#), on page 346
- [Viewing Logs](#), on page 346
- [Displaying Safe Print Details in Message Tracking](#), on page 347

## Overview

You can configure your email gateway to provide a safe view (safe-printed PDF version) of a message attachment detected as malicious or suspicious. The safe view of the message attachment is delivered to the end user and the original attachment is stripped from the message. You can use the 'Safe Print' content filter action to safe print all message attachments that match a configured content filter condition.

The ability to safe print message attachments in the email gateway helps an organization to:

- Prevent message attachments with malicious or suspicious content from entering an organization network.
- View malicious or suspicious message attachments without being affected by the malware.
- Deliver the original message attachment based on the end-user request.

The following languages are supported for the Safe-Print feature - English, Italian, Portuguese, Spanish, German, French, Japanese, Chinese (PRC and Taiwan), Russian, and Korean.

# How to Configure Email Gateway to Safe Print Message Attachments

Steps	Do This	More Information
Step 1	Configure safe print settings on the email gateway.	<a href="#">Configuring Safe Print Settings on Email Gateway, on page 342</a>
Step 2	Configure a content filter to safe print message attachments.	<a href="#">Configuring Content Filter to Safe Print Message Attachments, on page 343</a>
Step 3	Attach the content filter that you configured to safe print message attachments to an incoming mail policy.	<a href="#">Attaching Content Filter to Incoming Mail Policy, on page 345</a>

## Configuring Safe Print Settings on Email Gateway

### Procedure

- Step 1** Click **Security Services > Scan Behavior**.
- Step 2** Click **Edit Global Settings**.
- Step 3** Enter the required parameters described in the following table to configure safe print settings on the email gateway.

Parameter Source Details	Description
<b>Safe Print Settings</b>	
Maximum File Size	<p>Enter the maximum attachment size for a safe-printed attachment.</p> <p><b>Note</b> Make sure that the 'Maximum File Size' value does not exceed the 'Maximum attachment size to scan' value configured in the Scan Behavior &gt; Global Settings page.</p> <p><b>Note</b> If the 'Maximum File Size' value exceeds the 'Maximum Message Size to Scan' value configured for Outbreak Filters on your email gateway, then the message and the message attachment is not scanned by Outbreak Filters in the email pipeline.</p>
Maximum Page Count	Enter the maximum number of pages that you want to safe print in a message attachment.

Parameter Source Details	Description
Document Quality	Select the <b>Use Default Value (70)</b> option to use the recommended image quality value for a safe-printed attachment.  <b>Note</b> You can also select the <b>Enter Custom Value</b> option and enter a custom image quantity value for a safe-printed attachment.
File Type Selection	Select the required file types from the appropriate file groups (for example, "Microsoft Documents") that you can use to safe print a message attachment.
Watermark	Select <b>Enabled</b> option to add a watermark to a safe-printed attachment.  <b>Note</b> You can enter a custom text for the watermark in the <b>Enter Custom Text:</b> field.
Cover Page	Select <b>Enabled</b> option to add a cover page to a safe-printed attachment.  <b>Note</b> You can enter a custom text for the cover page in the <b>Enter Custom Text</b> field.

**Step 4** Submit and commit your changes.

#### What to do next

Configure a content filter to safe print a message attachment. For more information, see [Configuring Content Filter to Safe Print Message Attachments, on page 343](#).

## Configuring Content Filter to Safe Print Message Attachments

Use the 'Safe Print' content filter action to safe print a message attachment

You can use the Safe Print content filter action in any one of the following ways::

- Safe print matching attachments option
- Safe print all attachments option

Table 37:

Safe Print Action Option	Usage	Example	Supported Content Filter Conditions
Safe print matching attachments	Use the 'Safe print matching attachments' option to safe print all message attachments that match a configured content filter condition.	<p>Configure the 'Macro Detection' content filter condition and select the 'Safe Print Matching Attachments' option.</p> <p>If an incoming message contains three message attachments - 'docx1,' 'docx2,' and 'docx3' and the email gateway detects a macro in 'docx1,' then only 'docx1' is safe-printed.</p>	<p>The following are the content filter conditions that you can only use with the 'Safe print matching attachments' option:</p> <ul style="list-style-type: none"> <li>• URL Reputation</li> <li>• URL Category</li> <li>• Macro Detection</li> <li>• Attachment Content</li> <li>• Attachment File Info</li> </ul>
Safe print all attachments	Use the 'Safe print all attachments' option to safe print all message attachments when the configured content filter condition is true.	<p>Configure the 'Envelope Sender' content filter condition and select the 'Safe Print all attachments' option.</p> <p>If an incoming message from a sender 'user1@example.com' contains three message attachments - 'docx1,' 'docx2,' and 'ppt1' then all the message attachments - 'docx1,' 'docx2,' and 'ppt1' are safe-printed based on the following:</p> <ul style="list-style-type: none"> <li>• File types selected in the <b>Scan Behavior &gt; Safe Print Settings</b> page.</li> <li>• The user1@example.com sender matches the LDAP group directory configured in the 'Envelope Sender' content filter condition.</li> </ul>	<p>You can use any one of the content filter conditions available in your email gateway with the 'Safe print all attachments' option.</p>

As an example, use the following procedure to safe print message attachments that contain macros using the 'Macro Detection' condition and 'Safe Print' action.



### Before you begin

Make sure that you have configured safe print settings on the email gateway. See [Configuring Safe Print Settings on Email Gateway, on page 342](#)

### Procedure

---

- Step 1** Go to **Mail Policies > Incoming Content Filters**.
- Step 2** Click **Add Filter**.
- Step 3** Enter a name and description for the content filter.
- Step 4** Click **Add Condition**.
- Step 5** Click **Macro Detection**.
- Step 6** Select the file types that you want the email gateway to detect for macros and click **Add**.
- Step 7** Click **OK**.
- Step 8** Click **Add Action**.
- Step 9** Click **Safe Print**.
- Step 10** Select any one of the following actions to take on message attachments:
- Select **Safe print matching attachments** option to safe print all message attachments that match the configured Macro Detection content filter condition.
  - Select **Safe print all attachments** option to safe print all message attachments when the configured Macro Detection content filter condition is true
- Step 11** Select **Yes** to strip a message attachment that is marked as unscannable.
- A message attachment is marked as unscannable due to any one of the following reasons:
- Message contains an attachment that is encrypted.
  - Message contains an attachment that is corrupt.
  - I/O error occurs when performing a safe print action on the message attachment.
  - Timeout error occurs when performing a safe print action on the message attachment.
- Note** By default, a system generated message is added as an attachment text file when an attachment is unscannable. You can enter a custom message in the **Custom Replacement Message** field.
- Step 12** Click **OK**.
- Step 13** Submit and commit your changes.
- 

## Attaching Content Filter to Incoming Mail Policy

You can attach the content filter that you configured to safe print a message attachment to an incoming mail policy.

### Procedure

---

- Step 1** Go to **Mail Policies > Incoming Mail Policies**.
  - Step 2** Click the link below Content Filters.
  - Step 3** Make sure to select '**Enable Content Filters (Customize Settings)**.'
  - Step 4** Select the content filter that you created to safe print a message attachment.
  - Step 5** Submit and commit your changes.
- 

## Safe Print Settings and Clusters

If you use centralized management, you can configure safe print settings on the email gateway and mail policies at the cluster, group, and machine level.

## Monitoring Messages with Safe-Printed Attachments

You can use the Safe Print report page to view:

- Number of safe-printed attachments based on the file type in graphical format.
- Summary of safe-printed attachments based on the file type in tabular format.

In the 'Summary of Safe Print File Types' section, click the total number of safe-printed attachments to view the message details in Message Tracking.

## Viewing Logs

The log information about safe print is posted to the Mail Logs. Most information is at the Info or Debug level.

## Examples of Safe Print Log Entries

The safe print information is posted to the Mail Logs. Most information is at the Info or Debug level.

- I/O Errors
  - [Unable to Create Temporary Directory, on page 347](#)
  - [Unable to Create Safe-printed PDF Attachment, on page 347](#)
- [Corrupt File, on page 347](#)
- [Encrypted File, on page 347](#)
- [Timeout Error, on page 347](#)

## Unable to Create Temporary Directory

In this example, the log shows that a message attachment was not safe-printed because your email gateway was unable to create a temporary directory to save the file.

```
Sat Jul 20 05:53:48 2019 Info: MID 5 Unable to safe print the attachment,
Filename:test_file.docx, Reason: IO error occurred during safeprinting of the attachment
Sat Jul 20 05:53:48 2019 Trace: MID 5 Unable to safe print the attachment,
Filename:test_file.docx, Exception: Unable to create tmp directory for safeprinting document:
[Errno 2] No such file or directory: '/tmp/test_file.docx'
```

## Unable to Create Safe-printed PDF Attachment

In this example, the log shows that a message attachment was not safe-printed because your email gateway was unable to create a safe-printed PDF attachment.

```
Thu Jul 11 07:19:01 2019 Info: MID 132 Unable to safe print the attachment,
Filename:test_file.docx, Reason: IO error occurred during safeprinting of the attachment
Thu Jul 11 07:19:01 2019 Trace: MID 132 Unable to safe print the attachment,
Filename:test_file.docx, Exception: Error while creating safeprinted PDF document:
[Errno 2] No such file or directory: '/tmp/test_file.docx/safe_print_test_file.pdf'
```

## Corrupt File

In this example, the log shows that a message attachment was not safe-printed because the file was corrupt

```
Thu Jul 11 08:34:31 2019 Info: MID 142 Unable to safe print the attachment,
Filename:corrupt_file=20(1).docx, Reason: The attachment is corrupted
```

## Encrypted File

In this example, the log shows that a message attachment was not safe-printed because the file was encrypted.

```
Thu Jul 11 08:34:31 2019 Info: MID 142 Unable to safe print the attachment,
Filename:sept_subscription.pdf, Reason: The attachment is encrypted.
```

## Timeout Error

In this example, the log shows that a message attachment was not safe-printed because of a timeout error.

```
Thu Jul 11 10:32:29 2019 Info: MID 165 Unable to safe print the attachment,
Filename:20_page.docx, Reason: A timeout error occurred when trying to safe print the
attachment
```

# Displaying Safe Print Details in Message Tracking

Use Message Tracking to view the details of messages that contain safe-printed attachments.

### Before you begin

- Make sure that you enable the Message Tracking feature on the email gateway. To enable Message Tracking, go to **Security Services > Message Tracking** page in the legacy web interface of your email gateway.
- Content filters configured to safe print message attachments are operational.

## Procedure

---

- Step 1** [New Web Interface only] Go to **Tracking > Message Tracking**.  
OR  
[Legacy Web interface only] Go to **Monitor > Message Tracking**.
- Step 2** [New Web Interface] Click **Advanced Search**.  
OR  
[Legacy Web interface only] Click **Advanced**.
- Step 3** Check **Safe Print** under Message Event to view the details of messages that contain safe-printed attachments.
- Step 4** Enter the required search options and click **Search**.
-



## CHAPTER 16

# Integrating Email Gateway with Cisco Secure Awareness Cloud Service

---

This chapter contains the following sections:

- [Overview, on page 349](#)
- [How to Integrate Email Gateway with Cisco Secure Awareness Cloud Service, on page 350](#)
- [Creating Cisco Secure Awareness Cloud Service Account, on page 351](#)
- [Configuring Firewall Settings to Access Cisco Secure Awareness Cloud Service, on page 351](#)
- [Creating Sender Group to Allow Simulated Phishing Messages in Email Gateway, on page 352](#)
- [Obtaining Authentication Token from Cisco Secure Awareness Cloud Service, on page 353](#)
- [Enabling Cisco Secure Awareness Cloud Service on Email Gateway, on page 354](#)
- [Create Custom Incoming Mail Policy for End Users Categorized as Repeat Clickers, on page 355](#)
- [Cisco Secure Awareness Cloud Service and Clusters, on page 355](#)
- [Viewing Logs, on page 355](#)
- [Viewing Alerts, on page 357](#)

## Overview

The Cisco Secure Awareness cloud service allows you to effectively deploy phishing simulations, awareness training, or both to measure and report results. It empowers the security operations team to focus on real-time threats and not end-user mitigation.

The Cisco Secure Awareness cloud service provides reports of repeat clickers - users who repeatedly click on any URL or attachment in messages. These users are identified via a phishing simulation campaign defined by the Cisco Secure Awareness cloud service.

For more information on the Cisco Secure Awareness cloud service, see <https://secat.cisco.com>.

You can integrate your email gateway with the Cisco Secure Awareness cloud service to:

- Improve end-user awareness towards real-world phishing attacks.
- Allow email administrators to configure stringent policies for users identified as repeat clickers.

# How to Integrate Email Gateway with Cisco Secure Awareness Cloud Service

Perform these steps in order:

Steps	Do This	More Information
Step 1	[On Cisco Secure Awareness] Create a Cisco Security Awareness cloud service account for your organization based on your region.	<a href="#">Creating Cisco Secure Awareness Cloud Service Account, on page 351</a>
Step 2	Configure firewall settings to allow your email gateway to access the Cisco Secure Awareness cloud service.	<a href="#">Configuring Firewall Settings to Access Cisco Secure Awareness Cloud Service, on page 351</a>
Step 3	Create a new sender group to allow simulated phishing messages from the Cisco Secure Awareness cloud service in your email gateway.	<a href="#">Creating Sender Group to Allow Simulated Phishing Messages in Email Gateway, on page 352</a>
Step 4	[On Cisco Secure Awareness] Create a new user in the Cisco Secure Awareness cloud service to identify repeat clickers. :	See the CSA Administrator Guide at: <ul style="list-style-type: none"> <li>• <a href="https://secat.cisco.com/portal/Support">https://secat.cisco.com/portal/Support</a> [applicable for Americas users]</li> <li>• <a href="https://secat-eu.cisco.com/portal/Support">https://secat-eu.cisco.com/portal/Support</a> [applicable for European Union (EU) users]</li> </ul>
Step 5	[On Cisco Secure Awareness] Create simulated phishing messages in the Cisco Secure Awareness cloud service and send them to the end users in your organization. This process is used to track the end users who repeatedly click on any attachment or URL in messages.	See the CSA Administrator Guide at: <ul style="list-style-type: none"> <li>• <a href="https://secat.cisco.com/portal/Support">https://secat.cisco.com/portal/Support</a> [applicable for Americas users]</li> <li>• <a href="https://secat-eu.cisco.com/portal/Support">https://secat-eu.cisco.com/portal/Support</a> [applicable for European Union (EU) users]</li> </ul>
Step 6	Obtain the authentication token from the Cisco Secure Awareness cloud service.	<a href="#">Obtaining Authentication Token from Cisco Secure Awareness Cloud Service, on page 353</a>
Step 7	Enable the Cisco Secure Awareness cloud service on your email gateway.	<a href="#">Enabling Cisco Secure Awareness Cloud Service on Email Gateway, on page 354</a>

Steps	Do This	More Information
Step 8	Create a custom incoming mail policy to configure aggressive mail policies for end users categorized as repeat clickers.	<a href="#">Create Custom Incoming Mail Policy for End Users Categorized as Repeat Clickers, on page 355</a>

## Creating Cisco Secure Awareness Cloud Service Account

Depending on your region, create a Cisco Secure Awareness cloud service account with admin access rights for your organization using one of the following URLs:

- <https://secat.cisco.com> [applicable for Americas users]
- <https://secat-eu.cisco.com> [applicable for European Union (EU) users]

### What to do Next

Configure firewall settings to connect your email gateway to the Cisco Secure Awareness cloud service. For more information, see [Configuring Firewall Settings to Access Cisco Secure Awareness Cloud Service, on page 351](#)

## Configuring Firewall Settings to Access Cisco Secure Awareness Cloud Service

You must open HTTPS (Out) 443 port on the firewall for the following hostnames or IP addresses (refer to the table below) to connect your email gateway to the Cisco Secure Awareness cloud service.

Service	Americas		European Union	
	Hostname	IP Address	Hostname	IP Address
Cisco Secure Awareness cloud service	secat.cisco.com	52.242.31.199	secat-eu.cisco.com	40.127.163.97
Course Notification (Outbound)	-	167.89.98.161	-	40.127.163.97
Landing and Feedback Pages (Outbound)	-	52.242.31.199	-	
Email Attachment (Outbound)	-		-	



**Note** The IP addresses listed in the above table may change. For the latest list of IP addresses, see the ‘IP Allowlist Guide’ on the Cisco Secure Awareness cloud service at <https://secat.cisco.com/portal/Support/IpWhitelistingGuide>

#### What to do Next

Create a new sender group to allow simulated phishing messages from the Cisco Secure Awareness cloud service in your email gateway. For more information, see [Creating Sender Group to Allow Simulated Phishing Messages in Email Gateway, on page 352](#)

## Creating Sender Group to Allow Simulated Phishing Messages in Email Gateway

You must create a new sender group to allow simulated phishing messages from the Cisco Secure Awareness cloud service in your email gateway.

#### Before you begin

Make sure you have configured the firewall settings to allow your email gateway to access the Cisco Secure Awareness cloud service. For more information, see [Configuring Firewall Settings to Access Cisco Secure Awareness Cloud Service, on page 351](#)

#### Procedure

- 
- Step 1** Click **Mail Policies > HAT Overview**.
  - Step 2** Click **Add Sender Group**.
  - Step 3** Enter a name for the sender group.
  - Step 4** Select the priority order as **1**.
  - Step 5** Select the policy as **CYBERSEC\_AWARENESS\_ALLOWED**.
  - Step 6** Check the **SBRS to Not in Use** checkbox to disable IP Reputation filtering.
  - Step 7** Click **Submit and Add Senders**.
  - Step 8** Add any one of the following Cisco Secure Awareness cloud service IP addresses to configure as the sender IP address based on your region:
    - Americas - 207.200.3.14 or 173.244.184.143
    - European Union (EU) - 77.32.150.153
- Note** The Cisco Secure Awareness cloud service IP addresses are used to prevent your email gateway from interpreting simulated phishing messages as actual phish..
- Step 9** Submit and commit your changes.
-



**What to do next**

1. Create a new user in the Cisco Secure Awareness cloud service to identify repeat clickers.
2. Create simulated phishing messages in the Cisco Secure Awareness cloud service and send them to the end users in your organization.

For more information on how to complete the above two tasks, see the CSA Administrator Guide at:

- <https://secat.cisco.com/portal/Support> [applicable for Americas users]
- <https://secat-eu.cisco.com/portal/Support> [applicable for European Union (EU) users]

3. Obtain an authentication token from the Cisco Secure Awareness cloud service to download the Repeat Clickers list from the Cisco Secure Awareness cloud service. For more information, see [Obtaining Authentication Token from Cisco Secure Awareness Cloud Service, on page 353](#)

## Obtaining Authentication Token from Cisco Secure Awareness Cloud Service

You must obtain an authentication token from the Cisco Secure Awareness cloud service and use it to download the Repeat Clickers list from the Cisco Secure Awareness cloud service.

**Before you begin**

Make sure that you have an account in the Cisco Secure Awareness cloud service with admin access rights. For more information, see [Creating Cisco Secure Awareness Cloud Service Account, on page 351](#). If you are unable to access the Cisco Secure Awareness cloud service, contact Cisco Support for assistance.

**Procedure**

- 
- Step 1** Log in to the Cisco Secure Awareness cloud service.
  - Step 2** Go to **Environment > Settings**
  - Step 3** Click the **Report API** tab.
  - Step 4** Check the **Enable Report API** check box .
  - Step 5** Copy the authentication token.

Use this authentication token to download the Repeat Clickers list from the Cisco Secure Awareness cloud service.

---

**What to do next**

Enable the Cisco Secure Awareness cloud service on your email gateway. For more information, see [Enabling Cisco Secure Awareness Cloud Service on Email Gateway, on page 354](#)

# Enabling Cisco Secure Awareness Cloud Service on Email Gateway

## Before you begin

Make sure you have:

- A valid account in the Cisco Secure Awareness cloud service with admin access rights.
- Obtained a valid authentication token from the Cisco Secure Awareness cloud service. For more information, see [Obtaining Authentication Token from Cisco Secure Awareness Cloud Service, on page 353](#),

## Procedure

---

- Step 1** Go to **Security Services > Cisco Secure Awareness**.
  - Step 2** Click **Enable**.
  - Step 3** Check the **Enable Cisco Secure Awareness** check box .
  - Step 4** Choose the required server to connect your email gateway to the Cisco Secure Awareness cloud service.
  - Step 5** Enter the authentication token obtained from the Cisco Secure Awareness cloud service.
  - Step 6** [Optional] Enter the polling interval to download the Repeat Clickers list from the Cisco Secure Awareness cloud service.
  - Step 7** Submit and commit your changes.
- 

## What to do next

- After you enable the Cisco Secure Awareness cloud service, the email gateway automatically downloads the Repeat Clickers list from the Cisco Secure Awareness cloud service. You can view the number of repeat clicker users in the Repeat Clickers list by navigating to **Security Services > Cisco Secure Awareness > Repeat Clickers List Settings** section in the web interface of your email gateway. For more information about the Repeat Clickers list, log in to the Cisco Secure Awareness cloud service and navigate to **Analytics > Standard Reports > Phishing Simulations > Repeat Clickers** section.
- Create a custom incoming mail policy to configure aggressive mail policies for end users categorized as repeat clickers. For more information, see [Create Custom Incoming Mail Policy for End Users Categorized as Repeat Clickers, on page 355](#).
- Cisco Secure Email Submission Add-In now supports submission of simulated phishing messages sent through the Cisco Secure Awareness (CSA) cloud service portal. You can now submit the simulated phishing messages using the Secure Email Submission Add-In itself. For more details, see the [User Guide for Cisco Secure Email Submission Add-In](#).

# Create Custom Incoming Mail Policy for End Users Categorized as Repeat Clickers

You must create a custom incoming mail policy to configure aggressive mail policies for end users categorized as repeat clickers.

## Procedure

---

- Step 1** Go to **Mail Policies > Incoming Mail Policies**.
  - Step 2** Click **Add Policy**.
  - Step 3** Enter a name for the policy.
  - Step 4** Check **Add User**.
  - Step 5** Select **Following Recipients**.
  - Step 6** Check the **Include Repeat Clicker List** checkbox to include the list of recipients categorized as repeat clickers by the Cisco Secure Awareness cloud service.
  - Step 7** Click **OK**.
  - Step 8** Click **Submit**.
  - Step 9** Configure the required service engines (for example, Anti-Virus, Graymail, and so on) for the mail policy.
  - Step 10** Commit your changes.
- 

## Cisco Secure Awareness Cloud Service and Clusters

If you use centralized management, you can enable the Cisco Secure Awareness cloud service at the cluster, group, and machine level. If you have enabled your email gateway with the Cisco Secure Awareness cloud service in standalone mode, you can choose to join a cluster registered with the Cisco Secure Awareness cloud service.



---

**Note** When you disable the Cisco Secure Awareness cloud service at the machine level, it is disabled only for the logged-in email gateway while the other machines in the cluster are still connected to the Cisco Secure Awareness cloud service.

---

## Viewing Logs

The Cisco Secure Awareness cloud service information is posted to the Mail Logs. Most information is at the Info or Debug level.

**Examples of Cisco Secure Awareness Log Entries:**

- In this example, the log shows that the download of the Repeat Clickers list from the Cisco Secure Awareness cloud service failed because of an invalid token.

```
Tue Oct 13 10:12:59 2020 Warning: CSA:
The download of the Repeat Clickers list from
the Cisco Secure Awareness cloud service failed because
of an invalid token.
```

**Solution:** Make sure you obtain a valid authentication token from the Cisco Secure Awareness cloud service.

- In this example, the log shows that the download of the Repeat Clickers list from the Cisco Secure Awareness cloud service failed because of a connection error.

```
Wed Oct 14 10:59:36 2020 Warning: CSA:
The download of the Repeat Clickers list from
the Cisco Secure Awareness cloud service failed because
of a connection error.
```

**Solution:** Verify the firewall configuration settings used to connect your email gateway to the Cisco Secure Awareness cloud service.

- In this example, the log shows that the download of the Repeat Clickers list from the Cisco Secure Awareness cloud service failed because of an internal server error.

```
Wed Oct 14 10:59:36 2020 Warning: CSA:
The download of the Repeat Clickers list from
the Cisco Secure Awareness cloud service failed because
of an internal server error.
```

**Solution:** Contact Cisco Support for technical assistance.

- In this example, the log shows that the download of the Repeat Clickers list from the Cisco Secure Awareness cloud service failed because the SSL certificate verification failed.

```
Wed Oct 14 11:02:46 2020 Warning: CSA:
The download of the Repeat Clickers list from
the Cisco Secure Awareness cloud service failed because
the SSL certificate verification failed.
```

**Solution:** Add the required CA certificate of the proxy server in the custom certificate authority list of your email gateway.

- In this example, the log shows that the download of the Repeat Clickers list from the Cisco Secure Awareness cloud service failed because the proxy authentication failed.

```
Wed Oct 14 11:09:48 2020 Warning: CSA:
The download of the Repeat Clickers list from
the Cisco Secure Awareness cloud service failed
because the proxy authentication failed.
```

**Solution:** Check whether the proxy server is configured with the correct authentication credentials in your email gateway.

- In this example, the log shows that a request to the Cisco Secure Awareness cloud service failed because the Report API was not enabled on the Cisco Secure Awareness cloud service.

```
Mon Aug 17 15:35:42 2020 Warning: CSA:
The download of the Repeat Clickers list failed.
A request to the CSA cloud service failed because
the Report API was not enabled on the CSA cloud service
```

**Solution:** Check the Enable Report API check box in Environment > Settings > Report API tab of the Cisco Secure Awareness cloud service.

- In this example, the log shows that the Cisco Secure Awareness feature expires on a particular date.

```
2020-10-15 08:00:11,968 INFO csa The Cisco Secure
Awareness feature expires on 2029-12-28T23:59:59Z. You need to
contact your Cisco Account Manager to renew the license.
```

**Solution:** Contact your Cisco Account Manager to renew the license.

- In this example, the log shows that the Cisco Secure Awareness feature license has expired, and the feature is disabled on your email gateway.

```
2020-10-27 13:33:21,714 CRITICAL csa The Cisco Secure
Awareness feature license has expired, and the feature is
disabled on your email gateway. Contact your Cisco Account Manager
to renew the license.
```

**Solution:** Contact your Cisco Account Manager to renew the license.

- In this example, the log shows that the downloaded Repeat Clickers list is empty.

```
Tue Oct 13 10:10:18 2020 Info: CSA: The downloaded
Repeat Clickers list is empty.
```

**Solution:** Create simulated phishing messages in the Cisco Secure Awareness cloud service and send them to the recipients in your organization.

- In this example, the log shows that the download of the Repeat Clickers list from the Cisco Secure Awareness cloud service failed because you have reached the maximum number of download attempts.

```
Fri Oct 16 05:22:08 2020 Warning: CSA: The download
of the Repeat Clickers list from the Cisco Secure Awareness
cloud service failed because you have reached the maximum
number of attempts.
```

**Solution:** Contact Cisco Support to increase the number of attempts to download the Repeat Clickers list from the Cisco Secure Awareness cloud service.

## Viewing Alerts

The following table lists the system alerts generated for the Cisco Secure Awareness cloud service, including a description of the alert and the alert severity.

Component/Alert Name	Message and Description	Parameters
MAIL.CSA.DOWNLOAD_FAILURE	<p>Alert text: The download of the Repeat Clickers list from the Cisco Secure Awareness cloud service failed. \$reason.</p> <p>Alert level: WARNING.</p> <p>Description: Alert is sent when the download of the Repeat Clickers list from the Cisco Secure Awareness cloud service fails.</p>	<p>Parameters: reason</p> <p>reason - Reason for the failure to download repeat clickers list from Cisco Secure Awareness cloud service.</p> <p>For example: 'invalid token,' 'reached the maximum number of attempts,' and so on.</p>

Component/Alert Name	Message and Description	Parameters
MAIL.CSA.EMPTY_EMAIL_LIST	<p>Alert text: The downloaded Repeat Clickers list is empty.</p> <p>Alert level: INFO.</p> <p>Description: Alert is sent when the downloaded Repeat Clickers list is empty. This alert indicates that there are no Repeat Clickers listed in the Cisco Secure Awareness cloud service.</p>	N/A.
MAIL.CSA.LICENSE_EXPIRING	<p>Alert text: The Cisco Secure Awareness feature license expires on \$expiry. You must contact your Cisco Account Manager to renew the license.</p> <p>Region: \$region</p> <p>Server: \$server</p> <p>Alert level: INFO</p> <p>Description: Alert is sent on 7 days prior to expiry, 3 days prior to expiry and 1 day prior to expiry.</p>	<p>Parameters: expiry, region, server</p> <p>expiry – The date on which the Cisco Secure Awareness license is expiring.</p> <p>region – The region of the Cisco Secure Awareness license which is expiring. The region can be AMERICAS, EUROPE, and so on.</p> <p>server – The name of the server URL, for example, <a href="https://secat.cisco.com">https://secat.cisco.com</a>.</p>
MAIL.CSA.LICENSE_EXPIRED	<p>Alert text: The Cisco Secure Awareness feature license has expired, and the feature is disabled on your email gateway. Contact your Cisco Account Manager to renew the license.</p> <p>Region: \$region</p> <p>Server: \$server</p> <p>Alert Level: Critical</p> <p>Description: Alert is sent on expiry of the Cisco Secure Awareness license.</p>	<p>Parameters: region, server</p> <p>region – Region of the Cisco Secure Awareness license which has expired. The region can be AMERICAS, EUROPE, and so on.</p> <p>server – Name of the server URL, for example, <a href="https://secat.cisco.com">https://secat.cisco.com</a>.</p>

Component/Alert Name	Message and Description	Parameters
MAIL.CSA.LICENSE_RETRIVAL_FAILURE	<p>Alert text: The retrieval of the license expiry details from the Cisco Secure Awareness cloud service failed \$reason</p> <p>Alert level: WARNING</p> <p>Description: Alert is sent on failure to retrieve license expiry details from Cisco Secure Awareness cloud service for three consecutive times. Every day one attempt is made to retrieve the license expiry details until the license expiry details are retrieved successfully.</p>	<p>Parameters: reason</p> <p>reason – Reason for the failure to retrieve the license expiry details from the Cisco Secure Awareness cloud service.</p> <p>For example: ‘invalid token’, and ‘reached the maximum number of attempts.’</p>







## CHAPTER 17

# Anti-Virus

---

This chapter contains the following sections:

- [Anti-Virus Scanning Overview, on page 361](#)
- [Sophos Anti-Virus Filtering, on page 362](#)
- [McAfee Anti-Virus Filtering, on page 365](#)
- [How to Configure the Email Gateway to Scan for Viruses , on page 366](#)
- [Sending an Email to the Email Gateway to Test Anti-Virus Scanning , on page 375](#)
- [Updating Virus Definitions, on page 377](#)

## Anti-Virus Scanning Overview

The email gateway includes integrated virus scanning engines from third party companies Sophos and McAfee. You can obtain license keys for the email gateway to scan messages for viruses using one or both of these virus scanning engines, and then configure your email gateway to scan for viruses using either anti-virus scanning engine.

The McAfee and Sophos engines contain the program logic necessary to scan files at particular points, process and pattern-match virus definitions with data they find in your files, decrypt and run virus code in an emulated environment, apply heuristic techniques to recognize new viruses, and remove infectious code from legitimate files.

You can configure the email gateway to scan messages for viruses (based on the matching incoming or outgoing mail policy), and, if a virus is found, to perform different actions on the message (including “repairing” the message of viruses, modifying the subject header, adding an additional X-header, sending the message to an alternate address or mailhost, archiving the message, or deleting the message).

If enabled, virus scanning is performed in the “work queue” on the email gateway, immediately after Anti-Spam scanning. (See [Email Pipeline and Security Services, on page 58.](#))

By default, virus scanning is enabled for the default incoming and outgoing mail policies.

### Related Topics

- [Evaluation Key, on page 362](#)
- [Scanning Messages with Multiple Anti-Virus Scanning Engines, on page 362](#)

## Evaluation Key

Your email gateway ships with a 30-day evaluation key for each available anti-virus scanning engine. You enable the evaluation key by accessing the license agreement in the System Setup Wizard or Security Services > Sophos/McAfee Anti-Virus pages (in the GUI) or running the `antivirusconfig` or `systemsetup` commands (in the CLI). Once you have accepted the agreement, the Anti-Virus scanning engine will be enabled, by default, for the default incoming and outgoing mail policies. For information on enabling the feature beyond the 30-day evaluation period, contact your Cisco sales representative. You can see how much time remains on the evaluation via the **System Administration > Feature Keys** page or by issuing the `featurekey` command. (For more information, see [Feature Keys, on page 1004.](#))

## Scanning Messages with Multiple Anti-Virus Scanning Engines

AsyncOS supports scanning messages with multiple anti-virus scanning engines — multi-layer anti-virus scanning. You can configure your email gateway to use one or both of the licensed anti-virus scanning engines on a per mail policy basis. You could create a mail policy for executives, for example, and configure that policy to scan mail with both Sophos and McAfee engines.

Scanning messages with multiple scanning engines provides “defense in depth” by combining the benefits of both Sophos and McAfee anti-virus scanning engines. Each engine has leading anti-virus capture rates, but because each engine relies on a separate base of technology (discussed in [McAfee Anti-Virus Filtering, on page 365](#) and [Sophos Anti-Virus Filtering, on page 362](#)) for detecting viruses, the multi-scan approach can be even more effective. Using multiple scanning engines can lead to reduced system throughput, please contact your Cisco support representative for more information.

You cannot configure the order of virus scanning. When you enable multi-layer anti-virus scanning, the McAfee engine scans for viruses first, and the Sophos engine scans for viruses second. If the McAfee engine determines that a message is virus-free, the Sophos engine scans the message, adding a second layer of protection. If the McAfee engine determines that a message contains a virus, the email gateway skips Sophos scanning and performs actions on the virus message based on settings you configured.

## Sophos Anti-Virus Filtering

The email gateway includes integrated virus-scanning technology from Sophos, Plc. Sophos Anti-Virus provides cross-platform anti-virus protection, detection and disinfection.

Sophos Anti-Virus provides a virus detection engine that scans files for viruses, Trojan horses, and worms. These programs come under the generic term of *malware*, meaning “malicious software.” The similarities between all types of malware allow anti-virus scanners to detect and remove not only viruses, but also all types of malicious software.

### Related Topics

- [Virus Detection Engine, on page 363](#)
- [Virus Scanning, on page 363](#)
- [Detection Methods, on page 363](#)
- [Virus Descriptions, on page 364](#)
- [Sophos Alerts, on page 364](#)
- [When a Virus is Found, on page 364](#)

## Virus Detection Engine

The Sophos virus detection engine lies at the heart of the Sophos Anti-Virus technology. It uses a proprietary architecture similar to Microsoft's COM (Component Object Model), consisting of a number of objects with well-defined interfaces. The modular filing system used by the engine is based on separate, self-contained dynamic libraries each handling a different "storage class," for example, file type. This approach allows virus scanning operations to be applied on generic data sources, irrespective of type.

Specialized technology for loading and searching data enables the engine to achieve very fast scanning speeds. Incorporated within it are:

- A full code emulator for detecting polymorphic viruses
- An on-line decompressor for scanning inside archive files
- An OLE2 engine for detecting and disinfecting macro viruses

The email gateway integrates with the virus engine using SAV Interface.

## Virus Scanning

In broad terms, the engine's scanning capability is managed by a powerful combination of two important components: a classifier that knows where to look, and the virus database that knows what to look for. The engine classifies the file by type rather than by relying on the extension.

The virus engine looks for viruses in the bodies and attachments of messages received by the system; an attachment's file type helps determine its scanning. For example, if a message's attached file is an executable, the engine examines the header which tells it where the executable code starts and it looks there. If the file is a Word document, the engine looks in the macro streams. If it is a MIME file, the format used for mail messaging, it looks in the place where the attachment is stored.

## Detection Methods

How viruses are detected depends on their type. During the scanning process, the engine analyzes each file, identifies the type, and then applies the relevant technique(s). Underlying all methods is the basic concept of looking for certain types of instructions or certain ordering of instructions.

### Related Topics

- [Pattern Matching, on page 363](#)
- [Heuristics, on page 364](#)
- [Emulation, on page 364](#)

## Pattern Matching

In the technique of pattern matching, the engine knows the particular sequence of code and is looking for an exact match that will identify the code as a virus. More often, the engine is looking for sequences of code that are similar, but not necessarily identical, to the known sequences of virus code. In creating the descriptions against which files are compared during scanning, Sophos virus researchers endeavor to keep the identifying code as general as possible so that – using heuristics, as explained below – the engine will find not just the original virus but also its later derivatives.

## Heuristics

The virus engine can combine basic pattern matching techniques with heuristics – a technique using general rather than specific rules – to detect several viruses in the same family, even though Sophos researchers might have analyzed only one virus in that family. The technique enables a single description to be created that will catch several variants of one virus. Sophos tempers its heuristics with other methods, minimizing the incidence of false positives.

## Emulation

Emulation is a technique applied by the virus engine to polymorphic viruses. Polymorphic viruses are encrypted viruses that modify themselves in an effort to hide themselves. There is no visible constant virus code and the virus encrypts itself differently each time it spreads. When it runs, it decrypts itself. The emulator in the virus detection engine is used on DOS and Windows executables, while polymorphic macro viruses are found by detection code written in Sophos's Virus Description Language.

The output of this decryption is the real virus code and it is this output that is detected by the Sophos virus detection engine after running in the emulator.

Executables that are sent to the engine for scanning are run inside the emulator, which tracks the decryption of the virus body as it is written to memory. Normally the virus entry point sits at the front end of a file and is the first thing to run. In most cases, only a small amount of the virus body has to be decrypted in order for the virus to be recognized. Most clean executables stop emulating after only a few instructions, which reduces overhead.

Because the emulator runs in a restricted area, if the code does turn out to be a virus, the virus does not infect the email gateway.

## Virus Descriptions

Sophos exchanges viruses with other trusted anti-virus companies every month. In addition, every month customers send thousands of suspect files directly to Sophos, about 30% of which turn out to be viruses. Each sample undergoes rigorous analysis in the highly secure virus labs to determine whether or not it is a virus. For each newly discovered virus, or group of viruses, Sophos creates a description.

## Sophos Alerts

Cisco encourages customers who enable Sophos Anti-Virus scanning to subscribe to Sophos alerts on the Sophos site at <http://www.sophos.com/virusinfo/notifications/>. Subscribing to receive alerts directly from Sophos will ensure you are apprised of the latest virus outbreaks and their available solutions.

## When a Virus is Found

When a virus has been detected, Sophos Anti-Virus can repair (disinfect) the file. Sophos Anti-Virus can usually repair any file in which a virus has been found, after which the file can be used without risk. The precise action taken depends on the virus.

There can be limitations when it comes to disinfecting, because it is not always possible to return a file to its original state. Some viruses overwrite part of the executable program which cannot be reinstated. In this instance, you define how to handle messages with attachments that could not be repaired. You configure these settings on a per-recipient basis using the Email Security Feature: the **Mail Policies > Incoming or Outgoing**

**Mail Policies** pages (GUI) or the `policyconfig -> antivirus` command (CLI). For more information on configuring these settings, see [Configuring Virus Scanning Actions for Users, on page 367](#).

## McAfee Anti-Virus Filtering

The McAfee® scanning engine:

- Scans files by pattern-matching virus signatures with data from your files.
- Decrypts and runs virus code in an emulated environment.
- Applies heuristic techniques to recognize new viruses.
- Removes infectious code from files.

### Related Topics

- [Pattern-Matching Virus Signatures, on page 365](#)
- [Encrypted Polymorphic Virus Detection, on page 365](#)
- [Heuristics Analysis, on page 365](#)
- [When a Virus is Found, on page 364](#)

## Pattern-Matching Virus Signatures

McAfee uses anti-virus definition (DAT) files with the scanning engine to detect particular viruses, types of viruses, or other potentially unwanted software. Together, they can detect a simple virus by starting from a known place in a file, then searching for a virus signature. Often, they must search only a small part of a file to determine that the file is free from viruses.

## Encrypted Polymorphic Virus Detection

Complex viruses avoid detection with signature scanning by using two popular techniques:

- **Encryption.** The data inside the virus is encrypted so that anti-virus scanners cannot see the messages or computer code of the virus. When the virus is activated, it converts itself into a working version, then executes.
- **Polymorphism.** This process is similar to encryption, except that when the virus replicates itself, it changes its appearance.

To counteract such viruses, the engine uses a technique called emulation. If the engine suspects that a file contains such a virus, the engine creates an artificial environment in which the virus can run harmlessly until it has decoded itself and its true form becomes visible. The engine can then identify the virus by scanning for a virus signature, as usual.

## Heuristics Analysis

Using only virus signatures, the engine cannot detect a new virus because its signature is not yet known. Therefore the engine can use an additional technique — heuristic analysis.

Programs, documents or email messages that carry a virus often have distinctive features. They might attempt unprompted modification of files, invoke mail clients, or use other means to replicate themselves. The engine analyzes the program code to detect these kinds of computer instructions. The engine also searches for legitimate

non-virus-like behavior, such as prompting the user before taking action, and thereby avoids raising false alarms.

By using these techniques, the engine can detect many new viruses.

## When a Virus is Found

When a virus has been detected, Sophos Anti-Virus can repair (disinfect) the file. Sophos Anti-Virus can usually repair any file in which a virus has been found, after which the file can be used without risk. The precise action taken depends on the virus.

There can be limitations when it comes to disinfecting, because it is not always possible to return a file to its original state. Some viruses overwrite part of the executable program which cannot be reinstated. In this instance, you define how to handle messages with attachments that could not be repaired. You configure these settings on a per-recipient basis using the Email Security Feature: the **Mail Policies > Incoming or Outgoing Mail Policies** pages (GUI) or the `policyconfig -> antivirus` command (CLI). For more information on configuring these settings, see [Configuring Virus Scanning Actions for Users, on page 367](#).

## How to Configure the Email Gateway to Scan for Viruses

### How to Scan Messages for Viruses

	Do This	More Info
Step 1	Enable anti-virus scanning on the email gateway.	<a href="#">Enabling Virus Scanning and Configuring Global Settings , on page 367</a>
Step 2	Define the groups of users whose messages you want to scan for viruses.	<a href="#">Creating a Mail Policy for a Group of Senders and Recipients, on page 262</a>
Step 3	(Optional) Configure how you want the virus quarantine to handle messages.	<a href="#">Configuring Policy, Virus, and Outbreak Quarantines , on page 927</a>
Step 4	Determine how you want the email gateway to handle messages with viruses.	<a href="#">Configuring Virus Scanning Actions for Users, on page 367</a>
Step 5	Configure the anti-virus scanning rules for the user groups you defined.	<a href="#">Configuring the Anti-Virus Policies for Different Groups of Senders and Recipients, on page 372</a>
Step 6	(Optional) Send an email message to test the configuration.	<a href="#">Sending an Email to the Email Gateway to Test Anti-Virus Scanning , on page 375</a>

### Related Topics

- [Enabling Virus Scanning and Configuring Global Settings , on page 367](#)
- [Configuring Virus Scanning Actions for Users, on page 367](#)
- [Configuring the Anti-Virus Policies for Different Groups of Senders and Recipients, on page 372](#)
- [Notes on Anti-Virus Configurations, on page 373](#)
- [Flow Diagram for Anti-Virus Actions, on page 374](#)

## Enabling Virus Scanning and Configuring Global Settings

You may have enabled a virus scanning engine when you ran the System Setup Wizard. Regardless, configure settings using this procedure.



---

**Note** Depending on your feature keys, you can enable Sophos, McAfee, or both.

---

### Procedure

---

**Step 1** Navigate to the **Security Services > McAfee** page.

Or

Navigate to the **Security Services > Sophos** page.

**Step 2** Click **Enable**.

**Note** Clicking **Enable** enables the feature globally for the email gateway. However, you must later enable per-recipient settings in Mail Policies.

**Step 3** After reading the license agreement, scroll to the bottom of the page and click **Accept** to accept the agreement.

**Step 4** Click **Edit Global Settings**.

**Step 5** Choose a maximum virus scanning timeout value.

Configure a timeout value for the system to stop performing anti-virus scanning on a message. The default value is 60 seconds.

**Step 6** (Optional) Click **Enable Automatic Updates** to enable automatic update of the engine.

The email gateway fetches the required updates for the particular engine from the update server.

**Step 7** Submit and commit your changes.

---

### What to do next

Configure anti-virus settings on a per-recipient basis. See [Configuring Virus Scanning Actions for Users](#), on page 367.

## Configuring Virus Scanning Actions for Users

The virus scanning engine integrated into the email gateway processes messages for viruses for incoming and outgoing mail based on policies (configuration options) you configure using the Email Security Manager feature. You enable Anti-Virus actions on a per-recipient basis using the Mail Policies > Incoming or Outgoing Mail Policies pages (GUI) or the `policyconfig > antivir` command (CLI).

### Related Topics

- [Message Scanning Settings, on page 368](#)
- [Message Handling Settings, on page 368](#)

- [Configuring Settings for Message Handling Actions, on page 369](#)

## Message Scanning Settings

- Scan for Viruses Only:

Messages processed by the system are scanned for viruses. Repairs are *not* attempted for infected attachments. You can choose whether to drop attachments and deliver mail for messages that contain viruses or could not be repaired.

- Scan and Repair Viruses:

Messages processed by the system are scanned for viruses. If a virus is found in an attachment, the system will attempt to “repair” the attachment.

- Dropping Attachments

You can choose to drop infected attachments.

When infected attachments to messages have been scanned and *dropped* by the anti-virus scanning engine, the attachment is replaced with a new attachment called “Removed Attachment.” The attachment type is text/plain and contains the following:

```
This attachment contained a virus and was stripped.
```

```
Filename: filename
```

```
Content-Type: application/filetype
```

Users will always be notified if their messages were modified in any way because they were infected with a bad attachment. You can configure a secondary notification action, as well (see [Sending Notifications, on page 371](#)). The notify action is *not* needed to inform users that a message was modified if you choose to drop infected attachments.

- X-IronPort-AV Header

All messages that are processed by the Anti-Virus scanning engine on the email gateway have the header X-IronPort-AV: added to messages. This header provides additional information to you when debugging issues with your anti-virus configuration, particularly with messages that are considered “unscannable.” You can toggle whether the X-IronPort-AV header is included in messages that are scanned. Including this header is recommended.

## Message Handling Settings

You configure the virus scanning engine to handle four distinct classes of messages that are received by a listener, with separate actions for each. *Figure - Options for Handling Messages Scanned for Viruses* summarizes the actions the system performs when the virus scanning engine is enabled.

For each of the following message types, you can choose which actions are performed. The actions are described below (see [Configuring Settings for Message Handling Actions, on page 369](#)). For example, you can configure your anti- virus settings for virus-infected messages so that the infected attachment is dropped, the subject of the email is modified, and a custom alert is sent to the message recipient.

### Repaired Message Handling

Messages are considered *repaired* if the message was completely scanned and all viruses have been repaired or removed. These messages will be delivered as is.



## Encrypted Message Handling

Messages are considered encrypted if the engine is unable to finish the scan due to an encrypted or protected field in the message. Messages that are marked encrypted may also be repaired.

Note the differences between the encryption detection message filter rule (see [Encryption Detection Rule, on page 161](#)) and the virus scanning actions for “encrypted” messages. The encrypted message filter rule evaluates to “true” for any messages that are PGP or S/MIME encrypted. The encrypted rule can only detect PGP and S/MIME encrypted data. It does not detect password protected ZIP files, or Microsoft Word and Excel documents that include encrypted content. The virus scanning engine considers any message or attachment that is password protected to be “encrypted.”



---

**Note** If you upgrade from a 3.8 or earlier version of AsyncOS and you configured Sophos Anti-Virus scanning, you must configure the Encrypted Message Handling section after you upgrade.

---

## Unscannable Message Handling

Messages are considered unscannable if a scanning timeout value has been reached, or the engine becomes unavailable due to an internal error. Messages that are marked unscannable may also be repaired.

## Virus Infected Message Handling

The system may be unable to drop the attachment or completely repair a message. In these cases, you can configure how the system handles messages that could still contain viruses.

The configuration options are the same for encrypted messages, unscannable messages, and virus messages.

## Configuring Settings for Message Handling Actions

- [Action to Apply, on page 369](#)
- [Quarantines and Anti-Virus Scanning, on page 370](#)
- [Modify the Message Subject Header, on page 370](#)
- [Archive Original Message, on page 370](#)
- [Sending Notifications, on page 371](#)
- [Add Custom Header to Message, on page 371](#)
- [Modify Message Recipient, on page 371](#)
- [Send Message to Alternate Destination Host, on page 371](#)
- [Send Custom Alert Notification, on page 372](#)

## Action to Apply

Choose which overall action to take on each message type for encrypted, unscannable, or virus positive messages: drop the message, deliver the message as an attachment to a new message, deliver the message as is, or send the message to the anti-virus quarantine area ([Quarantines and Anti-Virus Scanning, on page 370](#)).

Configuring the email gateway to deliver the infected messages as an attachment to a new message allows the recipient to choose how to deal with the original, infected attachment.

If you choose to deliver the message or deliver the message as an attachment to a new message, you can additionally:

- Modify message subject

- Archive original message
- Send generic notification
- Add custom header to message
- Modify message recipient
- Send message to alternate destination host
- Send custom alert notification



---

**Note** These actions are not mutually exclusive; you can combine some or all of them differently within different incoming or outgoing policies for different processing needs for groups of users. See the following sections and [Notes on Anti-Virus Configurations, on page 373](#) for more information on defining various scanning policies using these options.

Repaired messages have only two advanced options: Add custom header and Send custom alert notification. All other message types have access to all of the advanced options.

---

## Quarantines and Anti-Virus Scanning

When flagged for quarantine, the message continues through the rest of the email pipeline. When the message reaches the end of the pipeline, if the message has been flagged for one or more quarantines then it enters those queues. Note that if the message does not reach the end of the pipeline, it is not placed in a quarantine.

For example, a content filter can cause a message to be dropped or bounced, in which case the message will not be quarantined.

## Archive Original Message

You can archive messages the system has identified as containing (or possibly containing) viruses to the “avarchive” directory. The format is an mbox-format log file. You *must* configure an “Anti-Virus Archive” log subscription to archive messages with viruses or messages that could not be completely scanned. For more information, see [Logging, on page 1145](#)



---

**Note** In the GUI, you may need to click the “Advanced” link to reveal the “Archive original message” setting.

---

## Modify the Message Subject Header

You can alter the text of identified messages by prepending or appending certain text strings to help users more easily identify and sort identified messages.



---

**Note** White space is not ignored in the “Modify message subject” field. Add spaces after (if prepending) or before (if appending) the text you enter in this field to separate your added text from the original subject of the message. For example, add the text [WARNING: VIRUS REMOVED] with a few trailing spaces if you are prepending.

---

The default text is:

Default Subject Line Text for Anti-Virus Subject Line Modification

Verdict	Default Text to Add to Subject
Encrypted	[WARNING: MESSAGE ENCRYPTED]
Infected	[WARNING: VIRUS DETECTED]
Repaired	[WARNING: VIRUS REMOVED]
Unscannable	[WARNING: A/V UNSCANNABLE]

Any message with multiple states causes a multi-part notification message informing users what actions the email gateway performed on the message (for example, the user is notified that the message was repaired of a virus, but another part of the message was encrypted).

## Sending Notifications

When the system has identified a message as containing viruses, you can send the default notification to the sender, the recipient, and/or additional users. When specifying additional users to notify, separate multiple addresses with commas (in both the CLI and the GUI). The default notification messages are:

Default Notifications for Anti-Virus Notifications

Verdict	Notification
Repaired	The following virus(es) was detected in a mail message: <virus name(s)> Actions taken: Infected attachment dropped (or Infected attachment repaired).
Encrypted	The following message could not be fully scanned by the anti-virus engine due to encryption.
Unscannable	The following message could not be fully scanned by the anti-virus engine.
Infectious	The following unrepairable virus(es) was detected in a mail message: <virus name(s)>.

## Add Custom Header to Message

You can define an additional, custom header to be added to all messages that are scanned by the anti-virus scanning engine. Click **Yes** and define the header name and text.

You can also create filters that use the `skip-viruscheck` action so that certain messages bypass virus scanning. See [Bypass Anti-Virus System Action, on page 209](#).

## Modify Message Recipient

You can modify the message recipient, causing the message to be delivered to a different address. Click **Yes** and enter the new recipient address.

## Send Message to Alternate Destination Host

You can choose to send the notification to a different recipient or destination host for encrypted, unscannable, or virus infected messages. Click **Yes** and enter an alternate address or host.

For example, you could route suspected messages to an administrator's mailbox or a special mail server for subsequent examination. In the case of a multi-recipient message, only a single copy is sent to the alternative recipient.

## Send Custom Alert Notification

You can send a custom notification to the sender, recipient, and/or other users (email addresses). To do so, you must first create the custom notification prior to configuring the settings. See [Understanding Text Resources, on page 647](#) for more information.

**Figure 18: Options for Handling Messages Scanned for Viruses**

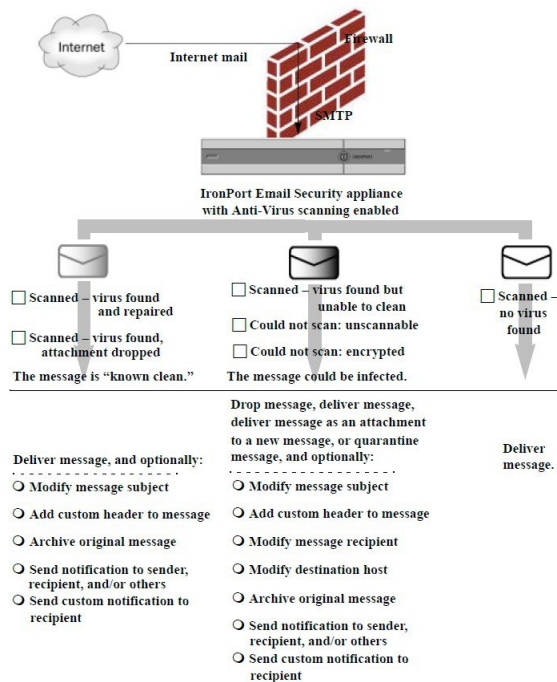

**Note** By default, Anti-Virus scanning is enabled in the \$TRUSTED mail flow policy for public listeners, which is referenced by the ALLOWED\_LIST sender group. See [Defining Access Rules for Email Senders Using Mail Flow Policies, on page 95](#).

## Configuring the Anti-Virus Policies for Different Groups of Senders and Recipients

The process for editing the per-user anti-virus settings for a mail policy is essentially the same for incoming or outgoing mail.

Individual policies (not the default) have an additional field to "Use Default" settings. Select this setting to inherit the default mail policy settings.

You enable anti-virus actions on a per-recipient basis using Incoming or Outgoing Mail Policies. You can configure mail policies in the GUI or in the CLI using the `policyconfig > antivirus` command. After you enable anti-virus settings globally, you configure these actions separately for each mail policy you create. You can configure different actions for different mail policies.

## Procedure

---

- Step 1** Navigate to the Mail Policies > Incoming Mail Policies or Mail Policies > Outgoing Mail Policies page.
- Step 2** Click the link for the anti-virus security service for the policy you want to configure.
- Note** Click the link in the default row to edit the settings for the default policy.
- Step 3** Click **Yes** or **Use Default** to enable Anti-Virus Scanning for the policy.
- The first setting on the page defines whether the service is enabled for the policy. You can click **Disable** to disable the service altogether.
- For mail policies other than the default, choosing “Yes” enables the fields in the Repaired, Encrypted, Unscannable, and Virus Infected Messages areas to become active.
- Step 4** Select an Anti-Virus scanning engine. You can select McAfee or Sophos engines.
- Step 5** Configure Message Scanning settings.
- See [Message Scanning Settings, on page 368](#) for more information.
- Step 6** Configure settings for Repaired, Encrypted, Unscannable, and Virus Infected messages.
- See [Message Handling Settings, on page 368](#) and [Configuring Settings for Message Handling Actions, on page 369](#).
- Step 7** Click **Submit**.
- Step 8** Commit your changes.
- 

## Notes on Anti-Virus Configurations

The drop attachments flag makes a considerable difference in how anti-virus scanning works. When the system is configured to “Drop infected attachments if a virus is found and it could not be repaired,” any viral or unscannable MIME parts are removed from messages. The output from Anti-Virus scanning, then, is almost always a clean message. The action defined for *Unscannable Messages*, as shown in the GUI pane, rarely takes place.

In a “Scan for Viruses only” environment, these actions “clean” messages by dropping the bad message parts. Only if the RFC822 headers themselves are attacked or encounter some other problem would this result in the unscannable actions taking place. However, when Anti-Virus scanning is configured for “Scan for Viruses only” and “Drop infected attachments if a virus is found and it could not be repaired,” is *not* chosen, the unscannable actions are very likely to take place.

The following table lists some common Anti-Virus configuration options

Common Anti-Virus Configuration Options

Situation	Anti-Virus Configuration
<p>Widespread Virus Outbreak</p> <p>Any viral message is simply dropped from the system with little other processing taking place.</p>	<p><b>Drop-attachments:</b> NO</p> <p><b>Scanning:</b> Scan-Only</p> <p><b>Cleaned messages:</b> Deliver</p> <p><b>Unscannable messages:</b> DROP message</p> <p>Encrypted messages: Send to administrator or quarantine for review.</p> <p>Viral messages: Drop message</p>
<p>Liberal Policy</p> <p>As many documents as possible are sent.</p>	<p><b>Drop-attachments:</b> YES</p> <p><b>Scanning:</b> Scan and Repair</p> <p><b>Cleaned messages:</b> [VIRUS REMOVED] and Deliver</p> <p><b>Unscannable messages:</b> Forward as attachment</p> <p>Encrypted messages: Mark and forward</p> <p>Viral messages: Quarantine or mark and forward.</p>
<p>More Conservative Policy</p>	<p><b>Drop-attachments:</b> YES</p> <p><b>Scanning:</b> Scan and Repair</p> <p><b>Cleaned messages:</b> [VIRUS REMOVED] and Deliver (Archive cleaned messages for a more cautious policy.)</p> <p><b>Unscannable messages:</b> Send notification(s), quarantine, OR drop and archive.</p> <p>Encrypted messages: Mark and forward OR treat as unscannable</p> <p>Viral messages: Archive and drop</p>
<p>Conservative with Review</p> <p>Possible virus messages are sent to a quarantine mailbox so that an administrator can review the content.</p>	<p><b>Drop-attachments:</b> NO</p> <p><b>Scanning:</b> Scan-Only</p> <p><b>Cleaned messages:</b> Deliver (this action won't normally be taken)</p> <p><b>Unscannable messages:</b> Forward as attachment, alt-src-host , or alt-rcpt-to actions.</p> <p>Encrypted messages: Treat as unscannable</p> <p>Viral messages: Forward to quarantine or administrator.</p>

## Flow Diagram for Anti-Virus Actions

The following figure explains how anti-virus actions and options affect messages processed by the email gateway.

Figure 19: Flow Diagram for Anti-Virus Actions

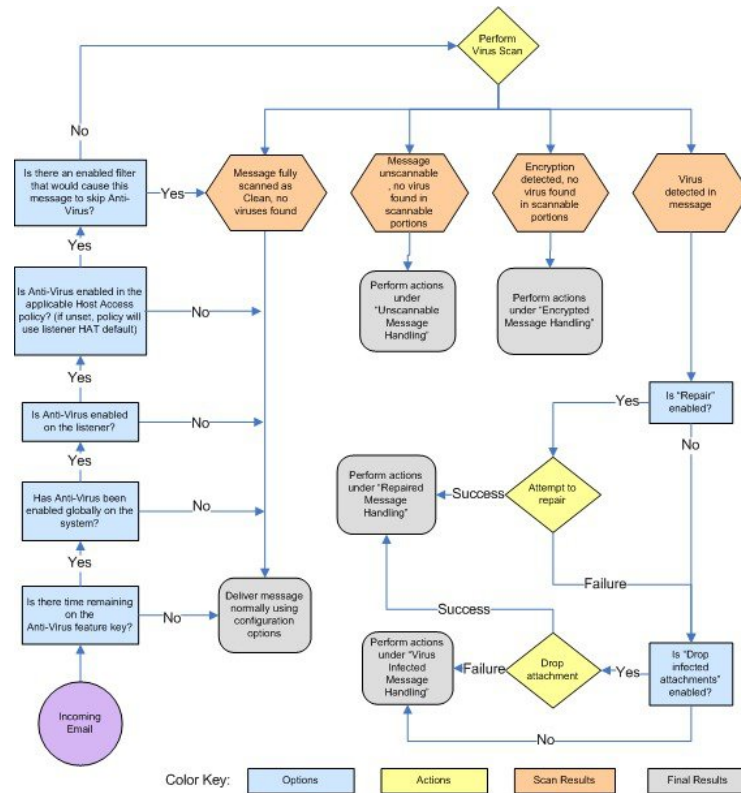

**Note** If you configure multi-layer anti-virus scanning, the Cisco appliance performs virus scanning with the McAfee engine first and the Sophos engine second. It scans messages using both engines, unless the McAfee engine detects a virus. If the McAfee engine detects a virus, the email gateway performs the anti-virus actions (repairing, quarantining, etc.) defined for the mail policy.

## Sending an Email to the Email Gateway to Test Anti-Virus Scanning

### Procedure

- Step 1** Enable virus scanning for a mail policy.
- Use the **Security Services > Sophos/McAfee Anti-virus** page or the `antivirusconfig` command to set global settings, and then use the Email Security Manager pages (GUI) or the `antivirus` subcommand of `policyconfig` to configure the settings for a specific mail policy.
- Step 2** Open a standard text editor, then type the following character string as *one line, with no spaces or line breaks*:
- ```
X50!P%@AP[4\PZX54(P^7CC)7]$EICAR-STANDARD-ANTIVIRUS-TEST-FILE!$H+H*
```

**Note** The line shown above should appear as one line in your text editor window, so be sure to maximize your text editor window and delete any line breaks. Also, be sure to type the letter O, not the number 0, in the “X5O...” that begins the test message.

If you are reading this manual on your computer, you can copy the line directly from the PDF file or HTML file and paste it into your text editor. If you copy the line, be sure to delete any extra carriage returns or spaces.

**Step 3** Save the file with the name `EICAR.COM`.

The file size will be 68 or 70 bytes.

**Note** This file is not a virus — it cannot spread or infect other files, or otherwise harm your computer. However, you should delete the file when you have finished testing your scanner to avoid alarming other users.

**Step 4** Attach the file `EICAR.COM` to an email message, and send it to the listener that will match the mail policy you configured in step 1.

Ensure that the recipient you specify in the test message will be accepted on the listener. (For more information, see [Adding Domains and Users For Which to Accept Messages, on page 123](#).)

Note that it may be difficult to email the file if you have virus scanning software installed for outgoing mail on a gateway other than the Cisco (for example, a Microsoft Exchange server).

**Note** The test file always scans as unrepairable.

**Step 5** Evaluate the actions you configured for virus scanning on the listener and ensure they are enabled and working as expected.

This is most easily accomplished by performing one of the following actions:

- a. Configure the virus scanning settings to Scan and Repair mode or Scan only mode without dropping attachments.
  - Send an email with the Eicar test file as an attachment. Confirm that the actions taken match your configuration for Virus Infected Message Handling (the settings in [Virus Infected Message Handling, on page 369](#)).
- b. Configure the virus scanning settings to Scan and Repair mode or Scan only mode with dropping attachments.
  - Send an email with the Eicar test file as an attachment.
  - Confirm that the actions taken match your configuration for Repaired Message Handling (the settings in [Repaired Message Handling, on page 368](#)).

For more information obtaining virus files for testing anti-virus scanning, see:

[http://www.eicar.org/anti\\_virus\\_test\\_file.htm](http://www.eicar.org/anti_virus_test_file.htm)

This page provides 4 files for downloading. Note that it may be difficult to download and extract these files if you have a client-side virus scanning software installed.

---



# Updating Virus Definitions

## Related Topics

- [About Retrieving Anti-Virus Updates via HTTP](#) , on page 377
- [Configuring Update Server Settings](#) , on page 377
- [Monitoring and Manually Checking for Anti-Virus Updates](#), on page 377
- [Verifying Anti-Virus Files Have Updated on the Email Gateway](#), on page 378

## About Retrieving Anti-Virus Updates via HTTP

Sophos and McAfee frequently update their virus definitions with newly-identified viruses. These updates must be passed to your email gateway.

By default, the email gateway is configured to check for updates every 5 minutes. For the Sophos and McAfee anti-virus engines, the server updates from a dynamic website.

The system does not timeout on updates as long as the update is actively downloading to the email gateway. If the update download pauses for too long, then the download times out.

The maximum amount of time that the system waits for an update to complete before timing out is a dynamic value that is defined as 1 minute less than the anti-virus update interval (defined on Security Services > Service Updates). This configuration value aids appliances on slower connections while downloading large updates that may take longer than 10 minutes to complete.

## Configuring Update Server Settings

You can configure virus update settings via the Security Services > Service Updates page. For example, you can configure how the system receives anti-virus updates and how often it checks for updates. For more information about these additional settings, see [Service Updates](#) , on page 1029.

## Monitoring and Manually Checking for Anti-Virus Updates

You can use the **Security Services > Sophos or McAfee** page or the `antivirusstatus` CLI command to verify the email gateway has the latest anti-virus engine and identity files installed, and to confirm when the last update was performed.

You can also manually perform updates. See [Manually Updating Anti-Virus Engines](#) , on page 377

## Manually Updating Anti-Virus Engines

### Procedure

---

- Step 1** Navigate to the Security Services > Sophos or McAfee Anti-Virus page.
- Step 2** Click **Update Now** in the Current McAfee/Sophos Anti-Virus Files table.

The email gateway checks for and downloads the latest updates.

---

**What to do next**

You can also configure this in the command-line interface using the `antivirusstatus` and `antivirusupdate` command

## Verifying Anti-Virus Files Have Updated on the Email Gateway

You can view the Updater Logs to verify whether or not the antivirus files have been successfully downloaded, extracted, or updated. Use the `tail` command to show the final entries in the Updater log subscription to ensure that virus updates were obtained.



## CHAPTER 18

# Managing Spam and Graymail

This chapter contains the following sections:

- [Overview of Anti-Spam Scanning](#) , on page 379
- [How to Configure the Email Gateway to Scan Messages for Spam](#), on page 380
- [IronPort Anti-Spam Filtering](#), on page 382
- [Configuring Intelligent Multi-Scan and Graymail Detection](#), on page 384
- [Defining Anti-Spam Policies](#) , on page 395
- [Protecting Email Gateway-Generated Messages From the Spam Filter](#), on page 401
- [Headers Added During Anti-Spam Scanning](#) , on page 402
- [Reporting Incorrectly Classified Messages to Cisco](#), on page 402
- [Determining Sender IP Address In Deployments with Incoming Relays](#) , on page 407
- [Monitoring Rules Updates](#), on page 416
- [Testing Anti-Spam](#), on page 417

## Overview of Anti-Spam Scanning

Anti-spam processes scan email for incoming (and outgoing) mail based on the mail policies that you configure.

- One or more scanning engines scan messages through their filtering modules.
- Scanning engines assign a score to each message. The higher the score, the greater the likelihood that the message is spam.
- Based on the score, each message is categorized as one of the following:
  - Not spam
  - Suspected spam
  - Positively-identified spam
- An action is taken based on the result.

Actions taken on messages positively identified as spam, suspected to be spam, or identified as unwanted marketing messages are not mutually exclusive; you can combine some or all of them differently within different incoming or outgoing policies for different processing needs for groups of users. You can also treat positively identified spam differently from suspected spam in the same policy. For example, you may want to drop messages positively identified as spam, but quarantine suspected spam messages.

For each mail policy, you can specify thresholds for some of the categories, and determine the action to take for each category. You can assign different users to different mail policies and define different scanning engines, spam-definition thresholds, and spam-handling actions for each policy.



**Note** For information about how and when anti-spam scanning is applied, see [Email Pipeline and Security Services](#), on page 58.

#### Related Topics

- [Anti-Spam Solutions](#) , on page 380

## Anti-Spam Solutions

Your email gateway offers the following anti-spam solutions:

- [IronPort Anti-Spam Filtering](#), on page 382.
- [Configuring Intelligent Multi-Scan and Graymail Detection](#), on page 384.

You can license and enable both these solutions on your email gateway, but you can only use one in a particular mail policy. You can specify a different anti-spam solution for different groups of users.

## How to Configure the Email Gateway to Scan Messages for Spam

#### Procedure

|               | Command or Action                                                                                                                      | Purpose                                                                                                                                                                                                                                                                                                                                                                                                                                                   |
|---------------|----------------------------------------------------------------------------------------------------------------------------------------|-----------------------------------------------------------------------------------------------------------------------------------------------------------------------------------------------------------------------------------------------------------------------------------------------------------------------------------------------------------------------------------------------------------------------------------------------------------|
| <b>Step 1</b> | Enable anti-spam scanning on the email gateway.                                                                                        | <p><b>Note</b> Remaining steps in this table apply to both scanning engine options.</p> <p>If you have feature keys for both Cisco IronPort Anti-Spam and Intelligent Multi-Scan, you can enable both solutions on the email gateway.</p> <ul style="list-style-type: none"> <li>• <a href="#">IronPort Anti-Spam Filtering</a>, on page 382</li> <li>• <a href="#">Configuring Intelligent Multi-Scan and Graymail Detection</a>, on page 384</li> </ul> |
| <b>Step 2</b> | Configure whether to quarantine spam on the local email gateway or use an external quarantine on a Cisco Secure Email and Web Manager. | <ul style="list-style-type: none"> <li>• <a href="#">Setting Up the Local Spam Quarantine</a>, on page 944</li> <li>• <a href="#">Working with an External Spam Quarantine</a> , on page 1292</li> </ul>                                                                                                                                                                                                                                                  |

|                | <b>Command or Action</b>                                                                                                                                                                                                                                                                          | <b>Purpose</b>                                                                                                                                                                                                                                                                                                                                                                            |
|----------------|---------------------------------------------------------------------------------------------------------------------------------------------------------------------------------------------------------------------------------------------------------------------------------------------------|-------------------------------------------------------------------------------------------------------------------------------------------------------------------------------------------------------------------------------------------------------------------------------------------------------------------------------------------------------------------------------------------|
| <b>Step 3</b>  | Define the groups of users whose messages you want to scan for spam.                                                                                                                                                                                                                              | <a href="#">Creating a Mail Policy for a Group of Senders and Recipients, on page 262</a>                                                                                                                                                                                                                                                                                                 |
| <b>Step 4</b>  | Configure the anti-spam scanning rules for the user groups you defined.                                                                                                                                                                                                                           | <a href="#">Defining Anti-Spam Policies , on page 395</a>                                                                                                                                                                                                                                                                                                                                 |
| <b>Step 5</b>  | If you want certain messages to skip Cisco Anti-Spam scanning, create message filters that use the skip-spamcheck action.                                                                                                                                                                         | <a href="#">Bypass Anti-Spam System Action, on page 208</a>                                                                                                                                                                                                                                                                                                                               |
| <b>Step 6</b>  | (Recommended) Enable IP Reputation Service scoring for each inbound mail flow policy, even if you are not rejecting connections based on IP Reputation Scores.                                                                                                                                    | For each inbound mail flow policy, ensure that “Use SenderBase for Flow Control” is On.<br>See <a href="#">Defining Rules for Incoming Messages Using a Mail Flow Policy, on page 103.</a>                                                                                                                                                                                                |
| <b>Step 7</b>  | If your email gateway does not connect directly to external senders to receive incoming mail, but instead receives messages relayed through a mail exchange, mail transfer agent, or other machine on your network, ensure that relayed incoming messages include the original sender IP address. | <a href="#">Determining Sender IP Address In Deployments with Incoming Relays , on page 407</a>                                                                                                                                                                                                                                                                                           |
| <b>Step 8</b>  | Prevent alert and other messages generated by your email gateway from being incorrectly identified as spam.                                                                                                                                                                                       | <a href="#">Protecting Email Gateway-Generated Messages From the Spam Filter, on page 401</a>                                                                                                                                                                                                                                                                                             |
| <b>Step 9</b>  | (Optional) Enable URL filtering to strengthen protection against malicious URLs in messages.                                                                                                                                                                                                      | <a href="#">Enable URL Filtering, on page 445</a>                                                                                                                                                                                                                                                                                                                                         |
| <b>Step 10</b> | Test your configuration.                                                                                                                                                                                                                                                                          | <a href="#">Testing Anti-Spam, on page 417</a>                                                                                                                                                                                                                                                                                                                                            |
| <b>Step 11</b> | (Optional) Configure settings for service updates (including anti-spam rules.)                                                                                                                                                                                                                    | Scanning rules for both anti-spam solutions are retrieved by default from the Cisco update servers. <ul style="list-style-type: none"> <li>• <a href="#">Service Updates , on page 1029</a></li> <li>• <a href="#">Updates Through a Proxy Server, on page 1033</a></li> <li>• <a href="#">Configuring Server Settings for Downloading Upgrades and Updates , on page 1034</a></li> </ul> |

# IronPort Anti-Spam Filtering

## Related Topics

- [Evaluation Key, on page 382](#)
- [Cisco Anti-Spam: an Overview , on page 382](#)
- [Configuring IronPort Anti-Spam Scanning, on page 383](#)

## Evaluation Key

Your email gateway ships with a 30-day evaluation key for the Cisco Anti-Spam software. This key is not enabled until you accept the license agreement in the system setup wizard or Security Services > IronPort Anti-Spam pages (in the GUI) or the `systemsetup` or `antispamconfig` commands (in the CLI). Once you have accepted the agreement, Cisco Anti-Spam will be enabled, by default, for the default incoming Mail Policy. An alert is also sent to the administrator address you configured (see the System Setup Wizard, [Step 2: System, on page 30](#)) noting that the Cisco Anti-Spam license will expire in 30 days. Alerts are sent 30, 15, 5, and 0 days prior to expiration. For information on enabling the feature beyond the 30-day evaluation period, contact your Cisco sales representative. You can see how much time remains on the evaluation via the System Administration > Feature Keys page or by issuing the `featurekey` command. (For more information, see [Feature Keys, on page 1004](#).)

## Cisco Anti-Spam: an Overview

IronPort Anti-Spam addresses a full range of known threats including spam, phishing and zombie attacks, as well as hard-to-detect low volume, short-lived email threats such as “419” scams. In addition, IronPort Anti-Spam identifies new and evolving blended threats such as spam attacks distributing malicious content through a download URL or an executable.

To identify these threats, IronPort Anti-Spam examines the full context of a message—its content, methods of message construction, the reputation of the sender, the reputation of web sites advertised in the message, and more. IronPort Anti-Spam combines the power of email and web reputation data, leveraging the full power of the world’s largest email and web traffic monitoring network — SenderBase — to detect new attacks as soon as they begin.

IronPort Anti-Spam analyzes over 100,000 message attributes across the following dimensions:

- Email reputation — *who* is sending you this message?
- Message content — *what* content is included in this message?
- Message structure — *how* was this message constructed?
- Web reputation — *where* does the call to action take you?

Analyzing multi-dimensional relationships allows the system to catch a broad range of threats while maintaining accuracy. For example, a message that has content claiming to be from a legitimate financial institution but that is sent from an IP address on a consumer broadband network or that contains a URL hosted on a “zombie” PC will be viewed as suspicious. In contrast, a message coming from a pharmaceutical company with a positive reputation will not be tagged as spam even if the message contains words closely correlated with spam.

## Related Topics

- [URL-Related Protections and Controls , on page 443](#)

# Configuring IronPort Anti-Spam Scanning

## Procedure

- Step 1** Select **Security Services > IronPort Anti-Spam**.
- Step 2** If you have not enabled IronPort Anti-Spam in the system setup wizard:
  - a) Click **Enable**.
  - b) Scroll to the bottom of the license agreement page and click **Accept** to accept the agreement.
- Step 3** Click **Edit Global Settings**.
- Step 4** Select the check box for **Enable IronPort Anti-Spam Scanning**.  
Checking this box enables the feature globally for the email gateway.
- Step 5** To optimize the throughput of your email gateway while still being able to scan increasingly larger messages sent by spammers, configure the thresholds for message scanning by Cisco Anti-Spam.

| Option                              | Description                                                                                                                                                                                                                                                                                                                                                                                                                                                                                                                                                                                                                                                                                                                                                                                                                                                                                                                                                                                                                                                                                                                                                                                                                                             |
|-------------------------------------|---------------------------------------------------------------------------------------------------------------------------------------------------------------------------------------------------------------------------------------------------------------------------------------------------------------------------------------------------------------------------------------------------------------------------------------------------------------------------------------------------------------------------------------------------------------------------------------------------------------------------------------------------------------------------------------------------------------------------------------------------------------------------------------------------------------------------------------------------------------------------------------------------------------------------------------------------------------------------------------------------------------------------------------------------------------------------------------------------------------------------------------------------------------------------------------------------------------------------------------------------------|
| Message Scanning Thresholds         | <p><b>a. Enter a value for <i>Always scan messages smaller than</i></b> —The recommended value is 1 MB or less. Messages smaller than the <i>always scan</i> size will be fully scanned, except in cases of “early exit.” Messages larger than this size are partially scanned if they are smaller than the <i>never scan</i> size.</p> <p>Cisco advises not to exceed 3 MB for the <i>always scan</i> message size. A larger value may result in decreased performance.</p> <p><b>b. Enter a value for <i>Never scan messages larger than</i></b> —The recommended value is 2 MB or less. Messages larger than this size will not be scanned by Cisco Anti-Spam and the X-IronPort-Anti-Spam-Filtered: true header will not be added to the message.</p> <p>Cisco advises not to exceed 10 MB for the <i>never scan</i> message size. A larger value may result in decreased performance.</p> <p>For messages larger than the <i>always scan</i> size or smaller than the <i>never scan</i> size, a limited and faster scan is performed.</p> <p><b>Note</b> If the Outbreak Filters maximum message size is greater than Cisco Anti-Spam’s <i>always scan</i> message, messages smaller than the Outbreak Filters maximum size are fully scanned.</p> |
| Timeout for Scanning Single Message | <p>Enter the number of seconds to wait for timeout when scanning a message.</p> <p>Enter an integer from 1 to 120. The default value is 60 seconds.</p>                                                                                                                                                                                                                                                                                                                                                                                                                                                                                                                                                                                                                                                                                                                                                                                                                                                                                                                                                                                                                                                                                                 |

| Option           | Description                                                                                                                                                                                                                                                                                                                                                                                                                                                                                                                                                                                                                                                                                                                                                                                                                                                       |
|------------------|-------------------------------------------------------------------------------------------------------------------------------------------------------------------------------------------------------------------------------------------------------------------------------------------------------------------------------------------------------------------------------------------------------------------------------------------------------------------------------------------------------------------------------------------------------------------------------------------------------------------------------------------------------------------------------------------------------------------------------------------------------------------------------------------------------------------------------------------------------------------|
| Scanning Profile | <p>Choose from any of the following scanning profiles to catch spam messages:</p> <ul style="list-style-type: none"> <li>• <b>Normal</b> - Enable this option for a balanced approach to block spam.</li> <li>• <b>Aggressive</b> - Enable this option to provide stronger emphasis to block spam. When enabled, tuning the Anti-Spam policy thresholds have more impact on spam detection than the Normal profile with a larger potential for false positives.</li> </ul> <p><b>Note</b> When using the new aggressive scanning profile mail policy adjustments to Anti-Spam thresholds have a larger impact than before. Therefore when enabling the aggressive profile, any Anti-Spam policy thresholds previously adjusted should be reset to default settings and then reevaluated for the best balance of spam catch rate vs. false positive potential.</p> |

**Step 6** Submit and commit your changes.

## Configuring Intelligent Multi-Scan and Graymail Detection

This section describes how to configure Cisco Intelligent Multi-Scan and Graymail Detection and Safe Unsubscribing:

- [Configuring Cisco Intelligent Multi-Scan, on page 384](#)
- [Configuring Global Settings for Intelligent Multi-Scan and Graymail Detection, on page 394](#)
- [Managing Graymail, on page 385](#)

## Configuring Cisco Intelligent Multi-Scan

Cisco Intelligent Multi-Scan incorporates multiple anti-spam scanning engines, including Cisco Anti-Spam, to provide a multi-layer anti-spam solution.

When processed by Cisco Intelligent Multi-Scan:

- A message is first scanned by third-party anti-spam engines.
- Cisco Intelligent Multi-Scan then passes the message and the verdicts of the third-party engines to Cisco Anti-Spam, which assumes responsibility for the final verdict.
- After Cisco Anti-Spam performs its scan, it returns a combined multi-scan score to AsyncOS.
- Combining the benefits of the third-party scanning engines and Cisco Anti-Spam results in more caught spam while maintaining Cisco Anti-Spam's low false positive rate.

You cannot configure the order of the scanning engines used in Cisco Intelligent Multi-Scan; Cisco Anti-Spam will always be the last to scan a message and Cisco Intelligent Multi-Scan will not skip it if a third-party engine determines that a message is spam.



Using Cisco Intelligent Multi-Scan can lead to reduced system throughput. Please contact your Cisco support representative for more information.



---

**Note** The Cisco Intelligent Multi-Scan feature key also enables Cisco Anti-Spam on the email gateway, giving you the option of enabling either Cisco Intelligent MultiScan or Cisco Anti-Spam for a mail policy.

---



---

**Important** When Cisco Intelligent Multi-Scan is enabled during system setup, it is enabled for the default incoming mail policy with the default values for the global settings.

---

### Before you begin

Activate the feature key for this feature. See [Feature Keys, on page 1004](#). You will see the IronPort Intelligent Multi-Scan option only if you have done so.

### Procedure

---

- Step 1** Select **Security Services > IMS and Graymail**.
- Step 2** If you have not enabled Cisco Intelligent Multi-Scan in the system setup wizard:
- Click **Enable**.
  - Scroll to the bottom of the license agreement page and click **Accept** to accept the agreement.
- Step 3** Click **Edit IMS Settings**.
- Step 4** Select the check box for **Enable Intelligent Multi-Scan** enable the feature globally for the email gateway. However, you must still enable per-recipient settings in Mail Policies.
- Step 5** (Optional) Click **Edit Global Settings** to configure the threshold for message scanning. For more information about global settings, see [Configuring Global Settings for Intelligent Multi-Scan and Graymail Detection, on page 394](#).
- Step 6** Submit and commit your changes.
- 

## Managing Graymail

- [Overview of Graymail, on page 386](#)
- [Graymail Management Solution in Email Gateway, on page 386](#)
- [How Graymail Management Solution Works, on page 387](#)
- [Configuring Graymail Detection and Safe Unsubscribing, on page 389](#)
- [Troubleshooting Graymail Detection and Safe Unsubscribing, on page 394](#)

## Overview of Graymail

Graymail messages are messages that do not fit the definition of spam, for example, newsletters, mailing list subscriptions, social media notifications, and so on. These messages were of use at some point in time, but have subsequently diminished in value to the point where the end user no longer wants to receive them.

The difference between graymail and spam is that the end user intentionally provided an email address at some point (for example, the end user subscribed to a newsletter on an e-commerce website or provided contact details to an organization during a conference) as opposed to spam, messages that the end user did not sign up for.

## Graymail Management Solution in Email Gateway

The graymail management solution in the email gateway comprises of two components: an integrated graymail scanning engine and a cloud-based Unsubscribe Service.

The graymail management solution allows organizations to:

- Identify graymail using the integrated graymail engine and apply appropriate policy controls.
- Provide an easy mechanism for end users to unsubscribe from unwanted messages using Unsubscribe Service.

In addition to these, the graymail management solution also help organizations to provide:

- **Secure unsubscribe option for end users.** Mimicking an unsubscribe option is a popular phishing technique. For this reason, the end users are generally wary of clicking unknown unsubscribe links. For such scenarios, the cloud-based Unsubscribe Service extracts the original unsubscribe URI, checks the reputation of the URI, and then performs the unsubscribe process on behalf of the end user. This protects end users from malicious threats masquerading as unsubscribe links.
- **Uniform subscription management interface for end users.** Different graymail senders use different layouts for displaying unsubscribe links to the users. The users must search for the unsubscribe link in the message body and perform the unsubscribing. Irrespective of the graymail senders, the graymail management solution provides a common layout for displaying unsubscribe links to the users.
- **Better visibility for administrators into various graymail categories.** The graymail engine classifies each graymail into three categories (see [Graymail Classification, on page 386](#)) and the administrators can set policy controls based on these categories.
- **Improved spam efficacy**

### Related Topics

- [Graymail Classification, on page 386](#)

## Graymail Classification

The graymail engine classifies each graymail into one of the following categories:

- **Marketing Email.** Advertising messages sent by professional marketing groups, for example, bulletins from Amazon.com with details about their newly launched products.
- **Social Network Email.** Notification messages from social networks, dating websites, forums, and so on. Examples include alerts from:
  - LinkedIn, for jobs that you may be interested in
  - CNET forums, when a user responds to your post.

- **Bulk Email.** Advertising messages sent by unrecognized marketing groups, for example, newsletters from TechTarget, a technology media company.

## How Graymail Management Solution Works

The following steps illustrates the workflow of graymail management solution:

**Figure 20: Graymail Management Solution Workflow**

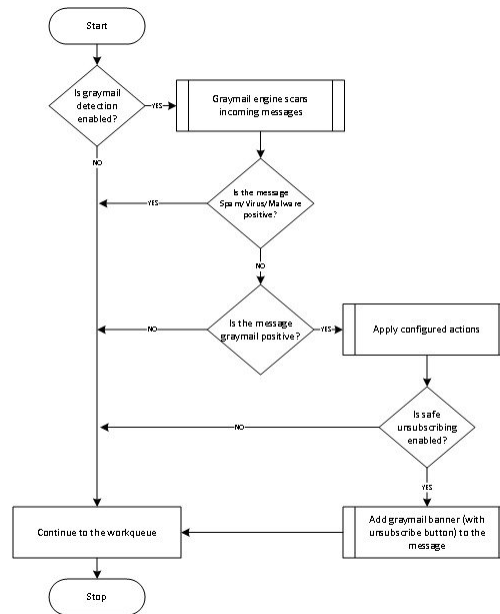

### Workflow

### Procedure

- 
- Step 1** The email gateway receives an incoming message.
  - Step 2** The email gateway checks if graymail detection is enabled. If graymail detection is enabled, go to Step 3. Else, go to Step 8
  - Step 3** The email gateway checks if the message is spam, virus, or malware positive. If positive, go to Step 8. Else, go to Step 4
  - Step 4** The email gateway checks if the message is graymail. If the message is graymail, go to Step 5. Else, go to Step 8
  - Step 5** The email gateway applies the configured policy actions such as, drop, deliver, bounce, or quarantine to the spam quarantine.
  - Step 6** The email gateway checks if safe unsubscribing is enabled. If safe unsubscribing is enabled, go to Step 7. Else, go to Step 8.
  - Step 7** The email gateway adds a banner with unsubscribe button to the message. Also, the email gateway rewrites the existing unsubscribe links in the message body.
  - Step 8** The email gateway processes the message through the next stages of its email work queue.
-

**What to do next**

For an overview of how email is processed through the system, from reception to routing to delivery, see [Understanding the Email Pipeline, on page 53](#)

**Related Topics**

- [How Safe Unsubscribing Works, on page 388](#)
- [Understanding the Email Pipeline, on page 53](#)

**How Safe Unsubscribing Works**

The following flow diagram shows how safe unsubscribing works.

*Figure 21: Safe Unsubscribing Workflow*

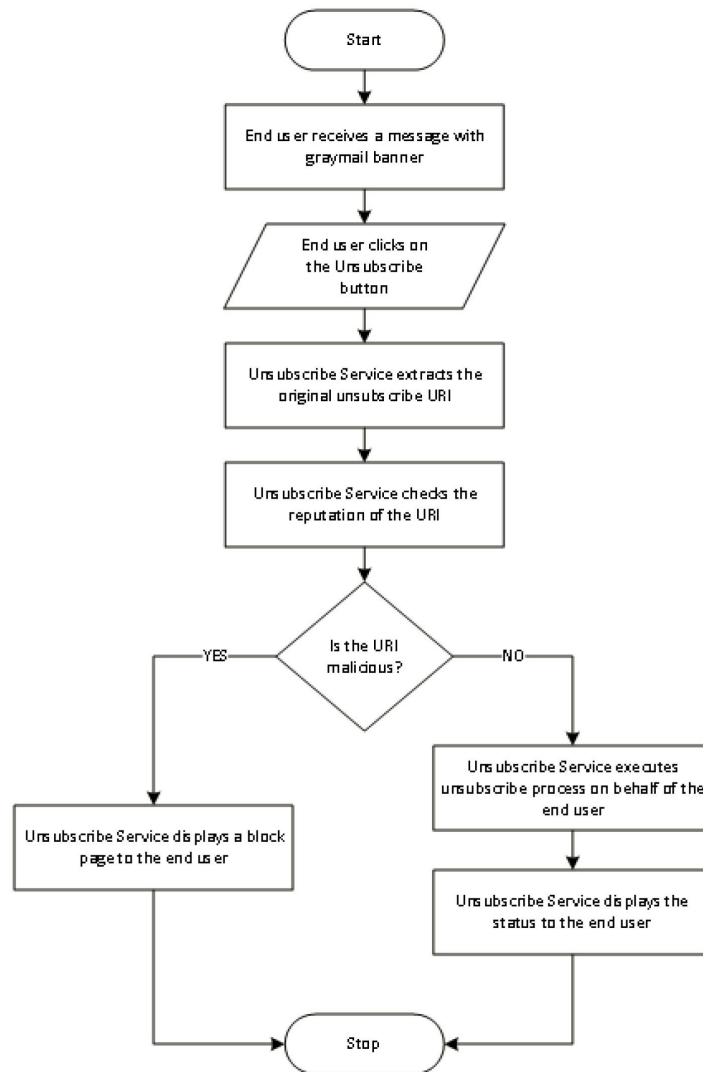

**Workflow**

## Procedure

---

- Step 1** End user receives a message with the graymail banner.
- Step 2** End user clicks on the Unsubscribe link.
- Step 3** Unsubscribe Service extracts the original unsubscribe URI.
- Step 4** Unsubscribe Service checks the reputation of the URI.
- Step 5** Depending on the reputation of the URI, the Unsubscribe Service performs one of the following actions:
- If the URI is malicious, the Unsubscribe Service will not perform the unsubscribe process and displays a block page to the end user.
  - If the URI is not malicious, depending on the URI type ( http or mailto ), the Unsubscribe Service sends an unsubscribe request to the graymail sender.
    - If the request is successful, the Unsubscribe Service displays the “Successfully unsubscribed” status to the end user.
    - If the first unsubscribe request fails, the Unsubscribe Service displays the “Unsubscribe process in progress” status and provides a URL that can be used to track the status of the unsubscribing.

End users can use this URL to track the status at a later point. After the first failed attempt, the Unsubscribe Service sends periodic unsubscribe requests for a duration of four hours.

If an end user checks the status of the unsubscribe process at a later point,
    - If one of the requests within the four hour duration (from the first failed attempt) is successful, the Unsubscribe Service displays the “Successfully unsubscribed” status to the end user.
    - If none of the requests within the four hour duration (from the first failed attempt) are successful, the Unsubscribe Service displays the “Unable to subscribe” status to the end user and provides a URL that can be used to unsubscribe from the graymail manually.
- 

## Configuring Graymail Detection and Safe Unsubscribing

- [Requirements for Graymail Detection and Safe Unsubscribing, on page 389](#)
- [Graymail Detection and Safe Unsubscribing in Cluster Configurations, on page 390](#)
- [Enable Graymail Detection and Safe Unsubscribing, on page 390](#)
- [Configuring the Incoming Mail Policy for Graymail Detection and Safe Unsubscribing, on page 390](#)
- [IronPort-PHdr Header Added During Graymail Scanning, on page 391](#)
- [Bypassing Graymail Actions using Message Filters, on page 392](#)
- [Monitoring Graymail, on page 392](#)
- [Updating Graymail Rules, on page 393](#)
- [Customizing the Appearance of Unsubscribe Page for End Users, on page 393](#)
- [End-User Safelist, on page 393](#)
- [Viewing Logs, on page 393](#)

### Requirements for Graymail Detection and Safe Unsubscribing

- For graymail detection, anti-spam scanning must be enabled globally. This can be either the IronPort Anti-Spam, the Intelligent Multi-Scan feature, or Outbreak Filters. See [Managing Spam and Graymail, on page 379](#).

- For safe unsubscribing,
  - Add the safe unsubscribing feature key.
  - The end user machines must be able to connect to the cloud-based Unsubscribe Service directly over the Internet.

## Graymail Detection and Safe Unsubscribing in Cluster Configurations

You can enable Graymail Detection and Safe Unsubscribing at the machine, group or cluster level.

### Enable Graymail Detection and Safe Unsubscribing

#### Procedure

---

- Step 1** Select **Security Services > IMS and Graymail**.
- Step 2** Click **Edit Graymail Settings**.
- Step 3** Check **Enable Graymail Detection**.
- Step 4** Check **Enable Safe Unsubscribe**.
- Step 5** (Optional) Check **Enable Automatic Updates** to enable automatic update of the engine.  
The email gateway fetches the required updates for the particular engine from the update server.
- Step 6** Click **Submit**.
- Step 7** (Optional) Click **Edit Global Settings** to configure the threshold for scanning the message. For more information, see [Configuring Global Settings for Intelligent Multi-Scan and Graymail Detection, on page 394](#).
- Step 8** Submit and commit your changes.
- 

#### What to do next

To configure Graymail Detection and Safe Unsubscribing global settings in CLI, use the `imsandgraymailconfig` CLI command. For more information, see *CLI Reference Guide for AsyncOS for Cisco Secure Email Gateway*.

### Configuring the Incoming Mail Policy for Graymail Detection and Safe Unsubscribing

#### Before You Begin

[Enable Graymail Detection and Safe Unsubscribing, on page 390](#)

#### Procedure

---

- Step 1** Click **Mail Policies > Incoming Mail Policies**.
- Step 2** Click the link in the **Graymail** column of the mail policy to modify.
- Step 3** Depending on your requirements, choose the following options:
  - Enable graymail detection
  - Enable safe unsubscribing
  - Choose whether to apply the above actions on all messages or only on unsigned messages.

**Note** The email gateway considers a message signed if it is encrypted using S/MIME or it contains an S/MIME signature.

- Actions to be taken on various graymail categories (Marketing Email, Social Network Email, and Bulk Email):

- Drop, deliver, bounce, or quarantine (to the spam quarantine) the message

**Note** If you plan to use safe unsubscribing option, you must set the action to deliver or quarantine.

- Send the message to an alternate host
- Modify subject of the message
- Add custom headers
- Send the message to an alternate envelope recipient

**Note** If you are sending a graymail positive message to an alternate envelope recipient, banner will not be added.

- Archive the message

**Note** If you are planning only to monitor the detected graymail, you can enable graymail detection per policy without having to configure actions for various graymail categories. In this scenario, the email gateway takes no action on the detected graymail.

**Step 4** Submit and commit your changes.

---

#### What to do next



**Note** You can also configure outgoing mail policies for graymail detection. Keep in mind that, in this scenario, you cannot configure safe unsubscribing.

---

To configure policy settings for Graymail Detection and Safe Unsubscribing in CLI, use the **policyconfig** command. For more information, see *CLI Reference Guide for AsyncOS for Cisco Secure Email Gateway*.

#### IronPort-PHdr Header Added During Graymail Scanning

The IronPort-PHdr header is added to all messages that are processed by the Graymail engine when:

- Graymail engine is enabled globally on the email gateway.
- Graymail scanning is enabled for a specific mail policy.



**Note** If Graymail scanning is not enabled for a specific mail policy, the IronPort-PHdr header is still added to all messages, if the Graymail engine is enabled globally on the email gateway.

---

The IronPort-PHdr header contains encoded proprietary information and is not customer-decodable. This header provides additional information about debugging issues with your Graymail configuration.



**Note** If Anti-Spam engine or Outbreak Filter is enabled for a specific mail policy, the IronPort-PHDr header is added to all messages that pass through the specific mail policy.

## Bypassing Graymail Actions using Message Filters

If you do not want to apply graymail actions on certain messages, you can use the following message filters to bypass graymail actions:

| Message Filter Action | Description                             |
|-----------------------|-----------------------------------------|
| skip-marketingcheck   | Bypass actions on marketing emails      |
| skip-socialcheck      | Bypass actions on social network emails |
| skip-bulkcheck        | Bypass actions on bulk emails           |

The following example specifies that messages received on the listener “private\_listener” must bypass graymail actions on social network emails.

```
internal_mail_is_safe:
if (recv-listener == 'private_listener')
{
skip-socialcheck
();
}
```

## Monitoring Graymail

You can view data about detected graymail using the following reports.

| Report                                                                        | Contains the Following Graymail Data                                                                                                                                                                     | More Info                                       |
|-------------------------------------------------------------------------------|----------------------------------------------------------------------------------------------------------------------------------------------------------------------------------------------------------|-------------------------------------------------|
| Overview page > Incoming Mail Summary                                         | The number of incoming graymail messages under each graymail category (Marketing, Social, and Bulk) and the total number of graymail messages.                                                           | <a href="#">Overview Page, on page 834</a>      |
| Incoming Mail page > Top Senders by Graymail Messages                         | The top graymail senders.                                                                                                                                                                                | <a href="#">Incoming Mail Page, on page 837</a> |
| Incoming Mail page > Incoming Mail Details                                    | The number of incoming graymail messages under each graymail category (Marketing, Social, and Bulk) and the total number of graymail messages for all the IP addresses, domain names, or network owners. |                                                 |
| Incoming Mail page > Incoming Mail Details > Sender Profile (drill down view) | The number of incoming graymail messages under each graymail category (Marketing, Social, and Bulk) and the total number of graymail messages for a given IP address, domain name, or network owner.     |                                                 |



| Report                                                                         | Contains the Following Graymail Data                                                                                                                             | More Info                                        |
|--------------------------------------------------------------------------------|------------------------------------------------------------------------------------------------------------------------------------------------------------------|--------------------------------------------------|
| Internal Users page > Top Users by Graymail                                    | The top end users who receive graymail.                                                                                                                          | <a href="#">Internal Users Page, on page 845</a> |
| Internal Users page > User Mail Flow Details                                   | The number of incoming graymail messages under each graymail category (Marketing, Social, and Bulk) and the total number of graymail messages for all the users. |                                                  |
| Internal Users page > User Mail Flow Details > Internal User (drill down view) | The number of incoming graymail messages under each graymail category (Marketing, Social, and Bulk) and the total number of graymail messages for a given user.  |                                                  |

If you had enabled Marketing Email Scanning under anti-spam settings for a mail policy, after upgrading to AsyncOS 9.5 or later, keep in mind that:

- The number of marketing messages is a sum of marketing messages detected before and after the upgrade.
- The total number of graymail messages does not include the number of marketing messages detected before the upgrade.
- The total number of attempted messages also includes the number of marketing messages detected before the upgrade.

## Updating Graymail Rules

If you have enabled service updates, scanning rules for the graymail management solution is retrieved from the Cisco update servers. But in some scenarios (for example, you have disabled automatic service updates or automatic service update is not working), you may want to manually update graymail rules.

To manually update the graymail rules, do one of the following:

- In web interface, go to **Security Service > IMS and Graymail** page, and click **Update Now**.
- In CLI, run the `graymailupdate` command.

To know the details of existing graymail rules, see the **Rule Updates** section of the **IMS and Graymail** page in web interface or use the `graymailstatus` command in CLI.

## Customizing the Appearance of Unsubscribe Page for End Users

When an end user clicks on unsubscribe link, the Unsubscribe Service displays a Cisco branded Unsubscribe page indicating the status of the unsubscribe process (see [How Safe Unsubscribing Works, on page 388](#)). You can customize the appearance of the Unsubscribe page and display your organization's branding (such as company logo, contact information, and so on) using **Security Services > Block Page Customization**. For instructions, see [Customizing the Notification That End Users See If a Site Is Malicious , on page 449](#).

## End-User Safelist

If the end users in your organization have configured Safelist for their own email accounts, graymail messages from a sender in the safelist will not be scanned by the graymail scanning engine. For more information about Safelists, see [Using Safelists and Blocklists to Control Email Delivery Based on Sender , on page 949](#).

## Viewing Logs

The graymail detection and safe unsubscribing information is posted to the following logs:

- **Graymail Engine Logs**. Contains information about the graymail engine, status, configuration, and so on. Most information is at Info or Debug level.

- **Graymail Archive.** Contains archived messages (the messages that are scanned and associated with the “archive message” action). The format is an mbox-format log file.
- **Mail Logs.** Contains information about graymail detection and addition of banner for safe unsubscribing. Most information is at Info or Debug level.

## Troubleshooting Graymail Detection and Safe Unsubscribing

[Unable to Perform Safe Unsubscribing, on page 394](#)

### Unable to Perform Safe Unsubscribing

#### Problem

After clicking on the Unsubscribe link, the end user sees the following message: “Unable to unsubscribe from...”

#### Solution

This problem can occur if the Unsubscribe Service is unable to perform the safe unsubscribe on behalf of the end user. The following are some of the common scenarios in which the Unsubscribe Service is unable to perform the safe unsubscribe:

- Unsubscribe URI or mailto address is wrong.
- Websites that require the end users’ credentials to unsubscribe.
- Websites that require the end users to confirm the request of unsubscribing by logging into their email accounts.
- Websites that require captcha to be solved and the Unsubscribe Service is unable to solve the captcha.
- Websites that require interactive unsubscribing.

The end users can use the URL provided at the bottom of the unsubscribe page to unsubscribe manually.

## Configuring Global Settings for Intelligent Multi-Scan and Graymail Detection

To optimize the throughput of your email gateway, you can configure the threshold and the timeout settings for scanning messages by Cisco Intelligent Multi-Scan and Graymail. These settings are common for both Cisco Intelligent Multi-Scan and Graymail configuration.

1. Select **Security Services > IMS and Graymail**
2. Click **Edit Global Settings**.
3. Select the thresholds for scanning with Cisco Intelligent Multi-Scan and Graymail Detection.

The default values are:

- Always scan 512K or less.



---

**Note** This setting is not applicable for Graymail Detection and Safe Unsubscribing.

---

- Never scan 1M or more.

4. Enter the number of seconds to wait for timeout when scanning a message.

When specifying the number of seconds, enter an integer from 1 to 120. The default value is 60 seconds.

Most users do not have to change the maximum message size to be scanned or the timeout value. That said, you may be able to optimize the throughput of your email gateway by lowering the maximum message size setting.

5. Submit and commit your changes.

## Defining Anti-Spam Policies

For each mail policy, you specify settings that determine which messages are considered spam and what action to take on those messages. You also specify which engine will scan messages that the policy applies to.

You can configure different settings for the default incoming and outgoing mail policies. If you need different anti-spam policies for different users, use multiple mail policies with different anti-spam settings. You can enable only one anti-spam solution per policy; you cannot enable both on the same policy.

### Before You Begin

- Complete all steps to this point in the table in [How to Configure the Email Gateway to Scan Messages for Spam, on page 380](#).
- Familiarize yourself with the following:
  - [Understanding Positive and Suspect Spam Thresholds, on page 397](#)
  - [Configuration Examples: Actions for Positively Identified versus Suspected Spam, on page 398](#)
  - [Unwanted Marketing Messages From Legitimate Sources, on page 398](#)
  - If you have enabled more than one anti-spam solution: [Enabling Different Anti-Spam Scanning Engines in Different Mail Policies: Configuration Example, on page 400](#)
  - [Headers Added During Anti-Spam Scanning, on page 402](#)
- If you will archive spam into the “Anti-Spam Archive” log, see also [Logging, on page 1145](#).
- If you will send messages to an alternate mailhost, see also [Alter Delivery Host Action, on page 203](#).

### Procedure

- 
- Step 1** Navigate to the **Mail Policies > Incoming Mail Policies** page.  
Or
  - Step 2** Navigate to the **Mail Policies > Outgoing Mail Policies** page.
  - Step 3** Click the link under the **Anti-Spam** column for any mail policy.
  - Step 4** In the **Enable Anti-Spam Scanning for This Policy** section, select the anti-spam solution you want to use for the policy.  
  
Options you see depend on the anti-spam scanning solution(s) that you have enabled.  
  
For mail policies other than the default: If you use settings from the default policy, all other options on the page are disabled.  
  
You can also disable anti-spam scanning altogether for this mail policy.
  - Step 5** Configure settings for positively identified spam, suspected spam, and marketing messages:

| Option                                                            | Description                                                                                                                                                                                                                                                                                                                                                                                                                                                                                                                                                                       |
|-------------------------------------------------------------------|-----------------------------------------------------------------------------------------------------------------------------------------------------------------------------------------------------------------------------------------------------------------------------------------------------------------------------------------------------------------------------------------------------------------------------------------------------------------------------------------------------------------------------------------------------------------------------------|
| Enable Suspected Spam Scanning<br>Enable Marketing Email Scanning | Choose an option.<br>Positively-identified spam scanning is always enabled if anti-spam scanning is enabled.                                                                                                                                                                                                                                                                                                                                                                                                                                                                      |
| Apply This Action to Message                                      | Choose which overall action to take on positively identified spam, suspected spam, or unwanted marketing messages: <ul style="list-style-type: none"> <li>• Deliver</li> <li>• Drop</li> <li>• Bounce</li> <li>• Quarantine</li> </ul>                                                                                                                                                                                                                                                                                                                                            |
| (Optional) Send to Alternate Host                                 | You can send identified messages to an alternate destination mailhost (an email server other than the ones listed in SMTP Routes or DNS).<br><br>Enter an IP address or hostname. If you enter a hostname, its Mail Exchange (MX) will be queried first. If none exists, the A record on the DNS server will be used (as with SMTP Routes).<br><br>Use this option if you want to redirect messages, for example to a sandbox mail server for further examination.<br><br>For additional important information, see <a href="#">Alter Delivery Host Action, on page 203</a> .     |
| Add Text to Subject                                               | You can alter text in the Subject of identified messages by prepending or appending certain text strings to help users more easily identify and sort spam and unwanted marketing messages.<br><br><b>Note</b> White space is not ignored in this field. Add spaces after (if prepending) or before (if appending) the text you enter in this field to separate your added text from the original subject of the message. For example, if you are prepending, add the text [SPAM] with a few trailing spaces.<br><br>“Add Text to Subject” field only accepts US-ASCII characters. |
| Advanced Options (for custom header and message delivery)         |                                                                                                                                                                                                                                                                                                                                                                                                                                                                                                                                                                                   |
| (Optional) Add Custom Header                                      | You can add a custom header to identified messages.<br><br>Click <b>Advanced</b> and define header and value.<br><br>You can use a custom header in conjunction with a content filter to perform actions such as redirecting URLs in suspected spam messages so that they pass through the Cisco Web Security proxy service. For information, see <a href="#">Using Custom Headers to Redirect URLs in Suspected Spam to the Cisco Web Security Proxy: Configuration Example</a> , on page 399.                                                                                   |

| Option                                             | Description                                                                                                                                                                                                                                                                                                                                                        |
|----------------------------------------------------|--------------------------------------------------------------------------------------------------------------------------------------------------------------------------------------------------------------------------------------------------------------------------------------------------------------------------------------------------------------------|
| (Optional) Send to an Alternate Envelope Recipient | You can have identified messages sent to an alternate envelope recipient address.<br>Click <b>Advanced</b> and define an alternate address.<br>For example, you could route messages identified as spam to an administrator's mailbox for subsequent examination. In the case of a multi-recipient message, only a single copy is sent to the alternate recipient. |
| Archive Message                                    | You can archive identified messages into the "Anti-Spam Archive" log. The format is an mbox-format log file.                                                                                                                                                                                                                                                       |
| Spam Thresholds                                    | Use the default thresholds or enter a threshold value for positively identified spam and a value for suspected spam.                                                                                                                                                                                                                                               |

**Step 6** Submit and commit your changes.

### What to do next

If you enabled anti-spam scanning for outgoing mail, check the anti-spam settings of the relevant host access table, especially for a private listener. See [Defining Access Rules for Email Senders Using Mail Flow Policies](#), on page 95.

### Related Topics

- [How to Configure the Email Gateway to Scan Messages for Spam](#), on page 380
- [Understanding Positive and Suspect Spam Thresholds](#), on page 397
- [Configuration Examples: Actions for Positively Identified versus Suspected Spam](#), on page 398
- [Unwanted Marketing Messages From Legitimate Sources](#), on page 398
- [Using Custom Headers to Redirect URLs in Suspected Spam to the Cisco Web Security Proxy: Configuration Example](#), on page 399
- [Enabling Different Anti-Spam Scanning Engines in Different Mail Policies: Configuration Example](#), on page 400

## Understanding Positive and Suspect Spam Thresholds

When evaluating messages for spam, both anti-spam scanning solutions apply thousands of rules in order to arrive at an overall spam score for the message. The score is then compared to the thresholds specified in the applicable mail policy to determine whether the message is considered spam.

For highest accuracy, the threshold for positive identification as spam is quite high by default: Messages scoring between 90 and 100 are considered to be positively identified as spam. The default threshold for suspected spam is 50.

- Messages with scores below the suspected spam threshold will be considered legitimate.
- Messages above the suspected threshold but below the positive-identification threshold will be considered to be suspected spam.

You can configure your anti-spam solution to reflect the spam tolerance levels of your organization by customizing the Positive and Suspected spam thresholds in each mail policy.

You can change the positively identified spam threshold to a value between 50 and 99. You can change the threshold for suspected spam to any value between 25 and the value you specified for positively-identified spam.

When you change the thresholds:

- Specifying a lower number (a more aggressive configuration) identifies more messages as spam and may produce more false positives. This provides a lower risk that users will see spam but a higher risk of having legitimate mail marked as spam.
- Specifying a higher number (a more conservative configuration) identifies fewer messages as spam and may deliver more spam. This provides a higher risk of users seeing spam but less risk that legitimate mail will be withheld as spam. Ideally, if set up correctly, the message subject will identify the message as likely spam and message will be delivered.

You can define separate actions to take on positively-identified and suspected spam. For example, you may want to drop “positively identified” spam but quarantine “suspected” spam.

### Related Topics

- [Anti-Spam Solutions](#) , on page 380
- [Configuration Examples: Actions for Positively Identified versus Suspected Spam](#) , on page 398

## Configuration Examples: Actions for Positively Identified versus Suspected Spam

| Spam                  | Sample Actions<br>(Aggressive)                                     | Sample Actions<br>(Conservative)                                                                                                                |
|-----------------------|--------------------------------------------------------------------|-------------------------------------------------------------------------------------------------------------------------------------------------|
| Positively Identified | Drop                                                               | <ul style="list-style-type: none"> <li>• Deliver with “ [Positive Spam] ” added to the subject of messages, or</li> <li>• Quarantine</li> </ul> |
| Suspected             | Deliver with “ [Suspected Spam] ” added to the subject of messages | Deliver with “ [Suspected Spam] ” added to the subject of messages                                                                              |

The aggressive example tags only suspected spam messages, while dropping those messages that are positively identified. Administrators and end-users can check the subject line of incoming message for false positives, and an administrator can adjust, if necessary, the suspected spam threshold.

In the conservative example, positively identified and suspected spam is delivered with an altered subject. Users can delete suspected and positively identified spam. This method is more conservative than the first.

For a further discussion of aggressive and conservative policies in mail policies, see [Managed Exceptions](#), on page 265.

## Unwanted Marketing Messages From Legitimate Sources

If you had configured Marketing Email Settings under anti-spam settings for a mail policy, after upgrading to AsyncOS 9.5 for Email, Marketing Email Settings under anti-spam settings will be moved under graymail settings of the same policy. See [Managing Spam and Graymail](#), on page 379.

# Using Custom Headers to Redirect URLs in Suspected Spam to the Cisco Web Security Proxy: Configuration Example

You can rewrite URLs in suspected spam so that when a recipient clicks a link in the message, the request is routed through the Cisco Web Security proxy service, which evaluates the safety of the site at click time and blocks access to known malicious sites.

## Before You Begin

Enable the URL Filtering feature and its prerequisites. See [Setting Up URL Filtering, on page 444](#).

## Procedure

---

- Step 1** Apply a custom header to suspected spam messages:
- Select **Mail Policies > Incoming Mail Policies**.
  - Click the link in the **Anti-Spam** column for a policy such as the Default policy.
  - In the Suspected Spam Settings section, enable suspected spam scanning.
  - Click **Advanced** to display the Add Custom Header option.
  - Add a custom header such as `url_redirect`.
  - Submit and commit your changes.
- Step 2** Create a content filter to redirect URLs in messages that have the custom header:
- Select **Mail Policies > Incoming Content Filters**.
  - Click **Add Filter**.
  - Name the filter `url_redirect`.
  - Click **Add Condition**.
  - Click **Other Header**.
  - Enter the header name: `url_redirect`.
- Make sure this exactly matches the header you created above.
- Select **Header exists**.
  - Click **OK**.
  - Click **Add Action**.
  - Click **URL Category**.
  - Select all categories in **Available Categories** and add them to **Selected Categories**.
  - For Action on URL, select **Redirect to Cisco Security Proxy**.
  - Click **OK**.
- Step 3** Add the content filter to the mail policy.
- Select **Mail Policies > Incoming Mail Policies**.
  - Click the link in the **Content Filters** column for the policy that you selected earlier in this procedure.
  - Select **Enable Content Filters** if it is not already selected.
  - Select the check box to enable the **url\_filtering** content filter.
  - Submit and commit your changes.
-

**What to do next****Related Topics**

- [Redirecting URLs, on page 425](#)
- [Content Filters, on page 269](#)

## Enabling Different Anti-Spam Scanning Engines in Different Mail Policies: Configuration Example

When using the System Setup Wizard (or `systemsetup` command in the CLI), you are presented with option to enable either Cisco Intelligent Multi-Scan or the Cisco Anti-Spam engine. You cannot enable both during system setup, but after system setup is complete you can enable the anti-spam solution that you didn't choose, by using the Security Services menu.

After the system is set up, you can configure the anti-spam scanning solution for incoming mail policies via the **Mail Policies > Incoming Mail Policies** page. (Anti-spam scanning is typically disabled for outgoing mail policies.) You can even disable anti-spam scanning for a policy.

In this example, the default mail policy and the "Partners" policy are using the Cisco Anti-Spam scanning engine to quarantine positive and suspected spam.

**Figure 22: Mail Policies - Anti -spam Engine Per Recipient**

### Incoming Mail Policies

Find Policies

Email Address:  
 Recipient  
 Sender
 
Find Policies

Policies

Add Policy...

| Order | Policy Name    | Anti-Spam                                                           | Anti-Virus                                                                   | Content Filters | Virus Outbreak Filters | Delete |
|-------|----------------|---------------------------------------------------------------------|------------------------------------------------------------------------------|-----------------|------------------------|--------|
| 1     | Partners       | (use default)                                                       | (use default)                                                                | (use default)   | (use default)          |        |
|       | Default Policy | IronPort Anti-Spam<br>Positive: Quarantine<br>Suspected: Quarantine | Sophos<br>Encrypted: Deliver<br>Unscannable: Deliver<br>Virus Positive: Drop | Disabled        | Enabled                |        |

Key: Default Custom Disabled

To change the Partners policy to use Cisco Intelligent Multi-Scan and scan for unwanted marketing messages, click on the entry in the Anti-Spam column corresponding with the Partners row ("use default").

Select Cisco Intelligent Multi-Scan for the scanning engine, and select Yes to enable unwanted marketing message detection. Use the default settings for unwanted marketing message detection.

The following figure shows Cisco Intelligent Multi-Scan and unwanted marketing message detection enabled in a policy.



Figure 23: Mail Policies - Enabling Cisco Intelligent Multi-scan

**Anti-Spam Settings**

**Policy:** Test

Enable Anti-Spam Scanning for This Policy:

- Use Settings from Default Policy (IronPort Anti-Spam)
- Use IronPort Anti-Spam service
- Use IronPort Intelligent Multi-Scan  
*Spam scanning built on IronPort Anti-Spam.*
- Disabled

**Positively-Identified Spam Settings**

Apply This Action to Message: Deliver

Send to Alternate Host (optional):

Add Text to Subject: Prepend [SPAM]

Advanced: Optional settings for custom header and message delivery.

**Suspected Spam Settings**

Enable Suspected Spam Scanning:  No  Yes

Apply This Action to Message: Deliver

Send to Alternate Host (optional):

Add Text to Subject: Prepend [SUSPECTED SPAM]

Advanced: Optional settings for custom header and message delivery.

**Marketing Email Settings**

Enable Marketing Email Scanning:  No  Yes

Apply This Action to Message: Deliver

Send to Alternate Host (optional):

Add Text to Subject: Prepend [MARKETING]

Advanced: Optional settings for custom header and message delivery.

After submitting and committing the changes, the mail policy looks like this:

Figure 24: Mail Policies - Intelligent Multi-Scan Enabled in Policy

Incoming Mail Policies

**Find Policies**

Email Address:

Recipient  Sender Find Policies

**Policies**

Add Policy...

| Order | Policy Name    | Anti-Spam                                                                                                 | Anti-Virus    | Content Filters | Virus Outbreak Filters | Delete |
|-------|----------------|-----------------------------------------------------------------------------------------------------------|---------------|-----------------|------------------------|--------|
| 1     | Partners       | IronPort Intelligent Multi-Scan<br>Positive: Deliver<br>Suspected: Deliver<br>Marketing Messages: Deliver | (use default) | (use default)   | (use default)          |        |
|       | Default Policy | IronPort Anti-Spam<br>Positive: Deliver<br>Suspected: Deliver<br>Marketing Messages: Disabled             | Not Available | Disabled        | Not Available          |        |

Key: Default Custom Disabled

# Protecting Email Gateway-Generated Messages From the Spam Filter

Because automated email messages that are sent from the email gateway (such as email alerts and scheduled reports) may contain URLs or other information that may cause them to be incorrectly identified as spam, you should do the following to ensure their delivery:

Include senders of these messages in an incoming mail policy that bypasses anti-spam scanning. See [Creating a Mail Policy for a Group of Senders and Recipients, on page 262](#) and [Bypass Anti-Spam System Action, on page 208](#).

## Headers Added During Anti-Spam Scanning

- If either anti-spam scanning engine is enabled for a mail policy, each message that passes through that policy will have the following headers added to the message:

**X-IronPort-Anti-Spam-Filtered: true**

**X-IronPort-Anti-Spam-Result**

The second header contains information that allows Cisco Support to identify the rules and engine version used to scan the message. Result information is encoded proprietary information and is not customer-decodable.

- Cisco Intelligent Multi-Scan also adds headers from the third-party anti-spam scanning engines.
- You can define additional custom headers to be added to all messages for a given mail policy that are positively identified as spam, suspected to be spam, or identified as unwanted marketing mail. See [Defining Anti-Spam Policies](#), on page 395.

### Related Topics

- [Using Custom Headers to Redirect URLs in Suspected Spam to the Cisco Web Security Proxy: Configuration Example](#), on page 399

## Reporting Incorrectly Classified Messages to Cisco

Messages that appear to be incorrectly classified may be reported to Cisco for analysis. The reported messages are used to enhance the accuracy and effectiveness of the product.

You can report incorrectly classified messages that belong to the following categories:

- Missed spam
- Message marked as a spam, but is not a spam
- Missed marketing message
- Message marked as a marketing message, but is not a marketing message
- Missed phishing message

### Related Topics

- [How to Report Incorrectly Classified Messages to Cisco](#), on page 402
- [How to Track Your Submissions](#), on page 407

## How to Report Incorrectly Classified Messages to Cisco

### Before You Begin

Before you start reporting incorrectly classified messages to Cisco, you must perform the following steps. Perform this step only once.

## Procedure

---

**Step 1** Register as an administrator on Cisco Talos Email Status Portal can be done in any one of the following ways:

**Note** Cisco Talos Email Status Portal is a web-based tool that allows email administrators to view and track email submissions on the portal.

- Registering when you are the first administrator in your organization to access the portal:
  - a. Log in to Cisco Talos Email Status Portal ([https://talosintelligence.com/email\\_status\\_portal](https://talosintelligence.com/email_status_portal)) using your Cisco credentials.
  - b. Click **Manage Account**.
  - c. Click **Add Domain**.
  - d. Enter your organization's domain name in the **Domain** field to register your domain with the portal.

**Note** Make sure that you enter a valid domain name, for example, `example.com` is the domain name in the following email address: `user@example.com`. If you have multiple domains in your organization, make sure that you add all the domains.

- e. Check the **I own this domain** check box if you are the owner of the domain entered in step 'd.'

**Note** If you do not check the 'I own this domain' check box, then you will only have domain view access rights. For more information, see the Cisco Talos Email Status Portal Help page at [https://talosintelligence.com/tickets/email\\_submissions/help](https://talosintelligence.com/tickets/email_submissions/help)

- f. Click **Submit**.

After you click Submit, an email with a 6-digit character verification code is automatically sent to `postmaster@domain.com` (where `domain.com` is the domain you entered in step 'd') to confirm the domain ownership.

If your organization is not using `postmaster@domain.com` or your administrator does not have access to the postmaster mailbox, create a message filter (on all your email gateways) to redirect messages from `SubmissionPortal@cisco.com` sent to `postmaster@domain.com` to a different email address. The following is a sample message filter:

```
redirect_postmaster: if (rcpt-to == "postmaster@domain.com") AND (mail-from ==
"^SubmissionPortal@cisco.com$") { alt-rcpt-to ("admin@domain.com"); }
```

- g. Enter the 6-digit character verification code in the **Domain Ownership Verification Code** dialog box to confirm the domain ownership.
- h. Click **Submit Verification Code**.

After you click the Submit Verification Code button, you are automatically provided with admin access rights. A registration ID is auto generated that can be viewed in the Manage Accounts section of the portal. You can use the registration ID for all the email gateways in your organization.

**Note** A registration ID is a unique identifier to identify submissions made from the Cisco Email Security Gateways that belong to a particular organization.

- Registering when an administrator in your organization is already registered on the portal:

- a. Log in to Cisco Talos Email Status Portal ([https://talosintelligence.com/email\\_status\\_portal](https://talosintelligence.com/email_status_portal)) using your Cisco credentials.
- b. Click **Manage Account**.
- c. Click **Add Domain**.
- d. Enter your organization's domain name in the **Domain** field to register your domain with the portal.  
**Note** Make sure that you enter a valid domain name, for example, `example.com` is the domain name in the following email address: `user@example.com`. If you have multiple domains in your organization, make sure that you add all the domains.
- e. Click **Submit**.

After you click Submit, an email notification is sent to the administrator who is already registered on the portal. This administrator must log in to the portal, and click **Approve** in the Permission Requests section of Manage Accounts to approve your registration request.

After your registration request is approved, a registration ID is auto generated that can be viewed in the Manage Accounts section of the portal. You can use the registration ID for all the email gateways in your organization.

**Note** A registration ID is a unique identifier to identify submissions made from the Cisco Email Security Gateways that belong to a particular organization.

**Step 2** Add the registration ID generated from Cisco Talos Email Status Portal for all the email gateways in your organization.

- a. Log in to your email gateways using the web interface.
- b. Go to **System Administration > Cisco Talos Email Status Portal Registration**.
- c. If your email gateway is part of a cluster, set the mode to cluster level.
- d. Click **Set Registration ID**.
- e. Enter the registration ID obtained from the Cisco Talos Email Status Portal in the **Registration ID** field.
- f. Submit and commit your changes.
- g. If your email gateway is not part of a cluster, you must repeat steps 1 through 6 on all the email gateways in your organization.

You can also use the `portalregistrationconfig` command in CLI to set the registration ID.

---

## How to Report Incorrectly Classified Messages to Cisco

For more information, see:

- How to Submit Email Messages to Cisco document at <https://www.cisco.com/c/en/us/support/docs/security/email-security-appliance/214133-how-to-submit-email-messages-to-cisco.html#anc5>.
- Cisco Talos Email Status Portal Help page at [https://talosintelligence.com/tickets/email\\_submissions/help](https://talosintelligence.com/tickets/email_submissions/help).

## Procedure

---

**Step 1** Perform the steps mentioned in **Before You Begin** section of [How to Report Incorrectly Classified Messages to Cisco, on page 402](#) .

**Step 2** Report incorrectly classified messages to Cisco using one of the following methods:

- [Using Cisco Email Security Plug-In, on page 405](#)
- [Forwarding Incorrectly Classified Message as an Attachment, on page 405](#)

After you report an incorrectly classified message to Cisco, you will receive an email notification based on the option you select under the Email Notification and Reports button in the Manage Account section of the portal.

**Note** The 'My Submission Notifications' and 'My Submission Reports' options under the 'Email Notification and Reports' button are set to off by default. For more information, see the Cisco Talos Email Status Portal Help page at [https://talosintelligence.com/tickets/email\\_submissions/help](https://talosintelligence.com/tickets/email_submissions/help)

---

## What to do next

[How to Track Your Submissions, on page 407](#)

## Using Cisco Email Security Plug-In

Cisco Email Security Plug-In is a tool that allows users (email administrators and end users) to report incorrectly classified messages to Cisco using Microsoft Outlook. When you deploy this plug-in as part of Microsoft Outlook, a reporting menu is added to the Microsoft Outlook web interface. You can use the plug-in menu to report incorrectly classified messages.

### Additional Information

- You can download Cisco Email Security Plug-In from the following page: <https://software.cisco.com/portal/pub/download/portal/select.html?&mdfid=284900944&flowid=41782&softwareid=283090986>.
- For more information, see the Cisco Email Security Plug-In Administrator Guide <http://www.cisco.com/c/en/us/support/security/email-encryption/products-user-guide-list.html>.

## Forwarding Incorrectly Classified Message as an Attachment

Depending on the category of the message, you can forward each incorrectly classified message as an RFC 822 attachment to the following addresses as shown in the table below:

| Email Submission         | Definition                                                                                                                                                                                                                                                                                                                                                                                                                                                                          | Submission Method                                                                                                                                   | User Consideration for Submitting                                                                                                              |
|--------------------------|-------------------------------------------------------------------------------------------------------------------------------------------------------------------------------------------------------------------------------------------------------------------------------------------------------------------------------------------------------------------------------------------------------------------------------------------------------------------------------------|-----------------------------------------------------------------------------------------------------------------------------------------------------|------------------------------------------------------------------------------------------------------------------------------------------------|
| Spam / Phish             | Unsolicited and undesired. Spam/Phish is never legitimate and may also be malicious (phish, virus, malware, scams, etc.)                                                                                                                                                                                                                                                                                                                                                            | spam@access.<br>ironport.com<br>phish@access.<br>ironport.com<br>virus@access.<br>ironport.com<br>Outlook Plugin 'Spam', 'Phish', or 'Virus' button | Delivered to the user's inbox, but user considers message to be spam or Phish.<br><br>Detected as spam, but user considers message legitimate. |
| Legitimate               | Legitimate (good) email, not spam. Also known as 'Ham.'                                                                                                                                                                                                                                                                                                                                                                                                                             | ham@access.<br>ironport.com<br>Outlook Plugin 'Not Spam' button                                                                                     | Marketing/graymail messages not detected as marketing/graymail.                                                                                |
| Marketing / Graymail     | Marketing is legitimate (not Spam) email that is commercial bulk email. Usually subscription based, sometimes unwanted.<br><br>Users may have knowingly or unknowingly solicited mail from the sender. For example swiping a badge at a conference or making an online purchase, etc. Legitimate subscription based marketing email will have a working unsubscribe mechanism.<br><br>Graymail is a broader category that includes Marketing as well as other legitimate bulk mail. | ads@access.<br>ironport.com<br>Outlook Plugin 'Marketing' button                                                                                    | Detected as spam, but user considers message legitimate                                                                                        |
| Not Marketing / Graymail | Legitimate email (not Spam) that is not bulk and not subscription based. Usually person-to-person and/or transactional.                                                                                                                                                                                                                                                                                                                                                             | not_ads@access.<br>ironport.com                                                                                                                     | Detected as Marketing/Graymail, but user considers the message to be transactional or otherwise not Marketing/Graymail.                        |

You can achieve best results if you use one of the following email programs to forward the message:

- Apple Mail
- Microsoft Outlook for Mac
- Microsoft Outlook Web App
- Mozilla Thunderbird

**Caution**

If you are using Microsoft Outlook 2010, 2013, or 2016 for Microsoft Windows, you must use the Cisco Email Security Plug-In or the Microsoft Outlook Web App to report incorrectly classified messages. This is because Outlook for Windows may not forward the message with the required headers intact. Also, use the mobile platforms only if you can forward the original message as an attachment.

## How to Track Your Submissions

After you receive an email notification with the submission details, you can view and track your submission on Cisco Talos Email Status Portal.

### Procedure

- Step 1** Log in to Cisco Talos Email Status Portal ([https://talosintelligence.com/email\\_status\\_portal](https://talosintelligence.com/email_status_portal)) using your Cisco credentials.
- Step 2** Click **Submissions** on Cisco Talos Email Status Portal.
- Step 3** Click **Filter Options** and select appropriate filter option(s).
- Step 4** (Optional) Click the calendar button to choose the specific date.

### What to do next

For more information, see the Cisco Talos Email Status Portal Help page at [https://talosintelligence.com/tickets/email\\_submissions/help](https://talosintelligence.com/tickets/email_submissions/help).

## Determining Sender IP Address In Deployments with Incoming Relays

If one or more mail exchange/transfer agents (MX or MTA), filtering servers, etc. stand at the edge of your network, between your email gateway and the external machines that are sending incoming mail, then your email gateway cannot determine the IP addresses of the sending machines. Instead, mail appears to originate from the local MX/MTA. However, IronPort Anti-Spam and Cisco Intelligent Multi-Scan (using the IP Reputation Service) depend on accurate IP addresses for external senders.

The solution is to configure your email gateway to work with incoming relays. You specify the names and IP addresses of all of the internal MX/MTAs connecting to the email gateway, as well as the header used to store the originating IP address.

### Related Topics

- [Example Environments with Incoming Relays](#) , on page 408
- [Configuring the Email Gateway to Work with Incoming Relays](#) , on page 409
- [How Incoming Relays Affect Functionality](#) , on page 414
- [Configuring Logs to Specify Which Headers Are Used](#) , on page 416

## Example Environments with Incoming Relays

The following figure shows a very basic example of an incoming relay. Mail from IP address 7.8.9.1 appears to come from IP address 10.2.3.4 because the local MX/MTA is relaying mail to the email gateway.

**Figure 25: Mail Relayed by MX/MTA — Simple**

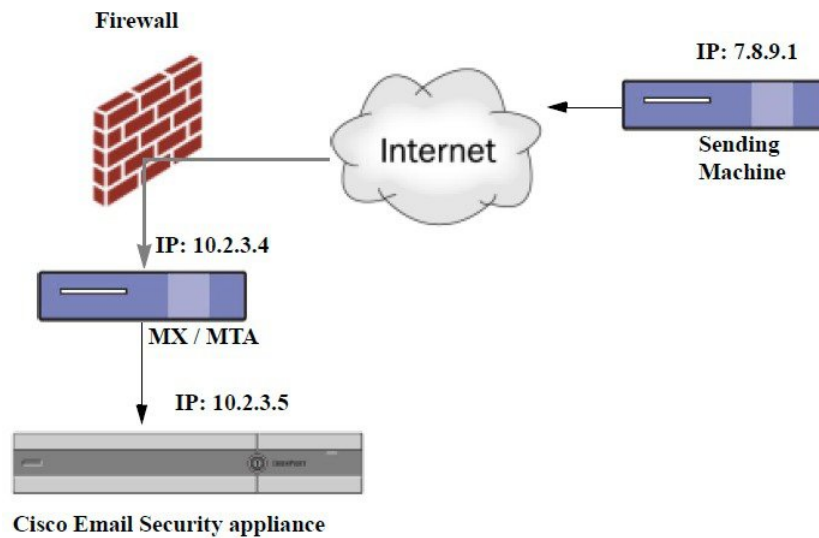

The following figure shows two other, slightly more complicated examples of how mail may be relayed inside the network and how mail may be processed by several servers within the network before it is passed to the email gateway. In example A, mail from 7.8.9.1 passes through the firewall and is processed by an MX and an MTA before being delivered to the email gateway. In example B, mail from 7.8.9.1 is sent to a load balancer or other type of traffic shaping appliance and is sent to any one of a range of MXs prior to being delivered to the email gateway.



Figure 26: Mail Relayed by MX/MTA — Advanced

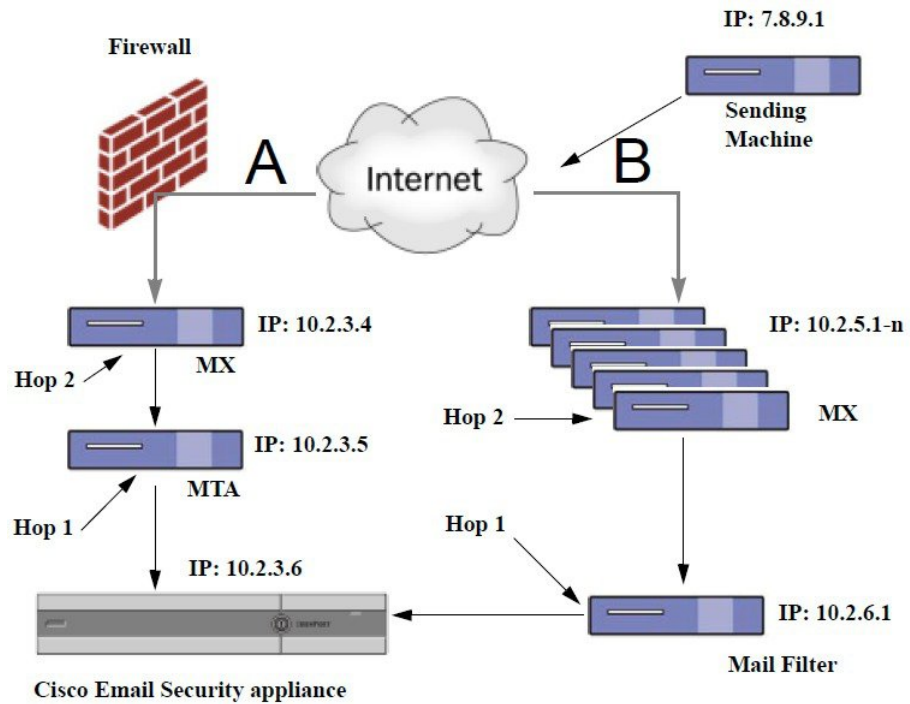

## Configuring the Email Gateway to Work with Incoming Relays

### Related Topics

- [Enabling the Incoming Relays Feature](#) , on page 409
- [Adding an Incoming Relay](#) , on page 410
- [Message Headers for Relayed Messages](#) , on page 411

### Enabling the Incoming Relays Feature



**Note** You should only enable the incoming relays feature if a local MX/MTA relays mail to your email gateway.

### Procedure

- Step 1** Select **Network > Incoming Relays**.
- Step 2** Click **Enable**.
- Step 3** Commit your changes.

## Adding an Incoming Relay

Add incoming relays to identify:

- Each machine on your network that will relay incoming messages to your email gateway, and
- The header that will label the IP address of the original external sender.

### Before You Begin

For information needed to complete these prerequisites, see [Message Headers for Relayed Messages](#), on page 411.

- Determine whether you will use custom or received headers to identify the IP address of the original external sender.
- If you will use custom headers:
  - Determine the exact header that will label the originating IP address of relayed messages.
  - For each MX, MTA, or other machine that connects to original external senders, set up that machine to add the header name and the IP address of the original external sender to incoming messages.

### Procedure

- 
- Step 1** Select **Network > Incoming Relays**.
  - Step 2** Click **Add Relay**.
  - Step 3** Enter a name for this relay.
  - Step 4** Enter the IP address of the MTA, MX, or other machine that connects to the email gateway to relay incoming messages.

You can use IPv4 or IPv6 addresses, standard CIDR format, or an IP address range. For example, if you have several MTAs at the edge of your network receiving email, you might want to enter a range of IP addresses to include all of your MTAs, such as 10.2.3.1/8 or 10.2.3.1-10.

For IPv6 addresses, AsyncOS supports the following formats:

- 2620:101:2004:4202::0-2620:101:2004:4202::ff
- 2620:101:2004:4202::
- 2620:101:2004:4202::23
- 2620:101:2004:4202::/64

- Step 5** Specify the header that will identify the IP address of the original external sender.

When entering a header, you do not need to enter the trailing colon.

- a) Select the header type:

Choose custom headers (recommended) or Received headers.

- b) For custom headers:

Enter the header name that you configured the relaying machine to add to relayed messages.

For example:

SenderIP

or

X-CustomHeader

c) For Received headers:

Enter the character or string after which the IP address will appear. Enter the number for the “hop” to check for the IP address.

**Step 6** Submit and commit your changes.

---

### What to do next

Consider doing the following:

- Add the relaying machine to a sender group with a mail flow policy that has unlimited messages for DHAP. For an explanation, see [Incoming Relays and Directory Harvest Attack Prevention, on page 415](#).
- To facilitate tracking and troubleshooting, configure the email gateway logs to show which header is used. See [Configuring Logs to Specify Which Headers Are Used , on page 416](#).

### Related Topics

- [How to Configure the Email Gateway to Scan Messages for Spam, on page 380](#)

## Message Headers for Relayed Messages

You will configure your email gateway to use one of the following types of header to identify the original sender of a relayed message:

- [Custom Header , on page 411](#)
- [Received Header, on page 412](#)

### Custom Header

Using custom headers is the recommended method of identifying original senders. The machine connecting to the original sender needs to add this custom header. The value of the header is expected to be the IP address of the external sending machine. For example:

**SenderIP: 7.8.9.1**

**X-CustomHeader: 7.8.9.1**

If your local MX/MTA can receive mail from a variable number of hops, inserting a custom header is the only way to enable the Incoming Relays feature. For example, in the following figure, both path C and D lead to IP address 10.2.3.5; however, path C has two hops and path D has one. Because the number of hops can vary in this situation, you must use a custom header in order to have Incoming Relays configured correctly.

Figure 27: Mail Relayed by MX/MTA — Variable Number of Hops

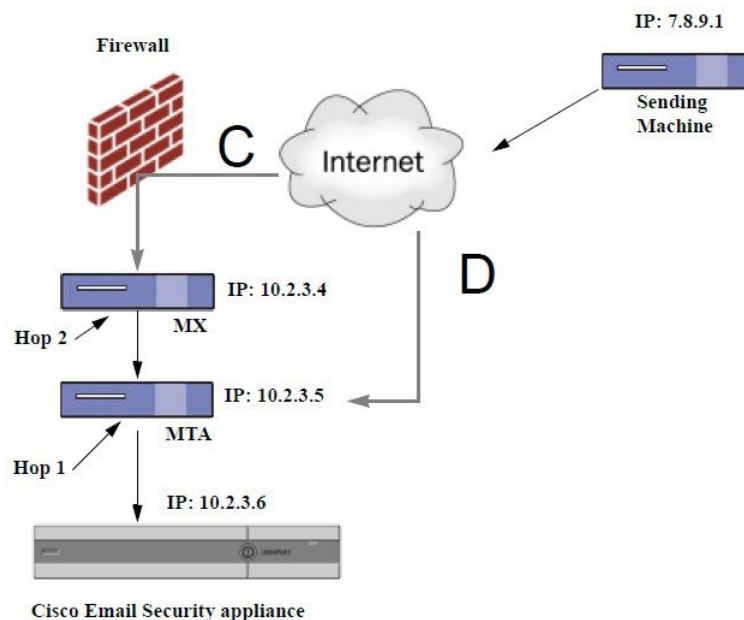

### Related Topics

- [Adding an Incoming Relay](#) , on page 410

### Received Header

If configuring the MX/MTAs to include a custom header containing the sending IP address is not an option, you can configure the incoming relays feature to attempt to determine the sending IP address by examining the “Received:” headers in the message. Using the “Received:” header will only work if the number of network “hops” will always be constant for an IP address. In other words, the machine at the first hop (10.2.3.5 in *Figure - Mail Relayed by MX/MTA — Advanced*) should always be the same number of hops away from the edge of your network. If incoming mail can take different paths (resulting in a different number of hops, as described in *Figure - Mail Relayed by MX/MTA — Variable Number of Hops*) to the machine connecting to your email gateway, you must use a custom header (see [Custom Header](#) , on page 411).

Specify a parsing character or string and the number of network hops (or Received: headers) back to look. A hop is basically the message traveling from one machine to another (being received by the email gateway does not count as a hop. See [Configuring Logs to Specify Which Headers Are Used](#) , on page 416 for more information). AsyncOS looks for the first IP address following the first occurrence of the parsing character or string in the Received: header corresponding to the number of specified hops. For example, if you specify two hops, the second Received: header, working backward from the email gateway is parsed. If neither the parsing character nor a valid IP address is found, the email gateway uses the real IP address of the connecting machine.

For the following example mail headers, if you specify an opening square bracket ( [ ) and two hops, the IP address of the external machine is 7.8.9.1. However, if you specify an closing parenthesis ( ) ) as the parsing character, a valid IP address will not be found. In this case, the Incoming Relays feature is treated as disabled, and the IP of the connecting machine is used (10.2.3.5).

In the example in *Figure - Mail Relayed by MX/MTA — Advanced* the incoming relays are:

- Path A — 10.2.3.5 (with 2 hops when using received headers) and
- Path B — 10.2.6.1 (with 2 hops when using received headers)

The following table shows example email headers for a message as it moves through several hops on its way to the email gateway as in *Figure - Mail Relayed by MX/MTA — Advanced*. This example shows extraneous headers (ignored by your email gateway) which are present once the message has arrived in the recipient's inbox. The number of hops to specify would be two.

**Table 38: A Series of Received: Headers (Path A Example 1)**

|   |                                                                                                                                                                                                                                                                                                                                                                                                                                  |
|---|----------------------------------------------------------------------------------------------------------------------------------------------------------------------------------------------------------------------------------------------------------------------------------------------------------------------------------------------------------------------------------------------------------------------------------|
| 1 | <pre>Microsoft Mail Internet Headers Version 2.0 Received: from smemail.rand.org ([10.2.2.7]) by smmail5.customerdoamin.org with Microsoft SMTPSVC(5.0.2195.6713); Received: from ironport.customerdomain.org ([10.2.3.6]) by smemail.customerdoamin.org with Microsoft SMTPSVC(5.0.2195.6713);</pre>                                                                                                                            |
| 2 | <pre>Received: from mta.customerdomain.org ([10.2.3.5]) by ironport.customerdomain.org with ESMTTP; 21 Sep 2005 13:46:07 -0700</pre>                                                                                                                                                                                                                                                                                             |
| 3 | <pre>Received: from mx.customerdomain.org (mx.customerdomain.org) [10.2.3.4]) by mta.customerdomain.org (8.12.11/8.12.11) with ESMTTP id j8LkKwul008155 for &lt;joefoo@customerdomain.org&gt;</pre>                                                                                                                                                                                                                              |
| 4 | <pre>Received: from sending-machine.spamham.com (sending-machine.spamham.com [7.8.9.1]) by mx.customerdomain.org (Postfix) with ESMTTP id 4F3DA15AC22 for &lt;joefoo@customerdomain.org&gt;</pre>                                                                                                                                                                                                                                |
| 5 | <pre>Received: from linux1.thespammer.com (HELO linux1.thespammer.com) ([10.1.1.89]) by sending-machine.spamham.com with ESMTTP; Received: from exchange1.thespammer.com ([10.1.1.111]) by linux1.thespammer.com with Microsoft SMTPSVC(6.0.3790.1830); Subject: Would like a bigger paycheck? Date: Wed, 21 Sep 2005 13:46:07 -0700 From: "A. Sender" &lt;asend@otherdomain.com&gt; To: &lt;joefoo@customerdomain.org&gt;</pre> |

Notes for the above table:

- The email gateway ignores these headers.
- The email gateway receives the message (not counted as a hop).
- First hop (and incoming relay).
- Second hop. This is the sending MTA. The IP address is 7.8.9.1.
- The email gateway ignores these Microsoft Exchange headers.

The following table shows the headers for the same email message, without the extraneous headers

**Table 39: A Series of Received: Headers (Path A Example 2)**

|   |                                                                                                                                                                                    |
|---|------------------------------------------------------------------------------------------------------------------------------------------------------------------------------------|
| 1 | Received: from mta.customerdomain.org ([10.2.3.5]) by ironport.customerdomain.org with ESMTTP; 21 Sep 2005 13:46:07 -0700                                                          |
| 2 | Received: from mx.customerdomain.org (mx.customerdomain.org) [10.2.3.4] by mta.customerdomain.org (8.12.11/8.12.11) with ESMTTP id j8LkKwU1008155 for <joefoo@customerdomain.org>; |
| 3 | Received: from sending-machine.spamham.com (sending-machine.spamham.com [7.8.9.1]) by mx.customerdomain.org (Postfix) with ESMTTP id 4F3DA15AC22 for <joefoo@customerdomain.org>;  |

The following figure shows the incoming relay for path A (above) as configured in the Add Relay page in the GUI:

**Figure 28: A Configured Incoming Relay with Received Header****Add Relay**

The screenshot shows the 'Add Relay' configuration page. The form is titled 'Incoming Relay' and contains the following fields:

- Name:** IncomingRelayOne
- IP Address:** 10.2.3.5
- Header:**  Parse the "Received" header
- Begin parsing after:** [ ]
- Hop:** 2

**Related Topics**

- [Adding an Incoming Relay](#) , on page 410

## How Incoming Relays Affect Functionality

- [Incoming Relays and Filters](#), on page 414
- [Incoming Relays, HAT, IP Reputation Score, and Sender Groups](#), on page 415
- [Incoming Relays and Directory Harvest Attack Prevention](#), on page 415
- [Incoming Relays and Trace](#), on page 415
- [Incoming Relays and Email Security Monitor \(Reporting\)](#) , on page 415
- [Incoming Relays and Message Tracking](#), on page 415
- [Incoming Relays and Logging](#) , on page 415

## Incoming Relays and Filters

The Incoming Relays feature provides the various IP Reputation Service related filter rules (reputation, no-reputation) with the correct IP Reputation score.

## Incoming Relays, HAT, IP Reputation Score, and Sender Groups

HAT policy groups do not currently use information from Incoming Relays. However, because the Incoming Relays feature does supply the Reputation score, you can simulate HAT policy group functionality via message filters and the \$reputation variable.

## Incoming Relays and Directory Harvest Attack Prevention

If a remote host attempts a directory harvest attack by sending messages to the MX or MTA serving as an incoming relay on your network, the email gateway drops the connection from the incoming relay if the relay is assigned to a sender group with a mail flow policy with Directory Harvest Attack Prevention (DHAP) enabled. This prevents all messages from the relay, including legitimate messages, from reaching the email gateway. The email gateway does not have the opportunity to recognize the remote host as the attacker and the MX or MTA that's acting as the incoming relay continues to receive mail from the attacking host. To work around this issue and continue receiving messages from the incoming relay, add the relay to a sender group with a mail flow policy that has unlimited messages for DHAP.

## Incoming Relays and Trace

Trace returns the Incoming Relay's IP Reputation Score in its results instead of the reputation score for the source IP address.

## Incoming Relays and Email Security Monitor (Reporting)

When using Incoming Relays:

- Email Security Monitor reports include data for both the external IP and the MX/MTA. For example, if an external machine (IP 7.8.9.1) sent 5 emails through the internal MX/MTA (IP 10.2.3.4), Mail Flow Summary will show 5 messages coming from IP 7.8.9.1 and 5 more coming from the internal relay MX/MTA (IP 10.2.3.5).
- The IP Reputation score is not reported correctly in the Email Security Monitor reports. Also, sender groups may not be resolved correctly.

## Incoming Relays and Message Tracking

When using Incoming Relays, the Message Tracking Details page displays the relay's IP address and the relay's IP Reputation Score for a message instead of the IP address and reputation score of the original external sender.

## Incoming Relays and Logging

In the following log example, the IP Reputation score for the sender is reported initially on line 1. Later, once the Incoming Relay is processed, the correct IP Reputation score is reported on line 5.

|   |                                                                                              |
|---|----------------------------------------------------------------------------------------------|
| 1 | Fri Apr 28 17:07:29 2006 Info: ICID 210158 ACCEPT SG UNKNOWNLIST match nx.domain IPR rfc1918 |
| 2 | Fri Apr 28 17:07:29 2006 Info: Start MID 201434 ICID 210158                                  |
| 3 | Fri Apr 28 17:07:29 2006 Info: MID 201434 ICID 210158 From: <joe@sender.com>                 |
| 4 | Fri Apr 28 17:07:29 2006 Info: MID 201434 ICID 210158 RID 0 To: <mary@example.com>           |

|    |                                                                                                                                    |
|----|------------------------------------------------------------------------------------------------------------------------------------|
| 5  | Fri Apr 28 17:07:29 2006 Info: MID 201434 IncomingRelay(senderdotcom): Header Received found, IP 192.192.108.1 being used, IPR 6.8 |
| 6  | Fri Apr 28 17:07:29 2006 Info: MID 201434 Message-ID '<7.0.1.0.2.20060428170643.0451be40@sender.com>'                              |
| 7  | Fri Apr 28 17:07:29 2006 Info: MID 201434 Subject 'That report...'                                                                 |
| 8  | Fri Apr 28 17:07:29 2006 Info: MID 201434 ready 2367 bytes from <joe@sender.com>                                                   |
| 9  | Fri Apr 28 17:07:29 2006 Info: MID 201434 matched all recipients for per-recipient policy DEFAULT in the inbound table             |
| 10 | Fri Apr 28 17:07:34 2006 Info: ICID 210158 close                                                                                   |
| 11 | Fri Apr 28 17:07:35 2006 Info: MID 201434 using engine: CASE spam negative                                                         |
| 12 | Fri Apr 28 17:07:35 2006 Info: MID 201434 antivirus negative                                                                       |
| 13 | Fri Apr 28 17:07:35 2006 Info: MID 201434 queued for delivery                                                                      |

### Incoming Relays and Mail Logs

The following example shows a typical log entry containing Incoming Relay information:

```
Wed Aug 17 11:20:41 2005 Info: MID 58298 IncomingRelay(myrelay): Header Received found, IP 192.168.230.120 being used
```

## Configuring Logs to Specify Which Headers Are Used

Your email gateway only examines the headers that were present when the message was received. So, additional headers added locally (such as Microsoft Exchange headers, etc.) or when the message is received by the email gateway are not processed. One way to help determine which headers are used is to configure AsyncOS logging to include the headers you use.

To configure logging settings for headers, see [Configuring Global Settings for Logging, on page 1215](#).

## Monitoring Rules Updates

Once you have accepted the license agreement, you can view the most recent Cisco Anti-Spam and Cisco Intelligent Multi-Scan rules updates.

### Procedure

- 
- Step 1** Select **Security Services > IronPort Anti-Spam**.
- or
- Step 2** Select **Security Services > IMS and Graymail**.
- Step 3** Look at the **Rule Updates** section and:



| To                                            | More Information                                                                                  |
|-----------------------------------------------|---------------------------------------------------------------------------------------------------|
| See the most recent update for each component | If an update has not occurred, or a server has not been configured, “Never Updated” is displayed. |
| See if an update is available                 | —                                                                                                 |
| Update rules if updates are available         | Click <b>Update Now</b> .                                                                         |

### What to do next

#### Related Topics

- [Service Updates](#) , on page 1029
- [Updates Through a Proxy Server](#), on page 1033
- [Configuring Server Settings for Downloading Upgrades and Updates](#) , on page 1034

## Testing Anti-Spam

| To                                  | Do This                                                                                                                                                                                                                             | More Information                                                                                                                                                                                                                                                                                                                                                                                                                                                                                                                                                                                                                                 |
|-------------------------------------|-------------------------------------------------------------------------------------------------------------------------------------------------------------------------------------------------------------------------------------|--------------------------------------------------------------------------------------------------------------------------------------------------------------------------------------------------------------------------------------------------------------------------------------------------------------------------------------------------------------------------------------------------------------------------------------------------------------------------------------------------------------------------------------------------------------------------------------------------------------------------------------------------|
| Test your configuration.            | <p>Test your configuration using the <code>X-advertisement: spam</code> header.</p> <p>For testing purposes, Cisco Anti-Spam considers any message with an X-header formatted as <code>X-Advertisement: spam to be spam</code>.</p> | <p>The test message you send with this header is flagged by Cisco Anti-Spam, and you can confirm that the actions you configured for the mail policy (<a href="#">Defining Anti-Spam Policies</a> , on page 395) are performed.</p> <p>Use this header with one of the following:</p> <ul style="list-style-type: none"> <li>• Use SMTP commands to send a test message with this header. See <a href="#">Sending an Email to the Email Gateway to Test Cisco Anti-Spam</a>, on page 418.</li> <li>• Use the trace command and include this header. See <a href="#">Debugging Mail Flow Using Test Messages: Trace</a>, on page 1255.</li> </ul> |
| Evaluate Anti-Spam engine efficacy. | Evaluate the product using a live mail stream directly from the Internet.                                                                                                                                                           | For a list of ineffective evaluation approaches that you should avoid, see <a href="#">Ways Not to Test Anti-Spam Efficacy</a> , on page 419.                                                                                                                                                                                                                                                                                                                                                                                                                                                                                                    |

#### Related Topics

- [Sending an Email to the Email Gateway to Test Cisco Anti-Spam](#), on page 418
- [Ways Not to Test Anti-Spam Efficacy](#), on page 419

## Sending an Email to the Email Gateway to Test Cisco Anti-Spam

### Before You Begin

Review the example in [Testing Anti-Spam Configuration: Example Using SMTP, on page 418](#).

### Procedure

---

- Step 1** Enable Cisco Anti-Spam on a mail policy.
- Step 2** Send a test email that includes the following header to a user in that mail policy: X-Advertisement: spam  
Use SMTP commands with Telnet to send this message to an address to which you have access.
- Step 3** Check the mailbox of the test account and confirm that the test message was correctly delivered based upon the actions you configured for the mail policy.

For example:

- Was the subject line altered?
- Was your additional custom header added?
- Was the message delivered to an alternate address?
- Was the message dropped?

### Related Topics

- [Testing Anti-Spam Configuration: Example Using SMTP, on page 418](#)
- 

## Testing Anti-Spam Configuration: Example Using SMTP

For this example, the mail policy must be configured to receive messages for the test address and the HAT must accept the test connection.

```
# telnet IP_address_of_IronPort_Appliance_with_IronPort_Anti-Spam port
220 hostname ESMTTP
helo example.com
250 hostname
mail from: <test@example.com>
250 sender <test@example.com> ok
rcpt to: <test@address>
250 recipient <test@address>
ok
data
354 go ahead
Subject: Spam Message Test
```

```
X-Advertisement: spam  
  
spam test  
  
.  
  
250 Message MID accepted  
  
221 hostname  
  
quit
```

## Ways Not to Test Anti-Spam Efficacy

Because IronPort AntiSpam and Cisco Intelligent Multi-Scan rules are added quickly to prevent active spam attacks and quickly expire once attacks have passed, you should not test efficacy using any of the following methods:

- Evaluating using resent or forwarded mail or cut-and-pasted spam messages.

Mail lacking the proper headers, connecting IP, signatures, etc. will result in inaccurate scores.

- Testing “hard spam” only.

Removing the “easy spam” using IP Reputation Service, blocked lists, message filters, etc. will result in a lower overall catch rate percentage.

- Resending spam caught by another anti-spam vendor.
- Testing older messages.

The scanning engine adds and removes rules rapidly based on current threats. Testing using old messages will therefore lead to inaccurate test results.





## CHAPTER 19

# Outbreak Filters

---

This chapter contains the following sections:

- [Overview of Outbreak Filters, on page 421](#)
- [How Outbreak Filters Work, on page 421](#)
- [How the Outbreak Filters Feature Works, on page 428](#)
- [Managing Outbreak Filters, on page 431](#)
- [Monitoring Outbreak Filters, on page 441](#)
- [Troubleshooting The Outbreak Filters Feature, on page 442](#)

## Overview of Outbreak Filters

Outbreak Filters protects your network from large-scale virus outbreaks and smaller, non-viral attacks, such as phishing scams and malware distribution, as they occur. Unlike most anti-malware security software, which cannot detect new outbreaks until data is collected and a software update is published, Cisco gathers data on outbreaks as they spread and sends updated information to your email gateway in real-time to prevent these messages from reaching your users.

Cisco uses global traffic patterns to develop rules that determine if an incoming message is safe or part of an outbreak. Messages that may be part of an outbreak are quarantined until they're determined to be safe based on updated outbreak information from Cisco or new anti-virus definitions are published by Sophos and McAfee.

Messages used in small-scale, non-viral attacks use a legitimate-looking design, the recipient's information, and custom URLs that point to phishing and malware websites that have been online only for a short period of time and are unknown to web security services. Outbreak Filters analyzes a message's content and searches for URL links to detect this type of non-viral attack. Outbreak Filters can rewrite URLs to redirect traffic to potentially harmful websites through a web security proxy, which either warns users that the website they are attempting to access may be malicious or blocks the website completely.

## How Outbreak Filters Work

### Related Topics

- [Delaying, Redirecting, and Modifying Messages, on page 422](#)
- [Threat Categories, on page 422](#)
- [Cisco Security Intelligence Operations, on page 423](#)

- [Context Adaptive Scanning Engine, on page 424](#)
- [Delaying Messages, on page 424](#)
- [Redirecting URLs, on page 425](#)
- [Modifying Messages, on page 426](#)
- [Types of Rules: Adaptive and Outbreak, on page 426](#)
- [Outbreaks, on page 427](#)
- [Threat Levels, on page 427](#)

## Delaying, Redirecting, and Modifying Messages

The Outbreak Filters feature uses three tactics to protect your users from outbreaks:

- **Delay.** Outbreak Filters quarantines messages that may be part of a virus outbreak or non-viral attack. While quarantined, the email gateway receives updated outbreak information and rescans the message to confirm whether it's part of an attack.



---

**Note** If a spam positive message is identified as outbreak positive by Outbreak Filters, the message is not sent to Outbreak Quarantine.

---

- **Redirect.** Outbreak Filters rewrites the URLs in non-viral attack messages to redirect the recipient through the Cisco web security proxy if they attempt to access any of the linked websites. The proxy displays a splash screen that warns the user that the website may contain malware, if the website is still operational, or displays an error message if the website has been taken offline. See [Redirecting URLs, on page 425](#) for more information on redirecting URLs.
- **Modify.** In addition to rewriting URLs in non-viral threat messages, Outbreak Filters can modify a message's subject and add a disclaimer above the message body to warn users about the message's content. See [Modifying Messages, on page 426](#) for more information.

## Threat Categories

The Outbreak Filters feature provides protection from two categories of message-based outbreaks: *virus outbreaks*, which are messages with never-before-seen viruses in their attachments, and *non-viral threats*, which includes phishing attempts, scams, and malware distribution through links to an external website.

By default, the Outbreak Filters feature scans your incoming and outgoing messages for possible viruses during an outbreak. You can enable scanning for non-viral threats in addition to virus outbreaks if you enable anti-spam scanning on the email gateway.



---

**Note** Your email gateway needs a feature key for Anti-Spam or Intelligent Multi-Scan in order for Outbreak Filters to scan for non-viral threats.

---

### Related Topics

- [Virus Outbreaks, on page 423](#)
- [Phishing, Malware Distribution, and Other Non-Viral Threats, on page 423](#)

## Virus Outbreaks

The Outbreak Filters feature provides you with a head start when battling virus outbreaks. An outbreak occurs when messages with attachments containing never-before-seen viruses or variants of existing viruses spread quickly through private networks and the Internet. As these new viruses or variants hit the Internet, the most critical period is the window of time between when the virus is released and when the anti-virus vendors release an updated virus definition. Having advanced notice — even a few hours — is vital to curbing the spread of the malware or virus. During that vulnerability window, the newly-found virus can propagate globally, bringing email infrastructure to a halt.

## Phishing, Malware Distribution, and Other Non-Viral Threats

Messages containing non-viral threats are designed to look like a message from a legitimate sources and often sent out to a small number of recipients. These messages may have one or more of the following characteristics in order to appear trustworthy:

- The recipient's contact information.
- HTML content designed to mimic emails from legitimate sources, such as social networks and online retailers.
- URLs pointing to websites that have new IP addresses and are online only for a short time, which means that email and web security services do not have enough information on the website to determine if it is malicious.
- URLs pointing to URL shortening services.

All of these characteristics make these messages more difficult to detect as spam. The Outbreak Filters feature provides a multi-layer defense from these non-viral threats to prevent your users from downloading malware or providing personal information to suspicious new websites.

If CASE discovers URLs in the message, it compares the message to existing Outbreak Rules to determine if the message is part of a small-scale non-viral outbreak and then assigns a threat level. Depending on the threat level, the email gateway delays delivery to the recipient until more threat data can be gathered and rewrites the URLs in the message to redirect the recipient to the Cisco web security proxy if they attempt to access the website. The proxy displays a splash page warning the user that the website may contain malware.

## Cisco Security Intelligence Operations

Cisco Security Intelligence Operations (SIO) is a security ecosystem that connects global threat information, reputation-based services, and sophisticated analysis to email gateways to provide stronger protection with faster response times.

SIO consists of three components:

- SenderBase. The world's largest threat monitoring network and vulnerability database.
- Threat Operations Center (TOC). A global team of security analysts and automated systems that extract actionable intelligence gathered by SenderBase.
- Dynamic Update. Real-time updates automatically delivered to email gateways as outbreaks occur.

SIO compares real-time data from the global SenderBase network to common traffic patterns to identify anomalies that are proven predictors of an outbreak. TOC reviews the data and issues a threat level of the possible outbreak. The email gateways download updated threat levels and Outbreak Rules and use them to scan incoming and outgoing messages, as well as messages already in the Outbreak quarantine.

Information about current virus outbreaks can be found on SenderBase's website here:

<http://www.senderbase.org/>

The SIO website provides a list of current non-viral threats, including spam, phishing, and malware distribution attempts:

<http://tools.cisco.com/security/center/home.x>

## Context Adaptive Scanning Engine

Outbreak Filters are powered by Cisco's unique Context Adaptive Scanning Engine (CASE). CASE leverages over 100,000 adaptive message attributes tuned automatically and on a regular basis, based on real-time analysis of messaging threats.

For virus outbreaks, CASE analyzes the message content, context and structure to accurately determine likely Adaptive Rule triggers. CASE combines Adaptive Rules and the real-time Outbreak Rules published by SIO to evaluate every message and assign a unique threat level.

To detect non-viral threats, CASE scans messages for URLs and uses Outbreak Rules from SIO to evaluate a message's threat level if one or more URLs are found.

Based on the message's threat level, CASE recommends a period of time to quarantine the message to prevent an outbreak. CASE also determines the rescan intervals so it can reevaluate the message based on updated Outbreak Rules from SIO. The higher the threat level, the more often it rescans the message while it is quarantined.

CASE also rescans messages when they're released from the quarantine. A message can be quarantined again if CASE determines that it is spam or contains a virus upon rescan.

For more information about CASE, see [Cisco Anti-Spam: an Overview](#), on page 382.

## Delaying Messages

The period between when an outbreak or email attack occurs and when software vendors release updated rules is when your network and your users are the most vulnerable. A modern virus can propagate globally and a malicious website can deliver malware or collect your users' sensitive information during this period. Outbreak Filters protects your users and network by quarantining suspect messages for a limited period of time, giving Cisco and other vendors time to investigate the new outbreak.

When a virus outbreak occurs, suspicious messages with attachments are quarantined until updated Outbreak Rules and new anti-virus signatures prove the email's attachment is clean or a virus.

Small scale, non-viral threats contain URLs to malicious websites that may be online for a short period of time in order to evade detection by web security services or through URL shortening services in order to circumvent web security by putting a trustworthy website in the middle. By quarantining messages containing URLs that meet your threat level threshold, not only does CASE have the opportunity to reevaluate the message's content based on updated Outbreak Rules from SIO, but the messages can remain in the quarantine long enough that the linked website may go offline or be blocked by a web security solution.

See [Dynamic Quarantine](#), on page 429 for more information on how Outbreak Filters quarantine suspicious messages.



## Redirecting URLs

When CASE scans a message at the Outbreak Filters stage, it searches for URLs in the message body in addition to other suspicious content. CASE uses published Outbreak Rules to evaluate whether the message is a threat and then scores the message with the appropriate threat level. Depending on the threat level, Outbreak Filters protects the recipient by rewriting all the URLs to redirect the recipient to the Cisco web security proxy, except for URLs pointing to bypassed domains, and delaying the delivery of the message in order for TOC to learn more about the website if it appears to be part of a larger outbreak. See [URL Rewriting and Bypassing Domains, on page 438](#) for more information on bypassing URLs for trusted domains.

After the email gateway releases and delivers the message, any attempt by the recipient to access the website is redirected through the Cisco web security proxy. This is an external proxy hosted by Cisco that displays a splash screen that warns the user that the website may be dangerous, if the website is still operational. If the website has been taken offline, the splash screen displays an error message.

If the recipient decides to click the message's URLs, the Cisco web security proxy displays a splash screen in the user's web browser to warn the user about the content of the message. The following figure shows an example of the splash screen warning. The recipient can either click **Ignore this warning** to continue on to the website or **Exit** to leave and safely close the browser window.

**Figure 29: Cisco Security Splash Screen Warning (proxy\_splash\_screen)**



The only way to access the Cisco web security proxy is through a rewritten URL in a message. You cannot access the proxy by typing a URL in your web browser.



**Note** You can customize the appearance of this splash screen and display your organization's branding such as company logo, contact information, and so on. See [Customizing the Notification That End Users See If a Site Is Malicious, on page 449](#).



**Tip** To redirect all URLs in suspected spam messages to the Cisco Web Security proxy service, see [Using Custom Headers to Redirect URLs in Suspected Spam to the Cisco Web Security Proxy: Configuration Example, on page 399](#).

## Modifying Messages

The Outbreak Filters feature modifies the message body of a non-viral threat message not only to rewrite the URLs but to alert the user that the message is a suspected threat. The Outbreak Filters feature can modify the subject header and add a disclaimer about the message's content above the message body. See [Message Modification, on page 436](#) for more information.

The threat disclaimer is created using the Disclaimer template through the Mail Policies > Text Resources page. See [Overview of Text Resource Management, on page 648](#) for more information.

## Types of Rules: Adaptive and Outbreak

Two types of rules are used by Outbreak Filters to detect potential outbreaks: Adaptive and Outbreak. The Outbreak Filters feature uses these two rule sets to provide the highest efficacy and the most focused set of criteria for threat detection to ensure that filters can be laser focused on a particular outbreak. The Outbreak Filters rules and actions are visible to the administrator, not hidden away behind the scenes, providing instant access to quarantined messages and the reason why they were quarantined.

### Related Topics

- [Adaptive Rules, on page 426](#)
- [Outbreak Rules, on page 426](#)

## Outbreak Rules

Outbreak Rules are generated by the Cisco Threat Operations Center (TOC), which is a part of the Cisco Security Intelligence Operations, and focus on the message as a whole, rather than just attachment filetypes. Outbreak Rules use SenderBase data (real time and historical traffic data) and any combination of message parameters such as attachment file type, file name keywords, or anti-virus engine update to recognize and prevent outbreaks in real time. Outbreak Rules are given a unique ID used to refer to the rule in various places in the GUI (such as the Outbreak quarantine).

Real-time data from the global SenderBase network is then compared to this baseline, identifying anomalies that are proven predictors of an outbreak. The TOC reviews the data and issues a threat indicator or Threat Level. The Threat Level is a numeric value between 0 (no threat) and 5 (extremely risky), and measures the likelihood that a message is a threat for which no other gateway defense is widely deployed by Cisco customers (for more information, see [Threat Levels, on page 427](#)). Threat Levels are published as Outbreak Rules by the TOC.

Some example characteristics that can be combined in Outbreak Rules include:

- File Type, File Type & Size, File Type & File Name Keyword, etc.
- File Name Keyword & File Size
- File Name Keyword
- Message URL
- File Name & Sophos IDE

## Adaptive Rules

Adaptive Rules are a set of rules within CASE that accurately compare message attributes to attributes of known virus outbreak messages. These rules have been created after studying known threat messages and known good messages within an extensive virus corpus. Adaptive Rules are updated often as the corpus is

evaluated. They complement existing Outbreak Rules to detect outbreak messages at all times. While Outbreak Rules take effect when a possible outbreak is occurring, Adaptive Rules (once enabled) are “always on,” catching outbreak messages locally before the full anomaly has formed on a global basis. Additionally, Adaptive Rules continuously respond to small and subtle changes in email traffic and structure, providing updated protection to customers.

## Outbreaks

A Outbreak Filter rule is basically a Threat Level (e.g. 4) associated with a set of characteristics for an email message and attachment — things such as file size, file type, file name, message content, and so on. For example, assume the Cisco SIO notices an increase in the occurrences of a suspicious email message carrying a .exe attachment that is 143 kilobytes in size, and whose file name includes a specific keyword (“hello” for example). An Outbreak Rule is published increasing the Threat Level for messages matching this criteria. Your email gateway checks for and downloads newly published Outbreak and Adaptive Rules every 5 minutes by default (see [Updating Outbreak Filter Rules, on page 434](#)). Adaptive Rules are updated less frequently than Outbreak Rules. On the email gateway, you set a threshold for quarantining suspicious messages. If the Threat Level for a message equals or exceeds the quarantine threshold, the message is sent to the *Outbreak* quarantine area. You can also set up a threshold for modifying non-viral threat messages to rewrite any URLs found in suspicious messages or add a notification at the top of message body.

## Threat Levels

The following table provides a basic set of guidelines or definitions for each of the various levels.

| Level | Risk       | Meaning                                                                                                                                |
|-------|------------|----------------------------------------------------------------------------------------------------------------------------------------|
| 0     | None       | There is no risk that the message is a threat.                                                                                         |
| 1     | Low        | The risk that the message is a threat is low.                                                                                          |
| 2     | Low/Medium | The risk that the message is a threat is low to medium. It is a “suspected” threat.                                                    |
| 3     | Medium     | Either the message is part of a confirmed outbreak or there is a medium to large risk of its content being a threat.                   |
| 4     | High       | Either the message is confirmed to be part of a large scale outbreak or its content is very dangerous.                                 |
| 5     | Extreme    | The message’s content is confirmed to part of an outbreak that is either extremely large scale or large scale and extremely dangerous. |

For more information about threat levels and outbreak rules, see [Outbreak Filters Rules, on page 434](#).

### Related Topics

- [Guidelines for Setting Your Quarantine Threat Level Threshold, on page 427](#)
- [Containers: Specific and Always Rules, on page 428](#)

## Guidelines for Setting Your Quarantine Threat Level Threshold

The quarantine threat level threshold allows administrators to be more or less aggressive in quarantining suspicious messages. A low setting (1 or 2) is more aggressive and will quarantine more messages; conversely,

a higher score (4 or 5) is less aggressive and will only quarantine messages with an extremely high likelihood of being malicious.

The same threshold applies to both virus outbreaks and non-virus threats, but you can specify different quarantine retention times for virus attacks and other threats. See [Dynamic Quarantine, on page 429](#) for more information.

Cisco recommends the default value of 3.

## Containers: Specific and Always Rules

Container files are files, such as zipped (.zip) archives, that contain other files. The TOC can publish rules that deal with specific files within archive files.

For example, if a virus outbreak is identified by TOC to consist of a .zip file containing a .exe, a specific Outbreak Rule is published that sets a threat level for .exe files within .zip files (.zip(exe)), but does not set a specific threat level for any other file type contained within .zip files (e.g. .txt files). A second rule (.zip(\*)) covers all other file types within that container file type. An Always rule for a container will always be used in a message's Threat Level calculation regardless of the types of files that are inside a container. An always rule will be published by the SIO if all such container types are known to be dangerous.

**Table 40: Fallback Rules and Threat Level Scores**

| Outbreak Rule | Threat Level | Description                                                                                           |
|---------------|--------------|-------------------------------------------------------------------------------------------------------|
| .zip(exe)     | 4            | This rule sets a threat level of 4 for .exe files within .zip files.                                  |
| .zip(doc)     | 0            | This rule sets a threat level of 0 for .doc files within .zip files.                                  |
| zip(*)        | 2            | This rule sets a threat level of 2 for all .zip files, regardless of the types of files they contain. |

## How the Outbreak Filters Feature Works

Email messages pass through a series of steps, the “email pipeline,” when being processed by your email gateway (for more information about the email pipeline, see [Understanding the Email Pipeline, on page 53](#)). As the messages proceed through the email pipeline, they are run through the anti-spam and anti-virus scanning engines if those engines are enabled for that mail policy. In other words, known spam or messages containing recognized viruses are not scanned by the Outbreak Filters feature because they will have already been removed from the mail stream — deleted, quarantined, etc. — based on your anti-spam and anti-virus settings. Messages that arrive at the Outbreak Filters feature have therefore been marked spam- and virus-free. Note that a message quarantined by Outbreak Filters may be marked as spam or containing a virus when it is released from the quarantine and rescanned by CASE, based on updated spam rules and virus definitions.



**Note** Messages that skip anti-spam and anti-virus scanning due to filters or the engines being disabled will still be scanned by Outbreak Filters.

### Related Topics

- [Message Scoring, on page 429](#)

- [Dynamic Quarantine, on page 429](#)

## Message Scoring

When a new virus attack or non-viral threat is released into the wild, no anti-virus or anti-spam software is able to recognize the threat yet, so this is where the Outbreak Filters feature can be invaluable. Incoming messages are scanned and scored by CASE using the published Outbreak and Adaptive Rules (see [Types of Rules: Adaptive and Outbreak, on page 426](#)). The message score corresponds with the message's threat level. Based on which, if any, rules the message matches, CASE assigns the corresponding threat level. If there is no associated threat level (the message does not match any rules), then the message is assigned a threat level of 0.

Once that calculation has been completed, the email gateway checks whether the threat level of that message meets or exceeds your quarantine or message modification threshold value and quarantines message or rewrites its URLs. If the threat level is below the thresholds, it will be passed along for further processing in the pipeline.

Additionally, CASE reevaluates existing quarantined messages against the latest rules to determine the latest threat level of a message. This ensures that only messages that have a threat level consistent with an outbreak message stay within the quarantine and messages that are no longer a threat flow out of the quarantine after an automatic reevaluation.

In the case of multiple scores for an outbreak message — one score from an Adaptive Rule (or the highest score if multiple Adaptive Rules apply), and another score from an Outbreak Rule (or the highest score if multiple Outbreak Rules apply) — intelligent algorithms are used to determine the final threat level.

It is possible to use the Outbreak Filters feature without having enabled anti-virus scanning on the email gateway. The two security services are designed to complement each other, but will also work separately. That said, if you do not enable anti-virus scanning on your email gateway, you will need to monitor your anti-virus vendor's updates and manually release or re-evaluate some messages in the Outbreak quarantine. When using Outbreak Filters without anti-virus scanning enabled, keep the following in mind:

- You should disable Adaptive Rules
- Messages will get quarantined by Outbreak Rules
- Messages will get released if the threat level is lowered or time expires

Downstream anti-virus vendors (desktops/groupware) may catch the message on release.



---

**Note** Anti-spam scanning needs to be enabled globally on an email gateway for the Outbreak Filters feature to scan for non-viral threats.

---

## Dynamic Quarantine

The Outbreak Filters feature's Outbreak quarantine is a temporary holding area used to store messages until they're confirmed to be threats or it's safe to deliver to users. (See [Outbreak Lifecycle and Rules Publishing, on page 430](#) for more information.) Quarantined messages can be released from the Outbreak quarantine in several ways. As new rules are downloaded, messages in the Outbreak quarantine are reevaluated based on a recommended rescan interval calculated by CASE. If the revised threat level of a message falls under the quarantine retention threshold, the message will automatically be released (regardless of the Outbreak quarantine's settings), thereby minimizing the time it spends in the quarantine. If new rules are published while messages are being re-evaluated, the rescan is restarted.

Please note that messages quarantined as virus attacks are not automatically released from the outbreak quarantine when new anti-virus signatures are available. New rules may or may not reference new anti-virus signatures; however, messages will not be released due to an anti-virus engine update unless an Outbreak Rule changes the threat level of the message to a score lower than your Threat Level Threshold.

Messages are also released from the Outbreak quarantine after CASE's recommended retention period has elapsed. CASE calculates the retention period based on the message's threat level. You can define separate maximum retention times for virus outbreaks and non-viral threats. If CASE's recommended retention time exceeds the maximum retention time for the threat type, the email gateway releases messages when the maximum retention time elapses. For viral messages the default maximum quarantine period is 1 day. The default period for quarantining non-viral threats is 4 hours. You can manually release messages from the quarantine.

The email gateway also releases messages when the quarantine is full and more messages are inserted (this is referred to as overflow). Overflow only occurs when the Outbreak quarantine is at 100% capacity, and a new message is added to the quarantine. At this point, messages are released in the following order of priority:

- Messages quarantined by Adaptive Rules (those scheduled to be released soonest are first)
- Messages quarantined by Outbreak Rules (those scheduled to be released soonest are first)

Overflow releases stop the moment the Outbreak quarantine is below 100% capacity. For more information about how quarantine overflow is handled, see [Retention Time for Messages in Quarantines](#), on page 926 and [Default Actions for Automatically Processed Quarantined Messages](#), on page 927.

Messages released from the Outbreak quarantine are scanned by the anti-virus and anti-spam engines again if they're enabled for the mail policy. If it is now marked as a known virus or spam, then it will be subject to your mail policy settings (including a possible second quarantining in the Virus quarantine or Spam quarantine). For more information, see [The Outbreak Filters Feature and the Outbreak Quarantine](#), on page 439.

Thus it is important to note that in a message's lifetime, it may actually be quarantined twice — once due to the Outbreak Filters feature, and once when it is released from the Outbreak quarantine. A message will not be subject to a second quarantine if the verdicts from each scan (prior to Outbreak Filters, and when released from the Outbreak quarantine) match. Also note that the Outbreak Filters feature does not take any final actions on messages. The Outbreak Filters feature will either quarantine a message (for further processing) or move the message along to the next step in the pipeline.

### Related Topics

- [Outbreak Lifecycle and Rules Publishing](#), on page 430

## Outbreak Lifecycle and Rules Publishing

Very early in a virus outbreak's life cycle, broader rules are used to quarantine messages. As more information becomes available, increasingly focused rules are published, narrowing the definition of what is quarantined. As the new rules are published, messages that are no longer considered possible virus messages are released from quarantine (messages in the outbreak quarantine are rescanned as new rules are published).

**Table 41: Example Rules for an Outbreak Lifecycle**

| Time | Rule Type                               | Rule Description                                                                                                     | Action                                                              |
|------|-----------------------------------------|----------------------------------------------------------------------------------------------------------------------|---------------------------------------------------------------------|
| T=0  | Adaptive Rule (based on past outbreaks) | A consolidated rule set based on over 100K message attributes, which analyzes message content, context and structure | Messages are automatically quarantined if they match Adaptive Rules |

| Time       | Rule Type     | Rule Description                                                                                      | Action                                                                                       |
|------------|---------------|-------------------------------------------------------------------------------------------------------|----------------------------------------------------------------------------------------------|
| T=5 min    | Outbreak Rule | Quarantine messages containing .zip (exe) files                                                       | Quarantine all attachments that are .zips containing a .exe                                  |
| T=10 min   | Outbreak Rule | Quarantine messages that have .zip (exe) files greater than 50 KB                                     | Any message with .zip (exe) files that are less than 50 KB would be released from quarantine |
| T=20 min   | Outbreak Rule | Quarantine messages that have .zip (exe) files between 50 to 55 KB, and have "Price" in the file name | Any message that does not match this criteria would be released from quarantine              |
| T=12 hours | Outbreak Rule | Scan against new signature                                                                            | All remaining messages are scanned against the latest anti-virus signature                   |

## Managing Outbreak Filters

Log in to the Graphical User Interface (GUI), select Security Services in the menu, and click Outbreak Filters.

Figure 30: Outbreak Filters Main Page

**Outbreak Filters**

**Outbreak Filters Overview**

|                               |         |
|-------------------------------|---------|
| Global Status:                | Enabled |
| Adaptive Rules:               | Enabled |
| Maximum Message Size to Scan: | 512K    |
| Receive Emailed Alerts:       | No      |

[Edit Global Settings...](#)

**Outbreak Filter Rules**

| Rule Updates         |               |                 |
|----------------------|---------------|-----------------|
| Rule Type            | Last Update   | Current Version |
| CASE Core Files      | Never Updated | 3.1.0-012       |
| CASE Utilities       | Never Updated | 3.1.0-012       |
| Virus Outbreak Rules | Never Updated | 20050718_000000 |

**Outbreak Filter Rules (higher number indicates greater risk. 1= lowest threat, 5= highest threat)**

| Threat Level | Rule ID          | Description                                                                                             |
|--------------|------------------|---------------------------------------------------------------------------------------------------------|
| 3            | OUTBREAK_0003427 | We are seeing unusual volume for file extension(s) pif. We are raising the Threat Level to 3. We wil... |
| 3            | OUTBREAK_0003428 | We are seeing unusual volume for file extension(s) exe. We are raising the Threat Level to 3. We wil... |
| 3            | OUTBREAK_0003429 | We are seeing unusual volume for file extension(s) zip(exe), zip:e(exe). We are raising the Threat L... |
| 3            | OUTBREAK_0003430 | We are seeing suspicious url(s) propagating through multiple sources. We are raising the Threat Leve... |
| 3            | OUTBREAK_0003431 | We are seeing suspicious url(s) propagating through multiple sources. We are raising the Threat Leve... |

Rules last updated: Wed May 25 22:36:12 2011

[Update Rules Now](#) [Clear Current Rules](#)

The Outbreak Filters page shows two sections: the Outbreak Filters Overview and a listing of current Outbreak Filter Rules (if any).

In the figure above, Outbreak Filters are enabled, Adaptive Scanning is enabled, and the maximum message size is set to 512k. To change these settings, click **Edit Global Settings**. For more information about editing Global Settings, see [Configuring Outbreak Filters Global Settings, on page 432](#).

The Outbreak Filter Rules section lists the time, date, and version of the latest update for various components (the rules engine as well as the rules themselves), as well as a listing of the current Outbreak Filter rules with threat level.

For more information about Outbreak Rules, see [Outbreak Filters Rules, on page 434](#).

### Related Topics

- [Configuring Outbreak Filters Global Settings, on page 432](#)
- [Outbreak Filters Rules, on page 434](#)
- [The Outbreak Filters Feature and Mail Policies, on page 434](#)
- [The Outbreak Filters Feature and the Outbreak Quarantine, on page 439](#)

## Configuring Outbreak Filters Global Settings

### Procedure

---

- Step 1** Click **Security Services > Outbreak Filters**.
- Step 2** Click **Edit Global Settings**.
- Step 3** Depending on your requirements, do the following:
- Enable Outbreak Filters globally
  - Enable Adaptive Rules scanning
  - Set a maximum size for files to scan (note that you are entering the size in *bytes* )
  - Enable alerts for the Outbreak Filter
  - Enable Web Interaction Tracking. See [Web Interaction Tracking , on page 447](#).
- Step 4** Submit and commit your changes.
- 

### What to do next

This functionality is also available via the `outbreakconfig` CLI command (see the CLI Reference Guide for AsyncOS for Cisco Secure Email Gateway). After you make your changes, submit and commit them.



**Note** You cannot enable the logging of URLs using the web interface. For instructions to enable logging of URLs using CLI, see [Enabling Logging of URLs and Message Tracking Details for URLs , on page 433](#)

---

### Related Topics

- [Enabling the Outbreak Filters Feature, on page 433](#)
- [Enabling Adaptive Rules, on page 433](#)
- [Enabling Alerts for Outbreak Filters, on page 433](#)
- [Enabling Logging of URLs and Message Tracking Details for URLs , on page 433](#)



## Enabling the Outbreak Filters Feature

To enable the Outbreak Filters feature globally, check the box next to Enable Outbreak Filters on the Outbreak Filters Global Settings page, and click **Submit**. You must have agreed to the Outbreak Filters license agreement first.

Once enabled globally, the Outbreak Filters feature can then be enabled or disabled individually for each incoming and outgoing mail policy, including the default policies. For more information, see [The Outbreak Filters Feature and Mail Policies, on page 434](#).

The Outbreak Filters feature uses the Context Adaptive Scanning Engine (CASE) to detect viral threats, regardless of whether anti-spam scanning is enabled, but you do need to have Anti-Spam or Intelligent Multi-Scan enabled globally on the email gateway to scan for non-viral threats.



---

**Note** If you have not already agreed to the license during system setup (see [Step 4: Security, on page 35](#)), you must click **Enable** on the Security Services > Outbreak Filters page, and then read and agree to the license.

---

## Enabling Adaptive Rules

Adaptive Scanning enables the use of Adaptive Rules in Outbreak Filters. A set of factors or traits (file size, etc.) are used to determine the likelihood of a message being part of an outbreak when no virus signature or spam criteria relating to the message's content is available. To enable Adaptive Scanning, check the box next to Enable Adaptive Rules on the Outbreak Filters Global Settings page, and click **Submit**.

## Enabling Alerts for Outbreak Filters

Check the box labeled “Emailed Alerts” to enable alerting for the Outbreak Filters feature. Enabling emailed alerts for Outbreak Filters merely enables the alerting engine to send alerts regarding Outbreak Filters. Specifying which alerts are sent and to which email addresses is configured via the Alerts page in the System Administration tab. For more information on configuring alerts for Outbreak Filters, see [Alerts, SNMP Traps, and Outbreak Filters, on page 441](#).

## Enabling Logging of URLs and Message Tracking Details for URLs

Logging of URL-related logs, and display of this information in Message Tracking details, is disabled by default. This includes the logs for the following events:

- Category of any URL in the message matches the URL category filters
- Reputation score of any URL in the message matches URL reputation filters
- Outbreak Filter rewrites any URL in the message

To enable logging of these events, use the `websecurityadvancedconfig` command in the CLI or go to **Security Services > URL Filtering** page in the web interface.

### Related Topics

- [Managing Outbreak Filter Rules, on page 434](#)

## Outbreak Filters Rules

Outbreak Rules are published by the Cisco Security Intelligence Operations and your email gateway checks for and downloads new outbreak rules every 5 minutes. You can change this update interval. See [Configuring Server Settings for Downloading Upgrades and Updates](#) , on page 1034 for more information.

### Related Topics

- [Managing Outbreak Filter Rules, on page 434](#)

## Managing Outbreak Filter Rules

Because the Outbreak Filters Rules are automatically downloaded for you, there really is no management needed on the part of the user.

However, if for some reason your email gateway is not able to reach Cisco's update servers for new rules over a period of time, it is possible that your locally-cached scores are no longer valid, i.e., if a known viral attachment type now has an update in the anti-virus software and/or is no longer a threat. At this time, you may wish to no longer quarantine messages with these characteristics.

You can manually download updated outbreak rules from Cisco's update servers by clicking **Update Rules Now**.



---

**Note** The **Update Rules Now** button does not “flush” all existing outbreak rules on the email gateway. It only replaces outbreak rules that have been updated. If there are no updates available on Cisco's update servers, then the email gateway will not download any outbreak rules when you click this button.

---

### Related Topics

- [Updating Outbreak Filter Rules, on page 434](#)

## Updating Outbreak Filter Rules

By default, your email gateway will attempt to download new Outbreak Filters rules every 5 minutes. You can change this interval via the Security Services > Service Updates page. For more information, see [Service Updates](#) , on page 1029.

## The Outbreak Filters Feature and Mail Policies

The Outbreak Filters feature has settings that can be set per mail policy. The Outbreak Filters feature can be enabled or disabled for each mail policy on the email gateway. Specific file extensions and domains can be exempted from processing by the Outbreak Filters feature, per mail policy. This functionality is also available via the policyconfig CLI command (see the CLI Reference Guide for AsyncOS for Cisco Secure Email Gateway).



---

**Note** Anti-Spam or Intelligent Multi-Scan scanning needs to be enabled globally on an email gateway for the Outbreak Filters feature to scan for non-viral threats.

---

To modify the Outbreak Filters feature settings for a specific mail policy, click the link in the Outbreak Filters column of the policy to change.

To enable and customize the Outbreak Filters feature for a particular mail policy, select **Enable Outbreak Filtering (Customize Settings)**.

You can configure the following Outbreak Filter settings for a mail policy:

- Quarantine threat level
- Maximum quarantine retention time
- Deliver non-viral threat messages immediately without adding them to quarantine
- File extension types for bypassing
- Message modification threshold
- Alter subject header using custom text and Outbreak Filter variables such as `$threat_verdict` , `$threat_category` , `$threat_type` , `$threat_description` , and `$threat_level` .
- Include the following email headers:
  - X-IronPort-Outbreak-Status
  - X-IronPort-Outbreak-Description
- Send the message to an alternate destination such as an email gateway or an exchange server.
- URL rewriting
- Threat disclaimer

Select **Enable Outbreak Filtering (Inherit Default mail policy settings)** to use the Outbreak Filters settings that are defined for the default mail policy. If the default mail policy has the Outbreak Filters feature enabled, all other mail policies use the same Outbreak Filter settings unless they are customized.

Once you have made your changes, commit your changes.

### Related Topics

- [Setting a Quarantine Level Threshold, on page 435](#)
- [Maximum Quarantine Retention, on page 435](#)
- [Bypassing File Extension Types, on page 436](#)
- [Message Modification, on page 436](#)

## Setting a Quarantine Level Threshold

Select a Quarantine Threat Level threshold for outbreak threats from the list. A smaller number means that you will be quarantining more messages, while a larger number results in fewer messages quarantined. Cisco recommends the default value of 3.

For more information, see [Guidelines for Setting Your Quarantine Threat Level Threshold, on page 427](#).

## Maximum Quarantine Retention

Specify the maximum amount of time that messages stay in the Outbreak Quarantine. You can specify different retention times for messages that may contain viral attachments and messages that may contain other threats, like phishing or malware links. For non-viral threats, check the **Deliver messages without adding them to quarantine** check box to deliver the messages immediately without adding them to quarantine.



---

**Note** You cannot quarantine non-viral threats unless you enable Message Modification for the policy.

---

CASE recommends a quarantine retention period when assigning the threat level to the message. The email gateway keeps the message quarantined for the length of time that CASE recommends unless it exceeds the maximum quarantine retention time for its threat type.

## Bypassing File Extension Types

You can modify a policy to bypass specific file types. Bypassed file extensions are not included when CASE calculates the threat level for the message; however, the attachments are still processed by the rest of the email security pipeline.

To bypass a file extension, click Bypass Attachment Scanning, select or type in a file extension, and click **Add Extension**. AsyncOS displays the extension type in the File Extensions to Bypass list.

To remove an extension from the list of bypassed extensions, click the trash can icon next to the extension in the File Extensions to Bypass list.

### Related Topics

- [Bypassing File Extensions: Container File Types, on page 436](#)

### Bypassing File Extensions: Container File Types

When bypassing file extensions, files within container files (a .doc file within a .zip, for example) are bypassed if the extension is in the list of extensions to bypass. For example, if you add .doc to the list of extensions to bypass, all .doc files, even those within container files are bypassed.

## Message Modification

Enable Message Modification if you want the email gateway to scan messages for non-viral threats, such as phishing attempts or links to malware websites.

Based on the message's threat level, AsyncOS can modify the message to rewrite all of the URLs to redirect the recipient through the Cisco web security proxy if they attempt to open the website from the message. The email gateway can also add a disclaimer to the message to alert the user that the message's content is suspicious or malicious.

You need to enable message modification in order to quarantine non-viral threat messages.

### Related Topics

- [Message Modification Threat Level, on page 437](#)
- [Message Subject, on page 437](#)
- [Outbreak Filters Email Headers, on page 437](#)
- [Alternate Destination Mail Host, on page 438](#)
- [URL Rewriting and Bypassing Domains, on page 438](#)
- [Threat Disclaimer, on page 438](#)

## Message Modification Threat Level

Select a Message Modification Threat Level threshold from the list. This setting determines whether to modify a message based on the threat level returned by CASE. A smaller number means that you will be modifying more messages, while a larger number results in fewer messages being modified. Cisco recommends the default value of 3.

## Message Subject

You can alter the text of the subject header on non-viral threat messages containing modified links to notify users that the message has been modified for their protection. Prepend or append the subject header with custom text, Outbreak Filter variables such as `$threat_verdict`, `$threat_category`, `$threat_type`, `$threat_description`, and `$threat_level`, or a combination of both. To insert variables, click **Insert Variables**, and select from the list of variables.

White space is not ignored in the Message Subject field. Add spaces after (if prepending) or before (if appending) the text you enter in this field to separate your added text from the original subject of the message. For example, add the text `[MODIFIED FOR PROTECTION]` with a few trailing spaces if you are prepending.



---

**Note** The Message Subject field only accepts US-ASCII characters.

---

## Outbreak Filters Email Headers

You can add the following additional headers to the message:

| Header                                 | Format                                                                                                                            | Example                                                                                                              | Options                                                                                                                                      |
|----------------------------------------|-----------------------------------------------------------------------------------------------------------------------------------|----------------------------------------------------------------------------------------------------------------------|----------------------------------------------------------------------------------------------------------------------------------------------|
| <b>X-IronPort-Outbreak-Status</b>      | X-IronPort-Outbreak-Status:<br><code>\$threat_verdict, level<br/>\$threat_level,<br/>\$threat_category -<br/>\$threat_type</code> | X-IronPort-Outbreak-Status: Yes, level 4, Phish - Password                                                           | <ul style="list-style-type: none"> <li>• Enable for all messages</li> <li>• Enable only for non-viral outbreak</li> <li>• Disable</li> </ul> |
| <b>X-IronPort-Outbreak-Description</b> | X-IronPort-Outbreak-Description:<br><code>\$threat_description</code>                                                             | X-IronPort-Outbreak-Description: It may trick victims into submitting their username and password on a fake website. | <ul style="list-style-type: none"> <li>• Enable</li> <li>• Disable</li> </ul>                                                                |



---

**Note** If you want to filter messages based on these headers, you must send the Outbreak Filter processed messages back to an email gateway (by configuring an alternate destination mail host), and scan them using a content filter that matches these headers.

---

## Alternate Destination Mail Host

If you want to perform a content filter-based scan on the Outbreak Filter processed messages, you must configure the Outbreak Filter to send the processed messages back to an email gateway. This is because, in the processing pipeline, the Outbreak Filter scan is performed after the content filter scan.

In the **Alternate Destination Mail Host** field, enter the IP address (IPv4 or IPv6) or the FQDN of the email gateway where you want to send the processed messages for further scans.

## URL Rewriting and Bypassing Domains

If the message's threat level exceeds the message modification threshold, the Outbreak Filters feature rewrites all URLs in the message to redirect the user to the Cisco web security proxy's splash page if they click on any of them. (See [Redirecting URLs, on page 425](#) for more information.) If the message's threat level exceeds the quarantine threshold, the appliance also quarantines the message. If a small scale, non-viral outbreak is in progress, quarantining the message gives TOC time to analyze any suspect websites linked from possible outbreak messages and determine whether the websites are malicious. CASE uses updated Outbreak Rules from SIO to rescan the message to determine if it is part of the outbreak. After the retention period expires, the email gateway releases the message from the quarantine.

AsyncOS rewrites all of the URLs inside a message except for the ones pointing to bypassed domains.

The following options are available for URL rewriting:

- **Enable only for unsigned messages.** This option allows AsyncOS to rewrite URLs in unsigned messages that meet or exceed the message modification threshold, but not signed messages. Cisco recommends using this setting for URL rewriting.



---

**Note** The email gateway may rewrite URLs in a DomainKeys/DKIM-signed message and invalidate the message's signature if a server or appliance on your network other than the email gateway is responsible for verifying the DomainKeys/DKIM signature.

The email gateway considers a message signed if it is encrypted using S/MIME or it contains an S/MIME signature.

---

- **Enable for all messages.** This option allows AsyncOS to rewrite URLs in all messages that meet or exceed the message modification threshold, including signed ones. If AsyncOS modifies a signed message, the signature becomes invalid.
- **Disable.** This option disables URL rewriting for Outbreak Filters.

You can modify a policy to exclude URLs to certain domains from modification. To bypass domains, enter the IPv4 address, IPv6 address, CIDR range, hostname, partial hostname or domain in the Bypass Domain Scanning field. Separate multiple entries using commas.

The Bypass Domain Scanning feature is similar to, but independent of, the global allowed list used by URL filtering. For more information about that allowed list, see [Creating Allowed Lists for URL Filtering , on page 448](#).

## Threat Disclaimer

The email gateway can append a disclaimer message above the heading of a suspicious message to warn the user of its content. This disclaimer can be in HTML or plain text, depending on the type of message.

Select the disclaimer text you want to use from the Threat Disclaimer list or click the Mail Policies > Text Resources link to create a new disclaimer using the Disclaimer Template. The Disclaimer Template includes variables for outbreak threat information. You can see a preview of the threat disclaimer by clicking Preview Disclaimer. For custom disclaimer messages, you can use variables to display the threat level, the type of threat, and a description of the threat in the message. For information on creating a disclaimer message, see [Overview of Text Resource Management, on page 648](#).

## The Outbreak Filters Feature and the Outbreak Quarantine

Messages quarantined by the Outbreak Filters feature are sent to the Outbreak quarantine. This quarantine functions like any other quarantine (for more information about working with quarantines, see [Policy, Virus, and Outbreak Quarantines, on page 923](#)) except that it has a “summary” view, useful for deleting or releasing all messages from the quarantine, based on the rule used to place the message in the quarantine (for Outbreak Rules, the Outbreak ID is shown, and for Adaptive Rules, a generic term is shown). For more information about the summary view, see [Outbreak Quarantine and the Manage by Rule Summary View, on page 440](#).

### Related Topics

- [Monitoring the Outbreak Quarantine, on page 439](#)
- [Outbreak Quarantine and the Manage by Rule Summary View, on page 440](#)

## Monitoring the Outbreak Quarantine

Though a properly configured quarantine requires little if any monitoring, it is a good idea to keep an eye on the Outbreak Quarantine, especially during and after virus outbreaks when legitimate messages may be delayed.

If a legitimate message is quarantined, one of the following occurs depending on the settings for the Outbreak quarantine:

- If the quarantine’s Default Action is set to Release, the message will be released when the retention time period expires or when the quarantine overflows. You can configure the Outbreak quarantine so that the following actions are performed on messages before they are released due to overflow: strip attachments, modify the subject, and add an X-Header. For more information about these actions, see [Default Actions for Automatically Processed Quarantined Messages , on page 927](#).
- If the quarantine’s Default Action is set to Delete, the message will be deleted when the retention time period expires, or when the quarantine overflows.
- Overflow occurs when the quarantine is full and more messages are added. In this case the messages closest to their expiration date (not necessarily the oldest messages) are released first, until enough room is available for the new messages. You can configure the Outbreak quarantine so that the following actions are performed on messages before they are released due to overflow: strip attachments, modify the subject, add an X-Header.

Because quarantined messages are rescanned whenever new rules are published, it is very likely that messages in the Outbreak quarantine will be released prior to the expiration time.

Still, it can be important to monitor the Outbreak quarantine if the Default Action is set to Delete. Cisco recommends most users to not set the default action to Delete. For more information about releasing messages from the Outbreak quarantine, or changing the Default Action for the Outbreak Quarantine, see [Default Actions for Automatically Processed Quarantined Messages , on page 927](#).

Conversely, if you have messages in your Outbreak quarantine that you would like to keep in the quarantine longer while you wait for a new rule update, for example, you can delay the expiration of those messages. Keep in mind that increasing the retention time for messages can cause the size of the quarantine to grow.



**Note** If anti-virus scanning is disabled globally (not via a mail policy) while a message is in the Outbreak quarantine, the message is not anti-virus scanned when it leaves the quarantine, even if anti-virus scanning is re-enabled prior to the message leaving the quarantine.



**Note** You can use the Outbreak Filters feature without having enabled anti-virus scanning on the email gateway. However, Outbreak Filters cannot scan for non-viral threats if anti-spam scanning is not enabled on the appliance.

## Outbreak Quarantine and the Manage by Rule Summary View

You can view the contents of the Outbreak quarantine by clicking on the name of the quarantine in the listing on the Monitor menu in the GUI. The Outbreak quarantine has an additional view as well, the Outbreak Quarantine Manage by Rule Summary link.

**Figure 31: The Outbreak Quarantine Manage by Rule Summary Link**

### Quarantines

| Quarantine                                           | Messages | Default Action                      | Status                               | Settings |
|------------------------------------------------------|----------|-------------------------------------|--------------------------------------|----------|
| Spam Quarantine                                      | 2565     | Retain 14 days then Delete          | <input type="text" value="2% Full"/> | Edit     |
| Outbreak<br><a href="#">[Manage by Rule Summary]</a> | 0        | Retention Varies<br>Action: Release | <input type="text" value="0% Full"/> | Edit     |
| Policy                                               | 0        | Retain 10 days then Delete          | <input type="text" value="0% Full"/> | Edit     |
| Virus                                                | 0        | Retain 30 days then Delete          | <input type="text" value="0% Full"/> | Edit     |

### Related Topics

- [Using the Summary View to Perform Message Actions on Messages in the Outbreak Quarantine Based on Rule ID.](#), on page 440

### Using the Summary View to Perform Message Actions on Messages in the Outbreak Quarantine Based on Rule ID.

Click on the Manage by Rule Summary link to see a listing of the contents of the Outbreak quarantine, grouped by rule ID:

**Figure 32: The Outbreak Quarantine Manage by Rule Summary View**

### Outbreak Quarantine Summary

| Manage by Rule Summary                                 |          |                    |                      |            |          |
|--------------------------------------------------------|----------|--------------------|----------------------|------------|----------|
| All <input type="checkbox"/>                           | Rule ID  | Number of messages | Average message size | Total size | Capacity |
| Select <input type="checkbox"/>                        | EXE_BAGL | 4                  | 16 KB                | 0.1 MB     | 0.0%     |
| <b>Totals</b>                                          |          | 4                  | 16 KB                |            |          |
| Select Action... <input type="button" value="Submit"/> |          |                    |                      |            |          |

From this view, you can choose to release, delete, or delay the exit for all messages pertaining to a specific outbreak or adaptive rule, rather than selecting individual messages. You can also search through or sort the listing.



This functionality is also available via the `quarantineconfig -> outbreakmanage` CLI command. For more information, see the CLI Reference Guide for AsyncOS for Cisco Secure Email Gateway.

## Monitoring Outbreak Filters

The email gateway includes several tools to monitor the performance and activity of the Outbreak Filters feature.

### Related Topics

- [Outbreak Filters Report, on page 441](#)
- [Outbreak Filters Overview and Rules Listing, on page 441](#)
- [Outbreak Quarantine, on page 441](#)
- [Alerts, SNMP Traps, and Outbreak Filters, on page 441](#)

## Outbreak Filters Report

The Outbreak Filters report to view the current status and configuration of Outbreak Filters on your email gateway as well as information about recent outbreaks and messages quarantined due to Outbreak Filters. View this information on the Monitor > Outbreak Filters page. For more information, see the “Email Security Monitor” chapter.

## Outbreak Filters Overview and Rules Listing

The overview and rules listing provide useful information about the current status of the Outbreak Filters feature. View this information via the Security Services > Outbreak Filters page.

## Outbreak Quarantine

Use the outbreak quarantine to monitor how many messages are being flagged by your Outbreak Filters threat level threshold. Also available is a listing of quarantined messages by rule. For information, see [Outbreak Quarantine and the Manage by Rule Summary View, on page 440](#) and [Policy, Virus, and Outbreak Quarantines, on page 923](#)

## Alerts, SNMP Traps, and Outbreak Filters

The Outbreak Filters feature supports two different types of notifications: regular AsyncOS alerts and SNMP traps.

SNMP traps are generated when a rule update fails. For more information about SNMP traps in AsyncOS, see the “Managing and Monitoring via the CLI” chapter.

AsyncOS has two types of alerts for the Outbreak Filter feature: size and rule

AsyncOS alerts are generated whenever the Outbreak quarantine’s size goes above 5, 50, 75, and 95 of the maximum size. The alert generated for the 95% threshold has a severity of CRITICAL, while the remaining alert thresholds are WARNING. Alerts are generated when the threshold is crossed as the quarantine size increases. Alerts are not generated when thresholds are crossed as the quarantine size decreases. For more information about alerts, see [Alerts, on page 1047](#).

AsyncOS also generates alerts when rules are published, the threshold changes, or when a problem occurs while updating rules or the CASE engine.

## Troubleshooting The Outbreak Filters Feature

This section provides some basic troubleshooting tips for the Outbreak Filters feature.

### Related Topics

- [Reporting Incorrectly Classified Messages to Cisco](#) , on page 442
- [Multiple Attachments and Bypassed Filetypes](#), on page 442
- [Message and Content Filters and the Email Pipeline](#), on page 442

## Reporting Incorrectly Classified Messages to Cisco

Use the checkbox on the Manage Quarantine page for the Outbreak quarantine to notify Cisco of misclassifications.

## Multiple Attachments and Bypassed Filetypes

Bypassed file types are only excluded if a message's only attachment is of that type, or in the case of multiple attachments, if the other attachments do not yet have existing rules. Otherwise the message is scanned.

## Message and Content Filters and the Email Pipeline

Message and content filters are applied to messages prior to scanning by Outbreak Filters. Filters can cause messages to skip or bypass the Outbreak Filters scanning.



## CHAPTER 20

# Protecting Against Malicious or Undesirable URLs

---

This chapter contains the following sections:

- [URL-Related Protections and Controls](#) , on page 443
- [Setting Up URL Filtering](#), on page 444
- [Taking Action Based on the Reputation or Category of URLs in Messages](#) , on page 450
- [Handling Unscannable Messages for URL Filtering](#), on page 454
- [Detecting Malicious URLs in Messages Using Content Filter](#), on page 455
- [Detecting Malicious URLs in Messages Using Message Filter](#), on page 456
- [Monitoring URL Filtering Results](#) , on page 457
- [Displaying URL Details in Message Tracking](#) , on page 457
- [Troubleshooting URL Filtering](#), on page 458
- [About URL Categories](#), on page 462

## URL-Related Protections and Controls

Control and protection against malicious or undesirable links is incorporated into the anti-spam, outbreak, content, and message filtering processes in the work queue. These controls:

- Increase the effectiveness of protection from malicious URLs in messages and attachments.

URL filtering is incorporated into Outbreak Filtering. This strengthened protection is useful even if your organization already has a Cisco Web Security Appliance or similar protection from web-based threats, because it blocks threats at the point of entry.

You can also use content or message filters to take action based on the Web Based Reputation Score (WBRS) of URLs in messages.



---

**Note** As a best practice, Cisco recommends rewriting URLs with a questionable, neutral, and favorable or unknown reputation to redirect them to the Cisco Web Security Proxy for click-time evaluation of their safety.

---

- Better identify spam

The email gateway uses the reputation and category of links in messages, in conjunction with other spam-identification algorithms, to help identify spam. For example, if a link in a message belongs to a marketing web site, the message is more likely to be a marketing message.

- Support enforcement of corporate acceptable use policies

The category of URLs (for example, Adult Content or Illegal Activities) can be used in conjunction with content and message filters to enforce corporate acceptable use policies.

- Allow you to identify users in your organization who most frequently clicked a URL in a message that has been rewritten for protection, as well as links that have most frequently been clicked.

### Related Topics

- [Which URLs Are Evaluated](#) , on page 444
- [Web Interaction Tracking Page](#), on page 852

## Which URLs Are Evaluated

URLs in incoming and outgoing messages (including attachments) are evaluated. Any valid string for a URL is evaluated, including strings with the following:

- http, https, or www
- domain or IP address
- port number preceded by a colon (:)
- uppercase or lowercase letters

When evaluating URLs to determine whether a message is spam, if necessary for load management, the system prioritizes screening of incoming messages over outgoing messages.

## Setting Up URL Filtering

- [Requirements for URL Filtering](#) , on page 444
- [Enable URL Filtering](#), on page 445
- [About the Connection to Talos Intelligence Services](#) , on page 446
- [Web Interaction Tracking](#) , on page 447
- [URL Filtering in Cluster Configurations](#), on page 448
- [Creating Allowed Lists for URL Filtering](#) , on page 448
- [Customizing the Notification That End Users See If a Site Is Malicious](#) , on page 449

## Requirements for URL Filtering

In addition to enabling URL filtering, you must enable other features depending on desired functionality.

For enhanced protection against spam:

- Anti-spam scanning must be enabled globally and per applicable mail policy. This can be either the IronPort Anti-Spam or the Intelligent Multi-Scan feature. See the anti-spam chapter.

For enhanced protection against malware:

- The Outbreak Filters feature must be enabled globally and per applicable mail policy. See the Outbreak Filters chapter.

To take action based on URL reputation, or to enforce acceptable use policies using message and content filters:

- The Outbreak Filters feature must be enabled globally. See the Outbreak Filters chapter.

## Enable URL Filtering

You can enable URL filtering using the **Security Services > URL Filtering** page in the web interface or the **websecurityconfig** command in CLI.

### Before You Begin

- Ensure that the requirements for the individual URL filtering features that you want to use have been met. See [Requirements for URL Filtering](#) , on page 444.
- (Optional) Create a list of URLs that you want all URL filtering functionalities to ignore. See [Creating Allowed Lists for URL Filtering](#) , on page 448.

### Procedure

- 
- Step 1** Select **Security Services > URL Filtering**.
- Step 2** Click **Enable**.
- Step 3** Select the **Enable URL Category and Reputation Filters** check box.
- Step 4** (Optional) If you have created a list of URLs to exempt from URL filtering when evaluating messages for spam and malware, and from all content and message filtering, select that list.
- This setting does not cause the message to bypass anti-spam or Outbreak Filters processing generally.
- Step 5** [Optional] Enable Web Interaction Tracking. See [Web Interaction Tracking](#) , on page 447.
- Step 6** [Optional] Click **Advanced Settings** and enter the required parameters described in the following table to configure advanced URL filtering settings:

| Parameter                                             | Description                                                                                                                                                                                                                                  |
|-------------------------------------------------------|----------------------------------------------------------------------------------------------------------------------------------------------------------------------------------------------------------------------------------------------|
| URL Lookup Timeout                                    | Enter the time taken for the URL to request the IP address for a certain domain name.                                                                                                                                                        |
| Maximum Number of URLs scanned in Message Body        | Enter the maximum number of URLs that you want the email gateway to scan in a message body                                                                                                                                                   |
| Maximum Number of URLs scanned in Message Attachments | Enter the maximum number of URLs that you want the email gateway to scan in message attachments.                                                                                                                                             |
| Rewrite URL text and HREF in Message                  | Select the <b>Yes</b> radio button if you want the entire rewritten URL to appear in the message body.<br><br>OR<br><br>Select the <b>No</b> radio button if you want the entire rewritten URL to only appear in the HREF for HTML messages. |

| Parameter   | Description                                                                                                                                                                                                                                                                                                                                                                                                                                                                                                                   |
|-------------|-------------------------------------------------------------------------------------------------------------------------------------------------------------------------------------------------------------------------------------------------------------------------------------------------------------------------------------------------------------------------------------------------------------------------------------------------------------------------------------------------------------------------------|
| URL Logging | <p>Select the <b>Enable</b> radio button if you want to display URL details in Mail Logs and Message Tracking.</p> <p>The URL details are logged in Mail Logs and Message Tracking based on any one of the following conditions:</p> <ul style="list-style-type: none"> <li>• Category of any URL in the message matches the URL category filters.</li> <li>• Reputation score of any URL in the message matches URL reputation filters.</li> <li>• Outbreak Filters (if enabled) rewrites any URL in the message.</li> </ul> |

**Step 7** Submit and commit your changes.

If you have met the applicable prerequisites, and you have already configured Outbreak Filters and Anti-Spam protection, then you do not need to make additional configurations to benefit from enhanced automatic detection of spam and malicious URLs.

---

**What to do next**

- To take action based on the reputation of URLs in messages, see [Taking Action Based on the Reputation or Category of URLs in Messages](#) , on page 450.
- To use URL categories in content and message filters, for example to enforce acceptable use policies, see [Taking Action Based on the Reputation or Category of URLs in Messages](#) , on page 450.
- To redirect all URLs in suspected spam messages to the Cisco Web Security proxy service, see [Using Custom Headers to Redirect URLs in Suspected Spam to the Cisco Web Security Proxy: Configuration Example](#) , on page 399.
- (Optional) To customize the appearance of end user notification page, see [Customizing the Notification That End Users See If a Site Is Malicious](#) , on page 449.
- Ensure that you receive alerts about issues related to this feature. See [Future URL Category Set Changes](#) , on page 475, the release notes for your AsyncOS release, and [Adding Alert Recipients](#), on page 1048.

## About the Connection to Talos Intelligence Services

URL reputation and category are provided by cloud-based Talos Intelligence Services.

The email gateway connects to the Talos Intelligence Services either directly or through a web proxy, using the port specified for URL filtering services in [Firewall Information, on page 1331](#) Communication is over HTTPS with mutual certificate authentication. Certificates are updated automatically (see [Service Updates , on page 1029.](#)) For additional information about required certificates, see the Release Notes available from the location specified in [Certificates for URL Filtering Features](#) , on page 447.

If an HTTP or HTTPS proxy has been configured on the **Security Services > Service Updates** page, the email gateway will use it when communicating with Talos Intelligence Services. For more information about using a proxy server, see [Configuring Server Settings for Downloading Upgrades and Updates](#) , on page 1034.



---

**Note** Certificates are not saved with a configuration file.

---

#### Related Topics

- [Certificates for URL Filtering Features](#) , on page 447
- [Alert: Beaker Connector: Error Fetching Enrollment Certificate](#) , on page 459
- [Alert: Beaker Connector: Certificate Is Invalid](#) , on page 459

## Certificates for URL Filtering Features

AsyncOS is designed to automatically deploy and update the certificates needed for communications with cloud services used for URL filtering features. However, if for any reason the system is unable to update these certificates, you will receive an alert that requires action from you.

Ensure that the email gateway is configured to send you these alerts (System type, Warning severity). For instructions, see [Alerts](#), on page 1047.

If you receive an alert about an invalid certificate, contact Cisco TAC, which can provide the required replacement certificate. For instructions to use the replacement certificate, see [Manually Configuring a Certificate for Communication with Talos Intelligence Services](#) , on page 462.

## Web Interaction Tracking

The web interaction tracking feature provides information about the end users who clicked on rewritten URLs and the action (allowed, blocked, or unknown) associated with each user click. Once you enable this feature, you can use the Web Interaction Tracking report to view information such as top malicious URLs clicked, top users who clicked on malicious URLs, and so on. For more information about the Web Interaction Tracking report, see [Web Interaction Tracking Page](#), on page 852.

Web Interaction Tracking data is provided by a cloud-based Cisco Aggregator Server.

#### Related Topics

- [Configuring Web Interaction Tracking](#), on page 447
- [About the Connection to Cisco Aggregator Server](#), on page 447

## Configuring Web Interaction Tracking

Depending on your requirements, you can enable web interaction tracking on one of the global settings pages:

- **Outbreak Filters.** Track end users who clicked URLs rewritten by Outbreak Filters. See [Configuring Outbreak Filters Global Settings](#), on page 432.
- **URL Filtering.** Track end users who clicked URLs rewritten by policies (using content and message filters). See [Enable URL Filtering](#), on page 445.

## About the Connection to Cisco Aggregator Server

The email gateway connects to the Cisco Aggregator Server every 30 minutes (non-configurable), either directly or through a web proxy, using the port specified for URL filtering services in [Firewall Information](#),

on page 1331 Communication is over HTTPS with mutual certificate authentication. Certificates are updated automatically (see [Service Updates](#) , on page 1029.)

If an HTTP or HTTPS proxy has been configured on the **Security Services > Service Updates** page, the email gateway will use it when communicating with the Cisco Aggregator Server. For more information about using a proxy server, see [Configuring Server Settings for Downloading Upgrades and Updates](#) , on page 1034.



---

**Note** Certificates are not saved with a configuration file.

---

## URL Filtering in Cluster Configurations

- You can enable URL filtering at the machine, group or cluster level.
- If URL filtering is enabled at machine level, URL allowed lists and web interaction tracking can be configured at machine, group or cluster level.
- If URL filtering is enabled at group level, URL allowed lists and web interaction tracking must be configured at group or cluster level.
- If URL filtering is enabled at cluster level, URL allowed lists and web interaction tracking must be configured at cluster level.
- The standard rules for clusters for Message Filters and Content Filters apply.

## Creating Allowed Lists for URL Filtering

If you specify a global allowed list when configuring the URL Filtering feature, then URLs on the allowed list are not evaluated for reputation or category, for anti-spam, Outbreak Filtering, or content and message filtering. However, the messages that contain these URLs are evaluated as usual by anti-spam scanning and Outbreak Filters. You can also specify a URL allowed list in each URL Filtering condition (rule) and action in content and message filters, to supplement the global URL allowed list.

To categorize allowed list URLs from Outbreak Filtering generally, use the Bypass Domain Scanning option that you configure on the Mail Policies: Outbreak Filters page. URL allowed lists for URL filtering are similar to, but independent of, Bypass Domain Scanning. For more information about that feature, see [URL Rewriting and Bypassing Domains](#), on page 438.

There is no relationship between URL filtering allowed lists described in this section and the allowed list used for sender reputation filtering based on IP Reputation score.

### Before You Begin

Consider importing a list of URLs instead of creating one in the web interface. See [Importing a URL List](#) , on page 449.

### Procedure

---

**Step 1** Select **Mail Policies > URL Lists**.

**Step 2** Select **Add URL List** or click a list to edit.

Be sure all URLs that you want to designate globally as an allowed list are in a single list. You can select only one global allowed list for URL filtering.



**Step 3** Create and submit the URL list.

To view a list of supported URL formats, enter a semicolon (;) into the **URLs** box and click **Submit**. Then click the **more...** link that appears.

Each URL, domain, or IP address can be on a separate line, or separate each with a comma.

**Step 4** Commit your changes.

---

#### What to do next

- To designate a URL list as the global allowed list, see [Enable URL Filtering, on page 445](#).
- To designate a URL list as the allowed list for a specific condition (rule) or action in a content or message filter, see [Taking Action Based on the Reputation or Category of URLs in Messages, on page 450](#) and [Content Filter Actions, on page 278](#). For message filters, see also [URL Category Actions, on page 213](#) and [URL Category Rule, on page 176](#).

#### Related Topics

- [Importing a URL List, on page 449](#)

## Importing a URL List

You can import a URL list to use as a allowed list for URL filtering.

#### Procedure

---

**Step 1** Create the text file to import:

- The first line must be the name of the URL list.
- Each URL must be on a separate line.

**Step 2** Upload the file to the `/configuration` directory on the appliance.

**Step 3** Use the `urllistconfig > new` command in the command-line interface.

---

## Customizing the Notification That End Users See If a Site Is Malicious

If an end user clicks a malicious URL identified by Outbreak Filtering or a Policy (using Content or Message Filters), the Cisco Web Security proxy displays a notification in the end user's web browser. This notification states that the site is malicious and access to it has been blocked.

When an end user clicks on a URL rewritten using Outbreak Filtering, the notification page is displayed for 10 seconds and then is redirected to the Cisco Web Security proxy for click-time evaluation.

You can customize the appearance of this notification page and display your organization's branding such as company logo, contact information, and so on.



---

**Note** If you do not customize the notification page, end users see a Cisco branded notification page.

---

### Before You Begin

- Enable URL filtering. See [Enable URL Filtering, on page 445](#).

### Procedure

---

**Step 1** Select **Security Services > Block Page Customization**.

**Step 2** Click **Enable**.

**Step 3** Check the **Enable Block Page customization** check box and enter the following details:

- URL of the organization's logo. It is recommended that the logo image is hosted on a publicly accessible server.
- Organization's name
- Organization's contact information

**Step 4** Choose the language of the notification. You can choose any one of the languages supported by the web interface.

**Note** The default language of the end user's browser takes precedence over the language you have selected here. Also, if the default language of the end user's browser is not supported by AsyncOS, then the notification is displayed in the language you have selected here.

**Step 5** (Optional) Preview the notification page by clicking **Preview Block Page Customization** link.

**Step 6** Submit and commit your changes.

### Next Steps

Set up URL rewriting in one of the following ways:

- Using Outbreak Filters. See [Redirecting URLs, on page 425](#).
  - Using Content or Message Filters. See [Taking Action Based on the Reputation or Category of URLs in Messages, on page 450](#).
- 

## Taking Action Based on the Reputation or Category of URLs in Messages

You can take action based on the reputation or category of URL links in the message body or message attachment using message filters and content filters in incoming and outgoing mail policies.

Because Outbreak Filters take many factors into consideration when evaluating messages for malware, and URL reputation alone may not trigger aggressive message handling, you may want to create filters based on URL reputation.

For example, you can use URL Reputation filters to:

- (For URLs in message body only) Rewrite URLs of neutral or unknown reputation to redirect them to the Cisco cloud Web Security proxy service for click-time evaluation.
- Drop messages that include URLs that have reputation scores in the Untrusted range.

You can use URL Category filters to:

- Filter categories of URLs to enforce organizational policies for acceptable web use, for example to prevent users from visiting adult or gambling sites while at the office.
- Provide enhanced protection from malicious sites, which may not exist long enough to be classified. (For URLs in message body only) You can redirect all URLs in the Unclassified category to the Cisco cloud Web Security proxy service for evaluation at the time a user clicks a link.

### Related Topics

- [Using URL-Related Conditions \(Rules\) and Actions](#) , on page 451
- [Filtering by URL Reputation or URL Category: Conditions and Rules](#) , on page 451
- [Modifying URLs in Messages: Using URL Reputation and URL Category Actions in Filters](#) , on page 452
- [Redirected URLs: What Does the End User Experience?](#) , on page 454

## Using URL-Related Conditions (Rules) and Actions

| To                                                                                  | Example                                                                     | Do This                                                                                                                                                                                                                            |
|-------------------------------------------------------------------------------------|-----------------------------------------------------------------------------|------------------------------------------------------------------------------------------------------------------------------------------------------------------------------------------------------------------------------------|
| Take action on the message as a whole.                                              | Drop or quarantine messages.                                                | Create a URL Reputation or URL Category condition or rule, then pair it with any action other than a URL Reputation or URL Category action.<br><br>Exception: Do not pair a URL Reputation condition or rule with a Bounce action. |
| (For URLs in message body only) Modify URLs in a message, or modify their behavior. | Replace a URL in the message with a text note, or make the URL unclickable. | Create a URL Reputation or URL Category action only; do not use a separate URL filtering condition.                                                                                                                                |

As always, you must specify a content filter in a mail policy in order to use it.

### Related Topics

- [Filtering by URL Reputation or URL Category: Conditions and Rules](#) , on page 451
- [Modifying URLs in Messages: Using URL Reputation and URL Category Actions in Filters](#) , on page 452

## Filtering by URL Reputation or URL Category: Conditions and Rules

You can perform actions on messages based on the reputation or category of URLs in the message body and message attachments. If you want to perform any action other than modifying URLs or their behavior, add a **URL Reputation** or **URL Category** condition and select the reputation scores or URL categories for which you want to apply the action.

For example, if you want to apply the **Drop (Final Action)** action to all messages that include URLs in the Adult category, add a condition of type **URL Category** with the **Adult** category selected.

If you do not specify a category, the action you choose is applied to all messages.

URL reputation score ranges for trusted, neutral, and untrusted URLs are predefined and not editable. However, you can specify a custom range instead. The specified endpoints are included in the range you specify. For example, if you create a custom range from -8 to -10, then -8 and -10 are included in the range. Use "Unknown" for URLs for which a reputation score cannot be determined.



---

**Note** Neutral URL reputation means that URLs are currently clean, but may turn malicious in future, as they are prone to attacks. For such URLs, administrators can create non-blocking policies, for example, redirecting them to the Cisco Web Security Proxy for click-time evaluation.

---

URLs that are included on the selected URL allowed list or on the global URL allowed list not evaluated.

The action that you pair with this condition is taken if any URL in the message matches the reputation score or any category specified in the condition.

If you want to modify URLs in a message, or modify their behavior, configure only a URL Reputation or URL Category action. You do not need a separate URL Reputation or URL Category condition or rule for this purpose.



---

**Note** Do not pair a URL Reputation condition with a Bounce action.

---



---

**Tip** To check the category of a particular URL, visit the link in [Reporting Uncategorized and Misclassified URLs](#), on page 475.

---

#### Related Topics

- [Creating Allowed Lists for URL Filtering](#), on page 448
- [Content Filters](#), on page 269

## Modifying URLs in Messages: Using URL Reputation and URL Category Actions in Filters

Use a URL Reputation or URL Category action to modify URLs in a message, or their behavior, based on the reputation or category of the URL.

URL Reputation and URL Category actions do not require a separate condition. Instead, the selected action is applied based on the reputation or categories that you select in the URL Reputation or URL Category action.

The action is applied only to URLs that meet the criteria specified in the action. Other URLs in the message are not modified.

If you do not specify a category, the action you choose is applied to all messages.

URL reputation score ranges for trusted, neutral, and untrusted URLs are predefined and not editable. However, you can specify a custom range instead. The specified endpoints are included in the range you specify. For example, if you create a custom range from -8 to -10, then -8 and -10 are included in the range. Use “Unknown” for URLs for which a reputation score cannot be determined.



---

**Note** Neutral URL reputation means that URLs are currently clean, but may turn malicious in future, as they are prone to attacks. For such URLs, administrators can create non-blocking policies, for example, redirecting them to the Cisco Web Security Proxy for click-time evaluation.

---

The following URL-related actions are only applicable for URLs in the message body::

- Defang a URL so that it is unclickable. Message recipients can still see and copy the URL.
- Redirect a URL so that if the message recipient clicks the link, the transaction is routed to a Cisco web security proxy in the cloud, which blocks access if the site is malicious.

Example: You might want to redirect all URLs in the **Uncategorized** category to the Cisco Cloud Web Security proxy service, as malicious sites used in phishing attacks often do not exist long enough to be classified.

See also [Redirected URLs: What Does the End User Experience?](#), on page 454.

To redirect URLs to a different proxy, see the example in the following bullet.



---

**Note** The Cisco Cloud Web Security proxy service has no configurable options in this release. For example, there is no threat score threshold to adjust or action to specify based on threat score.

---

- Replace the URL with any text.

To include the original URL in the text that appears in the message, use the \$URL variable.

Examples:

- Replace all URLs in the **Illegal Downloads** category with a note:

```
Message from your system administrator: A link to an illegal downloads web site has
been removed from this message.
```

- Include the original URL along with a warning:

```
WARNING! The following URL may contain malware: $URL
```

This becomes: WARNING: The following URL may contain malware: http://example.com.

- Redirect to a custom proxy or web security service:

```
http://custom_proxy/$URL
```

This becomes: http://custom\_proxy/http://example.com

The reputation and category of URLs that are included on the selected URL allowed list or on the global URL allowed list are not evaluated.

If you defang or replace URLs, you can choose to ignore URLs in signed messages.

Pairing a URL Reputation or URL Category action with a URL Reputation or URL Category condition (or rule) is not recommended. If you pair a condition (rule) and action that include different categories, then no match occurs.



---

**Tip** To check the category of a particular URL, visit the link in [Reporting Uncategorized and Misclassified URLs](#) , on page 475.

---

#### Related Topics

- [Creating Allowed Lists for URL Filtering](#) , on page 448
- [Using Custom Headers to Redirect URLs in Suspected Spam to the Cisco Web Security Proxy: Configuration Example](#) , on page 399
- [Content Filters](#), on page 269
- [URL Reputation Rules](#) , on page 175
- [URL Category Rule](#) , on page 176

## Redirected URLs: What Does the End User Experience?

Based on the evaluation by the Cisco Cloud Web Security proxy service:

- If the site is benign, the user is directed to the target web site and has no knowledge that the link has been redirected.
- If the site is malicious, the user sees a notice that the site is malicious and access to it has been blocked.

You can customize the appearance of end user notification page and display your organization's branding such as company logo, contact information, and so on. See [Customizing the Notification That End Users See If a Site Is Malicious](#) , on page 449.

- If communication with the Cisco Cloud Web Security proxy service times out, the user is allowed to access the target web site.
- If any other error occurs, the user sees a notice.

#### Related Topics

- [Modifying URLs in Messages: Using URL Reputation and URL Category Actions in Filters](#) , on page 452

## Handling Unscannable Messages for URL Filtering

In the following scenarios, the URL filtering scanning fails, and the following header - *X-URL-LookUp-ScanningError* is added to the message:

- Unable to obtain the URL Reputation and Category
- Unable to expand the shortened URLs in the message
- Number of URLs in the message body or message attachments exceeds the maximum URL scan limit

You can add a content filter, select the *X-URL-LookUp-ScanningError* header in the Other Header condition, and configure appropriate actions to take on the message.

# Detecting Malicious URLs in Messages Using Content Filter

Use the 'URL Reputation' content filter to detect URLs in messages categorized as malicious by the ETF engine and take appropriate actions on such messages.

You can configure the 'URL Reputation' content filter for ETF in any one of the following ways:

- Use the 'URL Reputation' condition with any appropriate action.
- Use the 'URL Reputation' action with any or no condition.
- Use the 'URL Reputation' condition and action.

The following procedure is used to detect malicious URLs using the 'URL Reputation' condition and action:



---

**Note**

- If you only want to use the 'URL Reputation' condition with any appropriate action, do not follow steps 11-20 of the procedure.
  - If you only want to use the 'URL Reputation' action with any or no condition., do not follow steps 4-10 of the procedure.
- 

**Before you begin**

- Make sure that you enable URL filtering on your email gateway. To enable URL filtering, go to *Security Services > URL Filtering* page in the web interface. For more information, see [Protecting Against Malicious or Undesirable URLs, on page 443](#).
- Make sure that you enable Outbreak Filters on your email gateway. To enable Outbreak Filters, go to *Security Services > Outbreak Filters* page in the web interface. For more information, see [Outbreak Filters, on page 421](#).
- Make sure that you enable Anti-Spam engine on your email gateway. To enable the Anti-Spam engine, go to *Security Services > Anti-Spam* page in the web interface. For more information, see [Managing Spam and Graymail, on page 379](#).
- (Optional) Create a URL list. To create one, go to *Mail Policies > URL Lists* page in the web interface. For more information, see [Protecting Against Malicious or Undesirable URLs, on page 443](#).

**Procedure**

---

- Step 1** Go to **Mail Policies > Incoming Content Filters**.
- Step 2** Click **Add Filter**.
- Step 3** Enter a name and description for the content filter.
- Step 4** Click **Add Condition**.
- Step 5** Click **URL Reputation**.
- Step 6** Select **External Threat Feeds**.
- Step 7** Select the ETF source(s) to detect malicious URLs.

- Step 8** (Optional) Select the list of allow listed URLs that you do not want the email gateway to detect for threats.
- Step 9** Select the required **Check URLs within** option to detect malicious URLs in the message body and subject and/or message attachments.
- Step 10** Click **OK**.
- Step 11** Click **Add Action**.
- Step 12** Click **URL Reputation**.
- Step 13** Select **External Threat Feeds**.
- Step 14** Make sure that you select the same ETF source(s) that you selected in the condition (Step 7).
- Step 15** (Optional) Select the same list of allow listed URLs that you selected in Step 8.
- Step 16** Select the required **Check URLs within** option to detect malicious URLs in the 'message body and subject' and/or 'message attachments'
- Step 17** Select the required action that you want to perform on the URLs within the message body and subject and/or message attachments.
- Note** In Step 16, if you choose the 'Check URLs within' option as 'Attachments', you can only strip the attachment from the message.
- Step 18** Select whether you want to take actions on all messages or unsigned messages.
- Step 19** Click **OK**.
- Step 20** Submit and commit your changes.
- Note** If you have configured URL Reputation content filters for Web Based Reputation Score (WBR) and ETF on your email gateway, it is recommended to set the order of the WBR URL Reputation content filter higher than the order of the ETF URL Reputation filter, to improve the performance of your email gateway.

## Detecting Malicious URLs in Messages Using Message Filter

As an example, use the 'URL Reputation' message filter rule syntax to detect malicious URLs in messages using the ETF engine, and to defang the URL.

### Syntax:

```
defang_url_in_message: if (url-external-threat-feeds (['etf_source1'],
<'URL_allowedlist'>,
<'message_attachments'> , <'message_body_subject'> ,))
{ url-etf-defang(['etf_source1'], "", 0); } <'URL_allowedlist'> ,
<'Preserve_signed'>}
```

### Where

- 'url-external-threat-feeds' is the URL Reputation rule.
- 'etf\_source1' is the ETF source(s) used to detect malicious URLs in the messages or message attachments.
- 'URL\_allowedlist' is the name of a URL allowed list. If a URL allowed list is not present, it is displayed as "".



- `'message_attachments'` is used to check for malicious URLs in the message attachments. A value of '1' is used to detect malicious URLs in the message attachments.
- `'message_body_subject'` is used to check for malicious URLs in the message body and subject. A value of '1' is used to detect malicious URLs in the message body and subject.



---

**Note** A value of “1,1” is used to detect malicious URLs in the message body, subject, and message attachments.

---

- `'url-etf-defang'` is one of the actions that you can take on messages that contain malicious URLs. The following examples are the ETF-based actions that you can apply on messages that contain malicious URLs:
  - `url-etf-strip(['etf_source1'], "None", 1)`
  - `url-etf-defang-strip(['etf_source1'], "None", 1, "Attachment removed")`
  - `url-etf-defang-strip(['etf_source1'], "None", 1)`
  - `url-etf-proxy-redirect(['etf_source1'], "None", 1)`
  - `url-etf-proxy-redirect-strip(['etf_source1'], "None", 1)`
  - `url-etf-proxy-redirect-strip(['etf_source1'], "None", 1, " Attachment removed")`
  - `url-etf-replace(['etf_source1'], "", "None", 1)`
  - `url-etf-replace(['etf_source1'], "URL removed", "None", 1)`
  - `url-etf-replace-strip(['etf_source1'], "URL removed ", "None", 1)`
  - `url-etf-replace-strip(['etf_source1'], "URL removed*", "None", 1, "Attachment removed")`
- `'Preserve_signed'` is represented by '1' or '0'. '1' indicates that this action applies to unsigned messages only and '0' indicates that this action applies to all messages.

In the following example, if a URL in the message attachment is detected as malicious by the ETF engine, the attachment is stripped.

```
Strip_Malicious_URLs: if (true) {url-etf-strip(['threat_feed_source'], "", 0);}
```

## Monitoring URL Filtering Results

To view data about malicious and neutral URLs detected, select **Monitor > URL Filtering**. For important information about the data on this page, see [URL Filtering Page](#), on page 851.

## Displaying URL Details in Message Tracking

To display details in Message Tracking for URLs caught by outbreak filters and relevant content filters:

- Message Tracking must be enabled.

- Outbreak filters and/or content filters based on URL reputation or URL Category must be operational.
- For outbreak filters, URL Rewriting must be enabled. See [URL Rewriting and Bypassing Domains](#), on page 438.
- URL logging must be enabled. See [Enabling Logging of URLs and Message Tracking Details for URLs](#), on page 433.

For more information about the data displayed, see [Message Tracking Details](#), on page 918.

To manage administrative user access to these potentially sensitive details, see [Controlling Access to Sensitive Information in Message Tracking](#), on page 977.

## Troubleshooting URL Filtering

### Related Topics

- [Viewing Logs](#), on page 458
- [Alert: Beaker Connector: Error Fetching Enrollment Certificate](#), on page 459
- [Alert: Beaker Connector: Certificate Is Invalid](#), on page 459
- [Unable to Connect to Talos Intelligence Services](#), on page 459
- [Alert: Unable to Connect to the Cisco Aggregator Server](#), on page 460
- [Alert: Unable to Retrieve Web Interaction Tracking Information from the Cisco Aggregator Server](#), on page 460
- [Using the websecurityadvancedconfig Command](#), on page 460
- [Message Tracking Search Does Not Find Messages with Specified Category](#), on page 460
- [Malicious URLs and Marketing Messages Are Not Caught by Anti-Spam or Outbreak Filters](#), on page 461
- [URLs in a Filtered Category Are Not Handled Correctly](#), on page 461
- [End User Reaches Malicious Site via Rewritten URL](#), on page 461
- [Manually Configuring a Certificate for Communication with Talos Intelligence Services](#), on page 462

## Viewing Logs

URL filtering information is posted to the following logs:

- Mail Logs ( mail\_logs ). Information related to the result of scanning a URL (action taken of a message depending on the URL) is posted to this log.
- URL Filtering Logs ( web\_client ). Information related to errors, timeouts, network issues, and so on while attempting the URL lookup are posted this log.

Most information is at Info or Debug level. For more information on logs, see [Logging](#), on page 1145.

Logs do not include information about what happens when a user clicks a redirected link in a message.

"SDS" and in logs refers to URL reputation services. "Beaker Connector" refers to Talos engine.

## Alert: Beaker Connector: Error Fetching Enrollment Certificate

### Problem

You receive an info-level alert about an error fetching the enrollment client certificate.

### Solution

This certificate is required to connect to the following cloud-based services: Talos Intelligence Services (to obtain URL reputation and category) and Cisco Aggregator Server (to obtain web interaction tracking data). Try the following:

1. Check for networking issues such as incorrect proxy settings or firewall issues.
2. Verify that your URL Filtering feature key is valid and active.
3. If the problem persists, contact Cisco TAC.

## Alert: Beaker Connector: Certificate Is Invalid

### Problem

You receive a critical alert about an invalid Beaker connector certificate.

### Solution

This certificate is required to connect to Talos Intelligence Services in the cloud in order to obtain URL reputation and category.

To obtain and manually install a certificate, see [Manually Configuring a Certificate for Communication with Talos Intelligence Services](#), on page 462.

## Unable to Connect to Talos Intelligence Services

### Problem

The **Security Services > URL Filtering** page persistently indicates an issue connecting to Talos Intelligence Services.

### Solution

- If you have enabled URL filtering but have not yet committed the change, commit the change.
- Check for recent alerts related to the connection with Talos Intelligence Services. See [Viewing Recent Alerts, on page 1050](#). If applicable, see [Alert: Beaker Connector: Error Fetching Enrollment Certificate, on page 459](#) and [Alert: Beaker Connector: Certificate Is Invalid, on page 459](#).
- If you are connecting via a proxy specified in **Security Services > Service Updates**, verify that this is configured and working properly.
- Check for other network issues that might prevent connection.
- If you see errors in the URL Filtering Logs related to timed out requests to the Talos client, use the `websecuritydiagnostics` command and the `websecurityadvancedconfig` command in the command-line interface to investigate and make changes:
  - If the diagnostics show that Response Time is not less than the configured URL Lookup Timeout, increase the URL Lookup Timeout value accordingly.

- Check the URL Filtering Logs for non-timeout errors in communications with the URL scanner, Cisco Web Security Services, or Talos client. "Talos client" in logs represents Talos Intelligence Services. If you see such log messages, contact TAC.

## Alert: Unable to Connect to the Cisco Aggregator Server

### Problem

You receive the following warning alert: Unable to Connect to the Cisco Aggregator Server.

### Solution

Do the following:

1. Check the connectivity between the email gateway and the Cisco Aggregator Server by pinging the hostname of the server from the email gateway. Use the aggregatorconfig command in CLI to view the hostname of the Cisco Aggregator Server.
2. If you are connecting via a proxy specified in Security Services > Service Updates, verify that this is configured and working properly.
3. Check for other network issues that might prevent connection.
4. Check if the DNS service is running.
5. If the problem persists, contact Cisco TAC.

## Alert: Unable to Retrieve Web Interaction Tracking Information from the Cisco Aggregator Server

### Problem

You receive the following warning alert: Unable to retrieve web interaction tracking information from the Cisco Aggregator Server.

### Solution

Do the following:

1. If you are connecting via a proxy specified in Security Services > Service Updates, verify that this is configured and working properly.
2. Check for other network issues that might prevent connection.
3. Check if the DNS service is running.
4. If the problem persists, contact Cisco TAC.

## Using the websecurityadvancedconfig Command

Except for changes explicitly described in this document, make no other changes using the websecurityadvancedconfig command without guidance from TAC.

## Message Tracking Search Does Not Find Messages with Specified Category

### Problem

Messages that contain URLs in a particular category are not found when searching by that category.

**Solution**

See [Expected Messages Are Missing from Search Results](#) , on page 921.

## Malicious URLs and Marketing Messages Are Not Caught by Anti-Spam or Outbreak Filters

**Problem**

Malicious URLs and messages containing marketing links are not caught by the anti-spam or outbreak filters.

**Solution**

- This can occur because web site reputation and category are only two among many criteria that anti-spam and outbreak filters use to determine their verdicts. You can increase the sensitivity of these filters by lowering the thresholds required to take action such as rewriting or replacing URLs with text, or quarantining or dropping messages. For details, see [The Outbreak Filters Feature and Mail Policies](#), on page 434 and [Defining Anti-Spam Policies](#) , on page 395. Alternatively, create content or message filters based on URL reputation score.
- This can also occur if the email gateway is unable to connect to the Talos Intelligence Services. See [Unable to Connect to Talos Intelligence Services](#), on page 459.

## URLs in a Filtered Category Are Not Handled Correctly

**Problem**

The defined action in a content or message filter based on URL category is not applied.

**Solution**

- Use the Trace feature (described in the Troubleshooting chapter) to follow the message processing path.
- This can occur if the email gateway is unable to connect to the Talos Intelligence Services. See [Unable to Connect to Talos Intelligence Services](#), on page 459.
- If there are no connection issues, the URLs may not yet be categorized, or may be miscategorized. See [Reporting Uncategorized and Misclassified URLs](#) , on page 475. You can use this site to determine the category of a URL.

## End User Reaches Malicious Site via Rewritten URL

**Problem**

A malicious URL was redirected to the Cisco Web Security Proxy, but the end user was able to access the site anyway.

**Solution**

This can occur if:

- The site was not yet identified as a malicious site.
- The connection to the Cisco Web Security Proxy timed out, which should be a rare occurrence. Ensure that network issues are not interfering with the connection.

## Manually Configuring a Certificate for Communication with Talos Intelligence Services

Use this procedure if the email gateway is unable to automatically obtain a certificate for communication with Talos Intelligence Services.

### Procedure

- 
- Step 1** Obtain the required certificate.
  - Step 2** Upload the certificate using **Network > Certificates**, or use the `certconfig` command in the command-line interface.
  - Step 3** In the command-line interface, enter the `websecurityconfig` command.
  - Step 4** Follow the prompts to set the client certificate for Talos Intelligence Services Authentication.
- 

## About URL Categories

### Related Topics

- [URL Category Descriptions](#) , on page 462
- [Determining the Category of a URL](#) , on page 475
- [Reporting Uncategorized and Misclassified URLs](#) , on page 475
- [Future URL Category Set Changes](#) , on page 475

## URL Category Descriptions

These URL categories are the same categories that are used on recent releases of AsyncOS for Web Security appliances.

| URL Category | Abbreviation | Code | Description                                                                                                                                                                                                                                                                                                            | Example URLs                                           |
|--------------|--------------|------|------------------------------------------------------------------------------------------------------------------------------------------------------------------------------------------------------------------------------------------------------------------------------------------------------------------------|--------------------------------------------------------|
| Adult        | adlt         | 1006 | Directed at adults, but not necessarily pornographic. May include adult clubs (strip clubs, swingers clubs, escort services, strippers); general information about sex, non-pornographic in nature; genital piercing; adult products or greeting cards; information about sex not in the context of health or disease. | www.adultentertainmentexpo.com<br>www.adultnetline.com |

| URL Category   | Abbrevia-tion | Code | Description                                                                                                                                                                                                                                                               | Example URLs                           |
|----------------|---------------|------|---------------------------------------------------------------------------------------------------------------------------------------------------------------------------------------------------------------------------------------------------------------------------|----------------------------------------|
| Advertisements | adv           | 1027 | Banner and pop-up advertisements that often accompany a web page; other advertising websites that provide advertisement content. Advertising services and sales are classified as “Business and Industry.”                                                                | www.adforce.com<br>www.doubleclick.com |
| Alcohol        | alc           | 1077 | Alcohol as a pleasurable activity; beer and wine making, cocktail recipes; liquor sellers, wineries, vineyards, breweries, alcohol distributors. Alcohol addiction is classified as “Health and Nutrition.” Bars and restaurants are classified as “Dining and Drinking.” | www.samueladams.com<br>www.whisky.com  |
| Arts           | art           | 1002 | Galleries and exhibitions; artists and art; photography; literature and books; performing arts and theater; musicals; ballet; museums; design; architecture. Cinema and television are classified as “Entertainment.”                                                     | www.moma.org<br>www.nga.gov            |
| Astrology      | astr          | 1074 | Astrology; horoscope; fortune telling; numerology; psychic advice; tarot.                                                                                                                                                                                                 | www.astro.com<br>www.astrology.com     |
| Auctions       | auct          | 1088 | Online and offline auctions, auction houses, and classified advertisements.                                                                                                                                                                                               | www.craigslist.com<br>www.ebay.com     |

| URL Category               | Abbreviation | Code | Description                                                                                                                                                                                                                                                                                                                                                                                                                                                                                                                                                                                                                                                                                                                                                                   | Example URLs                                 |
|----------------------------|--------------|------|-------------------------------------------------------------------------------------------------------------------------------------------------------------------------------------------------------------------------------------------------------------------------------------------------------------------------------------------------------------------------------------------------------------------------------------------------------------------------------------------------------------------------------------------------------------------------------------------------------------------------------------------------------------------------------------------------------------------------------------------------------------------------------|----------------------------------------------|
| Business and Industry      | busi         | 1019 | Marketing, commerce, corporations, business practices, workforce, human resources, transportation, payroll, security and venture capital; office supplies; industrial equipment (process equipment), machines and mechanical systems; heating equipment, cooling equipment; materials handling equipment; packaging equipment; manufacturing: solids handling, metal fabrication, construction and building; passenger transportation; commerce; industrial design; construction, building materials; shipping and freight (freight services, trucking, freight forwarders, truckload carriers, freight and transportation brokers, expedited services, load and freight matching, track and trace, rail shipping, ocean shipping, road feeder services, moving and storage). | www.freightcenter.com<br>www.staples.com     |
| Chat and Instant Messaging | chat         | 1040 | Web-based instant messaging and chat rooms.                                                                                                                                                                                                                                                                                                                                                                                                                                                                                                                                                                                                                                                                                                                                   | www.icq.com<br>www.meebo.com                 |
| Cheating and Plagiarism    | plag         | 1051 | Promoting cheating and selling written work, such as term papers, for plagiarism.                                                                                                                                                                                                                                                                                                                                                                                                                                                                                                                                                                                                                                                                                             | www.bestessays.com<br>www.superiorpapers.com |
| Child Abuse Content        | cprn         | 1064 | Worldwide illegal child sexual abuse content.                                                                                                                                                                                                                                                                                                                                                                                                                                                                                                                                                                                                                                                                                                                                 | —                                            |
| Computer Security          | csec         | 1065 | Offering security products and services for corporate and home users.                                                                                                                                                                                                                                                                                                                                                                                                                                                                                                                                                                                                                                                                                                         | www.computersecurity.com<br>www.symantec.com |



| URL Category            | Abbrevia-tion | Code | Description                                                                                                                                                                                                                                                                                                 | Example URLs                                                       |
|-------------------------|---------------|------|-------------------------------------------------------------------------------------------------------------------------------------------------------------------------------------------------------------------------------------------------------------------------------------------------------------|--------------------------------------------------------------------|
| Computers and Internet  | comp          | 1003 | Information about computers and software, such as hardware, software, software support; information for software engineers, programming and networking; website design; the web and Internet in general; computer science; computer graphics and clip art. "Freeware and Shareware" is a separate category. | www.xml.com<br>www.w3.org                                          |
| Dating                  | date          | 1055 | Dating, online personals, matrimonial agencies.                                                                                                                                                                                                                                                             | www.eharmony.com<br>www.match.com                                  |
| Digital Postcards       | card          | 1082 | Enabling sending of digital postcards and e-cards.                                                                                                                                                                                                                                                          | www.all-yours.net<br>www.delivr.net                                |
| Dining and Drinking     | food          | 1061 | Eating and drinking establishments; restaurants, bars, taverns, and pubs; restaurant guides and reviews.                                                                                                                                                                                                    | www.hideawaybrewpub.com<br>www.restaurantrow.com                   |
| Dynamic and Residential | dyn           | 1091 | IP addresses of broadband links that usually indicates users attempting to access their home network, for example for a remote session to a home computer.                                                                                                                                                  | http://109.60.192.55<br>http://dynalink.co.jp<br>http://ipadsl.net |
| Education               | edu           | 1001 | Education-related, such as schools, colleges, universities, teaching materials, and teachers' resources; technical and vocational training; online training; education issues and policies; financial aid; school funding; standards and testing.                                                           | www.education.com<br>www.greatschools.org                          |
| Entertainment           | ent           | 1093 | Details or discussion of films; music and bands; television; celebrities and fan websites; entertainment news; celebrity gossip; entertainment venues. Compare with the "Arts" category.                                                                                                                    | www.eonline.com<br>www.ew.com                                      |

| URL Category           | Abbreviation | Code | Description                                                                                                                                                                                                                                                                                                                | Example URLs                                        |
|------------------------|--------------|------|----------------------------------------------------------------------------------------------------------------------------------------------------------------------------------------------------------------------------------------------------------------------------------------------------------------------------|-----------------------------------------------------|
| Extreme                | extr         | 1075 | Material of a sexually violent or criminal nature; violence and violent behavior; tasteless, often gory photographs, such as autopsy photos; photos of crime scenes, crime and accident victims; excessive obscene material; shock websites.                                                                               | www.car-accidents.com<br>www.crime-scene-photos.com |
| Fashion                | fash         | 1076 | Clothing and fashion; hair salons; cosmetics; accessories; jewelry; perfume; pictures and text relating to body modification; tattoos and piercing; modeling agencies. Dermatological products are classified as "Health and Nutrition."                                                                                   | www.fashion.net<br>www.findabeautysalon.com         |
| File Transfer Services | fts          | 1071 | File transfer services with the primary purpose of providing download services and hosted file sharing                                                                                                                                                                                                                     | www.rapidshare.com<br>www.yousendit.com             |
| Filter Avoidance       | filt         | 1025 | Promoting and aiding undetectable and anonymous web usage, including cgi, php and glype anonymous proxy services.                                                                                                                                                                                                          | www.bypassschoolfilter.com<br>www.filterbypass.com  |
| Finance                | fnnc         | 1015 | Primarily financial in nature, such as accounting practices and accountants, taxation, taxes, banking, insurance, investing, the national economy, personal finance involving insurance of all types, credit cards, retirement and estate planning, loans, mortgages. Stock and shares are classified as "Online Trading." | finance.yahoo.com<br>www.bankofamerica.com          |
| Freeware and Shareware | free         | 1068 | Providing downloads of free and shareware software.                                                                                                                                                                                                                                                                        | www.freewarehome.com<br>www.shareware.com           |

| URL Category       | Abbreviation | Code | Description                                                                                                                                                                                                                                                                                                                                                                                                                                                                                                                                                                      | Example URLs                              |
|--------------------|--------------|------|----------------------------------------------------------------------------------------------------------------------------------------------------------------------------------------------------------------------------------------------------------------------------------------------------------------------------------------------------------------------------------------------------------------------------------------------------------------------------------------------------------------------------------------------------------------------------------|-------------------------------------------|
| Gambling           | gamb         | 1049 | Casinos and online gambling; bookmakers and odds; gambling advice; competitive racing in a gambling context; sports booking; sports gambling; services for spread betting on stocks and shares. Websites dealing with gambling addiction are classified as “Health and Nutrition.” Government-run lotteries are classified as “Lotteries”.                                                                                                                                                                                                                                       | www.888.com<br>www.gambling.com           |
| Games              | game         | 1007 | Various card games, board games, word games, and video games; combat games; sports games; downloadable games; game reviews; cheat sheets; computer games and Internet games, such as role-playing games.                                                                                                                                                                                                                                                                                                                                                                         | www.games.com<br>www.shockwave.com        |
| Government and Law | gov          | 1011 | Government websites; foreign relations; news and information relating to government and elections; information relating to the field of law, such as attorneys, law firms, law publications, legal reference material, courts, dockets, and legal associations; legislation and court decisions; civil rights issues; immigration; patents and copyrights; information relating to law enforcement and correctional systems; crime reporting, law enforcement, and crime statistics; military, such as the armed forces, military bases, military organizations; anti-terrorism. | www.usa.gov<br>www.law.com                |
| Hacking            | hack         | 1050 | Discussing ways to bypass the security of websites, software, and computers.                                                                                                                                                                                                                                                                                                                                                                                                                                                                                                     | www.hackthissite.org<br>www.gohacking.com |

| URL Category         | Abbreviation | Code | Description                                                                                                                                                                                                                                                                                                                                                                                                                                                                                                                                      | Example URLs                       |
|----------------------|--------------|------|--------------------------------------------------------------------------------------------------------------------------------------------------------------------------------------------------------------------------------------------------------------------------------------------------------------------------------------------------------------------------------------------------------------------------------------------------------------------------------------------------------------------------------------------------|------------------------------------|
| Hate Speech          | hate         | 1016 | Websites promoting hatred, intolerance, or discrimination on the basis of social group, color, religion, sexual orientation, disability, class, ethnicity, nationality, age, gender, gender identity; sites promoting racism; sexism; racist theology; hate music; neo-Nazi organizations; supremacism; Holocaust denial.                                                                                                                                                                                                                        | www.kkk.com<br>www.nazi.org        |
| Health and Nutrition | hlth         | 1009 | Health care; diseases and disabilities; medical care; hospitals; doctors; medicinal drugs; mental health; psychiatry; pharmacology; exercise and fitness; physical disabilities; vitamins and supplements; sex in the context of health (disease and health care); tobacco use, alcohol use, drug use, and gambling in the context of health (disease and health care); food in general; food and beverage; cooking and recipes; food and nutrition, health, and dieting; cooking, including recipe and culinary websites; alternative medicine. | www.health.com<br>www.webmd.com    |
| Humor                | lol          | 1079 | Jokes, sketches, comics and other humorous content. Adult humor likely to offend is classified as "Adult."                                                                                                                                                                                                                                                                                                                                                                                                                                       | www.humor.com<br>www.jokes.com     |
| Illegal Activities   | ilac         | 1022 | Promoting crime, such as stealing, fraud, illegally accessing telephone networks; computer viruses; terrorism, bombs, and anarchy; websites depicting murder and suicide as well as explaining ways to commit them.                                                                                                                                                                                                                                                                                                                              | www.ekran.no<br>www.thedisease.net |

| URL Category                                 | Abbrevia-tion | Code | Description                                                                                                                                                                                                                       | Example URLs                                |
|----------------------------------------------|---------------|------|-----------------------------------------------------------------------------------------------------------------------------------------------------------------------------------------------------------------------------------|---------------------------------------------|
| Illegal Downloads                            | ildl          | 1084 | Providing the ability to download software or other materials, serial numbers, key generators, and tools for bypassing software protection in violation of copyright agreements. Torrents are classified as “Peer File Transfer.” | www.keygenguru.com<br>www.zcrack.com        |
| Illegal Drugs                                | drug          | 1047 | Information about recreational drugs, drug paraphernalia, drug purchase and manufacture.                                                                                                                                          | www.cocaine.org<br>www.hightimes.com        |
| Infrastructure and Content Delivery Networks | infr          | 1018 | Content delivery infrastructure and dynamically generated content; websites that cannot be classified more specifically because they are secured or otherwise difficult to classify.                                              | www.akamai.net<br>www.webstat.net           |
| Internet Telephony                           | voip          | 1067 | Telephonic services using the Internet.                                                                                                                                                                                           | www.evaphone.com<br>www.skype.com           |
| Job Search                                   | job           | 1004 | Career advice; resume writing and interviewing skills; job placement services; job databanks; permanent and temporary employment agencies; employer websites.                                                                     | www.careerbuilder.com<br>www.monster.com    |
| Lingerie and Swimsuits                       | ling          | 1031 | Intimate apparel and swim wear, especially when modeled.                                                                                                                                                                          | www.swimsuits.com<br>www.victoriasecret.com |
| Lotteries                                    | lotr          | 1034 | Sweepstakes, contests and state-sponsored lotteries.                                                                                                                                                                              | www.calottery.com<br>www.flalottery.com     |
| Mobile Phones                                | cell          | 1070 | Short Message Services (SMS); ring tones and mobile phone downloads. Cellular carrier websites are included in the “Business and Industry” category.                                                                              | www.cbfsms.com<br>www.zedge.net             |

| URL Category                   | Abbreviation | Code | Description                                                                                                                                                                                                                                                                                                                                                                                                                                                                                                                                                                                                                                      | Example URLs                                |
|--------------------------------|--------------|------|--------------------------------------------------------------------------------------------------------------------------------------------------------------------------------------------------------------------------------------------------------------------------------------------------------------------------------------------------------------------------------------------------------------------------------------------------------------------------------------------------------------------------------------------------------------------------------------------------------------------------------------------------|---------------------------------------------|
| Nature                         | natr         | 1013 | Natural resources; ecology and conservation; forests; wilderness; plants; flowers; forest conservation; forest, wilderness, and forestry practices; forest management (reforestation, forest protection, conservation, harvesting, forest health, thinning, and prescribed burning); agricultural practices (agriculture, gardening, horticulture, landscaping, planting, weed control, irrigation, pruning, and harvesting); pollution issues (air quality, hazardous waste, pollution prevention, recycling, waste management, water quality, and the environmental cleanup industry); animals, pets, livestock, and zoology; biology; botany. | www.enature.com<br>www.nature.org           |
| News                           | news         | 1058 | News; headlines; newspapers; television stations; magazines; weather; ski conditions.                                                                                                                                                                                                                                                                                                                                                                                                                                                                                                                                                            | www.cnn.com<br>news.bbc.co.uk               |
| Non-Governmental Organizations | ngo          | 1087 | Non-governmental organizations such as clubs, lobbies, communities, non-profit organizations and labor unions.                                                                                                                                                                                                                                                                                                                                                                                                                                                                                                                                   | www.panda.org<br>www.unions.org             |
| Non-Sexual Nudity              | nsn          | 1060 | Nudism and nudity; naturism; nudist camps; artistic nudes.                                                                                                                                                                                                                                                                                                                                                                                                                                                                                                                                                                                       | www.artenuda.com<br>www.naturistsociety.com |
| Online Communities             | comm         | 1024 | Affinity groups; special interest groups; web newsgroups; message boards. Excludes websites classified as “Professional Networking” or “Social Networking.”                                                                                                                                                                                                                                                                                                                                                                                                                                                                                      | www.igda.org<br>www.ieee.org                |
| Online Storage and Backup      | osb          | 1066 | Offsite and peer-to-peer storage for backup, sharing, and hosting.                                                                                                                                                                                                                                                                                                                                                                                                                                                                                                                                                                               | www.adrive.com<br>www.dropbox.com           |

| URL Category              | Abbrevia-tion | Code | Description                                                                                                                                                                                                                                                                                                                                                                   | Example URLs                              |
|---------------------------|---------------|------|-------------------------------------------------------------------------------------------------------------------------------------------------------------------------------------------------------------------------------------------------------------------------------------------------------------------------------------------------------------------------------|-------------------------------------------|
| Online Trading            | trad          | 1028 | Online brokerages; websites that enable the user to trade stocks online; information relating to the stock market, stocks, bonds, mutual funds, brokers, stock analysis and commentary, stock screens, stock charts, IPOs, stock splits. Services for spread betting on stocks and shares are classified as "Gambling." Other financial services are classified as "Finance." | www.tdameritrade.com<br>www.scottrade.com |
| Organizational Email      | pem           | 1085 | Websites used to access business email (often via Outlook Web Access).                                                                                                                                                                                                                                                                                                        | —                                         |
| Parked Domains            | park          | 1092 | Websites that monetize traffic from the domain using paid listings from an ad network, or are owned by "squatters" hoping to sell the domain name for a profit. These also include fake search websites which return paid ad links.                                                                                                                                           | www.domainzaar.com<br>www.parked.com      |
| Peer File Transfer        | p2p           | 1056 | Peer-to-peer file request websites. This does not track the file transfers themselves.                                                                                                                                                                                                                                                                                        | www.bittorrent.com<br>www.limewire.com    |
| Personal Sites            | pers          | 1081 | Websites about and from private individuals; personal homepage servers; websites with personal contents; personal blogs with no particular theme.                                                                                                                                                                                                                             | www.karymullis.com<br>www.stallman.org    |
| Photo Searches and Images | img           | 1090 | Facilitating the storing and searching for, images, photographs, and clip-art.                                                                                                                                                                                                                                                                                                | www.flickr.com<br>www.photobucket.com     |
| Politics                  | pol           | 1083 | Websites of politicians; political parties; news and information on politics, elections, democracy, and voting.                                                                                                                                                                                                                                                               | www.politics.com<br>www.thisnation.com    |

| URL Category               | Abbreviation | Code | Description                                                                                                                                                                                                                                                 | Example URLs                                        |
|----------------------------|--------------|------|-------------------------------------------------------------------------------------------------------------------------------------------------------------------------------------------------------------------------------------------------------------|-----------------------------------------------------|
| Pornography                | porn         | 1054 | Sexually explicit text or depictions. Includes explicit anime and cartoons; general explicit depictions; other fetish material; explicit chat rooms; sex simulators; strip poker; adult movies; lewd art; web-based explicit email.                         | www.redtube.com<br>www.youporn.com                  |
| Professional Networking    | pnet         | 1089 | Social networking for the purpose of career or professional development. See also “Social Networking.”                                                                                                                                                      | www.linkedin.com<br>www.europeanpwn.net             |
| Real Estate                | rest         | 1045 | Information that would support the search for real estate; office and commercial space; real estate listings, such as rentals, apartments, and homes; house building.                                                                                       | www.realtor.com<br>www.zillow.com                   |
| Reference                  | ref          | 1017 | City and state guides; maps, time; reference sources; dictionaries; libraries.                                                                                                                                                                              | www.wikipedia.org<br>www.yellowpages.com            |
| Religion                   | rel          | 1086 | Religious content, information about religions; religious communities.                                                                                                                                                                                      | www.religionfacts.com<br>www.religioustolerance.org |
| SaaS and B2B               | saas         | 1080 | Web portals for online business services; online meetings.                                                                                                                                                                                                  | www.netsuite.com<br>www.salesforce.com              |
| Safe for Kids              | kids         | 1057 | Directed at, and specifically approved for, young children.                                                                                                                                                                                                 | kids.discovery.com<br>www.nickjr.com                |
| Science and Technology     | sci          | 1012 | Science and technology, such as aerospace, electronics, engineering, mathematics, and other similar subjects; space exploration; meteorology; geography; environment; energy (fossil, nuclear, renewable); communications (telephones, telecommunications). | www.physorg.com<br>www.science.gov                  |
| Search Engines and Portals | srch         | 1020 | Search engines and other initial points of access to information on the Internet.                                                                                                                                                                           | www.bing.com<br>www.google.com                      |



| URL Category          | Abbreviation | Code | Description                                                                                                                                                                | Example URLs                                    |
|-----------------------|--------------|------|----------------------------------------------------------------------------------------------------------------------------------------------------------------------------|-------------------------------------------------|
| Sex Education         | sxed         | 1052 | Factual websites dealing with sex; sexual health; contraception; pregnancy.                                                                                                | www.avert.org<br>www.scarleteen.com             |
| Shopping              | shop         | 1005 | Bartering; online purchasing; coupons and free offers; general office supplies; online catalogs; online malls.                                                             | www.amazon.com<br>www.shopping.com              |
| Social Networking     | snet         | 1069 | Social networking. See also “Professional Networking.”                                                                                                                     | www.facebook.com<br>www.twitter.com             |
| Social Science        | socs         | 1014 | Sciences and history related to society; archaeology; anthropology; cultural studies; history; linguistics; geography; philosophy; psychology; women's studies.            | www.archaeology.org<br>www.anthropology.net     |
| Society and Culture   | scty         | 1010 | Family and relationships; ethnicity; social organizations; genealogy; seniors; child-care.                                                                                 | www.childcare.gov<br>www.familysearch.org       |
| Software Updates      | swup         | 1053 | Websites that host updates for software packages.                                                                                                                          | www.softwarepatch.com<br>www.versiontracker.com |
| Sports and Recreation | sprt         | 1008 | All sports, professional and amateur; recreational activities; fishing; fantasy sports; public parks; amusement parks; water parks; theme parks; zoos and aquariums; spas. | www.espn.com<br>www.recreation.gov              |
| Streaming Audio       | aud          | 1073 | Real-time streaming audio content including Internet radio and audio feeds.                                                                                                | www.live-radio.net<br>www.shoutcast.com         |
| Streaming Video       | vid          | 1072 | Real-time streaming video including Internet television, web casts, and video sharing.                                                                                     | www.hulu.com<br>www.youtube.com                 |
| Tobacco               | tob          | 1078 | Pro-tobacco websites; tobacco manufacturers; pipes and smoking products (not marketed for illegal drug use). Tobacco addiction is classified as “Health and Nutrition.”    | www.bat.com<br>www.tobacco.org                  |

| URL Category         | Abbreviation | Code | Description                                                                                                                                                                                                                                                                                                                            | Example URLs                                |
|----------------------|--------------|------|----------------------------------------------------------------------------------------------------------------------------------------------------------------------------------------------------------------------------------------------------------------------------------------------------------------------------------------|---------------------------------------------|
| Transportation       | trns         | 1044 | Personal transportation; information about cars and motorcycles; shopping for new and used cars and motorcycles; car clubs; boats, airplanes, recreational vehicles (RVs), and other similar items. Note, car and motorcycle racing is classified as “Sports and Recreation.”                                                          | www.cars.com<br>www.motorcycles.com         |
| Travel               | trvl         | 1046 | Business and personal travel; travel information; travel resources; travel agents; vacation packages; cruises; lodging and accommodation; travel transportation; flight booking; airfares; car rental; vacation homes.                                                                                                                 | www.expedia.com<br>www.lonelyplanet.com     |
| Unclassified         | —            | —    | Websites which are not in the Cisco database are recorded as unclassified for reporting purposes. This may include mistyped URLs.                                                                                                                                                                                                      | —                                           |
| Weapons              | weap         | 1036 | Information relating to the purchase or use of conventional weapons such as gun sellers, gun auctions, gun classified ads, gun accessories, gun shows, and gun training; general information about guns; other weapons and graphic hunting sites may be included. Government military websites are classified as “Government and Law.” | www.coldsteel.com<br>www.gunbroker.com      |
| Web Hosting          | whst         | 1037 | Website hosting; bandwidth services.                                                                                                                                                                                                                                                                                                   | www.bluehost.com<br>www.godaddy.com         |
| Web Page Translation | tran         | 1063 | Translation of web pages between languages.                                                                                                                                                                                                                                                                                            | babelfish.yahoo.com<br>translate.google.com |

| URL Category    | Abbrevia-tion | Code | Description                                                                                                                                                      | Example URLs                      |
|-----------------|---------------|------|------------------------------------------------------------------------------------------------------------------------------------------------------------------|-----------------------------------|
| Web-Based Email | mail          | 1038 | Public web-based email services. Websites enabling individuals to access their company or organization's email service are classified as "Organizational Email." | mail.yahoo.com<br>www.hotmail.com |

## Determining the Category of a URL

To look up the category of a particular URL, visit the site shown in [Reporting Uncategorized and Misclassified URLs](#), on page 475.

## Reporting Uncategorized and Misclassified URLs

To report URLs that have been miscategorized, and URLs that are not categorized but should be, visit:

[https://talosintelligence.com/reputation\\_center/support](https://talosintelligence.com/reputation_center/support)

To check the status of submitted URLs, click the **Status on Submitted URLs** tab on this page.

## Future URL Category Set Changes

Rarely, the set of URL categories may change as a result of emerging trends and technologies. For example, a category may be added or removed, renamed, merged with another category, or split into two categories. These changes can affect the results from existing filters, so if changes occur, the email gateway will send an alert (System type, Warning severity). If you receive such an alert, you should evaluate and possibly update content and message filters to work with the updated categories. Existing filters will not automatically be changed. To ensure that you receive these alerts, see [Adding Alert Recipients, on page 1048](#).

The following changes do not require category set changes and will not generate alerts:

- Routine categorization of newly-categorized sites.
- Recategorization of misclassified sites.





## CHAPTER 21

# File Reputation Filtering and File Analysis

This chapter contains the following sections:

- [Overview of File Reputation Filtering and File Analysis](#) , on page 477
- [Configuring File Reputation and Analysis Features](#), on page 481
- [File Reputation and File Analysis Reporting and Tracking](#) , on page 499
- [Taking Action When File Threat Verdicts Change](#) , on page 501
- [Troubleshooting File Reputation and Analysis](#) , on page 501

## Overview of File Reputation Filtering and File Analysis

Advanced Malware Protection protects against zero-day and targeted file-based threats in email attachments by:

- Obtaining the reputation of known files.
- Analyzing behavior of certain files that are not yet known to the reputation service.
- Continuously evaluating emerging threats as new information becomes available, and notifying you about files that are determined to be threats after they have entered your network.

This feature is available for incoming messages and outgoing messages.

The file reputation and file analysis services have options for either public- or private-cloud (on-premises).

- The private-cloud file reputation service is provided by Cisco AMP Virtual Private Cloud appliance, operating in either “proxy” or “air-gap” (on-premises) mode. See [Configuring an On-premises File Reputation Server](#), on page 482.
- The private-cloud file analysis service is provided by an on-premises Cisco AMP Malware Analytics appliance. See [Configuring an On-Premises File Analysis Server](#) , on page 482.

## File Threat Verdict Updates

Threat verdicts can change as new information emerges. A file may initially be evaluated as unknown or clean, and the file may therefore be released to the recipient. If the threat verdict changes as new information becomes available, you will be alerted, and the file and its new verdict appear in the AMP Verdict Updates report. You can investigate the point-of-entry message as a starting point to remediating any impacts of the threat.

Verdicts can also change from malicious to clean.

When no dynamic content is found in a file after file analysis, the verdict is Low Risk. The file is not sent for file analysis, and the message continues through the email pipeline.

When the appliance processes subsequent instances of the same file, the updated verdict is immediately applied.

Information about the timing of verdict updates is included in the file-criteria document referenced in [Supported Files for File Reputation and Analysis Services](#) , on page 479.

### Related Topics

- [File Reputation and File Analysis Reporting and Tracking](#) , on page 499
- [Taking Action When File Threat Verdicts Change](#) , on page 501

## File Processing Overview

Evaluation of file reputation and sending of files for analysis occur immediately after anti-virus scanning, regardless of verdicts from previous scanning engines, unless a final action has been taken on the message.



---

**Note** By default, if a message has malformed MIME headers, the file reputation service returns a verdict of “unscannable.” The appliance will also attempt to extract the attachments from this message. If the appliance is unable to extract the attachments, verdict will remain as “unscannable.” If the appliance is able to extract the attachments, the file reputation of the attachments is evaluated. If the attachments are malicious, the verdict is changed from “unscannable” to “malicious.”

---

Communications between the appliance and the file reputation service are encrypted and protected from tampering.

After a file’s reputation is evaluated:

- If a message does not contain any attachments, the file reputation service will return a verdict of “skipped.”
- If the file is known to the file reputation service and is determined to be clean, the message continues through the workqueue.
- If the file reputation service returns a verdict of malicious, for any attachment in the message, then the appliance applies the action that you have specified in the applicable mail policy.
- If the file is known to the reputation service but there is insufficient information for a definitive verdict, the reputation service returns a reputation score based on characteristics of the file such as threat fingerprint and behavioral analysis. If this score meets or exceeds the configured reputation threshold, the appliance applies the action that you have configured in the mail policy for files that contain malware .
- If the reputation service has no information about the file, and the file does not meet the criteria for analysis (see [Supported Files for File Reputation and Analysis Services](#) , on page 479), the file is considered clean and the message continues through the workqueue.
- If you have enabled the File Analysis service, and the reputation service has no information about the file, and the file meets the criteria for files that can be analyzed (see [Supported Files for File Reputation and Analysis Services](#) , on page 479), then the message can be quarantined (see [Quarantining Messages with Attachments Sent for Analysis](#), on page 494) and the file sent for analysis. If you have not configured the appliance to quarantine messages when attachments are sent for analysis, or the file is not sent for analysis, then the message is released to the user.

- For deployments with on-premises file analysis, the reputation evaluation and file analysis occur simultaneously. If the reputation service returns a verdict, that verdict is used, as the reputation service includes inputs from a wider range of sources. If the file is unknown to the reputation service, the file the file analysis verdict is used.
- If the file reputation verdict information is unavailable because the connection with the server timed out, the file is considered as Unscannable and the actions configured are applied.

**Figure 33: Advanced Malware Protection Workflow for Public-Cloud File Analysis Deployments**

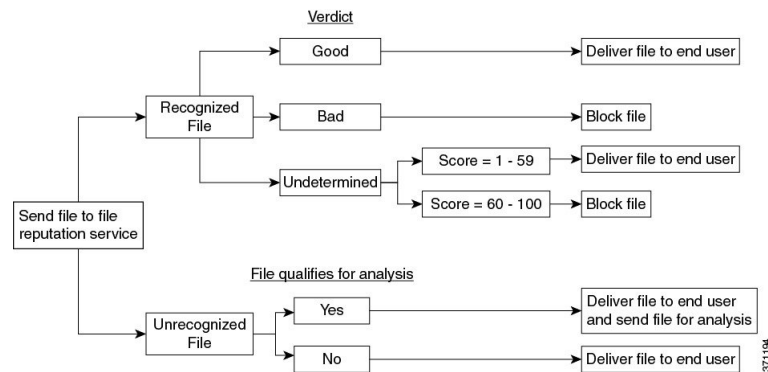

If the file is sent for analysis:

- If the file is sent to the cloud for analysis: Files are sent over HTTPS.
- Analysis normally takes minutes, but may take longer.
- A file that is flagged as malicious after File Analysis may not be identified as malicious by the reputation service. File reputation is determined by a variety of factors over time, not necessarily by a single file analysis verdict.
- Results for files analyzed using an on premises Cisco Secure Endpoint Malware Analytics appliance are cached locally.

For information about verdict updates, see [File Threat Verdict Updates](#) , on page 477.

## Supported Files for File Reputation and Analysis Services

The reputation service evaluates most file types. File type identification is determined by file content and is not dependent on the filename extension.

Some files with unknown reputation can be analyzed for threat characteristics. When you configure the file analysis feature, you choose which file types are analyzed. New types can be added dynamically; you will receive an alert when the list of uploadable file types changes, and can select added file types to upload.

Details about what files are supported by the reputation and analysis services are available only to registered Cisco customers. For information about which files are evaluated and analyzed, see *File Criteria for Advanced Malware Protection Services for Cisco Content Security Products*, available from <https://www.cisco.com/c/en/us/support/security/email-security-appliance/products-user-guide-list.html>. The criteria for evaluating a file's reputation and for sending files for analysis may change at any time.

In order to access this document, you must have a Cisco customer account with a support contract. To register, visit <https://tools.cisco.com/RPF/register/register.do>.

You should configure policies to block delivery of files that are not addressed by Advanced Malware Protection.



---

**Note** A file (either in incoming mail or outgoing mail) that has already been uploaded for analysis from any source will not be uploaded again. To view analysis results for such a file, search for the SHA-256 from the File Analysis reporting page.

---

#### Related Topics

- [Enabling and Configuring File Reputation and Analysis Services](#) , on page 483
- [Ensuring That You Receive Alerts About Advanced Malware Protection Issues](#), on page 498
- [Archive or Compressed File Processing](#), on page 480

## Archive or Compressed File Processing

If the file is compressed or archived,

- Reputation of the compressed or archive file is evaluated.

For information about which archived and compressed files are examined, including file formats, see the information linked from [Supported Files for File Reputation and Analysis Services](#) , on page 479.

In this scenario,

- If one of the extracted files is malicious, the file reputation service returns a verdict of Malicious for the compressed or the archive file.
- If the compressed or archive file is malicious and all the extracted files are clean, the file reputation service returns a verdict of Malicious for the compressed or the archive file.
- If the verdict of any of the extracted files is unknown, the extracted files are optionally (if configured and the file type is supported for file analysis) sent for file analysis.
- If the verdict of any of the extracted files or attachments is low risk, the file is not sent for file analysis.
- If the extraction of a file fails while decompressing a compressed or an archive file, the file reputation service returns a verdict of Unscannable for the compressed or the archive file. Keep in mind that, in this scenario, if one of the extracted files is malicious, the file reputation service returns a verdict of Malicious for the compressed or the archive file (Malicious verdict takes precedence over Unscannable verdict).
- An archive or compressed file is treated as unscannable in the following scenarios:
  - The data compression ratio is more than 20.
  - The archive file contains more than five levels of nesting.
  - The archive file contains more than 200 child files.
  - The archive file size is more than 50 MB.
  - The archive file is password protected or unreadable.



---

**Note** Reputation of the extracted files with safe MIME types, for example, text/plain, are not evaluated.

---



## Privacy of Information Sent to the Cloud

- Only the SHA that uniquely identifies a file is sent to the reputation service in the cloud. The file itself is not sent.
- If you are using the file analysis service in the cloud and a file qualifies for analysis, the file itself is sent to the cloud.
- Information about every file that is sent to the cloud for analysis and has a verdict of "malicious" is added to the reputation database. This information is used along with other data to determine a reputation score. Information about files analyzed by an on premises Cisco Secure Endpoint Malware Analytics appliance is not shared with the reputation service.

## Configuring File Reputation and Analysis Features

- [Requirements for Communication with File Reputation and Analysis Services](#) , on page 481
- [Configuring an On-premises File Reputation Server](#), on page 482
- [Configuring an On-Premises File Analysis Server](#) , on page 482
- [Enabling and Configuring File Reputation and Analysis Services](#)
- [\(Public Cloud File Analysis Services Only\) Configuring Appliance Groups](#) , on page 489
- [Configuring the Mail Policy for File Reputation Scanning and File Analysis](#), on page 491
- [Quarantining Messages with Attachments Sent for Analysis](#), on page 494
- [Using the File Analysis Quarantine](#), on page 495
- [Centralized File Analysis Quarantine](#) , on page 497
- [X-Headers for File Reputation and Analysis](#) , on page 497
- [Sending Notifications to End Users about Dropped Messages or Attachments](#) , on page 497
- [Advanced Malware Protection and Clusters](#) , on page 497
- [Ensuring That You Receive Alerts About Advanced Malware Protection Issues](#), on page 498
- [Configuring Centralized Reporting for Advanced Malware Protection Features](#) , on page 498

## Requirements for Communication with File Reputation and Analysis Services

- All Email Security appliances that use these services must be able to connect to them directly over the internet (excluding File Analysis services configured to use an on-premises Cisco Secure Endpoint Malware Analytics Appliance.)
- By default, communication with file reputation and analysis services .
- By default, communication with file reputation and cloud-based analysis services is routed through the interface that is associated with the default gateway. To route this traffic through a different interface,

create a static route for each address in the Advanced section of the Security Services > File Reputation and Analysis page.

- The following firewall ports must be open:

| Firewall Ports         | Description                                             | Protocol | In/Out | Hostname                                                                                                         | Appliance Interface                                                                        |
|------------------------|---------------------------------------------------------|----------|--------|------------------------------------------------------------------------------------------------------------------|--------------------------------------------------------------------------------------------|
| 32137 (default) or 443 | Access to cloud services for obtaining file reputation. | TCP      | Out    | As configured in Security Services > Anti-Malware and Reputation, Advanced section, Cloud Server Pool parameter. | Management, unless a static route is configured to route this traffic through a data port. |
| 443                    | Access to cloud services for file analysis.             | TCP      | Out    | As configured in Security Services > Anti-Malware and Reputation, Advanced section.                              |                                                                                            |

## Configuring an On-premises File Reputation Server

If you will use a Cisco AMP Virtual Private Cloud appliance as a private-cloud file analysis server:

- You can obtain the Cisco Advanced Malware Protection Virtual Private Cloud Appliance documentation, including the Installation and Configuration of FireAMP Private Cloud guide, from <http://www.cisco.com/c/en/us/support/security/fireamp-private-cloud-virtual-appliance/tsd-products-support-series-home.html>
- Use that documentation to perform the tasks described in this topic.
- Additional documentation is available using the Help link in the AMP Virtual Private Cloud appliance.
- Set up and configure the Cisco AMP Virtual Private Cloud appliance in either “proxy” or “air-gap” (on-premises) mode.
- Ensure the Cisco AMP Virtual Private Cloud appliance software version is 2.2, which enables integration with Cisco Email Security appliance .
- Download the AMP Virtual Private Cloud certificate and keys on that appliance for upload to this Email Security appliance
- Use the **Root Certificate** option to skip standard validation when the root authority, trusted by the Email Security Appliance, does not sign the tunnel proxy server certificate.



**Note** After you have set up the on-premises file-reputation server, you will configure connection to it from this Email Security appliance ; see Step 6 of [Enabling and Configuring File Reputation and Analysis Services](#) , on page 483

## Configuring an On-Premises File Analysis Server

If you will use a Cisco Secure Endpoint Malware Analytics Appliance as a private-cloud file analysis server:

- Obtain the Cisco Secure Endpoint Malware Analytics Appliance Setup and Configuration Guide and the Cisco Secure Endpoint Malware Analytics Appliance Administration Guide. Cisco Secure Endpoint

Malware Analytics Appliance documentation is available from <http://www.cisco.com/c/en/us/support/security/amp-threat-grid-appliances/products-installation-guides%20-list.html>.

Use this documentation to perform the tasks described in this topic.

Additional documentation is available from the Help link in the Cisco Secure Endpoint Malware Analytics appliance.

In the Administration Guide, search for information about all of the following: integrations with other Cisco appliances, CSA, Cisco Sandbox API, ESA, and Email Security Appliances, .

- Set up and configure the Cisco Secure Endpoint Malware Analytics Appliance.
- If necessary, update your Cisco Secure Endpoint Malware Analytics Appliance software to version 1.2.1, which supports integration with Cisco Email Security appliances.  
See the AMP Malware Analytics documentation for instructions for determining the version number and for performing the update.
- Ensure that your appliances can communicate with each other over your network. Cisco Email Security appliances must be able to connect to the CLEAN interface of the Cisco Secure Endpoint Malware Analytics appliance.
- If you will deploy a self-signed certificate: Generate a self-signed SSL certificate from the Cisco Secure Endpoint Malware Analytics appliance to be used on your Email Security appliance . See instructions for downloading SSL certificates and keys in the administrator's guide for your Cisco Secure Endpoint Malware Analytics appliance. Be sure to generate a certificate that has the hostname of your Cisco Secure Endpoint Malware Analytics appliance as CN. The default certificate from the Cisco Secure Endpoint Malware Analytics appliance does NOT work.
- Registration of your Email Security appliance with your Malware Analytics appliance occurs automatically when you submit the configuration for File Analysis, as described in [Enabling and Configuring File Reputation and Analysis Services](#) . However, you must activate the registration as described in the same procedure.

## Enabling and Configuring File Reputation and Analysis Services

### Before you begin

- Acquire feature keys for the file reputation service and the file analysis service and transfer them to this appliance.
- Meet the [Requirements for Communication with File Reputation and Analysis Services](#) , on page 481.
- Verify connectivity to the update servers configured on the Updates page .
- If you will use a Cisco AMP Virtual Private Cloud Appliance as a private cloud file reputation server, see [Configuring an On-premises File Reputation Server](#), on page 482.
- If you will use a Cisco Secure Endpoint Malware Analytics Appliance as a private cloud file analysis server, see [Configuring an On-Premises File Analysis Server](#) , on page 482.

## Procedure

- Step 1** Select **Security Services > File Reputation and Analysis**.
- Step 2** Click **Edit Global Settings**.
- Step 3** Click **Enable File Reputation Filtering** and optionally **Enable File Analysis**.
- If **Enable File Reputation Filtering** is checked, you must configure the section **File Reputation Server** (in **Step 6**), by either choosing the URL of an external public-reputation cloud server, or by providing the Private reputation cloud server connection information.
  - Similarly, if **Enable File Analysis** is checked, you must configure the section **File Analysis Server URL** (in **Step 7**), providing either the URL of an external cloud server, or the Private analysis cloud connection information.
- Note** New file types may be added after an upgrade and are not enabled by default. If you have enabled file analysis, and require the new file types to be included in analysis, you must enable them.

**Step 4** Accept the license agreement if presented.

**Step 5** In the **File Analysis** section, select the required file types from the appropriate file groups (for example, “Microsoft Documents”) to send for file analysis.

For information about supported file types, see the document described in [Supported Files for File Reputation and Analysis Services](#), on page 479

**Note** Cisco periodically checks for potentially malicious file types to prevent zero day threats. If new threats are identified, details of such file types are sent to your appliance through updater servers. Select the **Other potentially malicious file types** option to enable this functionality. If you enable this functionality, your appliance will send such file types for analysis in addition to the file types you have selected.

**Step 6** Expand the **Advanced Settings for File Reputation** panel and adjust the following options as needed:

| Option                 | Description                                                                                                                                                                                                                                                                                                                                                                                                                                                                                                                                                                                                                                                                                                               |
|------------------------|---------------------------------------------------------------------------------------------------------------------------------------------------------------------------------------------------------------------------------------------------------------------------------------------------------------------------------------------------------------------------------------------------------------------------------------------------------------------------------------------------------------------------------------------------------------------------------------------------------------------------------------------------------------------------------------------------------------------------|
| Cloud Domain           | The name of the domain to be used for file reputation queries.                                                                                                                                                                                                                                                                                                                                                                                                                                                                                                                                                                                                                                                            |
| File Reputation Server | <p>Choose either: the host name of the public reputation cloud server, or Private reputation cloud.</p> <p>If you choose Private reputation cloud, provide the following:</p> <ul style="list-style-type: none"> <li>• <b>Server</b> – The host name or IP address of the Cisco AMP Virtual Private Cloud appliance.</li> <li>• <b>Public Key</b> – Provide a valid public key for encrypted communications between this appliance and your private cloud appliance. This must be the same key used by the private cloud server: locate the key file on this appliance, and then click <b>Upload File</b>.</li> </ul> <p><b>Note</b> You must have already downloaded the key file from the server to this appliance.</p> |

| Option                                | Description                                                                                                                                                                                                                                                                                                                                                                                                                                                                                                                                                                                                                                                                                                                                                                                                                                                                                                                                                                                                                                                                                                                                                                                                                                                                                                                                                                                                                                                                      |
|---------------------------------------|----------------------------------------------------------------------------------------------------------------------------------------------------------------------------------------------------------------------------------------------------------------------------------------------------------------------------------------------------------------------------------------------------------------------------------------------------------------------------------------------------------------------------------------------------------------------------------------------------------------------------------------------------------------------------------------------------------------------------------------------------------------------------------------------------------------------------------------------------------------------------------------------------------------------------------------------------------------------------------------------------------------------------------------------------------------------------------------------------------------------------------------------------------------------------------------------------------------------------------------------------------------------------------------------------------------------------------------------------------------------------------------------------------------------------------------------------------------------------------|
| AMP for Endpoints Console Integration | Click <b>Register the Appliance with AMP for Endpoints</b> to integrate your appliance with AMP for Endpoints console. For detailed instructions, see <a href="#">Integrating the Appliance with AMP for Endpoints Console, on page 487</a> .                                                                                                                                                                                                                                                                                                                                                                                                                                                                                                                                                                                                                                                                                                                                                                                                                                                                                                                                                                                                                                                                                                                                                                                                                                    |
| SSL Communication for File Reputation | <p>Check <b>Use SSL (Port 443)</b> to communicate on port 443 instead of the default port, 32137. Refer to the Cisco AMP Virtual Private Cloud Appliance user guide for information about enabling SSH access to the server.</p> <p><b>Note</b> SSL communication over port 32137 may require you to open that port in your firewall.</p> <p>This option also allows you to configure an upstream proxy for communication with the file reputation service. If checked, provide the appropriate <b>Server</b>, <b>Username</b> and <b>Password</b> information.</p> <p>When <b>Use SSL (Port 443)</b> is selected, you can also check <b>Relax Certificate Validation</b> to skip standard certificate validation if the tunnel proxy server's certificate is not signed by a trusted root authority. For instance, select this option if using a self-signed certificate on a trusted internal tunnel proxy server.</p> <p><b>Note</b> If you checked <b>Use SSL (Port 443)</b> in the SSL Communication for File Reputation section of the Advanced Settings for File Reputation, you must add the AMP on-premises reputation server CA certificate to the certificate store on this appliance, using either the CLI command <code>certconfig &gt; CERTAUTHORITY &gt; CUSTOM</code>, or Network &gt; Certificates (Custom Certificate Authorities) in the Web interface. Obtain this certificate from the server (Configuration &gt; SSL &gt; Cloud server &gt; download).</p> |
| Heartbeat Interval                    | The frequency, in minutes, with which to ping for retrospective events.                                                                                                                                                                                                                                                                                                                                                                                                                                                                                                                                                                                                                                                                                                                                                                                                                                                                                                                                                                                                                                                                                                                                                                                                                                                                                                                                                                                                          |
| Query Timeout                         | The number of elapsed seconds before the reputation query times out.                                                                                                                                                                                                                                                                                                                                                                                                                                                                                                                                                                                                                                                                                                                                                                                                                                                                                                                                                                                                                                                                                                                                                                                                                                                                                                                                                                                                             |
| Processing Timeout                    | The number of elapsed seconds before the file processing times out.                                                                                                                                                                                                                                                                                                                                                                                                                                                                                                                                                                                                                                                                                                                                                                                                                                                                                                                                                                                                                                                                                                                                                                                                                                                                                                                                                                                                              |
| File Reputation Client ID             | The client ID for this appliance on the File Reputation server (read-only).                                                                                                                                                                                                                                                                                                                                                                                                                                                                                                                                                                                                                                                                                                                                                                                                                                                                                                                                                                                                                                                                                                                                                                                                                                                                                                                                                                                                      |
| File Retrospective                    | Check <b>Suppress the retrospective verdict alerts</b> to suppress the retrospective verdict alerts for messages that are not delivered to the message recipient, dropped or quarantined.                                                                                                                                                                                                                                                                                                                                                                                                                                                                                                                                                                                                                                                                                                                                                                                                                                                                                                                                                                                                                                                                                                                                                                                                                                                                                        |

**Note** Do not change any other settings in this section without guidance from Cisco support.

### Step 7

If you will use the cloud service for file analysis, expand the Advanced Settings for File Analysis panel and adjust the following options as needed:

| Option                   | Description                                                                                                                                                                                                                                                                                                                                                                                                                                                                                                                                                                                                                                                                                                                                                                                                                                                                                                                                                                                                                                                                                                                                                                                                                                                                                                                                                                                                                                                                                                                                                                                                                                                                                                                                                                                                                                                                                                                                                                                                                                                                                                                                                                                                                                                                      |
|--------------------------|----------------------------------------------------------------------------------------------------------------------------------------------------------------------------------------------------------------------------------------------------------------------------------------------------------------------------------------------------------------------------------------------------------------------------------------------------------------------------------------------------------------------------------------------------------------------------------------------------------------------------------------------------------------------------------------------------------------------------------------------------------------------------------------------------------------------------------------------------------------------------------------------------------------------------------------------------------------------------------------------------------------------------------------------------------------------------------------------------------------------------------------------------------------------------------------------------------------------------------------------------------------------------------------------------------------------------------------------------------------------------------------------------------------------------------------------------------------------------------------------------------------------------------------------------------------------------------------------------------------------------------------------------------------------------------------------------------------------------------------------------------------------------------------------------------------------------------------------------------------------------------------------------------------------------------------------------------------------------------------------------------------------------------------------------------------------------------------------------------------------------------------------------------------------------------------------------------------------------------------------------------------------------------|
| File Analysis Server URL | <p>Choose either: the name (URL) of an external cloud server, or <b>Private analysis cloud</b>.</p> <p>If specifying an external cloud server, choose the server that is physically nearest to your appliance. Newly available servers will be added to this list periodically using standard update processes.</p> <p>Choose Private analysis cloud to use an on-premises Cisco Secure Endpoint Malware Analytics appliance for file analysis, and provide the following:</p> <ul style="list-style-type: none"> <li>• <b>TG Servers</b> – Enter the IPv4 address or hostname of the standalone or clustered Cisco Secure Endpoint Malware Analytics appliances. You can add a maximum of seven Cisco Secure Endpoint Malware Analytics appliances.</li> </ul> <p><b>Note</b> The Serial Number indicates the order in which you add the standalone or clustered Cisco Secure Endpoint Malware Analytics appliances. It does not denote the priority of the appliances.</p> <p><b>Note</b> You cannot add standalone and cluster servers in one instance. It must be either standalone or cluster.</p> <p>You can add only one standalone server in an instance. If it is a cluster mode, you can add multiple servers upto seven and all the servers must belong to the same cluster. You cannot add multiple clusters.</p> <ul style="list-style-type: none"> <li>• <b>Certificate Authority</b> – Choose either <b>Use Cisco Default Certificate Authority</b>, or <b>Use Uploaded Certificate Authority</b>.</li> </ul> <p>If you choose <b>Use Uploaded Certificate Authority</b>, click <b>Browse</b> to upload a valid certificate file for encrypted communications between this appliance and your private cloud appliance. This must be the same certificate used by the private cloud server.</p> <p><b>Note</b> If you have configured the Cisco Secure Endpoint Malware Analytics portal on your appliance for file analysis, you can access the Cisco Secure Endpoint Malware Analytics portal (for example, <a href="https://panacea.threatgrid.eu">https://panacea.threatgrid.eu</a>) to view and track the files submitted for file analysis. For more information on how to access the Cisco Secure Endpoint Malware Analytics portal, contact Cisco TAC.</p> |
| Proxy Settings           | <p>Check <b>Use File Reputation Proxy</b> checkbox to use the same File Reputation tunnel proxy that you have already configured, as an upstream proxy for file analysis.</p> <p>If you want to configure a different upstream proxy, uncheck the <b>Use File Reputation Proxy</b> checkbox and enter the appropriate <b>Server</b>, <b>Port</b>, <b>Username</b>, and <b>Passphrase</b> information.</p>                                                                                                                                                                                                                                                                                                                                                                                                                                                                                                                                                                                                                                                                                                                                                                                                                                                                                                                                                                                                                                                                                                                                                                                                                                                                                                                                                                                                                                                                                                                                                                                                                                                                                                                                                                                                                                                                        |
| File Analysis Client ID  | The client ID for this appliance on the File Analysis server (read-only).                                                                                                                                                                                                                                                                                                                                                                                                                                                                                                                                                                                                                                                                                                                                                                                                                                                                                                                                                                                                                                                                                                                                                                                                                                                                                                                                                                                                                                                                                                                                                                                                                                                                                                                                                                                                                                                                                                                                                                                                                                                                                                                                                                                                        |

- Step 8** (Optional) Expand the Cache Settings panel, if you want to configure the cache expiry period for File Reputation disposition values.
- Step 9** Expand the Threshold Settings panel, if you want to set the upper limit for the acceptable file analysis score. The score above this threshold indicates that the file is infected. Choose any one of the following options:
- Use value from Cloud Service (95)
  - Enter Custom Value – defaults to 95
- Step 10** Submit and commit your changes.
- Step 11** If you are using an on-premises Cisco Secure Endpoint Malware Analytics appliance, activate the account for this appliance on the Cisco Secure Endpoint Malware Analytics appliance.
- Complete instructions for activating the “user” account are available in the Cisco Secure Endpoint Malware Analytics documentation.
- a) Note the File Analysis Client ID that appears at the bottom of the page section. This identifies the “user” that you will activate.
  - b) Sign in to the Cisco Secure Endpoint Malware Analytics appliance.
  - c) Select **Welcome...** > **Manage Users** and navigate to User Details.
  - d) Locate the “user” account based on the File Analysis Client ID of your Email Security appliances .
  - e) Activate this “user” account for your appliance.
- 

## Integrating the Appliance with AMP for Endpoints Console

You can integrate your appliance with AMP for Endpoints console, and perform the following actions in AMP for Endpoints console:

- Create a simple custom detection list.
- Add new malicious file SHAs to the simple custom detection list.
- Create an application allowed list.
- Add new file SHAs to the application allowed list.
- Create a custom policy.
- Attach the simple custom detection list and the application allowed list to the custom policy.
- Create a custom group.
- Attach the custom policy to the custom group.
- Move your registered appliance from the default group to the custom group.
- View the file trajectory details of a particular file SHA.

To integrate your appliance with AMP for Endpoints console, you need to register your appliance with the console.

After the integration, when a file SHA is sent to the File Reputation server, the verdict obtained for the file SHA from the File Reputation Server is overridden by the verdict already available for the same file SHA in the AMP for Endpoints console.

If a file SHA is already marked as malicious globally, and if the same file SHA is added to the blocked list in Secure Endpoint console, the file disposition is malicious.

The Advanced Malware Protection report page includes a new section - **Incoming Malware Files by Category** to view the percentage of block listed file SHAs received from the AMP for Endpoints console that are displayed as **Custom Detection**. The threat name of a block listed file SHA is displayed as **Simple Custom Detection** in the Incoming Malware Threat Files section of the report. You can click the link in the More Details section of the report to view the file trajectory details of a block listed file SHA in the AMP for Endpoints console.

### Before you begin

Make sure you have a user account in AMP for Endpoints console with admin access rights. For more details on how to create an AMP for Endpoints console user account, contact Cisco TAC.

[For clustered configuration] In a clustered configuration, you can only register your logged-in appliance with AMP for Endpoints console. If you have already registered your appliance with AMP for Endpoints console in the standalone mode, make sure to deregister the appliance manually before you join it to a cluster.

Make sure you have enabled and configured File Reputation Filtering. See [Enabling and Configuring File Reputation and Analysis Services](#) to know how to enable and configure File Reputation Filtering.

### Procedure

- 
- Step 1** Select **Security Services > File Reputation and Analysis**.
  - Step 2** Click **Edit Global Settings**.
  - Step 3** Click **Register Appliance with AMP for Endpoints** in the Advanced Settings panel for File Reputation in the File Reputation and File Analysis page of the web interface.
- Once you click Register Appliance with AMP for Endpoints, the AMP for Endpoints console login page appears.
- Step 4** Log in to the AMP for Endpoints console with your user credentials.
  - Step 5** Click **Allow** in the AMP for Endpoints authorization page to register your appliance.
- 

### What to do next

#### Next Steps:

- You can go to Accounts > Applications section of the AMP for Endpoints console page, to verify whether your appliance is registered with AMP for Endpoints console. Your appliance name is displayed in the Applications section of the AMP for Endpoints console page.
- After registration, your appliance is added to the default group (Audit Group) which has a default policy (Network Policy) attached to it. The default policy contains file SHAs that are added to the blocked list or the allowed list. If you want to customize the AMP for Endpoints settings for your appliance, and add your own file SHAs that are added to the blocked list or the allowed list, see the AMP for Endpoints user documentation at <https://console.amp.cisco.com/docs>.
- Make sure that the 'File Reputation Client ID' value in the File Reputation Settings page and the 'Device GUID' value of your registered appliance in the AMP for Endpoints console portal is the same. If the values are different, the integration of your appliance with AMP for Endpoints will not work properly.



at the machine or cluster level. You will need to deregister and register your appliance again to use the AMP for Endpoints functionality.

- To deregister your appliance connection from AMP for Endpoints console, you can click **Deregister** in the Advanced Settings for File Reputation section in your appliance, or you need to go to the AMP for Endpoints console page at <https://console.amp.cisco.com/>. For more information, see the AMP for Endpoints user documentation at <https://console.amp.cisco.com/docs>.



---

**Note** When you change your File Reputation server to a different data center, your appliance is automatically deregistered from the AMP for Endpoints console. You must re-register your appliance with AMP for Endpoints console with the same data center selected for the File Reputation server.

---



---

**Note** If you change your file reputation server at the cluster level, your logged-in appliance is automatically deregistered from the AMP for Endpoints console. Ensure that you deregister all the other machines in the cluster. You must re-register all your appliances with AMP for Endpoints console with the same data center selected for the File Reputation server

---



---

**Note** If a malicious file SHA gets a clean verdict, then verify whether the same file SHA is added to the allowed list in AMP for Endpoints console.

---

## Important! Changes Needed in File Analysis Setting

If you plan to use a new public cloud File Analysis service, make sure you read the following instructions to maintain datacenter isolation:

- The existing appliance grouping information is not preserved in the new File Analysis server. You must regroup your appliances on the new File Analysis server.
- Messages that are quarantined to the File Analysis Quarantine are retained until the retention period. After the quarantine retention period, the messages are released from the File Analysis Quarantine, and re-scanned by the AMP engine. The file is then uploaded to the new File Analysis server for analysis but the message is not sent to the File Analysis Quarantine again.

For more details, refer to the Cisco AMP Malware Analytics documentation from <http://www.cisco.com/c/en/us/support/security/amp-threat-grid-appliances/products-installation-guides-list.html>.

## (Public Cloud File Analysis Services Only) Configuring Appliance Groups

To allow all content security appliances in your organization to view file analysis result details in the cloud for files sent for analysis from any appliance in your organization, you need to join all appliances to the same appliance group. You can configure appliance groups at the machine or the cluster level.

**Before you begin:**

- Ensure that all the machines in the cluster are working.
- Ensure that you have connected to the configured File Analysis server of your region and the server is working.



---

**Note** If you load a license keys file that does not contain the 'cloud admin feature' key in the on-premises virtual email gateway, you can still perform auto-registration of Threat Group File Analysis using the Smart License Account ID.

---

### Procedure

---

- Step 1** Select **Security Services > File Reputation and Analysis**.
- Step 2** Click the **Click here to group or view Email Gateway for File Analysis reporting** option to create the Appliance Group.
- Step 3** [Applicable if Smart Licensing is disabled on your email gateway] Enter the group ID manually in the **Appliance ID/Name** field and click **Group Now**.

Or

[Applicable if Smart Licensing is enabled on your email gateway] The system automatically registers the Smart Account ID as group ID and displays it in the **Appliance Group ID/Name** field.

#### Notes:

- An appliance can belong to only one group.
  - You can add a machine to a group at any time.
  - You can configure appliance groups at the machine and the cluster levels.
  - If this is the first appliance being added to the group, provide a useful identifier for the group. This ID is case-sensitive and cannot contain spaces.
  - The appliance group ID you provide must be identical on all appliances that will share data about files that are uploaded for analysis. However, the ID is not validated on subsequent appliances in the group.
  - If you update the appliance group ID, the change takes effect immediately, and it does not require a Commit.
  - You must configure all appliances in a group to use the same File Analysis server in the cloud.
  - If Smart Licensing is enabled, the appliances are grouped using the Smart Account ID.
- 

## Updating Appliance Group Name for File Analysis Reporting

### Procedure

---

- Step 1** Select **Security Services > File Reputation and Analysis**.
- Step 2** Click the **Click here to group or view Email Gateway for File Analysis reporting** option.
- Step 3** Click **Change Group** in the Appliance Grouping for File Analysis Reporting page.

**Note** You can also use the `ampconfig > setgroup` sub command in the CLI to change the group ID.

**Step 4** Enter a name or ID in the **Appliance Group ID/Name** field and click **Group Now**.

**Note** You must individually update the group name for all the appliances in a specific group.

## Which Appliances Are In the Analysis Group?

### Procedure

- Step 1** Select **Security Services > File Reputation and Analysis**.
- Step 2** Click the **Click here to group or view Email Gateway for File Analysis reporting** option.
- Step 3** Click **View Appliances** to view the appliances added in a specific File Analysis Group.

## Viewing Alerts for File Analysis Grouping

The following table lists the system alerts generated for the Appliance Grouping for File Analysis reporting, including a description of the alert and the alert severity.

| Component/Alert Name  | Message and Description                                                                                                                                                                                                                                                                                                     | Parameter                          |
|-----------------------|-----------------------------------------------------------------------------------------------------------------------------------------------------------------------------------------------------------------------------------------------------------------------------------------------------------------------------|------------------------------------|
| AMP.ENGINE.ALERT.WARN | Alert text: Failed to register the file analysis group name with Cisco Threat Grid server. Contact Cisco TAC for assistance.<br><br>Alert level: WARNING.<br><br>Description: Alert is sent when the email gateway fails to register the Appliance Group name using the Smart Account ID with the Cisco Threat Grid server. | Parameters: Reason for the failure |

## Configuring the Mail Policy for File Reputation Scanning and File Analysis

### Procedure

- Step 1** Select **Mail Policies > Incoming Mail Policies** or **Mail Policies > Outgoing Mail Policies**, whichever is applicable.
- Step 2** Click the link in the **Advanced Malware Protection** column of the mail policy to modify.
- Step 3** Choose options.
- If you do not have an on-premises Cisco AMP Threat Grid Appliance and you do not want to send files to the cloud, for example for confidentiality reasons, uncheck **Enable File Analysis**.

- Select the actions that the appliance must perform if an attachment is considered as Unscannable. Attachments are considered Unscannable when the appliance is unable to scan the file for the following reasons:
  - **Message Errors:**
    - Password-protected archived or compressed file
    - Messages with RFC violation.
    - Messages that contain more than 200 child files
    - Messages that contain more than five nested levels of child files
    - Messages with extraction failure
  - **Rate Limit** - The files that are not scanned by the File Analysis server because the appliance has reached the file upload limit.
  - **AMP Service not available:**
    - File Reputation service is not available
    - File Analysis service is not available
    - File reputation query timeout
    - File upload query timeout
- You can configure any one of the following message handling actions on messages that are not scanned by the AMP engine:
  - Drop the message
  - Deliver the message as it is
  - Send the message to the policy quarantine
- Select the following additional actions, if you choose to deliver the message:
  - Whether to archive the original message. Archived messages are stored as an mbox-format log file in the amparchive directory on the appliance. The preconfigured AMP Archive ( amparchive ) log subscription is required.
  - Whether to warn the end user by modifying the message subject, for example, [WARNING: ATTACHMENT(S) MAY CONTAIN MALWARE].
  - Whether to add a custom header to provide granular controls to the administrator.
  - Whether to modify the message recipient causing the message to be delivered to a different address. Click Yes and enter the new recipient address.
  - Whether to send the unscannable messages to an alternate destination host. Click Yes and enter an alternate IP address or hostname.
- Select the following additional actions, if you choose to send the message to the policy quarantine:

- Whether to select a policy quarantine from the drop-down. When flagged for quarantine, the message is placed in the quarantine when it reaches the end of the email pipeline, and is scanned by all the other engines in the email pipeline.
  - Whether to archive the original message. Archived messages are stored as an mbox-format log file in the amparchive directory on the appliance. The preconfigured AMP Archive ( amparchive ) log subscription is required.
  - Whether to warn the end user by modifying the message subject, for example, [WARNING: ATTACHMENT(S) MAY CONTAIN MALWARE].
  - Whether to add a custom header to provide granular controls to the administrator.
- Select the actions that AsyncOS must perform if an attachment is considered Malicious. Select the following:
    - Whether to deliver or drop the message.
    - Whether to archive the original message. Archived messages are stored as an mbox-format log file in the amparchive directory on the appliance. The preconfigured AMP Archive ( amparchive ) log subscription is required.
    - Whether to deliver the message after removing the malware attachments.
    - Whether to warn the end user by modifying the message subject, for example, [WARNING: MALWARE DETECTED IN ATTACHMENT(S)].
    - Whether to add a custom header to provide granular controls to the administrator.
    - Whether to modify the message recipient causing the message to be delivered to a different address. Click **Yes** and enter the new recipient address.
    - Whether to send the malicious messages to an alternate destination host. Click **Yes** and enter an alternate IP address or hostname.
  - Select the actions that AsyncOS must perform if an attachment is sent for File Analysis. Select the following:
    - Whether to deliver or quarantine the message.
    - Whether to archive the original message. Archived messages are stored as an mbox-format log file in the amparchive directory on the appliance. The preconfigured AMP Archive ( amparchive ) log subscription is required.
    - Whether to warn the end user by modifying the message subject, for example, “[WARNING: ATTACHMENT(S) MAY CONTAIN MALWARE] .”
    - Whether to add a custom header to provide granular controls to the administrator.
    - Whether to modify the message recipient causing the message to be delivered to a different address. Click **Yes** and enter the new recipient address.
    - Whether to send the messages that are sent for file analysis to an alternate destination host. Click **Yes** and enter an alternate IP address or hostname.

- (For Incoming Mail Policy only) Configure the remedial actions to be performed on messages delivered to end users when the threat verdict changes to malicious. Select Enable Mailbox Auto Remediation and select one of the following actions:
    - Forward to an email address. Select this option to forward the message with malicious attachment to a specified user, for example, an email administrator.
    - Delete the message. Select this option to permanently delete the message with malicious attachment from the end user's mailbox.
    - Forward to an email address and delete the message. Select this option to forward the message with malicious attachment to a specified user, for example, an email administrator and permanently delete that message from the end user's mailbox.
- Note** Messages from certain folders (for example, Deleted Items) cannot be deleted as Office 365 services do not support deletion of messages from these folders.
- Important** Before configuring the Mailbox Auto Remediation settings, review [Remediating Messages in Mailboxes, on page 573](#)

**Step 4** Submit and commit your changes.

---

## Quarantining Messages with Attachments Sent for Analysis

You can configure the appliance to quarantine files sent for analysis instead of releasing them immediately to the workqueue. Quarantined messages and their attachments are rescanned for threats upon release from quarantine. If the message is released after file analysis results are available to the reputation scanner, any identified threats will be caught during rescanning.

### Procedure

---

- Step 1** Select **Mail Policies > Incoming Mail Policies** or **Mail Policies > Outgoing Mail Policies**, whichever is applicable.
- Step 2** Click the link in the **Advanced Malware Protection** column of the mail policy to modify.
- Step 3** Under Messages with File Analysis Pending section, select **Quarantine** from the Action Applied to Message drop-down.
- The quarantined messages are stored in the File Analysis quarantine. See [Using the File Analysis Quarantine, on page 495](#).
- Step 4** (Optional) Under Messages with File Analysis Pending section, choose the following options:
- Whether to archive the original message. Archived messages are stored as an mbox-format log file in the amparchive directory on the appliance. The preconfigured AMP Archive ( amparchive ) log subscription is required.
  - Whether to warn the end user by modifying the message subject, for example, “[WARNING: ATTACHMENT(S) MAY CONTAIN MALWARE] .”

- Whether to drop attachments in case of any pending file analysis verdict while delivering the final message from the appliance. The default option is 'No'
- Whether to add a custom header to provide granular controls to the administrator.

**Note** The above actions mentioned in step4 are applicable only when a message is released from the quarantine and not when the message is sent to the quarantine:

- Archiving the original message.
- Modifying a message subject.
- Adding a custom header.

**Step 5** Submit and commit your changes.

---

#### What to do next

#### Related Topics

[Using the File Analysis Quarantine, on page 495](#)

## Using the File Analysis Quarantine

- [Edit File Analysis Quarantine Settings, on page 495](#)
- [Manually Processing Messages in the File Analysis Quarantine, on page 496](#)

### Edit File Analysis Quarantine Settings

#### Procedure

---

- Step 1** Select **Monitor > Policy, Virus, and Outbreak Quarantines**.
- Step 2** Click the **File Analysis** quarantine link.
- Step 3** Specify the retention period.  
Changing the default from one hour is not recommended.
- Step 4** Specify the default action that AsyncOS must take after the retention period has passed.
- Step 5** If you do *not* want messages in this quarantine to be processed before the end of the Retention Period you specify, even when quarantine disk space is full, deselect **Free up space by applying default action on messages upon space overflow**.
- Step 6** If you select **Release** as the Default Action, optionally specify additional actions to apply to messages that are released before their retention period has passed:

| Option            | Information                                                                                                                                                                                                                                                                                                                                                       |
|-------------------|-------------------------------------------------------------------------------------------------------------------------------------------------------------------------------------------------------------------------------------------------------------------------------------------------------------------------------------------------------------------|
| Modify Subject    | Type the text to add and specify whether to add it to the beginning or the end of the original message subject.<br><br>For example, you might want to warn the recipient that the message may contain malware attachments.<br><br><b>Note</b> In order for a subject with non-ASCII characters to display correctly it must be represented according to RFC 2047. |
| Add X-Header      | An X-Header can provide a record of actions taken on a message. This can be helpful for example when handling inquiries about why a particular message was delivered.<br><br>Enter a name and value.<br><br>Example:<br>Name = Inappropriate-release-early<br>Value = True                                                                                        |
| Strip Attachments | Stripping attachments protects against malware attachments in messages.                                                                                                                                                                                                                                                                                           |

**Step 7** Specify the users who can access this quarantine:

| User                           | Information                                                                                                                                                                                                   |
|--------------------------------|---------------------------------------------------------------------------------------------------------------------------------------------------------------------------------------------------------------|
| Local Users                    | The list of local users includes only users with roles that can access quarantines.<br><br>The list excludes users with Administrator privileges, because all Administrators have full access to quarantines. |
| Externally Authenticated Users | You must have configured external authentication.                                                                                                                                                             |
| Custom User Roles              | You see this option only if you have created at least one custom user role with quarantine access.                                                                                                            |

**Step 8** Submit and commit your changes.

## Manually Processing Messages in the File Analysis Quarantine

### Procedure

**Step 1** Select **Monitor > Policy, Virus, and Outbreak Quarantines**.

**Step 2** In the row for File Analysis quarantine, click the blue number in the Messages column of the table.

**Step 3** Depending on your requirements, perform the following actions on messages:

- Delete
- Release



- Delay Scheduled Exit from quarantine
- Send a copy of messages to email addresses that you specify

## Centralized File Analysis Quarantine

For information about the centralized File Analysis quarantine, see chapter "*Centralized Policy, Virus and Outbreak Quarantine*" of the *Cisco Email Security Appliance Guide*.

## X-Headers for File Reputation and Analysis

You can use X-Headers to mark messages with actions and results of message processing steps. You tag messages with X-Headers in mail policies, then use content filters to choose handling options and final actions for these messages.

Values are case-sensitive.

| Header Name            | Possible Values (Case Sensitive)  | Description                                                                                                                             |
|------------------------|-----------------------------------|-----------------------------------------------------------------------------------------------------------------------------------------|
| X-Amp-Result           | Clean<br>Malicious<br>Unscannable | Verdict applied to messages processed by the file reputation service.                                                                   |
| X-Amp-Original-Verdict | file unknown<br>verdict unknown   | Verdict before adjustment based on reputation threshold. This header exists only if the original verdict is one of the possible values. |
| X-Amp-File-Uploaded    | true<br>false                     | If any file attached to a message was sent for analysis, this header is "true."                                                         |

## Sending Notifications to End Users about Dropped Messages or Attachments

To send notifications to end users when a suspect attachment or its parent message has been dropped based on file reputation scanning, use an X-header or Custom Header and Content Filters.

## Advanced Malware Protection and Clusters

If you use centralized management, you can enable Advanced Malware Protection and mail policies at the cluster, group and machine level.

Feature keys must be added at the machine level.

Appliance Groups should not be configured at cluster level.

## Ensuring That You Receive Alerts About Advanced Malware Protection Issues

Ensure that the appliance is configured to send you alerts related to Advanced Malware Protection.

You will receive alerts when:

| Alert Description                                                                                                                                                                                                                                         | Type                              | Severity |
|-----------------------------------------------------------------------------------------------------------------------------------------------------------------------------------------------------------------------------------------------------------|-----------------------------------|----------|
| You are setting up a connection to an on-premises (private cloud) Cisco Secure Endpoint Malware Analytics appliance and you need to activate the account as described in <a href="#">Enabling and Configuring File Reputation and Analysis Services</a> . | Anti-Malware                      | Warning  |
| Feature keys expire                                                                                                                                                                                                                                       | (As is standard for all features) |          |
| The file reputation or file analysis service is unreachable.                                                                                                                                                                                              | Anti-Virus and AMP                | Warning  |
| Communication with cloud services is established.                                                                                                                                                                                                         | Anti-Virus and AMP                | Info     |
| The reputation and analysis engine is restarted by a watchdog service                                                                                                                                                                                     | Anti-Virus and AMP                | Info     |
| A file reputation verdict changes.                                                                                                                                                                                                                        | Anti-Virus and AMP                | Info     |
| File types that can be sent for analysis have changed. You may want to enable upload of new file types.                                                                                                                                                   | Anti-Virus and AMP                | Info     |
| Analysis of some file types is temporarily unavailable.                                                                                                                                                                                                   | Anti-Virus and AMP                | Warning  |
| Analysis of all supported file types is restored after a temporary outage.                                                                                                                                                                                | Anti-Virus and AMP                | Info     |
| Invalid File Analysis service key. You need to contact Cisco TAC with the file analysis id details to fix this error.                                                                                                                                     | AMP                               | Error    |

### Related Topics

- [Several Alerts About Failure to Connect to File Reputation or File Analysis Servers](#) , on page 502
- [Taking Action When File Threat Verdicts Change](#) , on page 501

## Configuring Centralized Reporting for Advanced Malware Protection Features

If you will centralize reporting on a Security Management appliance, see important configuration requirements in the Advanced Malware Protection sections in the email reporting topic of the online help or user guide for your management appliance.

# File Reputation and File Analysis Reporting and Tracking

- [Identifying Files by SHA-256 Hash](#) , on page 499
- [File Reputation and File Analysis Report Pages](#), on page 499
- [Viewing File Reputation Filtering Data in Other Reports](#) , on page 500
- [About Message Tracking and Advanced Malware Protection Features](#) , on page 500

## Identifying Files by SHA-256 Hash

Because filenames can easily be changed, the appliance generates an identifier for each file using a Secure Hash Algorithm (SHA-256). If an appliance processes the same file with different names, all instances are recognized as the same SHA-256. If multiple appliances process the same file, all instances of the file have the same SHA-256 identifier.

In most reports, files are listed by their SHA-256 value (in an abbreviated format)

## File Reputation and File Analysis Report Pages

| Report                      | Description                                                                                                                                                                                                                                                                                                                                                                                                                                                                                                                                                                                                                                                                                                                                                                                                                                                                                                                                                                                                                                                                                                                                                         |
|-----------------------------|---------------------------------------------------------------------------------------------------------------------------------------------------------------------------------------------------------------------------------------------------------------------------------------------------------------------------------------------------------------------------------------------------------------------------------------------------------------------------------------------------------------------------------------------------------------------------------------------------------------------------------------------------------------------------------------------------------------------------------------------------------------------------------------------------------------------------------------------------------------------------------------------------------------------------------------------------------------------------------------------------------------------------------------------------------------------------------------------------------------------------------------------------------------------|
| Advanced Malware Protection | <p>Shows file-based threats that were identified by the file reputation service.</p> <p>For files with changed verdicts, see the AMP Verdict updates report. Those verdicts are not reflected in the Advanced Malware Protection report.</p> <p>If a file extracted from a compressed or archived file is malicious, only the SHA value of the compressed or archived file is included in the Advanced Malware Protection report.</p> <p>The <b>Incoming Malware Files by Category</b> section shows the percentage of file SHAs on the blocked list received from the AMP for Endpoints console that are categorised as <b>Custom Detection</b>.</p> <p>The threat name of file SHA on the blocked list obtained from AMP for Endpoints console is displayed as <b>Simple Custom Detection</b> in the Incoming Malware Threat Files section of the report.</p> <p>You can click the link in the More Details section of the report to view the file trajectory details about file SHA on the blocked list in the AMP for Endpoints console.</p> <p>You can view the <b>Low Risk</b> verdict details in the Incoming Files Handed by AMP section of the report.</p> |

| Report                                    | Description                                                                                                                                                                                                                                                                                                                                                                                                                                                                                                                                                                                                                                                                                                                                                                                                                         |
|-------------------------------------------|-------------------------------------------------------------------------------------------------------------------------------------------------------------------------------------------------------------------------------------------------------------------------------------------------------------------------------------------------------------------------------------------------------------------------------------------------------------------------------------------------------------------------------------------------------------------------------------------------------------------------------------------------------------------------------------------------------------------------------------------------------------------------------------------------------------------------------------|
| Advanced Malware Protection File Analysis | <p>Displays the time and verdict (or interim verdict) for each file sent for analysis. The appliance checks for analysis results every 30 minutes.</p> <p>To view more than 1000 File Analysis results, export the data as a .csv file.</p> <p>Drill down to view detailed analysis results, including the threat characteristics for each file.</p> <p>You can also search for additional information about an SHA, or click the link at the bottom of the file analysis details page to view additional details on the server that analyzed the file.</p> <p><b>Note</b> If extracted files from a compressed or an archive file are sent for file analysis, only SHA values of these extracted files are included in the File Analysis report.</p>                                                                               |
| Advanced Malware Protection Reputation    | <p>Because Advanced Malware Protection is focused on targeted and zero-day threats, threat verdicts can change as aggregated data provides more information.</p> <p>The AMP Reputation report lists the files processed by this appliance for which the verdict has changed since the message was received. For more information about this situation, see <a href="#">File Threat Verdict Updates</a>, on page 477.</p> <p>To view more than 1000 verdict updates, export the data as a .csv file.</p> <p>In the case of multiple verdict changes for a single SHA-256, this report shows only the latest verdict, not the verdict history.</p> <p>To view all affected messages for a particular SHA-256 within the maximum available time range (regardless of the time range selected for the report) click a SHA-256 link.</p> |

## Viewing File Reputation Filtering Data in Other Reports

Data for file reputation and analysis is available in other reports where relevant. A "Detected by Advanced Malware Protection" column may be hidden by default in applicable reports. To display additional columns, click the Columns link below the table.

## About Message Tracking and Advanced Malware Protection Features

When searching for file threat information in Message Tracking, keep the following points in mind:

- To search for malicious files found by the file reputation service, select **Advanced Malware Protection Positive** for the Message Event option in the Advanced section in Web Message Tracking.
- Message Tracking includes only information about file reputation processing and the original file reputation verdicts returned at the time a transaction message was processed. For example, if a file was initially

found to be clean, then a verdict update found the file to be malicious, only the clean verdict appears in Tracking results.

In Message Tracking details, the Processing Details section shows:

- The SHA-256 of each attachment in the message, and
  - The final Advanced Malware Protection verdict for the message as a whole, and
  - Any attachments which were found to contain malware.
- Verdict updates are available only in the AMP Verdict Updates report. The original message details in Message Tracking are not updated with verdict changes. To see transactions messages that have a particular attachment, click a SHA-256 in the verdict updates report.
  - Information about File Analysis, including analysis results and whether or not a file was sent for analysis, are available only in the File Analysis report.

Additional information about an analyzed file may be available from the cloud or on-premises File Analysis server. To view any available File Analysis information for a file, select **Reporting Monitor > File Analysis** and enter the SHA-256 to search for the file. If the File Analysis service has analyzed the file from any source, you can see the details. Results are displayed only for files that have been analyzed.

If the appliance processed a subsequent instance of a file that was sent for analysis, those instances will appear in Message Tracking search results.

## Taking Action When File Threat Verdicts Change

### Procedure

---

- Step 1** View the AMP Verdict Updates report.
  - Step 2** Click the relevant SHA-256 link to view message tracking data for all messages that contained that file that may have been delivered to end users.
  - Step 3** Using the tracking data, identify the users that may have been compromised, as well as information such as the file names involved in the breach and sender of the file.
  - Step 4** Check the File Analysis report to see if this SHA-256 was sent for analysis, to understand the threat behavior of the file in more detail.
- 

### What to do next

#### Related Topics

[File Threat Verdict Updates](#), on page 477

## Troubleshooting File Reputation and Analysis

- [Log Files](#), on page 502

- [Using Trace](#) , on page 502
- [Several Alerts About Failure to Connect to File Reputation or File Analysis Servers](#) , on page 502
- [API Key Error \(On-Premises File Analysis\)](#) , on page 503
- [Files are Not Uploaded As Expected](#) , on page 504
- [Alerts about File Types That Can Be Sent for Analysis](#) , on page 504

## Log Files

In logs:

- `AMP` and `amp` refer to the file reputation service or engine.
- `Retrospective` refers to verdict updates.
- `VRT` and `sandboxing` refer to the file analysis service.

Information about Advanced Malware Protection including File Analysis is logged in AMP Engine Logs.

File reputation filtering and analysis events are logged in AMP Engine logs and Mail logs.

In the log message “Response received for file reputation query” possible values for “upload action” are:

- 1: SEND. In this case, you must send the file for File Analysis.
- 2: DON’T SEND. In this case, you do not send the file for File Analysis.
- 3: SEND ONLY METADATA. In this case, you send only the metadata and not the entire file for File Analysis.
- 0: NO ACTION. In this case, no other action is required.

For “Disposition” in mail logs:

- 1: No malware detected or presumed clean (treated as clean)
- 2: Clean
- 3: Malware

Spyname is threat name.

## Using Trace

Trace is not available for the file reputation filtering and analysis features. Instead, send a test message from an account outside your organization.

## Several Alerts About Failure to Connect to File Reputation or File Analysis Servers

### Problem

You receive several alerts about failures to connect to the file reputation or analysis services in the cloud. (A single alert may indicate only a transient issue.)

**Solution**

- Ensure that you have met the requirements in [Requirements for Communication with File Reputation and Analysis Services](#) , on page 481.
- Check for network issues that may prevent the appliance from communicating with the cloud services.
- Increase the Query Timeout value:  
Select **Security Services > File Reputation and Analysis**. The Query Timeout value is in the Advanced settings area .

## API Key Error (On-Premises File Analysis)

**Problem**

You receive an API key alert when attempting to view File Analysis report details, or the Email Security appliance is unable to connect to the AMP Malware Analytics server to upload files for analysis.

**Solution**

This error can occur if you change the hostname of the AMP Malware Analytics server and you are using a self-signed certificate from the AMP Malware Analytics server, as well as possibly under other circumstances. To resolve the issue:

- Generate a new certificate from the AMP Malware Analytics appliance that has the new hostname.
- Upload the new certificate to the Email Security appliance .
- Reset the API key on the AMP Malware Analytics appliance. For instructions, see the online help on the AMP Malware Analytics appliance.

**Related Topics**

- [Enabling and Configuring File Reputation and Analysis Services](#)

## API Key Error (Public Cloud File Analysis)

**Problem**

You receive an API key alert when attempting to view or group the appliances for File Analysis reporting or when your email gateway cannot connect to the Cisco Threat Grid server to upload files for analysis.

**Solution**

This error can occur if the Cisco Threat Grid server is not reachable. Check the following and try to connect again:

- You have connected to the correct Threat Grid server for your region.
- The Threat Grid server is currently working.

**Related Topics**

- [\(Public Cloud File Analysis Services Only\) Configuring Appliance Groups](#) , on page 489

## Files are Not Uploaded As Expected

### Problem

Files are not evaluated or analyzed as expected. There is no alert or obvious error.

### Solution

Consider the following:

- The file may have been sent for analysis by another appliance and thus already be present on the File Analysis server or in the cache of the appliance that is processing the file.

## Alerts about File Types That Can Be Sent for Analysis

### Problem

You receive alerts of severity Info about file types that can be sent for file analysis.

### Solution

This alert is sent when supported file types change, or when the appliance checks to see what file types are supported. This can occur when:

- You or another administrator changes the file types selected for analysis.
- Supported file types change temporarily based on availability in the cloud service. In this case, support for the file types selected on the appliance will be restored as soon as possible. Both processes are dynamic and do not require any action from you.
- The appliance restarts, for example as part of an AsyncOS upgrade.





# CHAPTER 22

## Data Loss Prevention

This chapter contains the following sections:

- [Overview of Data Loss Prevention](#) , on page 505
- [System Requirements for Data Loss Prevention](#) , on page 507
- [How to Set Up Data Loss Prevention](#) , on page 507
- [Enabling Data Loss Prevention \(DLP\)](#) , on page 508
- [Policies for Data Loss Prevention](#), on page 508
- [Message Actions](#), on page 526
- [Displaying Sensitive DLP Data in Message Tracking](#) , on page 531
- [About Updating the DLP Engine and Content Matching Classifiers](#), on page 532
- [Working with DLP Incident Messages and Data](#) , on page 533
- [Troubleshooting Data Loss Prevention](#), on page 534

## Overview of Data Loss Prevention

The Data Loss Prevention (DLP) feature secures your organization’s proprietary information and intellectual property and enforces compliance with government regulations by preventing users from maliciously or unintentionally emailing sensitive data from your network. You define the types of data that your employees are not allowed to email by creating DLP policies that are used to scan outgoing messages for any data that may violate laws or corporate policies.

### Related Topics

- [Overview of the DLP Scanning Process](#) , on page 505
- [How Data Loss Prevention Works](#) , on page 506

## Overview of the DLP Scanning Process

|    | Action                                                                                          | More Information                                                                                                                                         |
|----|-------------------------------------------------------------------------------------------------|----------------------------------------------------------------------------------------------------------------------------------------------------------|
| 1. | A user in your organization sends an email message to a recipient outside of your organization. | The email gateway processes messages that are entering or leaving your network.<br><br>Messages sent to other users within your network are not scanned. |

|    | Action                                                                                                                                                                                                                                                                                                                           | More Information                                                                                                                                                                                                                               |
|----|----------------------------------------------------------------------------------------------------------------------------------------------------------------------------------------------------------------------------------------------------------------------------------------------------------------------------------|------------------------------------------------------------------------------------------------------------------------------------------------------------------------------------------------------------------------------------------------|
| 2. | The email gateway processes the message through the stages of its email “work queue” before it reaches the DLP scanning stage.                                                                                                                                                                                                   | Pre-DLP-scanning processes ensure, for example, that the message includes no spam or malware.<br><br>To see where DLP processing occurs in the workqueue, see the workqueue flow diagram in <a href="#">Email Pipeline Flows, on page 53</a> . |
| 3. | The email gateway scans the message body, header, and attachments for sensitive content that you have identified in DLP Policies.                                                                                                                                                                                                | See <a href="#">How Data Loss Prevention Works , on page 506</a> .                                                                                                                                                                             |
| 4. | If sensitive content is found, the email gateway takes action to protect the data, such as quarantining the message, dropping it, or delivering it with restrictions.<br><br>Otherwise, the message continues through the email gateway's work queue and if no issues are found, the email gateway delivers it to the recipient. | You define the actions to be taken. See <a href="#">Message Actions, on page 526</a> .                                                                                                                                                         |

## How Data Loss Prevention Works

When someone in your organization sends a message to a recipient outside your organization, the email gateway determines which outgoing mail policy applies to the sender or recipient of that message, based on rules that you defined. The email gateway evaluates the content of the message using the DLP policies that are specified in that outgoing mail policy.

Specifically, the email gateway scans the message content (including headers and attachments) for text that matches words, phrases, predefined patterns such as social security numbers, or a regular expression that you identified as sensitive content in an applicable DLP policy.

The email gateway also evaluates the context of disallowed content in order to minimize false positive matches. For example, a number matching a credit card number pattern is only a violation if it is accompanied by an expiration date, credit card company name (Visa, AMEX, etc.), or a person's name and address.

If message content matches more than one DLP policy, the first matching DLP policy in the list applies, based on the order that you specified. If an outgoing mail policy has multiple DLP policies that use the same criteria to determine whether content is a violation, all policies use the result from a single content scan.

When potentially sensitive content appears in a message, the email gateway assigns a risk factor score between 0 - 100 to the potential violation. This score indicates the likelihood that the message contains a DLP violation.

The email gateway then assigns the severity level (such as Critical or Low) that you have defined for that risk factor score, and performs the message action that you have specified for that severity level in the applicable DLP Policy.

# System Requirements for Data Loss Prevention

Data Loss Prevention is supported on all supported C-Series and X-Series appliances except appliances using D-Mode licenses.

## How to Set Up Data Loss Prevention

Perform these steps in order:

### Procedure

|               | Command or Action                                                                                                                                                                                                            | Purpose                                                                                                                                                                                                                                                                                                                 |
|---------------|------------------------------------------------------------------------------------------------------------------------------------------------------------------------------------------------------------------------------|-------------------------------------------------------------------------------------------------------------------------------------------------------------------------------------------------------------------------------------------------------------------------------------------------------------------------|
| <b>Step 1</b> | Enable the DLP feature.                                                                                                                                                                                                      | <a href="#">Enabling Data Loss Prevention (DLP)</a> , on page 508                                                                                                                                                                                                                                                       |
| <b>Step 2</b> | Define the possible actions that can be taken for messages in which violations are found or suspected. For example, you can quarantine such messages.                                                                        | <a href="#">Message Actions</a> , on page 526                                                                                                                                                                                                                                                                           |
| <b>Step 3</b> | Create DLP policies, which: <ul style="list-style-type: none"> <li>• identify the content that must not be emailed from your organization, and</li> <li>• specify which actions will be taken for each violation.</li> </ul> | Choose a method: <ul style="list-style-type: none"> <li>• <a href="#">Setting Up DLP Prevention Using a Wizard</a> , on page 509</li> <li>• <a href="#">Creating a DLP Policy Using a Predefined Template</a> , on page 511</li> <li>• <a href="#">Creating a Custom DLP Policy (Advanced)</a> , on page 512</li> </ul> |
| <b>Step 4</b> | Set the order of the DLP policies to determine which DLP policy is used to evaluate messages for DLP violations when the content could match more than one DLP policy.                                                       | <a href="#">Arranging the Order of the Email DLP Policies for Violation Matching</a> , on page 525                                                                                                                                                                                                                      |
| <b>Step 5</b> | Ensure that you have created Outgoing Mail Policies for each group of senders and recipients whose messages will be scanned for DLP violations.                                                                              | See <a href="#">Mail Policies</a> , on page 255<br>To further refine permitted and restricted message senders and recipients in individual DLP policies, see <a href="#">Filtering Messages for DLP Policies</a> , on page 523.                                                                                         |
| <b>Step 6</b> | Specify which DLP policies apply to which senders and recipients by assigning DLP policies to Outgoing Mail Policies.                                                                                                        | <a href="#">Associating DLP Policies with Outgoing Mail Policies</a> , on page 525                                                                                                                                                                                                                                      |
| <b>Step 7</b> | Configure settings for storage of and access to sensitive DLP information.                                                                                                                                                   | <ul style="list-style-type: none"> <li>• <a href="#">Displaying Sensitive DLP Data in Message Tracking</a> , on page 531</li> <li>• <a href="#">Controlling Access to Sensitive Information in Message Tracking</a>, on page 977</li> </ul>                                                                             |

# Enabling Data Loss Prevention (DLP)

## Procedure

---

**Step 1** Select **Security Services > Data Loss Prevention**.

**Step 2** Click **Enable**.

**Step 3** Scroll to the bottom of the license agreement page and click **Accept** to accept the agreement.

**Note** If you do not accept the license agreement, DLP is not enabled on the email gateway.

**Step 4** Under **Data Loss Prevention Global Settings**, select **Enable Data Loss Prevention**.

**Step 5** (Recommended) For now, deselect the other options on this page.

You can change these settings later, following instructions discussed elsewhere in this chapter.

**Step 6** Submit and commit your changes.

---

## What to do next

See [How to Set Up Data Loss Prevention](#) , on page 507.

## Related Topics

- [Displaying Sensitive DLP Data in Message Tracking](#) , on page 531
- [Setting Up DLP Prevention Using a Wizard](#) , on page 509
- [About Updating the DLP Engine and Content Matching Classifiers](#), on page 532

# Policies for Data Loss Prevention

## Related Topics

- [DLP Policy Description](#) , on page 509
- [Predefined DLP Policy Templates](#), on page 509
- [Setting Up DLP Prevention Using a Wizard](#) , on page 509
- [Creating a DLP Policy Using a Predefined Template](#) , on page 511
- [Creating a Custom DLP Policy \(Advanced\)](#) , on page 512
- [About Defining Disallowed Content Using Content Matching Classifiers](#) , on page 513
- [Filtering Messages for DLP Policies](#), on page 523
- [About Assessing Violation Severity](#) , on page 524
- [Arranging the Order of the Email DLP Policies for Violation Matching](#) , on page 525
- [Associating DLP Policies with the Default Outgoing Mail Policy](#) , on page 525
- [Important Information About Editing or Deleting DLP Policies](#) , on page 526

## DLP Policy Description

A DLP policy includes:

- a set of conditions that determine whether an outgoing message contains sensitive data, and
- the actions to be taken when a message contains such data.

You specify how message content is evaluated, based on:

- Specific disallowed content or patterns of information. Depending on the policy, you may need to create a regular expression to search for identification numbers. See [About Defining Disallowed Content Using Content Matching Classifiers](#), on page 513.
- A list of specific senders and recipients for filtering messages. See [Filtering Messages for DLP Policies](#), on page 523.
- A list of attachment file types for filtering messages. See [Filtering Messages for DLP Policies](#), on page 523.
- Settings that allow different actions to occur based on the severity of the violation. See [About Assessing Violation Severity](#), on page 524.

You determine the message senders and recipients that each policy applies to when you enable DLP policies in Outgoing Mail Policies.

## Predefined DLP Policy Templates

To simplify creation of DLP policies, your email gateway includes a large collection of predefined policy templates.

Template categories include:

- **Regulatory Compliance.** These templates identify messages and attachments that contain personally identifiable information, credit information, or other protected or non-public information.
- **Acceptable Use.** These templates identify messages sent to competitors or restricted recipients that contain sensitive information about an organization.
- **Privacy Protection.** These templates identify messages and attachments that contain identification numbers for financial accounts, tax records, or national IDs.
- **Intellectual Property Protection.** These templates identify popular publishing and design document file types that may contain intellectual property that an organization would want to protect.
- **Company Confidential.** These templates identify documents and messages that contain information about corporate accounting information and upcoming mergers and acquisitions.
- **Custom Policy.** This “template” lets you create your own policy from scratch using either pre-defined content matching classifiers or violation identification criteria specified by your organization. This option is considered advanced and should be used only in the rare cases when the predefined policy templates do not meet the unique requirements of your network environment.

Some of these templates require customization.

## Setting Up DLP Prevention Using a Wizard

The DLP Assessment Wizard helps you configure commonly-used DLP policies and enable them in the email gateway's default outgoing mail policy.



---

**Note** By default, DLP policies added using the DLP Assessment Wizard deliver all messages, regardless of the severity of detected DLP violations. You will need to edit the policies created using the wizard.

---

### Before You Begin

- Remove any existing DLP policies from the email gateway. You can only use the DLP Assessment Wizard if there are no existing DLP policies on the email gateway.
- If you need to detect messages that include student identification numbers or account numbers other than credit card numbers, US Social Security numbers, and US Drivers License numbers, create a regular expression that identifies those numbers. For more information, see [Regular Expressions for Identifying Identification Numbers](#) , on page 517.

### Procedure

---

**Step 1** Choose **Security Services > Data Loss Prevention**.

**Step 2** Click **Edit Settings**.

**Step 3** Select the **Enable and configure DLP using the DLP Assessment Wizard** check box.

**Step 4** Click **Submit**.

**Step 5** Complete the wizard.

Keep the following in mind:

- Any business that operates in California and owns or licenses computerized personally identifying information (PII) data for California residents, regardless of their physical location, is required to comply with **US State Regulations (California SB-1386)**. This law is one of the policy choices in the wizard.
- If you do not enter an email address to receive automatically-generated scheduled DLP Incident Summary report, the report will not be generated.
- When you review your configured settings, if you return to a step to make a change, you must proceed through the remaining steps until you reach the review page again. All settings that you previously entered will be remembered.
- When you complete the wizard, the **Outgoing Mail Policies** page displays, with your DLP policies enabled in the default outgoing mail policy. A summary of your DLP policy configuration is displayed at the top of the page.

**Step 6** Commit your changes.

---

### What to do next

- (Optional) To edit these DLP policies, create additional policies, change the overall action on messages, or change the severity level settings, choose **Mail Policies > DLP Policy Manager**. For information, see [Creating a DLP Policy Using a Predefined Template](#) , on page 511, [Creating a Custom DLP Policy \(Advanced\)](#) , on page 512, and [Adjusting the Severity Scale](#) , on page 524.
- (Optional) To enable existing DLP policies for other outgoing mail policies, see [Using Outgoing Mail Policies to Assign DLP Policies to Senders and Recipients](#) , on page 525.

### Related Topics

- [Creating a DLP Policy Using a Predefined Template](#) , on page 511

- [Creating a Custom DLP Policy \(Advanced\)](#) , on page 512

## Creating a DLP Policy Using a Predefined Template

### Procedure

---

- Step 1** Select **Mail Policies > DLP Policy Manager**.
- Step 2** Click **Add DLP Policy**.
- Step 3** Click the name of a category to display a list of the available DLP policy templates.
- Note** To view descriptions of each template, click **Display Policy Descriptions**.
- Step 4** Click **Add** for the DLP policy template that you want to use.
- Step 5** (Optional) Change the predefined name and description of the template.
- Step 6** If the policy requires or recommends customizing one or more content matching classifiers, enter a regular expression to define the pattern of your organization's identification numbering system and a list of words or phrases related to the identification numbers that identify them as such or are typically associated with them.
- For information, see:
- [About Defining Disallowed Content Using Content Matching Classifiers](#) , on page 513 and [Regular Expressions for Identifying Identification Numbers](#) , on page 517.
- Note** You cannot add or remove content matching classifiers for policies based on a predefined template.
- Step 7** (Optional) Apply the DLP policy only to messages with specific recipients, senders, attachment types, or previously-added message tags.
- For more information, see [Filtering Messages for DLP Policies](#), on page 523.
- You can separate multiple entries using a line break or a comma.
- Step 8** In the Severity Settings section:
- Choose an action to take for each level of violation severity. For more information, see [About Assessing Violation Severity](#) , on page 524.
  - (Optional) Click **Edit Scale** to adjust the violation severity scale for the policy. For more information, see [Adjusting the Severity Scale](#) , on page 524.
- Step 9** Submit and commit your changes.
- 

### What to do next

#### Related Topics

- [Setting Up DLP Prevention Using a Wizard](#) , on page 509
- [Creating a Custom DLP Policy \(Advanced\)](#) , on page 512

## Creating a Custom DLP Policy (Advanced)



**Note** Creating custom policies is very complex; create custom policies only if the predefined DLP policy templates do not meet the needs of your organization.

You can create a custom DLP policy from scratch using the Custom Policy template and add either a predefined content matching classifier or a custom classifier to the policy.

Custom policies can return a DLP violation if the content matches a single classifier or all classifiers, depending on how the policy is defined.

### Before You Begin

Suggested: Define the criteria that identify a content violation. See [Creating a Content Matching Classifier for Custom DLP Policies](#), on page 515. You can also define these criteria from within this procedure.

### Procedure

- Step 1** Select **Mail Policies > DLP Policy Manager**.
- Step 2** Click **Add DLP Policy**.
- Step 3** Click **Custom Policy**.
- Step 4** Click **Add** for the Custom Policy template.
- Step 5** Enter a name and description for the policy.
- Step 6** Identify the content and context that constitute a DLP violation:
  - a) Select a content matching classifier.
  - b) Click **Add**.
    - If you selected **Create a Classifier**, see [Creating a Content Matching Classifier for Custom DLP Policies](#), on page 515.
    - Otherwise, the selected classifier is added to the table.
  - c) (Optional) Add additional classifiers to the policy.

For example, you might be able to eliminate known likely false positive matches by adding another classifier and selecting NOT.
  - d) If you added multiple classifiers: Choose an option in the table heading to specify whether **any** or **all** of the classifiers must match in order to count the instance as a violation.
- Step 7** (Optional) Apply the DLP policy only to messages with specific recipients, senders, attachment types, or previously-added message tags.

For more information, see [Filtering Messages for DLP Policies](#), on page 523.

You can separate multiple entries using a line break or a comma.
- Step 8** In the Severity Settings section:
  - Choose an action to take for each level of violation severity. For more information, see [About Assessing Violation Severity](#), on page 524.



- (Optional) Click **Edit Scale** to adjust the violation severity scale for the policy. For more information, see [Adjusting the Severity Scale](#) , on page 524

**Step 9** Submit and commit your changes.

---

### What to do next

#### Related Topics

- [Setting Up DLP Prevention Using a Wizard](#) , on page 509
- [Creating a DLP Policy Using a Predefined Template](#) , on page 511

## About Defining Disallowed Content Using Content Matching Classifiers

Content matching classifiers define the content that cannot be emailed and optionally the context in which that content must occur in order to be considered a data loss prevention violation.

Suppose you want to prevent patient identification numbers from being emailed from your organization.

In order for the email gateway to recognize these numbers, you must specify the patterns of the record numbering system used by your organization, using one or more regular expressions. You can also add a list of words and phrases that might accompany the record number as supporting information. If the classifier detects the number pattern in an outgoing message, it searches for the supporting information to verify that the pattern is an identification number and not a random number string. Including context matching information results in fewer false positive matches.

For this example, you might create a DLP policy that uses the HIPAA and HITECH template. This template includes the Patient Identification Numbers content matching classifier, which you can customize to detect a patient's identification number. To detect numbers in the pattern of 123-CL456789, you would enter the regular expression `[0-9]{3}\-[A-Z]{2}[0-9]{6}` for the classifier. Enter "Patient ID" for a related phrase. Finish creating the policy and enable it in an outgoing mail policy. Submit and commit your changes. Now, if the policy detects the number pattern in an outgoing message with the phrase "Patient ID" in close proximity to the number pattern, the DLP policy returns a DLP violation.

### About Using Content Matching Classifiers in DLP Policies

Many of the predefined DLP policy templates include content matching classifiers. Some of these classifiers require customization in order to identify the patterns that are used for data in your organization.

If you create a custom DLP policy you can choose a predefined classifier or create one of your own.

#### Related Topics

- [Content Matching Classifier Examples](#), on page 514
- [Creating a Content Matching Classifier for Custom DLP Policies](#) , on page 515
- [Classifier Detection Rules for Identifying Sensitive Content \(Custom DLP Policies Only\)](#) , on page 516
- [Regular Expressions for Identifying Identification Numbers](#) , on page 517
- [Using Custom Dictionaries of Sensitive DLP Terms \(Custom DLP Policies Only\)](#) , on page 518
- [Determiners of the Risk Factor of a Suspected Violation](#) , on page 520
- [Viewing the Policies in Which Custom Content Classifiers are Used](#) , on page 523

## Content Matching Classifier Examples

The following examples show how classifiers match message content:

- [Credit Card Number, on page 514](#)
- [US Social Security Number, on page 514](#)
- [ABA Routing Numbers, on page 514](#)
- [Driver License Numbers \(US\) , on page 514](#)
- [National Provider IDs \(US\), on page 515](#)
- [Academic Records \(English\), on page 515](#)
- [Financial Statements \(English\), on page 515](#)

### Credit Card Number

Several DLP policy templates include the Credit Card Number classifier. The credit card number itself is subject to various constraints, such as the pattern of digits and punctuation, the issuer-specific prefix, and the final check digit. The classifier requires additional supporting information to make a match, such as an expiration date, or the name of the card issuer. This reduces the number of false positives.

Examples:

- 378734493671000 (No match because of no supporting information)
- 378734493671000 VISA (Match)
- 378734493671000 exp: 12/2019 (Match)

### US Social Security Number

The US Social Security Number classifier requires a properly formatted number as well as supporting data, such as a date of birth, name, or the string SSN .

Examples:

- 321-02-3456 (No match because of no supporting information)
- SSN: 132-45-6788 (Match)

### ABA Routing Numbers

The ABA Routing Number classifier is similar to the Credit Card Number classifier.

Examples:

- 119999992 (No match because of no supporting information)
- ABA No. 800000080 (Match)

### Driver License Numbers (US)

Many policies use a US Drivers License classifier. By default, this classifier searches for drivers licenses issued in the US. US state-specific policies such as California AB-1298 and Montana HB-732 search for their respective state US drivers' licenses only.

The individual state classifiers match against the patterns for that state, and require the corresponding state name or abbreviation, and additional supporting data.

Examples:

- CA DL# C3452362 (Match because it has the correct pattern for the number and supporting data)
- California DL# C3452362 (Match)

- DL: C3452362 (No match because there is not enough supporting data)
- California C3452362 (No match because there is not enough supporting data)
- OR DL# C3452362 (Match)
- OR DL# 3452362 (Match because it is the correct pattern for Oregon)
- WV DL# D654321 (Match because it is the correct pattern for West Virginia)
- WV DL# G654321 (Match)

### National Provider IDs (US)

The US National Provider Identifier classifier scans for a US National Provider Identifier (NPI) numbers, which is a 10-digit number with a check digit.

Examples:

- NPI No. 1245319599 (Match for NPI)
- NPI No. 1235678996 (Match for NPI)
- 3459872347 (No match because of no supporting information)
- NPI: 3459872342 (No match because of incorrect check digit)

### Academic Records (English)

The predefined FERPA (Family Educational Rights and Privacy Act) DLP policy template uses the Student Records classifier. Combine it with a customized Student Identification Number classifier to detect specific student ID patterns for better accuracy.

Example:

- Fall Semester Course Numbers: CHEM101, ECON102, MATH103 (Match)

### Financial Statements (English)

The predefined Sarbanes-Oxley (SOX) policy template uses the Corporate Financials classifier to search for non-public corporate financial information.

Example:

Gross Profits, Current Assets, and Cash Flow Statement for the Quarter ended June 30, 2016.  
(Match)

## Creating a Content Matching Classifier for Custom DLP Policies

Custom classifiers that you create are added to the list of classifiers that you can use when creating custom DLP policies.

### Procedure

|               | Command or Action                                                                          | Purpose                                                                                                                                                                                                                                 |
|---------------|--------------------------------------------------------------------------------------------|-----------------------------------------------------------------------------------------------------------------------------------------------------------------------------------------------------------------------------------------|
| <b>Step 1</b> | Understand how content matching classifiers are used to identify potential DLP violations. | See: <ul style="list-style-type: none"> <li>• <a href="#">About Defining Disallowed Content Using Content Matching Classifiers</a>, on page 513</li> <li>• <a href="#">Content Matching Classifier Examples</a>, on page 514</li> </ul> |

|               | Command or Action                                                                                                                                                                                                                                                                                   | Purpose                                                                                                                                                                                                                                                                                                                                                                                                 |
|---------------|-----------------------------------------------------------------------------------------------------------------------------------------------------------------------------------------------------------------------------------------------------------------------------------------------------|---------------------------------------------------------------------------------------------------------------------------------------------------------------------------------------------------------------------------------------------------------------------------------------------------------------------------------------------------------------------------------------------------------|
| <b>Step 2</b> | Select <b>Mail Policies &gt; DLP Policy Customizations</b> and click <b>Add Custom Classifier</b> . Enter a classifier name and description.                                                                                                                                                        | —                                                                                                                                                                                                                                                                                                                                                                                                       |
| <b>Step 3</b> | Enter a proximity and a minimum total score.                                                                                                                                                                                                                                                        | See <a href="#">Determiners of the Risk Factor of a Suspected Violation</a> , on page 520                                                                                                                                                                                                                                                                                                               |
| <b>Step 4</b> | Choose one of the following detection rule types and define the associated content matching criteria: <ul style="list-style-type: none"> <li>• words or phrases</li> <li>• text from a dictionary</li> <li>• a regular expression, or</li> <li>• an existing data loss prevention entity</li> </ul> | See: <ul style="list-style-type: none"> <li>• <a href="#">Classifier Detection Rules for Identifying Sensitive Content (Custom DLP Policies Only)</a> , on page 516</li> <li>• <a href="#">Using Custom Dictionaries of Sensitive DLP Terms (Custom DLP Policies Only)</a> , on page 518</li> <li>• <a href="#">Regular Expressions for Identifying Identification Numbers</a> , on page 517</li> </ul> |
| <b>Step 5</b> | (Optional) Add additional rules by clicking <b>Add Rule</b> .                                                                                                                                                                                                                                       | For information about Weight and Max Score, see <a href="#">Determiners of the Risk Factor of a Suspected Violation</a> , on page 520.                                                                                                                                                                                                                                                                  |
| <b>Step 6</b> | If you include multiple rules, specify whether <b>All</b> or <b>Any</b> rules must match.                                                                                                                                                                                                           | This setting is at the top of the Rules section.                                                                                                                                                                                                                                                                                                                                                        |
| <b>Step 7</b> | Submit and commit your changes.                                                                                                                                                                                                                                                                     | —                                                                                                                                                                                                                                                                                                                                                                                                       |

### What to do next

Use your custom content classifier in a custom DLP Policy. See [Creating a Custom DLP Policy \(Advanced\)](#) , on page 512.

### Related Topics

- [Viewing the Policies in Which Custom Content Classifiers are Used](#) , on page 523

## Classifier Detection Rules for Identifying Sensitive Content (Custom DLP Policies Only)

Content matching classifiers require rules for detecting DLP violations in a message or document. Classifiers can use one or more of the following detection rules:

- **Words or Phrases.** A list of words and phrases for which the classifier should look. Separate multiple entries with a comma or line break.
- **Regular Expression.** A regular expression to define a search pattern for a message or attachment. You can also define a pattern to exclude from matching to prevent false positives. See [Regular Expressions for Identifying Identification Numbers](#) , on page 517 and [Examples of Regular Expressions for Identifying Identification Numbers](#) , on page 518 for more information.
- **Dictionary.** A dictionary of related words and phrases. Your email gateway includes pre-defined dictionaries, or you can create your own. See [Using Custom Dictionaries of Sensitive DLP Terms \(Custom DLP Policies Only\)](#) , on page 518.

- **Entity.** A predefined pattern that identifies common types of sensitive data, such as credit card numbers, addresses, social security numbers, or ABA routing numbers. For descriptions of the entities, go to **Mail Policies > DLP Policy Manager**, click **Add DLP Policy**, click **Privacy Protection**, then click **Display Policy Descriptions**.

## Regular Expressions for Identifying Identification Numbers

Some policy templates require customization of one or more content matching classifiers, which involves creating a regular expression to search for identification numbers that may be linked to confidential information, such as a custom account number, patient identification number or Student ID. You can use the **Perl Compatible Regular Expression (PCRE2)** syntax to add regular expressions for content matching classifiers or the DLP policy templates. The regular expressions are validated for PCRE2 compatibility only when the DLP feature is enabled on your email gateway.



**Note** Regular expressions are case sensitive, so they should include upper and lower case, such as `[a-zA-Z]`. If only certain letters are used, you can define the regular expression accordingly.

The less specific the pattern, such as an 8-digit number, the more likely you will want the policy to search for additional words and phrases to distinguish a random 8-digit number from an actual customer number.

Use the following table as a guide for creating regular expressions for classifiers:

| Element                            | Description                                                                                                                                                                                                                                                                                                                                                                                                                                                                                                                                                                                                                                                                        |
|------------------------------------|------------------------------------------------------------------------------------------------------------------------------------------------------------------------------------------------------------------------------------------------------------------------------------------------------------------------------------------------------------------------------------------------------------------------------------------------------------------------------------------------------------------------------------------------------------------------------------------------------------------------------------------------------------------------------------|
| Regular expression ( abc )         | Regular expressions for classifiers match a string if the sequence of directives in the regular expression match any part of the string.<br><br>For example, the regular expression <b>ACC</b> matches the string <b>ACCOUNT</b> as well as <b>ACCT</b> .                                                                                                                                                                                                                                                                                                                                                                                                                          |
| [ ]                                | Use brackets to indicate a set of characters. Characters can be defined individually or within a range.<br><br>For example, <b>[a-z]</b> matches all lowercase letters from a to z, while <b>[a-zA-Z]</b> matches all uppercase and lowercase letters from A to Z. <b>[xyz]</b> matches only the letters x, y, or z.                                                                                                                                                                                                                                                                                                                                                               |
| Backslash special characters ( \ ) | The backslash character <i>escapes</i> special characters. Thus the sequence <code>\.</code> only matches a literal period, the sequence <code>\\$</code> only matches a literal dollar sign, and the sequence <code>\^</code> only matches a literal caret symbol.<br><br>The backslash character also begins tokens, such as <code>\d</code> .<br><br><b>Important Note:</b> The backslash is also a special escape character for the parser. As a result, if you want to include a backslash in your regular expression, you must use <i>two</i> backslashes — so that after parsing, only one “real” backslash remains, which is then passed to the regular expression system. |

| Element                         | Description                                                                                                                                                                                                                                                                                                                     |
|---------------------------------|---------------------------------------------------------------------------------------------------------------------------------------------------------------------------------------------------------------------------------------------------------------------------------------------------------------------------------|
| <code>\d</code>                 | Token that matches a digit ( 0 - 9 ). To match more than one digit, enter an integer in {} to define the length of the number.<br><br>For example, <code>\d</code> matches only a single digit such as 5 , but not 55 . Using <code>\d{2}</code> matches a number consisting of two digits, such as 55 , but not 5 .            |
| <code>\D</code>                 | Token that matches any non-digit character. To match more than one non-digit character, enter an integer in {} to define the length.                                                                                                                                                                                            |
| <code>\w</code>                 | Token that matches any alphanumeric character and the underscore ( a - z , A - Z , 0 - 9 , and _ ).                                                                                                                                                                                                                             |
| Number of repetitions {min,max} | The regular expression notation that indicates the number of repetitions of the previous token is supported.<br><br>For example, the expression “ <code>\d{8}</code> ” matches 12345678 and 11223344 but not 8 .                                                                                                                |
| Or ( )                          | Alternation, or the “or” operator. If A and B are regular expressions, the expression “ A B ” will match any string that matches either “A” or “B.” Can be used to combine number patterns in a regular expression.<br><br>For example, the expression “ <code>foo bar</code> ” will match either foo or bar , but not foobar . |

### Related Topics

- [Examples of Regular Expressions for Identifying Identification Numbers , on page 518](#)

### Examples of Regular Expressions for Identifying Identification Numbers

Simple regular expressions that describe patterns of numbers and letters in identification or account numbers might look like the following:

- An 8-digit number: `\d{8}`
- Identification code with hyphens between sets of numbers: `\d{3}-\d{4}-\d{4}`
- Identification code that begins with a single letter that can be upper or lower case: `[a-zA-Z]\d{7}`
- Identification code that begins with three digits and is followed by nine uppercase letters: `\d{3}[A-Z]{9}`
- Using | to define two different number patterns to search for: `\d{3}[A-Z]{9}|\d{2}[A-Z]{9}-\d{4}`

### Using Custom Dictionaries of Sensitive DLP Terms (Custom DLP Policies Only)

AsyncOS comes with a set of predefined dictionaries, but you can also create custom DLP dictionaries to specify terms for the DLP scanning feature to match.

You can create a custom DLP dictionary in several ways:

- [Adding Custom DLP Dictionaries Directly , on page 519](#)
- [Creating DLP Dictionaries as Text Files , on page 519](#) and then [Importing DLP Dictionaries , on page 519](#).
- [Exporting DLP Dictionaries , on page 519](#) from another email gateway and then [Importing DLP Dictionaries , on page 519](#).

## Adding Custom DLP Dictionaries Directly

### Procedure

---

- Step 1** Select **Mail Policies > DLP Policy Manager**.
  - Step 2** In the **Advanced Settings** section, click the link beside **Custom DLP Dictionaries**.
  - Step 3** Click **Add Dictionary**.
  - Step 4** Enter a name for the custom dictionary.
  - Step 5** Enter new dictionary entries (words and phrases) into the list of terms.  
Dictionary terms are case-sensitive and can contain non-ASCII characters.  
When entering multiple entries, separate the entries with line breaks.
  - Step 6** Click **Add**.
  - Step 7** Submit and commit your changes.
- 

## Creating DLP Dictionaries as Text Files

You can create your own dictionary as a text file on your local machine and import it onto the email gateway. Use line breaks for each term in the dictionary text file. Dictionary terms are case-sensitive and can contain non-ASCII characters.

## Exporting DLP Dictionaries



---

**Note** Predefined DLP dictionaries cannot be exported.

---

### Procedure

---

- Step 1** Select **Mail Policies > DLP Policy Manager**.
  - Step 2** Click the link for the **Custom DLP Dictionaries** section under **Advanced Settings**.
  - Step 3** Click **Export Dictionary**.
  - Step 4** Select a dictionary to export.
  - Step 5** Enter a file name for the dictionary.
  - Step 6** Choose where to save the exported dictionary, either on your local computer or in the configuration directory on the email gateway.
  - Step 7** Select an encoding for the file.
  - Step 8** Click **Submit** and save the file.
- 

## Importing DLP Dictionaries

### Before You Begin

If you will import a file that you exported from a non-DLP dictionary on an email gateway, you must first strip the weight values from the text file and convert any regular expressions to words or phrases.

### Procedure

---

- Step 1** Select **Mail Policies > DLP Policy Manager**.
  - Step 2** In the **Advanced Settings** section, click the link beside **Custom DLP Dictionaries**.
  - Step 3** Click **Import Dictionary**.
  - Step 4** Select a file to import from either your local machine or the configuration directory on the email gateway.
  - Step 5** Select an encoding.
  - Step 6** Click **Next**.  
A “Success” message appears and the imported dictionary is displayed in the Add Dictionary page. However, the process is not yet complete.
  - Step 7** Name and edit the dictionary.
  - Step 8** Click **Submit**.
- 

## Determiners of the Risk Factor of a Suspected Violation

When the email gateway scans a message for DLP violations, it assigns a risk factor score to the message. This score indicates the likelihood that the message contains a DLP violation. A score of 0 means the message almost certainly does not contain a violation. A score of 100 means it almost certainly does contain a violation.

### For DLP Policies Based On Predefined Templates

You cannot view or modify risk factor scoring parameters for DLP policies created from predefined templates. However, if there are too many false positive matches for a particular DLP policy, you can adjust the severity scale for that policy. See [About Assessing Violation Severity](#) , on page 524. For policies based on templates that do not have a content matching classifier, such as the SOX (Sarbanes-Oxley) template, the scanning engine always returns a risk factor value of “75” when a message violates the policy.

### For Custom DLP Policies

When you create content matching classifiers for custom DLP policies, you specify values that are used to determine the risk factor score:

- **Proximity**. How close the rule matches must occur in the message or attachment to count as a violation. For example, if a numeric pattern similar to a social security number appears near the top of a long message and an address appears in the sender’s signature at the bottom, they are presumed to be unrelated and the data does not count as a match.
- **Minimum Total Score**. The minimum risk factor score required for sensitive content to be labeled a DLP violation. If the score of a message’s matches does not meet the minimum total score, its data is not considered sensitive.
- **Weight**. For each custom rule you create, you specify a “weight” to indicate the importance of the rule. A score is obtained by multiplying the number of detection rule matches by the weight of the rule. Two instances of a rule with a weight of 10 results in a score of 20 . If one rule is more important for the classifier than the others, it should be assigned a greater weight.



- **Maximum Score.** A rule's maximum score prevents a large number of matches for a low-weight rule from skewing the final score of the scan.
- **Minimum Score.** You can use the recommended minimum score or choose to use the weight depending on the **Use recommended minimum scores for entity-based rules** check box selected in the Custom Classifiers Settings section of the DLP Policy Customizations page. For more information, see [Using Minimum Score for Entity-based Rules \(Custom DLP Policies Only\)](#), on page 522

To calculate the risk factor, the classifier multiplies the number of matches for a detection rule by the weight of the rule. If this value exceeds the detection rule's maximum score, the classifier uses the maximum score value. If the classifier has more than one detection rule, it adds the scores for all of its detection rules into a single value. The classifier maps the detection rules score (10 - 10000) on a scale of 10 -100 using the logarithmic scale shown in the following table to create the risk factor:

**Table 42: How Risk Factor Scores Are Calculated From Detection Rule Scores**

| Rule Scores | Risk Factor |
|-------------|-------------|
| 0           | 0           |
| 1           | 1           |
| 2           | 2           |
| 3           | 3           |
| 5           | 6           |
| 6           | 7           |
| 7           | 8           |
| 8           | 9           |
| 9           | 10          |
| 10          | 11          |
| 15          | 16          |
| 20          | 20          |
| 25          | 24          |
| 30          | 26          |
| 40          | 32          |
| 50          | 36          |
| 75          | 44          |
| 100         | 50          |
| 125         | 54          |

| Rule Scores | Risk Factor |
|-------------|-------------|
| 150         | 58          |
| 257         | 67          |
| 300         | 70          |
| 400         | 75          |
| 500         | 78          |
| 750         | 84          |
| 1000        | 87          |
| 5000        | 98          |
| 8000        | 99          |
| 10000       | 99          |
| 20000       | 100         |

## Using Minimum Score for Entity-based Rules (Custom DLP Policies Only)

### Procedure

---

**Step 1** Go to **Mail Policies > DLP Policy Customizations**.

**Step 2** In the **Custom Classifiers Settings** section, select the **Use recommended minimum scores for entity-based rules** check box.

If you select this option, the score for the entity-based rule is calculated using the configured minimum score instead of the weight.

For example, when you disable this option and a message has five rule matches of a certain entity with the weight configured as 10, the rule calculates the score as five matches times 10 occurrences, which is 50. If you enable this option with a minimum score for an entity as 10, the score is calculated based on the configured minimum score and the number of partial and full matches.

**Note** You must review the minimum total score of all the classifiers with entity-based rules when you select the Use recommended minimum scores for entity-based rules option.

**Step 3** Click **Submit** and commit your changes.

After you enable this option, you must review the minimum scores for entity-based rules of a custom classifier. For more information, see [Creating a Content Matching Classifier for Custom DLP Policies](#), on page 515.

---

## Viewing the Policies in Which Custom Content Classifiers are Used

### Procedure

- 
- Step 1** Select **Mail Policies > DLP Policy Customizations**.
- Step 2** In the **Custom Classifiers** section, click the **Policies** link in the heading of the Custom Classifiers table.
- 

### What to do next

#### Related Topics

- [Creating a Content Matching Classifier for Custom DLP Policies](#), on page 515

## Filtering Messages for DLP Policies

To improve performance or accuracy, you can limit a DLP policy to apply only to certain messages based on the following criteria:

| Option                              | Description                                                                                                                                                                                                                                                                                                                                                                                                                                                                                                                                                                                                                                                                                                                                                                                                                                                                                                                                                                                                                                                                                                               |
|-------------------------------------|---------------------------------------------------------------------------------------------------------------------------------------------------------------------------------------------------------------------------------------------------------------------------------------------------------------------------------------------------------------------------------------------------------------------------------------------------------------------------------------------------------------------------------------------------------------------------------------------------------------------------------------------------------------------------------------------------------------------------------------------------------------------------------------------------------------------------------------------------------------------------------------------------------------------------------------------------------------------------------------------------------------------------------------------------------------------------------------------------------------------------|
| Filtering by Senders and Recipients | <p>You can limit the DLP policy to apply to messages that do or do not include recipients or senders that you specify using one of the following:</p> <ul style="list-style-type: none"> <li>• Full email address: <code>user@example.com</code></li> <li>• Partial email address: <code>user@</code></li> <li>• All users in a domain: <code>@example.com</code></li> <li>• All users in a partial domain: <code>@.example.com</code></li> </ul> <p>Separate multiple entries using a line break or a comma.</p> <p>AsyncOS first matches the recipient or sender of an outgoing message to an outgoing mail policy, then matches the sender or recipient to the sender and recipient filters specified in the DLP policies enabled for that mail policy.</p> <p>For example, you might want to disallow all senders from sending a certain type of information, except to recipients in a partner domain. You would create a DLP policy for that information, including a filter that exempts all users in the partner domain, then include this DLP policy in an Outgoing Mail Policy that applies to all senders.</p> |
| Filtering by Attachment Types       | <p>You can limit the DLP policy to scanning only messages that do or do not include specific attachment types. Choose an attachment category, then a predefined file type, or specify file types that are not listed. If you specify a file type that is not predefined, AsyncOS searches for the file type based on the attachment's extension.</p> <p>You can also limit DLP scanning to attachments with a minimum file size.</p>                                                                                                                                                                                                                                                                                                                                                                                                                                                                                                                                                                                                                                                                                      |

| Option                   | Description                                                                                                                                                                                                                                                                                                                                                                     |
|--------------------------|---------------------------------------------------------------------------------------------------------------------------------------------------------------------------------------------------------------------------------------------------------------------------------------------------------------------------------------------------------------------------------|
| Filtering by Message Tag | If you want to limit a DLP policy to messages containing a specific phrase, you can use a message or content filter to search outgoing messages for the phrase and insert a custom message tag into the message. For more information, see <a href="#">Content Filter Actions, on page 278</a> and <a href="#">Using Message Filters to Enforce Email Policies, on page 127</a> |

## About Assessing Violation Severity

When the DLP scanning engine detects a potential DLP violation, it calculates a risk factor score that represents the likelihood that the instance actually is a DLP violation. The policy compares the risk factor score to the Severity Scale defined in that policy in order to determine the severity level (for example, Low or Critical.) You specify the action to take for violations at each severity level (except Ignore, for which no action is ever taken.) You can adjust the risk factor scores required to reach each severity level.

### Related Topics

- [Adjusting the Severity Scale , on page 524](#)

## Adjusting the Severity Scale

All policies have a default severity scale. You can adjust this scale for each policy.

For example, by default, a violation has a severity level of Critical if its risk factor score is between 90 and 100. However, for violations that match a particular policy, you may want increased sensitivity to potential data loss. For this DLP policy, you could change the Critical severity level to any violation with a risk factor score between 75 and 100.

### Procedure

- 
- Step 1** Select **Mail Policies > DLP Policy Manager**.
  - Step 2** Click the name of the policy to edit.
  - Step 3** In the **Severity Settings** section, click **Edit Scale**.
  - Step 4** Use the scale's arrows to adjust the scores for the severity levels.
  - Step 5** Click **Done**.
  - Step 6** In the Severity Scale table, verify that your scores are as you want them.
  - Step 7** Click **Submit**.
- 

### What to do next

#### Related Topics

- [About Assessing Violation Severity , on page 524](#)

## Arranging the Order of the Email DLP Policies for Violation Matching

If a DLP violation matches more than one of the DLP policies enabled in the outgoing mail policy, only the first matching DLP policy in the list is used.

### Procedure

---

- Step 1** On the DLP Policy Manager page, click **Edit Policy Order**.
  - Step 2** Click on the row for a policy you want to move and drag it to a new position in the order.
  - Step 3** Once you have finished reordering the policies, submit and commit your changes.
- 

## Associating DLP Policies with Outgoing Mail Policies

### Related Topics

- [Associating DLP Policies with the Default Outgoing Mail Policy](#) , on page 525
- [Using Outgoing Mail Policies to Assign DLP Policies to Senders and Recipients](#) , on page 525

## Associating DLP Policies with the Default Outgoing Mail Policy

The default outgoing mail policy is used when no other outgoing mail policy matches the sender or a recipient.

### Before You Begin

Complete all activities up to this point in the table in [How to Set Up Data Loss Prevention](#) , on page 507. For example, ensure that you have created the DLP policies that you want to include in the default Outgoing Mail Policy.

### Procedure

---

- Step 1** Choose **Mail Policies > Outgoing Mail Policies**.
  - Step 2** In the **Default Policy** row of the table, click the **Disabled** link in the **DLP** column.
  - Step 3** Select **Enable DLP (Customize Settings)**.
  - Step 4** Select the DLP policies to enable for the default outgoing mail policy.
  - Step 5** Submit and commit your changes.
- 

### What to do next

Choose the DLP policies for additional Outgoing Mail Policies. See [Using Outgoing Mail Policies to Assign DLP Policies to Senders and Recipients](#) , on page 525.

## Using Outgoing Mail Policies to Assign DLP Policies to Senders and Recipients

Specify which DLP policies apply to which senders and recipients by enabling them in outgoing mail policies. You can use DLP policies only in outgoing mail policies.

**Before You Begin**

Configure the DLP policy settings for the default Outgoing Mail policy. See [Associating DLP Policies with the Default Outgoing Mail Policy](#) , on page 525.

**Procedure**

- 
- Step 1** Choose **Mail Policies > Outgoing Mail Policies**.
  - Step 2** Click the link in the DLP column in any row of the table.
  - Step 3** Select the DLP policies to associate with this outgoing mail policy.
  - Step 4** Submit your changes.
  - Step 5** Repeat as needed for other Outgoing Mail Policies.
  - Step 6** Commit your changes.
- 

**What to do next**

See [How to Set Up Data Loss Prevention](#) , on page 507.

## Important Information About Editing or Deleting DLP Policies

| Action                | Information                                                                                                                                                                         |
|-----------------------|-------------------------------------------------------------------------------------------------------------------------------------------------------------------------------------|
| Editing a DLP policy  | If you rename a policy, you must re-enable it in your outgoing mail policies.                                                                                                       |
| Deleting a DLP policy | If you delete a policy, you will receive a notification if the DLP policy is used in one or more outgoing mail policies. Deleting a DLP policy removes it from these mail policies. |

## Message Actions

You specify primary and secondary actions that the email gateway will take when it detects a possible DLP violation in an outgoing message. Different actions can be assigned for different violation types and severities.

Primary actions include:

- Deliver
- Drop
- Quarantine

Secondary actions include:

- Sending a copy to a policy quarantine if you choose to deliver the message. The copy is a perfect clone of the original, including the Message ID. Quarantining a copy allows you to test the DLP system before deployment in addition to providing another way to monitor DLP violations. When you release the copy from the quarantine, the email gateway delivers the copy to the recipient, who will have already received the original message.

- Encrypting messages. The email gateway only encrypts the message body. It does not encrypt the message headers.
- Altering the subject header of messages containing a DLP violation.
- Adding disclaimer text to messages.
- Sending messages to an alternate destination mailhost.
- Sending copies (bcc) of messages to other recipients. (For example, you could copy messages with critical DLP violations to a compliance officer's mailbox for examination.)
- Sending a DLP violation notification message to the sender or other contacts, such as a manager or DLP compliance officer. See [Drafting DLP Notifications](#) , on page 529.



**Note** These actions are not mutually exclusive: you can combine some of them within different DLP policies for various processing needs for different user groups. You can also configure different treatments based on the different severity levels in the same policy. For example, you may want to quarantine messages with critical DLP violations and send a notification to a compliance officer, but you may want to deliver messages with low severity levels.

#### Related Topics

- [Defining Actions to Take for DLP Violations \(Message Actions\)](#) , on page 527
- [Viewing and Editing Message Actions](#) , on page 528
- [Drafting DLP Notifications](#) , on page 529

## Defining Actions to Take for DLP Violations (Message Actions)

#### Before You Begin

- Create at least one dedicated quarantine to hold messages (or copies of messages) that violate DLP policies.  
  
This can be a local quarantine on an email gateway or a centralized quarantine on a Cisco Secure Email and Web Manager.  
  
For information, see [Policy, Virus, and Outbreak Quarantines](#), on page 923
- If you want to encrypt messages before delivery, make sure you have set up an encryption profile. See [Cisco Email Encryption](#), on page 535
- To include disclaimer text when delivering messages with DLP violations or suspected violations, specify disclaimer text in **Mail Policies > Text Resources**. For information, see [Disclaimer Template](#), on page 651
- To send a notification to the sender of a DLP violation or to another person such as a compliance officer, first create the DLP notification template. See [Drafting DLP Notifications](#) , on page 529.

#### Procedure

- Step 1** Select **Mail Policies > DLP Policy Customizations**.
- Step 2** In the **Message Actions** section, click **Add Message Action**.
- Step 3** Enter a name for the message action.

**Step 4** Enter a description of the message action.

**Step 5** Choose whether to drop, deliver, or quarantine messages containing DLP violations.

**Note** If you select Deliver, you can choose to have a copy of the message sent to a policy quarantine. The copy of the message is a perfect clone, including the Message ID.

**Step 6** If you want to encrypt the message upon delivery or its release from quarantine, select the **Enable Encryption** check box and select the following options:

- **Encryption Rule.** Always encrypts the message or only encrypt it if an attempt to send it over a TLS connection first fails.
- **Encryption Profile.** Encrypts the message using the specified encryption profile and delivers it if you use a Cisco IronPort Encryption Appliance or a hosted key service.
- **Encrypted Message Subject.** Subject for the encrypted message. Use the value is **\$Subject** to keep the existing message subject.

**Step 7** If you select Quarantine as the action, choose the policy quarantine that you want to use for messages containing DLP violations.

**Step 8** Click **Advanced** if you want to modify the message using any of the following options:

- Add a custom header
- Modify the message subject
- Deliver it to alternate host
- Send a copy (bcc) to another recipient
- Send a DLP notification message

**Step 9** Submit and commit your changes.

## Viewing and Editing Message Actions

### Procedure

**Step 1** Select **Mail Policies > DLP Policy Customizations**.

**Step 2** In the **Message Actions** section, choose an action:

| To                                                      | Do This                                                                        |
|---------------------------------------------------------|--------------------------------------------------------------------------------|
| View the mail policies to which each action is assigned | Click the <b>Policies</b> link in the heading of the Message Actions table.    |
| View the description that you entered for each action   | Click the <b>Description</b> link in the heading of the Message Actions table. |
| View or edit details of a Message Action                | Click the name of the Message Action.                                          |



| To                                                                                                                                                                                          | Do This                                                                                                                                                                       |
|---------------------------------------------------------------------------------------------------------------------------------------------------------------------------------------------|-------------------------------------------------------------------------------------------------------------------------------------------------------------------------------|
| Delete a Message Action                                                                                                                                                                     | Click the trash can icon next to the message action you want to delete.<br><br>A confirmation message notifies you if the message action is used in one or more DLP policies. |
| Duplicate a Message Action<br><br>You can use this feature to create a backup copy of a Message Action before changing it, or to use as a starting point for a new, similar Message Action. | Click the <b>Duplicate</b> icon next to the message action that you want to duplicate.                                                                                        |

**Step 3** Submit and commit any changes.

---

## Drafting DLP Notifications

Use this procedure to create a template for the notification that will be sent when an email message contains information that violates your organization's data loss prevention policies. You can send this notification to the sender of the message that violated DLP policy, or to another address, for example a manager or DLP Compliance officer.

### Before You Begin

- Familiarize yourself with the [DLP Notification Template Variable Definitions, on page 530](#). You can use these variables to customize the notification with specific details about each violation.

### Procedure

---

**Step 1** Select **Mail Policies > Text Resources**.

**Step 2** Click **Add Text Resource**.

**Step 3** For **Type**, select **DLP Notification Template**.

DLP variables are not available for the plain Notification template.

**Step 4** Enter notification text and variables.

The notification should inform its recipients that an outgoing message may contain sensitive data that violates your organization's data loss prevention policies.

---

### What to do next

Specify this DLP notification template in a Message Action in a DLP policy in the DLP Policy Manager.

### Related Topics

- [DLP Notification Template Variable Definitions, on page 530](#)

## DLP Notification Template Variable Definitions

Use the following variables to include specific information about each DLP violation in the notification.

| Variable            | Substituted With                                                                                                                                                     |
|---------------------|----------------------------------------------------------------------------------------------------------------------------------------------------------------------|
| \$DLPPolicy         | Replaced by the name of the email DLP policy violated.                                                                                                               |
| \$DLPSeverity       | Replaced by the severity of violation. Can be “Low,” “Medium,” “High,” or “Critical.”                                                                                |
| \$DLPRiskFactor     | Replaced by the risk factor of the message’s sensitive material (score 0 - 100).                                                                                     |
| \$To                | Replaced by the message To: header (not the Envelope Recipient).                                                                                                     |
| \$From              | Replaced by the message From: header (not the Envelope Sender).                                                                                                      |
| \$Subject           | Replaced by the subject of the original message.                                                                                                                     |
| \$Date              | Replaced by the current date, using the format MM/DD/YYYY.                                                                                                           |
| \$Time              | Replaced by the current time, in the local time zone.                                                                                                                |
| \$GMTimestamp       | Replaced by the current time and date, as would be found in the Received: line of an email message, using GMT.                                                       |
| \$MID               | Replaced by the Message ID, or “MID” used internally to identify the message. Not to be confused with the RFC822 “Message-Id” value (use \$Header to retrieve that). |
| \$Group             | Replaced by the name of the sender group the sender matched on when injecting the message. If the sender group had no name, the string “>Unknown<” is inserted.      |
| \$Reputation        | Replaced by the IP Reputation score of the sender. If there is no reputation score, it is replaced with “None”.                                                      |
| \$filenames         | Replaced with a comma-separated list of the message’s attachments’ filenames.                                                                                        |
| \$filetypes         | Replaced with a comma-separated list of the message’s attachments’ file types.                                                                                       |
| \$filesizes         | Replaced with a comma-separated list of the message’s attachment’s file sizes.                                                                                       |
| \$remotehost        | Replaced by the hostname of the system that sent the message to the Cisco appliance.                                                                                 |
| \$AllHeaders        | Replaced by the message headers.                                                                                                                                     |
| \$EnvelopeFrom      | Replaced by the Envelope Sender (Envelope From, <MAIL FROM>) of the message.                                                                                         |
| \$Hostname          | Replaced by the hostname of the email gateway.                                                                                                                       |
| \$bodysize          | Replaced by the size, in bytes, of the message.                                                                                                                      |
| \$header[‘string ’] | Replaced by the value of the quoted header, if the original message contains a matching header. Note that double quotes may also be used.                            |
| \$remoteip          | Replaced by the IP address of the system that sent the message to the email gateway.                                                                                 |
| \$recvlistener      | Replaced by the nickname of the listener that received the message.                                                                                                  |

| Variable             | Substituted With                                                                                                            |
|----------------------|-----------------------------------------------------------------------------------------------------------------------------|
| \$dropped_filenames  | Same as \$filenames , but displays list of dropped files.                                                                   |
| \$dropped_filename   | Returns only the most recently dropped filename.                                                                            |
| \$recvint            | Replaced by the nickname of the interface that received the message.                                                        |
| \$timestamp          | Replaced by the current time and date, as would be found in the Received: line of an email message, in the local time zone. |
| \$Time               | Replaced by the current time, in the local time zone.                                                                       |
| \$orgid              | Replaced by the SenderBase Organization ID (an integer value).                                                              |
| \$enveloperecipients | Replaced by all Envelope Recipients (Envelope To, <RCPT TO>) of the message.                                                |
| \$dropped_filetypes  | Same as \$filetypes , but displays list of dropped file types.                                                              |
| \$dropped_filetype   | Returns only the file type of the most recently dropped file.                                                               |

## Displaying Sensitive DLP Data in Message Tracking

DLP deployment offers the option to log the content that violates your DLP policies, along with the surrounding content, which can then be viewed in Message Tracking. This content may include sensitive data such as credit card numbers and social security numbers.

### Before You Begin

Enable Message Tracking. See [Enabling Message Tracking, on page 911](#)

### Procedure

- 
- Step 1** Select **Security Services > Data Loss Prevention**.
  - Step 2** Click **Edit Settings**.
  - Step 3** Select the **Enable Matched Content Logging** check box.
  - Step 4** Submit and commit your changes.
- 

### What to do next

Specify which administrative users can view this information. See [Controlling Access to Sensitive Information in Message Tracking, on page 977](#).

### Related Topics

- [Message Tracking Details , on page 918](#)

# About Updating the DLP Engine and Content Matching Classifiers

Updates for the Cisco DLP engine and the predefined content matching classifiers on your email gateway are independent of updates for other security services.

## Related Topics

- [Determining the Current Version of the DLP Engine](#) , on page 532
- [Updating the DLP Engine and Content Matching Classifiers Manually](#) , on page 532
- [Enabling Automatic Updates \(Not Recommended\)](#) , on page 533
- [DLP Updates on Centralized \(Clustered\) Email Gateways](#) , on page 533

## Determining the Current Version of the DLP Engine

### Procedure

---

**Step 1** Select **Security Services > Data Loss Prevention**.

**Step 2** Look in the **Current DLP Version Files** section.

**Note** You can also use the `dlpstatus` CLI command to view the current version of the DLP engine. See the *CLI Reference Guide for AsyncOS for Cisco Secure Email Gateway* for more information.

---

## Updating the DLP Engine and Content Matching Classifiers Manually

### Before you Begin

See the following:

- (If applicable) [DLP Updates on Centralized \(Clustered\) Email Gateways](#) , on page 533

### Procedure

---

**Step 1** Select **Security Services > Data Loss Prevention**.

**Step 2** Click **Update Now** in the **Current DLP Version Files** section.

This button is available only when there are new updates available for download.

**Note** You can also use the `dlpupdate` CLI command to update the DLP engine. See the *CLI Reference Guide for AsyncOS for Cisco Secure Email Gateway* for more information.

---

## Enabling Automatic Updates (Not Recommended)

Use this procedure to enable the email gateway to check for and download updates at a regular interval.



**Note** Cisco recommends that you do not enable automatic updates. These updates may change the content matching classifiers used in your DLP policies. Instead, manually download DLP updates and test them in a lab environment before updating email gateways used in production.

### Before You Begin

- On the **Security Settings > Service Updates** page, make sure you have enabled automatic updates and specified an update interval for all service updates.
- See [DLP Updates on Centralized \(Clustered\) Email Gateways](#), on page 533.

### Procedure

- Step 1** Select **Security Services > Data Loss Prevention**.
- Step 2** Click **Edit Settings**.
- Step 3** Select the **Enable automatic updates** check box.
- Step 4** Submit and commit your changes.

## DLP Updates on Centralized (Clustered) Email Gateways

Note the following:

- You cannot enable automatic DLP updates for email gateways in clustered deployments.
- DLP updates are always performed at the machine level, irrespective of DLP configured at the cluster, machine or group level.
- You can only check the status of an email gateway's DLP engine using the `dlpstatus` CLI command at the machine level.

## Working with DLP Incident Messages and Data



**Note** See also the documentation for the Cisco Secure Email and Web Manager, as applicable to your deployment.

| To                                                                                                                                                             | Do This                                              |
|----------------------------------------------------------------------------------------------------------------------------------------------------------------|------------------------------------------------------|
| Search for messages containing DLP violations using criteria such as DLP policy name, violation severity, and action taken, and view details of messages found | See <a href="#">Tracking Messages</a> , on page 911. |

| To                                                                             | Do This                                                                                                           |
|--------------------------------------------------------------------------------|-------------------------------------------------------------------------------------------------------------------|
| View or manage messages that have been quarantined as suspected DLP violations | See <a href="#">Working with Messages in Policy, Virus, or Outbreak Quarantines</a> , on page 933.                |
| View a summary of DLP incidents                                                | See information about DLP Incident Summary reports in <a href="#">Using Email Security Monitor</a> , on page 829. |
| View information about DLP violations discovered in outgoing mail              | See information about DLP Incident reports in <a href="#">Using Email Security Monitor</a> , on page 829.         |

### Related Topics

- [Displaying Sensitive DLP Data in Message Tracking](#) , on page 531
- [Controlling Access to Sensitive Information in Message Tracking](#), on page 977

## Troubleshooting Data Loss Prevention

- [DLP Fails to Detect Violations in Email Attachments](#), on page 534

### DLP Fails to Detect Violations in Email Attachments

#### Problem

When using predefined DLP policies, DLP fails to detect violations in email attachments. This can be caused by:

- The small value of the proximity parameter in the predefined DLP policies



---

**Note** You cannot change the proximity of a predefined DLP policy.

---

- The high severity scale parameter defined in the predefined DLP policies

#### Solution

- Create a custom policy and adjust the proximity as required. See [Creating a Custom DLP Policy \(Advanced\)](#) , on page 512
- Lower the severity scale parameter of the predefined DLP policy. See [Adjusting the Severity Scale](#) , on page 524



## CHAPTER 23

# Cisco Email Encryption

---

This chapter contains the following sections:

- [Overview of Cisco Email Encryption, on page 535](#)
- [How to Encrypt Messages with Cisco Secure Email Encryption Service, on page 536](#)
- [Encrypting Messages using the Email Gateway, on page 537](#)
- [Determining Which Messages to Encrypt, on page 542](#)
- [Inserting Encryption Headers into Messages, on page 545](#)

## Overview of Cisco Email Encryption

AsyncOS supports using encryption to secure inbound and outbound email. To use this feature, you create an encryption profile that specifies characteristics of the encrypted message and connectivity information for the Cisco Secure Email Encryption Service (managed service) key server.

Next, you create content filters, message filters, and Data Loss Prevention policies to determine which messages to encrypt.

1. An outgoing message that meets the filter condition is placed in a queue on the email gateway for encryption processing.
2. Once the message is encrypted, the key used to encrypt it is stored on the key server and the encrypted message is queued for delivery.
3. If a temporary condition exists that prohibits the encryption of emails in the queue (i.e., temporary C-Series busyness or Cisco Secure Email Encryption Service unavailability), messages are re-queued and retried at a later time.



---

**Note** You can also set up the email gateway to first attempt to send a message over a TLS connection before encrypting it. For more information, see [Using a TLS Connection as an Alternative to Encryption, on page 542](#).

---

# How to Encrypt Messages with Cisco Secure Email Encryption Service

Table 43: How to Encrypt Messages with Cisco Secure Email Encryption Service

| Steps  | Do This                                                                                                                   | More Info                                                                                                                                                                                                                                                              |
|--------|---------------------------------------------------------------------------------------------------------------------------|------------------------------------------------------------------------------------------------------------------------------------------------------------------------------------------------------------------------------------------------------------------------|
| Step 1 | Set up the Cisco IronPort Encryption appliance on the network.                                                            | See <a href="#">Setup and Installation</a> , on page 13                                                                                                                                                                                                                |
| Step 2 | Enable message encryption.                                                                                                | <a href="#">Enabling Message Encryption on the Email Gateway</a> , on page 538.                                                                                                                                                                                        |
| Step 3 | Specify the encryption key server and the security settings for the encrypted messages by creating an encryption profile. | <a href="#">Configuring How the Key Service Handles Encrypted Messages</a> , on page 538.                                                                                                                                                                              |
| Step 4 | Define the conditions that messages must meet in order for the email gateway to encrypt them.                             | <a href="#">Determining Which Messages to Encrypt</a> , on page 542.                                                                                                                                                                                                   |
| Step 5 | Determine when to encrypt messages in the email workflow.                                                                 | <ul style="list-style-type: none"> <li>• <a href="#">Encrypting and Immediately Delivering Messages using a Content Filter</a>, on page 543.</li> <li>or</li> <li>• <a href="#">Encrypting a Message upon Delivery using a Content Filter</a>, on page 544.</li> </ul> |
| Step 6 | (Optional) Flag messages for additional security.                                                                         | <a href="#">Inserting Encryption Headers into Messages</a> , on page 545.                                                                                                                                                                                              |
| Step 7 | Define groups of users for whom you want to encrypt messages.                                                             | Create a mail policy.<br>See <a href="#">Mail Policies</a> , on page 255                                                                                                                                                                                               |
| Step 8 | Associate the encryption actions that you defined with the user groups you defined.                                       | Associate the content filter with the mail policy.<br>See <a href="#">Mail Policies</a> , on page 255                                                                                                                                                                  |

## Related Topics

- [Encryption Workflow](#), on page 536

## Encryption Workflow

When using email encryption, the email gateway encrypts a message and stores the message key on the Cisco Secure Email Encryption Service (hosted key service). When the recipient opens an encrypted message, the recipient is authenticated by the key service, and the decrypted message is displayed.



Figure 34: Encryption Workflow

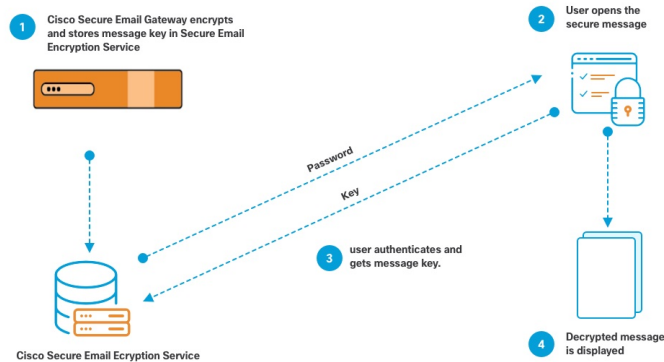

The basic workflow for opening encrypted messages is:

1. When you configure an encryption profile, you specify the parameters for message encryption. For an encrypted message, the email gateway creates and stores a message key on the hosted key service (Cisco Secure Email Encryption Service).
2. The recipient opens the secure envelope in a browser.
3. When a recipient opens an encrypted message in a browser, a password may be required to authenticate the recipient's identity. The key server returns the encryption key associated with the message.



**Note** When opening an encrypted email message for the first time, the recipient is required to register with the key service to open the secure envelope. After registering, the recipient may be able to open encrypted messages without authenticating, depending on settings configured in the encryption profile. The encryption profile may specify that a password isn't required, but certain features will be unavailable.

4. The decrypted message is displayed.

## Encrypting Messages using the Email Gateway

To use encryption with the email gateway, you must configure an encryption profile. You can enable and configure an encryption profile using the `encryptionconfig` CLI command, or via Security Services > Cisco IronPort Email Encryption in the GUI.



**Note** If PXE and S/MIME encryption is enabled on the email gateway, AsyncOS encrypts messages using S/MIME first, and then using PXE.

### Related Topics

- [Enabling Message Encryption on the Email Gateway, on page 538](#)
- [Configuring How the Key Service Handles Encrypted Messages, on page 538](#)
- [Configuring the Default Locale of the Envelope, on page 541](#)
- [Updating to the Latest Version of the PXE Engine, on page 542](#)

## Enabling Message Encryption on the Email Gateway

### Procedure

---

**Step 1** Click **Security Services > Cisco IronPort Email Encryption**.

**Step 2** Click **Enable**.

**Step 3** (Optional) Click **Edit Settings** to configure the following options:

- The maximum message size to encrypt. Cisco's recommended message size is 10 MB. The maximum message size the email gateway will encrypt is 25 MB.

**Note** Encrypting messages larger than the recommended 10 MB limit may slow down the performance of the email gateway. If you are using the Cisco Registered Envelope Service, message recipients will be unable to reply to an encrypted message that has attachments larger than 10 MB.

- Email address of the encryption account administrator. When you provision an Encryption Profile, this email address is registered automatically with the encryption server.
- Configure a proxy server.

**Note** You can configure the preferred storage to store a copy of the encrypted envelope by enabling the **Read from Message** feature in the Secure Email Encryption Service admin portal. The following storage options are available:

- Cisco Storage
- Microsoft OneDrive Storage

For more details, see the *Cisco Secure Email Encryption Service Account Administrator Guide* on [this page](#).

---

## Configuring How the Key Service Handles Encrypted Messages

You can create one or more encryption profiles if you use a key service. You might want to create different encryption profiles if you want to use different levels of security for different groups of email. For example, you might want messages containing sensitive material to be sent with high security, but other messages to be sent with medium security. In this case, you might create a high security encryption profile to associate with the messages containing certain key words (such as 'confidential'), and create another encryption profile for other outgoing messages.

You can assign an encryption profile to a custom user role to allow delegated administrators assigned to that role to use the encryption profile with their DLP policies and content filters. Only administrators, operators, and delegated users can use encryption profiles when configuring DLP policies and content filters. Encryption profiles that are not assigned to a custom role are available for use by all delegated administrators with mail or DLP policy privileges. See [Distributing Administrative Tasks, on page 973](#) for more information.



**Note** You can configure multiple encryption profiles for a hosted key service. If your organization has multiple brands, this allows you to reference different logos stored on the key server for the PXE envelopes.

An encryption profile stores the following settings:

- **Key server settings.** Specify a key server and information for connecting to that key server.
- **Envelope settings.** Specify details about the message envelope, such as the level of security, whether to return read receipts, the length of time a message is queued for encryption before it times out, the type of encryption algorithm to use, and whether to enable a decryption applet to run on the browser.
- **Message settings.** Specify details about messages, such as whether to enable secure message forwarding and secure Reply All.
- **Notification settings.** Specify the notification template to use for text and HTML notifications, as well as encryption failure notifications. You create the templates in text resources and select the templates when creating the encryption profile. You can also localize envelopes and specify a message subject for encryption failure notifications. For more information about notifications, see [Encryption Notification Templates, on page 660](#) and [Bounce and Encryption Failure Notification Templates, on page 659](#).

## Procedure

- 
- Step 1** In the Email Encryption Profiles section, click **Add Encryption Profile**.
- Step 2** Enter a name for the Encryption Profile.
- Step 3** Click the **Used By (Roles)** link, select the custom user role you want to have access to the encryption profile, and click **OK**.
- Delegated administrators assigned to this custom role can use the encryption profile for any DLP policies and content filters for which they are responsible.
- Step 4** In the Key Server Settings section, select Cisco Secure Email Encryption Service (hosted key service).
- Step 5** If you select the Cisco Secure Email Encryption Service, enter the URL for the hosted key service. The key service URL is `https://res.cisco.com`.
- Step 6** Click **Advanced** under Key Server Settings to specify whether to use HTTP or HTTPS for transferring the envelope's encrypted payload when the recipient opens the envelope. Choose from one of the following:
- **Use the Key Service with HTTP.** Transfers the encrypted payload from the key service using HTTP when the recipient opens the envelope. For Cisco Secure Email Encryption Service, this is the URL you specified in Step 5.
  - Since the payload is already encrypted, transporting it over HTTP is safe and faster than sending over HTTPS. This provides better performance than sending image requests over HTTPS.
  - **Use the Key Service with HTTPS.** Transfers the encrypted payload from the key service using HTTPS when the recipient opens the envelope. For Cisco Secure Email Encryption Service, this is the URL you specified in Step 5.
  - **Specify a separate URL for payload transport.** If you don't want to use the key server for your encrypted payload, you can use another URL and specify whether to use HTTP or HTTPS for the payload transfer.
- Step 7** In the Envelope Settings section, select the level of message security:

- **High Security.** The recipient must always enter a passphrase to open encrypted messages.
- **Medium Security.** The recipient does not need to enter credentials to open the encrypted message if the recipient credentials are cached.
- **No Passphrase Required.** This is the lowest level of encrypted message security. The recipient does not need to enter a passphrase to open the encrypted message. You can still enable the read receipts, Secure Reply All, and Secure Message Forwarding features for envelopes that are not passphrase-protected.

**Step 8** To enable users to open your organization's URL by clicking its logo, you can add a link to the logo. Choose from the following options:

- **No link.** A live link is not added to the message envelope.
- **Custom link URL.** Enter the URL to add a live link to the message envelope.

**Step 9** (Optional) Enable read receipts. If you enable this option, the sender receives a receipt when recipients open the secure envelope.

**Step 10** (Optional) Click **Advanced** under Envelope Settings to configure the following settings:

- Enter the length of time (in seconds) that a message can be in the encryption queue before timing out. Once a message times out, the email gateway bounces the message and sends a notification to the sender.
  - Select an encryption algorithm - 'AES 192' or 'AES 256.'
- Note** AES provides stronger encryption but also takes longer to decrypt, introducing delays for recipients. AES is typically used in government and banking applications.
- Enable or disable the decryption applet. Enabling this option causes the message attachment to be opened in the browser environment. Disabling this option causes message attachments to be decrypted at the key server. If you disable this option, messages may take longer to open, but are not dependent on the browser environment.

**Step 11** In the Message Settings section, do the following:

- To enable secure reply all feature, check the **Enable Secure Reply All** check box.
- To enable secure message forwarding feature, check the **Enable Secure Message Forwarding** check box.

**Step 12** (Optional) If you have selected Cisco Secure Email Encryption Service and this service supports localization of envelopes, enable localization of envelopes. In Notification Settings section, check the **Use Localized Envelope** check box.

**Note** If you enable localization of envelopes, you cannot select encrypted message HTML or text notification.

If you want to set the default locale of the envelope, see [Configuring the Default Locale of the Envelope](#), on page 541.

**Step 13** Select the HTML and text notification templates.

**Note** The key server uses an HTML or text notification based on the recipient's email application. You must configure notifications for both.

Do the following:

- a) Select an HTML notification template. Choose from HTML notifications you configured in text resources. If you did not configure a template, the system uses the default template.
- b) Select a text notification template. Choose from text notifications you configured in text resources. If you did not configure a template, the system uses the default template.

**Note** These options are unavailable if you use localized envelopes.

- Step 14** Enter a subject header for encryption failure notifications. The email gateway sends a notification if the encryption process times out.
- Step 15** Select an encryption failure notification template for the message body. Choose from an encryption failure notification template you configured in text resources. If you did not configure a template, the system uses the default template.
- Step 16** Submit and commit your changes.
- Step 17** If you use Cisco Registered Envelope Service, you must take the additional step of provisioning your email gateway. Provisioning the email gateway registers the encryption profile with the hosted key service. To provision the email gateway, click the **Provision** button for the encryption profile you want to register.
- 

## Configuring the Default Locale of the Envelope

The default locale of the envelope is English. If you have selected Cisco Secure Email Encryption Service and this service supports localization of envelopes, you can change the locale of the envelope to any one of the following:

- English
- French
- German
- Japanese
- Portuguese
- Spanish
- Italian
- Korean
- Dutch
- Polish
- Russian
- Chinese

### Before You Begin

- Create an encryption profile with Cisco Secure Email Encryption Service as Key Service Type and envelope localization enabled. See [Configuring How the Key Service Handles Encrypted Messages, on page 538](#).
- Make sure that Cisco Secure Email Encryption Service supports localization of envelopes.

## Procedure

---

- Step 1** Click **Security Services > Cisco IronPort Email Encryption**.
- Step 2** Open an existing encryption profile.
- Step 3** In the **Notification Settings** section, choose the locale from the **Localized Envelopes** drop-down list.
- Step 4** Click **Submit**.
- Step 5** Click **Commit Changes**.
- 

## Updating to the Latest Version of the PXE Engine

The Cisco Email Encryption Settings page displays the current versions of the PXE engine and the Domain Mappings file used by your email gateway. You can use the **Security Services > Service Updates** page (or the `updateconfig` command in the CLI) to configure the email gateway to automatically update the PXE engine. For more information, see [Service Updates](#), on page 1029.

You can also manually update the engine using the **Update Now** button of the PXE Engine Updates section of IronPort Email Encryption Settings page (or the `encryptionupdate` command in the CLI).

## Determining Which Messages to Encrypt

After you create an encryption profile, you need to create an outgoing content filter that determines which email messages should be encrypted. The content filter scans outgoing email and determines if the message matches the conditions specified. Once the content filter determines a message matches the condition, the email gateway encrypts the message and sends the generated key to the key server. It uses settings specified in the encryption profile to determine the key server to use and other encryption settings.

You can also encrypt messages after they are released after Data Loss Prevention scanning. For more information, see [Defining Actions to Take for DLP Violations \(Message Actions\)](#), on page 527.

### Related Topics

- [Using a TLS Connection as an Alternative to Encryption](#), on page 542
- [Encrypting and Immediately Delivering Messages using a Content Filter](#), on page 543
- [Encrypting a Message upon Delivery using a Content Filter](#), on page 544

## Using a TLS Connection as an Alternative to Encryption

Based on the destination controls specified for a domain, your email gateway can securely relay a message over a TLS connection instead of encrypting it, if a TLS connection is available. The email gateway decides whether to encrypt the message or send it over a TLS connection based on the TLS setting in the destination controls (Required, Preferred, or None) and the action defined in the encryption content filter.

When creating the content filter, you can specify whether to always encrypt a message or to attempt to send it over a TLS connection first, and if a TLS connection is unavailable, to encrypt the message. The following table shows you how an email gateway will send a message based on the TLS settings for a domain's destination controls, if the encryption control filter attempts to send the message over a TLS connection first.

Table 44: TLS Support on Email Gateways

| Destination Controls TLS Setting | Action if TLS Connection Available | Action if TLS Connection Unavailable |
|----------------------------------|------------------------------------|--------------------------------------|
| None                             | Encrypt envelope and send          | Encrypt envelope and send            |
| TLS Preferred                    | Send over TLS                      | Encrypt envelope and send            |
| TLS Required                     | Send over TLS                      | Retry/bounce message                 |

For more information about enabling TLS on destination controls, see [Configuring the Gateway to Receive Email](#), on page 65.

## Encrypting and Immediately Delivering Messages using a Content Filter

### Before You Begin

- To understand the concept of building conditions for content filters, see [Overview of Content Filters](#), on page 269.
- (Optional) See [Inserting Encryption Headers into Messages](#), on page 545.

### Procedure

- 
- Step 1** Go to **Mail Policies > Outgoing Content Filters**.
- Step 2** In the Filters section, click **Add Filter**.
- Step 3** In the Conditions section, click **Add Condition**.
- Step 4** Add a condition to filter the messages that you want to encrypt. For example, to encrypt sensitive material, you might add a condition that identifies messages containing particular words or phrases, such as “Confidential,” in the subject or body.
- Step 5** Click **OK**.
- Step 6** Optionally, click **Add Action** and select **Add Header** to insert an encryption header into the messages to specify an additional encryption setting.
- Step 7** In the Actions section, click **Add Action**.
- Step 8** Select **Encrypt and Deliver Now (Final Action)** from the **Add Action** list.
- Step 9** Select whether to always encrypt messages that meet the condition or to only encrypt messages if the attempt to send it over a TLS connection fails.
- Step 10** Select the encryption profile to associate with the content filter.
- The encryption profile specifies settings about the key server to use, levels of security, formatting of the message envelope, and other message settings. When you associate an encryption profile with the content filter, the content filter uses these stored settings to encrypt messages.
- Step 11** Enter a subject for the message.
- Step 12** Click **OK**.
- The content filter in the following figure shows a content filter that searches for ABA content in the message body. The action defined for the content filter specifies that the email is encrypted and delivered.

Figure 35: Encryption Content Filter

**Content Filter Settings**

Name:

Currently Used by Policies: *No policies currently use this rule.*

Description:

Order:  (of 2)

---

**Conditions**

| Order | Condition    | Rule                          | Delete                                |
|-------|--------------|-------------------------------|---------------------------------------|
| 1     | Message Body | only-body-contains("*aba", 1) | <input type="button" value="Delete"/> |

---

**Actions**

| Order | Action                             | Rule                                      | Delete                                |
|-------|------------------------------------|-------------------------------------------|---------------------------------------|
| 1     | Encrypt and Deliver (Final Action) | encrypt("encrypt_sensitive", "\$Subject") | <input type="button" value="Delete"/> |

**Step 13** After you add the encrypt action, click **Submit**.

**Step 14** Commit your changes.

### What to do next

After you add the content filter, you need to add the filter to an outgoing mail policy. You may want to enable the content filter on the default policy, or you may choose to apply the filter to a specific mail policy, depending on your organization's needs. For information about working with mail policies, see [Overview of Mail Policies](#), on page 255.

## Encrypting a Message upon Delivery using a Content Filter

Create a content filter to encrypt a message on delivery, which means that the message continues to the next stage of processing, and when all processing is complete, the message is encrypted and delivered.

### Before You Begin

- To understand the concept of building conditions for content filters, see [Overview of Content Filters](#), on page 269.
- (Optional) See [Inserting Encryption Headers into Messages](#), on page 545.

### Procedure

**Step 1** Go to **Mail Policies > Outgoing Content Filters**.

**Step 2** In the Filters section, click **Add Filter**.

**Step 3** In the Conditions section, click **Add Condition**.

**Step 4** Add a condition to filter the messages that you want to encrypt. For example, to encrypt sensitive material, you might add a condition that identifies messages containing particular words or phrases, such as "Confidential," in the subject or body.

**Step 5** Click **OK**.

**Step 6** Optionally, click **Add Action** and select **Add Header** to insert an encryption header into the messages to specify an additional encryption setting.



- Step 7** In the Actions section, click **Add Action**.
- Step 8** Select **Encrypt on Delivery** from the **Add Action** list.
- Step 9** Select whether to always encrypt messages that meet the condition or to only encrypt messages if the attempt to send it over a TLS connection fails.
- Step 10** Select the encryption profile to associate with the content filter.
- The encryption profile specifies settings about the key server to use, levels of security, formatting of the message envelope, and other message settings. When you associate an encryption profile with the content filter, the content filter uses these stored settings to encrypt messages.
- Step 11** Enter a subject for the message.
- Step 12** Click **OK**.
- Step 13** After you add the encrypt action, click **Submit**.
- Step 14** Commit your changes.

---

### What to do next

After you add the content filter, you need to add the filter to an outgoing mail policy. You may want to enable the content filter on the default policy, or you may choose to apply the filter to a specific mail policy, depending on your organization's needs. For information about working with mail policies, see [Overview of Mail Policies, on page 255](#).

## Inserting Encryption Headers into Messages

AsyncOS enables you to add encryption settings to a message by inserting an SMTP header into a message using either a content filter or a message filter. The encryption header can override the encryption settings defined in the associated encryption profile, and it can apply specified encryption features to messages.



---

**Note** The Cisco Ironport Encryption appliance must be set up to handle flagged messages.

---

### Procedure

---

- Step 1** Go to **Mail Policies > Outgoing Content Filters** or **Incoming Content Filters**.
- Step 2** In the Filters section, click **Add Filter**.
- Step 3** In the Actions section, click **Add Action** and select **Add/Edit Header** to insert an encryption header into the messages to specify an additional encryption setting.

For example, if you want a Registered Envelope to expire in 24 hours after you send it, type X-PostX-ExpirationDate as the header name and +24:00:00 as the header value.

---

### What to do next

### Related Topics

- [Encryption Headers, on page 546](#)
- [Encryption Headers Examples, on page 547](#)
- For more information about creating an encryption content filter, see [Encrypting and Immediately Delivering Messages using a Content Filter, on page 543](#).
- For information about inserting a header using a message filter, see [Using Message Filters to Enforce Email Policies, on page 127](#).

## Encryption Headers

The following table displays the encryption headers that you can add to messages.

**Table 45: Email Encryption Headers**

| MIME Header                 | Description                                                                                                                                                                                                                                                                                                                                                                                                                                                                                                                                                                         | Value                                                                                                                                                                                             |
|-----------------------------|-------------------------------------------------------------------------------------------------------------------------------------------------------------------------------------------------------------------------------------------------------------------------------------------------------------------------------------------------------------------------------------------------------------------------------------------------------------------------------------------------------------------------------------------------------------------------------------|---------------------------------------------------------------------------------------------------------------------------------------------------------------------------------------------------|
| X-PostX-Reply-Enabled       | Indicates whether to enable secure reply for the message and displays the Reply button in the message bar. This header adds an encryption setting to the message.                                                                                                                                                                                                                                                                                                                                                                                                                   | A Boolean for whether to display the Reply button. Set to true to display the button. The default value is false .                                                                                |
| X-PostX-Reply-All-Enabled   | Indicates whether to enable secure “reply all” for the message and displays the Reply All button in the message bar. This header overrides the default profile setting.                                                                                                                                                                                                                                                                                                                                                                                                             | A Boolean for whether to display Reply All button. Set to true to display the button. The default value is false .                                                                                |
| X-PostX-Forward-Enabled     | Indicates whether to enable secure message forwarding and displays the Forward button in the message bar. This header overrides the default profile setting.                                                                                                                                                                                                                                                                                                                                                                                                                        | A Boolean for whether to display the Forward button. Set to true to display the button. The default value is false .                                                                              |
| X-PostX-Send-Return-Receipt | Indicates whether to enable read receipts. The sender receives a receipt when recipients open the Secure Envelope. This header overrides the default profile setting.                                                                                                                                                                                                                                                                                                                                                                                                               | A Boolean for whether to send a read receipt. Set to true to display the button. The default value is false .                                                                                     |
| X-PostX-Expiration-Date     | <p>Defines a Registered Envelope’s expiration date before sending it. The key server restricts access to the Registered Envelope after the expiration date. The Registered Envelope displays a message indicating that the message has expired. This header adds an encryption setting to the message.</p> <p>If you use Cisco Registered Envelope Service, you can log in to the website at <a href="http://res.cisco.com">http://res.cisco.com</a> and use the message management features to set, adjust, or eliminate the expiration dates of messages after you send them.</p> | A string value containing relative date or time. Use the +HH:MM:SS format for relative hours, minutes, and seconds, and the +D format for relative days. By default, there is no expiration date. |

| MIME Header                            | Description                                                                                                                                                                                                                                                                                                                                                                                                                                                                                       | Value                                                                                                                                                                                             |
|----------------------------------------|---------------------------------------------------------------------------------------------------------------------------------------------------------------------------------------------------------------------------------------------------------------------------------------------------------------------------------------------------------------------------------------------------------------------------------------------------------------------------------------------------|---------------------------------------------------------------------------------------------------------------------------------------------------------------------------------------------------|
| X-PostX-ReadNotification-Date          | Defines the Registered Envelope's "read by" date before sending it. The local key server generates a notification if the Registered Envelope has not been read by this date. Registered Envelopes with this header do not work with Cisco Registered Envelope Service, only a local key server. This header adds an encryption setting to the message.                                                                                                                                            | A string value containing relative date or time. Use the +HH:MM:SS format for relative hours, minutes, and seconds, and the +D format for relative days. By default, there is no expiration date. |
| X-PostX-Suppress-Applet-For-Open       | Indicates whether to disable the decryption applet. The decryption applet causes message attachments to be opened in the browser environment. Disabling the applet causes the message attachment to be decrypted at the key server. If you disable this option, messages may take longer to open, but they are not dependent on the browser environment. This header overrides the default profile setting.                                                                                       | A Boolean for whether to disable the decryption applet. Set to true to disable the applet. The default value is false .                                                                           |
| X-PostX-Use-Script                     | Indicates whether to send JavaScript-free envelopes. A JavaScript-free envelope is a Registered Envelope that does not include the JavaScript that is used to open envelopes locally on the recipient's computer. The recipient must use either the Open Online method or the Open by Forwarding method to view the message. Use this header if a recipient domain's gateway strips JavaScript and makes the encrypted message unopenable. This header adds an encryption setting to the message. | A Boolean for whether the JavaScript applet should be included or not. Set to false to send a JavaScript-free envelope. The default value is true .                                               |
| X-PostX-Remember-Envelope-Key-Checkbox | Indicates whether to allow envelope-specific key caching for offline opening of envelopes. With envelope key caching, the decryption key for a particular envelope is cached on the recipient's computer when the recipient enters the correct passphrase and selects the "Remember the password for this envelope" check box. After that, the recipient does not need to enter a passphrase again to reopen the envelope on the computer. This header adds an encryption setting to the message. | A Boolean for whether to enable envelope key caching and display the "Remember the password for this envelope" check box. The default value is false .                                            |

## Encryption Headers Examples

This section provides examples of encryption headers.

### Related Topics

- [Enabling JavaScript-Free Envelopes, on page 548](#)
- [Enabling Envelope Key Caching for Offline Opening, on page 548](#)
- [Enabling Message Expiration, on page 548](#)

- [Disabling the Decryption Applet, on page 548](#)

## Enabling Envelope Key Caching for Offline Opening

To send a Registered Envelope with envelope key caching enabled, insert the following header into the message:

```
X-PostX-Remember-Envelope-Key-Checkbox: true
```

The “Remember the password for this envelope” check box is displayed on the Registered Envelope.

## Enabling JavaScript-Free Envelopes

To send a Registered Envelope that is JavaScript-free, insert the following header into the message:

```
X-PostX-Use-Script: false
```

When the recipient opens the securedoc.html attachment, the Registered Envelope is displayed with an Open Online link, and the Open button is disabled.

## Enabling Message Expiration

To configure a message so that it expires 24 hours after you send it, insert the following header into the message:

```
X-PostX-ExpirationDate: +24:00:00
```

The recipient can open and view the content of the encrypted message during the 24-hour period after you send it. After that, the Registered Envelope displays a message indicating that the envelope has expired.

## Disabling the Decryption Applet

To disable the decryption applet and have the message attachment decrypted at the key server, insert the following header into the message:

```
X-PostX-Suppress-Applet-For-Open: true
```



---

**Note** The message may take longer to open when you disable the decryption applet, but it is not dependent on the browser environment.

---



## CHAPTER 24

# S/MIME Security Services

---

This chapter contains the following sections:

- [Overview of S/MIME Security Services, on page 549](#)
- [S/MIME Security Services in Email Gateway, on page 549](#)
- [Signing, Encrypting, or Signing and Encrypting Outgoing Messages using S/MIME, on page 553](#)
- [Verifying, Decrypting, or Decrypting and Verifying Incoming Messages using S/MIME, on page 563](#)
- [S/MIME Certificate Requirements, on page 569](#)
- [Managing Public Keys, on page 570](#)

## Overview of S/MIME Security Services

Secure/Multipurpose Internet Mail Extensions (S/MIME) is a standards-based method for sending and receiving secure, verified email messages. S/MIME uses public/private key pair to encrypt or sign messages. This way,

- If the message is encrypted, only the message recipient can open the encrypted message.
- If the message is signed, the message recipient can validate the identity of the sender's domain and can be assured that the message has not been altered while in transit.

For more information about S/MIME, review the following RFCs:

- RFC 5750: Secure/Multipurpose Internet Mail Extensions (S/MIME) Version 3.2 - Certificate Handling
- RFC 5751: Secure/Multipurpose Internet Mail Extensions (S/MIME) Version 3.2 - Message Specification
- RFC 3369: Cryptographic Message Syntax

## S/MIME Security Services in Email Gateway

Organizations may want to communicate securely using S/MIME without requiring that all end users possess their own certificates. For such organizations, the email gateway supports S/MIME security services (signing, encryption, verification, and decryption) at the gateway level using certificates that identify the organization rather than the individual user.

The email gateway provides the following S/MIME security services for Business-to-Business (B2B) and Business-to-Consumer (B2C) scenarios:

- Sign, encrypt, or sign and encrypt messages using S/MIME. See [Signing, Encrypting, or Signing and Encrypting Outgoing Messages using S/MIME, on page 553](#).

- Verify, decrypt, or decrypt and verify messages using S/MIME. See [Verifying, Decrypting, or Decrypting and Verifying Incoming Messages using S/MIME](#), on page 563.

### Related Topics

- [Understanding How S/MIME Security Services Works](#), on page 550

## Understanding How S/MIME Security Services Works

- [Scenario: Business-to-Business](#), on page 550
- [Scenario: Business-to-Consumer](#), on page 552

### Scenario: Business-to-Business

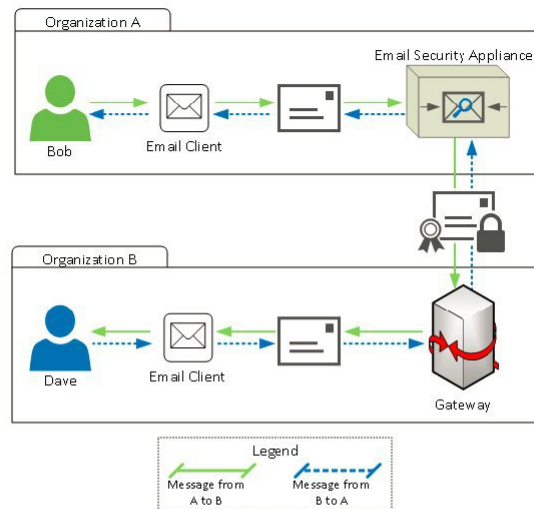

Organizations A and B want all the messages communicated between them to be signed and encrypted using S/MIME. Organization A has configured Cisco Secure Email Gateway to perform S/MIME security services at the gateway level. Organization B has configured a third-party application to perform S/MIME security services at the gateway level.



---

**Note** The current example assumes that organization B is using a third-party application to perform S/MIME security services. In the real world, this can be any application or email gateway (including Cisco Secure Email Gateway) that can perform S/MIME security services at the gateway level.

---

**Organization A sending a message to Organization B:**

1. Bob (Organization A) uses an email client to send an unsigned and unencrypted message to Dave (Organization B).
2. Cisco Secure Email Gateway in the Organization A signs and encrypts the messages and sends it to Organization B.
3. The third-party application at the gateway of Organization B decrypts and verifies the message.
4. Dave receives an unencrypted and signed message.

**Organization B sending a message to Organization A:**

1. Dave (Organization B) uses an email client to send an unsigned and unencrypted message to Bob (Organization A).
2. The third-party application at the gateway of Organization B signs and encrypts the message and sends it to Organization A.
3. Cisco Secure Email Gateway in the Organization A decrypts and verifies the message.
4. Bob receives an unencrypted and signed message.

## Scenario: Business-to-Consumer

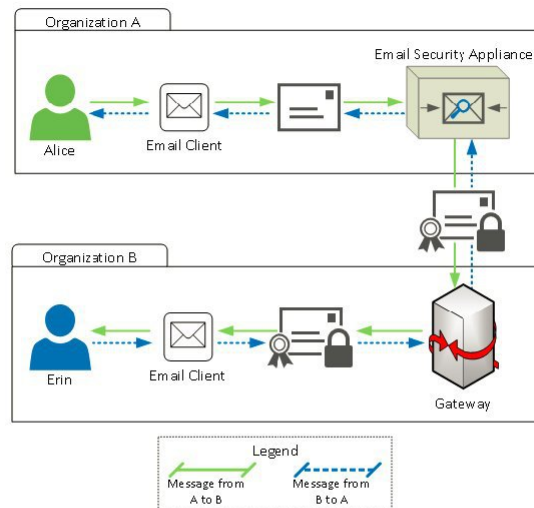

Organizations A and B want all the messages communicated between them to be signed and encrypted using S/MIME. Organization A has configured Cisco Secure Email Gateway to perform S/MIME security services at the gateway level. Organization B has configured the email clients of all the users to perform S/MIME security services.

### Organization A sending a message to Organization B:

1. Alice (Organization A) uses an email client to send an unsigned and unencrypted message to Erin (Organization B).
2. Secure Email Gateway in the Organization A signs and encrypts the messages and sends it to Organization B.
3. The email client in the Organization B decrypts and verifies the message and displays it to Erin.

### Organization B sending a message to Organization A:

1. Erin (Organization B) uses the email client to sign and encrypt a message and sends it to Alice (Organization A).
2. Secure Email Gateway in the Organization A decrypts and verifies the message.
3. Alice receives an unencrypted and unsigned message.



# Signing, Encrypting, or Signing and Encrypting Outgoing Messages using S/MIME

- [S/MIME Signing and Encryption Workflow in Email Gateway, on page 553](#)
- [How to Sign, Encrypt, or Sign and Encrypt Outgoing Messages using S/MIME, on page 554](#)
- [Setting Up Certificates for S/MIME Signing, on page 555](#)
- [Setting Up Public Keys for S/MIME Encryption, on page 557](#)
- [Managing S/MIME Sending Profiles, on page 559](#)
- [Determining Which Messages to Sign, Encrypt, or Sign and Encrypt, on page 561](#)
- [Signing, Encrypting, or Signing and Encrypting and Immediately Delivering Messages using a Content Filter, on page 562](#)
- [Signing, Encrypting, or Signing and Encrypting a Message upon Delivery using a Content Filter, on page 562](#)



---

**Note** You can use the email gateway to sign, encrypt, and sign and encrypt outgoing and incoming messages.

---

## S/MIME Signing and Encryption Workflow in Email Gateway

- [S/MIME Signing Workflow, on page 553](#)
- [S/MIME Encryption Workflow, on page 553](#)

### S/MIME Signing Workflow

The following process describes how the email gateway performs S/MIME signing.

1. Apply a hash algorithm to the message to create a message digest.
2. Encrypt the message digest using private key of the email gateway's S/MIME certificate.
3. Create a PKCS7 signature with the encrypted message digest and public key of the email gateway's S/MIME certificate.
4. Sign the message by attaching the PKCS7 signature to the message.
5. Send the signed message to the recipient.

### S/MIME Encryption Workflow

The following process describes how the email gateway performs S/MIME encryption.

1. Create a pseudo-random session key.
2. Encrypt the message body using the session key.
3. Encrypt the session key using the public key of the recipient's (gateway or consumer) S/MIME certificate.
4. Attach the encrypted session key to the message.
5. Send the encrypted message to the recipient.



**Note** If PXE and S/MIME encryption is enabled on the email gateway, it encrypts messages using S/MIME first, and then using PXE.

## How to Sign, Encrypt, or Sign and Encrypt Outgoing Messages using S/MIME

| Steps  | Do This                                                                                                                                                                                                                                                                                                                                                                                                                    | More Info                                                                                                                                                                                                                                                                                                                         |
|--------|----------------------------------------------------------------------------------------------------------------------------------------------------------------------------------------------------------------------------------------------------------------------------------------------------------------------------------------------------------------------------------------------------------------------------|-----------------------------------------------------------------------------------------------------------------------------------------------------------------------------------------------------------------------------------------------------------------------------------------------------------------------------------|
| Step 1 | Understand the S/MIME certificate requirements.                                                                                                                                                                                                                                                                                                                                                                            | See <a href="#">S/MIME Certificate Requirements</a> , on page 569.                                                                                                                                                                                                                                                                |
| Step 2 | Depending on your requirements, do one of the following: <ul style="list-style-type: none"> <li>For S/MIME signing, set up an S/MIME signing certificate.</li> <li>For S/MIME encryption, set up the public key of the recipient's S/MIME certificate.</li> <li>For S/MIME signing and encryption, set up an S/MIME signing certificate and the public key of the recipient's S/MIME certificate, respectively.</li> </ul> | See: <ul style="list-style-type: none"> <li><a href="#">Setting Up Certificates for S/MIME Signing</a>, on page 555</li> <li><a href="#">Setting Up Public Keys for S/MIME Encryption</a>, on page 557</li> </ul>                                                                                                                 |
| Step 3 | Create a profile for signing, encrypting, or signing and encrypting messages.                                                                                                                                                                                                                                                                                                                                              | See <a href="#">Create an S/MIME Sending Profile for Signing, Encrypting, or Signing and Encrypting Messages</a> , on page 560.                                                                                                                                                                                                   |
| Step 4 | Define the conditions that messages must meet in order for the email gateway to sign, encrypt, or sign and encrypt them.                                                                                                                                                                                                                                                                                                   | See <a href="#">Determining Which Messages to Sign, Encrypt, or Sign and Encrypt</a> , on page 561.                                                                                                                                                                                                                               |
| Step 5 | Determine when in the email workflow to sign, encrypt, or sign and encrypt messages.                                                                                                                                                                                                                                                                                                                                       | See: <ul style="list-style-type: none"> <li><a href="#">Signing, Encrypting, or Signing and Encrypting and Immediately Delivering Messages using a Content Filter</a>, on page 562</li> <li><a href="#">Signing, Encrypting, or Signing and Encrypting a Message upon Delivery using a Content Filter</a>, on page 562</li> </ul> |
| Step 6 | Define groups of users for whom you want to sign or encrypt messages.                                                                                                                                                                                                                                                                                                                                                      | Create a mail policy.<br>See <a href="#">Mail Policies</a> , on page 255                                                                                                                                                                                                                                                          |
| Step 7 | Associate the signing or encryption actions that you defined with the user groups you defined.                                                                                                                                                                                                                                                                                                                             | Associate the content filter with the mail policy.<br>See <a href="#">Mail Policies</a> , on page 255                                                                                                                                                                                                                             |



**Note** If you want to perform S/MIME signing, encryption, or signing and encryption using CLI, use the `smimeconfig` command. See *CLI Reference Guide for AsyncOS for Cisco Secure Email Gateway*.

## Setting Up Certificates for S/MIME Signing

You must set up an S/MIME certificate for signing messages. The email gateway allows you to set up S/MIME signing certificates using one of the following methods:

- Create a self-signed S/MIME certificate using the email gateway. See [Creating a Self-Signed S/MIME Certificate, on page 555](#).
- Import an existing S/MIME certificate to the email gateway. See [Importing an S/MIME Signing Certificate, on page 556](#).



**Note** Cisco recommends that you use self-signed S/MIME certificates for sending signed messages to the users within your organization or in a testing environment. For sending signed messages to external users or in a production environment, use a valid S/MIME certificate obtained from a trusted CA.

For understanding the certificate requirements for S/MIME, see [S/MIME Certificate Requirements, on page 569](#).

## Creating a Self-Signed S/MIME Certificate

You can generate self-signed S/MIME certificates that are compliant to RFC 5750 (Secure/Multipurpose Internet Mail Extensions (S/MIME) Version 3.2 - Certificate Handling) using the web interface or CLI.



**Note** Cisco recommends that you use self-signed S/MIME certificates for sending signed messages to the users within your organization or in a testing environment.

### Procedure

- Step 1** Click **Network > Certificates**.
- Step 2** Click **Add Certificate**.
- Step 3** Choose **Create Self-Signed S/MIME Certificate**.
- Step 4** Enter the following information for the self-signed certificate:

| Common Name         | The fully qualified domain name.                    |
|---------------------|-----------------------------------------------------|
| Organization        | The exact legal name of the organization.           |
| Organizational Unit | Section of the organization.                        |
| City (Locality)     | The city where the organization is legally located. |

|                                   |                                                                                                                                                                                                                                                                   |
|-----------------------------------|-------------------------------------------------------------------------------------------------------------------------------------------------------------------------------------------------------------------------------------------------------------------|
| <b>Common Name</b>                | <b>The fully qualified domain name.</b>                                                                                                                                                                                                                           |
| State (Province)                  | The state, county, or region where the organization is legally located.                                                                                                                                                                                           |
| Country                           | The two letter ISO abbreviation of the country where the organization is legally located.                                                                                                                                                                         |
| Duration before expiration        | The number of days before the certificate expires.                                                                                                                                                                                                                |
| Subject Alternative Name(Domains) | If you configure this field, any user from the specified domain can send signed messages.<br><br>Name of the domain from which you plan to send signed messages. Examples include domain.com and *.domain.net . For multiple entries, use a comma-separated list. |
| Subject Alternative Name(Email)   | If you configure this field, only the specified users can send signed messages.<br><br>Email address of the user who is planning to send signed messages, for example, user@somedomain.com . For multiple entries, use a comma-separated list.                    |
| Private Key Size                  | Size of the private key to generate the certificate signing request (CSR).                                                                                                                                                                                        |

**Note** An S/MIME signing certificate can contain both Subject Alternative Name (Domains) and Subject Alternative Name (Email).

**Step 5** Click **Next** to view the certificate and signature information.

**Step 6** Depending on your requirements, do the following:

- Select the **FQDN Validation** check box to allow the email gateway to check whether the 'Common Name,' 'SAN: DNS Name' fields, or both present in the certificate, are in the FQDN format.
- Enter a name for the certificate.
- If you want to submit a CSR for the self-signed certificate to a certificate authority, click **Download Certificate Signing Request** to save the CSR in PEM format to a local or network machine.

**Step 7** Submit and commit your changes.

#### What to do next



**Note** Use the `certconfig` command to generate self-signed S/MIME certificates using CLI.

## Importing an S/MIME Signing Certificate

If you already have an S/MIME certificate for signing messages, you can add it to the email gateway by importing it.

### Before You Begin

Make sure that the S/MIME certificate that you plan to import meets the requirements described in [S/MIME Certificate Requirements, on page 569](#).

### Procedure

---

- Step 1** Click **Network > Certificates**.
  - Step 2** Click **Add Certificate**.
  - Step 3** Choose **Import Certificate**.
  - Step 4** Enter the path to the certificate file on your network or local machine.
  - Step 5** Enter the passphrase for the file.
  - Step 6** Click **Next** to view the certificate's information.
  - Step 7** [Optional] Select the **FQDN Validation** check box to allow the email gateway to check whether the 'Common Name,' 'SAN: DNS Name' fields, or both present in the certificate, are in the FQDN format.
  - Step 8** Enter a name for the certificate.
  - Step 9** Submit and commit your changes.
- 

### What to do next



**Note** Use the `certconfig` command to import S/MIME certificates using CLI.

---

## Setting Up Public Keys for S/MIME Encryption

You must add the public key of the recipient's S/MIME certificate to the email gateway for encrypting messages. Depending on your organizational policies and processes, you can use one of the following methods to add the public key to the email gateway:

- Request the recipient to send the public key using an electronic channel, for example, email. You can then add the public key using the web interface or CLI.  
For instructions to add the public key, see [Adding a Public Key for S/MIME Encryption, on page 557](#).
- Enable public key harvesting using the web interface or CLI and request the recipient to send a signed message. The Email Security email gateway can harvest the public key from the signed message.  
For instructions to harvest public key from an incoming signed message, see [Harvesting Public Keys, on page 558](#).

## Adding a Public Key for S/MIME Encryption

### Before You Begin

- Make sure that the public key meets the requirements described in [S/MIME Certificate Requirements, on page 569](#).
- Make sure that the public key is in PEM format.

### Procedure

---

- Step 1** Click **Mail Policies > Public Keys**.
  - Step 2** Click **Add Public Key**.
  - Step 3** Enter the name of the public key.
  - Step 4** Enter the public key.
  - Step 5** Submit and commit your changes.
- 

### What to do next



**Note** Use the `smimeconfig` command to add public keys using CLI.

---

## S/MIME Harvested Public Keys

You can configure the email gateway to retrieve (harvest) public keys from the incoming S/MIME signed messages and use the harvested keys to send encrypted messages to the owners (business or consumer) of the harvested keys.

Public key harvesting can be enabled on the Mail Flow Policies. All the harvested public keys are listed on the S/MIME Harvested Public Keys page.

### Related Topic

- [Harvesting Public Keys, on page 558](#)

## Harvesting Public Keys

You can configure the email gateway to retrieve (harvest) public key from the incoming S/MIME signed messages and use it to send encrypted messages to the owner (business or consumer) of the harvested key.



**Note** By default, public keys from expired or self-signed S/MIME certificates are not harvested.

---

### Before You Begin

Make sure that the public key of the sender's S/MIME certificate meets the requirements described in [S/MIME Certificate Requirements, on page 569](#).

### Procedure

---

- Step 1** Click **Mail Policies > Mail Flow Policies**.
- Step 2** Create a new Mail Flow Policy or modify an existing one.
- Step 3** Scroll down to the **Security Features** section.
- Step 4** Under S/MIME Public Key Harvesting, do the following:

- Enable S/MIME public key harvesting.
- (Optional) Choose whether to harvest public keys if the verification of the incoming signed messages fail.
- (Optional) Choose whether to harvest updated public keys.

**Note** If an email gateway receives more than one updated public key from the same domain or message within 48 hours, it sends out a warning alert.

**Step 5** Submit and commit your changes.

---

### What to do next



**Note** The size of the harvested public key repository on the email gateway is 512 MB. If repository is full, the email gateway will automatically remove unused public keys.

Use the `listenerconfig` command to enable key harvesting using CLI.

---

### Next Step

Request the recipient to send a signed message to the email gateway administrator. The email gateway will harvest the public key from the signed message and displays it on the Mail Policies > Harvested Public Keys page.

### Related Topics

- [S/MIME Harvested Public Keys, on page 558](#)

## Managing S/MIME Sending Profiles

An S/MIME sending profile allows you define parameters such as:

- S/MIME mode to use, for example, sign, encrypt, and so on.
- S/MIME certificate for signing
- S/MIME signing mode to use, for example, opaque or detached.
- Action to take if the public key of the recipient's S/MIME certificate is not available on the email gateway.

For example, one organization requires all the messages sent to them be signed and another one requires all the messages sent to them be signed and encrypted. In this scenario, you must create two sending profiles, one for signing alone and one for signing and encryption.

You can create, edit, delete, import, export, and search S/MIME sending profiles using the web interface or CLI.

### Related Topics

- [Create an S/MIME Sending Profile for Signing, Encrypting, or Signing and Encrypting Messages, on page 560](#)
- [Edit an S/MIME Sending Profile, on page 561](#)

## Create an S/MIME Sending Profile for Signing, Encrypting, or Signing and Encrypting Messages

### Procedure

**Step 1** Click **Mail Policies > Sending Profiles**.

**Step 2** Click **Add Profile**.

**Step 3** Configure the following fields:

|                            |                                                                                                                                                                                                                                                                                                                                                                                                                                                                                                                                                                                                                                                          |
|----------------------------|----------------------------------------------------------------------------------------------------------------------------------------------------------------------------------------------------------------------------------------------------------------------------------------------------------------------------------------------------------------------------------------------------------------------------------------------------------------------------------------------------------------------------------------------------------------------------------------------------------------------------------------------------------|
| <b>S/MIME Profile Name</b> | <b>Enter the name of the sending profile.</b>                                                                                                                                                                                                                                                                                                                                                                                                                                                                                                                                                                                                            |
| S/MIME Mode                | <p>Choose the S/MIME mode. Possible values are:</p> <ul style="list-style-type: none"> <li>• <b>Sign</b></li> <li>• <b>Encrypt</b></li> <li>• <b>Sign/Encrypt</b>. Sign and then encrypt</li> <li>• <b>Triple</b>. Sign, encrypt, and then sign again</li> </ul> <p><b>Note</b> If you are using one of the following S/MIME modes: <b>Sign</b>, <b>Sign/Encrypt</b>, or <b>Triple</b>, messages will be bounced to the sender if the signing fails.</p>                                                                                                                                                                                                 |
| Signing Certificate        | <p>Choose the signing certificate to use.</p> <p><b>Note</b> You need to set this field only if you choose one of the following S/MIME modes: <b>Sign</b>, <b>Sign/Encrypt</b>, or <b>Triple</b>.</p>                                                                                                                                                                                                                                                                                                                                                                                                                                                    |
| S/MIME Sign Mode           | <p>Choose the mode of S/MIME signing. Possible values are:</p> <ul style="list-style-type: none"> <li>• <b>Opaque</b>. An opaque-signed message contains the message and signature combined in a single part and can be read only by verifying the signature.</li> <li>• <b>Detached</b>. The signature information is separate from the text being signed. The MIME type for this is multipart/signed with the second part having a MIME subtype of application/(x-)pkcs7-signature.</li> </ul> <p><b>Note</b> You need to set this field only if you choose one of the following S/MIME modes: <b>Sign</b>, <b>Sign/Encrypt</b>, or <b>Triple</b>.</p> |



|                            |                                                                                                                                                                                                                                                                                                                                                                                                                                                                                                                                                                                                                                                                                                                                                                                                                                                                                                                                                                                                                                                                                                                                                                                                                                                                   |
|----------------------------|-------------------------------------------------------------------------------------------------------------------------------------------------------------------------------------------------------------------------------------------------------------------------------------------------------------------------------------------------------------------------------------------------------------------------------------------------------------------------------------------------------------------------------------------------------------------------------------------------------------------------------------------------------------------------------------------------------------------------------------------------------------------------------------------------------------------------------------------------------------------------------------------------------------------------------------------------------------------------------------------------------------------------------------------------------------------------------------------------------------------------------------------------------------------------------------------------------------------------------------------------------------------|
| <b>S/MIME Profile Name</b> | <b>Enter the name of the sending profile.</b>                                                                                                                                                                                                                                                                                                                                                                                                                                                                                                                                                                                                                                                                                                                                                                                                                                                                                                                                                                                                                                                                                                                                                                                                                     |
| S/MIME Action              | <p>Choose the action that the email gateway must take if the recipient's public key is not available. Possible values are:</p> <ul style="list-style-type: none"> <li>• <b>Bounce.</b> The message is bounced to the sender if any one of the recipient's public key is not available.</li> <li>• <b>Drop.</b> The message is dropped if any one of the recipient's public key is not available.</li> <li>• <b>Split.</b> The message is split. The message to the recipients whose public keys are not available are delivered without encryption and the message to the recipients whose public keys are available are encrypted and delivered.</li> </ul> <p><b>Example:</b> Assume that you are sending a message to bob@example1.com and dave@example2.com and the public key of dave@example2.com is not available. In this scenario, if you have selected <b>Split</b>, the email gateway will:</p> <ul style="list-style-type: none"> <li>• Deliver the message to bob@example1.com after encrypting it.</li> <li>• Deliver the message to dave@example2.com without encrypting it.</li> </ul> <p><b>Note</b> You need to set this field only if you choose one of the following S/MIME modes: <b>Encrypt</b>, <b>Sign/Encrypt</b>, or <b>Triple</b>.</p> |

**Step 4** Submit and commit your changes.

#### What to do next



**Note** Use the `smimeconfig` command to create sending profiles using CLI.

## Edit an S/MIME Sending Profile

### Procedure

- Step 1** Click **Mail Policies > Sending Profiles**.
- Step 2** Click on the sending profile that you want to modify.
- Step 3** Edit the fields as described in [Create an S/MIME Sending Profile for Signing, Encrypting, or Signing and Encrypting Messages, on page 560](#).
- Step 4** Submit and commit your changes.

## Determining Which Messages to Sign, Encrypt, or Sign and Encrypt

After you create a sending profile, you need to create an outgoing content filter that determines which email messages should be signed, encrypted, or signed and encrypted. The content filter scans outgoing email and

determines if the message matches the conditions specified. Once the content filter determines a message matches the condition, the email gateway signs, encrypts, or signs or encrypts the message.

#### Related Topics

- [How to Filter Messages Based on Content, on page 287](#)

## Signing, Encrypting, or Signing and Encrypting and Immediately Delivering Messages using a Content Filter

### Before You Begin

Understand the concept of building conditions for content filters. See [How Content Filters Work, on page 269](#).

### Procedure

---

- Step 1** Go to **Mail Policies > Outgoing Content Filters**.
- Step 2** In the Filters section, click **Add Filter**.
- Step 3** In the Conditions section, click **Add Condition**.
- Step 4** Add a condition to filter the messages that you want to sign, encrypt, or sign and encrypt. For example, to encrypt sensitive material, you might add a condition that identifies messages containing particular words or phrases, such as “Confidential,” in the subject or body.
- Step 5** Click **OK**.
- Step 6** In the Actions section, click **Add Action**.
- Step 7** Select **S/MIME Sign/Encrypt (Final Action)** from the **Add Action** list.
- Step 8** Select the sending profile to associate with the content filter.
- Step 9** Click **OK**.
- Step 10** Submit and commit your changes.
- 

### What to do next

After you add the content filter, you need to add the filter to an outgoing mail policy. You may want to enable the content filter on the default policy, or you may choose to apply the filter to a specific mail policy, depending on your organization’s needs. For information about working with mail policies, see [Overview of Mail Policies, on page 255](#).

## Signing, Encrypting, or Signing and Encrypting a Message upon Delivery using a Content Filter

Create a content filter to sign, encrypt, or sign and encrypt a message on delivery, which means that the message continues to the next stage of processing, and when all processing is complete, the message is signed, encrypted, or signed and encrypted, and delivered.

### Before You Begin

- Understand the concept of building conditions for content filters. See [Overview of Content Filters](#) , on page 269.

### Procedure

---

- Step 1** Go to **Mail Policies > Outgoing Content Filters**.
- Step 2** In the Filters section, click **Add Filter**.
- Step 3** In the Conditions section, click **Add Condition**.
- Step 4** Add a condition to filter the messages that you want to sign, encrypt, or sign and encrypt. For example, to encrypt sensitive material, you might add a condition that identifies messages containing particular words or phrases, such as “Confidential,” in the subject or body.
- Step 5** Click **OK**.
- Step 6** In the Actions section, click **Add Action**.
- Step 7** Select **S/MIME Sign/Encrypt on Delivery** from the **Add Action** list.
- Step 8** Select the sending profile to associate with the content filter.
- Step 9** Click **OK**.
- Step 10** Submit and commit your changes.
- 

### What to do next

After you add the content filter, you need to add the filter to an outgoing mail policy. You may want to enable the content filter on the default policy, or you may choose to apply the filter to a specific mail policy, depending on your organization’s needs. For information about working with mail policies, see [Overview of Mail Policies](#), on page 255.

## Verifying, Decrypting, or Decrypting and Verifying Incoming Messages using S/MIME

- [S/MIME Verification and Decryption Workflow in Email Gateway](#), on page 563
- [How to Verify, Decrypt, or Decrypt and Verify Incoming Messages Using S/MIME](#), on page 564
- [Setting Up Certificates for Decrypting Messages](#), on page 565
- [Setting Up Public Keys for Verifying Signed Messages](#), on page 566
- [Enabling S/MIME Decryption and Verification](#), on page 568
- [Configuring an Action for S/MIME Decrypted or Verified Message](#), on page 568



---

**Note** You can use the email gateway S/MIME security services to verify, decrypt, or decrypt and verify outgoing and incoming messages.

---

## S/MIME Verification and Decryption Workflow in Email Gateway

- [S/MIME Verification Workflow](#), on page 564

- [S/MIME Decryption Workflow, on page 564](#)

## S/MIME Verification Workflow

The following process describes how the email gateway performs S/MIME verification.

1. Apply a hash algorithm to the signed message to create a message digest.
2. Decrypt the PKCS7 signature attached to the signed message using the public key of the sender's S/MIME certificate, and get the message digest.
3. Compare the generated message digest with the message digest retrieved from the signed message. If the message digests match, the message is verified.
4. Validate the S/MIME certificate of the sender domain with the Certificate Authority.

## S/MIME Decryption Workflow

The following process describes how the email gateway performs S/MIME decryption.

1. Decrypt the session key using the private key of the email gateway's S/MIME certificate
2. Decrypt the message body using the session key.

## How to Verify, Decrypt, or Decrypt and Verify Incoming Messages Using S/MIME

| Steps  | Do This                                                                                                                                                                                                                                                                                                                                                                                                                                                                                                                                                                                                                                                                                                                                                                                                                                                          | More Info                                                                                                                                                                                                                                                                                                               |
|--------|------------------------------------------------------------------------------------------------------------------------------------------------------------------------------------------------------------------------------------------------------------------------------------------------------------------------------------------------------------------------------------------------------------------------------------------------------------------------------------------------------------------------------------------------------------------------------------------------------------------------------------------------------------------------------------------------------------------------------------------------------------------------------------------------------------------------------------------------------------------|-------------------------------------------------------------------------------------------------------------------------------------------------------------------------------------------------------------------------------------------------------------------------------------------------------------------------|
| Step 1 | Understand the S/MIME certificate requirements.                                                                                                                                                                                                                                                                                                                                                                                                                                                                                                                                                                                                                                                                                                                                                                                                                  | See <a href="#">S/MIME Certificate Requirements, on page 569</a> .                                                                                                                                                                                                                                                      |
| Step 2 | Depending on your requirements, do one of the following: <ul style="list-style-type: none"> <li>• For S/MIME decryption, add your organization's S/MIME certificate (that contains the private key required to perform decryption) to the email gateway.</li> <li>• For S/MIME verification, add the public key of the sender's S/MIME certificate required to perform verification to the email gateway.</li> <li>• For S/MIME decryption and verification, add the following to the email gateway:               <ul style="list-style-type: none"> <li>• Your organization's S/MIME certificate (that contains the private key required to perform decryption) to the email gateway.</li> <li>• Certificate Authority of the sender domain.</li> <li>• Public key of the sender's S/MIME certificate required to perform verification.</li> </ul> </li> </ul> | See <ul style="list-style-type: none"> <li>• <a href="#">Setting Up Certificates for Decrypting Messages, on page 565</a></li> <li>• <a href="#">Setting Up Public Keys for Verifying Signed Messages, on page 566</a></li> <li>• <a href="#">Importing a Custom Certificate Authority List, on page 689</a></li> </ul> |
| Step 3 | Configure your mail flow policies to verify, decrypt, or decrypt and verify incoming messages using S/MIME.                                                                                                                                                                                                                                                                                                                                                                                                                                                                                                                                                                                                                                                                                                                                                      | See <a href="#">Enabling S/MIME Decryption and Verification, on page 568</a> .                                                                                                                                                                                                                                          |

| Steps  | Do This                                                                                      | More Info                                                                                         |
|--------|----------------------------------------------------------------------------------------------|---------------------------------------------------------------------------------------------------|
| Step 4 | (Optional) Define the action that the email gateway takes on decrypted or verified messages. | See <a href="#">Configuring an Action for S/MIME Decrypted or Verified Message</a> , on page 568. |



**Note** If you want to perform S/MIME verification, decryption, or decryption and verification using CLI, use the `listenerconfig > hostaccess` command. See the CLI inline help for more details.

## Setting Up Certificates for Decrypting Messages

You must add your organization's S/MIME certificate (that contains the private key required to perform decryption) to the email gateway.

### Before You Begin

- Share the public key of the email gateway's S/MIME certificate with the sender (business or consumer) in one of the following ways:
  - Send the public key using an electronic channels, for example, email.
  - Request the sender to retrieve the public key using key harvesting.

The sender can use this public key to send encrypted messages to your email gateway.



**Note** In a B2C scenario, if your organization's S/MIME certificate is a domain certificate, some email clients (for example, Microsoft Outlook) may not be able to send encrypted messages using the public key of your organization's S/MIME certificate. This is because these email clients do not support encryption using public keys of domain certificates.

- Make sure that the S/MIME certificate that you plan to import meets the requirements described in [S/MIME Certificate Requirements](#), on page 569.

### Procedure

- Step 1** Click **Network > Certificates**.
- Step 2** Click **Add Certificate**.
- Step 3** Choose **Import Certificate**.
- Step 4** Enter the path to the certificate file on your network or local machine.
- Step 5** Enter the passphrase for the file.
- Step 6** Click **Next** to view the certificate's information.
- Step 7** Enter a name for the certificate.
- Step 8** Submit and commit your changes.

**What to do next**

---

**Note** Use the `certconfig` command to add the S/MIME certificates using CLI.

---

## Setting Up Public Keys for Verifying Signed Messages

You must add the public key of the sender's S/MIME certificate to the email gateway for verifying signed messages. Depending on your organizational policies and processes, you can use one of the following methods to add the public key to the email gateway:

- Request the sender to send their public key using an electronic channels, for example, email. You can then add the public key using the web interface or CLI.

For instructions to add the public key, see [Adding a Public Key for S/MIME Encryption, on page 557](#).

- Retrieve the public key using key harvesting. See [Harvesting Public Keys, on page 558](#).

## Adding a Public Key for S/MIME Verification

**Before You Begin**

- Make sure that the public key meets the requirements described in [S/MIME Certificate Requirements, on page 569](#).
- Make sure that the public key is in PEM format.

**Procedure**

- 
- |               |                                               |
|---------------|-----------------------------------------------|
| <b>Step 1</b> | Click <b>Mail Policies &gt; Public Keys</b> . |
| <b>Step 2</b> | Click <b>Add Public Key</b> .                 |
| <b>Step 3</b> | Enter the name of the public key.             |
| <b>Step 4</b> | Enter the public key.                         |
| <b>Step 5</b> | Submit and commit your changes.               |
- 

**What to do next**

---

**Note** Use the `smimeconfig` command to add public keys using CLI.

---

## Harvesting Public Keys for S/MIME Verification

You can configure the email gateway to retrieve (harvest) public key from the incoming S/MIME signed messages and use it to verify signed messages from the owner (business or consumer) of the harvested key.



---

**Note** By default, public keys from expired or self-signed S/MIME certificates are not harvested.

---

1. Enable public key harvesting using the web interface or CLI. See [Enabling Public Key Harvesting, on page 567](#).
2. Request the sender to send a signed message.
3. After the harvesting is complete, add the harvested public key to the email gateway. See [Adding a Harvested Public Key for S/MIME Verification, on page 567](#).

This step is to ensure that the message is verified at the gateway level.

## Enabling Public Key Harvesting

### Procedure

---

- Step 1** Click **Mail Policies > Mail Flow Policies**.
- Step 2** Create a new Mail Flow Policy or modify an existing one.
- Step 3** Scroll down to the **Security Features** section.
- Step 4** Under S/MIME Public Key Harvesting, do the following:
- Enable S/MIME public key harvesting.
  - (Optional) Choose whether to harvest public keys if the verification of the incoming signed messages fail.
  - (Optional) Choose whether to harvest updated public keys.
- Note** If an email gateway receives more than one updated public key from the same domain or message within 48 hours, it sends out a warning alert.
- Step 5** Submit and commit your changes.
- 

### What to do next



---

**Note** The size of the harvested public key repository on the email gateway is 512 MB. If the repository is full used, the email gateway automatically removes unused public keys.

Use the `listenerconfig` command to enable key harvesting using CLI.

---

## Adding a Harvested Public Key for S/MIME Verification

### Procedure

---

- Step 1** Click **Mail Policies > Harvested Public Keys**.
- Step 2** Click on the intended harvested public key and copy the public key.

- Step 3** Add the public key to the email gateway. See [Adding a Public Key for S/MIME Verification, on page 566](#).
- Step 4** Submit and commit your changes.
- 

## Enabling S/MIME Decryption and Verification

### Procedure

---

- Step 1** Click **Mail Policies > Mail Flow Policies**.
- Step 2** Create a new Mail Flow Policy or modify an existing one.
- Step 3** Scroll down to the **Security Features** section.
- Step 4** Under S/MIME Decryption/Verification, do the following:
- Enable S/MIME decryption and verification.
  - Choose whether to retain or remove the digital signature from the messages after S/MIME verification. If you do not want your end users to know about S/MIME gateway verification, select **Remove**.
- For triple wrapped messages, only the inner signature is retained or removed.
- Step 5** Submit and commit your changes.
- 

### What to do next



- Tip** If S/MIME Decryption and Verification is enabled in the Mail Flow Policies, all the S/MIME messages are delivered irrespective of the status of the decryption and verification. If you want to configure an action for handling S/MIME Decrypted or Verified Messages, you can use the message filter rules—smime-gateway-verified and smime-gateway . For more information, see [Configuring an Action for S/MIME Decrypted or Verified Message, on page 568](#).
- 

## Configuring an Action for S/MIME Decrypted or Verified Message

After the email gateway performs S/MIME decryption, verification, or both, you may want to take different actions depending on the results. You can use the message filter rules—smime-gateway-verified and smime-gateway to perform actions on the messages based on the result of decryption, verification, or both. For more information, see [Using Message Filters to Enforce Email Policies, on page 127](#)



- Note** You can also use the content filter conditions—**S/MIME Gateway Message** and **S/MIME Gateway Verified** to perform actions on the messages based on the result of decryption, verification, or both. For more information, see [Content Filters, on page 269](#)
- 

Example: Quarantine S/MIME Messages that failed Verification, Decryption, or Both



The following message filter checks if the message is an S/MIME message and quarantines it if the verification or decryption using S/MIME fails.

```
quarantine_smime_messages:if (smime-gateway-message and not smime-gateway-verified)
{ quarantine("Policy"); }
```

## S/MIME Certificate Requirements

- [Certificate Requirements for Signing, on page 569](#)
- [Certificate Requirements for Encryption, on page 570](#)

### Certificate Requirements for Signing

The S/MIME certificate for signing must contain the following information:

| Common Name                       | The fully qualified domain name.                                                                                                                                                                                                                                                                                                                  |
|-----------------------------------|---------------------------------------------------------------------------------------------------------------------------------------------------------------------------------------------------------------------------------------------------------------------------------------------------------------------------------------------------|
| Organization                      | The exact legal name of the organization.                                                                                                                                                                                                                                                                                                         |
| Organizational Unit               | Section of the organization.                                                                                                                                                                                                                                                                                                                      |
| City (Locality)                   | The city where the organization is legally located.                                                                                                                                                                                                                                                                                               |
| State (Province)                  | The state, county, or region where the organization is legally located.                                                                                                                                                                                                                                                                           |
| Country                           | The two letter ISO abbreviation of the country where the organization is legally located.                                                                                                                                                                                                                                                         |
| Duration before expiration        | The number of days before the certificate expires.                                                                                                                                                                                                                                                                                                |
| Subject Alternative Name(Domains) | Name of the domain from which you plan to send signed messages. Examples include domain.com and *.domain.net . For multiple entries, use a comma-separated list.                                                                                                                                                                                  |
| Subject Alternative Name(Email)   | Email address of the user who is planning to send signed messages, for example, user@somedomain.com . For multiple entries, use a comma-separated list.                                                                                                                                                                                           |
| Private Key Size                  | Size of the private key to generate for the CSR.                                                                                                                                                                                                                                                                                                  |
| Key Usage                         | Key usage is a restriction method that determines what a certificate can be used for. If the key usage extension is specified, the following bits: digitalSignature and nonRepudiation must be set.<br><br>If the key usage extension is not specified, receiving clients must presume that the digitalSignature and nonRepudiation bits are set. |

For detailed information about S/MIME certificates, see RFC 5750: Secure/Multipurpose Internet Mail Extensions (S/MIME) Version 3.2 - Certificate Handling.

## Certificate Requirements for Encryption

The S/MIME certificate for encryption must contain the following information:

| Common Name                       | The fully qualified domain name.                                                                                                                                                                                                                                                          |
|-----------------------------------|-------------------------------------------------------------------------------------------------------------------------------------------------------------------------------------------------------------------------------------------------------------------------------------------|
| Organization                      | The exact legal name of the organization.                                                                                                                                                                                                                                                 |
| Organizational Unit               | Section of the organization.                                                                                                                                                                                                                                                              |
| City (Locality)                   | The city where the organization is legally located.                                                                                                                                                                                                                                       |
| State (Province)                  | The state, county, or region where the organization is legally located.                                                                                                                                                                                                                   |
| Country                           | The two letter ISO abbreviation of the country where the organization is legally located.                                                                                                                                                                                                 |
| Duration before expiration        | The number of days before the certificate expires.                                                                                                                                                                                                                                        |
| Subject Alternative Name(Domains) | Name of the domain to which you plan to send encrypted messages. Examples include domain.com and *.domain.net . For multiple entries, use a comma-separated list.<br><br>If you plan to send encrypted messages to all the users in a domain, the public key should include a SAN Domain. |
| Subject Alternative Name(Email)   | Email address of the user to whom you plan to send encrypted messages, for example, user@somedomain.com . For multiple entries, use a comma-separated list.                                                                                                                               |
| Private Key Size                  | Size of the private key to generate for the CSR.                                                                                                                                                                                                                                          |
| Key Usage                         | Key usage is a restriction method that determines what a certificate can be used for. The key usage extension must be specified and the following bit must be set: keyEncipherment .                                                                                                      |

For detailed information about S/MIME certificates, see RFC 5750: Secure/Multipurpose Internet Mail Extensions (S/MIME) Version 3.2 - Certificate Handling.

## Managing Public Keys

the email gateway requires:

- The public key of the recipient's S/MIME encryption certificate for encrypting the outgoing messages.
- The public key of the sender's S/MIME signing certificate for verifying incoming signed messages.

You can add public keys to your email gateway in one of the following ways:

- If you have the intended public key in PEM format, you can add it using the web interface or CLI. See [Adding a Public Key, on page 571](#).
- If you have an export file that contains the intended public keys, you can copy the export file to the /configuration directory and import it using the web interface or CLI. See [Importing Public Keys from an Existing Export File, on page 571](#).

The email gateway also supports key harvesting (automatically retrieving public keys from incoming signed messages). For more information, see [S/MIME Harvested Public Keys, on page 558](#).

## Adding a Public Key

### Before You Begin

- Make sure that the public key meets the requirements described in [S/MIME Certificate Requirements, on page 569](#).
- Make sure that the public key is in PEM format.

### Procedure

---

- Step 1** Click **Mail Policies** > **Public Keys**.
- Step 2** Click **Add Public Key**.
- Step 3** Enter the name of the public key.
- Step 4** Enter the public key.
- Step 5** Submit and commit your changes.
- 

### What to do next



**Note** Use the `smimeconfig` command to add public keys using CLI.

---

## Importing Public Keys from an Existing Export File

### Before You Begin

Copy the export file to the /configuration directory of the email gateway. For instructions to create an export file, see [Exporting Public Keys, on page 572](#).

### Procedure

---

- Step 1** Click **Mail Policies** > **Public Keys**.
- Step 2** Click **Import Public Keys**.
- Step 3** Select the export file and click **Submit**.

**Note** The import process may take longer if you are importing a file with large number of public keys. Make sure that you adjust the web interface or CLI inactivity timeout accordingly.

- Step 4** Commit your changes.
-

## Exporting Public Keys

All public keys on the email gateway are exported together in a single text file and stored in the /configuration directory.

### Procedure

---

- Step 1** Choose **Mail Policies > Public Keys**.
  - Step 2** Click **Export Public Keys**.
  - Step 3** Enter a name for the file and click **Submit**.
-



## CHAPTER 25

# Remediating Messages in Mailboxes

This chapter contains the following sections:

- [Overview, on page 573](#)
- [Workflow, on page 574](#)
- [Performing Remedial Actions on Messages in Mailboxes , on page 576](#)
- [Configuring Mailbox Remediation on Email Gateway, on page 582](#)
- [Upgrading to AsyncOS 13.0 and Later Releases, on page 592](#)
- [Monitoring Mailbox Remediation Results, on page 592](#)
- [Viewing Mailbox Remediation Details in Message Tracking, on page 592](#)
- [Troubleshooting Mailbox Remediation, on page 592](#)

## Overview

The email gateway provides the capability to remediate the malicious messages that are already delivered to the user mailbox. You can configure your email gateway to remediate the messages in the following ways:

- automatically remediate the messages when the AMP sends the retrospective alert to your email gateway
- manually search and remediate the messages using the Message Tracking filter

A file can turn malicious anytime, even after it has reached user's mailbox. AMP can identify this as new information emerges and push retrospective alerts to your email gateway. You can configure your email gateway to perform auto-remedial actions on the messages in user mailbox when the threat verdict changes. For example, you can configure your email gateway to delete the message from the recipient's mailbox when the verdict of the attachment changes from clean to malicious.

You can also use the Message Tracking page to search and remediate the messages that are delivered to the user mailbox. The Message Tracking page is a unified place to search for all messages delivered to the mailboxes. From the search result, you can choose the messages you want to remediate and apply the action you want to perform on the messages.

The email gateway can perform remedial actions(manually or automatically) on the messages in the following mailbox deployments:

- Microsoft Exchange online – mailbox hosted on Microsoft Office 365
- Microsoft Exchange on-premise – a local Microsoft Exchange server

- Hybrid/Multiple tenant configuration – a combination of mailboxes configured across Microsoft Exchange online and Microsoft Exchange on-premise deployments

## Workflow

### Mailbox Auto Remediation Workflow

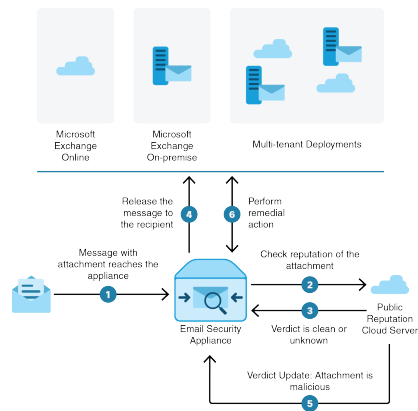

1. Message with an attachment reaches the email gateway.
2. The email gateway queries the public file reputation cloud server to evaluate the reputation of the attachment.
3. The public file reputation cloud server sends the verdict to the email gateway. The verdict is clean or unknown.
4. The email gateway releases the message to the recipient.
5. After a certain period, the email gateway receives a verdict update from the public file reputation cloud server. The new verdict is malicious.
6. The email gateway performs the configured remedial action on the message (with malicious attachment) residing in the recipient's mailbox.

### Search and Remediate Messages Workflow

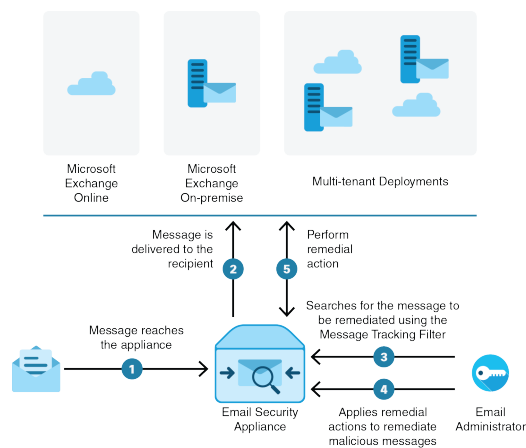

1. Message reaches the email gateway.
2. Message is delivered to the recipient.

3. The administrator searches for the message delivered to the recipient using the Message Tracking filter.
4. The user selects the message to be remediated from the recipient's mailbox and applies the remedial action on the message.
5. The email gateway performs the configured remedial action on the message residing in the recipient's mailbox.

## How the Email Gateway Performs Auto-Remedial Actions

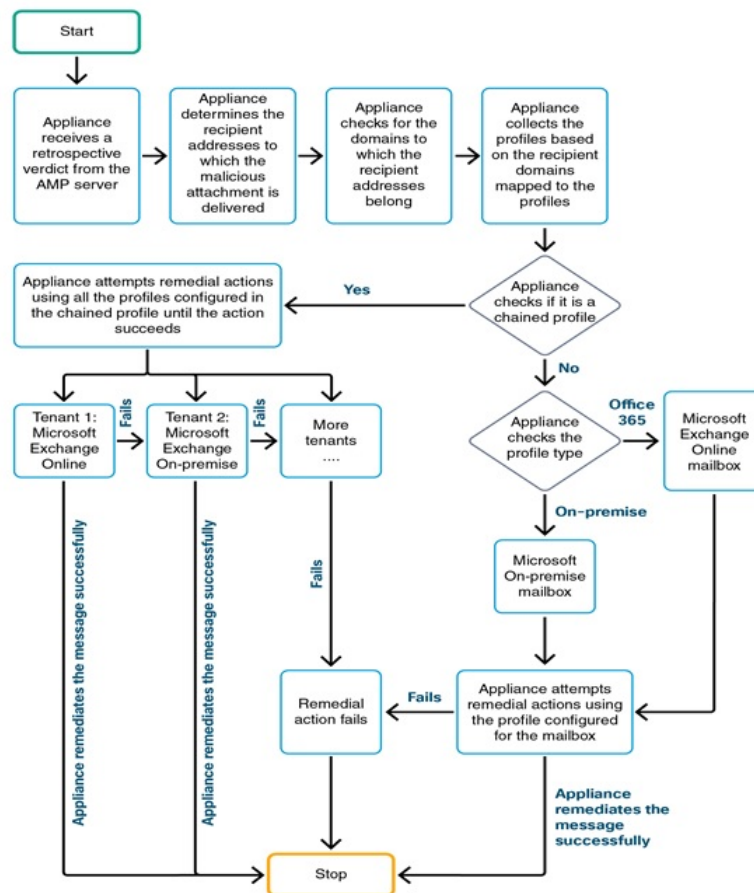

1. [Only to search and remediate messages] The user searches for the messages delivered to the user mailbox using the Message Tracking filter.
2. [Only to search and remediate messages] The user selects the messages to be remediated and applies remedial action on the messages.
3. [Only to automatically remediate messages] When the email gateway receives a retrospective verdict from the public file reputation cloud server, the email gateway initiates the mailbox remediation process.

4. [Only to automatically remediate messages] The email gateway determines the email addresses to which the malicious message was delivered.
5. The appliance identifies the recipient domains to which the email addresses belong.
6. Based on the recipient domains, the email gateway collects the account profile that is mapped to the domains.

An account profile defines the mailbox settings that are used by the appliance to connect to the mailbox and perform the auto-remedial actions. You must create an account profile and map it to the recipient domains to successfully remediate the message from the mailbox.

7. The email gateway checks for the profile mapped to the domains:
  - [Only for hybrid or multi-tenant deployment] If it is a chained profile, the email gateway attempts to perform remedial actions using all the account profiles in the chained profile.

A chained profile is a combination of multiple account profiles. In case of a hybrid or multi-tenant deployment, where there are mailboxes present across multiple deployments, you must create a chained profile to combine all the profiles defined for mailboxes in the deployment. The email gateway attempts to perform remedial actions based on the order in which the account profiles are added in the chained profile.

  - If it is not a chained profile, the email gateway checks the profile type to know if it is an Microsoft Exchange online profile or an Microsoft Exchange on-premise profile.
8. The email gateway performs remedial actions using the identified profile and remediates the message.



---

**Note** Mailbox remediation may fail for various reasons. For more information, see [Troubleshooting Mailbox Remediation, on page 592](#).

---

### Contents

- [Performing Remedial Actions on Messages in Microsoft Exchange Online Mailboxes, on page 577](#)
- [Performing Remedial Actions on Messages in Microsoft Exchange On-Premise Mailboxes, on page 579](#)
- [Performing Remedial Actions on Messages in Mailboxes on Hybrid Deployment, on page 580](#)

## Performing Remedial Actions on Messages in Mailboxes

You can perform remedial actions on messages in the following mailbox deployments:

- Microsoft Exchange Online (Office 365) - [Performing Remedial Actions on Messages in Microsoft Exchange Online Mailboxes, on page 577](#)
- Microsoft Exchange On-Premise - [Performing Remedial Actions on Messages in Microsoft Exchange On-Premise Mailboxes, on page 579](#)
- Hybrid/Multi-tenant Deployment - [Performing Remedial Actions on Messages in Mailboxes on Hybrid Deployment, on page 580](#)



# Performing Remedial Actions on Messages in Microsoft Exchange Online Mailboxes

You can configure your email gateway to perform remediation of messages from user mailbox.

If your organization is using Microsoft Exchange online to manage mailboxes, you can configure your email gateway to perform auto-remedial actions on the messages in user mailbox when the threat verdict changes. For example, you can configure your email gateway to delete the message from the recipient's mailbox when the verdict of the attachment changes from clean to malicious.

You can perform remedial actions manually on messages that are already delivered to the user mailbox. For example, an administrator monitoring the incoming messages can perform remedial actions on messages in the user mailbox using the Message Tracking filter.

## Contents

- [How to Configure Remedial Action on Messages in Microsoft Exchange Online Mailboxes, on page 577](#)

## How to Configure Remedial Action on Messages in Microsoft Exchange Online Mailboxes

|               | Do This                                                                         | More Info                                                                                                                     |
|---------------|---------------------------------------------------------------------------------|-------------------------------------------------------------------------------------------------------------------------------|
| <b>Step 1</b> | Review the prerequisites.                                                       | <a href="#">Prerequisites for Remediating Messages in Microsoft Exchange Online Mailboxes, on page 582</a>                    |
| <b>Step 2</b> | Register email gateway as an application on Azure AD (Azure Management Portal). | <a href="#">Registering Your Email Gateway as an Application on Azure AD, on page 584</a>                                     |
| <b>Step 3</b> | Enable the account settings on your email gateway.                              | Enable mailbox remediation on your email gateway.<br><a href="#">Enabling Account Settings on Email Gateway , on page 586</a> |

|               | Do This                                                                                                                                                                              | More Info                                                                                                                                                                                                                                                                                                                                                                                                                                                                                                                                                                                                                                                                                                                                                                                                                                                                                                                                                                                                                                                                                                                                                                                                                                                      |
|---------------|--------------------------------------------------------------------------------------------------------------------------------------------------------------------------------------|----------------------------------------------------------------------------------------------------------------------------------------------------------------------------------------------------------------------------------------------------------------------------------------------------------------------------------------------------------------------------------------------------------------------------------------------------------------------------------------------------------------------------------------------------------------------------------------------------------------------------------------------------------------------------------------------------------------------------------------------------------------------------------------------------------------------------------------------------------------------------------------------------------------------------------------------------------------------------------------------------------------------------------------------------------------------------------------------------------------------------------------------------------------------------------------------------------------------------------------------------------------|
| <b>Step 4</b> | Create an account profile of type Office 365/Hybrid (Graph API) on your email gateway.                                                                                               | <p>Create an Office 365 profile for the user mailbox and define the mailbox settings on the email gateway.</p> <p>Before you begin, make sure that you have:</p> <ul style="list-style-type: none"> <li>• The values of the following parameters - Client ID and Tenant ID of the application that you registered on the Azure Management Portal. See Step 9 of <a href="#">Registering Your Email Gateway as an Application on Azure AD, on page 584</a>.</li> <li>• For Client Certificate based communication, obtain the values of the following parameters: <ul style="list-style-type: none"> <li>• Private key of the certificate in .pem format. See <a href="#">Certificate for Secure Communication</a></li> <li>• Certificate thumbprint (\$base64Thumbprint). See Step 8 of <a href="#">Registering Your Email Gateway as an Application on Azure AD, on page 584</a>.</li> </ul> </li> <li>• For Client Secret based communication, obtain the value of the generated client secret of the application that you created on the Azure Management Portal. See Step 8 of <a href="#">Registering Your Email Gateway as an Application on Azure AD, on page 584</a>.</li> </ul> <p>See <a href="#">Creating an Account Profile</a> , on page 587.</p> |
| <b>Step 5</b> | Add the recipient domain and map the domain to the Office 365 profile.                                                                                                               | <p>Add the domain that the recipient mailbox belongs and map the domain to the Office 365 account profile.</p> <p>See <a href="#">Mapping Domains to the Account Profile</a> , on page 589.</p>                                                                                                                                                                                                                                                                                                                                                                                                                                                                                                                                                                                                                                                                                                                                                                                                                                                                                                                                                                                                                                                                |
| <b>Step 6</b> | [Only to automatically remediate messages] Configure your email gateway to perform remedial actions on messages delivered to end users when the threat verdict changes to malicious. | <a href="#">Configure Auto-Remedial Actions on Messages in the Mailboxes, on page 590</a>                                                                                                                                                                                                                                                                                                                                                                                                                                                                                                                                                                                                                                                                                                                                                                                                                                                                                                                                                                                                                                                                                                                                                                      |
| <b>Step 7</b> | [Only to search and remediate messages] Configure your email gateway to perform remedial actions manually on messages delivered to end users.                                        | <a href="#">Search and Remediate Messages in the Mailboxes, on page 590</a>                                                                                                                                                                                                                                                                                                                                                                                                                                                                                                                                                                                                                                                                                                                                                                                                                                                                                                                                                                                                                                                                                                                                                                                    |

# Performing Remedial Actions on Messages in Microsoft Exchange On-Premise Mailboxes

You can configure the email gateway to remediate messages from a mailbox on an Exchange on-premise server. The messages can be remediated automatically by the email gateway or manually by the user using the Message Tracking filter.

The email gateway uses a user account with impersonator privileges to access the Exchange on-premise mailbox and perform remedial actions on the message. You must create this user account with impersonator privileges on the mail exchange server to which the email gateway has to connect and remediate the message.



**Note** Cisco has validated Mailbox Auto Remediation only on Microsoft Exchange 2013, 2016, and 2019.

## Contents

- [How to Configure Remedial Actions on Messages in Microsoft Exchange On-Premise Mailboxes](#), on page 579

## How to Configure Remedial Actions on Messages in Microsoft Exchange On-Premise Mailboxes

|               | Do This                                                                        | More Info                                                                                                                                                                                                                                                                                                                                                                  |
|---------------|--------------------------------------------------------------------------------|----------------------------------------------------------------------------------------------------------------------------------------------------------------------------------------------------------------------------------------------------------------------------------------------------------------------------------------------------------------------------|
| <b>Step 1</b> | Review the prerequisites.                                                      | <a href="#">Prerequisites for Remediating Messages in an On-Premise Account</a> , on page 583                                                                                                                                                                                                                                                                              |
| <b>Step 2</b> | Enable the account settings on your email gateway.                             | Enable mailbox remediation on your email gateway.<br><a href="#">Enabling Account Settings on Email Gateway</a> , on page 586                                                                                                                                                                                                                                              |
| <b>Step 3</b> | Create an account profile of type On-Premise on your email gateway.            | Create an On-Premise profile for the user mailbox and define the mailbox settings on your email gateway.<br><br>Before you begin, make sure that you have: <ul style="list-style-type: none"> <li>• The impersonator user account details</li> <li>• The host name of the local mail exchange server</li> </ul> <a href="#">Creating an Account Profile</a> , on page 587. |
| <b>Step 4</b> | Add the recipient domain and map the domain to the On-premise account profile. | Add the domain that the recipient mailbox belongs and map the domain to the On-premise account profile.<br><br>See <a href="#">Mapping Domains to the Account Profile</a> , on page 589.                                                                                                                                                                                   |

|               | Do This                                                                                                                                                                                 | More Info                                                                                 |
|---------------|-----------------------------------------------------------------------------------------------------------------------------------------------------------------------------------------|-------------------------------------------------------------------------------------------|
| <b>Step 5</b> | [Only to automatically remediate messages]<br>Configure your email gateway to perform remedial actions on messages delivered to end users when the threat verdict changes to malicious. | <a href="#">Configure Auto-Remedial Actions on Messages in the Mailboxes, on page 590</a> |
| <b>Step 6</b> | [Only to search and remediate messages]<br>Configure remedial actions on messages in the on premise mailbox.                                                                            | <a href="#">Search and Remediate Messages in the Mailboxes, on page 590</a>               |

## Performing Remedial Actions on Messages in Mailboxes on Hybrid Deployment

You can configure a single email gateway to remediate messages from a hybrid exchange deployment or multiple exchange tenants. For example, if your organization is in a process of moving the mailbox from Microsoft Exchange on-premise to Microsoft Exchange online, there will be mailboxes deployed on Microsoft Exchange online and Microsoft Exchange on-premise until the migration is complete. The messages can be remediated automatically by the email gateway or manually by the user using the Message Tracking filter.

To automatically remediate messages from multiple mailboxes configured across different deployments, create a chained profile. A chained profile combines all the account profiles of a hybrid or multi-tenant deployment. The order in which the profiles are added to the chained profile defines the priority in which the email gateway checks the profile to remediate messages.

When the email gateway receives a retrospective verdict from the AMP server, the appliance attempts to perform the remediation action using each profile present in the chained profile in the order of priority defined in the chained profile.

To manually search and remediate the messages that are delivered to the user mailbox, use the Message Tracking filter. You can use this filter to select the messages you want to remediate, configure the remedial action, and apply the remedial action on the messages.

### Contents

- [How to Perform Remedial Actions on Messages in Mailboxes on Hybrid Deployment, on page 580](#)

## How to Perform Remedial Actions on Messages in Mailboxes on Hybrid Deployment

|               | Do This                                                                         | More Info                                                                                                                                                                                                                                                |
|---------------|---------------------------------------------------------------------------------|----------------------------------------------------------------------------------------------------------------------------------------------------------------------------------------------------------------------------------------------------------|
| <b>Step 1</b> | Review the prerequisites.                                                       | Ensure that all the prerequisites for performing auto-remedial actions on Microsoft Exchange online and Microsoft Exchange on-premise mailboxes are met for a hybrid or multi-tenant deployment.<br><br>See <a href="#">Prerequisites, on page 582</a> . |
| <b>Step 2</b> | Register email gateway as an application on Azure AD (Azure Management Portal). | <a href="#">Registering Your Email Gateway as an Application on Azure AD, on page 584</a>                                                                                                                                                                |

|               | Do This                                                                              | More Info                                                                                                                                                                                                                                                                                                                                                                                                                                                                                                                                                                                                                                                                                                                                                                                                                                                                                                                                                                                                                                                                                                                                                                                                                                                                                                                                                  |
|---------------|--------------------------------------------------------------------------------------|------------------------------------------------------------------------------------------------------------------------------------------------------------------------------------------------------------------------------------------------------------------------------------------------------------------------------------------------------------------------------------------------------------------------------------------------------------------------------------------------------------------------------------------------------------------------------------------------------------------------------------------------------------------------------------------------------------------------------------------------------------------------------------------------------------------------------------------------------------------------------------------------------------------------------------------------------------------------------------------------------------------------------------------------------------------------------------------------------------------------------------------------------------------------------------------------------------------------------------------------------------------------------------------------------------------------------------------------------------|
| <b>Step 3</b> | Enable the account settings on your email gateway.                                   | Enable mailbox remediation on your email gateway.<br><br>See <a href="#">Enabling Account Settings on Email Gateway</a> , on page 586.                                                                                                                                                                                                                                                                                                                                                                                                                                                                                                                                                                                                                                                                                                                                                                                                                                                                                                                                                                                                                                                                                                                                                                                                                     |
| <b>Step 4</b> | Create account profiles for all the mailboxes in the hybrid/multi-tenant deployment. | Create account profiles for the user mailboxes and define mailbox settings on the email gateway.<br><br>Before you begin, make sure that you have: <ul style="list-style-type: none"> <li>• The values of the following parameters - Client ID and Tenant ID of the application that you registered on the Azure Management Portal. See Step 9 of <a href="#">Registering Your Email Gateway as an Application on Azure AD</a>, on page 584.</li> <li>• For Client Certificate based communication, obtain the values of the following parameters: <ul style="list-style-type: none"> <li>• Private key of the certificate in .pem format. See <a href="#">Certificate for Secure Communication</a></li> <li>• Certificate thumbprint (\$base64Thumbprint). See Step 8 of <a href="#">Registering Your Email Gateway as an Application on Azure AD</a>, on page 584.</li> </ul> </li> <li>• For Client Secret based communication, obtain the value of the generated client secret of the application that you created on the Azure Management Portal. See Step 8 of <a href="#">Registering Your Email Gateway as an Application on Azure AD</a>, on page 584.</li> <li>• The impersonator user account details.</li> <li>• The host name of the local mail exchange server.</li> </ul><br>See <a href="#">Creating an Account Profile</a> , on page 587. |
| <b>Step 5</b> | Create a chained profile.                                                            | Create a chained profile and add all the profiles of a hybrid/multi- tenant deployment.<br><br>See <a href="#">Creating a Chained Profile</a> , on page 588.                                                                                                                                                                                                                                                                                                                                                                                                                                                                                                                                                                                                                                                                                                                                                                                                                                                                                                                                                                                                                                                                                                                                                                                               |
| <b>Step 6</b> | Add the recipients' domains and map them to the chained profile.                     | Add the domains that the recipients' mailboxes belong and map the domains to the chained profile.<br><br>See <a href="#">Mapping Domains to the Account Profile</a> , on page 589.                                                                                                                                                                                                                                                                                                                                                                                                                                                                                                                                                                                                                                                                                                                                                                                                                                                                                                                                                                                                                                                                                                                                                                         |

|        | Do This                                                                                                                                                                                 | More Info                                                                                 |
|--------|-----------------------------------------------------------------------------------------------------------------------------------------------------------------------------------------|-------------------------------------------------------------------------------------------|
| Step 7 | [Only to automatically remediate messages]<br>Configure your email gateway to perform remedial actions on messages delivered to end users when the threat verdict changes to malicious. | <a href="#">Configure Auto-Remedial Actions on Messages in the Mailboxes, on page 590</a> |
| Step 8 | [Only to search and remediate messages]<br>Apply the remedial actions on the messages.                                                                                                  | <a href="#">Search and Remediate Messages in the Mailboxes, on page 590</a>               |

## Configuring Mailbox Remediation on Email Gateway

- [Prerequisites, on page 582](#)
- [Registering Your Email Gateway as an Application on Azure AD, on page 584](#)
- [Enabling Account Settings on Email Gateway , on page 586](#)
- [Creating an Account Profile , on page 587](#)
- [Creating a Chained Profile , on page 588](#)
- [Mapping Domains to the Account Profile , on page 589](#)
- [Configure Auto-Remedial Actions on Messages in the Mailboxes, on page 590](#)
- [Search and Remediate Messages in the Mailboxes, on page 590](#)

## Prerequisites

- [Prerequisites for Remediating Messages in Microsoft Exchange Online Mailboxes, on page 582](#)
- [Prerequisites for Remediating Messages in an On-Premise Account, on page 583](#)

## Prerequisites for Remediating Messages in Microsoft Exchange Online Mailboxes

- [Only for Mailbox Auto Remediation] - [Feature Keys for File Reputation Service and the File Analysis Service, on page 582](#)
- [Office 365 Accounts, on page 583](#)
- [Client Secret or Certificate for Secure Communication, on page 583](#)

### Feature Keys for File Reputation Service and the File Analysis Service



---

**Note** The File Reputation Service and the File Analysis Service feature keys are not required for performing Search and Remediate actions on messages in the user mailbox.

---

To configure remedial actions for Mailbox Auto Remediation on messages in the user mailbox, make sure that you have:

- Added the feature keys for the file reputation service and the file analysis service to your email gateway.
- Enabled File Reputation and Analysis feature on your email gateway. See [File Reputation Filtering and File Analysis, on page 477](#).

### Office 365 Accounts

Make sure that you have the following accounts that are required to register your email gateway with Azure AD:

- An Office 365 business account
- An Azure AD subscription associated with your Office 365 business account

For more information, contact your Office 365 administrator.

### Client Secret or Certificate for Secure Communication

To secure the communication between Office 365 services and your email gateway, you must perform any one of the following tasks:

- Generate a Client Secret of the application that you created on the Azure Management Portal.
- Set up a certificate in one of the following ways: create a self-signed certificate or obtain a certificate from a trusted CA.

You must have:

- A public key in .crt or .p12 format. Make sure that the emailAddress is set to the email address of the Office 365 administrator ( <admin\_username>@<domain>.com )
- An associated private key in .pem format, with keysize at least 2048 bit.



---

**Note** Private keys with passphrase are not supported in this release.

---

For more information, see <https://www.cisco.com/c/en/us/support/docs/security/email-security-appliance/211404-How-to-configure-Azure-AD-and-Office-365.html>.

### Prerequisites for Remediating Messages in an On-Premise Account

- [Only for Mailbox Auto Remediation] - [Feature Keys for File Reputation Service and the File Analysis Service, on page 582](#)
- (Optional) [Import Microsoft Exchange Web Service \(EWS\) Certificate, on page 584](#)
- [Add a User to the Impersonator Role, on page 584](#)

## Feature Keys for File Reputation Service and the File Analysis Service



**Note** The File Reputation Service and the File Analysis Service feature keys are not required for performing Search and Remediate actions on messages in the user mailbox.

To configure remedial actions for Mailbox Auto Remediation on messages in the user mailbox, make sure that you have:

- Added the feature keys for the file reputation service and the file analysis service to you email gateway.
- Enabled File Reputation and Analysis feature on your email gateway. See [File Reputation Filtering and File Analysis, on page 477](#).

### (Optional) Import Microsoft Exchange Web Service (EWS) Certificate

If you are using a self-signed certificate on an Microsoft Exchange on-premise server for the EWS service, you must import the certificate from the Microsoft Exchange on-premise server into the email gateway. To import a certificate, see [Importing a Certificate , on page 676](#).

### Add a User to the Impersonator Role

The email gateway uses a user account that has impersonator privileges to access the Microsoft Exchange on-premise mailbox. The mail exchange administrator must create a user account with impersonator privileges on the local exchange server. The email gateway used this user account to remediate messages from the mailbox.

#### Procedure

- 
- Step 1** Create a user account for which impersonator privileges must be assigned. This user account is used by the email gateway to access and operate the mailbox to remediate the messages.
  - Step 2** Log in to the Microsoft Exchange Control Panel interface using administrator credentials.
  - Step 3** Navigate to **Permissions -> Admin Roles**.
  - Step 4** Create a role and assign the 'ApplicationImpersonation' privileges for the role.
  - Step 5** Add the user account for which the impersonator privileges must be assigned as a member of this new role.
- 

## Registering Your Email Gateway as an Application on Azure AD

Office 365 services use Azure Active Directory (Azure AD) to provide secure access to users' mailboxes. For your email gateway to access the Office 365 mailboxes, you must register your email gateway with Azure AD. The following are the high level steps you need to perform to register your email gateway with Azure AD. For detailed instructions, see Microsoft documentation ( <https://docs.microsoft.com/en-us/azure/active-directory/develop/quickstart-register-app> ).

### Before You Begin

Perform the tasks described in [Prerequisites for Remediating Messages in Microsoft Exchange Online Mailboxes, on page 582](#).



## Procedure

---

- Step 1** Sign into the Azure Management Portal using your Office 365 business account credentials.
- Step 2** Add a new application to the directory linked to your Office 365 subscription.
- Step 3** Navigate to **App Registrations > New Registration** to add a new application.
- Step 4** While adding a new application, make sure that you:
- Specify the application name and the account types the application must support.
  - (Optional) Select the application type as Web and provide the URL where users can sign-in and use your email gateway.
- Step 5** Assign the permissions that the application requires. Click **API permissions** on the navigation pane and click **Add a permission**.
- Step 6** Select **Microsoft Graph > Application permissions** and assign the following permissions:
- Mail.Read – Read mail in all mailboxes
  - Mail.ReadWrite - Read and write mail in all mailboxes
  - Mail.Send - Send mail as any user
- Step 7** Grant admin consent for all the requested permissions for all accounts in the organization.
- Step 8** Secure the communication between the Office 365 services and the email gateway by performing any one of the following tasks:
- Generate a Client Secret of the application that you created on the Azure Management Portal.
- Note** Make sure that you copy the client secret value because it is not displayed during a subsequent login to the Azure Management portal.
- Update the application manifest with the key credentials from the public key certificate. Perform the following steps:
- a. Using a Windows PowerShell prompt, get the values for `$base64Thumbprint`, `$base64Value`, and `$keyid` from the public key certificate. See the example below. From the Windows PowerShell prompt, navigate to the directory containing the public key certificate and run the following:

### Example

```
$cer = New-Object System.Security.Cryptography.X509Certificates.X509Certificate2
$cer.Import(".\mycer.cer")
$bin = $cer.GetRawCertData()
$base64Value = [System.Convert]::ToBase64String($bin)
$bin = $cer.GetCertHash()
$base64Thumbprint = [System.Convert]::ToBase64String($bin)
$keyid = [System.Guid]::NewGuid().ToString()
```

After running the above commands, run the following commands to extract their values:

```
$keyid
$base64Value
$base64Thumbprint
```

- b. Click **Manifest** on left pane of the registered application pane to open the manifest of the application.
- c. In the manifest text editor, replace the empty `KeyCredentials` property with the following JSON:

**Example**

```
"keyCredentials": [
  {
    "customKeyIdentifier": "$base64Thumbprint_from_step_1",
    "keyId": "$keyid_from_step1",
    "type": "AsymmetricX509Cert",
    "usage": "Verify",
    "value": "$base64Value_from_step1"
  }
],
```

**Example:**

In the above JSON snippet, make sure that you replace the values of `$base64Thumbprint`, `$base64Value`, and `$keyid` with the values you obtained in step a. Each value must be entered in a single line

**Step 9** After registering your appliance with Azure AD, note down the following details from the Azure Management Portal from the Overview pane of the registered application:

- Client ID
- Tenant ID. The Tenant ID is the unique value that will available on all the URLs listed on this page. For instance, the URLs listed on this page are:
  - <https://login.microsoftonline.com/abcd1234-bcdd-469d-8545-a0662708cbc3/federationmetadata/2007-06/federationmetadata.xml>
  - <https://login.microsoftonline.com/abcd1234-bcdd-469d-8545-a0662708cbc3/wsfed>
  - <https://login.microsoftonline.com/abcd1234-bcdd-469d-8545-a0662708cbc3/saml2>

In this case, the Tenant ID is `abcd1234-bcdd-469d-8545-a0662708cbc3` .

**What to do next**

[Enabling Account Settings on Email Gateway](#) , on page 586

## Enabling Account Settings on Email Gateway

**Before You Begin**

Make sure that you have:

- [Required only for Mailbox Auto Remediation] Enabled File Reputation and Analysis feature on your email gateway. See [File Reputation Filtering and File Analysis](#), on page 477.

**Procedure**

- Step 1** Log in to the email gateway.
- Step 2** Click **System Administration** > **Account Settings**.
- Step 3** Click **Enable**.

- Step 4** Select **Enable Account Settings**.
- Step 5** (Optional) Enter the maximum number of attempts the email gateway makes to connect to the mailbox to remediate the message. The value must be an integer from 1 to 5.
- Step 6** (Optional) Enter the number of seconds the email gateway must wait before the connection times out to the hybrid mail exchange server. The value must be an integer from 15 to 90.
- Step 7** (Optional) Enter the number of seconds the email gateway must wait before the connection times out to the local mail exchange server. The value must be an integer from 15 to 90.
- Step 8** Submit and commit your changes.
- 

### What to do next

[Creating an Account Profile](#) , on page 587

## Creating an Account Profile

An account profile defines the mailbox parameters that are required for the email gateway to connect to the mailbox and perform remedial actions when the threat verdict of the message in the mailbox turns malicious.

Each profile credentials are related to one single tenant. If you want to perform remediation across multiple tenants, then you have to configure one profile for each tenant and chain them together using a chained profile. However, if you are using a load balancer for a multi-tenant deployment, you can still configure a single profile and use the hostname of the load balancer while creating a profile.

### Before You Begin

Make sure that you have:

- Enabled the account settings. See [Enabling Account Settings on Email Gateway](#) , on page 586.
- A valid email address in the Microsoft Exchange online or Microsoft Exchange on-premise server.
- The parameters required to configure the Microsoft Exchange online or Microsoft Exchange on-premise account.

### Procedure

---

- Step 1** Log in to the email gateway.
- Step 2** Click **System Administration > Account Settings**.
- Step 3** Click **Create Account Profile**.
- Step 4** Enter a name and description for the profile.
- Step 5** Select the profile type based on the mailbox deployment:
- **Office 365/Hybrid (Graph API)** – Select this to configure a mailbox deployed on Microsoft Exchange online and enter the following details:
    - Client ID and Tenant ID of the application that you registered on the Azure Management Portal.
    - Select any one of the following methods to validate the client credentials:
      - **Client Secret**: Select this option and enter the Client Secret of the application that you generated on the Azure Management Portal.

- **Client Certificate:** Select this option, enter the Thumbprint of the certificate (value of \$base64Thumbprint ), and click **Choose File** to upload the private key of the certificate in the .pem format.
- **Exchange On-premise** - Select this to configure a mailbox deployed on Microsoft Exchange on-premise and enter the following details:
  - Enter the username and password of the user account with impersonator privileges. For more information, see [Add a User to the Impersonator Role, on page 584](#).
  - Enter the hostname of the Microsoft Exchange on-premise server.
 

**Note** If you are using a load balancer for a multi-tenant deployment, you must configure the hostname of your load balancer.

- Step 6** Verify whether the email gateway can connect to the Microsoft Exchange online or Exchange on-premise server.
- a) Click **Test Connection**.
  - b) Enter an email address. This must be a valid email address in the Microsoft Exchange online or Microsoft Exchange on-premise.
  - c) Click **Test Connection**.  
The status is displayed confirming whether your appli email gatewayance can connect to the mailbox server.
  - d) 4. Click **Done**. For troubleshooting the errors, see [Troubleshooting Mailbox Remediation, on page 592](#).
- Step 7** Submit and commit your changes.

---

#### What to do next

- [Creating a Chained Profile , on page 588](#)
- [Mapping Domains to the Account Profile , on page 589](#)

## Creating a Chained Profile

This task is mandatory only if you want to remediate messages in a mailbox on a hybrid or multi-tenant deployments.

#### Before You Begin

Make sure that you have at least one account profile added on your email gateway:

#### Procedure

---

- Step 1** Log in to the email gateway.
- Step 2** Click **System Administration > Account Settings**.
- Step 3** Click **Create Chained Profile**.
- Step 4** Enter a name and description for the chained profile.

- Step 5** Select the account profile you want to add to the chained profile from the drop-down menu. To add more profiles, click **Add Account Profile**.
- Note**
- You must add the profiles in the order of priority in which you want the email gateway to check the profile for remediating the message.
  - You can create a maximum of five chained profiles at a time on your email gateway.
  - You can add a maximum of 10 account profiles per chained profile.
- Step 6** Submit and commit your changes.
- 

#### What to do next

[Mapping Domains to the Account Profile](#) , on page 589

## Mapping Domains to the Account Profile

You must define the domain to which the recipient's mailbox belongs. The domain is then mapped to the account profile which is used by the email gateway to remediate message in the mailbox.



- Note**
- You can edit the domain mapping to add new domains to the existing domain mapped to the profile.
  - The domain mapping is unique to a profile. Domains mapped to one profile cannot be mapped to another.
- 

#### Before You Begin

Make sure that you have at least one account profile added on your email gateway.

#### Procedure

---

- Step 1** Log in to the email gateway.
- Step 2** Click **System Administration > Account Settings**.
- Step 3** Click **Create Domain Mapping**.
- Step 4** Enter the domain names separated by commas. If you want to map the profile to all the domains, type the string 'ALL'.
- Step 5** Select the profile to be mapped to the domain(s). You can also map a chained profile to the domain(s).
- Step 6** Submit and commit your changes.
- 

#### What to do next

- [Configure Auto-Remedial Actions on Messages in the Mailboxes](#), on page 590
- [Search and Remediate Messages in the Mailboxes](#), on page 590

## Configure Auto-Remedial Actions on Messages in the Mailboxes



**Note** Perform the following steps if you want to configure remedial actions for Mailbox Auto Remediation on messages in the mailboxes.

### Before You Begin

Make sure that you have enabled Mailbox Auto Remediation and configured the account settings on your appliance. See [Enabling Account Settings on Email Gateway](#) , on page 586.

### Procedure

- Step 1** Select **Mail Policies > Incoming Mail Policies**.
- Step 2** Click the link in the **Advanced Malware Protection** column of the mail policy to modify.
- Step 3** Select **Enable Mailbox Auto Remediation**.
- Step 4** Specify the action to be taken on messages delivered to end users when the threat verdict changes to malicious. Depending on your requirements, choose one of the following remedial actions:
  - Forward to an email address. Select this option to forward the message with malicious attachment to a specified user, for example, an email administrator.
  - Delete the message. Select this option to permanently delete the message with malicious attachment from the end user's mailbox.
  - Forward to an email address and delete the message. Select this option to forward the message with malicious attachment to a specified user, for example, an email administrator and permanently delete that message from the end user's mailbox.
- Step 5** Submit and commit your changes.

### What to do next

#### Related Topics

- [Monitoring Mailbox Remediation Results, on page 592](#)
- [Viewing Mailbox Remediation Details in Message Tracking, on page 592](#)
- [Troubleshooting Mailbox Remediation, on page 592](#)

## Search and Remediate Messages in the Mailboxes

### Before You Begin

- Make sure that you have enabled mailbox remediation and configured the account settings on your email gateway. See [Enabling Account Settings on Email Gateway](#) , on page 586.
- Enable Message Tracking on your email gateway. See [Enabling Message Tracking, on page 911](#).
- If you are using the Centralized Message Tracking service, make sure that you have enabled the trailblazer port and AsyncOS API HTTP port on the managed email gateway and the Cisco Secure Email and Web

Manager can access the trailblazer port. If the trailblazer port is disabled, ensure that the Cisco Secure Email and Web Manager can access the AsyncOS API HTTP port on the managed email gateway.



---

**Note** You can perform the following steps only in the new web interface of the email gateway.

---

### Procedure

---

- Step 1** Click the Email Security Appliance is getting a new look. Try it!! link on the legacy web interface. See [Accessing the Web-Based Graphical User Interface \(GUI\), on page 26](#).
- Step 2** Click the **Tracking** tab.
- Step 3** Click the **Messages** tab to narrow your search results. For more information, see [Searching for Email Messages on the New Web Interface, on page 915](#).
- Step 4** Select the messages you want to remediate. You can select a maximum of 1000 messages at a time. You can remediate the messages that are only in the delivered state.
- Step 5** Click **Remediate**.
- Step 6** Enter the following details:
- Enter a batch name for the remediation.
  - Select anyone of the following remediation action:
    - Delete the messages. Select this option to permanently delete the malicious messages from the end user's mailbox.
    - Forward to an email address or multiple email addresses separated by a semicolon(;). Select this option to forward the malicious messages to a specified user, for example, an email administrator.
    - Forward to an email address or multiple email addresses separated by a semicolon(;), and delete the messages. Select this option to forward the malicious messages to a specified user, for example, an email administrator and permanently delete that messages from the end user's mailbox.
- Step 7** Click **Apply**.

---

After you click Apply, you can view the **Remediation Report Status** widget at the bottom-right corner of the Message Tracking page. Use this widget to check the status of the Remediation Report generation. After the Remediation Report generation is complete, click **View Details** on the widget to go to the Remediation Report to view the remediation results.



---

**Note** You can also view Remediation Report directly by navigating to Reports > User Reports> Remediation Report and click the **Mailbox Search And Remediate** tab.

---

### What to do next

#### Related Topics

- [Monitoring Mailbox Remediation Results, on page 592](#)

- [Viewing Mailbox Remediation Details in Message Tracking, on page 592](#)
- [Troubleshooting Mailbox Remediation, on page 592](#)

## Upgrading to AsyncOS 13.0 and Later Releases

The mailbox settings defined in the previous AsyncOS versions are migrated seamlessly during the upgrade. This mailbox is created with the profile name as 'Default' and mapped to 'ALL' domains. This profile can be edited as required after the upgrade. Ensure that your application has access to Microsoft Graph API on Azure Active Directory to remediate messages from Microsoft Exchange online mailboxes. For more information, see [Registering Your Email Gateway as an Application on Azure AD, on page 584](#).

## Monitoring Mailbox Remediation Results

You can view the details of the mailbox remediation results using the Remediation report page. To view the report:

1. Click the **Email Security Appliance is getting a new look. Try it!!** link on the legacy web interface.
2. Click the **Monitoring** tab.
3. Click the **Reports** drop-down menu and select **Remediation Report**.

Use this report to view the following details:

- Total number of messages attempted for remediation using Mailbox Auto Remediation and Mailbox Search and Remediate.
- Number of messages successfully remediated for a configured remedial action.
- Number of messages for which the remediation failed.
- Details about the messages for which the remediation was attempted.

For more information, refer to the section [Remediation Report Page, on page 901](#).

## Viewing Mailbox Remediation Details in Message Tracking

You can view the details of messages remediated using Mailbox Search and Remediate in Message Tracking page. Before you begin the remediation, ensure that the Message Tracking is enabled.



---

**Note** Messages attempted for remediation using Mailbox Auto Remediation are not included in the tracking search results.

---

For more information about the data displayed, see [Message Tracking Details , on page 918](#).

## Troubleshooting Mailbox Remediation

- [Connection Errors, on page 593](#)
- [Viewing Logs, on page 594](#)



- [Alerts, on page 595](#)
- [Configured Remedial Actions Are Not Performed, on page 595](#)

## Connection Errors

### Problem

While trying to check the connection between your email gateway and recipient mailbox on the Account Settings page (**System Administration > Account Settings**), you receive an error message: `Connection Unsuccessful`.

### Solution

Depending on the response from the server, do one of the following:

| Error Message                                                                                | Reason and Solution                                                                                                                                                                                                                                                                                                                                                                                                                                                           |
|----------------------------------------------------------------------------------------------|-------------------------------------------------------------------------------------------------------------------------------------------------------------------------------------------------------------------------------------------------------------------------------------------------------------------------------------------------------------------------------------------------------------------------------------------------------------------------------|
| The SMTP address has no mailbox associated with it                                           | You have entered an email address that is not part of the associated mail domain.<br><br>Enter a valid email address and check the connection again.                                                                                                                                                                                                                                                                                                                          |
| The mailbox cannot be accessed using this profile or the required permissions may be missing | Verify that: <ul style="list-style-type: none"> <li>• You have the required permission to access the user mailbox. The Microsoft Exchange online account can be accessed only using the Microsoft Graph API and the Microsoft Exchange on-premise account using an user account with impersonator privileges.</li> <li>• You have selected the incorrect profile type. Modify the profile details on the Edit Account Profile page and check the connection again.</li> </ul> |
| Access is denied. Check credentials and try again                                            | The Office 365 application configured in Microsoft Azure does not have the required permission to access the Microsoft Exchange online mailbox.                                                                                                                                                                                                                                                                                                                               |
| Application with identifier '<client_id>' was not found in the directory <tenant_id>         | You have entered an invalid Client ID.<br><br>Modify the Client ID on the Account Profile page and check the connection again.                                                                                                                                                                                                                                                                                                                                                |
| No service namespace named '<tenant_id>' was found in the data store.                        | You have entered an invalid Tenant ID.<br><br>Modify the Tenant ID on the Account Profile page and check the connection again.                                                                                                                                                                                                                                                                                                                                                |
| Error validating credentials. Credential validation failed                                   | You have entered an invalid certificate thumbprint.<br><br>Modify the certificate thumbprint on the Account Profile page and check the connection again.                                                                                                                                                                                                                                                                                                                      |

| Error Message                                                                                                                                        | Reason and Solution                                                                                                                                                                                                                                                                                                                                                                                                                                                                                                                                                                                                                                                                                                                                                     |
|------------------------------------------------------------------------------------------------------------------------------------------------------|-------------------------------------------------------------------------------------------------------------------------------------------------------------------------------------------------------------------------------------------------------------------------------------------------------------------------------------------------------------------------------------------------------------------------------------------------------------------------------------------------------------------------------------------------------------------------------------------------------------------------------------------------------------------------------------------------------------------------------------------------------------------------|
| Error validating credentials. Client assertion contains an invalid signature.                                                                        | You have entered an incorrect certificate thumbprint or you have uploaded an invalid or incorrect certificate private key.<br>Verify that: <ul style="list-style-type: none"> <li>You have entered the correct thumbprint.</li> <li>You have uploaded the correct certificate private key.</li> <li>The certificate private key is not expired.</li> <li>The time zone of your email gateway matches the time zone in the certificate private key.</li> </ul>                                                                                                                                                                                                                                                                                                           |
| The requested user <email address> is invalid                                                                                                        | The email address entered does not match with the profile type of the account profile. Enter a valid email address or modify the account profile on the Account Profile page and check the connection again.                                                                                                                                                                                                                                                                                                                                                                                                                                                                                                                                                            |
| Failed to verify exchange server('<host name>') certificate. If self-signed certificate is used on exchange server install its custom CA certificate | <ul style="list-style-type: none"> <li>You have entered an invalid CA or self-signed certificate on the Microsoft Exchange on-premise server. Verify the certificate and check the connection again.</li> </ul> <p><b>Note</b> Ensure that the certificate you are using corresponds to the hostname provided in the profile. For example, if you have provided the IP address of the exchange server in your profile setting and the certificate is based on the hostname, then the connection will fail.</p> <ul style="list-style-type: none"> <li>You have not imported the self-signed certificate from the Microsoft Exchange on-premise server to your email gateway. For more information, see <a href="#">Importing a Certificate</a>, on page 676.</li> </ul> |
| Invalid username or password entered for exchange server ('<email address>')                                                                         | You have entered an invalid user name or password for the impersonator user account that is used to connect to the Microsoft Exchange on-premise mailbox.)                                                                                                                                                                                                                                                                                                                                                                                                                                                                                                                                                                                                              |
| The account does not have permission to impersonate the requested user                                                                               | The user account used to connect to the Microsoft Exchange on-premise mailbox is not a member of the impersonator role (does not have impersonator privileges).                                                                                                                                                                                                                                                                                                                                                                                                                                                                                                                                                                                                         |
| Please check host <hostname> is valid exchange server address.                                                                                       | You have entered an incorrect hostname of the Microsoft Exchange on-premise server. Modify the hostname on the Account Profile page and check the connection again.                                                                                                                                                                                                                                                                                                                                                                                                                                                                                                                                                                                                     |

## Viewing Logs

Mailbox remediation information is posted to the following logs:

- Mail Logs ( mail\_logs ). The time at which the mailbox remediation process started is posted to this log. Information about Mailbox Auto Remediation or Mailbox Search and Remediate action:
  - The time at which the mailbox remediation process started is posted to this log.
  - The remediation status.
  - The reason for the unsuccessful remediation.

- The recipients for whom the remediation was successful and unsuccessful.
  - The source from which the Search and Remediate action is initiated.
  - The user who initiated the Search and Remediate action.
  - The remedial action attempted on the messages.
- Remediation Logs. Information related to remediation status, actions performed, errors and so on are posted to this log.

## Alerts

### **Alert: Connectivity Issues Between Email Gateway and Microsoft Exchange Services Detected**

#### **Problem**

You receive an info-level alert indicating that there are connectivity issues between your email gateway and Microsoft Exchange online or Microsoft Exchange on-premise services and the email gateway is unable to perform the configured remedial action.

#### **Solution**

Do the following:

- Check for network issues that might prevent the communication between your email gateway and Microsoft Exchange online or Microsoft Exchange on-premise services.

Review the network settings of your email gateway. See [Changing Network Settings, on page 1069](#).

- Ensure that your application has access to Microsoft Graph API on Azure Active Directory.
- Ensure that the user account used to access the Exchange on-premise mailbox has impersonator privileges.
- Verify that the parameters configured in the corresponding profiles are valid and test the connection.
- Check for firewall issues. See [Firewall Information, on page 1331](#).
- Check whether the Microsoft Exchange online or Microsoft Exchange on-premise services are operational.

## Configured Remedial Actions Are Not Performed

#### **Problem**

After receiving a retrospective alert from the AMP server, configured remedial actions are not performed on the malicious messages in Exchange online and Exchange on-premise mailboxes.

Or

The user is unable to remediate the messages manually using the Remediate option on the Message Tracking page.

#### **Solution**

Do the following:

- Test the connection between your email gateway and Exchange online and Exchange on-premise services. See [Creating an Account Profile, on page 587](#).
- [Only for Mailbox Auto Remediation] Check whether you have received the following alert: Connectivity Issues Between Email Gateway and Exchange online and Exchange on-premise Services Detected. See [Alerts, on page 595](#).

Configured Remedial Actions Are Not Performed



## CHAPTER 26

# Email Authentication

---

This chapter contains the following sections:

- [Email Authentication Overview, on page 597](#)
- [Configuring DomainKeys and DKIM Signing, on page 599](#)
- [How to Verify Incoming Messages Using DKIM, on page 612](#)
- [Overview of SPF and SIDF Verification, on page 618](#)
- [How to Verify Incoming Messages Using SPF/SIDF, on page 619](#)
- [Enabling SPF and SIDF, on page 620](#)
- [Determining the Action to Take for SPF/SIDF Verified Mail, on page 624](#)
- [Testing the SPF/SIDF Results, on page 627](#)
- [DMARC Verification, on page 628](#)
- [Forged Email Detection, on page 636](#)

## Email Authentication Overview

AsyncOS supports email verification and signing to prevent email forgery. To verify incoming mail, AsyncOS supports Sender Policy Framework (SPF), Sender ID Framework (SIDF), DomainKeys Identified Mail (DKIM), Domain-based Message Authentication, Reporting and Conformance (DMARC), and Forged Email Detection. To authenticate outbound mail, AsyncOS supports DomainKeys and DKIM signing.

### Related Topics

- [DomainKeys and DKIM Authentication, on page 597](#)
- [Overview of SPF and SIDF Verification, on page 618](#)
- [DMARC Verification, on page 628](#)
- [Forged Email Detection, on page 636](#)

## DomainKeys and DKIM Authentication

With DomainKeys or DKIM email authentication, the sender signs the email using public key cryptography. The verified domain can then be used to detect forgeries by comparing it with the domain in the From: (or Sender:) header of the email.

DomainKeys and DKIM consist of two main parts: signing and verification. AsyncOS supports the “signing” half of the process for DomainKeys, and it supports both signing and verification for DKIM. You can also enable bounce and delay messages to use DomainKeys and DKIM signing.

### Related Topics

- [DomainKeys and DKIM Authentication Workflow, on page 598](#)
- [DomainKeys and DKIM Signing in AsyncOS, on page 598](#)

## DomainKeys and DKIM Authentication Workflow

Figure 36: Authentication Work Flow



1. Administrator (domain owner) publishes a public key into the DNS name space.
2. Administrator loads a private key in the outbound Mail Transfer Agent (MTA).
3. Email submitted by an authorized user of that domain is digitally signed with the respective private key. The signature is inserted in the email as a DomainKey or DKIM signature header and the email is transmitted.
4. Receiving MTA extracts the DomainKeys or DKIM signature from the header and the claimed sending domain (via the Sender: or From: header) from the email. The public key is retrieved from the claimed signing domain which is extracted from DomainKeys or DKIM signature header fields.
5. The public key is used to determine whether the DomainKeys or DKIM signature was generated with the appropriate private key.

To test your outgoing DomainKeys signatures, you can use a Yahoo! or Gmail address, as these services are free and provide validation on incoming messages that are DomainKeys signed.

## DomainKeys and DKIM Signing in AsyncOS

DomainKeys and DKIM signing in AsyncOS is implemented via domain profiles and enabled via a mail flow policy (typically, the outgoing “relay” policy). For more information, see the “Configuring the Gateway to Receive Mail” chapter. Signing the message is the last action performed by the email gateway before the message is sent.

Domain profiles associate a domain with domain key information (signing key and related information). As email is sent via a mail flow policy on the email gateway, sender email addresses that match any domain profile are DomainKeys signed with the signing key specified in the domain profile. If you enable both DKIM and DomainKeys signing, the DKIM signature is used. You implement DomainKeys and DKIM profiles via the `domainkeysconfig` CLI command or via the Mail Policies > Domain Profiles and the Mail Policies > Signing Keys pages in the GUI.

DomainKeys and DKIM signing works like this: a domain owner generates two keys — a public key stored in the public DNS (a DNS TXT record associated with that domain) and a private key that is stored on the email gateway is used to sign mail that is sent (mail that originates) from that domain.

As messages are received on a listener used to send messages (outbound), the email gateway checks to see if any domain profiles exist. If there are domain profiles created on the email gateway (and implemented for the mail flow policy), the message is scanned for a valid Sender: or From: address. If both are present, the Sender: header is always used for Domain Keys and DKIM Signing, but the From: header is also required even though it is not used for DKIM signing. When only the Sender: header is present, the DomainKeys or DKIM Signing profiles are not matched. The From: header is only used when:

- There is no Sender: header.
- You select the Use From Header for DKIM Signing option in the DKIM Global Setting page in the web interface.



---

**Note** From AsyncOS 10.0 and later, you can select whether you want to use the From: header for DKIM Signing option in the DKIM Global Settings page of the web interface. It is mainly important to use the From: header with DKIM Signing for proper DMARC verification.

---

If a valid address is not found, the message is not signed and the event is logged in the mail\_logs.



---

**Note** If you create both a DomainKey and DKIM profile (and enable signing on a mail flow policy), AsyncOS signs outgoing messages with both a DomainKeys and DKIM signature.

---

If a valid sending address is found, the sending address is matched against the existing domain profiles. If a match is found, the message is signed. If not, the message is sent without signing. If the message has an existing DomainKeys (a “DomainKey-Signature:” header) the message is only signed if a new sender address has been added after the original signing. If a message has an existing DKIM signature, a new DKIM signature is added to the message.

AsyncOS provides a mechanism for signing email based on domain as well as a way to manage (create new or input existing) signing keys.

The configuration descriptions in this document represent the most common uses for signing and verification. You can also enable DomainKeys and DKIM signing on a mail flow policy for inbound email, or enable DKIM verification on a mail flow policy for outbound email.



---

**Note** When you configure domain profiles and signing keys in a clustered environment, note that the Domain Key Profile settings and Signing Key settings are linked. Therefore, if you copy, move or delete a signing key, the same action is taken on the related profile.

---

## Configuring DomainKeys and DKIM Signing

### Related Topics

- [Signing Keys, on page 600](#)
- [Public Keys, on page 600](#)
- [Domain Profiles, on page 601](#)

- [Enabling Signing for Bounce and Delay Messages, on page 602](#)
- [Enabling Signing for Outgoing Mail, on page 602](#)
- [Configuring DomainKeys/DKIM Signing \(GUI\), on page 603](#)
- [Domain Keys and Logging, on page 612](#)

## Signing Keys

A signing key is the private key stored on the email gateway. When creating a signing key, you specify a key size. Larger key sizes are more secure; however, larger keys also can impact performance. The email gateway supports keys from 512 bits up to 2048 bits. The 768 - 1024 bit key sizes are considered secure and used by most senders today. Keys based on larger key sizes can impact performance and are not supported above 2048 bits. For more information about creating signing keys, see [Creating or Editing a Signing Key, on page 606](#).

If you are entering an existing key, simply paste it into the form. Another way to use existing signing keys is to import the key as a text file. For more information about adding existing signing keys, see [Importing or Entering Existing Signing Keys , on page 607](#).

Once a key is entered, it is available for use in domain profiles, and will appear in the Signing Key drop-down list in the domain profile.

### Related Topics

- [Exporting and Importing Signing Keys, on page 600](#)

## Exporting and Importing Signing Keys

You can export your signing keys to a text file on the email gateway. When you export keys, all of the keys currently existing on the email gateway are put into a text file. For more information about exporting keys, see [Exporting Signing Keys, on page 607](#).

You can import keys that have been exported as well.



---

**Note** Importing keys causes all of the current keys on the email gateway to be replaced.

---

For more information, see [Importing or Entering Existing Signing Keys , on page 607](#).

## Public Keys

Once you have associated a signing key with a domain profile, you can create DNS text record which contains your public key. You do this via the Generate link in the DNS Text Record column in the domain profile listing (or via `domainkeysconfig -> profiles -> dnstxt` in the CLI):

For more information about generating a DNS Text Record, see [Generating a DNS Text Record , on page 609](#).

You can also view the public key via the View link on the Signing Keys page:



Figure 37: View Public Key Link on Signing Keys Page

Signing Keys

| Name    | Key Size (Bits) | Public Key           | Domain Profiles | All<br>Delete            |
|---------|-----------------|----------------------|-----------------|--------------------------|
| TestKey | 768             | <a href="#">View</a> | ExampleProfile  | <input type="checkbox"/> |

## Domain Profiles

A domain profile associates a sender domain with a signing key, along with some other information needed for signing.

- A name for the domain profile.
- A domain name (the domain to be included in the “d=” header).
- A selector (a selector is used to form the query for the public key. In the DNS query type, this value is prepended to the “\_domainkey.” namespace of the sending domain).
- A canonicalization method (the method by which the headers and content are prepared for presentation to the signing algorithm). AsyncOS supports both “simple” and “nofws” for DomainKeys and “relaxed” and “simple” for DKIM.
- A signing key (see [Signing Keys, on page 600](#) for more information).
- A list of headers and the body length to sign (DKIM only).
- A list of tags you want to include in the signature’s header (DKIM only). These tags store the following information:
  - The identity of the user or agent (e.g., a mailing list manager) on whose behalf the message is signed.
  - A comma-separated list of query methods used to retrieve the public key.
  - The timestamp of when the signature was created.
  - The expiration time of the signature, in seconds.
  - A vertical bar-separated (i.e., |) list of header fields present when the message was signed.
- The tags you want to include in the signature (DKIM only).
- A list of Profile Users (addresses allowed to use the domain profile for signing).



**Note** The domain in the addresses specified in the profile users must match the domain specified in the Domain field.

You can search through all of your existing domain profiles for a specific term. See [Searching Domain Profiles, on page 611](#) for more information.

Additionally, you can choose whether to:

- Sign system-generated messages with DKIM signatures
- Use From header for DKIM signing

For instructions, see [Editing DKIM Global Settings, on page 611](#).

**Related Topics**

- [Exporting and Importing Domain Profiles, on page 602](#)

## Exporting and Importing Domain Profiles

You can export your existing domain profiles to a text file on the email gateway. When you export the domain profiles, all of the profiles existing on the email gateway are put into a single text file. See [Exporting Domain Profiles, on page 610](#).

You can import domain profiles that you have previously exported. Importing domain profiles causes all of the current domain profiles on the machine to be replaced. See [Importing Domain Profiles, on page 610](#).

## Enabling Signing for Outgoing Mail

DomainKeys and DKIM signing is enabled on mail flow policies for outbound mail. For more information, see the “Configuring the Gateway to Receive Mail” chapter.

**Procedure**

- 
- Step 1** On the Mail Flow Policies page (from the Mail Policies menu), click on the RELAYED mail flow policy (outgoing).
  - Step 2** From the Security Features section, enable DomainKeys/DKIM Signing by selecting On.
  - Step 3** Submit and commit your changes.
- 

## Enabling Signing for Bounce and Delay Messages

In addition to signing outbound messages, you may want to sign bounce and delay messages. You may want to do this to alert recipients that the bounce and delay messages they receive from your company are legitimate. To enable DomainKeys and DKIM signing for bounce and delay messages, you enable DomainKeys/DKIM signing for the bounce profile associated with the public listener.

**Procedure**

- 
- Step 1** On the bounce profile associated with the public listener where you will send signed outbound messages, go to Hard Bounce and Delay Warning Messages.
  - Step 2** Enable “Use Domain Key Signing for Bounce and Delay Messages”:

**Note** You must have completed all steps listed in [Configuring DomainKeys/DKIM Signing \(GUI\)](#), on page 603 to sign bounced and delay messages.

The From: address in the domain profile must match the address used for the bounce return address. To ensure these addresses match, you can configure a return address for the bounce profile (System Administration > Return Addresses), and then use the same name in the Profile Users list in the domain profile. For example, you would configure a return address of MAILER-DAEMON@example.com for the bounce return address, and add MAILER-DAEMON@example.com as a profile user in the domain profile.

---

## Configuring DomainKeys/DKIM Signing (GUI)

### Procedure

---

- Step 1** Create a new or import an existing private key. For information on creating or importing signing keys, see [Signing Keys](#), on page 600.
  - Step 2** Create a domain profile and associate the key with the domain profile. For information on creating a domain profile, see [Domain Profiles](#), on page 601.
  - Step 3** Create the DNS text record. For information about creating the DNS text record, see [Generating a DNS Text Record](#), on page 609.
  - Step 4** If you have not already done so, enable DomainKeys/DKIM signing on a mail flow policy for outbound mail (see [Enabling Signing for Outgoing Mail](#), on page 602).
  - Step 5** Optionally, enable DomainKeys/DKIM signing for bounced and delay messages. For information about enabling signing for bounce and delay messages, see [Enabling Signing for Bounce and Delay Messages](#), on page 602.
  - Step 6** Send email. Mail sent from a domain that matches a domain profile will be DomainKeys/DKIM signed. In addition, bounce or delay messages will be signed if you configured signing for bounce and delay messages.
- Note** If you create both a DomainKey and DKIM profile (and enable signing on a mail flow policy), AsyncOS signs outgoing messages with both a DomainKeys and DKIM signature.
- 

### What to do next

#### Related Topics

- [Creating Domain Profiles for DomainKeys Signing](#), on page 604
- [Creating a New Domain Profile for DKIM Signing](#), on page 604
- [Creating or Editing a Signing Key](#), on page 606
- [Importing or Entering Existing Signing Keys](#), on page 607
- [Testing Domain Profiles](#), on page 609
- [Editing DKIM Global Settings](#), on page 611

## Creating Domain Profiles for DomainKeys Signing

### Procedure

---

- Step 1** Choose **Mail Policies > Signing Profiles**.
- Step 2** In the **Domain Signing Profiles** section, click **Add Profile**.
- Step 3** Enter a name for the profile.
- Step 4** For the **Domain Key Type**, choose **Domain Keys**.  
Additional options appear on the page.
- Step 5** Enter the domain name.
- Step 6** Enter a selector. Selectors are arbitrary names prepended to the "\_domainkey" namespace, used to help support multiple concurrent public keys per sending domain. A selector value and length must be legal in the DNS namespace and in email headers with the additional provision that they cannot contain a semicolon.
- Step 7** Select the canonicalization (no forwarding whitespaces or simple).
- Step 8** If you have already created a signing key, select a signing key. Otherwise, skip to the next step. You must create (or import) at least one signing key in order to have signing keys to choose from in the list. See [Creating or Editing a Signing Key, on page 606](#).
- Step 9** Enter users (email addresses, hosts, etc.) that will use the domain profile for signing.
- Step 10** Submit and commit your changes.
- Step 11** At this point (if you have not already) you should enable DomainKeys/DKIM signing on an outgoing mail flow policy (see [Enabling Signing for Outgoing Mail, on page 602](#)).
- Note** If you create both a DomainKeys and DKIM profile, AsyncOS performs both DomainKeys and DKIM signing on outgoing mail.
- 

## Creating a New Domain Profile for DKIM Signing

### Procedure

---

- Step 1** Choose **Mail Policies > Signing Profiles**.
- Step 2** In the **Domain Signing Profiles** section, click **Add Profile**.
- Step 3** Enter a name for the profile.
- Step 4** For the **Domain Key Type**, choose **DKIM**.  
Additional options appear on the page.
- Step 5** Enter the domain name.
- Step 6** Enter a selector. Selectors are arbitrary names prepended to the "\_domainkey." namespace, used to help support multiple concurrent public keys per sending domain. A selector value and length must be legal in the DNS namespace and in email headers with the additional provision that they cannot contain a semicolon.
- Step 7** Select the canonicalization for the header. Choose from the following options:

- **Relaxed.** The “relaxed” header canonicalization algorithm performs the following: header names are changed to lowercase, headers are unfolded, linear white spaces are reduced to a single space, leading and trailing spaces are stripped.
- **Simple.** No changes to headers are made.

**Step 8** Select the canonicalization for the body. Choose from the following options:

- **Relaxed.** The “relaxed” header canonicalization algorithm performs the following: empty lines are stripped at the end of the body, white spaces are reduced to a single space within lines, and trailing white spaces are stripped in lines.
- **Simple.** Empty lines at the end of the body are stripped.

**Step 9** If you have already created a signing key, select a signing key. Otherwise, skip to the next step. You must create (or import) at least one signing key in order to have signing keys to choose from in the list. See [Creating or Editing a Signing Key, on page 606](#).

**Step 10** Select the list of headers to sign. You can select from the following headers:

- **All.** AsyncOS signs all the headers present at the time of signature. You may want to sign all headers if you do not expect headers to be added or removed in transit.
- **Standard.** You may want to select the standard headers if you expect that headers may be added or removed in transit. AsyncOS signs only the following standard headers (if the header is not present in the message, the DKIM signature indicates a null value for the header):
  - From
  - Sender, Reply To-
  - Subject
  - Date, Message-ID
  - To, Cc
  - MIME-Version
  - Content-Type, Content-Transfer-Encoding, Content-ID, Content-Description
  - Resent-Date, Resent-From, Resent-Sender, Resent-To, Resent-cc, Resent-Message-ID
  - In-Reply-To, References
  - List-Id, List-Help, List-Unsubscribe, List-Subscribe, List-Post, List-Owner, List-Archive

**Note** When you select “Standard”, you can add additional headers to sign.

**Step 11** Specify how to sign the message body. You can choose to sign the message body, and/or how many bytes to sign. Select one of the following options:

- **Whole Body Implied.** Do not use the “l=” tag to determine body length. The entire message is signed and no changes are allowed.
- **Whole Body Auto-determined.** The entire message body is signed, and appending some additional data to the end of body is allowed during transit.
- **Sign first \_ bytes.** Sign the message body up to the specified number of bytes.

- Step 12** Select the tags you want to include in the message signature's header field. The information stored in these tags are used for message signature verification. Select one or more of the following options:
- **“i” Tag.** The identity of the user or agent (e.g., a mailing list manager) on behalf of which this message is signed. Enter the domain name prepended with the @ symbol, such as the domain @example.com .
  - **“q” Tag.** A colon-separated list of query methods used to retrieve the public key. Currently, the only valid value is dns/txt.
  - **“t” Tag.** A timestamp for when the signature was created.
  - **“x” Tag.** The absolute date and time when the signature expires. Specify an expiration time (in seconds) for the signature. The default is 31536000 seconds.
  - **“z” Tag.** A vertical bar-separated (i.e., | ) list of header fields present when the message was signed. This includes the names of the header fields and their values. For example:

```
z=From:admin@example.com|To:joe@example.com|
Subject:test%20message|Date:Date:August%2026,%202011%205:30:02%20PM%20-0700
```

- Step 13** Enter users (email addresses, hosts, etc.) that will use the domain profile for signing.

**Note** When you create domain profiles, be aware that a hierarchy is used in determining the profile to associate with a particular user. For example, you create a profile for example.com and another profile for joe@example.com. When mail is sent from joe@example.com, the profile for joe@example.com is used. However, when mail is sent from adam@example.com, the profile for example.com is used.

- Step 14** Submit and commit your changes.

- Step 15** At this point (if you have not already) you should enable DomainKeys/DKIM signing on an outgoing mail flow policy (see [Enabling Signing for Outgoing Mail, on page 602](#)).

**Note** If you create both a DomainKeys and DKIM profile, AsyncOS performs both DomainKeys and DKIM signing on outgoing mail.

---

## Creating or Editing a Signing Key

- [Create a New Signing Key, on page 606](#)
- [Edit an Existing Signing Key, on page 607](#)

### Create a New Signing Key

Signing keys are required for domain profiles for DomainKeys and DKIM signing.

#### Procedure

---

- Step 1** Choose **Mail Policies > Signing Keys**.
- Step 2** Click **Add Key**.
- Step 3** Enter a name for the key.
- Step 4** Click **Generate** and select a key size.
- Step 5** Submit and commit your changes.

**Note** If you have not done so already, you may need to edit your domain profile to assign the key.

---

## Edit an Existing Signing Key

### Procedure

---

- Step 1** Choose **Mail Policies > Signing Keys**.
  - Step 2** Click the intended signing key.
  - Step 3** Edit the intended fields as described in [Create a New Signing Key, on page 606](#).
  - Step 4** Submit and commit your changes.
- 

## Exporting Signing Keys

All keys on the email gateway are exported together in a single text file.

### Procedure

---

- Step 1** Choose **Mail Policies > Signing Keys**.
  - Step 2** Click **Export Keys**.
  - Step 3** Enter a name for the file and click **Submit**.
- 

## Importing or Entering Existing Signing Keys

### Related Topics

- [Pasting a Key , on page 607](#)
- [Importing Keys from an Existing Export File , on page 608](#)

## Pasting a Key

### Procedure

---

- Step 1** Choose **Mail Policies > Signing Keys**.
  - Step 2** Click **Add Key**.
  - Step 3** Paste the key into the Paste Key field (must be PEM-formatted and must be RSA keys only).
  - Step 4** Submit and commit your changes.
-

## Importing Keys from an Existing Export File



---

**Note** To obtain a key file, see [Exporting Signing Keys, on page 607](#).

---

### Procedure

---

- Step 1** Choose **Mail Policies > Signing Keys**.
  - Step 2** Click **Import Keys**.
  - Step 3** Select the file that contains the exported signing keys.
  - Step 4** Click **Submit**. You are warned that importing will replace all existing signing keys. All of the keys in the text file are imported.
  - Step 5** Click **Import**.
- 

## Deleting Signing Keys

### Related Topics

- [Removing Selected Signing Keys , on page 608](#)
- [Removing All Signing Keys , on page 608](#)

## Removing Selected Signing Keys

### Procedure

---

- Step 1** Choose **Mail Policies > Signing Keys**.
  - Step 2** Mark the checkbox to the right of each signing key to remove.
  - Step 3** Click **Delete**.
  - Step 4** Confirm the deletion.
- 

## Removing All Signing Keys

### Procedure

---

- Step 1** Choose **Mail Policies > Signing Keys**.
  - Step 2** Click **Clear All Keys** on the Signing Keys page.
  - Step 3** Confirm the deletion.
-



## Generating a DNS Text Record

### Procedure

- 
- Step 1** Choose **Mail Policies > Signing Profiles**.
  - Step 2** In the Domain Signing Profiles section, in the DNS Text Record column, click the **Generate** link for the corresponding domain profile.
  - Step 3** Mark the checkbox for the attributes you wish to include in the DNS text record.
  - Step 4** Click **Generate Again** to re-generate the key with any changes you have made.
  - Step 5** The DNS text record is displayed in the text field at the bottom of the window (where you can now copy it). In some cases, multi-string DNS text records are generated. See [Multi-string DNS Text Records, on page 609](#).
  - Step 6** Click **Done**.
- 

### What to do next

#### Related Topics

- [Multi-string DNS Text Records, on page 609](#)

### Multi-string DNS Text Records

Multi-string DNS text records may be generated if the key size of the signing key used to generate the DNS text records are larger than 1024 bits. This is because not more than 255 characters are allowed in a single string of a DNS text record. The DKIM authentication may fail as some of the DNS servers do not accept or serve multi-string DNS text records.

To avoid this scenario, it is recommended that you use double quotes to break up the multi-string DNS text record into smaller strings not exceeding 255 bytes. The following is an example.

```
s._domainkey.domain.com. IN TXT "v=DKIM1;"
"p=MIIBIjANBgkqhkiG9w0BAQEFAAOCAQ8AMIIBCgKCAQE"
"A4Vbhjq2n/3DbEk6EHdeVXlIXFT7OE181amoZLbvMX+bej"
"CdxcsFV3uS7G8oOJSWBP0z++nTQmy9ZDWfaiopU6k7tzoI"
"+oRDlKkhCQrM4oP2B2F5sTDkYwPY3Pen2jgC2OgbPnbo3o"
"m3c1wMWgSoZxoZUE4ly5kPuK9fTtpeJHNiZAqkFICiev4yrkL"
"R+SmFsJn9MYH5+1chyZ74BVm+16Xq2mptWXEwpiOxWI"
"YHXsZo2zRjedrQ45vmgb8xUx5ioYY9/yBLHudGc+GUKTj1i4"
"mQg48yCD/HVNfsSRXaPinliEkypH9cSnvgvWuIYUQz0dHU;"
```

DKIM implementations reassemble DNS text records broken down this way into the full original single string before processing them.

## Testing Domain Profiles

Once you have created a signing key, associated it with a domain profile, and generated and inserted the DNS text into your authorized DNS, you can test your domain profile.

### Procedure

- 
- Step 1** Choose **Mail Policies > Signing Profiles**.

- Step 2** In the **Domain Signing Profiles** section, in the Test Profile column, click the **Test** link for the domain profile.
- Step 3** A message is displayed at the top of the page, indicating success or failure. If the test fails, a warning message is displayed, including the error text.
- 

## Exporting Domain Profiles

All domain profiles on the email gateway are exported together in a single text file.

### Procedure

---

- Step 1** Choose **Mail Policies > Signing Profiles**.
- Step 2** Click **Export Domain Profiles**.
- Step 3** Enter a name for the file and click **Submit**.
- 

## Importing Domain Profiles

### Procedure

---

- Step 1** Choose **Mail Policies > Signing Profiles**.
- Step 2** Click **Import Domain Profiles**.
- Step 3** Select the file that contains the exported domain profiles.
- Step 4** Click **Submit**. You are warned that importing will replace all existing domain profiles. All of the domain profiles in the text file are imported.
- Step 5** Click **Import**.
- 

## Deleting Domain Profiles

### Related Topics

- [Removing Selected Domain Profiles](#) , on page 610
- [Removing All Domain Profiles](#) , on page 611

## Removing Selected Domain Profiles

### Procedure

---

- Step 1** Choose **Mail Policies > Signing Profiles**.
- Step 2** Mark the checkbox to the right of each domain profile to remove.
- Step 3** Click **Delete**.

**Step 4** Confirm the deletion.

---

## Removing All Domain Profiles

### Procedure

---

**Step 1** Choose **Mail Policies > Signing Profiles**.

**Step 2** Click **Clear All Profiles**.

**Step 3** Confirm the deletion.

---

## Searching Domain Profiles

### Procedure

---

**Step 1** Choose **Mail Policies > Signing Profiles**.

**Step 2** In the Find Domain Profiles section, specify the search term.

**Step 3** Click **Find Profiles**.

**Step 4** The search scans the following fields for each domain profile: email, domain, selector, and signing key name.

**Note** If you do not enter search terms, the search engine returns all domain profiles.

---

## Editing DKIM Global Settings

You can use the DKIM Global Settings to choose whether to:

- Sign system-generated messages with a DKIM signature. The email gateway will sign the following messages:
  - Cisco IronPort Spam Quarantine notifications
  - Content filter-generated notifications
  - Configuration messages
  - Support requests
- Use From header for DKIM signing

### Procedure

---

**Step 1** Choose **Mail Policies > Signing Profiles**.

**Step 2** Under DKIM Global Settings, click **Edit Settings**.

**Step 3** Depending on your requirements, configure the following fields:

- DKIM Signing of System Generated Messages

- Use From header for DKIM Signing

**Note** If you are not using From header for DKIM signing or if a valid From header is missing, Sender header will be used. For DMARC verification of DKIM signed messages, you must use the From header during DKIM signing.

**Step 4** Submit and commit your changes.

## Domain Keys and Logging

Lines such as the following are added to the mail logs upon DomainKeys signing:

```
Tue Aug 28 15:29:30 2007 Info: MID 371 DomainKeys: signing with dk-profile - matches
user123@example.com
Tue Aug 28 15:34:15 2007 Info: MID 373 DomainKeys: cannot sign - no profile matches
user12@example.com
```

Lines such as these are added to the mail logs upon DKIM signing:

```
Tue Aug 28 15:29:54 2007 Info: MID 372 DKIM: signing with dkim-profile - matches
user@example.com
Tue Aug 28 15:34:15 2007 Info: MID 373 DKIM: cannot sign - no profile matches
user2@example.com
```

## How to Verify Incoming Messages Using DKIM

How to Verify Incoming Messages Using DKIM

|        | Do This                                                                                        | More Info                                                                                  |
|--------|------------------------------------------------------------------------------------------------|--------------------------------------------------------------------------------------------|
| Step 1 | Create a profile for verifying messages using DKIM.                                            | <a href="#">Creating a DKIM Verification Profile, on page 614</a>                          |
| Step 2 | (Optional) Create a custom mail flow policy to use for verifying incoming messages using DKIM. | <a href="#">Defining Rules for Incoming Messages Using a Mail Flow Policy, on page 103</a> |
| Step 3 | Configure your mail flow policies to verify incoming messages using DKIM.                      | <a href="#">Configuring DKIM Verification on the Mail Flow Policy, on page 616</a>         |
| Step 4 | Define the action that the email gateway takes on verified messages.                           | <a href="#">Configuring an Action for DKIM Verified Mail, on page 617</a>                  |
| Step 5 | Associate the action with groups of specific senders or recipients.                            | <a href="#">Configuring Mail Policies, on page 261</a>                                     |

### Related Topics

- [DKIM Verification Checks Performed by AsyncOS, on page 613](#)
- [Managing DKIM Verification Profiles, on page 613](#)

- [Configuring DKIM Verification on the Mail Flow Policy, on page 616](#)
- [Configuring an Action for DKIM Verified Mail, on page 617](#)

## DKIM Verification Checks Performed by AsyncOS

When you configure an AsyncOS email gateway for DKIM verification, the following checks are performed:

### Procedure

---

- Step 1** AsyncOS checks for the DKIM-Signature field in incoming mail, the syntax of the signature header, valid tag values, and required tags. If the signature fails any of these checks, AsyncOS returns a *permfail*.
- Step 2** After the signature check is performed, the public key is retrieved from the public DNS record, and the TXT record is validated. If errors are encountered during this process, AsyncOS returns a *permfail*. A *tempfail* occurs if the DNS query for the public key fails to get a response.
- Step 3** After retrieving the public key, AsyncOS checks the hashed values and verifies the signature. If any failures occur during this step, AsyncOS returns a *permfail*.
- Step 4** If the checks all pass, AsyncOS returns a *pass*.

**Note** When the message body is greater than the specified length, AsyncOS returns the following verdict:

```
dkim = pass (partially verified [x bytes])
```

where *X* represents the number of bytes verified.

The final verification result is entered as an *Authentication-Results* header. For example, you might get a header that looks like one of the following:

```
Authentication-Results: example1.com
```

```
header.from=From:user123@example.com; dkim=pass (signature verified)
```

```
Authentication-Results: example1.com
```

```
header.from=From:user123@example.com; dkim=pass (partially verified [1000 bytes])
```

```
Authentication-Results: example1.com
```

```
header.from=From:user123@example.com; dkim=permfail (body hash did not verify)
```

**Note** Current DKIM verification stops at the first valid signature. It is not possible to verify using the last signature encountered. This functionality may be available in a later release.

When the domain has its DNS TXT record in DKIM Test Mode (*t=y*), the email gateway completely skips any DKIM Verifications and Actions.

---

## Managing DKIM Verification Profiles

A DKIM verification profile is a list of parameters that the email gateway's mail flow policies use for verifying DKIM signatures. For example, you can create two verification profiles, one that allows 30 seconds before a query times out and a second that allows only 3 seconds before a query times out. You can assign the second

verification profile to the Throttled mail flow policy to prevent connection starvation in case of a DDoS. A verification profile consists of the following information:

- A name for the verification profile.
- The smallest and largest acceptable public key size. The default key sizes are 512 and 2048, respectively.
- The maximum number of signatures in the message to verify. If a message has more signatures than the maximum amount you defined, the email gateway skips verification of the remaining signatures and continues to process the message. The default is 5 signatures.
- The maximum allowed difference in time (in seconds) between the sender's system time and verifier's. For example, if the message signature expires at 05:00:00 and the verifier's system time is 05:00:30, the message signature is still valid if the allowed difference in time is 60 seconds but it is invalid if the allowed difference is 10 seconds. The default is 60 seconds.
- An option whether to use a body length parameter.
- The SMTP action to take in case of a temporary failure.
- The SMTP action to take in case of a permanent failure.

You can search through all of your existing verification profiles by the profile name.

You can export your DKIM verification profiles as a text file in your email gateway's configure directory. When you export the verification profiles, all of the profiles existing on the email gateway are put into a single text file. See [Exporting DKIM Verification Profiles, on page 615](#) for more information.

You can import DKIM verification profiles that you previously exported. Importing DKIM verification profiles causes all of the current DKIM verification profiles on the machine to be replaced. See [Importing DKIM Verification Profiles, on page 615](#) for more information.

### Related Topics

- [Creating a DKIM Verification Profile, on page 614](#)
- [Exporting DKIM Verification Profiles, on page 615](#)
- [Importing DKIM Verification Profiles, on page 615](#)
- [Deleting DKIM Verification Profiles, on page 615](#)
- [Searching DKIM Verification Profiles, on page 616](#)

## Creating a DKIM Verification Profile

### Procedure

- 
- Step 1** Click **Mail Policies > Verification Profiles**.
  - Step 2** Click **Add Profile**.
  - Step 3** Enter the name of the profile.
  - Step 4** Select the minimum key size you want the email gateway to accept for signing keys.
  - Step 5** Select the maximum key size you want the email gateway to accept for signing keys.
  - Step 6** Select the maximum number of signatures to verify in a single message. The default is five signatures.
  - Step 7** Select the number of seconds before the key query times out. The default is 10 seconds.
  - Step 8** Select maximum allowed difference in time (in seconds) between the sender's system time and verifier's. The default is 60 seconds.
  - Step 9** Select whether to use the body-length parameter in the signature to verify the message.

- Step 10** Select whether the email gateway accepts or rejects the message if there is a temporary failure when verifying its signature. If you want the email gateway to reject the message, you can choose to have it send the default 451 SMTP response code or another SMTP response code and text.
- Step 11** Select whether the email gateway accepts or rejects the message if there is a permanent failure when verifying its signature. If you want the email gateway to reject the message, you can choose to have it send the default 451 SMTP response code or another SMTP response code and text.
- Step 12** Submit your changes.  
The new profile appears in the DKIM Verification Profiles table.
- Step 13** Commit your changes.
- Step 14** At this point you should enable DKIM verification on an incoming mail flow policy and select the verification profile you want to use.
- 

## Exporting DKIM Verification Profiles

All DKIM verification profiles on the email gateway are exported as a single text file and saved in the configuration directory on the email gateway.

### Procedure

---

- Step 1** Choose **Mail Policies > Verification Profiles**.
- Step 2** Click **Export Profiles**.
- Step 3** Enter a name for the file and click **Submit**.
- 

## Importing DKIM Verification Profiles

### Procedure

---

- Step 1** Choose **Mail Policies > Verification Profiles**.
- Step 2** Click **Import Profiles**.
- Step 3** Select the file that contains the DKIM verification profiles.
- Step 4** Click **Submit**. You are warned that importing will replace all existing DKIM verification profiles.
- Step 5** Click **Import**.
- 

## Deleting DKIM Verification Profiles

### Related Topics

- [Removing Selected DKIM Verification Profiles](#) , on page 616
- [Removing All DKIM Verification Profiles](#), on page 616

## Removing Selected DKIM Verification Profiles

### Procedure

---

- Step 1** Choose **Mail Policies > Verification Profiles**.
  - Step 2** Mark the checkbox to the right of each DKIM verification profile you want to delete.
  - Step 3** Click **Delete**.
  - Step 4** Confirm the deletion.
- 

## Removing All DKIM Verification Profiles

### Procedure

---

- Step 1** Choose **Mail Policies > Verification Profiles**.
  - Step 2** Click **Clear All Profiles**.
  - Step 3** Confirm the deletion.
- 

## Searching DKIM Verification Profiles

To search all DKIM verification profiles for a specific term in the profile name:

### Procedure

---

- Step 1** Choose **Mail Policies > Verification Profiles**.
  - Step 2** In the **Search DKIM Verification Profiles** section, specify the search term.
  - Step 3** Click **Find Profiles**.
- The search scans the profile name for each DKIM verification profile.
- If you do not enter search terms, the search engine returns all DKIM verification profiles.
- 

## Configuring DKIM Verification on the Mail Flow Policy

DKIM verification is enabled on mail flow policies for incoming email.

### Procedure

---

- Step 1** Choose **Mail Policies > Mail Flow Policies**.
- Step 2** Click the incoming mail policy for the listener where you want to perform verification.



- Step 3** In the Security Features section of the mail flow policy, enable DKIM Verification by selecting **On**.
- Step 4** Select the DKIM verification profile that you want to use for the policy.
- Step 5** Commit your changes.
- 

#### What to do next

#### Related Topics

- [DKIM Verification and Logging, on page 617](#)

## DKIM Verification and Logging

Lines such as the following are added to the mail logs upon DKIM verification:

```
mail.current:Mon Aug 6 13:35:38 2007 Info: MID 17 DKIM: no signature
mail.current:Mon Aug 6 15:00:37 2007 Info: MID 18 DKIM: verified pass
```

## Configuring an Action for DKIM Verified Mail

When you verify DKIM mail, an *Authentication-Results* header is added to the mail, but the mail is accepted regardless of the authentication result. To configure actions based on these authentication results, you can create a content filter to perform actions on the DKIM-verified mail. For example, if DKIM verification fails, you may want configure the mail to be delivered, bounced, dropped, or sent to a quarantine. To do this, you must configure an action using a content filter.

#### Procedure

---

- Step 1** Choose **Mail Policies > Incoming Content Filters**.
- Step 2** Click **Add Filter**.
- Step 3** In the Conditions section, click **Add Condition**.
- Step 4** Select **DKIM Authentication** from the list of conditions.
- Step 5** Choose a DKIM condition. Select one of the following options:
- **Pass**. The message passed the authentication tests.
  - **Neutral**. Authentication was not performed.
  - **Temperror**. A recoverable error occurred.
  - **Permerror**. An unrecoverable error occurred.
  - **Hardfail**. The authentication tests failed.
  - **None**. The message was not signed.
- Step 6** Select an action to associate with the condition. For example, if the DKIM verification fails, you may want to notify the recipient and bounce the message. Or, if DKIM verification passes, you may want to deliver the message immediately without further processing.
- Step 7** Submit the new content filter.

- Step 8** Enable the content filter on the appropriate incoming mail policy.
- Step 9** Commit your changes.
- 

## Overview of SPF and SIDF Verification

AsyncOS supports Sender Policy Framework (SPF) and Sender ID Framework (SIDF) verification. SPF and SIDF are methods for verifying authenticity of email based on DNS records. SPF and SIDF allow the owner of an Internet domain to use a special format of DNS TXT records to specify which machines are authorized to transmit email for that domain. Compliant mail receivers then use the published SPF records to test the authorization of the sending Mail Transfer Agent's identity during a mail transaction.

When you use SPF/SIDF authentication, the senders publish SPF records specifying which hosts are permitted to use their names, and compliant mail receivers use the published SPF records to test the authorization of the sending Mail Transfer Agent's identity during a mail transaction.



---

**Note** Because SPF checks require parsing and evaluation, AsyncOS performance may be impacted. In addition, be aware that SPF checks increase the load on your DNS infrastructure.

---

When you work with SPF and SIDF, note that SIDF is similar to SPF, but it has some differences. To get a full description of the differences between SIDF and SPF, see RFC 4406. For the purposes of this documentation, the two terms are discussed together except in the cases where only one type of verification applies.



---

**Note** AsyncOS does not support SPF for incoming relays.

---

### Related Topics

- [A Note About Valid SPF Records, on page 618](#)

## A Note About Valid SPF Records

To use SPF and SIDF with an email gateway, publish the SPF record according to the RFCs 4406, 4408, and 7208. Review RFC 4407 for a definition of how the PRA identity is determined. You may also want to refer to the following website to view common mistakes made when creating SPF and SIDF records:

[http://www.openspf.org/FAQ/Common\\_mistakes](http://www.openspf.org/FAQ/Common_mistakes)

### Related Topics

- [Valid SPF Records, on page 619](#)
- [Valid SIDF Records, on page 619](#)
- [Testing Your SPF Records, on page 619](#)

## Valid SPF Records

To pass the SPF HELO check, ensure that you include a “v=spf1 a –all” SPF record for each sending MTA (separate from the domain). If you do not include this record, the HELO check will likely result in a None verdict for the HELO identity. If you notice that SPF senders to your domain return a high number of None verdicts, these senders may not have included a “v=spf1 a –all” SPF record for each sending MTA.

## Valid SIDF Records

To support the SIDF framework, you need to publish both “v=spf1” and “spf2.0” records. For example, your DNS record may look like the following example:

```
example.com. TXT "v=spf1 +mx a:colo.example.com/28 -all"
smtp-out.example.com TXT "v=spf1 a -all"
example.com. TXT "spf2.0/mfrom,pra +mx a:colo.example.com/28 -all"
```

SIDF does not verify the HELO identity, so in this case, you do not need to publish SPF v2.0 records for each sending MTA.



**Note** If you choose not to support SIDF, publish an “spf2.0/pr a ~all” record.

## Testing Your SPF Records

In addition to reviewing the RFCs, it is a good idea to test your SPF records before you implement SPF verification on an email gateway. There are several testing tools available on the openspf.org website:

<http://www.openspf.org/Tools>

You can use the following tool to determine why an email failed an SPF record check:

<http://www.openspf.org/Why>

In addition, you can enable SPF on a test listener and use Cisco’s trace CLI command (or perform trace from the GUI) to view the SPF results. Using trace, you can easily test different sending IPs.

## How to Verify Incoming Messages Using SPF/SIDF

|        | Do This                                                                                            | More Info                                                                                  |
|--------|----------------------------------------------------------------------------------------------------|--------------------------------------------------------------------------------------------|
| Step 1 | (Optional) Create a custom mail flow policy to use for verifying incoming messages using SPF/SIDF. | <a href="#">Defining Rules for Incoming Messages Using a Mail Flow Policy, on page 103</a> |
| Step 2 | Configure your mail flow policies to verify incoming messages using SPF/SIDF.                      | <a href="#">Enabling SPF and SIDF, on page 620</a>                                         |
| Step 3 | Define the action that the email gateway takes on verified messages.                               | <a href="#">Determining the Action to Take for SPF/SIDF Verified Mail, on page 624</a>     |
| Step 4 | Associate the action with groups of specific senders or recipients.                                | <a href="#">Configuring Mail Policies, on page 261</a>                                     |

|        | Do This                                              | More Info                                                 |
|--------|------------------------------------------------------|-----------------------------------------------------------|
| Step 5 | (Optional) Test the results of message verification. | <a href="#">Testing the SPF/SIDF Results, on page 627</a> |



**Caution** Although Cisco strongly endorses email authentication globally, at this point in the industry's adoption, Cisco suggests a cautious disposition for SPF/SIDF authentication failures. Until more organizations gain greater control of their authorized mail sending infrastructure, Cisco urges customers to avoid bouncing emails and instead quarantine emails that fail SPF/SIDF verification.



**Note** The AsyncOS command line interface (CLI) provides more control settings for SPF level than the web interface. Based on the SPF verdict, the email gateway can accept or reject a message, in SMTP conversation, on a per listener basis. You can modify the SPF settings when editing the default settings for a listener's Host Access Table using the listenerconfig command. See the [Enabling SPF and SIDF via the CLI, on page 621](#) for more information on the settings.

## Enabling SPF and SIDF

To use SPF/SIDF, you must enable SPF/SIDF for a mail flow policy on an incoming listener. You can enable SPF/SIDF on the listener from the default mail flow policy, or you can enable it for particular incoming mail flow policies.

### Procedure

- Step 1** Choose **Mail Policies > Mail Flow Policy**.
- Step 2** Click **Default Policy Parameters**.
- Step 3** In the default policy parameters, view the Security Features section.
- Step 4** In the **SPF/SIDF Verification** section, click **On**.
- Step 5** Set the level of conformance (the default is SIDF-compatible). This option allows you to determine which standard of SPF or SIDF verification to use. In addition to SIDF conformance, you can choose SIDF-compatible, which combines SPF and SIDF

SPF/SIDF Conformance Levels

| Conformance Level | Description                                                                                                                                                                                                                          |
|-------------------|--------------------------------------------------------------------------------------------------------------------------------------------------------------------------------------------------------------------------------------|
| SPF               | The SPF/SIDF verification behaves according to RFC4408 and RFC7208.<br>- No purported responsible address (PRA) identity verification takes place.<br><b>NOTE:</b> Select this conformance option to test against the HELO identity. |

| Conformance Level | Description                                                                                                                                                                                                                                                                                                                                                                                                                                                         |
|-------------------|---------------------------------------------------------------------------------------------------------------------------------------------------------------------------------------------------------------------------------------------------------------------------------------------------------------------------------------------------------------------------------------------------------------------------------------------------------------------|
| SIDF              | <p>The SPF/SIDF verification behaves according to RFC4406.</p> <ul style="list-style-type: none"> <li>-The PRA Identity is determined with full conformance to the standard.</li> <li>- SPF v1.0 records are treated as spf2.0/mfrom.pra.</li> <li>- For a nonexistent domain or a malformed identity, a verdict of Fail is returned.</li> </ul>                                                                                                                    |
| SIDF Compatible   | <p>The SPF/SIDF verification behaves according to RFC4406 <i>except for</i> the following differences:</p> <ul style="list-style-type: none"> <li>- SPF v1.0 records are treated as spf2.0/mfrom.</li> <li>- For a nonexistent domain or a malformed identity, a verdict of None is returned.</li> </ul> <p><b>NOTE:</b> This conformance option was introduced at the request of the OpenSPF community (<a href="http://www.openspf.org">www.openspf.org</a>).</p> |

**Note** More settings are available via the CLI. See [Enabling SPF and SIDF via the CLI, on page 621](#) for more information.

**Step 6** If you choose a conformance level of SIDF-compatible, configure whether the verification downgrades a Pass result of the PRA identity to None if there are Resent-Sender: or Resent-From: headers present in the message. You might choose this option for security purposes.

**Step 7** If you choose a conformance level of SPF, configure whether to perform a test against the HELO identity. You might use this option to improve performance by disabling the HELO check. This can be useful because the spf-passed filter rule checks the PRA or the MAIL FROM Identities first. The email gateway only performs the HELO check for the SPF conformance level.

### What to do next

#### Related Topics

- [The Received-SPF Header, on page 623](#)
- [Enabling SPF and SIDF via the CLI, on page 621](#)

## Enabling SPF and SIDF via the CLI

The AsyncOS CLI supports more control settings for each SPF/SIDF conformance level. When configuring the default settings for a listener's Host Access Table, you can choose the listener's SPF/SIDF conformance level and the SMTP actions (ACCEPT or REJECT) that the email gateway performs, based on the SPF/SIDF verification results. You can also define the SMTP response that the email gateway sends when it rejects a message.

Depending on the conformance level, the email gateway performs a check against the HELO identity, MAIL FROM identity, or PRA identity. You can specify whether the email gateway proceeds with the session (ACCEPT) or terminates the session (REJECT) for each of the following SPF/SIDF verification results for each identity check:

- **None.** No verification can be performed due to the lack of information.

- **Neutral.** The domain owner does not assert whether the client is authorized to use the given identity.
- **SoftFail.** The domain owner believes the host is not authorized to use the given identity but is not willing to make a definitive statement.
- **Fail.** The client is not authorized to send mail with the given identity.
- **TempError.** A transient error occurred during verification.
- **PermError.** A permanent error occurred during verification.

The email gateway accepts the message for a Pass result unless you configure the SIDF Compatible conformance level to downgrade a Pass result of the PRA identity to None if there are Resent-Sender: or Resent-From: headers present in the message. The email gateway then takes the SMTP action specified for when the PRA check returns None.

If you choose not to define the SMTP actions for an identity check, the email gateway automatically accepts all verification results, including Fail.

The email gateway terminates the session if the identity verification result matches a REJECT action for any of the enabled identity checks. For example, an administrator configures a listener to accept messages based on all HELO identity check results, including Fail, but also configures it to reject messages for a Fail result from the MAIL FROM identity check. If a message fails the HELO identity check, the session proceeds because the email gateway accepts that result. If the message then fails the MAIL FROM identity check, the listener terminates the session and then returns the SMTP response for the REJECT action.

The SMTP response is a code number and message that the email gateway returns when it rejects a message based on the SPF/SIDF verification result. The TempError result returns a different SMTP response from the other verification results. For TempError, the default response code is 451 and the default message text is #4.4.3 Temporary error occurred during SPF verification. For all other verification results, the default response code is 550 and the default message text is #5.7.1 SPF unauthorized mail is prohibited. You can specify your own response code and message text for TempError and the other verification results.

Optionally, you can configure the email gateway to return a third-party response from the SPF publisher domain if the REJECT action is taken for Neutral, SoftFail, or Fail verification result. By default, the email gateway returns the following response:

```
550-#5.7.1 SPF unauthorized mail is prohibited.
```

```
550-The domain example.com explains:
```

```
550 <Response text from SPF domain publisher>
```

To enable these SPF/SIDF settings, use the `listenerconfig -> edit` subcommand and select a listener. Then use the `hostaccess -> default` subcommand to edit the Host Access Table's default settings.

The following SPF control settings are available for the Host Access Table

SPF Control Settings via the CLI

| Conformance Level | Available SPF Control Settings                                                                                                                                                                                                                                                                                                                                                                                                                                                                                                                                                                                               |
|-------------------|------------------------------------------------------------------------------------------------------------------------------------------------------------------------------------------------------------------------------------------------------------------------------------------------------------------------------------------------------------------------------------------------------------------------------------------------------------------------------------------------------------------------------------------------------------------------------------------------------------------------------|
| SPF Only          | <ul style="list-style-type: none"> <li>• Whether to perform HELO identity check</li> <li>• SMTP actions taken based on the results of the following identity checks:               <ul style="list-style-type: none"> <li>• HELO identity (if enabled)</li> <li>• MAIL FROM Identity</li> </ul> </li> <li>• SMTP response code and text returned for the REJECT action</li> <li>• Verification time out (in seconds)</li> </ul>                                                                                                                                                                                              |
| SIDF Compatible   | <ul style="list-style-type: none"> <li>• Whether to perform a HELO identity check</li> <li>• Whether the verification downgrades a Pass result of the PRA identity to None if the Resent-Sender: or Resent-From: headers are present in the message.</li> <li>• SMTP actions taken based on the results of the following identity checks:               <ul style="list-style-type: none"> <li>• HELO identity (if enabled)</li> <li>• MAIL FROM Identity</li> <li>• PRA Identity</li> </ul> </li> <li>• SMTP response code and text returned for the REJECT action.</li> <li>• Verification timeout (in seconds)</li> </ul> |
| SIDF Strict       | <ul style="list-style-type: none"> <li>• SMTP actions taken based on the results of the following identity checks:               <ul style="list-style-type: none"> <li>• MAIL FROM Identity</li> <li>• PRA Identity</li> </ul> </li> <li>• SMTP response code and text returned in case of SPF REJECT action.</li> <li>• Verification timeout (in seconds)</li> </ul>                                                                                                                                                                                                                                                       |

The email gateway performs the HELO identity check and accepts the None and Neutral verification results and rejects the others. The CLI prompts for the SMTP actions are the same for all identity types. The user does not define the SMTP actions for the MAIL FROM identity. The email gateway automatically accepts all verification results for the identity. The email gateway uses the default reject code and text for all REJECT results.

You can also configure this in the command-line interface using the `listenerconfig` command.

## The Received-SPF Header

When you configure AsyncOS for SPF/SIDF verification, it places an SPF/SIDF verification header ( `Received-SPF` ) in the email. The `Received-SPF` header contains the following information:

- **verification result** - the SPF verification result (see [Verification Results, on page 625](#)).
- **identity** - the identity that SPF verification checked: HELO, MAIL FROM, or PRA.
- **receiver** - the verifying host name (which performs the check).
- **client IP address** - the IP address of the SMTP client.
- **ENVELOPE FROM** - the envelope sender mailbox. (Note that this may be different from the MAIL FROM identity, as the MAIL FROM identity cannot be empty.)
- **x-sender** - the value of the HELO, MAIL FROM, or PRA identity.
- **x-conformance** - the level of conformance (see *Table - SPF/SIDF Conformance Levels*) and whether a downgrade of the PRA check was performed.

The following example shows a header added for a message that passed the SPF/SIDF check:

```
Received-SPF: Pass identity=pra; receiver=box.example.com;
client-ip=1.2.3.4; envelope-from="alice@fooo.com";
x-sender="alice@company.com"; x-conformance=sidf_compatible
```



---

**Note** The `spf-status` and `spf-passed` filter rules use the received-SPF header to determine the status of the SPF/SIDF verification.

---

## Determining the Action to Take for SPF/SIDF Verified Mail

When you receive SPF/SIDF verified mail, you may want to take different actions depending on the results of the SPF/SIDF verification. You can use the following message and content filter rules to determine the status of SPF/SIDF verified mail and perform actions on the messages based on the verification results:

- `spf-status`. This filter rule determines actions based on the SPF/SIDF status. You can enter a different action for each valid SPF/SIDF return value.
- `spf-passed`. This filter rule generalizes the SPF/SIDF results as a Boolean value.



---

**Note** The `spf-passed` filter rule is only available in message filters.

---

You can use the `spf-status` rule when you want to address more granular results, and use the `spf-passed` rule when you want to create a simple Boolean.

### Related Topics

- [Verification Results, on page 625](#)
- [Using the spf-status Filter Rule in the CLI, on page 625](#)
- [spf-status Content Filter Rule in the GUI, on page 626](#)
- [Using the spf-passed Filter Rule, on page 627](#)



## Verification Results

If you use the `spf-status` filter rule, you can check against the SPF/SIDF verification results using the following syntax:

```
if (spf-status == "Pass")
```

If you want a single condition to check against multiple status verdicts, you can use the following syntax:

```
if (spf-status == "PermError, TempError")
```

You can also check the verification results against the HELO, MAIL FROM, and PRA identities using the following syntax:

```
if (spf-status("pra") == "Fail")
```



---

**Note** You can only use the `spf-status` message filter rule to check results against HELO, MAIL FROM, and PRA identities. You cannot use the `spf-status` content filter rule to check against identities. The `spf-status` content filter checks only the PRA identity.

---

You can receive any of the following verification results:

- None - no verification can be performed due to the lack of information.
- Pass - the client is authorized to send mail with the given identity.
- Neutral - the domain owner does not assert whether the client is authorized to use the given identity.
- SoftFail - the domain owner believes the host is not authorized to use the given identity but is not willing to make a definitive statement.
- Fail - the client is not authorized to send mail with the given identity.
- TempError - a transient error occurred during verification.
- PermError - a permanent error occurred during verification.

## Using the spf-status Filter Rule in the CLI

The following example shows the `spf-status` message filter in use:

```
skip-spam-check-for-verified-senders:

if (sendergroup == "TRUSTED" and spf-status == "Pass"){

skip-spamcheck();

}

quarantine-spf-failed-mail:

if (spf-status("pra") == "Fail") {

if (spf-status("mailfrom") == "Fail"){

# completely malicious mail

quarantine("Policy");
```

```

} else {

if(spf-status("mailfrom") == "SoftFail") {

# malicious mail, but tempting

quarantine("Policy");

}

}

} else {

if(spf-status("pra") == "SoftFail"){

if (spf-status("mailfrom") == "Fail"

or spf-status("mailfrom") == "SoftFail"){

# malicious mail, but tempting

quarantine("Policy");

}

}

}

stamp-mail-with-spf-verification-error:

if (spf-status("pra") == "PermError, TempError"

or spf-status("mailfrom") == "PermError, TempError"

or spf-status("helo") == "PermError, TempError"){

# permanent error - stamp message subject

strip-header("Subject");

insert-header("Subject", "[POTENTIAL PHISHING] $Subject");

}

.

```

## spf-status Content Filter Rule in the GUI

You can also enable the spf-status rule from the content filters in the GUI. However, you cannot check results against HELO, MAIL FROM, and PRA identities when using the spf-status content filter rule.

To add the spf-status content filter rule from the GUI, click **Mail Policies > Incoming Content Filters**. Then add the SPF Verification filter rule from the Add Condition dialog box. Specify one or more verification results for the condition.

After you add the SPF Verification condition, specify an action to perform based on the SPF status. For example, if the SPF status is SoftFail, you might quarantine the message.

## Using the spf-passed Filter Rule

The `spf-passed` rule shows the results of SPF verification as a Boolean value. The following example shows an `spf-passed` rule used to quarantine emails that are not marked as `spf-passed`:

```
quarantine-spf-unauthorized-mail:

if (not spf-passed) {

    quarantine("Policy");

}
```



**Note** Unlike the `spf-status` rule, the `spf-passed` rule reduces the SPF/SIDF verification values to a simple Boolean. The following verification results are treated as not passed in the `spf-passed` rule: None, Neutral, Softfail, TempError, PermError, and Fail. To perform actions on messages based on more granular results, use the `spf-status` rule.

## Testing the SPF/SIDF Results

Test the results of SPF/SIDF verification and use these results to determine how to treat SPF/SIDF failures because different organizations implement SPF/SIDF in different ways. Use a combination of content filters, message filters, and the Email Security Monitor - Content Filters report to test the results of the SPF/SIDF verification.

Your degree of dependence on SPF/SIDF verification determines the level of granularity at which you test SPF/SIDF results.

### Related Topics

- [Basic Granularity Test of SPF/SIDF Results, on page 627](#)
- [Greater Granularity Test of SPF/SIDF Results, on page 628](#)

## Basic Granularity Test of SPF/SIDF Results

To get a basic measure of the SPF/SIDF verification results for incoming mail, you can use content filters and the Email Security Monitor - Content Filters page. This test provides a view of the number of messages received for each type of SPF/SIDF verification result.

### Procedure

- Step 1** Enable SPF/SIDF verification for a mail flow policy on an incoming listener, and use a content filter to configure an action to take. For information on enabling SPF/SIDF, see [Enabling SPF and SIDF, on page 620](#).
- Step 2** Create an `spf-status` content filter for each type of SPF/SIDF verification. Use a naming convention to indicate the type of verification. For example, use “SPF-Passed” for messages that pass SPF/SIDF verification, or “SPF-TempErr” for messages that weren’t passed due to a transient error during verification. For information about creating an `spf-status` content filter, see [spf-status Content Filter Rule in the GUI, on page 626](#).

- Step 3** After you have processed a number of SPF/SIDF verified messages, click **Monitor > Content Filters** to see how many messages triggered each of the SPF/SIDF verified content filters.
- 

## Greater Granularity Test of SPF/SIDF Results

For more comprehensive information about SPF/SIDF verification results, only enable SPF/SIDF verification for specific groups of senders, and review the results for those specific senders. Then, create a mail policy for that particular group and enable SPF/SIDF verification on the mail policy. Create content filters and review the Content Filters report as explained in [Basic Granularity Test of SPF/SIDF Results, on page 627](#). If you find that the verification is effective, then you can use SPF/SIDF verification as a basis for deciding whether to drop or bounce emails for this specified group of senders.

### Procedure

---

- Step 1** Create a mail flow policy for SPF/SIDF verification. Enable SPF/SIDF verification for the mail flow policy on an incoming listener. For information about enabling SPF/SIDF, see [Enabling SPF and SIDF, on page 620](#).
- Step 2** Create a sender group for SPF/SIDF verification and use a naming convention to indicate SPF/SIDF verification. For information about creating sender groups, see the “Configuring the Gateway to Receive Mail” chapter.
- Step 3** Create an **spf-status** content filter for each type of SPF/SIDF verification. Use a naming convention to indicate the type of verification. For example, use “SPF-Passed” for messages that pass SPF/SIDF verification, or “SPF-TempErr” for messages that weren’t passed due to a transient error during verification. For information about creating an **spf-status** content filter, see [spf-status Content Filter Rule in the GUI, on page 626](#).
- Step 4** After you process a number of SPF/SIDF-verified messages, click **Monitor > Content Filters** to see how many messages triggered each of the SPF/SIDF-verified content filters.
- 

## DMARC Verification

Domain-based Message Authentication, Reporting and Conformance (DMARC) is a technical specification created to reduce the potential for email-based abuse. DMARC standardizes how email receivers perform email authentication using SPF and DKIM mechanisms. To pass DMARC verification, an email must pass at least one of these authentication mechanisms, and the Authentication Identifiers must comply with RFC 5322.

The email gateway allows you to:

- Verify incoming emails using DMARC.
- Define profiles to override (accept, quarantine, or reject) domain owners’ policies.
- Send feedback reports to domain owners, which helps to strengthen their authentication deployments.
- Send delivery error reports to the domain owners if the DMARC aggregate report size exceeds 10 MB or the size specified in the RUA tag of the DMARC record.

AsyncOS can handle emails that are compliant with the DMARC specification as submitted to Internet Engineering Task Force (IETF) on March 31, 2013. For more information, see <http://tools.ietf.org/html/draft-kucherawy-dmarc-base-02>.



---

**Note** The email gateway will not perform DMARC verification of messages from domains with malformed DMARC records. However, the email gateway can receive and process such messages.

---

#### Related Topics

- [DMARC Verification Workflow, on page 629](#)
- [How to Verify Incoming Messages Using DMARC, on page 629](#)

## DMARC Verification Workflow

The following describes how AsyncOS performs DMARC verification.

1. A listener configured on AsyncOS receives an SMTP connection.
2. AsyncOS performs SPF and DKIM verification on the message.
3. AsyncOS fetches the DMARC record for the sender's domain from the DNS.
  - If no record is found, AsyncOS skips the DMARC verification and continues processing.
  - If the DNS lookup fails, AsyncOS takes action based on the specified DMARC verification profile.
4. Depending on DKIM and SPF verification results, AsyncOS performs DMARC verification on the message.



---

**Note** If DKIM and SPF verification is enabled, DMARC verification reuses the DKIM and SPF verification results.

---

5. Depending on the DMARC verification result and the specified DMARC verification profile, AsyncOS accepts, quarantines, or rejects the message. If the message is not rejected due to DMARC verification failure, AsyncOS continues processing.
6. AsyncOS sends an appropriate SMTP response and continues processing.
7. If sending of aggregate reports is enabled, AsyncOS gathers DMARC verification data and includes it in the daily report sent to the domain owners. For more information about the DMARC aggregate feedback report, see [DMARC Aggregate Reports, on page 635](#).



---

**Note** If the aggregate report size exceeds 10 MB or the size specified in the RUA tag of the DMARC record, AsyncOS sends delivery error reports to the domain owners.

---

## How to Verify Incoming Messages Using DMARC

How to Verify Incoming Messages Using DMARC

|        | Do This                                                                                                                                                                                                     | More Information                                                                                                                                                                                                                                            |
|--------|-------------------------------------------------------------------------------------------------------------------------------------------------------------------------------------------------------------|-------------------------------------------------------------------------------------------------------------------------------------------------------------------------------------------------------------------------------------------------------------|
| Step 1 | Create a new DMARC verification profile or modify the default DMARC verification profile to meet your requirements.                                                                                         | <a href="#">Create a DMARC Verification Profile, on page 631</a><br><a href="#">Edit a DMARC Verification Profile, on page 632</a>                                                                                                                          |
| Step 2 | (Optional) Configure global DMARC settings to meet your requirements.                                                                                                                                       | <a href="#">Configure Global DMARC Settings, on page 633</a>                                                                                                                                                                                                |
| Step 3 | Configure your mail flow policies to verify incoming messages using DMARC.                                                                                                                                  | <a href="#">Configuring DMARC Verification on the Mail Flow Policy, on page 634</a>                                                                                                                                                                         |
| Step 4 | (Optional) Configure a return address for DMARC feedback reports.                                                                                                                                           | <a href="#">Configure a Return Address for DMARC Feedback Reports, on page 634</a>                                                                                                                                                                          |
| Step 5 | (Optional) Review the following: <ul style="list-style-type: none"> <li>• DMARC Verification and Incoming Mail reports</li> <li>• Messages that failed DMARC verification using Message Tracking</li> </ul> | <ul style="list-style-type: none"> <li>• <a href="#">DMARC Verification Page, on page 848</a></li> <li>• <a href="#">Incoming Mail Page, on page 837</a></li> <li>• <a href="#">Searching for Messages on the Legacy Interface , on page 912</a></li> </ul> |

### Related Topics

- [Managing DMARC Verification Profiles, on page 630](#)
- [DMARC Aggregate Reports, on page 635](#)
- [Configure Global DMARC Settings, on page 633](#)
- [Configuring DMARC Verification on the Mail Flow Policy, on page 634](#)
- [Configure a Return Address for DMARC Feedback Reports, on page 634](#)

## Managing DMARC Verification Profiles

A DMARC verification profile is a list of parameters that the mail flow policies of the email gateway use for verifying DMARC. For example, you may want to create a stringent profile that rejects all non-compliant messages from a particular domain and a less stringent profile that quarantines all non-compliant messages from another domain.

A DMARC verification profile consists of the following information:

- A name for the verification profile.
- Message action to take when the policy in the DMARC record is reject.
- Message action to take when the policy in the DMARC record is quarantine.
- Message action in case of a temporary failure.
- Message action in case of a permanent failure.

### Related Topics

- [Create a DMARC Verification Profile, on page 631](#)
- [Edit a DMARC Verification Profile, on page 632](#)
- [Exporting DMARC Verification Profiles, on page 632](#)
- [Importing DMARC Verification Profiles, on page 632](#)

- [Deleting DKIM Verification Profiles, on page 615](#)

## Create a DMARC Verification Profile

Use this procedure to create a new DMARC verification profile.



**Note** By default, AsyncOS provides a default DMARC verification profile. If you do not want to create a new DMARC verification profile, you can use the default DMARC verification profile. The default DMARC verification profile is available on **Mail Policies > DMARC** page. For instructions to edit the default DMARC verification profile, see [Edit a DMARC Verification Profile, on page 632](#).

### Procedure

- 
- Step 1** Choose **Mail Policies > DMARC**.
- Step 2** Click **Add Profile**.
- Step 3** Enter the name of the profile.
- Step 4** Set the message action that AsyncOS takes when the policy in the DMARC record is reject. Choose one of the following:
- **No Action.** AsyncOS does not take any action on the messages that fail DMARC verification.
  - **Quarantine.** AsyncOS quarantines the messages that fail DMARC verification to a specified quarantine.
  - **Reject.** AsyncOS rejects all messages that fail DMARC verification and returns a specified SMTP code and response. The default values are, respectively: 550 and #5.7.1 DMARC unauthenticated mail is prohibited.
- Step 5** Set the message action that AsyncOS takes when the policy in the DMARC record is quarantine. Choose one of the following:
- **No Action.** AsyncOS does not take any action on the messages that fail DMARC verification.
  - **Quarantine.** AsyncOS quarantines the messages that fail DMARC verification to a specified quarantine.
- Step 6** Set the message action that AsyncOS takes on the messages that result in temporary failure during DMARC verification. Choose one of the following:
- **Accept.** AsyncOS accepts messages that result in temporary failure during DMARC verification.
  - **Reject.** AsyncOS rejects messages that result in temporary failure during DMARC verification and returns a specified SMTP code and response. The default values are, respectively: 451 and #4.7.1 Unable to perform DMARC verification.
- Step 7** Set the message action that AsyncOS takes on the messages that result in permanent failure during DMARC verification. Choose one of the following:
- **Accept.** AsyncOS accepts messages that result in permanent failure during DMARC verification.
  - **Reject.** AsyncOS rejects messages that result in permanent failure during DMARC verification, and returns a specified SMTP code and response. The default values are, respectively: 550 and #5.7.1 DMARC verification failed.
- Step 8** Submit and commit your changes.
-

## Edit a DMARC Verification Profile

### Procedure

---

- Step 1** Choose **Mail Policies > DMARC**.
  - Step 2** Click the intended verification profile name.
  - Step 3** Edit the intended fields as described in [Create a DMARC Verification Profile, on page 631](#).
  - Step 4** Submit and commit your changes.
- 

## Exporting DMARC Verification Profiles

You can export all DMARC verification profiles on your email gateway to a single text file in the configuration directory.

### Procedure

---

- Step 1** Choose **Mail Policies > DMARC**.
  - Step 2** Click **Export Profiles**.
  - Step 3** Enter a name for the file.
  - Step 4** Click **Submit**.
- 

## Importing DMARC Verification Profiles

### Procedure

---

- Step 1** Choose **Mail Policies > DMARC**.
  - Step 2** Click **Import Profiles**.
  - Step 3** Choose the file that contains the DMARC verification profiles.
  - Step 4** Click **Submit**. You are warned that importing will replace all existing DMARC verification profiles.
  - Step 5** Click **Import**.
  - Step 6** Commit your changes.
- 

## Deleting DMARC Verification Profiles

### Procedure

---

- Step 1** Choose **Mail Policies > DMARC**.
- Step 2** Select the verification profiles that you want to delete.
- Step 3** Click **Delete**.



**Step 4** Confirm the deletion.

## Configure Global DMARC Settings

### Procedure

**Step 1** Choose **Mail Policies > DMARC**.

**Step 2** Click **Edit Global Settings**.

**Step 3** Make changes to the settings defined in the following table.

#### DMARC Global Settings

| Global Setting                                | Description                                                                                                                                                                                                                                                                                                                                                                     |
|-----------------------------------------------|---------------------------------------------------------------------------------------------------------------------------------------------------------------------------------------------------------------------------------------------------------------------------------------------------------------------------------------------------------------------------------|
| Specific senders bypass address list          | <p>Skip DMARC verification of messages from specific senders. Choose an address list from the drop-down list.</p> <p><b>Note</b> Address lists that are created using full email addresses or domains only can be used to bypass DMARC verification. For more information, see <a href="#">Using a List of Sender Addresses for Incoming Connection Rules</a>, on page 110.</p> |
| Bypass verification for messages with headers | <p>Skip DMARC verification of messages that contain specific headers. For example, use this option to skip DMARC verification of messages from mailing lists and trusted forwarders.</p> <p>Enter a header or multiple headers separated by commas.</p>                                                                                                                         |
| Schedule for report generation                | <p>The time when you want AsyncOS to generate DMARC aggregate reports. For example, you can choose non-peak hours for generating aggregate reports to avoid impact on mail flow.</p>                                                                                                                                                                                            |
| Entity generating reports                     | <p>The entity generating DMARC aggregate reports. This helps the domain owners who receive DMARC aggregate reports to identify the entity that generated the report.</p> <p>Enter a valid domain name.</p>                                                                                                                                                                      |
| Additional contact information for reports    | <p>Additional contact information, for example, details of your organization's customer support, if the domain owners who receive DMARC aggregate reports want to contact the entity that generated the report.</p>                                                                                                                                                             |
| Send copy of all aggregate reports to         | <p>Send a copy of all DMARC aggregate reports to specific users, for example, internal users who perform analysis on the aggregate reports.</p> <p>Enter an email address or multiple addresses separated by commas.</p>                                                                                                                                                        |
| Error Reports                                 | <p>Send delivery error reports to the domain owners if the DMARC aggregate report size exceeds 10 MB or the size specified in the RUA tag of the DMARC record.</p> <p>Check the check box.</p>                                                                                                                                                                                  |

**Step 4** Submit and commit your changes.

---

## Configuring DMARC Verification on the Mail Flow Policy

### Procedure

---

- Step 1** Choose **Mail Policies > Mail Flow Policies**.
- Step 2** Click the incoming mail policy for the listener where you want to perform verification.
- Step 3** In the Security Features section of the mail flow policy, enable DMARC Verification by choosing **On**.
- Step 4** Select the DMARC verification profile that you want to use for the policy.
- Step 5** (Optional) Enable sending of DMARC aggregate feedback reports to email addresses in the RUA tag of DMARC-enabled domains from whom messages are received.
- Aggregate feedback reports are generated daily.
- Step 6** Submit and commit your changes.
- 

### What to do next

#### Related Topics

- [DMARC Verification Logs, on page 634](#)

## DMARC Verification Logs

Log messages are added to the mail logs during the following stages of DMARC verification.

- DMARC verification attempted on a message
- DMARC verification is complete
- DMARC verification details including DKIM and SPF alignment results
- DMARC verification on a message is skipped
- DMARC record is fetched and parsed or DNS failures
- DMARC aggregate report delivery for a domain failed
- Error report generated for a domain
- Error report delivery for a domain succeeded
- Error report delivery for a domain failed

## Configure a Return Address for DMARC Feedback Reports

### Procedure

---

- Step 1** Choose **System Administration > Return Addresses**.
- Step 2** Click **Edit Settings**.
- Step 3** Provide a return address for DMARC aggregate feedback reports.

**Step 4** Submit and commit your changes.

## DMARC Aggregate Reports

DMARC relies on a feedback mechanism to enforce domain owner policies safely and in a scalable manner. This feedback mechanism helps the domain owners to strengthen their authentication deployments.

If you are using AsyncOS to perform DMARC verification and you have enabled sending of aggregate feedback reports in the mail flow policy, AsyncOS generates aggregate feedback reports daily, and sends it to the domain owners. These reports are in XML format and are archived into a GZip file.



**Note** All DMARC aggregate feedback reports that AsyncOS generates are DMARC compliant.

A DMARC aggregate feedback report contains the following sections:

- Metadata of the report sender such as email address and report ID number.
- Details of the published DMARC policy.
- Details of DMARC policy disposition such as source IP address and disposition summary.
- Domain identifiers
- DMARC verification results and authentication summary.

### Related Topics

- [Sample DMARC Aggregate Feedback Report, on page 635](#)

### Sample DMARC Aggregate Feedback Report

```
<?xml version="1.0" encoding="UTF-8" ?>
<feedback>
  <version>1.0</version>
  <report_metadata>
    <org_name>cisco.com</org_name>
    <email>noreply-dmarc-support@cisco.com</email>
    <extra_contact_info>http://cisco.com/dmarc/support</extra_contact_info>
    <report_id>bld925$4ecceab=0694614b826605cd@cisco.com</report_id>
    <date_range>
      <begin>1335571200</begin>
      <end>1335657599</end>
    </date_range>
  </report_metadata>
  <policy_published>
    <domain>example.com</domain>
    <adkim>r</adkim>
    <aspf>r</aspf>
    <p>none</p>
    <sp>none</sp>
    <pct>100</pct>
  </policy_published>
  <record>
    <row>
      <source_ip>1.1.1.1</source_ip>
      <count>2</count>
      <policy_evaluated>
        <disposition>none</disposition>
      </policy_evaluated>
    </row>
  </record>
</feedback>
```

```

        <dkim>fail</dkim>
        <spf>pass</spf>
    </policy_evaluated>
</row>
<identifiers>
<envelope_from>example.com</envelope_from>
    <header_from>example.com</header_from>
</identifiers>
<auth_results>
    <dkim>
        <domain>example.com</domain>
        <selector>ny</selector>
        <result>fail</result>
    </dkim>
    <dkim>
        <domain>example.net</domain>
    <selector></selector>
        <result>pass</result>
    </dkim>
    <spf>
        <domain>example.com</domain>
    <scope>mfrom</scope>
        <result>pass</result>
    </spf>
</auth_results>
</record>
</feedback>

```

## Forged Email Detection

Email forging (also known as spoofing, CEO fraud, or business email compromise) is the process of altering the message header to hide the real identity of the sender and to make it look like a legitimate message from someone you know. Assume that a fraudster impersonating as an executive of an organization, is sending a forged message to an employee asking to send a list of clients and their personally identifiable information (PII). The employee, unaware of the real identity of the sender, provides a list of clients and their PII. The fraudster uses the PII to perform identity theft.

The email gateway can detect fraudulent messages with forged sender address (From: header) and perform specified actions on such messages. For example, your email gateway can detect messages with forged sender address and replace the From: header with the Envelope Sender. In this case, the employee will see the email address of the real sender (fraudster's) instead of the forged email address.

### Related Topics

- [Setting Up Forged Email Detection, on page 636](#)
- [Monitoring Forged Email Detection Results, on page 637](#)
- [Displaying Forged Email Detection Details in Message Tracking, on page 638](#)

## Setting Up Forged Email Detection

1. Identify the users in your organization (for example, executives) whose messages are likely to be forged. Create a new content dictionary and add the names of the identified users to it.

While creating a content dictionary,

- Enter the name of the user and not the email address. For example, enter “ Olivia Smith ” instead of “ olivia.smith@example.com .”
- Do not configure Advanced Matching and Smart Identifiers.
- Do not choose weight for the terms used.
- Do not use regular expressions.

The following figure shows a sample content dictionary created for Forged Email Detection.

**Figure 38: Content Dictionary for Forged Email Detection**

Dictionary Properties	
Name:	FED
Advanced Matching:	<input type="checkbox"/> Match whole words <input type="checkbox"/> Case Sensitive
Smart Identifiers: ?	Match specific patterns such as social security numbers and credit card numbers.

Dictionary		Number of terms: 6	
Add Terms:	Term	Weight	Delete
	Matthew Johnson	1	
	Kristine Hansen	1	
	Olivia Smith	1	
	Allen Williams	1	
	John Simons	1	
	Viola Hatton	1	

For instructions to configure a content dictionary, see [Adding Dictionaries, on page 643](#).

2. Create an incoming content or message filter to detect forged messages and the actions that the email gateway must take on such messages. Use the following:
  - **Condition/Rule:** Forged Email Detection (See [Content Filter Conditions, on page 270](#) and [Message Filter Rules, on page 128](#))



**Note** If you want to skip the Forged email detection filter for messages from specific senders, choose the address list from the **Exception List** drop-down list. You can choose only the address lists that are created using the full email addresses. For more information on adding exception address list, refer to [Using a List of Sender Addresses for Incoming Connection Rules, on page 110](#).

- **Action:** Forged Email Detection or any other actions based on your requirement. (See [Content Filter Conditions, on page 270](#) and [Message Filter Rules, on page 128](#))
3. Add the newly created content filter to an incoming mail policy. See [How to Enforce Mail Policies on a Per-User Basis, on page 256](#).

## Monitoring Forged Email Detection Results

To view data about forged messages detected, see the Forged Email Matches report page (**Monitor > Forged Email Matches**). This report page includes the following reports:

- **Top Forged Email Matches.** Displays the top ten users in the content dictionary that matched the forged From: header in the incoming messages.
- **Forged Email Matches: Details.** Displays a list of all the users in the content dictionary that matched the forged From: header in the incoming messages and for a given user, the number of messages matched. Click on the number to view a list of messages in Message Tracking.

## Displaying Forged Email Detection Details in Message Tracking

To display details of forged messages detected by the email gateway in Message Tracking, make sure that:

- Message Tracking is enabled. See [Tracking Messages, on page 911](#).
- Content or message filters for detecting forged messages are operational.



## CHAPTER 27

# Text Resources

---

This chapter contains the following sections:

- [Overview of Text Resources, on page 639](#)
- [Content Dictionaries, on page 640](#)
- [Using and Testing the Content Dictionaries Filter Rules, on page 645](#)
- [Understanding Text Resources, on page 647](#)
- [Overview of Text Resource Management, on page 648](#)
- [Using Text Resources, on page 651](#)

## Overview of Text Resources

This chapter discusses creating and managing various text resources, such as content dictionaries, disclaimers, and templates.

### Related Topics

- [Content Dictionaries, on page 639](#)
- [Text Resources, on page 640](#)
- [Message Disclaimer Stamping, on page 640](#)
- [Using Custom Dictionaries of Sensitive DLP Terms \(Custom DLP Policies Only\) , on page 518](#)

## Content Dictionaries

Content dictionaries are groups of words or entries that work in conjunction with the Body Scanning feature on the email gateway and are available to both content and message filters. Use the dictionaries you define to scan messages, message headers, and message attachments for terms included in the dictionary in order to take appropriate action in accordance with your corporate policies. For example, you could create a list of confidential or profane words, and, using a filter rule to scan messages that contain words in the list, drop, archive, or quarantine the message.

The AsyncOS operating system includes the ability to define a total of 100 content dictionaries using the GUI (Mail Policies > Dictionaries) or the CLI's **dictionaryconfig** command. You can create, delete, and view dictionaries; add and delete entries from a dictionary; and import and export entire dictionaries.

You can use content dictionaries to scan messages against message or content filters in order to take appropriate action in accordance with your corporate policies. You can create, delete, and view dictionaries; add and

delete entries from a dictionary; and import and export entire dictionaries. You can also determine case sensitivity and word boundary detection for each dictionary. For example, you could create a list of confidential or profane words, and, using a filter rule to scan messages for words in the list, drop or archive messages containing matching words. And you can add a “weight” terms in a dictionary so that certain terms trigger a filter action more easily.

Dictionaries can contain non-ASCII characters.

Note that, for efficient processing, the following content dictionary entries are treated as words:

- Entries containing only alphanumeric characters
- Email addresses containing the following characters: 0-9, A-Z, a-z, dot, underscore, hyphen, and at symbol
- Domain names containing the following characters: 0-9, A-Z, a-z, dot, underscore, hyphen, and at symbol

If you want the email gateway to treat such a word as a regular expression, enclose the word in parenthesis, for example, (user@example.com) .

### Related Topics

- [Dictionary Content, on page 641](#)
- [Importing and Exporting Dictionaries as Text Files, on page 642](#)
- [Adding Dictionaries, on page 643](#)
- [Deleting Dictionaries, on page 644](#)
- [Importing Dictionaries, on page 644](#)
- [Exporting Dictionaries, on page 645](#)

## Text Resources

Text resources are text objects, such as disclaimers, notification templates, and anti-virus templates. You can create new objects for use in various components of AsyncOS. You can import and export text resources.

## Message Disclaimer Stamping

Message disclaimer stamping allows you to add a disclaimer text resource to messages. For example, you could append a copyright statement, promotional message, or disclaimer to every message sent from within your enterprise.

## Content Dictionaries

Content dictionaries are groups of words or entries that work in conjunction with the Body Scanning feature on the email gateway and are available to both content and message filters. Use the dictionaries you define to scan messages, message headers, and message attachments for terms included in the dictionary in order to take appropriate action in accordance with your corporate policies. For example, you could create a list of confidential or profane words, and, using a filter rule to scan messages that contain words in the list, drop, archive, or quarantine the message.

The AsyncOS operating system includes the ability to define a total of 100 content dictionaries using the GUI (Mail Policies > Dictionaries) or the CLI's **dictionaryconfig** command. You can create, delete, and view dictionaries; add and delete entries from a dictionary; and import and export entire dictionaries.



You can use content dictionaries to scan messages against message or content filters in order to take appropriate action in accordance with your corporate policies. You can create, delete, and view dictionaries; add and delete entries from a dictionary; and import and export entire dictionaries. You can also determine case sensitivity and word boundary detection for each dictionary. For example, you could create a list of confidential or profane words, and, using a filter rule to scan messages for words in the list, drop or archive messages containing matching words. And you can add a “weight” terms in a dictionary so that certain terms trigger a filter action more easily.

Dictionaries can contain non-ASCII characters.

Note that, for efficient processing, the following content dictionary entries are treated as words:

- Entries containing only alphanumeric characters
- Email addresses containing the following characters: 0-9, A-Z, a-z, dot, underscore, hyphen, and at symbol
- Domain names containing the following characters: 0-9, A-Z, a-z, dot, underscore, hyphen, and at symbol

If you want the email gateway to treat such a word as a regular expression, enclose the word in parenthesis, for example, (user@example.com) .

### Related Topics

- [Dictionary Content, on page 641](#)
- [Importing and Exporting Dictionaries as Text Files, on page 642](#)
- [Adding Dictionaries, on page 643](#)
- [Deleting Dictionaries, on page 644](#)
- [Importing Dictionaries, on page 644](#)
- [Exporting Dictionaries, on page 645](#)

## Dictionary Content

Words in dictionaries are created with one text string per line, and entries can be in plain text or in the form of regular expressions. Dictionaries can also contain non-ASCII characters. Defining dictionaries of regular expressions can provide more flexibility in matching terms, but doing so requires you to understand how to delimit words properly. For a more detailed discussion of Python style regular expressions, consult the Python Regular Expression HOWTO, accessible from

<http://www.python.org/doc/howto/>



---

**Note** To use the special character # at the beginning of a dictionary entry, you can use a character class [#] to prevent it being treated as a comment.

---

For each term, you specify a “weight,” so that certain terms can trigger filter conditions more easily. When AsyncOS scans messages for the content dictionary terms, it “scores” the message by multiplying the number of term instances by the weight of term. Two instances of a term with a weight of three would result in a score of six. AsyncOS then compares this score with a threshold value associated with the content or message filter to determine if the message should trigger the filter action.

You can also add smart identifiers to a content dictionary. Smart identifiers are algorithms that search for patterns in data that correspond to common numeric patterns, such as social security numbers and ABA routing numbers. These identifiers can be useful for policy enforcement. For more information about regular expressions,

see “Regular Expressions in Rules” in the “Using Message Filters to Enforce Email Policies” chapter. For more information about smart identifiers, see “Smart Identifiers” in the “Using Message Filters to Enforce Email Policies” chapter.



---

**Note** Dictionaries containing non-ASCII characters may or may not display properly in the CLI on your terminal. The best way to view and change dictionaries that contain non-ASCII characters is to export the dictionary to a text file, edit that text file, and then import the new file back into the email gateway. For more information, see [Importing and Exporting Dictionaries as Text Files, on page 642](#).

---

### Related Topics

- [Word Boundaries and Double-byte Character Sets, on page 642](#)

## Word Boundaries and Double-byte Character Sets

In some languages (double-byte character sets), the concepts of a word or word boundary, or case do not exist. Complex regular expressions that depend on concepts like what is or is not a character that would compose a word (represented as “w” in regex syntax) cause problems when the locale is unknown or if the encoding is not known for certain. For that reason, you may want to disable word-boundary enforcement.

## Importing and Exporting Dictionaries as Text Files

The content dictionary feature also includes, by default, the following text files located in the configuration directory of the email gateway:

- `config.dtd`
- `profanity.txt`
- `proprietary_content.txt`
- `sexual_content.txt`

These text files are intended to be used in conjunction with the content dictionaries feature to aid you in creating new dictionaries. These content dictionaries are weighted and use smart identifiers to better detect patterns in data and trigger filters when the patterns indicate compliance issues.



---

**Note** Importing and exporting dictionaries does not preserve the Match Whole Words and Case Sensitive settings. This settings are only preserved in the configuration file.

---

See [FTP, SSH, and SCP Access, on page 1303](#) for more information accessing on the configuration directory.

You can also create your own dictionary files and import them onto the email gateway. The best way to add non-ASCII characters to dictionaries is to add the terms into the dictionary in a text file off the email gateway, move that file onto the email gateway, and then import that file as a new dictionary. For more information about importing dictionaries, see [Importing Dictionaries, on page 644](#). For information about exporting dictionaries, see [Exporting Dictionaries, on page 645](#).



**Caution** These text files contain terms that some persons may consider obscene, indecent or offensive. If you import terms from these files into your content dictionaries, the terms will be displayed when you later view the content dictionaries you have configured on the email gateway.

## Adding Dictionaries

### Procedure

- 
- Step 1** Navigate to the **Mail Policies > Dictionaries** page.
- Step 2** Click **Add Dictionary**.
- Step 3** Type a name for the dictionary.
- Step 4** (Optional) Configure Advanced Matching.
- Note** AsyncOS preserves the **Match Whole Words** and **Case Sensitive** settings when you save them in the configuration file. AsyncOS does not preserve these settings when importing and exporting dictionaries.
- Step 5** (Optional) Add a smart-identifier to the dictionary.
- Smart identifiers are algorithms that search for patterns in data that correspond to common numeric patterns, such as social security numbers and ABA routing numbers. For more information about smart identifiers, see the “Using Message Filters to Enforce Email Policies” chapter.
- Step 6** Enter new dictionary entries into the list of terms.
- If you have multiple new entries to add, and you want them to be equally likely trigger a filter action, put each new term on its own line.
- Note** Content dictionary entries with the regular expression: “. \* ” at the beginning or end will cause the system to lock if a match for the “word” MIME part is found. Cisco Systems recommends you do not use “. \* ” at the beginning or end of a content dictionary entry.
- Step 7** Specify a weight for the term(s).
- You can “weight” a dictionary term so that it is more likely than other terms to trigger a filter action. For more information about how this weight is used to determine filter actions, see “Threshold Scoring for Content Dictionaries” in the “Using Message Filters to Enforce Email Policies” chapter.
- Step 8** Click **Add**.
- Step 9** Submit and commit your changes.
- 

### What to do next

#### Related Topics

- [Dictionary Content, on page 641.](#)

## Deleting Dictionaries

### Before You Begin

Be aware that AsyncOS marks any message filter that references the deleted dictionary as invalid. AsyncOS leaves any content filter that references the deleted dictionary enabled, but will evaluate them to false.

### Procedure

---

- Step 1** Navigate to the **Mail Policies > Dictionaries** page.
  - Step 2** Click the trash can icon next to the dictionary to delete in the dictionary listing.  
A confirmation message lists any filters that are currently referencing the dictionary.
  - Step 3** Click **Delete** in the confirmation message.
  - Step 4** Commit your changes.
- 

## Importing Dictionaries

### Before You Begin

Verify that the file to import is present in the configuration directory on the email gateway.

### Procedure

---

- Step 1** Navigate to the **Mail Policies > Dictionaries** page.
  - Step 2** Click **Import Dictionary**.
  - Step 3** Select the location to import from.
  - Step 4** Select the file to import.
  - Step 5** Select the default weight to use for dictionary terms.  
AsyncOS will assign a default weight to any terms with unspecified weights. You can edit the weights after importing the file.
  - Step 6** Select an encoding.
  - Step 7** Click **Next**.
  - Step 8** Name and edit the dictionary.
  - Step 9** Submit and commit your changes.
-

## Exporting Dictionaries

### Procedure

- 
- Step 1** Navigate to the **Mail Policies** > Dictionaries page.
- Step 2** Click **Export Dictionary**.
- Step 3** Select the dictionary to export.
- Step 4** Enter a file name for the exported dictionary.  
This is the name of the file that will be created in the configuration directory on the email gateway.
- Step 5** Select the location to export to.
- Step 6** Select an encoding for the text file.
- Step 7** Submit and commit your changes.
- 

## Using and Testing the Content Dictionaries Filter Rules

Dictionaries can be used along with the various `dictionary-match()` message filter rules and with content filters.

### Related Topics

- [Dictionary Match Filter Rule, on page 645](#)

## Dictionary Match Filter Rule

The message filter rule named `dictionary-match(<dictionary_name>)` (and its counterparts) evaluates to true if the message body contains any of the regular expressions in the content dictionary named `dictionary_name`. If that dictionary does not exist, the rule evaluates to false.

Note that the `dictionary-match()` rule functions similarly to the `body-contains()` body scanning rule: it only scans the body and attachments of messages, and not the headers.

For scanning headers, you can use the appropriate `*-dictionary-match()` -type rule (there are rules for specific headers, such as `subject-dictionary-match()` and a more generic rule, `header-dictionary-match()`, in which you can specify any header including custom headers). See “Dictionary Rules” in the “Using Message Filters to Enforce Email Policies” chapter for more information about dictionary matching.

**Table 46: Message Filter Rules for Content Dictionaries**

Rule	Syntax	Description
Dictionary Match	<code>dictionary-match(&lt;dictionary_name&gt;)</code>	Does the message contain a word that matches all the regular expressions listed in the named dictionary?

In the following example, a new message filter using the `dictionary-match()` rule is created to blind carbon copy the administrator when the email gateway scans a message that contains any words within the dictionary

named “secret\_words” (created in the previous example). Note that because of the settings, only messages that contain the whole word “codename” matching the case exactly will evaluate to true for this filter.

```
bcc_codenames:

if (dictionary-match ('secret_words'))

{

bcc('administrator@example.com');

}
```

In this example, we send the message to the Policy quarantine:

```
quarantine_codenames:

if (dictionary-match ('secret_words'))

{

quarantine('Policy');

}
```

### Related Topics

- [Example Dictionary Entries, on page 646](#)
- [Testing Content Dictionaries, on page 646](#)

## Example Dictionary Entries

*Table 47: Example Dictionary Entries*

Description	Example
Wildcard	
Anchors	Ends with: foo \$ Begins with: ^ foo
Email address(Do not escape the period)	<b>foo@example.com, @example.com</b> <b>example.com\$ (ends with)@example.*</b>
Subject	<b>An email subject</b> (keep in mind when using the ^ anchor in email subjects that subjects are often prepended with “RE:” or “FW:” and the like)

## Testing Content Dictionaries

The `trace` function can provide quick feedback on message filters that use the `dictionary-match()` rule. See [Debugging Mail Flow Using Test Messages: Trace, on page 1255](#) for more information. You can also use the `quarantine()` action to test filters, as in the `quarantine_codenames` filter example above.

# Understanding Text Resources

Text resources are text templates that can be attached to messages or sent as messages. Text resources can be one of the following types:

- **Message disclaimers** — Text that is added to messages. For more information, see [Disclaimer Template, on page 651](#).
- **Notification templates** — Messages that are sent as notifications, used with the `notify()` and `notify-bcc()` actions. For more information, see [Notification Templates, on page 656](#).
- **Anti-virus Notification templates** — Messages that are sent as notifications when a virus is found in a message. You can create a template for a container (which appends the original message), or as a notice that is sent without the appended message. For more information, see [Anti-Virus Notification Templates, on page 657](#).
- **Bounce and Encryption Failure Notification templates** — Messages that are sent as notifications when a message is bounced or message encryption fails. For more information, see [Bounce and Encryption Failure Notification Templates, on page 659](#).
- **Encryption Notification Templates** — Messages that are sent when you configure the email gateway to encrypt outgoing email. The message notifies recipients that they have received an encrypted message and provides instructions for reading it. For more information, see [Encryption Notification Templates, on page 660](#).

You can use the CLI ( `textconfig` ) or the GUI to manage text resources, including: adding, deleting, editing, importing, and exporting. For information on managing text resources using the GUI, see [Overview of Text Resource Management, on page 648](#).

Text resources can contain non-ASCII characters.



---

**Note** Text resources containing non-ASCII characters may or may not display properly in the CLI on your terminal. To view and change text resources that contain non-ASCII characters, export the text resource to a text file, edit that text file, and then import the new file back into the email gateway. For more information, see [Importing and Exporting Dictionaries as Text Files, on page 642](#).

---

## Related Topics

- [Importing and Exporting Dictionaries as Text Files, on page 642](#)

## Importing and Exporting Text Resources as Text Files

You must have access to the configuration directory on the email gateway. Imported text files must be present in the configuration directory on the email gateway. Exported text files are placed in the configuration directory.

See [FTP, SSH, and SCP Access, on page 1303](#) for more information on accessing the configuration directory.

To add non-ASCII characters to text resources, add the terms into the text resource in a text file off the email gateway, move that file onto the email gateway, and then import that file as a new text resource. For more information about importing text resources, see [Importing Text Resources, on page 649](#). For information about exporting text resources, see [Exporting Text Resources, on page 649](#).

# Overview of Text Resource Management

You can manage text resources using either the GUI or the CLI. This section focuses on the GUI.

Manage text resources from the CLI using the `textconfig` command.

Text resource management includes these tasks:

- Adding
- Editing and deleting
- Exporting, and importing
- Defining plain text messages for all text resource types
- Defining HTML-based messages for some text resource types

## Related topics

- [Adding Text Resources, on page 648](#)
- [Deleting Text Resources, on page 648](#)
- [Exporting Text Resources, on page 649](#)
- [Importing Text Resources, on page 649](#)
- [Overview of HTML-Based Text Resources, on page 650.](#)

## Adding Text Resources

### Procedure

---

- Step 1** Navigate to **Mail Policies > Text Resources**
- Step 2** Click **Add Text Resource**.
- Step 3** Enter a name for the text resource in the **Name** field.
- Step 4** Select the type of text resource from the **Type** field.
- Step 5** Enter the message text in either the **Text** or the **HTML and Plain Text** field.

If the text resource allows only plain text messages, use the **Text** field. If the text resource allows both HTML and plain text messages, use the **HTML and Plain Text** fields.

- Step 6** Submit and commit your changes.
- 

### What to do next

#### Related topics

- [Overview of HTML-Based Text Resources, on page 650.](#)

## Deleting Text Resources

### Before you begin



Note the impact of deleting text resources:

- Any message filters that reference the deleted text resource are marked as invalid.
- Any content filters that reference the deleted text resource are left enabled, but will evaluate to false.

### Procedure

---

**Step 1** On the **Mail Policies > Text Resources** page, click the trash can icon under the Delete column for the text resource you want to delete. A confirmation message is displayed.

**Step 2** Click **Delete** to delete the text resource.

**Note** You cannot delete a text resource that is referenced in any of the content or message filter configurations.

**Step 3** Commit your changes.

---

## Importing Text Resources

### Before you begin

Ensure that the file to import is in the configuration directory on the email gateway.

### Procedure

---

**Step 1** On the **Mail Policies > Text Resources** page, click **Import Text Resource**.

**Step 2** Select a file to import.

**Step 3** Specify an encoding.

**Step 4** Click **Next**.

**Step 5** Choose a name, edit, and select the text resource type.

**Step 6** Submit and commit your changes.

---

## Exporting Text Resources

### Before you begin

Be aware that when you export a text resource, a text file is created in the configuration directory on the email gateway.

### Procedure

---

**Step 1** On the **Mail Policies > Text Resources** page, click **Export Text Resource**.

**Step 2** Select a text resource to export.

**Step 3** Enter a file name for the text resource.

- Step 4** Select an encoding for the text file.
- Step 5** Click **Submit** to create the text file containing the text resource in the configuration directory.
- 

## Overview of HTML-Based Text Resources

You can create some text resources with both HTML-based and plain text messages, such as Disclaimers. When a text resource containing both HTML-based and plain text messages is applied to an email message, the HTML-based text resource message is applied to the text/html part of the email message, and the plain text message is applied to the text/plain part of the email message.

When you add or edit an HTML-based text resource, the GUI includes a rich text edit that allows you to enter rich text without having to manually write HTML code.

Consider the following information when adding and editing an HTML-based text resource:

- You can choose to have the plain text version of the message to be automatically generated based on the HTML version, or you can define the plain text version independently.
- You can switch between the rich text editor and HTML code by clicking the **Code View** button.
- To enter HTML code that is not supported in the rich text editor in the GUI, switch to code view and manually enter HTML code. For example, you might want to do this to insert a reference to an image file located on an external server using the `<img src>` HTML tag.

### Related Topics

- [Importing and Exporting HTML-Based Text Resources, on page 650](#)

## Importing and Exporting HTML-Based Text Resources

You can export to and import from a text file HTML-based text resources. When you export an HTML-based text resource to a file, the file contains the following sections for each version of the text resource:

- [html\_version]
- [text\_version]

The order of these sections does not matter.

For example, an exported file might contain the following text:

```
[html_version]
<p>Sample <i>message.</i></p>
[text_version]
Sample message.
```

Consider the following rules and guidelines when exporting and importing HTML-based text resources:

- When you export an HTML-based text resource whose plain text message is automatically generated from the HTML version, the exported file does not contain the [text\_version] section.
- When you import from a text file, any HTML code under the [html\_version] section is converted to the HTML message in the created text resource if the text resource type supports HTML messages. Similarly, any text under the [text\_version] section is converted to the plain text message in the created text resource.

- When you import from a file that contains an empty or nonexistent `[html_version]` section to create a HTML-based text resource, the email gateway creates both an HTML and plain text message using the text in the `[text_version]` section.

## Using Text Resources

All types of text resources are created in the same way, using the Text Resources page or the `textconfig` CLI command. Once created, each type is used in a different way. Disclaimers and notification templates are used with filters and listeners, while anti-virus notification templates are used with mail policies and anti-virus settings.

### Related Topics

- [Disclaimer Template, on page 651](#)
- [Disclaimer Stamping and Multiple Encodings, on page 654](#)
- [Notification Templates, on page 656](#)
- [Anti-Virus Notification Templates, on page 657](#)
- [Bounce and Encryption Failure Notification Templates, on page 659](#)
- [Encryption Notification Templates, on page 660](#)

## Disclaimer Template

The email gateway can add a default disclaimer above or below the text (heading or footer) for some or all messages received by a listener. You can add disclaimers to messages on the email gateway using the following methods:

- Via a listener, using the GUI or the `listenerconfig` command (see [Adding Disclaimer Text via a Listener, on page 652](#)).
- Using the content filter action, `Add Disclaimer Text` (see [Content Filter Actions, on page 278](#)).
- Using the message filter action, `add-footer()` (see the “Using Message Filters to Enforce Email Policies” chapter).
- Using a data loss prevention profile (see [Data Loss Prevention, on page 505](#)).
- Using message modification for Outbreak Filters to alert the user that the message may be an attempt at phishing or malware distribution (see [Modifying Messages, on page 426](#)). Disclaimers added for this type of notification are added above the text.

For example, you can append a copyright statement, promotional message, or disclaimer to every message sent from within your enterprise.

Prior to using disclaimer text you have to create the disclaimer template. Use the Text Resources page in the GUI (see [Adding Text Resources, on page 648](#)) or the `textconfig` command (see the CLI Reference Guide for AsyncOS for Cisco Secure Email Gateway) to create and manage a set of text strings to be used.

### Related Topics

- [Adding Disclaimers via Filters, on page 652](#)
- [Adding Disclaimer Text via a Listener, on page 652](#)
- [Disclaimers and Filter Action Variables, on page 652](#)

## Adding Disclaimer Text via a Listener

Once you have disclaimer text resources created, select which text strings will be appended to messages received by the listener. You can add disclaimer text above or below a message. This feature is available on both public (inbound) and private (outbound) listeners.

If you send a message that consists of text and HTML (Microsoft Outlook calls this type of message a “multipart alternative”), the email gateway will stamp the disclaimer on both parts of the message. However, if your message has signed content, the content will not be modified because the modification will invalidate the signature. Instead, a new part is created with a disclaimer stamp that says “Content-Disposition inline attachment.” For more information on multipart messages, see “Message Bodies vs. Message Attachments” in the “Using Message Filters to Enforce Email Policies” chapter.

## Adding Disclaimers via Filters

You can also append specific, predefined text strings to the disclaimers of messages using the filter action `add-footer()` or the content filter action “Add Disclaimer Text.” For example, the following message filter rule appends the text string named `legal.disclaimer` to all messages sent from users in the LDAP group “Legal:”

```
Add-Disclaimer-For-Legal-Team:

if (mail-from-group == 'Legal')
{
add-footer('legal.disclaimer');
}
```

## Disclaimers and Filter Action Variables

You can also use message filter action variables (see “Action Variables” in the “Using Message Filters to Enforce Email Policies” chapter for more information).

The following variables are available for the Disclaimer Template:

**Table 48: Anti-Virus Notification Variables**

Variable	Substituted With
\$To	Replaced by the message To: header (not the Envelope Recipient).
\$From	Replaced by the message From: header (not the Envelope Sender).
\$Subject	Replaced by the subject of the original message.
\$Date	Replaced by the current date, using the format MM/DD/YYYY.
\$Time	Replaced by the current time, in the local time zone.
\$GMTimestamp	Replaced by the current time and date, as would be found in the Received: line of an email message, using GMT.
\$MID	Replaced by the Message ID, or “MID” used internally to identify the message. Not to be confused with the RFC822 “Message-Id” value (use \$Header to retrieve that).

Variable	Substituted With
\$Group	Replaced by the name of the sender group the sender matched on when injecting the message. If the sender group had no name, the string ">Unknown<" is inserted.
\$Policy	Replaced by the name of the HAT policy applied to the sender when injecting the message. If no predefined policy name was used, the string ">Unknown<" is inserted.
\$Reputation	Replaced by the IP Reputation score of the sender. If there is no reputation score, it is replaced with "None".
\$filenames	Replaced with a comma-separated list of the message's attachments' filenames.
\$filetypes	Replaced with a comma-separated list of the message's attachments' file types.
\$filesizes	Replaced with a comma-separated list of the message's attachment's file sizes.
\$remotehost	Replaced by the hostname of the system that sent the message to the email gateway.
\$AllHeaders	Replaced by the message headers.
\$EnvelopeFrom	Replaced by the Envelope Sender (Envelope From, <MAIL FROM>) of the message.
\$Hostname	Replaced by the hostname of the email gateway.
\$header['string ']	Replaced by the value of the quoted header, if the original message contains a matching header. Note that double quotes may also be used.
\$envelope recipients	Replaced by all Envelope Recipients (Envelope To, <RCPT TO>) of the message.
\$bodysize	Replaced by the size, in bytes, of the message.
\$FilterName	Returns the name of the filter being processed.
\$MatchedContent	Returns the content that triggered a scanning filter rule (including filter rules such as body-contains and content dictionaries).
\$DLPPolicy	Replaced by the name of the email DLP policy violated.
\$DLPSeverity	Replaced by the severity of violation. Can be "Low," "Medium," "High," or "Critical."
\$DLPRiskFactor	Replaced by the risk factor of the message's sensitive material (score 0 - 100).
\$threat_category	Replaced with the type of Outbreak Filters threat, such as phishing, virus, scam, or malware.
\$threat_type	Replaced by a subcategory of the Outbreak Filters threat category. For example, can be a charity scam, a financial phishing attempt, a fake deal, etc.
\$threat_description	Replaced by a description of the Outbreak Filters threat.
\$threat_level	Replaced by the message's threat level (score 0 - 5).

Variable	Substituted With
\$threat_verdict	Replaced by Yes or No, depending on the Message Modification Threat Level threshold. If the viral or non-viral threat level of a message is greater than or equal to the message modification threat level threshold, the value of this variable is set to Yes.

To use message filter action variables in disclaimers, create a message disclaimer (via the Text Resource page in the GUI or the **textconfig** command), and reference the variable:

The add-footer() action supports non-ASCII text by adding the footer as an inline, UTF-8 coded, quoted printable attachment.

## Disclaimer Stamping and Multiple Encodings

AsyncOS includes a setting used to modify the way disclaimer stamping with different character encodings works. By default, AsyncOS attempts to place the disclaimers it attaches within the body part of an email message. You can use a setting configured within the `localeconfig` command to configure the behavior if the encodings of the body part and the disclaimer are different. To understand this setting, it is helpful to view an email message as consisting of several parts:

To: joe@example.com From: mary@example.com Subject: Hi!	Headers
<blank line>	
Hello!	Body part
This message has been scanned...	First attachment part
Example.zip	Second attachment part

The message body after the first blank line may contain many MIME parts. The second and following parts are often called “attachments,” while the first is often called the “body” or “text.”

A disclaimer can be included in an email as either an attachment (above) or as part of the body

To: joe@example.com From: mary@example.com Subject: Hi!	Headers
<blank line>	
Hello!	Body part
This message has been scanned...	Disclaimer now included in body part

Example.zip	First attachment part
-------------	-----------------------

Typically, when there is an encoding mismatch between the message body and a disclaimer, AsyncOS attempts to encode the entire message in the same encoding as the message body so that the disclaimer will be included in the body (“inline”) and not included as a separate attachment. In other words, the disclaimer will be included inline if the encoding of the disclaimer matches that of the body, or if the text in the disclaimer contains characters that can be displayed inline (in the body). For example, it is possible to have a ISO-8859-1 encoded disclaimer that only contains US-ASCII characters; consequently, this will display “inline” without problems.

However, if the disclaimer cannot be combined with the body, you can use the `localeconfig` command to configure AsyncOS to attempt to promote, or convert, the body text to match the encoding of the disclaimer so that the disclaimer can be included in the body of the message:

```
example.com> localeconfig
```

```
Behavior when modifying headers: Use encoding of message body
Behavior for untagged non-ASCII headers: Impose encoding of message body
Behavior for mismatched footer or heading encoding: Try both body and footer or heading
encodings
Behavior when decoding errors found: Disclaimer is displayed as inline content and the
message body is added as an attachment.
```

```
Choose the operation you want to perform:
- SETUP - Configure multi-lingual settings.
[]> setup
```

```
If a header is modified, encode the new header in the same encoding as the message body?
(Some MUAs incorrectly handle headers encoded in a different encoding than the body.
However, encoding a modified header in the same encoding as the message body may cause
certain
characters in the modified header to be lost.) [Y]>
```

```
If a non-ASCII header is not properly tagged with a character set and is being used or
modified,
impose the encoding of the body on the header during processing and final representation
of the message?
(Many MUAs create non-RFC-compliant headers that are then handled in an undefined way.
Some MUAs handle headers encoded in character sets that differ from that of the main body
in an incorrect way.
Imposing the encoding of the body on the header may encode the header more precisely.
This will be used to interpret the content of headers for processing, it will not modify
or rewrite the
header unless that is done explicitly as part of the processing.) [Y]>
```

```
Disclaimers (as either footers or headings) are added in-line with the message body whenever
possible.
However, if the disclaimer is encoded differently than the message body, and if imposing a
single encoding
will cause loss of characters, it will be added as an attachment. The system will always
try to use the
message body's encoding for the disclaimer. If that fails, the system can try to edit the
message body to
use an encoding that is compatible with the message body as well as the disclaimer. Should
the system try to
re-encode the message body in such a case? [Y]>
```

```
If the disclaimer that is added to the footer or header of the message generates an error
when decoding the message body,
it is added at the top of the message body. This prevents you to rewrite a new message
content that must merge with
the original message content and the header/footer-stamp. The disclaimer is now added as
```

```

an additional MIME part
that displays only the header disclaimer as an inline content, and the rest of the message
content is split into
separate email attachments. Should the system try to ignore such errors when decoding the
message body? [N]>

```

Behavior when modifying headers: Use encoding of message body

Behavior for untagged non-ASCII headers: Impose encoding of message body

**Behavior for mismatched footer or heading encoding: Try both body and footer or heading encodings**

Behavior when decoding errors found: Disclaimer is displayed as inline content and the message body is added as an attachment.

```

Choose the operation you want to perform:
- SETUP - Configure multi-lingual settings.
[]>

```

For more information about the `localeconfig` command, see the “Configuring the Email Gateway to Receive Mail” chapter.

## Notification Templates

Notification templates are used with the `notify()` and `notify-copy()` filter actions. Notification templates may contain non-ascii text and action variables (see “Action Variables” in the “Using Message Filters to Enforce Email Policies” chapter), including the anti-virus-related variables used by anti-virus notifications. For example, you could use the `$Allheaders` action variable to include the headers from the original message. You can configure the From: address for notifications, see [Configuring the Return Address for Email Gateway Generated Messages, on page 1044](#).

Once you have created a notification template, you can refer to it in content and message filters. The following figure shows a content filter where the `notify-copy()` filter action is set to send the “grape\_text” notification to “grapewatchers@example.com.”

**Figure 39: Notify Example in a Content Filter**

### Edit Content Filter

Edit Filter	
Name:	grapecheck
Currently used by policies:	DEFAULT
Description:	Looking for grapes.
Order:	1
Apply filter:	<input checked="" type="radio"/> If one or more conditions match <input type="radio"/> Only if ALL conditions match
Conditions	
Select New Condition...	Add Condition
Condition	Delete
body-contains("grape")	
Actions	
Select New Action...	Add Action
Action	Delete
notify-copy ("grapewatchers@example.com", "Found one!", "", "grape_text")	
Cancel	Submit



## Anti-Virus Notification Templates

There are two types of anti-virus notification templates:

- **anti-virus notification template.** The anti-virus notification template is used when the original message is not attached to the virus notification.
- **anti-virus container template.** The container template is used when the original message is sent as an attachment.

Anti-virus notification templates are used in basically the same way as notification templates except that they are used with the anti-virus engine instead of filters. You can specify a custom notification to send while editing a mail policy. You can configure the From: address for anti-virus notifications. For information, see [Configuring the Return Address for Email Gateway Generated Messages, on page 1044](#).

### Related Topics

- [Custom Anti-Virus Notification Templates, on page 657](#)

## Custom Anti-Virus Notification Templates

The following figure shows a mail policy where a custom anti-virus notification is specified.

**Figure 40: Anti-Virus Container Template Notification Example in a Mail Policy**

Virus Infected Messages:	
Action Applied to Message:	Deliver as Attachment (RFC822) to New Message
Archive Original Message:	<input type="radio"/> No <input checked="" type="radio"/> Yes
Modify Message Subject:	<input type="radio"/> No <input checked="" type="radio"/> Prepend <input type="radio"/> Append
	[WARNING : VIRUS DETECTED]
Advanced	Add Custom Header to Message: <input checked="" type="radio"/> No <input type="radio"/> Yes Header: <input type="text"/> Value: <input type="text"/>
	Container Notification: anti_virus_container Preview Message Body  <small>(see Mail Policies &gt; Text Resources &gt; Anti-Virus Container Template)</small>

### Related Topics

- [Anti-Virus Notification Variables, on page 657](#)

## Anti-Virus Notification Variables

When creating an anti-virus notification, you can use any of the notification variables listed in the following table:

**Table 49: Anti-Virus Notification Variables**

Variable	Substituted With
\$To	Replaced by the message To: header (not the Envelope Recipient).
\$From	Replaced by the message From: header (not the Envelope Sender).
\$Subject	Replaced by the subject of the original message.

Variable	Substituted With
\$AV_VIRUSES	Replaced by the list of all the viruses found anywhere in the message: “Unix/Apache.Trojan”, “W32/Bagel-F”
\$AV_VIRUS_TABLE	Replaced by the table of MIME-Part/Attachment names and viruses in each part: “HELLO.SCR” : “W32/Bagel-F” <unnamed part of the message> : “Unix/Apache.Trojan”
\$AV_VERDICT	Replaced by the anti-virus verdict.
\$AV_DROPPED_TABLE	Replaced by the table of attachments that were dropped. Each row is composed of a part or filename followed by the list of viruses associated with that part: “HELLO.SCR” : “W32/Bagel-f”, “W32/Bagel-d” “Love.SCR” : “Netsky-c”, “W32/Bagel-d”
\$AV_REPAIRED_VIRUSES	Replaced by the list of all the viruses found and repaired.
\$AV_REPAIRED_TABLE	Replaced by the table of all parts and viruses found and repaired: “HELLO.SCR” : “W32/Bagel-F”
\$AV_DROPPED_PARTS	Replaced by the list of filenames that were dropped: “HELLO.SCR”, “CheckThisOut.exe”
\$AV_REPAIRED_PARTS	Replaced by the list of filenames or parts that were repaired.
\$AV_ENCRYPTED_PARTS	Replaced by the list of filenames or parts that were encrypted.
\$AV_INFECTED_PARTS	Replaced by a comma-separated list of filenames for the files that contained a virus.
\$AV_UNSCANNABLE_PARTS	Replaced by the list of filenames or parts that were unscannable.
\$Date	Replaced by the current date, using the format MM/DD/YYYY.
\$Time	Replaced by the current time, in the local time zone.
\$GMTimestamp	Replaced by the current time and date, as would be found in the Received: line of an email message, using GMT.
\$MID	Replaced by the Message ID, or “MID” used internally to identify the message. Not to be confused with the RFC822 “Message-Id” value (use \$Header to retrieve that).
\$Group	Replaced by the name of the sender group the sender matched on when injecting the message. If the sender group had no name, the string “>Unknown<” is inserted.
\$Policy	Replaced by the name of the HAT policy applied to the sender when injecting the message. If no predefined policy name was used, the string “>Unknown<” is inserted.

Variable	Substituted With
\$Reputation	Replaced by the IP Reputation score of the sender. If there is no reputation score, it is replaced with “None”.
\$filenames	Replaced with a comma-separated list of the message’s attachments’ filenames.
\$filetypes	Replaced with a comma-separated list of the message’s attachments’ file types.
\$filesizes	Replaced with a comma-separated list of the message’s attachment’s file sizes.
\$remotehost	Replaced by the hostname of the system that sent the message to the email gateway.
\$AllHeaders	Replaced by the message headers.
\$EnvelopeFrom	Replaced by the Envelope Sender (Envelope From, <MAIL FROM>) of the message.
\$Hostname	Replaced by the hostname of the email gateway.



**Note** Variable names are not case-sensitive. For example, specifying “\$to” is equivalent to specifying “\$To” in the text resource. If an “AV\_” variable is empty in the original message, the string <None> is substituted.

After the text resource has been defined, use the **Mail Policies > Incoming/Outgoing Mail Policies > Edit Anti-Virus Settings** page or the `policyconfig -> edit -> antivirus` command to specify that the original message is to be included as an RFC 822 attachment for Repaired, Unscannable, Encrypted, or Virus Positive messages. See [Send Custom Alert Notification, on page 372](#) for more information.

## Bounce and Encryption Failure Notification Templates

Bounce and encryption failure notification templates are used in basically the same way as notification templates except that they are used with bounce notifications and message encryption failure notifications. You can specify a custom bounce notification to send while editing a bounce profile and a custom message encryption failure notification while editing an encryption profile.

The following figure shows a bounce notification template specified in a bounce profile.

**Figure 41: Bounce Notification Example in a Bounce Profile**

Send Delay Warning Messages:

Use Default (No)  Yes  No

Message Composition

Message Subject:

Notification Template:

Minimum Interval Between Messages:  seconds

Maximum Number of Messages to Send:



**Note** You must use RFC-1891 DSNs to use custom templates.

The following figure shows an encryption failure template specified in an encryption profile.

**Figure 42: Encryption Failure Notification Example in an Encryption Profile**

Notification Settings	
<i>Use system generated notifications by default or create custom notification templates can be configured in Mail Policies &gt; Text Resources</i>	
HTML Notification:	System Generated Preview Message
Text Notification:	System Generated Preview Message
Encryption Failure Notification:	Message Subject: <input type="text" value="[[ENCRYPTION FAILURE]]"/> Message Body: <input type="text" value="MaxSize"/>

### Related Topics

- [Bounce and Encryption Failure Notification Variables, on page 660](#)

## Bounce and Encryption Failure Notification Variables

When creating a bounce or encryption failure notification, you can use any of the notification variables listed in the following table:

**Table 50: Bounce Notification Variables**

Variable	Substituted With
\$Subject	The subject of the original message.
\$Date	Replaced by the current date, using the format MM/DD/YYYY.
\$Time	Replaced by the current time, in the local time zone.
\$GMTTimeStamp	Replaced by the current time and date, as would be found in the Received: line of an email message, using GMT.
\$MID	Replaced by the Message ID, or “MID” used internally to identify the message. Not to be confused with the RFC822 “Message-Id” value (use \$Header to retrieve that).
\$BouncedRecipient	Bounced recipient address
\$BounceReason	Reason for this notification
\$remotehost	Replaced by the hostname of the system that sent the message to the email gateway.

## Encryption Notification Templates

Encryption notification templates are used when you configure Cisco Email Encryption to encrypt outbound email. The notification informs recipients that they have received an encrypted message and provides

instructions for reading it. You can specify a custom encryption notification to send with encrypted messages. You specify both an HTML and a text encryption notification when you create an encryption profile. Therefore, if you want to create a custom profile, you should create both text and HTML notifications.





## CHAPTER 28

# Validating Recipients Using an SMTP Server

This chapter contains the following sections:

- [Overview of SMTP Call-Ahead Recipient Validation, on page 663](#)
- [SMTP Call-Ahead Recipient Validation Workflow, on page 663](#)
- [How to Validate Recipients Using an External SMTP Server, on page 665](#)
- [Enabling a Listener to Validate Incoming Mail Via the SMTP Server, on page 668](#)
- [Configuring LDAP Routing Query Settings, on page 669](#)
- [SMTP Call-Ahead Query Routing, on page 669](#)
- [Bypassing SMTP Call-Ahead Validation for Certain Users or Groups, on page 670](#)

## Overview of SMTP Call-Ahead Recipient Validation

The SMTP call-ahead recipient validation feature queries an external SMTP server before accepting incoming mail for a recipient. Use this feature to validate recipients when you cannot use LDAP Accept or the Recipient Access Table (RAT). For example, suppose you host mail for many mailboxes, each using a separate domain, and your LDAP infrastructure does not allow you to query the LDAP server to validate each recipient. In this case, the email gateway can query the SMTP server and validate the recipient before continuing the SMTP conversation.

You can use SMTP call-ahead recipient validation in order to reduce processing on messages for invalid recipients. Typically, a message for an invalid recipient progresses through the work queue before it can be dropped. Instead, an invalid message can be dropped or bounced during the incoming/receiving part of the email pipeline without requiring additional processing.

## SMTP Call-Ahead Recipient Validation Workflow

When you configure your email gateway for SMTP call-ahead recipient validation, the email gateway suspends the SMTP conversation with the sending MTA while it “calls ahead” to the SMTP server to verify the recipient. When the email gateway queries the SMTP server, it returns the SMTP server’s response to the Email Security appliance, and depending on the settings you have configured, you can accept the mail or drop the connection with a code and custom response.

The following figure shows the basic workflow of the SMTP call-head validation conversation.

Figure 43: SMTP Call Ahead Server Conversation Workflow

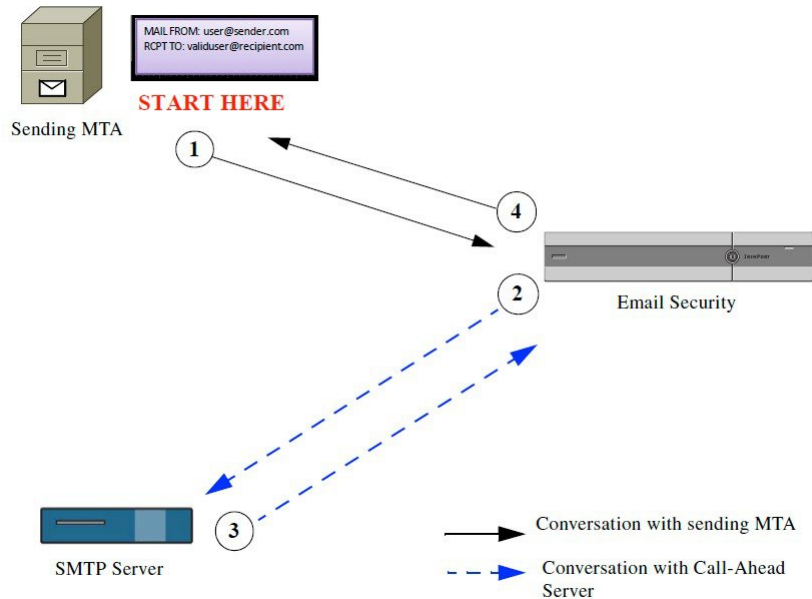

1. The sending MTA initiates an SMTP conversation.
2. The email gateway suspends the SMTP conversation while it sends a query to the SMTP server to verify the recipient, *validuser@recipient.com*.



---

**Note** If SMTP routes or LDAP routing queries are configured, these routes will be used to query the SMTP server.

---

3. The SMTP Server returns a query response to the email gateway.
4. The email gateway resumes the SMTP conversation and sends a response to the sending MTA, allowing the conversation to continue or dropping the connection based on the SMTP server response (and settings you configure in the SMTP Call-Ahead profile).

Due to the order of processes in the email pipeline, if the message for a given recipient is rejected by the RAT, then the SMTP call-ahead recipient validation will not occur. For example, if you specified in the RAT that only mail for *example.com* is accepted, then mail for *recipient@domain2.com* is rejected before SMTP call-ahead recipient validation can occur.



---

**Note** If you have configured Directory Harvest Attack Prevention (DHAP) in the HAT, be aware that SMTP call-ahead server rejections are part of the number of rejections included in the maximum invalid recipients per hour that you specify. You may need to adjust this number to account for additional SMTP server rejections. For more information about DHAP, see the “Configuring the Gateway to Receive Email” chapter.

---



# How to Validate Recipients Using an External SMTP Server

	Do This	More Info
Step 1	Determine how the email gateway connects to the SMTP server and interprets the server's responses.	<a href="#">Configuring the Call-Ahead Server Profile, on page 665</a>
Step 2	Configure a public listener to use the SMTP server to validate recipients	<a href="#">Enabling a Listener to Validate Incoming Mail Via the SMTP Server, on page 668</a>
Step 3	(Optional) Update your LDAP Routing query to determine the SMTP server to use when routing mail to a different host.	<a href="#">Configuring LDAP Routing Query Settings, on page 669</a>
Step 4	(Optional) Configure the email gateway to bypass call-ahead validation for certain recipients	<a href="#">Bypassing SMTP Call-Ahead Validation for Certain Users or Groups, on page 670</a>

## Related Topics

- [Configuring the Call-Ahead Server Profile, on page 665](#)

## Configuring the Call-Ahead Server Profile

When you configure the SMTP Call-Ahead Server Profile, you specify the settings that determine how the email gateway connects with the SMTP server and how it interprets the responses sent back from the SMTP server.

### Procedure

- 
- Step 1** Click **Network > SMTP Call-Ahead**.
  - Step 2** Click **Add Profile**.
  - Step 3** Enter the settings for the profile. For more information, see *Table - SMTP Call-Ahead Server Profile Settings*.
  - Step 4** Configure the advanced settings for the profile. For more information, see *Table - SMTP Call-Ahead Server Profile Advanced Settings*.
  - Step 5** Submit and commit your changes.
- 

### What to do next

- [SMTP Call-Ahead Server Profile Settings, on page 666](#)
- [Call Ahead Server Responses, on page 668](#)

## SMTP Call-Ahead Server Profile Settings

When you configure the SMTP Call-Ahead Server Profile, you need to configure settings that determine how the email gateway connects with the SMTP server.

**Table 51: SMTP Call-Ahead Server Profile Settings**

Setting	Description
Profile Name	Name of the call-ahead server profile.
Call-Ahead Server Type	<p>Choose from one of the following methods for connecting to the call-ahead server:</p> <ul style="list-style-type: none"> <li>• <b>Use Delivery Host.</b> Select this option to specify that the host for the delivery email address is used for the SMTP call-ahead query. For example, if the mail recipient address is <i>recipient@example.com</i>, the SMTP query is executed against the SMTP server associated with <i>example.com</i>. If you have configured SMTP routes or LDAP routing queries, these routes are used to determine the SMTP server to query. For details about configuring LDAP routing queries, see <a href="#">Configuring LDAP Routing Query Settings, on page 669</a>.</li> <li>• <b>Static Call-Ahead Server.</b> Use this option to create a static list of call-ahead servers to query. You may want to use this option if you do not expect the names and locations of the call-ahead servers to change often. When you use this option, the email gateway queries the hosts in a round-robin fashion, starting with the first static call-ahead server listed.</li> </ul> <p><b>Note</b> Note that when you choose the static call-ahead server type, no SMTP routes are applied to the query. Instead an MX lookup is performed, and then an A lookup is performed on the hosts to obtain the call-ahead IP addresses for the static servers.</p>
Static Call-Ahead Servers	<p>If you choose to use the static call-ahead server type, enter a list of host and port combinations in this field. List the server and port using the following syntax:</p> <pre>ironport.com:25</pre> <p>Separate multiple entries with a comma.</p>

The following table describes the SMTP Call-Ahead Server Profile advanced settings:

Table 52: SMTP Call-Ahead Server Profile Advanced Settings

Setting	Description
Interface	<p>The interface used to initiate the SMTP conversation with the SMTP server.</p> <p>Choose to use the Management interface or Auto. When you select Auto, the email gateway attempts to automatically detect an interface to use. The Cisco IronPort interface attempts to connect to the SMTP server in the following ways:</p> <ul style="list-style-type: none"> <li>• If the call-ahead server is on the same subnet as one of the configured interfaces, then the connection is initiated by the matching interface.</li> <li>• Any configured SMTP routes are used to route the query.</li> <li>• Otherwise, the interface that is on the same subnet as the default gateway are used.</li> </ul>
TLS Support for Recipient Validation	<p>Select the <b>Enabled</b> radio button if you want to perform SMTP call-ahead recipient validation using TLS.</p> <p><b>Note</b> The SMTP call-ahead recipient validation uses the same TLS version selected in the 'Other TLS Client Services' option in the 'SSL Configuration' page in your email gateway.</p> <p><b>Note</b> If you select the 'TLS Support for Recipient Validation' option, make sure you add a valid client certificate in your email gateway to establish SMTP call-ahead recipient validation using TLS.</p> <p><b>Note</b> TLS support for SMTP call-ahead recipient validation uses the DEFAULT SSL cipher list. The DEFAULT keyword is the OpenSSL DEFAULT cipher string, which is generally ALL:!EXPORT:!LOW:!aNULL:!eNULL:!SSLv2.</p>
MAIL FROM Address	The MAIL FROM: address to be used for the SMTP conversation with the SMTP server.
Validation Request Timeout	The number of seconds to wait for a result from the SMTP server. This timeout value is for a single recipient validation request which may involve contacting multiple call-ahead servers. See <a href="#">Call Ahead Server Responses, on page 668</a> .
Validation Failure Action	The action to be taken when a recipient validation request fails (due to a timeout, server failure, network issue, or unknown response). You can configure how you want the email gateway to handle the different responses. See <a href="#">Call Ahead Server Responses, on page 668</a> .
Temporary Failure Action	The action to be taken when a recipient validation request temporarily fails (and a 4xx response is returned from the remote SMTP server). This can occur when the mailbox is full, the mailbox is not available, or the service is not available.  See <a href="#">Call Ahead Server Responses, on page 668</a> .
Max. Recipients per Session	Maximum number of recipients to be validated in a single SMTP session.  Specify between 1 - 25,000 sessions.

Setting	Description
Max. Connections per Server	Maximum number of connections to a single call-ahead SMTP server. Specify between 1-100 connections.
Cache	Size of the cache for SMTP responses. Specify between 100-1,000,000 entries
Cache TTL	Time-to-live value for entries in the cache. This field defaults to 900 seconds. Specify between 60 - 86400 seconds.

## Call Ahead Server Responses

The SMTP server may return the following responses:

- **2xx**: When an SMTP code starting with 2 is received from the call-ahead server, the recipient is accepted. For example, a response of 250 allows the mailing action to continue.
- **4xx**: An SMTP code starting with a 4 means that a temporary failure has occurred in processing the SMTP request. A retry may later be processed successfully. For example, a response of 451 means the requested action was aborted or there was a local error in processing.
- **5xx**: An SMTP code starting with 5 means a permanent failure in processing the SMTP request occurred. For example, a response of 550 means the requested action was not taken or the mailbox was unavailable.
- **Timeout**. If no response is returned from the call-ahead server, you can configure how long to attempt to retry before a timeout occurs.
- **Connection error**. If a connection to the call-ahead server fails, you can configure whether to accept or reject a connection for the recipient address.
- **Custom Response**. You can configure to reject a connection with custom SMTP response (code and text) for validation failures and temporary failures.

## Enabling a Listener to Validate Incoming Mail Via the SMTP Server

Once you create the SMTP Call-Ahead Server Profile, you need to enable it on a listener to allow the listener to validate incoming mail via the SMTP server. SMTP call-ahead functionality is only available on public listeners, as recipient validation is not necessary for private listeners.

### Procedure

- 
- Step 1** Go to **Network > Listeners**.
  - Step 2** Click the name of the listener where you want to enable SMTP call-ahead functionality.
  - Step 3** In the **SMTP Call Ahead Profile** field, select the SMTP Call-Ahead profile you want to enable.
  - Step 4** Submit and commit your changes.
-

## Configuring LDAP Routing Query Settings

If you use an LDAP routing query to route mail to a different mail host, AsyncOS uses the Alternate Mailhost Attribute to determine the SMTP server to query. However, there are cases where you may not want that to occur. For example, in the following schema, note that the mail host attribute ( mailHost ) has a different SMTP address than the servers listed in the call-ahead SMTP server attribute ( callAhead ):

```
dn: mail=cisco.com, ou=domains
mail: cisco.com
mailHost: smtp.mydomain.com
policy: ASAV
callAhead: smtp2.mydomain.com,smtp3.mydomain.com:9025
```

In this case, you can use the **SMTP Call-Ahead** field to create a routing query that directs the SMTP call-ahead query to the servers listed in the callAhead attribute. For example, you might create a routing query with the following attributes:

**Figure 44: LDAP Routing Query Configured for SMTP Call-Ahead**

<input checked="" type="checkbox"/> Routing Query	
Name:	LDAP1.routing
Query String:	{mail={d}} <span style="float: right;">Test Query</span>
Recipient Email to Rewrite the Envelope Recipient:	
Alternative Mailhost Attribute:	mailHost
SMTP Call-Ahead Server Attribute (optional):	callAhead <small>This attribute is used only if an SMTP Call-Ahead server is configured. Go to Network &gt; SMTP Call-Ahead.</small>

In this query, the {d} represents the domain part of the recipient address, and the SMTP Call-Ahead Server Attribute returns the values for the call-ahead servers and the port that should be used for the query: smtp2.mydomain.com, smtp3.mydomain.com on port 9025.



**Note** This example shows just one way to configure a query that enables you to use the LDAP routing query to direct SMTP call-ahead queries to the correct SMTP servers. You are not required to use the query string or specific LDAP attributes described in this example.

## SMTP Call-Ahead Query Routing

When routing an SMTP call-ahead query, AsyncOS checks for information in the following order:

1. Checks the domain name.
2. Checks for LDAP Routing queries.
3. Checks for SMTP Routes.
4. Performs a DNS Lookup (First an MX Lookup is performed, followed by an A lookup).

If there is no LDAP routing query or no SMTP Routes configured for the domain, the result of preceding state is passed to next stage. In any case where there is no SMTP Route present, a DNS lookup is performed.

When you use an LDAP Routing query for an SMTP call-ahead query and you also have SMTP routes configured, the routing behavior depends upon the values returned by the routing query.

- If the LDAP routing query returns a single hostname without a port, the SMTP call-ahead query applies SMTP routes. If the SMTP routes only lists the destination host as the hostname, a DNS lookup is performed to obtain the IP address of the SMTP server.
- If the LDAP routing query returns a single hostname with a port, the SMTP route is used, but the port returned by the LDAP query is used over any ports specified in SMTP routes. If the SMTP routes only lists the destination host as the hostname, a DNS lookup is performed to obtain the IP address of the SMTP server.
- If the LDAP routing query returns multiple hosts with or without ports, SMTP routes are applied, but the ports returned by the LDAP routing query are used over those present in SMTP routes. If the SMTP routes only lists the destination host as the hostname, a DNS lookup is performed to obtain the IP address of the SMTP server.

## Bypassing SMTP Call-Ahead Validation for Certain Users or Groups

You may want to enable SMTP call-ahead validation on a listener but skip the SMTP call-ahead validation for certain users or groups of users.

You may want to skip SMTP call-ahead validation for recipients for whom mail should not be delayed during SMTP call-ahead queries. For example, you could add a RAT entry for a customer service alias that you know is valid and will likely need immediate attention.

To configure bypassing SMTP call-ahead validation via the GUI, select **Bypass SMTP Call-Ahead** when you add or edit the RAT entry



## CHAPTER 29

# Encrypting Communication with Other MTAs

This chapter contains the following sections:

- [Overview of Encrypting Communication with Other MTAs, on page 671](#)
- [Working with Certificates, on page 672](#)
- [Enabling TLS on a Listener's HAT, on page 677](#)
- [Enabling TLS and Certificate Verification on Delivery, on page 680](#)
- [DNS-based Authentication of Named Entities, on page 683](#)
- [Managing Lists of Certificate Authorities, on page 687](#)
- [Enabling a Certificate for HTTPS, on page 690](#)

## Overview of Encrypting Communication with Other MTAs

Enterprise Gateways (or Message Transfer Agents, i.e. MTAs) normally communicate “in the clear” over the Internet. That is, the communications are not encrypted. In several scenarios, malicious agents can intercept this communication without the knowledge of the sender or the receiver. Communications can be monitored and even altered by a third party.

Transport Layer Security (TLS) is an improved version of the Secure Socket Layer (SSL) technology. It is a widely used mechanism for encrypting SMTP conversations over the Internet. AsyncOS supports the STARTTLS extension to SMTP (Secure SMTP over TLS), described in RFC 3207 (which obsoletes RFC 2487).

The TLS implementation in AsyncOS provides privacy through encryption. It allows you to import an X.509 certificate and private key from a certificate authority service or create a self-signed certificate to use on the email gateway. AsyncOS supports separate TLS certificates for public and private listeners, secure HTTP (HTTPS) management access on an interface, the LDAP interface, and all outgoing TLS connections.

### Related Topics

- [How to Encrypt SMTP Conversations using TLS, on page 671](#)

## How to Encrypt SMTP Conversations using TLS

How to Encrypt SMTP Conversations using TLS

	Do This	More Info
Step 1	Obtain an X.509 certificate and private key from a recognized certificate authority.	<a href="#">Working with Certificates, on page 672</a>
Step 2	Install the certificate on the email gateway	Install a certificate by either: <ul style="list-style-type: none"> <li>• <a href="#">Creating a Self-Signed Certificate , on page 674</a></li> <li>• <a href="#">Importing a Certificate , on page 676</a></li> </ul>
Step 3	Enable TLS for receiving messages, delivering messages, or both	<ul style="list-style-type: none"> <li>• <a href="#">Enabling TLS on a Listener's HAT, on page 677</a></li> <li>• <a href="#">Enabling TLS and Certificate Verification on Delivery, on page 680</a></li> </ul>
Step 4	(Optional) Customize the list of trusted certificate authorities that the appliance uses to verify a certificate from a remote domain to establish the domain's credentials.	<a href="#">Managing Lists of Certificate Authorities, on page 687</a>
Step 5	(Optional) Configure the email gateway to send an alert when it's unable to deliver messages to a domain that requires a TLS connection.	<a href="#">Sending Alerts When a Required TLS Connection Fails, on page 682</a>

## Working with Certificates

To use TLS, the email gateway must have an X.509 certificate and matching private key for receiving and delivery. You may use the same certificate for both SMTP receiving and delivery and different certificates for HTTPS services on an interface, the LDAP interface, and all outgoing TLS connections to destination domains, or use one certificate for all of them.

You can view the entire list of certificates on the Network > Certificates page in the web interface and in the CLI by using the print command after you configure the certificates using certconfig . Note that the print command does not display intermediate certificates.



---

**Caution** Your email gateway ships with a demonstration certificate to test the TLS and HTTPS functionality, but enabling either service with the demonstration certificate is not secure and is not recommended for general use. When you enable either service with the default demonstration certificate, a warning message is printed in the CLI.

---

### Related Topics

- [Deploying a Signed Certificate , on page 673](#)
- [Deploying Self-Signed Certificates , on page 673](#)



## Deploying a Signed Certificate

Use a signed certificate when you cannot exchange self-signed certificates between the email gateway and the other machine, for example because that machine is not in your domain. Your corporate security department may have other requirements.

	Do This	More Info
Step 1	If you are deploying in a cluster, follow instructions.	<a href="#">Certificates and Centralized Management, on page 674</a>
Step 2	Generate a self-signed certificate and Certificate Signing Request (CSR).	<a href="#">Creating a Self-Signed Certificate , on page 674</a>
Step 3	Send the generated certificate to a recognized Certificate Authority for signing.	<a href="#">About Sending a Certificate Signing Request (CSR) to a Certificate Authority , on page 675</a>
Step 4	Upload the signed certificate.	<a href="#">Uploading a Certificate Signed by a Certificate Authority , on page 676</a>
Step 5	Ensure that the certificate authority that signed the certificate is on the list of trusted authorities.	<a href="#">Managing Lists of Certificate Authorities, on page 687</a>
Step 6	If applicable, use an intermediate certificate.	<a href="#">Intermediate Certificates, on page 674</a>

## Deploying Self-Signed Certificates

You can generally use self-signed certificates for communications between email gateways that are behind your corporate firewall. Your corporate security department may have other requirements.

	Do This	More Info
Step 1	If you are deploying in a cluster, follow instructions.	<a href="#">Certificates and Centralized Management, on page 674</a>
Step 2	Generate a self-signed certificate from the email gateway.	<a href="#">Creating a Self-Signed Certificate , on page 674</a>
Step 3	Export the self-signed certificate.	<a href="#">Exporting a Certificate , on page 677</a>
Step 4	Import the self-signed certificate to the machine with which the email gateway will communicate.	See the documentation for the other machine.
Step 5	Generate and export a self-signed certificate from the other machine.	See the documentation for the other machine.

	Do This	More Info
Step 6	Import the self-signed certificate from the other machine into the email gateway.	<a href="#">Importing a Certificate</a> , on page 676 or See the chapter in this guide for configuring communication with that machine.  For example, to configure secure communications with a Cisco AMP Threat Grid Appliance, see instructions for configuring Advanced settings in <a href="#">Configuring an On-Premises File Analysis Server</a> , on page 482.

## Certificates and Centralized Management

A certificate usually uses the local machine's hostname for the certificate's common name. If your email gateways are part of a cluster, you will need to import a certificate for each cluster member as the machine level, with the exception of a wild card certificate or a Subject Alternative Name (SAN) certificate that you can install at the cluster level. Each cluster member's certificate must use the same certificate name so the cluster can refer to it when a member's listener is communicating with another machine.

## Intermediate Certificates

In addition to root certificate verification, AsyncOS supports the use of intermediate certificate verification. Intermediate certificates are certificates issued by a trusted root certificate authority which are then used to create additional certificates - effectively creating a chained line of trust. For example, a certificate may be issued by godaddy.com who, in turn, is granted the rights to issue certificates by a trusted root certificate authority. The certificate issued by godaddy.com must be validated against godaddy.com's private key as well as the trusted root certificate authority's private key.

## Creating a Self-Signed Certificate

You might want to create a self-signed certificate on the email gateway for any of the following reasons:

- To encrypt SMTP conversations with other MTAs using TLS (both inbound and outbound conversations).
- To enable the HTTPS service on the email gateway for accessing the GUI using HTTPS.
- Use as a client certificate for LDAPS if the LDAP server asks for a client certificate.
- To allow secure communication between the email gateway and a Cisco AMP Threat Grid Appliance.

To create a self-signed certificate using the CLI, use the certconfig command.

### Procedure

- 
- Step 1** Select **Network > Certificates**.
- Step 2** Click **Add Certificate**.
- Step 3** Select **Create Self-Signed Certificate**.
- Step 4** Enter the following information for the self-signed certificate:

<b>Common Name</b>	<b>The fully qualified domain name.</b>
Organization	The exact legal name of the organization.

Common Name	The fully qualified domain name.
Organizational Unit	Section of the organization.
City (Locality)	The city where the organization is legally located.
State (Province)	The state, county, or region where the organization is legally located.
Country	The two letter ISO abbreviation of the country where the organization is legally located.
Duration before expiration	The number of days before the certificate expires.
Private Key Size	Size of the private key to generate for the CSR. Only 2048-bit and 1024-bit are supported.

**Step 5** Click **Next**.

**Step 6** Select the **FQDN Validation** check box to allow the email gateway to check whether the 'Common Name present in the certificate is in the FQDN format.

**Step 7** Enter a name for the certificate. By default, AsyncOS assigns the common name previously entered.

**Step 8** If you will submit this certificate as a Certificate Signing Request (CSR), click **Download Certificate Signing Request** to save the CSR in PEM format to a local or network machine.

**Step 9** Submit and commit your changes.

### What to do next

See the appropriate next step:

- [Deploying a Signed Certificate](#) , on page 673
- [Deploying Self-Signed Certificates](#) , on page 673

## About Sending a Certificate Signing Request (CSR) to a Certificate Authority

A certificate authority is a third-party organization or company that issues digital certificates used to verify identity and distributes public keys. This provides an additional level of assurance that the certificate is issued by a valid and trusted identity. You may purchase certificates and private keys from a recognized certificate authority. Cisco does not recommend one service over another.

The email gateway can create a self-signed certificate and generate a Certificate Signing Request (CSR) to submit to a certificate authority to obtain the public certificate. The certificate authority will return a trusted public certificate signed by a private key. Use the **Network > Certificates** page in the web interface or the `certconfig` command in the CLI to create the self-signed certificate, generate the CSR, and install the trusted public certificate.

If you are acquiring or creating a certificate for the first time, search the Internet for “certificate authority services SSL Server Certificates,” and choose the service that best meets the needs of your organization. Follow the service’s instructions for obtaining a certificate.

### What To Do Next

See [Deploying a Signed Certificate](#) , on page 673.

## Uploading a Certificate Signed by a Certificate Authority

When the certificate authority returns the trusted public certificate signed by a private key, upload the certificate to the email gateway.

You can use the certificate with a public or private listener, an IP interface's HTTPS services, the LDAP interface, or all outgoing TLS connections to destination domains.

### Procedure

- 
- Step 1** Make sure that the trusted public certificate that you receive is in PEM format or a format that you can convert to PEM using before uploading to the email gateway. (Tools for doing this are included with OpenSSL, free software from <http://www.openssl.org>.)
- Step 2** Upload the signed certificate to the email gateway:
- Note** Uploading the certificate from the certificate authority overwrites the existing self-signed certificate.
- Select **Network > Certificates**.
  - Click the name of the certificate that you sent to the Certificate Authority for signing.
  - Enter the path to the file on your local machine or network volume.
- Step 3** You can also upload an intermediate certificate related to the self-signed certificate.
- 

### What to do next

#### Related Topics

- [Deploying a Signed Certificate](#) , on page 673

## Importing a Certificate

AsyncOS also allows you to import certificates from other machines that are saved in the PKCS #12 format to use on your email gateway.

To import a certificate using the CLI, use the `certconfig` command.



- 
- Note** If you are deploying a signed certificate, do not use this procedure to import the signed certificate. Instead, see [Uploading a Certificate Signed by a Certificate Authority](#) , on page 676 .
- 

### Procedure

- 
- Step 1** Select **Network > Certificates**.
- Step 2** Click **Add Certificate**.
- Step 3** Select the **Import Certificate** option.
- Step 4** Enter the path to the certificate file on your network or local machine.
- Step 5** Enter the passphrase for the file.
- Step 6** Click **Next** to view the certificate's information.

- Step 7** Select the **FQDN Validation** check box to allow the email gateway to check whether the 'Common Name,' 'SAN: DNS Name' fields, or both present in the certificate, are in the FQDN format.
- Step 8** Enter a name for the certificate.  
AsyncOS assigns the common name by default.
- Step 9** Submit and commit your changes.
- 

#### What to do next

- If you are deploying self-signed certificates, see [Deploying Self-Signed Certificates](#) , on page 673.

## Exporting a Certificate

AsyncOS also allows you to export certificates and save them in the PKCS #12 format.



---

**Note** If you are deploying a signed certificate, do not use this procedure to generate a Certificate Signing Request (CSR). Instead, see [Deploying a Signed Certificate](#) , on page 673.

---

#### Procedure

---

- Step 1** Navigate to the **Network > Certificates** page.
- Step 2** Click **Export Certificate**.
- Step 3** Select the certificate you want to export.
- Step 4** Enter the file name for the certificate.
- Step 5** Enter and confirm the passphrase for the certificate file.
- Step 6** Click **Export**.
- Step 7** Save the file to a local or network machine.
- Step 8** You can export additional certificates or click **Cancel** to return to the Network > Certificates page.
- 

#### What to do next

- If you are deploying self-signed certificates, see [Deploying Self-Signed Certificates](#) , on page 673.

## Enabling TLS on a Listener's HAT

You must enable TLS for any listeners where you require encryption. You may want to enable TLS on listeners facing the Internet (that is, public listeners), but not for listeners for internal systems (that is, private listeners). Or, you may want to enable encryption for all listeners.

You can specify the following settings for TLS on a listener.

Table 53: TLS Settings for a Listener

TLS Setting	Meaning
1. No	TLS is not allowed for incoming connections. No connections to the listener will require encrypted SMTP conversations. This is the default setting for all listeners you configure on the email gateway.
2. Preferred	TLS is allowed for incoming connections to the listener from MTAs.
3. Required	TLS is allowed for incoming connections to the listener from MTAs, and until a <code>STARTTLS</code> command is received, the email gateway responds with an error message to every command other than <code>NOOP</code> , <code>EHLO</code> , or <code>QUIT</code> . This behavior is specified by RFC 3207, which defines the SMTP Service Extension for Secure SMTP over Transport Layer Security. “Requiring” TLS means that email which the sender is not willing to encrypt with TLS will be refused by the email gateway before it is sent, thereby preventing it from being transmitted in the clear.

By default, neither private nor public listeners allow TLS connections. You must enable TLS in a listener’s HAT to enable TLS for either inbound (receiving) or outbound (sending) email. In addition, all default mail flow policy settings for private and public listeners have the `tls` setting set to “off.”

You can assign a specific certificate for TLS connections to individual public listeners when creating a listener. For more information, see [Listening for Connection Requests by Creating a Listener Using Web Interface](#), on page 71.

#### Related Topics

- [Assigning a Certificate to a Public or Private Listener for TLS Connections Using the GUI](#), on page 678
- [Assigning a Certificate to a Public or Private Listener for TLS Connections Using the CLI](#), on page 679
- [Logging](#), on page 683
- [GUI Example: Changing the TLS setting for Listeners HAT](#), on page 679
- [CLI Example: Changing the TLS Setting for Listeners HAT](#), on page 679

## Assigning a Certificate to a Public or Private Listener for TLS Connections Using the GUI

### Procedure

- 
- Step 1** Navigate to the Network > Listeners page.
  - Step 2** Click the name of the Listener to edit.
  - Step 3** In the Certificate field, choose a certificate.
  - Step 4** Submit and commit your changes.
-

## Assigning a Certificate to a Public or Private Listener for TLS Connections Using the CLI

### Procedure

---

- Step 1** Use the `listenerconfig -> edit` command to choose a listener you want to configure.
- Step 2** Use the `certificate` command to see the available certificates.
- Step 3** Choose the certificate you want to assign to the listener when prompted.
- Step 4** When you are finished configuring the listener, issue the `commit` command to enable the change.
- 

## Logging

The Email Security appliance will note in the mail logs instances when TLS is required but could not be used by the listener. The mail logs will be updated when the following conditions are met:

- TLS is set to “required” for a listener.
- The Email Security appliance has sent a “Must issue a STARTTLS command first” command.
- The connection is closed without having received any successful recipients.

Information on why the TLS connection failed will be included in the mail logs.

## GUI Example: Changing the TLS setting for Listeners HAT

### Procedure

---

- Step 1** Navigate to the Mail Policies > Mail Flow Policies page.
- Step 2** Choose a listener whose policies you want to modify, and then click the link for the name of policy to edit. (You can also edit the Default Policy Parameters.)
- Step 3** In the “Encryption and Authentication” section, for the “TLS:” field, choose the level of TLS you want for the listener.
- Step 4** Submit and commit your changes
- The mail flow policy for the listener is updated with the TLS setting you chose
- 

## CLI Example: Changing the TLS Setting for Listeners HAT

### Procedure

---

- Step 1** Use the `listenerconfig -> edit` command to choose a listener you want to configure.

**Step 2** Use the `hostaccess -> default` command to edit the listener's default HAT settings.

**Step 3** Change the TLS setting by entering one of the following choices when you are prompted with the following questions:

```
Do you want to allow encrypted TLS connections?
```

1. No
2. Preferred
3. Required

```
[1]> 3
```

```
You have chosen to enable TLS. Please use the 'certconfig' command to ensure that there is a valid certificate configured.
```

**Step 4** Note that this example asks you to use the `certconfig` command to ensure that there is a valid certificate that can be used with the listener. If you have not created any certificates, the listener uses the demonstration certificate that is pre-installed on the email gateway. You may enable TLS with the demonstration certificate for testing purposes, but it is not secure and is not recommended for general use. Use the `listenerconfig -> edit -> certificate` command to assign a certificate to the listener. Once you have configured TLS, the setting will be reflected in the summary of the listener in the CLI.

```
Name: Inboundmail
```

```
Type: Public
```

```
Interface: PublicNet (192.168.2.1/24) TCP Port 25
```

```
Protocol: SMTP
```

```
Default Domain:
```

```
Max Concurrency: 1000 (TCP Queue: 50)
```

```
Domain map: disabled
```

```
TLS: Required
```

**Step 5** Issue the `commit` command to enable the change

## Enabling TLS and Certificate Verification on Delivery

You can require that TLS is enabled for email delivery to specific domains using the Destination Controls page or the `destconfig` command.

In addition to TLS, you can require that the domain's server certificate is verified. This domain verification is based on a digital certificate used to establish the domain's credentials. The validation process involves four validation requirements:

- The chain of issuer certificates for the SMTP session ends in a certificate issued by a trusted certificate authority (CA)
- The Common Name (CN) listed on the certificate matches either the receiving machine's DNS name or the message's destination domain.



-or-

The message's destination domain matches one of the DNS names in the certificate's Subject Alternative Name (subjectAltName) extension, as described in RFC 2459. The matching supports wildcards as described in section 3.1 of RFC 2818.

- [Optional - Only if FQDN validation enabled in SSL Configuration settings]: Check whether the 'Common Name,' 'SAN: DNS Name' fields, or both present in the server certificate, are in the FQDN format.
- [Optional - Only if X 509 validation enabled in SSL Configuration settings]: Check for the signature algorithm of the server certificate.

A trusted CA is a third-party organization or company that issues digital certificates used to verify identity and distributes public keys. This provides an additional level of assurance that the certificate is issued by a valid and trusted identity.

You can configure your email gateway to send messages to a domain over a TLS connection as an alternative to envelope encryption. See the “Cisco Email Encryption” chapter for more information.

You can specify a certificate for the email gateway to use for all outgoing TLS connections. To specify the certificate, click **Edit Global Settings** on the Destination Controls page or use `destconfig -> setup` in the CLI. The certificate is a global setting, not a per-domain setting.

You can specify 5 different settings for TLS for a given domain when you include a domain using the Destination Controls page or the `destconfig` command. In addition to specifying whether exchanges with a domain are required or preferred to be TLS encoded, you can dictate whether validation of the domain is necessary. See the following table for an explanation of the settings:

**Table 54: TLS Settings for Delivery**

TLS Setting	Meaning
Default	The default TLS setting set using the Destination Controls page or the <code>destconfig -&gt; default</code> subcommand used for outgoing connections from the listener to the MTA for the domain.  The value “Default” is set if you answer “no” to the question: “Do you wish to apply a specific TLS setting for this domain?”
1. No	TLS is not negotiated for outgoing connections from the interface to the MTA for the domain.
2. Preferred	TLS is negotiated from the email gateway interface to the MTA(s) for the domain. However, if the TLS negotiation fails (prior to receiving a 220 response), the SMTP transaction does not fall back to clear text. No attempt is made to verify if the certificate originates from a trusted certificate authority. If an error occurs and the TLS negotiation fails after the 220 response is received, the SMTP transaction will continue "in the clear" (not encrypted).
3. Required	TLS is negotiated from the email gateway interface to MTA(s) for the domain. No attempt is made to verify the domain’s certificate. If the negotiation fails, no email is sent through the connection. If the negotiation succeeds, the mail is delivered via an encrypted session.

TLS Setting	Meaning
4. Preferred (Verify)	<p>TLS is negotiated from the email gateway to the MTA(s) for the domain. The email gateway attempts to verify the domain's certificate.</p> <p>Three outcomes are possible:</p> <ul style="list-style-type: none"> <li>• TLS is negotiated and the certificate is verified. The mail is delivered via an encrypted session.</li> <li>• TLS is negotiated, but the certificate is not verified. The mail is delivered via an encrypted session.</li> <li>• No TLS connection is made and, subsequently the certificate is not verified. The email message is delivered in plain text.</li> </ul>
5. Required (Verify)	<p>TLS is negotiated from the email gateway to the MTA(s) for the domain. Verification of the domain certificate is required. The following outcomes are possible:</p> <ul style="list-style-type: none"> <li>• A TLS connection is negotiated and the certificate is verified. The email message is delivered via an encrypted session.</li> <li>• A TLS connection is negotiated, but the certificate is not verified by a trusted Certificate Authority (CA). The mail is not delivered.</li> <li>• A TLS connection is not negotiated. The mail is not delivered.</li> </ul>
6. Required - Verify Hosted Domains	<p>The difference between TLS Required - Verify and TLS Required - Verify Hosted Domain options lays in identity verification process. The way how the presented identity is processed and what type of reference identifiers are allowed to be used make a difference about a final result.</p> <p>The presented identity is first derived from <code>subjectAltName</code> extension of type <code>dNSName</code>. If there is no match between the <code>dNSName</code> and one of accepted reference identities (<code>REF-ID</code>), the verification fails no matter if <code>CN</code> exist in subject field and could pass further identity verification. The <code>CN</code> derived from subject field is validated only when the certificate does not contain any of <code>subjectAltName</code> extension of type <code>dNSName</code>.</p>

If there is no specific entry for a given recipient domain in the good neighbor table, or if there is a specific entry but there is no specific TLS setting for the entry, then the behavior is whatever is set using the Destination Controls page or the `destconfig -> default` subcommand (“No,” “Preferred,” “Required,” “Preferred (Verify),” or “Required (Verify)”).

### Related Topics

- [Sending Alerts When a Required TLS Connection Fails, on page 682](#)
- [Logging, on page 683](#)
- [Managing Lists of Certificate Authorities, on page 687](#)

## Sending Alerts When a Required TLS Connection Fails

You can specify whether the email gateway sends an alert if the TLS negotiation fails when delivering messages to a domain that requires a TLS connection. The alert message contains name of the destination domain for the failed TLS negotiation. The email gateway sends the alert message to all recipients set to receive Warning

severity level alerts for System alert types. You can manage alert recipients via the System Administration > Alerts page in the GUI (or via the `alertconfig` command in the CLI).

### Related Topics

- [Enabling TLS Connection Alerts](#) , on page 683

## Enabling TLS Connection Alerts

### Procedure

---

- Step 1** Navigate to the Mail Policies Destination Controls page.
- Step 2** Click **Edit Global Settings**.
- Step 3** Click **Enable** for “Send an alert when a required TLS connection fails.”

This is a global setting, not a per-domain setting. For information on the messages that the email gateway attempted to deliver, use the Monitor > Message Tracking page or the mail logs.

- Step 4** Submit and commit your changes.
- 

### What to do next

You can also configure this in the command-line interface using the `destconfig -> setup` command to enable TLS connection alerts using the CLI

## Logging

The email gateway will note in the mail logs instances when TLS is required for a domain but could not be used. Information on why the TLS connection could not be used will be included. The mail logs will be updated when any of the following conditions are met:

- The remote MTA does not support ESMTP (for example, it did not understand the EHLO command from the email gateway).
- The remote MTA supports ESMTP but “STARTTLS” was not in the list of extensions it advertised in its EHLO response.
- The remote MTA advertised the “STARTTLS” extension but responded with an error when the email gateway sent the STARTTLS command.

## DNS-based Authentication of Named Entities

- [Overview of SMTP DNS-based Authentication of Named Entities](#), on page 684
- [Enabling TLS for Delivery with DANE Support](#), on page 686
- [Sending Alerts When DANE Fails](#), on page 687

## Overview of SMTP DNS-based Authentication of Named Entities

TLS connections that are authenticated using certificates can become vulnerable to a security breach in any one of the following ways:

- A trusted Certificate Authority (CA) can issue certificates to any domain name.
- An attacker can use a man-in-the-middle (MITM) attack to downgrade a TLS connection to plain text communication.
- If DNSSEC is not configured on the DNS server, an attacker can forge a DNS response with fake DNS MX records and redirect messages to an insecure server which can lead to DNS cache poisoning attacks.
- Self-signed certificates or certificates issued by a private Certificate Authority (CA) can be used when a receiving Mail Transfer Agent (MTA) is not configured with a list of trusted Certificate Authority.

The SMTP DNS-based Authentication of Named Entities (DANE) protocol validates your X.509 certificates with DNS names using a Domain Name System Security (DNSSEC) extension configured on your DNS server and a DNS resource record, also known as a TLSA record.

The TLSA record is added in the certificate that contains details about either the Certificate Authority (CA), the end entity certificate, or the trust anchor used for the DNS name described in *RFC 6698*. For more information, see [Creating TLSA Record, on page 685](#). The Domain Name System Security (DNSSEC) extensions provide added security on the DNS by addressing vulnerabilities in DNS security. DNSSEC using cryptographic keys and digital signatures ensures that the lookup data is correct and connects to legitimate servers.

The following are the benefits of using SMTP DANE for outgoing TLS connections:

- Provides secure delivery of messages by preventing Man-in-the-Middle (MITM) downgrade attacks, eavesdropping and DNS cache poisoning attacks.
- Provides authenticity of TLS certificates and DNS information, when secured by DNSSEC.

### Related Topics

- [SMTP DANE Workflow, on page 684](#)
- [Creating TLSA Record, on page 685](#)
- [Enabling TLS for Delivery with DANE Support, on page 686](#)
- [Sending Alerts When DANE Fails, on page 687](#)

## SMTP DANE Workflow

The following figure describes flow of messages using outgoing TLS connection with DANE support:

Figure 45: Message Delivery Using TLS with DANE Support

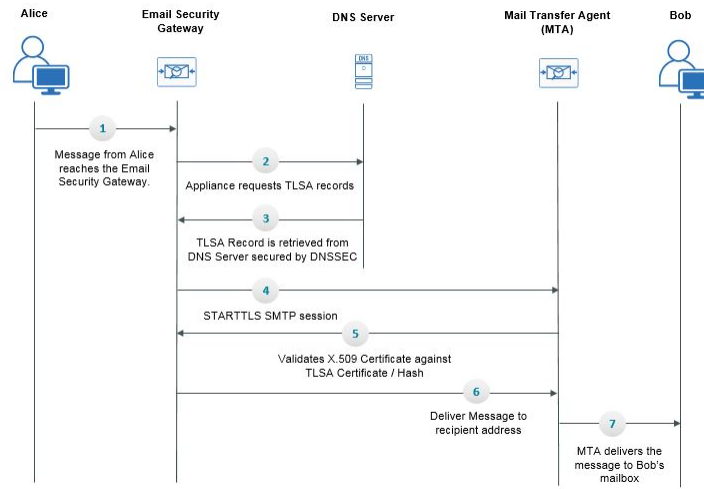

1. Sender (Alice) sends a message to a recipient (Bob) outside the organization.
2. The message reaches the email gateway.
3. The email gateway requests for a DNS resource record, also known as a TLSA record of the DNS from the DNS server.
4. The certificates and a TLSA record is retrieved from the DNS server, secured by DNSSEC.
5. The email gateway establishes a STARTTLS SMTP session to the recipient's address.
6. The X.509 certificates are validated against the complete TLSA record or hash value of the TLSA record, of the recipient's address. After successful validation, the message is delivered to the recipient's Mail Transfer Agent (MTA). If certificate verification fails, the message is delivered at a later time or the message is bounced.
7. The MTA delivers the message to recipient's mailbox.

## Creating TLSA Record

You can create a TLSA record of your preferred certificate authority (CA) on the DNS record signed with DNSSEC. Below is a sample TLSA record for a Fully Qualified Domain Name (FQDN) `www.example.com`:

```

_443._tcp.www.example.com. IN TLSA (0 0 1
91751cee0a1ab8414400238a761411daa29643ab4b8243e9a91649e25be53ada)
  
```

The above example TLSA record has the following fields that are encrypted:

- **Certificate Usage:** Specifies the type of certificate.
  - In the given sample, the first '0' digit specifies the CA certificate that must be matched to the PKIX certification path, as described in RFC 6698.
  - If it is '1', it specifies the end entity certificate that must be matched to the end entity certificate given by the server in TLS.

- If it is '2', it specifies a certificate that must be used as a trust anchor while validating the end entity certificate given by the server in TLS.
- If it is '3', it specifies a certificate that must match the end entity certificate given by the server in TLS.
- **Selector Field:** Specifies the part of TLS certificate that is matched with the association data.
  - In the given sample, the second '0' specifies that the full certificate must be matched.
  - If it is '1', it specifies that only the 'SubjectPublicKeyInfo' field must be matched.
- **Matching Type:** Specifies the type of HASH value that is used.
  - In the given sample, the third '1' specifies the SHA-256 hash of the selected content.
  - If it is '0', it specifies the exact match on the selected content.
  - If it is '2' it specifies the SHA-512 hash of the selected content.

## Enabling TLS for Delivery with DANE Support

### Before you begin

- Ensure that the envelope sender and the TLSA resource record is DNSSEC verified.
- Ensure that you enable TLS to configure DANE on your email gateway. For more information, see [Enabling TLS and Certificate Verification on Delivery, on page 680](#).

### Procedure

- Step 1** Go to **Mail Policies > Destination Controls** page.
- Step 2** Click **Add Destination Controls** or modify an existing entry.
- Step 3** From the **TLS Support** field, you must select **Preferred, Required** or **Mandatory** to enable DANE support on your email gateway.
- Step 4** From the **DANE Support** field, you can specify the following settings for DANE for a given TLS connection.

DANE Setting	Description
Default	The default DANE setting set using the Destination Controls page is used for outgoing TLS connections from the listener to the MTA for the domain.  The "Default" DANE setting is inherited from the default TLS settings in Destination Controls. You can override this setting to the custom Destination Control entry.
None	Select "None", if you do not want DANE to be used for negotiating outgoing connections from the interface to the MTA for the domain.

DANE Setting	Description
Opportunistic	<p>If you select "Opportunistic" and the remote host does not support DANE, opportunistic TLS is used for encrypting SMTP conversations.</p> <p>If you select "Opportunistic" and the remote host supports DANE, it becomes the preferred mode for encrypting SMTP conversations.</p>
Mandatory	<p>If you select "Mandatory" and the remote host does not support DANE, no connection is established to the destination host.</p> <p>If you select "Mandatory" and the remote host supports DANE, it becomes the preferred mode for encrypting SMTP conversations.</p>

**Step 5** Submit and Commit your changes.

## Sending Alerts When DANE Fails

You can specify whether the email gateway sends an alert if the DANE verification fails to all MX hosts when delivering messages to a domain that requires a TLS connection with DANE support. The email gateway sends the alert message to all recipients set to receive Warning severity level alerts for System alert types.

### Enabling DANE Alerts

#### Procedure

- Step 1** Go to **System Administration > Alerts** page.
- Step 2** Select the alert recipient you want to enable the alert.
- Step 3** Select the **Message Delivery** check box corresponding to the alert type.
- Step 4** Submit and commit your changes.

## Managing Lists of Certificate Authorities

The email gateway uses stored trusted certificate authorities that it uses to verify a certificate from a remote domain to establish the domain's credentials. You can configure the email gateway to use the following trusted certificate authorities:

- **Pre-installed list.** The email gateway has a pre-installed list of trusted certificate authorities. This is called the system list.
- **User-defined list.** You can customize a list of trusted certificate authorities and then import the list onto the email gateway.

You can use either the system list or the customized list, and you can also use both lists to verify certificate from a remote domain.

Manage the lists using the Network > Certificates > Edit Certificate Authorities page in the GUI or the certconfig > certauthority command in the CLI.

On the Network > Certificates > Edit Certificate Authorities page, you can perform the following tasks:

- **View the system list (pre-installed) of certificate authorities.** For more information, see [Viewing the Pre-Installed list of Certificate Authorities, on page 688](#).
- **Choose whether or not to use the system list.** You can enable or disable the system list. For more information, see [Disabling the System Certificate Authority List, on page 688](#).
- **Choose whether or not to use a custom certificate authority list.** You can enable the email gateway to use a custom list and then import the list from a text file. For more information, see [Importing a Custom Certificate Authority List, on page 689](#).
- **Export the list of certificate authorities to a file.** You can export either the system or customized list of certificate authorities to a text file. For more information, see [Exporting a Certificate Authorities List, on page 689](#).

#### Related Topics

- [Viewing the Pre-Installed list of Certificate Authorities, on page 688](#)
- [Disabling the System Certificate Authority List, on page 688](#)
- [Importing a Custom Certificate Authority List, on page 689](#)
- [Exporting a Certificate Authorities List, on page 689](#)
- [Certificate Updates, on page 690](#)
- [Managing Trusted Root Certificates, on page 690](#)

## Viewing the Pre-Installed list of Certificate Authorities

### Procedure

---

- Step 1** Navigate to the Network > Certificates page.
  - Step 2** Click **Edit Settings** in the Certificate Authorities section.
  - Step 3** Click **View System Certificate Authorities**.
- 

## Disabling the System Certificate Authority List

The pre-installed system certificate authorities list cannot be removed from the email gateway, but you can enable or disable it. You might want to disable it to allow the email gateway to only use your custom list to verify certificates from remote hosts.

### Procedure

---

- Step 1** Navigate to the Network > Certificates page.



- Step 2** Click **Edit Settings** in the Certificate Authorities section.
  - Step 3** Click **Disable** for the System List.
  - Step 4** Submit and commit your changes.
- 

## Importing a Custom Certificate Authority List

You can create a custom of list trusted certificate authorities and import it onto the email gateway. The file must be in the PEM format and include certificates for the certificate authorities that you want the email gateway to trust.

### Procedure

---

- Step 1** Navigate to the Network > Certificates page.
  - Step 2** Click **Edit Settings** in the Certificate Authorities section.
  - Step 3** Click **Enable** for the Custom List.
  - Step 4** Enter the full path to the custom list on a local or network machine.
  - Step 5** Select the **FQDN Validation** check box to allow the email gateway to check whether the 'Common Name,' 'SAN: DNS Name' fields, or both present in the certificate, are in the FQDN format.
  - Step 6** Submit and commit your changes.
- 

## Exporting a Certificate Authorities List

If you want to use only a subset of the trusted certificate authorities in the system or edit an existing custom list, you can export the list to a .txt file and edit it to add or remove certificate authorities. After you have finished editing the list, import the file back onto the email gateway as a custom list.

### Procedure

---

- Step 1** Navigate to the Network > Certificates page.
  - Step 2** Click **Edit Settings** in the Certificate Authorities section.
  - Step 3** Click **Export List**.  
AsyncOS displays the Export Certificate Authority List page.
  - Step 4** Select the list you want to export.
  - Step 5** Enter a filename for the list.
  - Step 6** Click **Export**.  
AsyncOS displays a dialog box asking if want to open or save the list as a .txt file.
-

## Certificate Updates

The Updates section under Certificate Lists displays the version and last-updated information for the Cisco trusted-root-certificate (system CA certificate) bundle on the email gateway. The bundle is updated periodically.

Click **Update Now** on the Certificates page to update the existing Cisco trusted-root-certificate (system CA certificate) bundle to the latest available version.

## Managing Trusted Root Certificates

You can view the count and details of the following certificates in your email gateway:

- Custom Trusted Root (custom CA) certificates
- Cisco Trusted Root (system CA) certificates

### Procedure

---

- Step 1** Navigate to **Network > Certificates** page.
- Step 2** Click **Manage Trusted Root Certificates** under the Certificate Lists section to view the details of the custom or system CA certificates.
- Step 3** Click the required certificate link (for example, 'Admin-Root-CA') under the Cisco Trusted Root Certificate List section to view the certificate details.
- Step 4** [Optional] Click the **Download Certificate** link below the certificate (for example, 'Admin-Root-CA') details to download the certificate.

**Note** You can also click the required certificate link under the Custom Trusted Root Certificates List section to view or download the certificate details.

**Note** You can also delete a Custom Trusted Root (custom CA) certificate, if required.

---

## Enabling a Certificate for HTTPS

You can enable a certificate for HTTPS services on an IP interface using either the **Network > IP Interfaces** page in the GUI or the `interfaceconfig` command in the CLI.

### Procedure

---

- Step 1** Navigate to the **Network > IP Interfaces** page.
- Step 2** Select the interface you want to enable the HTTPS service.
- Step 3** Under Appliance Management, check the **HTTPS** check box and enter the port number.
- Step 4** Submit and commit your changes.
-

### What to do next



---

**Note** The demonstration certificate that is pre-installed on the email gateway. You may enable HTTPS services with the demonstration certificate for testing purposes, but it is not secure and is not recommended for general use.

You can enable HTTPS services using the System Setup Wizard in the GUI. For more information, see [Setup and Installation, on page 13](#).

---





## CHAPTER 30

# Configuring Routing and Delivery Features

This chapter contains the following sections:

- [Routing Email for Local Domains, on page 693](#)
- [Rewriting Addresses, on page 698](#)
- [Creating Alias Tables, on page 699](#)
- [Configuring Masquerading, on page 706](#)
- [The Domain Map Feature, on page 716](#)
- [Directing Bounced Email, on page 722](#)
- [Controlling Email Delivery Using Destination Controls, on page 730](#)
- [Bounce Verification, on page 739](#)
- [Set Email Delivery Parameters, on page 742](#)
- [Configuring Mail Gateways for all Hosted Domains Using Virtual Gateway™ Technology, on page 745](#)
- [Using Global Unsubscribe, on page 754](#)
- [Review: Email Pipeline, on page 757](#)

## Routing Email for Local Domains

In [Configuring the Gateway to Receive Email, on page 65](#) you customized private and public listeners to service SMTP connections for an Enterprise Gateway configuration. Those listeners were customized to handle specific connections (via HAT modification) and receive mail for specific domains (via RAT modification of public listeners).

The email gateway routes mail to local domains to hosts specified via the **Network > SMTP Routes** page (or the `smtproutes` command). This feature is similar to the `sendmail mailertable` feature.



**Note** If you have completed the GUI's System Setup Wizard (or the Command Line Interface `systemsetup` command) as described in the "Setup and Installation" chapter and committed the changes, you defined the first SMTP route entries on the email gateway for each RAT entry you entered at that time.

### Related Topics

- [SMTP Routes Overview, on page 694](#)
- [Default SMTP Route, on page 694](#)

- [Defining an SMTP Route, on page 695](#)
- [SMTP Routes Limits, on page 695](#)
- [SMTP Routes and DNS, on page 695](#)
- [SMTP Routes and Alerts, on page 696](#)
- [SMTP Routes, Mail Delivery, and Message Splintering, on page 696](#)
- [SMTP Routes and Outbound SMTP Authentication, on page 696](#)
- [Managing SMTP Routes to Send Outbound Email Using the GUI, on page 696](#)

## SMTP Routes Overview

SMTP Routes allow you to redirect all email for a particular domain to a different mail exchange (MX) host. For example, you could make a mapping from `example.com` to `groupware.example.com`. This mapping causes any email with `@example.com` in the Envelope Recipient address to go instead to `groupware.example.com`. The system performs an “MX” lookup on `groupware.example.com`, and then performs an “A” lookup on the host, just like a normal email delivery. This alternate MX host does not need to be listed in DNS MX records and it does not even need to be a member of the domain whose email is being redirected. The AsyncOS operating system allows up to forty thousand (40,000) SMTP Route mappings to be configured for your email gateway. (See [SMTP Routes Limits, on page 695](#))

This feature also allows host “globbing.” If you specify a partial domain, such as `.example.com`, then any domain ending in `example.com` matches the entry. For instance, `fred@foo.example.com` and `wilma@bar.example.com` both match the mapping.

If a host is not found in the SMTP Routes table, an MX lookup is performed using DNS. The result is not re-checked against the SMTP Routes table. If the DNS MX entry for `foo.domain` is `bar.domain`, any email sent to `foo.domain` is delivered to the host `bar.domain`. If you create a mapping for `bar.domain` to some other host, email addressed to `foo.domain` is not affected.

In other words, recursive entries are not followed. If there is an entry for `a.domain` to redirect to `b.domain`, and a subsequent entry to redirect email for `b.domain` to `a.domain`, a mail loop will *not* be created. In this case, email addressed to `a.domain` will be delivered to the MX host specified by `b.domain`, and conversely email addressed to `b.domain` will be delivered to the MX host specified by `a.domain`.

The SMTP Routes table is read from the top down for every email delivery. The most specific entry that matches a mapping wins. For example, if there are mappings for both `host1.example.com` and `.example.com` in the SMTP Routes table, the entry for `host1.example.com` will be used because it is the more specific entry — even if it appears after the less specific `.example.com` entry. Otherwise, the system performs a regular MX lookup on the domain of the Envelope Recipient.

## Default SMTP Route

You can also define a default SMTP route with the special keyword `ALL`. If a domain does not match a previous mapping in the SMTP Routes list, it defaults to being redirected to the MX host specified by the `ALL` entry.

When you print the SMTP Routes entries, the default SMTP route is listed as `ALL:`. You cannot delete the default SMTP route; you may only clear any values entered for it.

Configure the default SMTP route via the Network > SMTP Routes page or the `smtproutes` command.

## Defining an SMTP Route

Use the Network > SMTP Routes page (or the `smtproutes` command) to construct routes. When you create a new route, you first specify the domain or partial domain for which you want to create a permanent route. You then specify destination hosts. Destination hosts can be entered as fully-qualified hostnames or as IP addresses. IP addresses can be either Internet Protocol version 4 (IPv4) or version 6 (IPv6).

For IPv6 addresses, AsyncOS supports the following formats:

- `2620:101:2004:4202::0-2620:101:2004:4202::ff`
- `2620:101:2004:4202::`
- `2620:101:2004:4202::23`
- `2620:101:2004:4202::/64`

You can also specify a special destination host of `/dev/null` to drop the messages that match the entry. (So, in effect, specifying `/dev/null` for the default route will ensure that no mail received by the email gateway is ever delivered.)

A receiving domain can have multiple destination hosts, each assigned a priority number, much like an MX record. The destination host with the lowest number identifies as the primary destination host for the receiving domain. Other destination hosts listed will be used as backup.

Destinations with identical priority will be used in a “round-robin” fashion. The round-robin process is based on SMTP connections, and is not necessarily message-based. Also, if one or more of the destination hosts are not responding, messages will be delivered to one of the reachable hosts. If all the configured destination hosts are not responding, mail is queued for the receiving domain and delivery to the destination hosts is attempted later. (It does not fail over to using MX records).

When constructing routes using the `smtproutes` command in the CLI, you can prioritize each destination host by using `/pri=`, followed by an integer between 0 and 65535 to assign priority (0 is the highest priority) after the hostname or IP address. For example, `host1.example.com/pri=0` has a higher priority than `host2.example.com/pri=10`. Separate multiple entries with commas.

## SMTP Routes Limits

You can define up to 40,000 routes. The final default route of ALL is counted as a route against this limit. Therefore, you can define up to 39,999 custom routes and one route that uses the special keyword ALL.

## SMTP Routes and DNS

Use the special keyword USEDNS to tell the email gateway to do MX lookups to determine next hops for specific domains. This is useful when you need to route mail for subdomains to a specific host. For example, if mail to `example.com` is to be sent to the company’s Exchange server, you might have something similar to the following SMTP route:

```
example.com exchange.example.com
```

However, for mail to various subdomains (`foo.example.com`), add an SMTP route that looks like this:

```
.example.com USEDNS
```

## SMTP Routes and Alerts

Alerts sent from the email gateway to addresses specified in the System Administration > Alerts page (or the alertconfig command) follow SMTP Routes defined for those destinations.

## SMTP Routes, Mail Delivery, and Message Splintering

**Incoming:** if one message has 10 recipients and they are all on the same Exchange server, AsyncOS will open one TCP connection and present exactly one message to the mail store, not 10 separate messages.

**Outgoing:** works similarly, but if one message is going to 10 recipients in 10 different domains, AsyncOS will open 10 connections to 10 MTAs and deliver them one email each.

**Splintering:** if one incoming message has 10 recipients and they are each in separate Incoming Policy groups (10 groups), the message will splinter even if all 10 recipients are on the same Exchange server. Thus, 10 separate emails will be delivered over a single TCP connection.

## SMTP Routes and Outbound SMTP Authentication

If an Outbound SMTP Authentication profile has been created, you can apply it to an SMTP Route. This allows authentication for outgoing mail in cases where the email gateway sits behind a mail relay server that is at the edge of the network. For more information about Outbound SMTP Authentication, see [Outgoing SMTP Authentication, on page 807](#).

## Managing SMTP Routes to Send Outbound Email Using the GUI

Use the Network > SMTP Routes page to manage SMTP Routes on your email gateway. You can add, modify, and delete mappings in the table. You can export or import the SMTP Routes entries.

### Related Topics

- [Adding SMTP Routes, on page 696](#)
- [Exporting SMTP Routes, on page 697](#)
- [Importing SMTP Routes, on page 697](#)

## Adding SMTP Routes

### Procedure

- 
- Step 1** Click **Add Route** on the Network > SMTP Routes page.
- Step 2** Enter a receiving domain. This can be a hostname, domain, IPv4 address, or IPv6 address.
- Step 3** Enter a destination host. This can be a hostname, IPv4 address, or IPv6 address. You can add multiple destination hosts by clicking **Add Row** and entering the next destination host in the new row.
- Note** You can specify a port number by adding “:<port number>” to the destination host: example.com:25.
- Step 4** If you add multiple destination hosts, enter an integer between 0 and 65535 to assign priority to the hosts. 0 is the highest priority. See [Defining an SMTP Route, on page 695](#) for more information.



- Step 5** Submit and commit your changes.
- 

## Exporting SMTP Routes

Similar to the Host Access Table (HAT) and the Recipient Access Table (RAT), you can also modify SMTP routes mappings by exporting and importing a file. To export the SMTP Routes:

### Procedure

---

- Step 1** Click **Export SMTP Routes** on the SMTP Routes page.
- Step 2** Enter a name for the file and click **Submit**.
- 

## Importing SMTP Routes

Similar to the Host Access Table (HAT) and the Recipient Access Table (RAT), you can also modify SMTP routes mappings by exporting and importing a file. To import SMTP Routes:

### Procedure

---

- Step 1** Click **Import SMTP Routes** on the SMTP Routes page.
- Step 2** Select the file that contains the exported SMTP Routes.
- Step 3** Click **Submit**. You are warned that importing will replace all existing SMTP Routes. All of the SMTP Routes in the text file are imported.
- Step 4** Click **Import**.

You can place “comments” in the file. Lines that begin with a ‘#’ character are considered comments and are ignored by AsyncOS. For example:

```
# this is a comment, but the next line is not  
ALL:
```

---

### What to do next

At this point, our Email Gateway configuration looks like this:

Figure 46: SMTP Routes Defined for a Public Listener

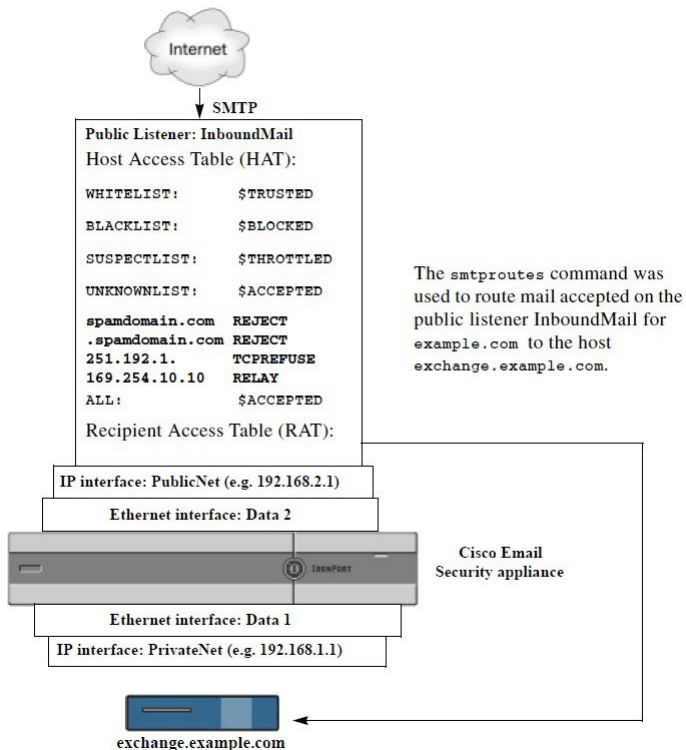

## Rewriting Addresses

AsyncOS provides several methods for rewriting Envelope Sender and Recipient addresses in the email pipeline. Rewriting addresses can be used, for example, to redirect mail sent to a partner domain or to hide (“mask”) your internal infrastructure.

The following table provides an overview of the various features used for rewriting sender and recipient email addresses.

Table 55: Methods for Rewriting Addresses

Original Address	Change to	Feature	Works on
*@anydomain	user@domain	Alias Tables (see <a href="#">Creating Alias Tables, on page 699</a> )	<ul style="list-style-type: none"> <li>Envelope Recipients only</li> <li>Applied globally</li> <li>Maps aliases to email addresses or other aliases</li> </ul>
*@olddomain	*@newdomain	Domain Mapping (see <a href="#">The Domain Map Feature, on page 716</a> )	<ul style="list-style-type: none"> <li>Envelope Recipients only</li> <li>Applied per listener</li> </ul>

Original Address	Change to	Feature	Works on
*@olddomain	*@newdomain	Masquerading (see <a href="#">Configuring Masquerading, on page 706</a> )	<ul style="list-style-type: none"> <li>Envelope Sender and the To:, From:, and/or CC: headers</li> <li>Applied per listener</li> </ul>

## Creating Alias Tables

Alias tables provide a mechanism to redirect messages to one or more recipients. You can construct a mapping table of aliases to usernames and other aliases in a similar fashion to the `/etc/mail/aliases` feature of a sendmail configuration on some Unix systems.

When the Envelope Recipient (also known as the Envelope To, or `RCPT TO`) of an email accepted by a listener matches an alias as defined in an alias table, the Envelope Recipient address of the email will be rewritten.



**Note** A listener checks the alias table and modifies the recipients *after* checking the RAT and *before* message filters. See the “Understanding the Email Pipeline” chapter.



**Note** The Alias Table functionality actually rewrites the Envelope Recipient of the email. This is different than the `smtproutes` command (see [Directing Bounced Email, on page 722](#)), which does not rewrite the Envelope Recipient of the email, but instead simply reroutes the email to specified domains.

### Related Topics

- [Configuring an Alias Table from the Command Line, on page 699](#)
- [Exporting and Importing an Alias Table, on page 700](#)
- [Deleting Entries from the Alias Table, on page 701](#)

## Configuring an Alias Table from the Command Line

Alias tables are defined in sections as follows: each section is headed by a domain context, which is a list of domains that the section is relevant to, followed by a list of maps.

A domain context is a list of one or more domains or partial domains, separated by commas and enclosed in square brackets ('[ ' and ' ]'). A domain is a string containing letters, digits hyphens, and periods as defined in RFC 1035, section 2.3.1., “Preferred name syntax.” A partial domain, such as `.example.com` is a domain that begins with a period. All domains that end with a substring matching the partial domain are considered a match. For example, the domain context `.example.com` would match `mars.example.com` and `venus.example.com`. Below the domain context is a list of maps, which are aliases followed by a list of recipients. A map is constructed as follows:

Table 56: Alias Table Syntax

Left-hand Side (LHS)	Separator	Right-hand Side (RHS)
a list of one or more aliases to match	the colon character (“ : ”)	a list of one or more recipient addresses or aliases

An alias in the **left-hand side** can contain the following formats:

<code>username</code>	Specifies an alias to match. There must be a preceding “domains” attribute specified in the table. The lack of this parameter will produce an error.
<code>user@domain</code>	Specifies an exact email address to match on.

You can enter multiple aliases, separated by commas on a single left-hand side line.

Each recipient in the **right-hand side** can be a full `user@domain` email address, or another alias.

An alias file can contain “global” aliases (aliases that are applied globally instead of to a specific domain) with no implied domain, domain contexts within which aliases have one or more implied domains, or both.

“Chains” (or recursive entries) of aliases may be created, but they must end in a full email address.

A special destination of `/dev/null` is supported to drop the message in order to be compatible with context of a sendmail configuration. If a message is mapped to `/dev/null` via an alias table, the dropped counter is increased. (See the “Managing and Monitoring via the CLI” chapter.) The recipient is accepted but not enqueued.

#### Related Topics

- [Example Alias Table, on page 701](#)
- [Example aliasconfig Command, on page 703](#)

## Exporting and Importing an Alias Table

To import an alias table, first see [FTP, SSH, and SCP Access, on page 1303](#) to ensure that you can access the email gateway.

Use the `export` subcommand of the `aliasconfig` command to save any existing alias table. A file (whose name you specify) will be written to the `/configuration` directory for the listener. You can modify this file outside of the CLI and then re-import it. (If you have malformed entries in the file, errors are printed when you try to import the file.)

Place the alias table file in the `/configuration` directory, and then use the `import` subcommand of the `aliasconfig` command to upload the file.

Comment out lines in the table using a number symbol (`#`) at the beginning of each line.

Remember to issue the `commit` command after you import an alias table file so that the configuration changes take effect.

## Deleting Entries from the Alias Table

If you delete entries from the alias table from the command line interface (CLI), you are prompted to choose a domain group first. Choose the “ALL (any domain)” entry to see a numbered list of aliases that apply to all domains. Then choose the number(s) of the aliases you want to delete.

### Example Alias Table



---

**Note** All entries in this example table have been commented out.

---

```
# sample Alias Table file

# copyright (c) 2001-2005, IronPort Systems, Inc.

#

# Incoming Envelope To addresses are evaluated against each
# entry in this file from top to bottom. The first entry that
# matches will be used, and the Envelope To will be rewritten.

#

# Separate multiple entries with commas.

#

# Global aliases should appear before the first domain
# context. For example:

#

# admin@example.com: administrator@example.com
# postmaster@example.net: administrator@example.net
#

# This alias has no implied domain because it appears
# before a domain context:

#

# someaddr@somewhere.dom: specificperson@here.dom

#

# The following aliases apply to recipients @ironport.com and
# any subdomain within .example.com because the domain context
# is specified.

#

# Email to joe@ironport.com or joe@foo.example.com will
```

```
# be delivered to joseph@example.com.
#
# Similarly, email to fred@mx.example.com will be
# delivered to joseph@example.com
#
# [ironport.com, .example.com]
#
# joe, fred: joseph@example.com
#
# In this example, email to partygoers will be sent to
# three addresses:
#
# partygoers: wilma@example.com, fred@example.com, barney@example.com
#
# In this example, mail to help@example.com will be delivered to
# customercare@otherhost.dom. Note that mail to help@ironport.com will
# NOT be processed by the alias table because the domain context
# overrides the previous domain context.
#
# [example.com]
#
# help: customercare@otherhost.dom
#
# In this example, mail to nobody@example.com is dropped.
#
# nobody@example.com: /dev/null
#
# "Chains" may be created, but they must end in an email address.
# For example, email to "all" will be sent to 9 addresses:
#
# [example.com]
#
```

```
# all: sales, marketing, engineering
# sales: joe@example.com, fred@example.com, mary@example.com
# marketing:bob@example.com, advertising
# engineering:betty@example.com, miles@example.com, chris@example.com
# advertising:richard@example.com, karen@advertising.com
```

## Example aliasconfig Command

In this example, the `aliasconfig` command is used to construct an alias table. First, the domain context of **example.com** is specified. Then, an alias of **customer** is constructed so that any email sent to `customer@example.com` is redirected to `bob@example.com`, `frank@example.com`, and `sally@example.com`. Next, a global alias of **admin** is constructed so that an email sent to `admin` is redirected to `administrator@example.com`. Finally, the alias table is printed to confirm.

Note that when the table is printed, the global alias for `admin` appears *before* the first domain context of `example.com`.

```
mail3.example.com> aliasconfig

No aliases in table.

Choose the operation you want to perform:

- NEW - Create a new entry.
- IMPORT - Import aliases from a file.

[ ]> new

How do you want your aliases to apply?

1. Globally
2. Add a new domain context

[1]> 2

Enter new domain context.

Separate multiple domains with commas.

Partial domains such as .example.com are allowed.

[ ]> example.com

Enter the alias(es) to match on.

Separate multiple aliases with commas.

Allowed aliases:

- "user" - This user in this domain context.
- "user@domain" - This email address.
```

```
[ ]> customercare

Enter address(es) for "customercare".

Separate multiple addresses with commas.

[ ]> bob@example.com, frank@example.com, sally@example.com

Adding alias customercare: bob@example.com,frank@example.com,sally@example.com

Do you want to add another alias? [N]> n

There are currently 1 mappings defined.

Choose the operation you want to perform:

- NEW - Create a new entry.
- EDIT - Modify an entry.
- DELETE - Remove an entry.
- PRINT - Display the table.
- IMPORT - Import aliases from a file.
- EXPORT - Export table to a file.
- CLEAR - Clear the table.

[ ]> new

How do you want your aliases to apply?

1. Globally
2. Add a new domain context
3. example.com

[1]> 1

Enter the alias(es) to match on.

Separate multiple aliases with commas.

Allowed aliases:

- "user@domain" - This email address.
- "user" - This user for any domain
- "@domain" - All users in this domain.
- "@.partialdomain" - All users in this domain, or any of its sub domains.

[ ]> admin

Enter address(es) for "admin".

Separate multiple addresses with commas.
```



```
[ ]> administrator@example.com
Adding alias admin: administrator@example.com
Do you want to add another alias? [N]> n

There are currently 2 mappings defined.
Choose the operation you want to perform:
- NEW - Create a new entry.
- EDIT - Modify an entry.
- DELETE - Remove an entry.
- PRINT - Display the table.
- IMPORT - Import aliases from a file.
- EXPORT - Export table to a file.
- CLEAR - Clear the table.

[ ]> print
admin: administrator@example.com
[ example.com ]
customercare: bob@example.com, frank@example.com, sally@example.com

There are currently 2 mappings defined.
Choose the operation you want to perform:
- NEW - Create a new entry.
- EDIT - Modify an entry.
- DELETE - Remove an entry.
- PRINT - Display the table.
- IMPORT - Import aliases from a file.
- EXPORT - Export table to a file.
- CLEAR - Clear the table.

[ ]>
```

At this point, our Email Gateway configuration looks like this:

Figure 47: Alias Tables Defined for the Email Gateway

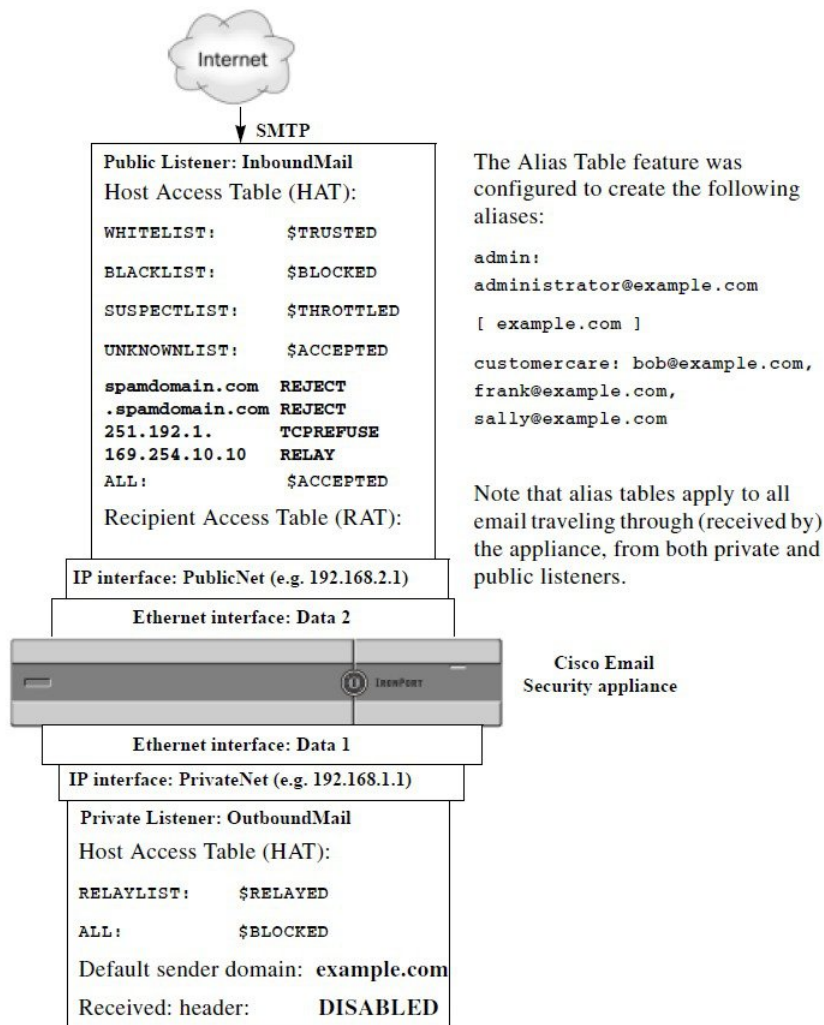

## Configuring Masquerading

Masquerading is a feature that rewrites the Envelope Sender (also known as the sender, or MAIL FROM) and the To:, From:, and/or CC: headers on email processed by a listener according to a table that you construct. A typical example implementation of this feature is “Virtual Domains,” which allows you to host multiple domains from a single site. Another typical implementation is “hiding” your network infrastructure by “stripping” the subdomains from strings in email headers. The Masquerading feature is available for both private and public listeners.



**Note** The Masquerading feature is configured on a per-listener basis, as opposed to the Alias Tables functionality, which is configured for the entire system.

A listener checks the masquerading table for matches and modifies the recipients while the message is in the work queue, immediately after LDAP recipient acceptance queries and before LDAP routing queries. See the “Understanding the Email Pipeline” chapter.

The Masquerading feature actually rewrites addresses for the Envelope Sender and the To:, From:, and CC: fields of the email that has been received. You can specify different masquerading parameters for each listener you create in one of two ways:

- via a static table of mappings you create
- via an LDAP query.

This section discusses the static table method. The table format is forward-compatible with the `/etc/mail/genericstable` feature of a sendmail configuration on some Unix systems. See [LDAP Queries, on page 771](#) for more information on LDAP masquerading queries.

#### Related Topics

- [Masquerading and altsrghost, on page 707](#)

## Masquerading and altsrghost

Generally, the masquerading feature rewrites the Envelope Sender, and any subsequent actions to be performed on the message will be “triggered” from the masqueraded address. However, when you run the `altsrghost` command from the CLI, the `altsrghost` mappings are triggered from the original address (and not the modified, masqueraded address).

For more information, see [Configuring Mail Gateways for all Hosted Domains Using Virtual Gateway™ Technology, on page 745](#) and [Review: Email Pipeline, on page 757](#).

#### Related Topics

- [Configuring Static Masquerading Tables, on page 707](#)
- [Sample Masquerading Table for a Private Listener, on page 708](#)
- [Importing a Masquerading Table , on page 709](#)
- [Example Masquerading , on page 709](#)

## Configuring Static Masquerading Tables

You configure the static masquerading table of mappings by using the `edit -> masquerade` subcommand of the `listenerconfig` command. Alternatively, you can import a file containing the mappings. See [Importing a Masquerading Table , on page 709](#). The subcommand creates and maintains a table that maps input addresses, usernames, and domains to new addresses and domains. See [LDAP Queries, on page 771](#) for more information on LDAP masquerading queries.

When messages are injected into the system, the table is consulted, and the message is rewritten if a match in the header is found.

A domain masquerading table is constructed as follows:

Table 57: Masquerading Table Syntax

Left-hand Side (LHS)	Separator	Right-hand Side (RHS)
a list of one or more usernames and/or domains to match	whitespace (space or tab character)	the rewritten username and/or domain

The following table lists valid entries in the masquerading table:

Left-hand Side (LHS)	Right-hand Side (RHS)
username	username@domain
This entry specifies a username to match. Incoming email messages matching a username on the left-hand side are matched and rewritten with the address on the right-hand side. The right-hand side must be a full address.	
user@domain	username@domain
The entry specifies an exact address to match. Incoming messages matching a full address on the left-hand side are rewritten with the address listed on the right-hand side. The right-hand side must be a full address.	
@domain	@domain
This entry specifies any address with the specified domain. The original domain on the left-hand side is replaced with the domain in the right-hand side, leaving the username intact.	
@.partialdomain	@domain
This entry specifies any address with the specified domain. The original domain on the left-hand side is replaced with the domain in the right-hand side, leaving the username intact.	
ALL	@domain
The ALL entry matches bare addresses and rewrites them with the address on the right-hand side. The right-hand side must be a domain preceded by an “@”. This entry always has the lowest precedence regardless of its location in the table.	
<b>Note</b>	You can use the ALL entry for private listeners only.

- Rules are matched by the order in which they appear in the masquerading table.
- Addresses in the From:, To:, and CC: fields in the headers are matched and rewritten upon receiving by default. You can also configure the option to match and rewrite the Envelope Sender. Enable and disable the Envelope Sender and which headers to rewrite using the config subcommand.
- You can comment out lines in the table using a number symbol (#) at the beginning of each line. Everything following a # to the end of the line will be considered a comment and ignored.
- A masquerading table is limited to 400,000 entries, whether you create them via the new subcommand or import them from a file.

## Sample Masquerading Table for a Private Listener

```
# sample Masquerading file

@example.com @example.com # Hides local subdomains in the header
```

```

sales sales_team@success.com

@techsupport tech_support@biggie.com

user@localdomain user@company.com

ALL @bigsender.com

```

## Importing a Masquerading Table

A traditional `sendmail /etc/mail/genericstable` file can be imported. To import a `genericstable` file, first see [FTP, SSH, and SCP Access, on page 1303](#) to ensure that you can access the email gateway.

Place the `genericstable` file in the configuration directory, and then use the `import` subcommand of the `masquerade` subcommand to upload the file. Use the commands in this order:

```
listenerconfig -> edit -> listener_number -> masquerade -> import
```

Alternatively, you can use the `export` subcommand to download the existing configuration. A file (whose name you specify) will be written to the configuration directory. You can modify this file outside of the CLI and then import it again.

When you use the `import` subcommand, ensure that the file contains only valid entries. If there is an invalid entry (for example, a left-hand side with no right-hand side), the CLI reports syntax errors when you import the file. If there is a syntax error during import, no mappings in the entire file are imported.

Remember to issue the `commit` command after you import a `genericstable` file so that the configuration changes for the listener take effect.

## Example Masquerading

In this example, the `masquerade` subcommand of `listenerconfig` is used to construct a domain masquerading table for the private listener named “OutboundMail” on the PrivateNet interface.

First, the option to use LDAP for masquerading is declined. (For information on configuring LDAP masquerading queries, see [LDAP Queries, on page 771](#) for more information on LDAP masquerading queries.)

Then, a partial domain notation of `@.example.com` is mapped to `@example.com` so that any email sent from any machine in the subdomain of `.example.com` will be mapped to `example.com`. Then, the username `joe` is mapped to the domain `joe@example.com`. The domain masquerading table is then printed to confirm both entries, and then exported to a file named `masquerade.txt`. The `config` subcommand is used to disable re-writing addresses in the CC: field, and finally, the changes are committed.

```

mail3.example.com> listenerconfig

Currently configured listeners:

1. InboundMail (on PublicNet, 192.168.2.1) SMTP TCP Port 25 Public
2. OutboundMail (on PrivateNet, 192.168.1.1) SMTP TCP Port 25 Private

Choose the operation you want to perform:

- NEW - Create a new listener.
- EDIT - Modify a listener.
- DELETE - Remove a listener.
- SETUP - Change global settings.

```

```
[ ]> edit

Enter the name or number of the listener you wish to edit.

[ ]> 2

Name: OutboundMail

Type: Private

Interface: PrivateNet (192.168.1.1/24) TCP Port 25

Protocol: SMTP

Default Domain:

Max Concurrency: 600 (TCP Queue: 50)

Domain Map: Disabled

TLS: No

SMTP Authentication: Disabled

Bounce Profile: Default

Footer: None

LDAP: Off

Choose the operation you want to perform:

- NAME - Change the name of the listener.

- INTERFACE - Change the interface.

- LIMITS - Change the injection limits.

- SETUP - Configure general options.

- HOSTACCESS - Modify the Host Access Table.

- BOUNCECONFIG - Choose the bounce profile to use for messages injected on this
listener.

- MASQUERADE - Configure the Domain Masquerading Table.

- DOMAINMAP - Configure domain mappings.

- LDAPACCEPT - Configure an LDAP query to determine whether a recipient address should
be accepted or bounced/dropped.

- LDAPROUTING - Configure an LDAP query to reroute messages.

- LDAPGROUP - Configure an LDAP query to determine whether a sender or
recipient is in a specified group.

- SMTPAUTH - Configure an SMTP authentication.

[ ]> masquerade

Do you want to use LDAP for masquerading? [N]> n
```

```
Domain Masquerading Table
```

```
There are currently 0 entries.
```

```
Masqueraded headers: To, From, Cc
```

```
Choose the operation you want to perform:
```

- NEW - Create a new entry.
- DELETE - Remove an entry.
- PRINT - Display all entries.
- IMPORT - Import all entries from a file.
- EXPORT - Export all entries to a file.
- CONFIG - Configure masqueraded headers.
- CLEAR - Remove all entries.

```
[> new
```

```
Enter the source address or domain to masquerade.
```

```
Usernames like "joe" are allowed.
```

```
Full addresses like "user@example.com" are allowed.
```

```
Full addresses with subdomain wildcards such as "username@.company.com" are allowed.
```

```
Domains like @example.com and @.example.com are allowed.
```

```
Hosts like @training and @.sales are allowed.
```

```
[> @.example.com
```

```
Enter the masqueraded address or domain.
```

```
Domains like @example.com are allowed.
```

```
Full addresses such as user@example.com are allowed.
```

```
[> @example.com
```

```
Entry mapping @.example.com to @example.com created.
```

```
Domain Masquerading Table
```

```
There are currently 1 entries.
```

```
Masqueraded headers: To, From, Cc
```

```
Choose the operation you want to perform:
```

- NEW - Create a new entry.
- DELETE - Remove an entry.
- PRINT - Display all entries.

- IMPORT - Import all entries from a file.
- EXPORT - Export all entries to a file.
- CONFIG - Configure masqueraded headers.
- CLEAR - Remove all entries.

```
[> new
```

Enter the source address or domain to masquerade.

Username like "joe" are allowed.

Full addresses like "user@example.com" are allowed.

Full addresses with subdomain wildcards such as "username@.company.com" are allowed.

Domains like @example.com and @.example.com are allowed.

Hosts like @training and @.sales are allowed.

```
[> joe
```

Enter the masqueraded address.

Only full addresses such as user@example.com are allowed.

```
[> joe@example.com
```

Entry mapping joe to joe@example.com created.

Domain Masquerading Table

There are currently 2 entries.

Masqueraded headers: To, From, Cc

Choose the operation you want to perform:

- NEW - Create a new entry.
- DELETE - Remove an entry.
- PRINT - Display all entries.
- IMPORT - Import all entries from a file.
- EXPORT - Export all entries to a file.
- CONFIG - Configure masqueraded headers.
- CLEAR - Remove all entries.

```
[> print
```

```
@.example.com @example.com
```

```
joe joe@example.com
```

Domain Masquerading Table



```
There are currently 2 entries.
Masqueraded headers: To, From, Cc
Choose the operation you want to perform:
- NEW - Create a new entry.
- DELETE - Remove an entry.
- PRINT - Display all entries.
- IMPORT - Import all entries from a file.
- EXPORT - Export all entries to a file.
- CONFIG - Configure masqueraded headers.
- CLEAR - Remove all entries.

[ ]> export
Enter a name for the exported file:
[ ]> masquerade.txt
Export completed.
Domain Masquerading Table
There are currently 2 entries.
Masqueraded headers: To, From, Cc
Choose the operation you want to perform:
- NEW - Create a new entry.
- DELETE - Remove an entry.
- PRINT - Display all entries.
- IMPORT - Import all entries from a file.
- EXPORT - Export all entries to a file.
- CONFIG - Configure masqueraded headers.
- CLEAR - Remove all entries.

[ ]> config
Do you wish to masquerade Envelope Sender?
[ N ]> y
Do you wish to masquerade From headers?
[ Y ]> y
Do you wish to masquerade To headers?
[ Y ]> y
```

```
Do you wish to masquerade CC headers?
[Y]> n
Do you wish to masquerade Reply-To headers?
[Y]> n
Domain Masquerading Table
There are currently 2 entries.
- NEW - Create a new entry.
- DELETE - Remove an entry.
- PRINT - Display all entries.
- IMPORT - Import all entries from a file.
- EXPORT - Export all entries to a file.
- CONFIG - Configure masqueraded headers.
- CLEAR - Remove all entries.
[]>
Name: OutboundMail
Type: Private
Interface: PrivateNet (192.168.1.1/24) TCP Port 25
Protocol: SMTP
Default Domain:
Max Concurrency: 600 (TCP Queue: 50)
Domain Map: Disabled
TLS: No
SMTP Authentication: Disabled
Bounce Profile: Default
Footer: None
LDAP: Off
Choose the operation you want to perform:
- NAME - Change the name of the listener.
- INTERFACE - Change the interface.
- LIMITS - Change the injection limits.
- SETUP - Configure general options.
- HOSTACCESS - Modify the Host Access Table.
```

- BOUNCECONFIG - Choose the bounce profile to use for messages injected on this listener.
- MASQUERADE - Configure the Domain Masquerading Table.
- DOMAINMAP - Configure domain mappings.
- LDAPACCEPT - Configure an LDAP query to determine whether a recipient address should be accepted or bounced/dropped.
- LDAPROUTING - Configure an LDAP query to reroute messages.
- LDAPGROUP - Configure an LDAP query to determine whether a sender or recipient is in a specified group.
- SMTPAUTH - Configure an SMTP authentication.

[ ]>

Currently configured listeners:

1. InboundMail (on PublicNet, 192.168.2.1) SMTP TCP Port 25 Public
2. OutboundMail (on PrivateNet, 192.168.1.1) SMTP TCP Port 25 Private

Choose the operation you want to perform:

- NEW - Create a new listener.
- EDIT - Modify a listener.
- DELETE - Remove a listener.
- SETUP - Change global settings.

[ ]>

Our Enterprise Gateway configuration now looks like this:

Figure 48: Masquerading Defined for a Private Listener

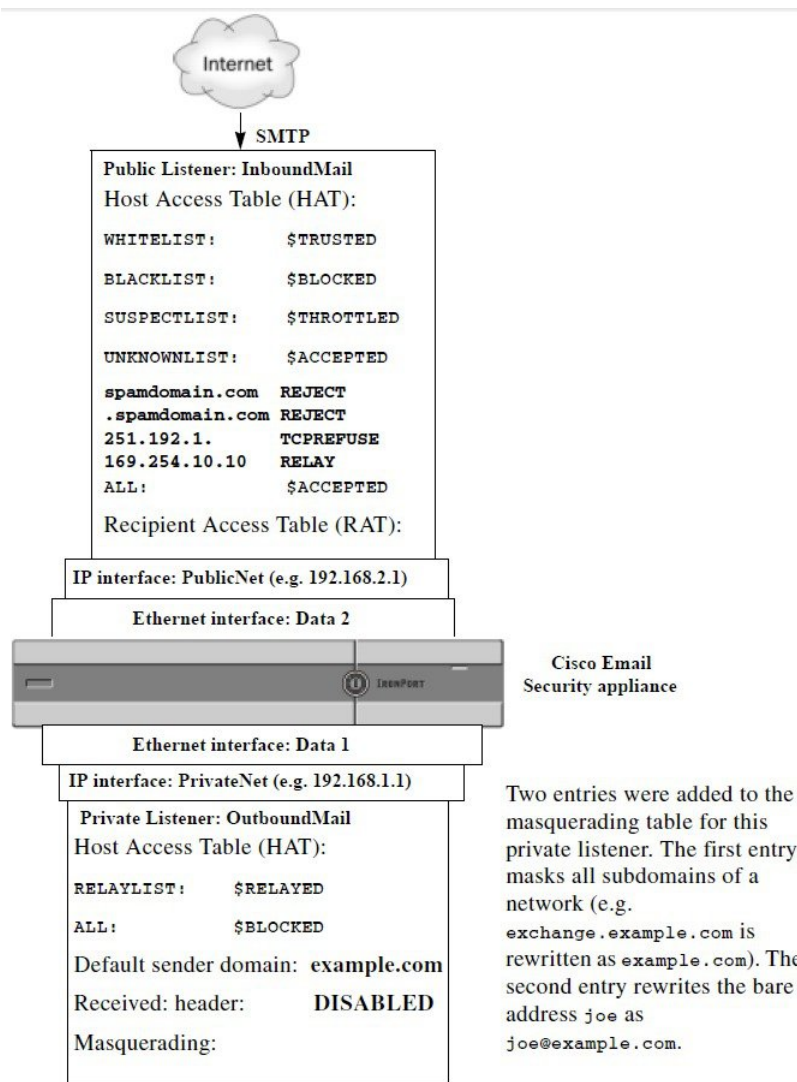

## The Domain Map Feature

You can configure a “domain map” for listeners. For each listener you configure, you can construct a domain map table which rewrites the Envelope Recipient for each recipient in a message that matches a domain in the domain map table. This feature is similar to the sendmail “Domain Table” or Postfix “Virtual Table” feature. Only the Envelope Recipient is affected; the “To:” headers are not re-written by this feature.



**Note** The processing of the domain map feature happens immediately before the RAT and right after Default Domain is evaluated. See the “Understanding the Email Pipeline” chapter.

A common implementation of the domain map feature is to accept incoming mail for more than one legacy domain. For example, if your company has acquired another company, you could construct a domain map on the email gateway to accept messages for the acquired domain and rewrite the Envelope Recipients to your company's current domain.



**Note** You can configure up to 20,000 separate, unique domain mappings.

**Table 58: Domain Map Table Example Syntax**

Left Side	Right Side	Comments
username@example.com	<b>username2@example.net</b>	Only complete address for the right side
user@.example.com	<b>user2@example.net</b>	
@example.com	<b>user@example.net</b> <i>or</i> <b>@example.net</b>	Complete address or fully-qualified domain name.
@.example.com	<b>user@example.net</b> <i>or</i> <b>@example.net</b>	

In the following example, the `domainmap` subcommand of the `listenerconfig` command is used to create a domain map for the public listener “InboundMail.” Mail for the domain and any subdomain of `oldcompanyname.com` is mapped to the domain `example.com`. The mapping is then printed for confirmation. Contrast this example with the configuration of placing both domains in the listener's RAT: the domain map feature will actually rewrite the Envelope Recipient of `joe@oldcomapanyname.com` to `joe@example.com`, whereas placing the domain `oldcompanyname.com` in the listener's RAT will simply accept the message for `joe@oldcompanyname.com` and route it without rewriting the Envelope Recipient. Also, contrast this example with the alias table feature. Alias tables *must* resolve to an explicit address; they cannot be constructed to map “*any username @domain*” to “*the same username @newdomain*.”

```
mail3.example.com> listenerconfig
```

```
Currently configured listeners:
```

1. Inboundmail (on PublicNet, 192.168.2.1) SMTP TCP Port 25 Public
2. Outboundmail (on PrivateNet, 192.168.1.1) SMTP TCP Port 25 Private

```
Choose the operation you want to perform:
```

- NEW - Create a new listener.
- EDIT - Modify a listener.
- DELETE - Remove a listener.
- SETUP - Change global settings.

```
[ ]> edit

Enter the name or number of the listener you wish to edit.

[ ]> 1

Name: InboundMail
Type: Public
Interface: PublicNet (192.168.2.1/24) TCP Port 25
Protocol: SMTP
Default Domain:
Max Concurrency: 1000 (TCP Queue: 50)
Domain Map: Disabled
TLS: No
SMTP Authentication: Disabled
Bounce Profile: Default
Use SenderBase For Reputation Filters and IP Profiling: Yes
Footer: None
LDAP: Off

Choose the operation you want to perform:

- NAME - Change the name of the listener.
- INTERFACE - Change the interface.
- LIMITS - Change the injection limits.
- SETUP - Configure general options.
- HOSTACCESS - Modify the Host Access Table.
- RCPTACCESS - Modify the Recipient Access Table.
- BOUNCECONFIG - Choose the bounce profile to use for messages injected on this
listener.
- MASQUERADE - Configure the Domain Masquerading Table.
- DOMAINMAP - Configure domain mappings.

[ ]> domainmap

Domain Map Table

There are currently 0 Domain Mappings.

Domain Mapping is: disabled

Choose the operation you want to perform:

- NEW - Create a new entry.
```

```
- IMPORT - Import domain mappings from a file.

[]> new

Enter the original domain for this entry.
Domains such as "@example.com" are allowed.
Partial hostnames such as "@.example.com" are allowed.
Email addresses such as "test@example.com" and "test@.example.com"
are also allowed.

[]> @.oldcompanyname.com

Enter the new domain for this entry.
The new domain may be a fully qualified
such as "@example.domain.com" or a complete
email address such as "test@example.com"

[]> @example.com

Domain Map Table

There are currently 1 Domain Mappings.

Domain Mapping is: enabled

Choose the operation you want to perform:

- NEW - Create a new entry.
- EDIT - Modify an entry.
- DELETE - Remove an entry.
- PRINT - Display all domain mappings.
- IMPORT - Import domain mappings from a file.
- EXPORT - Export domain mappings to a file.
- CLEAR - Clear all domain mappings.

[]> print

@.oldcompanyname.com --> @example.com

Domain Map Table

There are currently 1 Domain Mappings.

Domain Mapping is: enabled

Choose the operation you want to perform:

- NEW - Create a new entry.
```

```
- EDIT - Modify an entry.
- DELETE - Remove an entry.
- PRINT - Display all domain mappings.
- IMPORT - Import domain mappings from a file.
- EXPORT - Export domain mappings to a file.
- CLEAR - Clear all domain mappings.

[]>

Name: InboundMail

Type: Public

Interface: PublicNet (192.168.2.1/24) TCP Port 25

Protocol: SMTP

Default Domain:

Max Concurrency: 1000 (TCP Queue: 50)

Domain Map: Enabled

TLS: No

SMTP Authentication: Disabled

Bounce Profile: Default

Use SenderBase For Reputation Filters and IP Profiling: Yes

Footer: None

LDAP: Off

Choose the operation you want to perform:

- NAME - Change the name of the listener.
- INTERFACE - Change the interface.
- LIMITS - Change the injection limits.
- SETUP - Configure general options.
- HOSTACCESS - Modify the Host Access Table.
- RCPTACCESS - Modify the Recipient Access Table.
- BOUNCECONFIG - Choose the bounce profile to use for messages injected on this
listener.
- MASQUERADE - Configure the Domain Masquerading Table.
- DOMAINMAP - Configure domain mappings.

[]>
```



### Related Topics

- [Importing and Exporting a Domain Map Table](#) , on page 721

## Importing and Exporting a Domain Map Table

To import or export a domain map table, first see [FTP, SSH, and SCP Access, on page 1303](#) to ensure that you can access the email gateway.

Create a text file of entries of domains to map. Separate the entries with white space (either a tab character or spaces). Comment out lines in the table using a number symbol (#) at the beginning of each line.

Place the file in the configuration directory, and then use the `import` subcommand of the `domain` subcommand to upload the file. Use the commands in this order:

```
listenerconfig -> edit -> injector_number -> domainmap -> import
```

Alternatively, you can use the `export` subcommand to download the existing configuration. A file (whose name you specify) will be written to the configuration directory. You can modify this file outside of the CLI and then import it again.

When you use the `import` subcommand, ensure that the file contains only valid entries. If there is an invalid entry (for example, a left-hand side with no right-hand side), the CLI reports syntax errors when you import the file. If there is a syntax error during import, no mappings in the entire file are imported.

Remember to issue the `commit` command after you import a domain map table file so that the configuration changes for the listener take effect.

Our Enterprise Gateway configuration now looks like this:

Figure 49: Domain Map Defined for a Public Listener

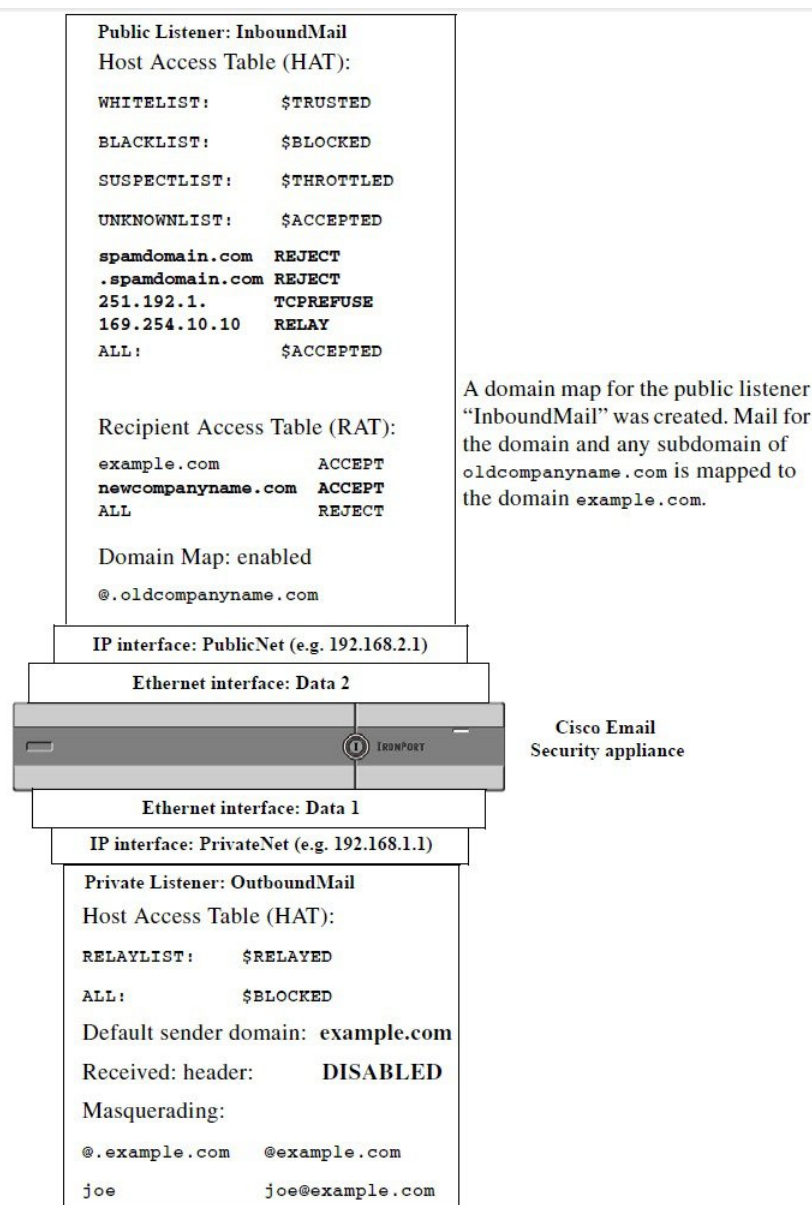

## Directing Bounced Email

Bounced email is an inevitable part of any email delivery. Your email gateway is able to process bounced email in a number of highly configurable ways.

Please note, this section describes how to control how your email gateway generates outgoing bounces (based on incoming mail). To control how your email gateway controls incoming bounces (based on outgoing mail) use Bounce Verification (see [Bounce Verification, on page 731](#)).

**Related Topics**

- [Handling Undeliverable Email, on page 723](#)
- [Creating a New Bounce Profile, on page 729](#)
- [Applying Bounce Profiles to Listeners, on page 729](#)

## Handling Undeliverable Email

The AsyncOS operating system classifies undeliverable email, or “bounced messages,” into the following categories:

<b>“Conversational” bounces:</b>	
<b>The remote domain bounces the message during the initial SMTP conversation.</b>	
Soft bounces	A message that is temporarily undeliverable. For example, a user’s mailbox may be full. These messages can be retried at a later time. (e.g. An SMTP 4XX error code.)
Hard bounces	A message that is permanently undeliverable. For example, the user no longer exists for that domain. These messages will not be retried. (e.g. An SMTP 5XX error code.)
<b>“Delayed” (or “Non-conversational”) bounces:</b>	
<b>The remote domain accepts the message for delivery, only to bounce it at a later time.</b>	
Soft bounces	A message that is temporarily undeliverable. For example, a user’s mailbox may be full. These messages can be retried at a later time. (e.g. An SMTP 4XX error code.)
Hard bounces	A message that is permanently undeliverable. For example, the user no longer exists for that domain. These messages will not be retried. (e.g. An SMTP 5XX error code.)

You use the Bounce Profiles page on the Network menu in the GUI (or the `bounceconfig` command) to configure how AsyncOS handles hard and soft conversational bounces for each listener you create. You create bounce profiles and then apply profiles to each listener via the `Network > Listeners` page (or the `listenerconfig` command). You can also assign bounce profiles to specific messages using message filters. (See [Using Message Filters to Enforce Email Policies, on page 127](#) for more information.)

**Related Topics**

- [Notes on Soft and Hard Bounces, on page 723](#)
- [Bounce Profile Parameters, on page 724](#)
- [Hard Bounces and the status Command, on page 727](#)
- [Conversational Bounces and SMTP Routes Message Filter actions, on page 727](#)
- [Example Bounce Profiles, on page 727](#)
- [Delivery Status Notification Format, on page 728](#)
- [Delay Warning Messages, on page 728](#)
- [Delay Warning Messages and Hard Bounces, on page 728](#)

## Notes on Soft and Hard Bounces

- For conversational soft bounces, a soft bounce event is defined as each time a recipient delivery temporarily fails. A single recipient may incur several soft bounce events. You use the Bounce Profiles page or the

bounceconfig command to configure parameters for each soft bounce event. (See [Bounce Profile Parameters](#), on page 724.)

- By default, the system generates a bounce message and sends it to the original sender for each hard bounced recipient. (The message is sent to the address defined in the Envelope Sender address of the message envelope. Envelope From is also commonly referred to as the Envelope Sender.) You can disable this feature and instead rely on log files for information about hard bounces. (See the “Logging” chapter.)
- Soft bounces become hard bounces after the maximum time in queue or the maximum number of retries, whichever comes first.

## Bounce Profile Parameters

When configuring a bounce profile, the following parameters control how conversational bounces are handled per message:

**Table 59: Bounce Profile Parameters**

<b>Maximum number of retries</b>	The number of times the system should try to reconnect to the recipient host to re-deliver the soft bounced message before treating it as a hard bounced message. The default is 100 retries.
<b>Maximum number of seconds in queue</b>	The amount of time the system should spend trying connect to the recipient host to re-deliver the soft bounced message before treating it as a hard bounced message. The default is 259,200 seconds (72 hours).
<b>Initial number of seconds to wait before retrying a message</b>	The amount of time the system should wait before the first attempt to re-deliver the soft bounced message. The default is 60 seconds. Set the initial retry time to a high value to reduce the frequency of soft bounce attempts. Conversely, to increase the frequency, lower the value.
<b>Maximum number of seconds to wait before retrying a message</b>	The maximum amount of time the system should wait before trying to re-deliver the soft bounced message. The default is 3,600 seconds (1 hour). This is not the interval between each subsequent try; rather, it is another parameter that can be used to control the number of retries. The initial retry interval is limited on the high end by the maximum retry interval. If the calculated retry interval period exceeds the maximum retry interval then the maximum retry interval is used instead.

<p><b>Send Hard Bounce Messages</b></p>	<p>Specify whether to send bounce message for hard bounce. If this option is enabled, you can choose the format of the bounce message. By default, bounce messages use the DSN format (RFC 1894).</p> <p>You can also send customized bounce messages based on the language of the original message (subject and body). For example, you may want to send bounce messages in Chinese for messages in Chinese and bounce messages in English for all the messages in other languages.</p> <p>Under <b>Notification Template</b>, click <b>Add Row</b> and choose the message language and the template that you want to use.</p> <p><b>Note</b> Make sure that you do not delete the default entry (<b>Message Language</b> set to <b>Default</b>). You can change the bounce notification template for the default entry.</p> <p>The language of a message is considered Default in the following scenarios:</p> <ul style="list-style-type: none"> <li>• If the language of the message is different from the language selected in the other Notification Template entries.</li> <li>• If the language of the message is not supported by the email gateway.</li> <li>• If the email gateway is unable to detect the language of the message.</li> <li>• If the content (subject and body) in the message is less than 50 bytes.</li> </ul> <p>While configuring the above example (send bounce messages in Chinese for messages in Chinese and bounce messages in English for all the messages in other languages,) the Notification Template table will look like this:</p> <table border="1" data-bbox="894 1037 1240 1115"> <thead> <tr> <th>Message Language</th> <th>Template</th> </tr> </thead> <tbody> <tr> <td>汉语繁体 [zh-cn]</td> <td>bounce_chinese</td> </tr> <tr> <td>Default</td> <td>bounce_english</td> </tr> </tbody> </table> <p>You can also choose whether to parse the DSN status field from the bounce response. If you choose “Yes,” the email gateway searches the bounce response for a DSN status code (RFC 3436) and uses the code in the Status field of the delivery status notification.</p>	Message Language	Template	汉语繁体 [zh-cn]	bounce_chinese	Default	bounce_english
Message Language	Template						
汉语繁体 [zh-cn]	bounce_chinese						
Default	bounce_english						

<p><b>Send Delay Warning Messages</b></p>	<p>Specify whether to send warning message for delayed delivery. If this option is enabled, you can configure custom delay warning messages based on the language of the original message (subject and body). For example, you may want to send delay warning messages in Chinese for the messages in Chinese and delay warning messages in English for all the messages in other languages.</p> <p>Under <b>Notification Template</b>, click <b>Add Row</b> and choose the message language and the template that you want to use.</p> <p><b>Note</b> Make sure that you do not delete the default entry (<b>Message Language</b> set to <b>Default</b>). You can change the bounce notification template for the default entry.</p> <p>The language of a message is considered Default in the following scenarios:</p> <ul style="list-style-type: none"> <li>• If the language of the message is different from the language selected in the other Notification Template entries.</li> <li>• If the language of the message is not supported by the email gateway.</li> <li>• If the email gateway is unable to detect the language of the message.</li> <li>• If the content (subject and body) in the message is less than 50 bytes.</li> </ul> <p>While configuring the above example (send delay warning messages in Chinese for the messages in Chinese and delay warning messages in English for all the messages in other languages,) the Notification Template table will look like this:</p> <table border="1" data-bbox="824 961 1235 1052"> <thead> <tr> <th>Message Language</th> <th>Template</th> </tr> </thead> <tbody> <tr> <td>汉语简体 [zh-cn]</td> <td>bounce_chinese</td> </tr> <tr> <td>Default</td> <td>bounce_english</td> </tr> </tbody> </table> <p>You can also specify the minimum interval between messages as well as the maximum number of retries to send.</p>	Message Language	Template	汉语简体 [zh-cn]	bounce_chinese	Default	bounce_english
Message Language	Template						
汉语简体 [zh-cn]	bounce_chinese						
Default	bounce_english						
<p><b>Specify Recipient for Bounces</b></p>	<p>You can bounce messages to an alternate address rather than the default of the Envelope Sender address.</p>						
<p><b>Use DomainKeys signing for bounce and delay messages</b></p>	<p>You can select a DomainKeys profile to use for signing bounce and delay messages. For information on DomainKeys, see <a href="#">DomainKeys and DKIM Authentication, on page 597</a>.</p>						
<p><b>Global Settings</b></p>							
<p><b>Configure these settings via the Edit Global Settings link on the Bounce Profiles page or by editing the default bounce profile via the <code>bounceconfig</code> command in the CLI.</b></p>							
<p><b>Initial number of seconds to wait before retrying an unreachable host</b></p>	<p>The amount of time the system should wait before retrying a host that is unreachable. The default is 60 seconds.</p>						
<p><b>Max interval allowed between retries to an unreachable host</b></p>	<p>The maximum amount of time the system should wait before retrying a host that is unreachable. The default is 3,600 seconds (1 hour). When the delivery initially fails due to the host being down, it will start with the minimum number of seconds retry value, and for each subsequent retry to the downed host, will increase the duration, up to this maximum number of seconds value.</p>						

## Hard Bounces and the status Command

When hard bounce message generation is enabled, the following counters in the status and status detail commands increment each time the email gateway generates a hard bounce message for delivery:

Counters:	Reset	Uptime	Lifetime
Receiving			
Messages Received	0	0	0
Recipients Received	0	0	0
Gen. Bounce Recipients	0	0	0

For more information, see the “Monitoring and Managing via the CLI” chapter. When hard bounce message generation is disabled, none of these counters increments when a recipient hard bounces.



**Note** The Envelope Sender address of the message envelope is different than the From: in the message headers. AsyncOS can be configured to send hard bounce messages to an email address different than the Envelope Sender address.

## Conversational Bounces and SMTP Routes Message Filter actions

Mappings for SMTP Routes and message filter actions are not applied to the routing of SMTP bounce messages generated by the email gateway as a result of a conversational bounce. When an email gateway receives a conversational bounce message, it generates an SMTP bounce message back to the Envelope Sender of the original message. In this case, the email gateway is actually generating the message, so any SMTP Routes that apply to an injected message for relaying do not apply.

## Example Bounce Profiles

Consider these two examples using different bounce profile parameters:

**Table 60: Example 1: Bounce Profile Parameters**

Parameter	Value
Max number of retries	2
Max number of seconds in queue	259,200 seconds (72 hours)
Initial number of seconds before retrying	60 seconds
Max number of seconds to wait before retrying	60 seconds

In Example 1, the first recipient delivery attempt is made at  $t=0$ , immediately after the message is injected into the email gateway. With the default initial retry time of 60 seconds, the first retry attempt is made

approximately one minute later at  $t=60$ . The retry interval is calculated and it is determined to use the maximum retry interval of 60 seconds. Thus, the second retry attempt is made at approximately  $t=120$ . Immediately after this retry attempt, the system generates a hard bounce message for that recipient because the maximum number of retries is two.

**Table 61: Example 2: Bounce Profile Parameters**

Parameter	Value
Max number of retries	100
Max number of seconds in queue	100 seconds
Initial number of seconds before retrying	60 seconds
Max number of seconds to wait before retrying	120 seconds

In Example 2, the first delivery attempt is made at  $t=0$  and the first retry is made at  $t=60$ . The system hard bounces the message immediately before the next delivery attempt (scheduled to occur at  $t=120$ ) because it has exceeded the maximum time in queue of 100 seconds.

## Delivery Status Notification Format

Bounce messages generated by the system, by default, use the Delivery Status Notification (DSN) format for both hard and soft bounces. DSN is a format defined by RFC 1894 (see <http://www.faqs.org/rfcs/rfc1894.html>) that “defines a MIME content-type that may be used by a message transfer agent (MTA) or electronic mail gateway to report the result of an attempt to deliver a message to one or more recipients.” By default, the delivery status notification includes an explanation of the delivery status and the original message if the message size is less than 10k. If the message size is greater than 10k, the delivery status notification includes the message headers only. If the message headers exceed 10k, the delivery status notification truncates the headers. If you want include messages (or message headers) that are greater than 10k in the DSN, you can use the `max_bounce_copy` parameter in the `bounceconfig` command (this parameter is only available from the CLI).

## Delay Warning Messages

Time in Queue Messages (delay notification messages) generated by the system also use the DSN format. Change the default parameters by using the Bounce Profiles page on the Network menu (or the `bounceconfig` command) to edit existing or create new bounce profiles and change the default values for:

- The minimum interval between sending delay warning messages.
- The maximum number of delay warning messages to send per recipient.

## Delay Warning Messages and Hard Bounces

Note that it is possible to receive both a delay warning and a hard bounce for the same message *simultaneously*, if you have set a very small durations for both the “Maximum Time in Queue” setting and the minimum interval setting for “Send Delay Warning Messages.” Cisco Systems recommends using the default values for these settings as a minimum if you choose to enable sending of delay warning messages.

Further, delay warning messages and bounce messages originated by the email gateway may be delayed by as much as 15 minutes during processing.



## Creating a New Bounce Profile

In the following example, a bounce profile named `bouncepr1` is created using the Bounce Profiles page. In this profile, all hard bounced messages are sent to the alternate address `bounce-mailbox@example.com`. Delay warnings messages are enabled. One warning message will be sent per recipient, and the default value of 4 hours (14400 seconds) between warning messages is accepted.

### Related Topics

- [Editing the Default Bounce Profile, on page 729](#)
- [Example of a Minimalist Bounce Profile, on page 729](#)

## Editing the Default Bounce Profile

You can edit any bounce profile by clicking its name in the Bounce Profiles listing. You can also edit the default bounce profile. In this example, the default profile is edited to increase the `maximum number of seconds to wait before retrying unreachable hosts` from 3600 (one hour) to 10800 (three hours):

## Example of a Minimalist Bounce Profile

In the following example, a bounce profile named `minimalist` is created. In this profile, messages are not retried when they bounce (zero maximum retries), and the maximum time to wait before retrying is specified. Hard bounce messages are disabled, and soft bounce warnings are not sent.

## Applying Bounce Profiles to Listeners

Once you have created a bounce profile, you can apply that profile to a listener using the **Network > Listeners** page or the `listenerconfig` command.

In the following example, the `bouncepr1` profile is applied to the `OutgoingMail` listener.

At this point, our Email Gateway configuration looks like this:

Figure 50: Applying a Bounce Profile to a Private Listener

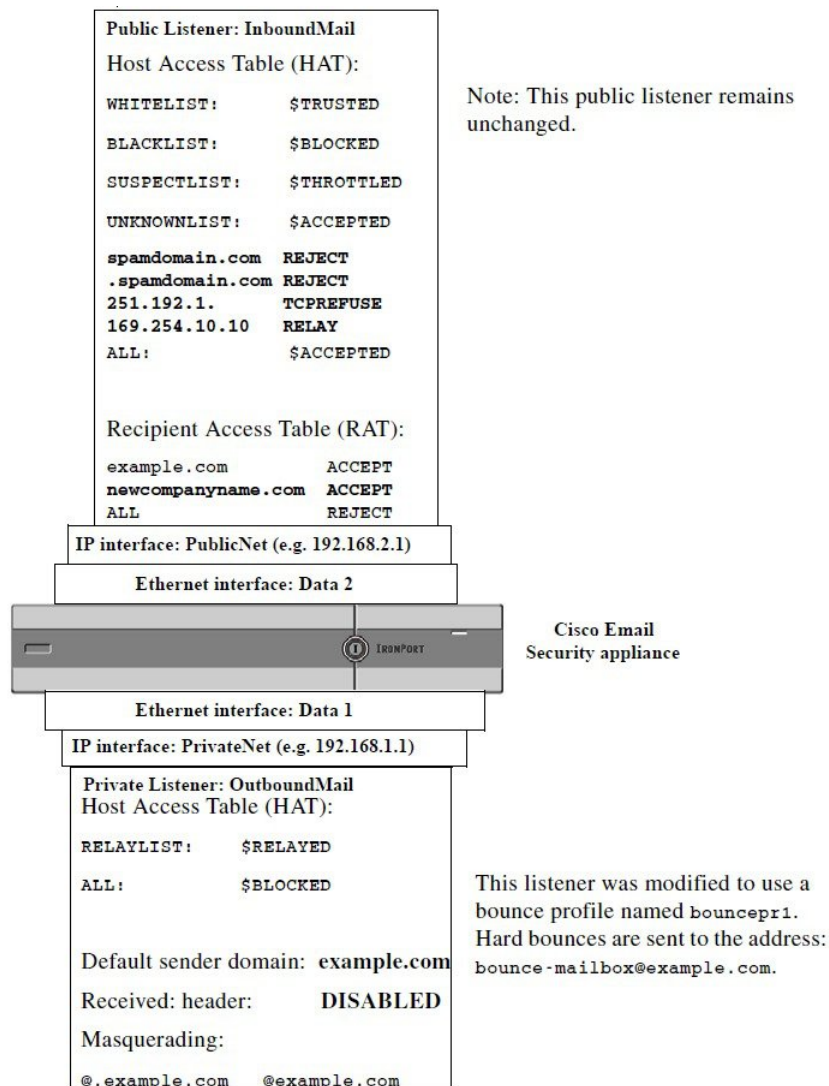

## Controlling Email Delivery Using Destination Controls

Uncontrolled high-volume email delivery can overwhelm recipient domains. AsyncOS gives you full control of message delivery by defining the number of connections your email gateway will open or the number of messages your email gateway will send to each destination domain.

Using the Destination Controls feature (Mail Policies > Destination Controls in the GUI, or the `destconfig` command in the CLI), you can control:

- [Rate Limiting](#), on page 731
- [TLS](#), on page 731
- [Bounce Verification](#), on page 731
- [Bounce Profile](#), on page 731

## Rate Limiting

- **Concurrent Connections:** number of simultaneous connections to remote hosts the email gateway will attempt to open.
- **Maximum Messages Per Connection:** number of messages your email gateway will send to a destination domain before the email gateway initiates a new connection.
- **Recipients:** number of recipients the email gateway will send to a given remote host in a given time period.
- **Limits:** how to apply the limits you have specified on a per-destination and per MGA hostname basis.

## TLS

- Whether TLS connections to remote hosts will be accepted, allowed, or required (see [Controlling TLS, on page 734](#)).
- Whether to send an alert when TLS negotiation fails when delivering a message to a remote host that requires a TLS connection. This is a global setting, not a per-domain setting.
- Assign a TLS certificate to use for all outbound TLS connections to remote hosts.

## Bounce Verification

- Whether or not to perform address tagging via Bounce Verification (see [Bounce Verification, on page 739](#)).

## Bounce Profile

- Which bounce profile should be used by the email gateway for a given remote host (the default bounce profile is set via the Network > Bounce Profiles page).

You can also control the default settings for unspecified domains.

### Related Topics

- [Determining Which Interface is Used for Mail Delivery, on page 731](#)
- [Default Delivery Limits, on page 732](#)
- [Working with Destination Controls, on page 732](#)

## Determining Which Interface is Used for Mail Delivery

Unless you specify the output interface via the `deliveryconfig` command or via a message filter ( `alt-src-host` ), or through the use of a virtual gateway, the output interface is selected by the AsyncOS routing table. Basically, selecting “auto” means to let AsyncOS decide.

In greater detail: local addresses are identified by applying the interface netmask to the interface IP address. Both of these are set via the Network > Interfaces page or by the `interfaceconfig` command (or during system setup). If the address space overlaps, the most specific netmask is used. If a destination is local, packets are sent via the appropriate local interface.

If the destination is not local, packets are sent to the default router (set via the Network > Routing page or with the `setgateway` command). The IP address of the default router is local. The output interface is determined

by the rule for selecting the output interface for local addresses. For example, AsyncOS chooses the most specific IP address and netmask that include the default router's IP address.

The routing table is configured via the Network > Routing page (or via the `routeconfig` command). A matching entry in the routing table takes precedence over the default route. A more specific route takes precedence over a less specific route.

## Default Delivery Limits

Each outbound destination domain has its own outbound queue. Therefore, each domain has a separate set of concurrency limits as specified in the Destination Controls table. Further, each unique domain not listed specifically in the Destination Controls table uses another set of the “Default” limits as set in the table.

## Working with Destination Controls

Use the Mail Policies > Destination Controls page in the GUI or the `destconfig` command in the CLI to create, edit, and delete Destination Control entries.

### Related Topics

- [Controlling the Version of Internet Protocol Addresses, on page 732](#)
- [Controlling the Number of Connections, Messages, and Recipients to a Domain, on page 732](#)
- [Controlling TLS, on page 734](#)
- [Controlling Bounce Verification Tagging, on page 735](#)
- [Controlling Bounces, on page 735](#)
- [Adding a New Destination Control Entry, on page 735](#)
- [Importing and Exporting Destination Control Configurations, on page 735](#)
- [Destination Controls and the CLI, on page 738](#)

## Controlling the Version of Internet Protocol Addresses

You can configure which version of Internet Protocol addresses to use for the connection to a domain. The email gateway uses both Internet Protocol version 4 (IPv4) and Internet Protocol version (IPv6). You can configure a listener on the email gateway to use one version of the protocol or both.

If the “Required” setting for either IPv4 or IPv6 is specified, the email gateway will negotiate a connection to the domain using an address of the specified version. If the domain does not use that IP address version, no email will be sent. If the “Preferred” setting for either IPv4 or IPv6 is specified, the email gateway will first attempt to negotiate a connection to the domain using an address of the specified version then fall back to the other if the first is not reachable.

## Controlling the Number of Connections, Messages, and Recipients to a Domain

You may want to limit how your appliance will deliver email to avoid overwhelming remote hosts or your own internal groupware servers with email from your email gateway.

For each domain, you can assign a maximum number of connections, outbound messages, and recipients that will never be exceeded by the system in a given time period. This “good neighbor” table is defined through the Destination Controls feature (**Mail Policies > Destination Controls** or the `destconfig` command — previously the `setgoodtable` command). You can specify the domain name using the following syntax:

```
domain.com
```

or

.domain.com

This syntax enables AsyncOS to specify destination controls for sub-domains such as sample.server.domain.com without entering each full subdomain address individually.

For connections, messages, and recipients, you set whether the limits you define are enforced for each Virtual Gateway address, or for the entire system. (Virtual Gateway address limits control the number of concurrent connections per IP interface. System-wide limits control the total number of connections the email gateway will allow.)

You also set whether the limits you define are enforced for the entire domain.



**Note** The current system default is 500 connections per domain and 50 messages per connection.

These values are explained in the following table.

**Table 62: Values in the Destination Controls Table**

Field	Description
Concurrent Connections	The maximum number of outbound connections that will be made by the email gateway to a given host. (Note that the domain can include your internal groupware hosts.)
Maximum Messages Per Connection	The maximum number of messages allowed for a single outbound connection from the email gateway to a given host before initiating a new connection.
Recipients	<p>The maximum number of recipients allowed within the given period of time. “None” denotes that there is no recipient limit for the given domain.</p> <p>The minimum period of time — between 1 and 60 minutes — that the email gateway will count the number of recipients. Specifying a time period of “0” disables the feature.</p> <p><b>Note</b> If you change the recipient limit, AsyncOS resets the counters for all messages already in the queue. The email gateway delivers the messages based on the new recipient limit.</p>
Apply Limits	<p>Specifies whether the limit will be applied (enforces) to the entire domain.</p> <p>This setting applies to connection, message, and recipient limits.</p> <p>Specifies whether the limit will be applied system-wide or for each Virtual Gateway address.</p> <p><b>Note</b> If you have configured groups of IP addresses, but you have not configured virtual gateways, do not configure apply limits per each virtual gateway. This setting is intended only for systems configured to use virtual gateways. For information on configuring virtual gateways, see <a href="#">Configuring Mail Gateways for all Hosted Domains Using Virtual Gateway™ Technology</a>, on page 745.</p>



---

**Note** If limits are applied per each Virtual Gateway address, you can still effectively implement system-wide limits by setting the Virtual Gateway limit to the system-wide limit you want divided by the number of possible virtual gateways. For example, if you have four Virtual Gateway addresses configured, and you do not want to open more than 100 simultaneous connections to the domain `yahoo.com`, set the Virtual Gateway limit to 25 simultaneous connections.

The `delivernow` command, when acting on all domains, resets all counters tracked in the `destconfig` command.

---

## Controlling TLS

You can also configure the TLS (Transport Layer Security) on a per-domain basis. If the “Required” setting is specified, a TLS connection will be negotiated from the email gateway listener to MTA(s) for the domain. If the negotiation fails, no email will be sent through the connection. For more information, see [Enabling TLS and Certificate Verification on Delivery, on page 680](#).

You can specify whether the email gateway sends an alert if the TLS negotiation fails when delivering messages to a domain that requires a TLS connection. The alert message contains name of the destination domain for the failed TLS negotiation. The email gateway sends the alert message to all recipients set to receive Warning severity level alerts for System alert types. You can manage alert recipients via the System Administration > Alerts page in the GUI (or via the `alertconfig` command in the CLI).

To enable TLS connection alerts, click **Edit Global Settings** on the Destination Controls page or `destconfig -> setup` subcommand. This is a global setting, not a per-domain setting. For information on the messages that the email gateway attempted to deliver, use the Monitor > Message Tracking page or the mail logs.

You must specify a certificate to use for all outgoing TLS connections. You can edit the ‘Default’ destination controls entry in the web interface or use the `destconfig > setup` subcommand in the CLI to specify the certificate to use for all destination controls.. For information on obtaining a certificate, see [Working with Certificates, on page 672](#).

You can also choose a different certificate other than the certificate configured in the ‘Default’ destination control entry for specific domains.

You can choose a different certificate in any one of the following ways:

- Edit the corresponding destination control entry and select a different certificate using the **TLS certificate** option in the web interface.
- Use the `destconfig > new` or `edit` sub commands to select a certificate when you create or edit a destination control entry.



---

**Note** You can create a maximum of 100 destination control entries with a different certificate than the certificate configured in the ‘Default’ destination control entry.

---

For more information on alerts, see the “System Administration” chapter.

## Controlling Bounce Verification Tagging

You can specify whether or not mail sent is tagged for bounce verification. You can specify this for the default, as well as specific destinations. Cisco suggests enabling bounce verification for the default, and then creating new destinations for specific exclusions. See [Bounce Verification, on page 739](#) for more information.

## Controlling Bounces

In addition to controlling the number of connections and recipients will deliver to a remote host, you can also specify a bounce profile to be used for that domain. If specified, the bounce profile appears in the fifth column of the `destconfig` command. If you do not specify a bounce profile, the default bounce profile will be used. For more information, see [Creating a New Bounce Profile, on page 729](#).

## Adding a New Destination Control Entry

### Procedure

- 
- Step 1** Click **Add Destination**:
- Step 2** Configure the entry.
- Step 3** Submit and commit your changes.
- 

## Importing and Exporting Destination Control Configurations

If you are managing multiple domains, you can create a single configuration file to define Destination Control entries for all of the domains and import it onto the email gateway. The format of the configuration file is similar to a Windows INI configuration file. The parameters for a domain are grouped in a section with the domain name as the section name. For example, use the section name `[example.com]` to group the parameters for the domain `example.com`. Any parameter that is not defined will be inherited from the default Destination Control entry. You can define the parameters for the default Destination Control entry by including a `[DEFAULT]` section in the configuration file.

Importing the configuration file overwrites all of email gateway's Destination Control entries, except for the default entry unless the configuration file includes the `[DEFAULT]` section. All other existing Destination Control entries will be deleted.

You can define any of the following parameters for a domain in the configuration file. All parameters are required for the `[DEFAULT]` section except for the `bounce_profile` parameter:

**Table 63: Destination Control Configuration File Parameters**

Parameter Name	Description
<code>ip_sort_pref</code>	Specifies the Internet Protocol version for the domain. Enter one of the following values: <ul style="list-style-type: none"> <li>• <code>PREFER_V6</code> for “IPv6 Preferred”</li> <li>• <code>REQUIRE_V6</code> for “IPv6 Required”</li> <li>• <code>PREFER_V4</code> for “IPv4 Preferred”</li> <li>• <code>REQUIRE_V4</code> for “IPv4 Required”</li> </ul>

Parameter Name	Description
<code>max_host_concurrency</code>	The maximum number of outbound connections that will be made by the email gateway to a given host.  If you define this parameter for a domain, the <code>limit_type</code> and <code>limit_apply</code> parameters must also be defined.
<code>max_messages_per_connection</code>	The maximum number of messages allowed for a single outbound connection from the email gateway to a given host before initiating a new connection.
<code>recipient_minutes</code>	The period of time — between 1 and 60 minutes — that the email gateway will count the number of recipients. Leave undefined if no recipient limit should be applied.
<code>recipient_limit</code>	The maximum number of recipients allowed within the given period of time. Leave undefined if no recipient limit should be applied.  If you define this parameter for a domain, the <code>recipient_minutes</code> , <code>limit_type</code> , and <code>limit_apply</code> parameters must also be defined.
<code>limit_type</code>	Specifies whether the limit will be applied to the entire domain or to each mail exchange IP address specified for that domain.  Enter one of the following values: <ul style="list-style-type: none"> <li>• 0 (or <code>host</code>) for the domain</li> <li>• 1 (or <code>MXIP</code>) for the mail exchange IP address</li> </ul>
<code>limit_apply</code>	Specifies whether the limit will be applied system-wide or for each Virtual Gateway address.  Enter one of the following values: <ul style="list-style-type: none"> <li>• 0 (or <code>system</code>) for system-wide</li> <li>• 1 (or <code>VG</code>) for Virtual Gateway</li> </ul>
<code>bounce_validation</code>	Specifies whether to turn on bounce validation address tagging.  Enter one of the following values: <ul style="list-style-type: none"> <li>• 0 (or <code>off</code>)</li> <li>• 1 (or <code>on</code>)</li> </ul>
<code>table_tls</code>	Specifies the TLS setting for the domain. See <a href="#">Enabling TLS and Certificate Verification on Delivery, on page 680</a> for more information.  Enter one of the following values: <ul style="list-style-type: none"> <li>• 0 (or <code>off</code>)</li> <li>• 1 (or <code>on</code>) for “Preferred”</li> <li>• 2 (or <code>required</code>) for “Required”</li> <li>• 3 (or <code>on_verify</code>) for “Preferred (Verify)”</li> <li>• 4 (or <code>require_verify</code>) for “Required (Verify)”</li> </ul> Strings are not case sensitive.



Parameter Name	Description
bounce_profile	Name of the bounce profile to use. This cannot be used in the [DEFAULT] destination control entry.
send_tls_req_alert	Whether to send an alert if the required TLS connection fails. Enter one of the following values: <ul style="list-style-type: none"> <li>• 0 (or off )</li> <li>• 1 (or on )</li> </ul> This is a global setting and can only be used in the [DEFAULT] destination control entry.
certificate	Certificate used for outgoing TLS connections. If you do not specify a certificate, then the certificate in the [DEFAULT] destination control entry is used.  <b>Note</b> If you do not specify a certificate, AsyncOS assigns the demonstration certificate, but using the demonstration certificate is not secure and not recommended for general use.

The following example shows a configuration file for the domains example1.com and example2.com along with the default Destination Control entry:

```
[DEFAULT]
ip_sort_pref = PREFER_V6
max_host_concurrency = 500
max_messages_per_connection = 50
recipient_minutes = 60
recipient_limit = 300
limit_type = host
limit_apply = VG
table_tls = off
bounce_validation = 0
send_tls_req_alert = 0
certificate = example.com
[example1.com]
ip_sort_pref = PREFER_V6
recipient_minutes = 60
recipient_limit = 100
table_tls = require_verify
limit_apply = VG
```

```

bounce_profile = tls_failed

limit_type = host

[example2.com]

certificate = example2.com

table_tls = on

bounce_profile = tls_failed

```

The above example results in the following Destination Control entries for example1.com and example2.com:

example1.com

```

IP Address Preference: IPv6 Preferred

Maximum messages per connection: 50

Rate Limiting:

500 concurrent connections

100 recipients per 60 minutes

Limits applied to entire domain, across all virtual gateways

TLS: Required (Verify)

TLS Certificate: example.com

Bounce Profile: tls_failed

```

example2.com

```

IP Address Preference: IPv6 Preferred

Maximum messages per connection: Default

Rate Limiting: Default

TLS: Preferred

TLS Certificate: example2.com

Bounce Profile: tls_failed

```

Use the **Import Table** button on the Destination Controls page or the `destconfig -> import` command to import a configuration file. You can also export your Destination Control entries to an INI file using the **Export Table** button on the Destination Controls page or the `destconfig -> export` command. AsyncOS includes the `[Default]` domain control entry in the exported INI file.

## Destination Controls and the CLI

You can use the `destconfig` command in the CLI to configure Destination Control entries. This command is discussed in the CLI Reference Guide for AsyncOS for Cisco Secure Email Gateway.

# Bounce Verification

A “bounce” message is a new message that is sent by a receiving MTA, using the Envelope Sender of the original email as the new Envelope Recipient. This bounce is sent back to the Envelope Recipient (usually) with a blank Envelope Sender (MAIL FROM: <>) when the original message is undeliverable (typically due to a non-existent recipient address).

Increasingly, spammers are attacking email infrastructure via misdirected bounce attacks. These attacks consist of a flood of bounce messages, sent by unknowing, legitimate mail servers. Basically, the process spammers use is to send email via open relays and “zombie” networks to multiple, potentially invalid addresses (Envelope Recipients) at various domains. In these messages, the Envelope Sender is forged so that the spam appears to be coming from a legitimate domain (this is known as a “Joe job”).

In turn, for each incoming email with an invalid Envelope Recipient, the receiving mail servers generate a new email — a bounce message — and send it along to the Envelope Sender at the innocent domain (the one whose Envelope Sender address was forged). As a result, this target domain receives a flood of “misdirected” bounces — potentially millions of messages. This type of distributed denial of service attack can bring down email infrastructure and render it impossible for the target to send or receive legitimate email.

To combat these misdirected bounce attacks, AsyncOS includes Bounce Verification. When enabled, Bounce Verification tags the Envelope Sender address for messages sent via your email gateway. The Envelope Recipient for any bounce message received by the email gateway is then checked for the presence of this tag. Legitimate bounces (which should contain this tag) are untagged and delivered. Bounce messages that do not contain the tag can be handled separately.

Note that you can use Bounce Verification to manage incoming bounce messages based on your outgoing mail. To control how your email gateway generates outgoing bounces (based on incoming mail), see [Directing Bounced Email, on page 722](#).

## Related Topics

- [Overview: Tagging and Bounce Verification, on page 739](#)
- [Preventing a Bounced Message Storm Using Bounce Verification, on page 741](#)
- [Accepting Legitimate Untagged Bounced Messages, on page 740](#)

## Overview: Tagging and Bounce Verification

When sending email with bounce verification enabled, your email gateway will rewrite the Envelope Sender address in the message. For example, MAIL FROM: joe@example.com becomes MAIL FROM: prvs=joe=123ABCDEFGH@example.com . The 123... string in the example is the “bounce verification tag” that gets added to the Envelope Sender as it is sent by your email gateway. The tag is generated using a key defined in the Bounce Verification settings (see [Bounce Verification Address Tagging Keys, on page 740](#) for more information about specifying a key). If this message bounces, the Envelope Recipient address in the bounce will typically include this bounce verification tag.

You can enable or disable bounce verification tagging system-wide as a default. You can also enable or disable bounce verification tagging for specific domains. In most situations, you would enable it by default, and then list specific domains to exclude in the Destination Controls table (see [Working with Destination Controls, on page 732](#)).

If a message already contains a tagged address, AsyncOS does not add another tag (in the case of an email gateway delivering a bounce message to an email gateway inside the DMZ).

**Related Topics**

- [Handling Incoming Bounce Messages, on page 740](#)
- [Bounce Verification Address Tagging Keys, on page 740](#)

**Handling Incoming Bounce Messages**

Bounces that include a valid tag are delivered. The tag is removed and the Envelope Recipient is restored. This occurs immediately after the Domain Map step in the email pipeline. You can define how your email gateways handle untagged or invalidly tagged bounces — reject them or add a custom header. See [Configuring Bounce Verification Settings, on page 742](#) for more information.

If the bounce verification tag is not present, or if the key used to generate the tag has changed, or if the message is more than seven days old, the message is treated as per the settings defined for Bounce Verification.

For example, the following mail log shows a bounced message rejected by the email gateway:

```
Fri Jul 21 16:02:19 2006 Info: Start MID 26603 ICID 125192

Fri Jul 21 16:02:19 2006 Info: MID 26603 ICID 125192 From: <>

Fri Jul 21 16:02:40 2006 Info: MID 26603 ICID 125192 invalid bounce, rcpt address
<bob@example.com> rejected by bounce verification.
Fri Jul 21 16:03:51 2006 Info: Message aborted MID 26603 Receiving aborted by sender

Fri Jul 21 16:03:51 2006 Info: Message finished MID 26603 aborted
```



---

**Note** When delivering non-bounce mail to your own internal mail server (Exchange, etc.), you should disable Bounce Verification tagging for that internal domain.

---

AsyncOS considers bounces as mail with a null Mail From address (<>). For non-bounce messages that might contain a tagged Envelope Recipient, AsyncOS applies a more lenient policy. In such cases, AsyncOS ignores the seven-day key expiration and tries to find a match with older keys as well.

**Bounce Verification Address Tagging Keys**

The tagging key is a text string your email gateway uses when generating the bounce verification tag. Ideally, you would use the same key across all of your email gateways so that all mail leaving your domain is tagged consistently. That way, if one email gateway tags the Envelope Sender on an outgoing message an incoming bounce will be verified and delivered even if the bounce is received by a different email gateway.

There is a seven day grace period for tags. For example, you may choose to change your tagging key multiple times within a seven-day period. In such a case, your email gateway will try to verify tagged messages using all previous keys that are less than seven days old.

**Accepting Legitimate Untagged Bounced Messages**

AsyncOS also includes a HAT setting related to Bounce Verification for considering whether untagged bounces are valid. The default setting is “No,” which means that untagged bounces are considered invalid and the email gateway either rejects the message or applies a customer header, depending on the action selected on the **Mail Policies > Bounce Verification** page. If you select “Yes,” the email gateway considers untagged bounces to be valid and accepts them. This may be used in the following scenario:

Suppose you have a user that wants to send email to a mailing list. However, the mailing list accepts messages only from a fixed set of Envelope Senders. In such a case, tagged messages from your user will not be accepted (as the tag changes regularly).

#### Procedure

---

- Step 1** Add the domain to which the user is trying to send mail to the Destination Controls table and disable tagging for that domain. At this point, the user can send mail without problems.
- Step 2** However, to properly support receiving bounces from that domain (since they will not be tagged) you can create a sender group for that domain and enable the Consider Untagged Bounces to be Valid parameter in an “Accept” mail flow policy.
- 

## Preventing a Bounced Message Storm Using Bounce Verification

#### Procedure

---

- Step 1** Enter a tagging key. For more information, see [Configuring Bounce Verification Address Tagging Keys, on page 741](#).
- Step 2** Edit the bounce verification settings. For more information, see [Configuring Bounce Verification Settings, on page 742](#).
- Step 3** Enable bounce verification via Destination Controls. For more information, see [Working with Destination Controls, on page 732](#).
- 

#### What to do next

#### Related Topics

- [Configuring Bounce Verification Address Tagging Keys, on page 741](#)
- [Configuring Bounce Verification Settings, on page 742](#)
- [Configuring Bounce Verification Using the CLI, on page 742](#)
- [Bounce Verification and Cluster Configuration, on page 742](#)

## Configuring Bounce Verification Address Tagging Keys

The Bounce Verification Address Tagging Keys listing shows your current key and any unpurged keys you have used in the past. To add a new key:

#### Procedure

---

- Step 1** On the **Mail Policies > Bounce Verification** page, click **New Key**.
- Step 2** Enter a text string and click **Submit**.

**Step 3**    **Commit** your changes.

---

#### What to do next

#### Related Topics

- [Purging Keys, on page 742](#)

## Purging Keys

You can purge your old address tagging keys by selecting a rule for purging from the pull-down menu and clicking **Purge**.

## Configuring Bounce Verification Settings

The bounce verification settings determine which action to take when an invalid bounce is received.

### Procedure

---

- Step 1**    Choose **Mail Policies > Bounce Verification**.
  - Step 2**    Click **Edit Settings**.
  - Step 3**    Select whether to reject invalid bounces, or to add a custom header to the message. If you want to add a header, enter the header name and value.
  - Step 4**    Optionally, enable smart exceptions. This setting allows incoming mail messages, and bounce messages generated by internal mail servers, to be automatically exempted from bounce verification processing (even when a single listener is used for both incoming and outgoing mail).
  - Step 5**    Submit and commit your changes.
- 

## Configuring Bounce Verification Using the CLI

You can use the `bvconfig` and `destconfig` commands in the CLI to configure bounce verification. These commands are discussed in the *CLI Reference Guide for AsyncOS for Cisco Secure Email Gateway*.

## Bounce Verification and Cluster Configuration

Bounce verification works in a cluster configuration as long as both email gateways use the same "bounce key." When you use the same key, either systems should be able to accept a legitimate bounce back. The modified header tag/key is not specific to each email gateway.

## Set Email Delivery Parameters

The `deliveryconfig` command sets parameters to be used when delivering email from the email gateway.

The email gateway accepts email using multiple mail protocols: SMTP and QMQP. However, all outgoing email is delivered using SMTP, which is why the `deliveryconfig` command does not require that the protocol be specified.



---

**Note** Several of the features or commands described in this section will affect, or be affected by routing precedence. Please see the “Assigning Network and IP Addresses” appendix for more information.

---

#### Related Topics

- [Default Delivery IP Interface, on page 743](#)
- [Possible Delivery Feature, on page 743](#)
- [Default Maximum Concurrency, on page 743](#)
- [deliveryconfig Example, on page 744](#)

## Default Delivery IP Interface

By default, the system uses an IP interface or IP interface group for email delivery. Any currently configured IP interface or IP interface group can be set. If no specific interface is identified, AsyncOS will use the hostname associated with the default delivery interface in the SMTP HELO command when communicating with recipient hosts. To configure IP interfaces, use the `interfaceconfig` command.

These are the rules for using Auto selection of email delivery interfaces:

- If the remote email server is on the same subnet as one of the configured interfaces, then traffic will go out on the matching interface.
- When set to auto-select, static routes you have configured using `routeconfig` take effect.
- Otherwise, the interface that is on the same subnet as the default gateway will be used. If all of the IP addresses have an equivalent route to the destination, then the system uses the most efficient interface available.

## Possible Delivery Feature



---

**Caution** If you enable this feature, message delivery will not be reliable and may lead to loss of messages. Also, your email gateway will not be RFC 5321-compliant. For more information, see <http://tools.ietf.org/html/rfc5321#section-6.1..>

---

When the Possible Delivery feature is enabled, AsyncOS treats any message that times-out after the body of the message is delivered, but before recipient host acknowledges receipt of the message, as a “possible delivery.” This functionality prevents recipients from receiving multiple copies of a message if continuous errors at their recipient host prevent acknowledgment of receipt. AsyncOS logs this recipient as a possible delivery in the mail logs and counts the message as completed.

## Default Maximum Concurrency

You also specify the default maximum number of concurrent connections the email gateway makes for outbound message delivery. (The system-wide default is 10,000 connections to separate domains.) The limit is monitored in conjunction with the per-listener maximum outbound message delivery concurrency (the default per listener is 600 connections for private listeners and 1000 connections for public listeners). Setting the value lower than the default prevents the gateway from dominating weaker networks. For example, certain

firewalls do not support large numbers of connections, and this could induce Denial of Service (DoS) warnings in these environments.

## deliveryconfig Example

In the following example, the `deliveryconfig` command is used to set the default interface to “Auto” with “Possible Delivery” enabled. The system-wide maximum outbound message delivery is set to 9000 connections.

```
mail3.example.com> deliveryconfig

Choose the operation you want to perform:
- SETUP - Configure mail delivery.

[]> setup

Choose the default interface to deliver mail.

1. Auto
2. PublicNet2 (192.168.3.1/24: mail4.example.com)
3. Management (192.168.42.42/24: mail3.example.com)
4. PrivateNet (192.168.1.1/24: mail3.example.com)
5. PublicNet (192.168.2.1/24: mail3.example.com)

[1]> 1

Enable "Possible Delivery"? [Y]> y

Please enter the default system wide maximum outbound message delivery
concurrency

[10000]> 9000

mail3.example.com>
```

Our Email Gateway configuration now looks like this:



Figure 51: Setting Destination and Delivery Parameters

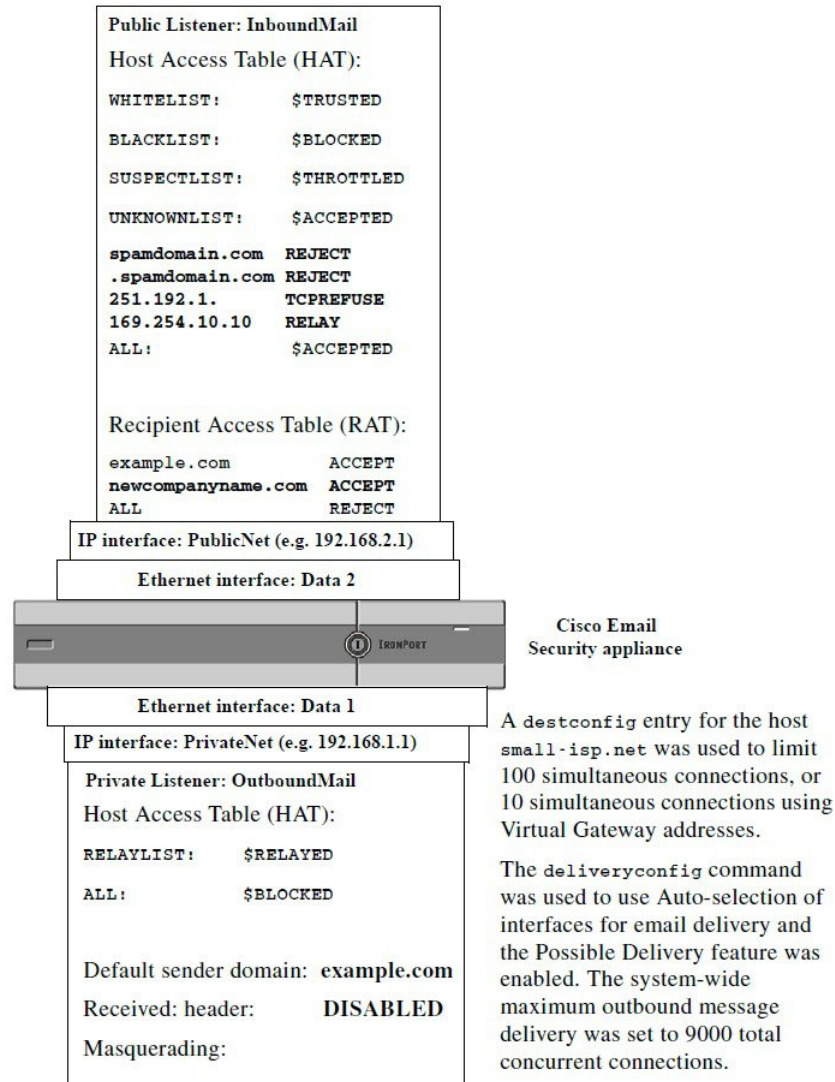

## Configuring Mail Gateways for all Hosted Domains Using Virtual Gateway™ Technology

This section describes Cisco Virtual Gateway™ technology and its benefits, how to set up a Virtual Gateway address, and how to monitor and manage Virtual Gateway addresses.

The Cisco Virtual Gateway technology allows you to configure enterprise mail gateways for all domains you host — with distinct IP addresses, hostname and domains — and create separate corporate email policy enforcement and anti-spam strategies for those domains, while hosted within the same physical email gateway. The number of Virtual Gateway addresses available on all the email gateway models is 255.

### Related Topics

- [Overview, on page 746](#)
- [Setting Up Virtual Gateway Addresses, on page 746](#)
- [Monitoring the Virtual Gateway Addresses, on page 753](#)
- [Managing Delivery Connections per Virtual Gateway Address, on page 753](#)

## Overview

Cisco has developed a unique Virtual Gateway technology designed to help ensure that corporations can reliably communicate with their customers via email. Virtual Gateway technology enables users to separate the email gateway into multiple Virtual Gateway addresses from which to send and receive email. Each Virtual Gateway address is given a distinct IP address, hostname and domain, and email queue.

Assigning a distinct IP address and hostname to each Virtual Gateway address ensures that email delivered through the gateway will be properly identified by the recipient host and prevents critical email from being blocked as spam. The email gateway has the intelligence to give the correct hostname in the SMTP HELO command for each of the Virtual Gateway addresses. This ensures that if a receiving Internet Service Provider (ISP) performs a reverse DNS look-up, the email gateway will match the IP address of the email sent through that Virtual Gateway address. This feature is extremely valuable, because many ISPs use a reverse DNS lookup to detect unsolicited email. If the IP address in the reverse DNS look-up does not match the IP address of the sending host, the ISP may assume the sender is illegitimate and will frequently discard the email. The Cisco Virtual Gateway technology ensures that reverse DNS look-ups will always match the sending IP address, preventing messages from being blocked accidentally.

Messages in each Virtual Gateway address are also assigned to a separate message queue. If a certain recipient host is blocking email from one Virtual Gateway address, messages intended for that host will remain in the queue and eventually timeout. But messages intended for the same domain in a different Virtual Gateway queue that is not being blocked will be delivered normally. While these queues are treated separately for delivery purposes, the system administration, logging and reporting capability still provide a holistic view into all Virtual Gateway queues as if they were one.

## Setting Up Virtual Gateway Addresses

Before setting up the Cisco Virtual Gateway addresses, you must allocate a set of IP addresses that will be used to send email from. (For more information, see the “Assigning Network and IP Addresses” appendix.) You should also ensure proper configuration of your DNS servers so that the IP address resolves to a valid hostname. Proper configuration of DNS servers ensures that if the recipient host performs a reverse DNS lookup, it will resolve to valid IP/hostname pairs.

### Related Topics

- [Creating New IP Interfaces for Use with Virtual Gateways, on page 747](#)
- [Mapping Messages to IP Interfaces for Delivery, on page 749](#)
- [Importing an altsrchoost File, on page 750](#)
- [altsrchoost Limits, on page 750](#)
- [Example Text File with Valid Mappings for the altsrchoost Command, on page 750](#)
- [Adding an altsrchoost Mapping through the CLI, on page 751](#)

## Creating New IP Interfaces for Use with Virtual Gateways

After the IP addresses and hostnames have been established, the first step in configuring the Virtual Gateway addresses is to create new IP interfaces with the IP/hostname pairs using the Network > IP Interfaces page in the GUI or the interfaceconfig command in the CLI.

Once the IP interfaces have been configured, you have the option to combine multiple IP interfaces into interface groups; these groups can then be assigned to specific Virtual Gateways addresses which the system cycles through in a “round robin” fashion when delivering email.

After creating the required IP interfaces, you have two options for setting up the Virtual Gateway addresses and defining which email campaign will be sent from each IP interface or interface group:

- You can use the altsrhost command to map email from specific sender IP addresses or Envelope Sender address information to a host IP interface (Virtual Gateway address) or interface group for delivery.
- Using message filters, you can set up specific filters to deliver flagged messages using a specific host IP interface (Virtual Gateway address) or interface group. See [Alter Source Host \(Virtual Gateway address\) Action, on page 204](#). (This method is more flexible and powerful than the one above.)

For more information about creating IP interfaces, see the “Accessing the Email Gateway” appendix.

So far, we have been using an Email Gateway configuration with the following interfaces defined as shown in the following figure.

Figure 52: Example Public and Private interfaces

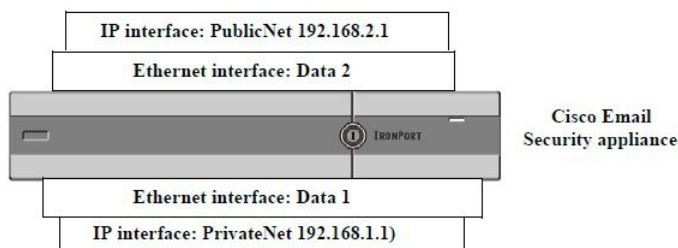

In the following example, the IP Interfaces page confirms that these two interfaces (PrivateNet and PublicNet) have been configured, in addition to the Management interface.

Figure 53: IP Interface Page

### IP Interfaces

Network Interfaces and IP Addresses			
<a href="#">Add IP Interface...</a>			
Name	IP Address	Hostname	Delete
Management	192.168.42.42/24	mail3.example.com	
PrivateNet	192.168.1.1/24	mail3.example.com	
PublicNet	192.168.2.1/24	mail3.example.com	

Next, the Add IP Interface page is used to create a new interface named PublicNet2 on the Data2 Ethernet interface. The IP address of 192.168.2.2 is used, and the hostname of mail4.example.com is specified. The services for FTP (port 21) and SSH (port 22) are then enabled.

Figure 54: Add IP Interface Page

Add IP Interface

IP Interface Settings																									
Name:	PublicNet2																								
Ethernet Port:	Data 2																								
IP Address:	192.168.2.2 *																								
Netmask:	255.255.255.0 *																								
Hostname:	mail4.example.com																								
Services:	<table border="1"> <thead> <tr> <th>Service</th> <th>Port</th> </tr> </thead> <tbody> <tr> <td><input checked="" type="checkbox"/> FTP</td> <td>21</td> </tr> <tr> <td><input checked="" type="checkbox"/> SSH</td> <td>22 *</td> </tr> <tr> <td colspan="2">Appliance Management</td> </tr> <tr> <td><input type="checkbox"/> HTTP</td> <td>80 *</td> </tr> <tr> <td><input type="checkbox"/> HTTPS</td> <td>443 *</td> </tr> <tr> <td colspan="2"><input type="checkbox"/> Redirect HTTP requests to HTTPS (HTTP and HTTPS Services will be turned on)</td> </tr> <tr> <td colspan="2">IronPort Spam Quarantine</td> </tr> <tr> <td><input type="checkbox"/> IronPort Spam Quarantine HTTP</td> <td>82</td> </tr> <tr> <td><input type="checkbox"/> IronPort Spam Quarantine HTTPS</td> <td>83</td> </tr> <tr> <td colspan="2"><input type="checkbox"/> Redirect HTTP requests to HTTPS (HTTP and HTTPS Services will be turned on)</td> </tr> <tr> <td colspan="2"> <input type="checkbox"/> This is the default interface for IronPort Spam Quarantine                      Quarantine login and notifications will originate on this interface.                      URL Displayed in Notifications:  <input type="radio"/> Hostname  <input type="radio"/> <input type="text"/>                      (examples: http://spamQ.url/, http://10.1.1.1:82/)                 </td> </tr> </tbody> </table>	Service	Port	<input checked="" type="checkbox"/> FTP	21	<input checked="" type="checkbox"/> SSH	22 *	Appliance Management		<input type="checkbox"/> HTTP	80 *	<input type="checkbox"/> HTTPS	443 *	<input type="checkbox"/> Redirect HTTP requests to HTTPS (HTTP and HTTPS Services will be turned on)		IronPort Spam Quarantine		<input type="checkbox"/> IronPort Spam Quarantine HTTP	82	<input type="checkbox"/> IronPort Spam Quarantine HTTPS	83	<input type="checkbox"/> Redirect HTTP requests to HTTPS (HTTP and HTTPS Services will be turned on)		<input type="checkbox"/> This is the default interface for IronPort Spam Quarantine Quarantine login and notifications will originate on this interface. URL Displayed in Notifications: <input type="radio"/> Hostname <input type="radio"/> <input type="text"/> (examples: http://spamQ.url/, http://10.1.1.1:82/)	
Service	Port																								
<input checked="" type="checkbox"/> FTP	21																								
<input checked="" type="checkbox"/> SSH	22 *																								
Appliance Management																									
<input type="checkbox"/> HTTP	80 *																								
<input type="checkbox"/> HTTPS	443 *																								
<input type="checkbox"/> Redirect HTTP requests to HTTPS (HTTP and HTTPS Services will be turned on)																									
IronPort Spam Quarantine																									
<input type="checkbox"/> IronPort Spam Quarantine HTTP	82																								
<input type="checkbox"/> IronPort Spam Quarantine HTTPS	83																								
<input type="checkbox"/> Redirect HTTP requests to HTTPS (HTTP and HTTPS Services will be turned on)																									
<input type="checkbox"/> This is the default interface for IronPort Spam Quarantine Quarantine login and notifications will originate on this interface. URL Displayed in Notifications: <input type="radio"/> Hostname <input type="radio"/> <input type="text"/> (examples: http://spamQ.url/, http://10.1.1.1:82/)																									
Warnings - * Please exercise care when disabling or changing these items, as this could disrupt active connections to this appliance when changes to these items are committed. ** Hyperlinks and URLs affected by these changes will not be usable until the changes are committed.																									
Cancel	Submit																								

Our Email Gateway configuration now looks like this:

Figure 55: Adding Another Public Interface

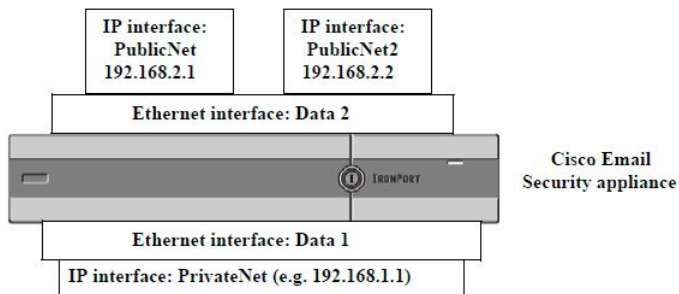

Using Virtual Gateway addresses, a configuration like the one shown in the following figure is also possible.

Figure 56: Four Virtual Gateway Addresses on One Ethernet Interface

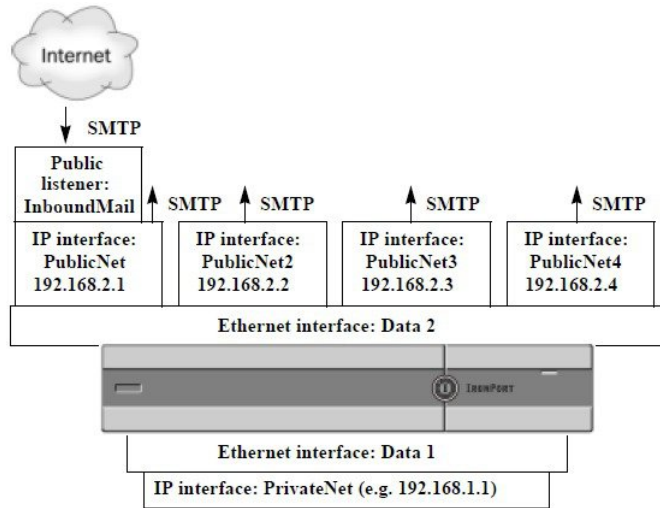

Note that four separate IP interfaces can be used to deliver mail, where only one public listener is configured to accept messages from the Internet.

## Mapping Messages to IP Interfaces for Delivery

The `altsrchost` command provides the simplest and most straightforward method to segment each email gateway into multiple IP interfaces (Virtual Gateway addresses) from which to deliver email. However, users requiring more power and flexibility in mapping messages to particular Virtual Gateways should investigate the use of message filters. See [Using Message Filters to Enforce Email Policies, on page 127](#) for more information.

The `altsrchost` command allows you to control which IP interface or interface group to use during email delivery based on one of the following:

- the sender’s IP address
- the Envelope Sender address

To specify which IP interface or interface group the system will deliver email from, you create mapping keys that pair either the sender’s IP address or the Envelope Sender address to an IP interface or interface group (specified by interface name or group name).

AsyncOS will compare both the IP address and Envelope Sender address to the mapping keys. If either the IP address or Envelope Sender address matches one of the keys, the corresponding IP interface is used for the outbound delivery. If there is no match, the default outbound interface will be used.

The system can match any of the following keys and take preference in the following order:

<b>Sender’s IP address</b>	The IP address of the sender must match exactly. Example: 192.168.1.5
<b>Fully-formed Envelope Sender</b>	The Envelope Sender must match the entire address exactly. Example: username@example.com
<b>Username</b>	The system will match username syntax against the Envelope Sender address up to the @ sign. The @ sign must be included. Example: username@

<b>Domain</b>	The system will match domain name syntax against the Envelope Sender address starting with the @ sign. The @ sign must be included. Example: @example.com
---------------	-----------------------------------------------------------------------------------------------------------------------------------------------------------



**Note** A listener checks the information in the `altsrchoost` table and directs the email to a particular interface *after* checking the masquerading information and *before* message filters are checked.

Use these subcommands within the `altsrchoost` command to create mappings in the Virtual Gateways via the CLI:

Syntax	Description
<code>new</code>	Create a new mapping manually.
<code>print</code>	Display the current list of mappings.
<code>delete</code>	Remove one of the mappings from the table.

## Importing an altsrchoost File

Like the HAT, the RAT, `smtproutes`, and masquerading and alias tables, you can modify `altsrchoost` entries by exporting and importing a file.

### Procedure

- Step 1** Use the `export` subcommand of the `altsrchoost` command to export the existing entries to a file (whose name you specify).
- Step 2** Outside of the CLI, get the file. (See [FTP, SSH, and SCP Access, on page 1303](#) for more information.)
- Step 3** With a text editor, create new entries in the file. The order that rules appear in the `altsrchoost` table is important.
- Step 4** Save the file and place it in the “`altsrchoost`” directory for the interface so that it can be imported. (See [FTP, SSH, and SCP Access, on page 1303](#) for more information.)
- Step 5** Use the `import` subcommand of `altsrchoost` to import the edited file.

## altsrchoost Limits

You can define up to 1,000 `altsrchoost` entries.

## Example Text File with Valid Mappings for the altsrchoost Command

```
# Comments to describe the file

@example.com DemoInterface

paul@ PublicInterface

joe@ PublicInterface

192.168.1.5, DemoInterface
```

```
steve@example.com PublicNet
```

The `import` and `export` subcommands operate on a line-by-line basis and map either the sender IP address or the Envelope Sender address line to the interface name. The key must be the first block of non-space characters followed by the interface name in the second block of non-space characters, separated by a comma (,) or space (.). Comment lines start with a number sign (#) and will be ignored.

## Adding an altsrchoost Mapping through the CLI

In the following example, the `altsrchoost` table is printed to show that there are no existing mappings. Two entries are then created:

- Mail from the groupware server host named `@exchange.example.com` is mapped to the `PublicNet` interface.
- Mail from the sender IP address of `192.168.35.35` (for example, the marketing campaign messaging system) is mapped to the `PublicNet2` interface.

Finally, the `altsrchoost` mappings are printed to confirm and the changes are committed.

```
mail3.example.com> altsrchoost
```

```
There are currently no mappings configured.
```

```
Choose the operation you want to perform:
```

- NEW - Create a new mapping.
- IMPORT - Load new mappings from a file.

```
[ ]> new
```

```
Enter the Envelope From address or client IP address for which you want to set up a Virtual Gateway mapping. Partial addresses such as "@example.com" or "user@" are allowed.
```

```
[ ]> @exchange.example.com
```

```
Which interface do you want to send messages for @exchange.example.com from?
```

1. PublicNet2 (192.168.2.2/24: mail4.example.com)
2. Management (192.168.42.42/24: mail3.example.com)
3. PrivateNet (192.168.1.1/24: mail3.example.com)
4. PublicNet (192.168.2.1/24: mail4.example.com)

```
[1]> 4
```

```
Mapping for @exchange.example.com on interface PublicNet created.
```

```
Choose the operation you want to perform:
```

- NEW - Create a new mapping.
- EDIT - Modify a mapping.
- DELETE - Remove a mapping.
- IMPORT - Load new mappings from a file.
- EXPORT - Export all mappings to a file.

- PRINT - Display all mappings.
- CLEAR - Remove all mappings.

```
[> new
```

Enter the Envelope From address or client IP address for which you want to set up a Virtual Gateway mapping. Partial addresses such as "@example.com" or "user@" are allowed.

```
[> 192.168.35.35
```

Which interface do you want to send messages for 192.168.35.35 from?

1. PublicNet2 (192.168.2.2/24: mail4.example.com)
2. Management (192.168.42.42/24: mail3.example.com)
3. PrivateNet (192.168.1.1/24: mail3.example.com)
4. PublicNet (192.168.2.1/24: mail4.example.com)

```
[1]> 1
```

Mapping for 192.168.35.35 on interface PublicNet2 created.

Choose the operation you want to perform:

- NEW - Create a new mapping.
- EDIT - Modify a mapping.
- DELETE - Remove a mapping.
- IMPORT - Load new mappings from a file.
- EXPORT - Export all mappings to a file.
- PRINT - Display all mappings.
- CLEAR - Remove all mappings.

```
[> print
```

1. 192.168.35.35 -> PublicNet2
2. @exchange.example.com -> PublicNet

Choose the operation you want to perform:

- NEW - Create a new mapping.
- EDIT - Modify a mapping.
- DELETE - Remove a mapping.
- IMPORT - Load new mappings from a file.
- EXPORT - Export all mappings to a file.



```

- PRINT - Display all mappings.
- CLEAR - Remove all mappings.

[]>

mail3.example.com> commit

Please enter some comments describing your changes:

[]> Added 2 altsrchoost mappings

Do you want to save the current configuration for rollback? [Y]> n

Changes committed: Fri May 23 11:42:12 2014 GMT

```

An illustration of the configuration change in this example is shown in the following figure:

**Figure 57: Example: Selecting an IP Interface or Interface Group to Use**

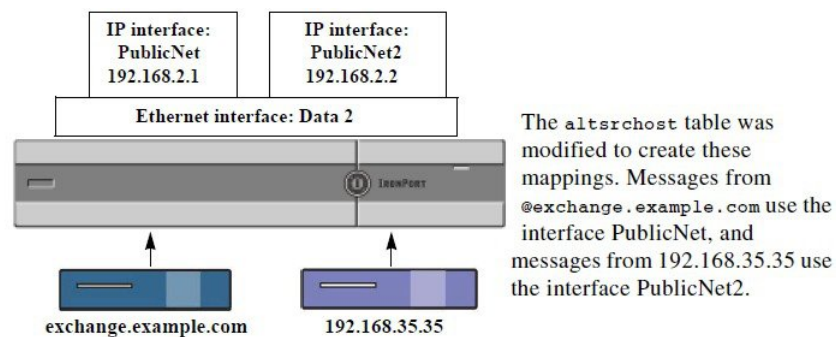

## Monitoring the Virtual Gateway Addresses

While each Virtual Gateway address has its own email queue for delivery purposes, the system administration, logging, and reporting capabilities still provide a holistic view into all Virtual Gateway queues as if they were one. To monitor the recipient host status for each Virtual Gateway queue, use the `hoststatus` and `hostrate` command. See the “Reading the Available Components of Monitoring” section in the “Managing and Monitoring Using the CLI” chapter.

The `hoststatus` command returns monitoring information about email operations relating to a specific recipient host.

If you are using Virtual Gateway technology, information about each Virtual Gateway address is also displayed. The command requires you to input the domain of the host information to be returned. DNS information stored in the AsyncOS cache and the last error returned from the recipient host is also given. Data returned is cumulative since the last `resetcounters` command.

The statistics returned are grouped into two categories: counters and gauges. In addition, other data returned include: last activity, MX records, and last 5XX error.

## Managing Delivery Connections per Virtual Gateway Address

Certain system parameters require settings at the system and Virtual Gateway address levels.

For example, some recipient ISPs limit the number of connections they allow for each client host. Therefore, it is important to manage relationships with the ISPs, especially when email is being delivered over multiple Virtual Gateway addresses.

See [Controlling Email Delivery Using Destination Controls, on page 730](#) for information about the `destconfig` command and how Virtual Gateway addresses are affected.

When you create a “group,” of Virtual Gateway addresses, the good neighbor table settings for Virtual Gateway are applied to the group, even if the group consists of 254 IP addresses.

For example, suppose you have created group of 254 outbound IP addresses set up as a group to cycle through in a “round-robin” fashion, and suppose the good neighbor table for `small-isp.com` is 100 simultaneous connections for the system and 10 connections for Virtual Gateway addresses. This configuration will *never* open more than 10 connections total for all 254 IP addresses in that group; the group is treated as a single Virtual Gateway address.

## Using Global Unsubscribe

To ensure that specific recipients, recipient domains, or IP addresses never receive messages from the email gateway, use the AsyncOS Global Unsubscribe feature. The unsubscribe command allows you to add and delete addresses to a global unsubscribe list, as well as enable and disable the feature. AsyncOS checks all recipient addresses against a list of “globally unsubscribed” users, domains, email addresses, and IP addresses. If a recipient matches an address in the list, the recipient is either dropped or hard bounced, and the Global Unsubscribe (GUS) counter is incremented. (Log files will note whether a matching recipient was dropped or hard bounced.) The GUS check occurs immediately before an attempt to send email to a recipient, thus inspecting all messages sent by the system.



**Note** Global Unsubscribe is not intended to replace the removal of names and general maintenance of mailing lists. The feature is intended to act as a fail-safe mechanism to ensure email does not get delivered to inappropriate entities.

Global Unsubscribe has a maximum limit of 10,000 addresses. Global Unsubscribe addresses can be in one of four forms:

**Table 64: Global Unsubscribe Syntax**

<code>username@example.com</code>	Fully-formed email address This syntax is used to block a specific recipient at a specific domain.
<code>username@</code>	Username The username syntax will block all recipients with the specified username at all domains. The syntax is the username followed by an at sign ( @ ).
<code>@example.com</code>	Domain The domain syntax is used to block all recipients destined for a particular domain. The syntax is the specific domain, preceded by an at sign ( @ ).

@.example.com	<p>Partial Domain</p> <p>The partial domain syntax is used to block all recipients destined for a particular domain and all its subdomains.</p>
10.1.28.12	<p>IP address</p> <p>The IP address syntax is used to block all recipients destined for a particular IP address. This syntax can be useful if a single IP address is hosting multiple domains. The syntax consists of a common dotted octet IP address.</p>

### Related Topics

- [Adding a Global Unsubscribe Address Using The CLI, on page 755](#)
- [Exporting and Importing a Global Unsubscribe File, on page 756](#)

## Adding a Global Unsubscribe Address Using The CLI

In this example, the address `user@example.net` is added to the Global Unsubscribe list, and the feature is configured to hard bounce messages. Messages sent to this address will be bounced; the email gateway will bounce the message immediately prior to delivery.

```
mail3.example.com> unsubscribe
```

```
Global Unsubscribe is enabled. Action: drop.
```

```
Choose the operation you want to perform:
```

- NEW - Create a new entry.
- IMPORT - Import entries from a file.
- SETUP - Configure general settings.

```
[ ]> new
```

```
Enter the unsubscribe key to add. Partial addresses such as
```

```
"@example.com" or "user@" are allowed, as are IP addresses. Partial hostnames such as  
"@.example.com" are allowed.
```

```
[ ]> user@example.net
```

```
Email Address 'user@example.net' added.
```

```
Global Unsubscribe is enabled.
```

```
Choose the operation you want to perform:
```

- NEW - Create a new entry.
- DELETE - Remove an entry.
- PRINT - Display all entries.

```

- IMPORT - Import entries from a file.
- EXPORT - Export all entries to a file.
- SETUP - Configure general settings.
- CLEAR - Remove all entries.

[]> setup

Do you want to enable the Global Unsubscribe feature? [Y]> y

Would you like matching messages to be dropped or bounced?

1. Drop
2. Bounce

[1]> 2

Global Unsubscribe is enabled. Action: bounce.

Choose the operation you want to perform:

- NEW - Create a new entry.
- DELETE - Remove an entry.
- PRINT - Display all entries.
- IMPORT - Import entries from a file.
- EXPORT - Export all entries to a file.
- SETUP - Configure general settings.
- CLEAR - Remove all entries.

[]>

mail3.example.com> commit

Please enter some comments describing your changes:

[]> Added username "user@example.net" to global unsubscribe

Do you want to save the current configuration for rollback? [Y]> n

Changes committed: Fri May 23 11:42:12 2014 GMT

```

## Exporting and Importing a Global Unsubscribe File

Like the HAT, the RAT, smtproutes, static masquerading tables, alias tables, domain map tables, and altsrhost entries, you can modify global unsubscribe entries by exporting and importing a file.

## Procedure

---

- Step 1** Use the export subcommand of the unsubscribe command to export the existing entries to a file (whose name you specify).
- Step 2** Outside of the CLI, get the file. (See [FTP, SSH, and SCP Access, on page 1303](#) for more information.)
- Step 3** With a text editor, create new entries in the file.

Separate entries in the file by new lines. Return representations from all standard operating systems are acceptable (<CR>, <LF>, or <CR><LF>). Comment lines start with a number sign (#) and are ignored. For example, the following file excludes a single recipient email address (test@example.com), all recipients at a particular domain (@testdomain.com), all users with the same name at multiple domains (testuser@), and any recipients at a specific IP address (11.12.13.14).

```
# this is an example of the global_unsubscribe.txt file
test@example.com
@testdomain.com
testuser@
11.12.13.14
```

- Step 4** Save the file and place it in the configuration directory for the interface so that it can be imported. (See [FTP, SSH, and SCP Access, on page 1303](#) for more information.)
- Step 5** Use the import subcommand of unsubscribe to import the edited file.
- 

## Review: Email Pipeline

The following tables provide an overview of how email is routed through the system, from reception to routing to deliver. Each feature is processed in order (from top to bottom) and is briefly summarized. Shaded areas in *Table - Email Pipeline for the Cisco Secure Email Gateway: Routing and Delivery Features* represent processing that occurs in the Work Queue.

You can test most of the configurations of features in this pipeline using the trace command. For more information, see “Debugging Mail Flow Using Test Messages: Trace” in the Troubleshooting chapter.



---

**Note** For outgoing mail, Data Loss Prevention scanning takes place after the Outbreak Filters stage.

---

Table 65: Email Pipeline for the Cisco Secure Email Gateway: Receiving Email Features

Feature	Description
Host Access Table (HAT)	ACCEPT, REJECT, RELAY, or TCPREFUSE connections
Host DNS Sender Verification	Maximum outbound connections Maximum concurrent inbound connections per IP address
Sender Groups	Maximum message size and messages per connection
Envelope Sender Verification	Maximum recipients per message and per hour
Sender Verification Exception Table	TCP listen queue size TLS: no/preferred/required
Mail Flow Policies	SMTP AUTH: no/preferred/required Drop email with malformed FROM headers Always accept or reject mail from entries in the Sender Verification Exception Table. SenderBase on/off (IP profiling/flow control)
Received Header	Adds a received header to accepted email: on/off.
Default Domain	Adds default domain for “bare” user addresses.
Bounce Verification	Used to verify incoming bounce messages as legitimate.
Domain Map	Rewrites the Envelope Recipient for each recipient in a message that matches a domain in the domain map table.
Recipient Access Table (RAT)	(Public listeners only) ACCEPT or REJECT recipients in RCPT TO plus Custom SMTP Response. Allow special recipients to bypass throttling.
Alias tables	Rewrites the Envelope Recipient. (Configured system-wide. aliasconfig is not a subcommand of listenerconfig .)
LDAP Recipient Acceptance	LDAP validation for recipient acceptance occurs within the SMTP conversation. If the recipient is not found in the LDAP directory, the message is dropped or bounced. LDAP validation can be configured to occur within the work queue instead.

Table 66: Email Pipeline for the Email Security Appliance: Routing and Delivery Features

<b>Work Queue</b>	<b>LDAP Recipient Acceptance</b>		LDAP validation for recipient acceptance occurs within the work queue. If the recipient is not found in the LDAP directory, the message is dropped or bounced. LDAP validation can be configured to occur within the SMTP conversation instead.
	<b>Masquerading or LDAP Masquerading</b>		Masquerading occurs in the work queue; it rewrites the Envelope Sender, To:, From:, and/or CC: headers, from a static table or via an LDAP query.
	<b>LDAP Routing</b>		LDAP queries are performed for message routing or address rewriting. Group LDAP queries work in conjunction with message filter rules mail-from-group and rept-to-group .
	<b>Message Filters*</b>		Message Filters are applied prior to message “splintering.” * Can send messages to quarantines.
	<b>Anti-Spam**</b>	<b>Per Recipient Scanning</b>	Anti-spam scanning engine examines messages and returns a verdict for further processing.
	<b>Anti-Virus*</b>		Anti-Virus scanning examines messages for viruses. Messages are scanned and optionally repaired, if possible. * Can send messages to quarantines.
	<b>Advanced Malware Protection</b>		Advanced Malware Protection performs file reputation scanning and file analysis, in order to detect malware in attachments.
	<b>Content Filters*</b>		Content Filters are applied. * Can send messages to quarantines.
	<b>Outbreak Filters*</b>		The Outbreak Filters feature helps protect against virus outbreaks. * Can send messages to quarantines.
	<b>Virtual gateways</b>		Sends mail over particular IP interfaces or groups of IP interfaces.
<b>Delivery limits</b>		1. Sets the default delivery interface. 2. Sets the total maximum number of outbound connections.	
<b>Domain-based Limits</b>		Defines, per-domain: maximum outbound connections for each virtual gateway and for the entire system; the bounce profile to use; the TLS preference for delivery: no/preferred/required	
<b>Domain-based routing</b>		Routes mail based on domain without rewriting Envelope Recipient.	
<b>Global unsubscribe</b>		Drops recipients according to specific list (configured system-wide).	
	<b>Bounce profiles</b>		Undeliverable message handling. Configurable per listener, per Destination Controls entry, and via message filters.

\* These features can send messages to special queues called Quarantines.





## CHAPTER 31

# Integrating the Email Gateway with Cisco Advanced Phishing Protection

---

This chapter contains the following sections:

- [Overview of Cisco Advanced Phishing Protection, on page 761](#)
- [How to Integrate Email Gateway with the Cisco Advanced Phishing Protection Cloud Service, on page 762](#)
- [Advanced Phishing Protection and Clusters, on page 769](#)
- [Advanced Phishing Protection Report Page, on page 769](#)
- [Monitoring Message Metadata on the Cisco Advanced Phishing Protection Cloud Service, on page 770](#)
- [Displaying Messages Submitted to the Cisco Advanced Phishing Protection Cloud Service, on page 770](#)

## Overview of Cisco Advanced Phishing Protection

Cisco Advanced Phishing Protection provides Business Email Compromise (BEC) and phishing detection capabilities. It detects identity deception-based threats by performing reputation checks on sender address by using advanced machine learning techniques and added intelligence. This intelligence continuously adapts to drive a real-time understanding of senders and provides enhanced protection.

The Advanced Phishing Protection engine on the email gateway checks the unique behavior of all legitimate senders, based on the historic email traffic to your organization. The cloud service interface of the Cisco Advanced Phishing Protection provides risk analysis to distinguish good messages from potentially malicious messages.

The Cisco Advanced Phishing Protection cloud service relies on the email gateway as a sensor engine to receive a copy of the message metadata sent inbound into your organization. This sensor engine collects metadata such as message headers from the email gateway and relay them to the Cisco Advanced Phishing Protection cloud service for analysis. After the analysis, potentially malicious messages are remediated from the recipient mailbox automatically, based on the pre-configured policies on the Advanced Phishing Protection cloud service.

The ability to use the email gateway as a sensor engine helps an organization to:

- Identify, investigate, and remediate threats observed on the message headers, from the recipient mailbox.
- View the reporting data of the metadata of the message from multiple email gateways in your organization.

## Benefits of Cisco Advanced Phishing Protection

The following are the benefits of deploying Cisco Advanced Phishing Protection on the email gateway:

- The Sensor-based solution can be rapidly deployed to ensure that your users are fully protected from damaging breaches.
- Provides another layer of defense to more effectively secure your email environment.
- Gain a real-time understanding of senders, learn, and authenticate email identities and behavioral relationships to protect against BEC attacks.
- Automatically remove malicious emails from the recipient's inbox and calls out identity deception techniques to prevent wire fraud or other advanced attacks.
- Get detailed visibility into email attack activity, including total messages secured and attacks prevented.
- Prevents the following:
  - Attacks that use compromised accounts and social engineering.
  - Phishing, ransomware, zero-day attacks and spoofing.
  - BEC with no malicious payload or URL.

## Workflow

1. Activate the license to access the Cisco Advanced Phishing Protection cloud service.
2. Set up the email gateway as a sensor engine on the Cisco Advanced Phishing Protection cloud service. This deploys the email gateway as a lightweight sensor via the cloud or on-premise.
3. Register the sensor engine on the email gateway with the Cisco Advanced Phishing Protection cloud service.
4. The sensor engine on the email gateway forwards the metadata of messages considered clean, to the Cisco Advanced Phishing Protection cloud service.
5. The Cisco Advanced Phishing Protection cloud service determines if the message metadata is malicious.
6. Pre-configured policies on the Cisco Advanced Phishing Protection cloud service, when configured with an 'Enforcement' sensor, blocks or redirects the message for further incident investigation.

## How to Integrate Email Gateway with the Cisco Advanced Phishing Protection Cloud Service

Perform these steps in the following order:

**Procedure**

	<b>Command or Action</b>	<b>Purpose</b>
<b>Step 1</b>	Review the prerequisites.	<a href="#">Prerequisites, on page 763</a>
<b>Step 2</b>	Obtain the provisioning key from Cisco Advanced Phishing Protection cloud service.	<a href="#">Obtaining the Provisioning Key from the Cisco Advanced Phishing Protection Cloud Service, on page 764</a>
<b>Step 3</b>	Register your email gateway as a sensor engine with the Cisco Advanced Phishing Protection cloud service.	<a href="#">Registering the Cisco Advanced Phishing Protection Sensor on the Email Gateway, on page 764</a>
<b>Step 4</b>	Enable Advanced Phishing Protection on the email gateway.	<a href="#">Enabling Advanced Phishing Protection on the Email Gateway, on page 765</a>
<b>Step 5</b>	Obtaining API Access Keys from the Cisco Advanced Phishing Protection cloud service.	<a href="#">Obtaining API Access Keys from Cisco Advanced Phishing Protection Cloud Service, on page 766</a>
<b>Step 6</b>	Configure incoming mail policies to enable forwarding of message metadata.	<a href="#">Configuring Incoming Mail Policies to Enable Forwarding of Message Metadata, on page 767</a>
<b>Step 7</b>	Monitor metadata of message forwarded to the Advanced Phishing Protection Cloud Service.	<a href="#">Monitoring Message Metadata on the Cisco Advanced Phishing Protection Cloud Service, on page 768</a>

**Prerequisites**

- [Activating the Account for Cisco Advanced Phishing Protection Cloud Service, on page 763](#)
- [Installing Sensors on the Cisco Advanced Phishing Protection Cloud Service, on page 763](#)

**Activating the Account for Cisco Advanced Phishing Protection Cloud Service**

Make sure that you have:

- Obtained a license to access the Cisco Advanced Phishing Protection cloud service from the following URL - <https://www.cisco.com/c/en/us/buy.html>.
- Activated your account using the activation link that you receive through an email notification to get provisioned with the Cisco Advanced Phishing Protection cloud service.

**Installing Sensors on the Cisco Advanced Phishing Protection Cloud Service**

Make sure that you have setup your email gateway as sensor engine as per your organizational requirements. For more information, see *User Guide for Cisco Advanced Phishing Protection*.

## Obtaining the Provisioning Key from the Cisco Advanced Phishing Protection Cloud Service

### Before you begin

Make sure that you have access to Cisco Advanced Phishing Protection cloud service with admin access rights. For more information, see [Prerequisites, on page 763](#). If you are unable to access the Cisco Advanced Phishing Protection cloud service, contact Cisco TAC for assistance.

### Procedure

---

- Step 1** Log in to the Cisco Advanced Phishing Protection cloud service.
- Step 2** Choose **Manage > Sensors**.
- Step 3** Select **Installation > Download Sensor Installer**.
- Step 4** From the drop-down, select the sensor installation script configured as per your organizational requirements. For example: Cisco SEG.
- For more information, see [Installing Sensors on the Cisco Advanced Phishing Protection Cloud Service, on page 763](#).
- Step 5** Copy the 6-word provisioning key.

Use this provisioning key to configure the Cisco Email Security Gateway as a sensor.

**Note** To register the email gateway as a sensor, you must use the provisioning key within 7 days of generation.

---

### What to do next

Register your email gateway with the Cisco Advanced Phishing Protection cloud service. For more information, see [Registering the Cisco Advanced Phishing Protection Sensor on the Email Gateway, on page 764](#).

## Registering the Cisco Advanced Phishing Protection Sensor on the Email Gateway

### Before you begin

Make sure that you have:

- A valid provisioning key to register your email gateway with the Advanced Phishing Protection cloud service. For more information, see [Obtaining the Provisioning Key from the Cisco Advanced Phishing Protection Cloud Service, on page 764](#).
- Opened HTTPS (In and Out) 443 port on the firewall for the FQDNs to register your email gateway with the Cisco Advanced Phishing Protection cloud service.

## Procedure

---

- Step 1** Log in to the email gateway.
- Step 2** Go to **Security Services > Advanced Phishing Protection**.
- Step 3** Click **Register**.
- Step 4** From the URL drop-down, select the region of the Cisco Advanced Phishing Protection cloud service.
- Step 5** Enter the 6-word provisioning key obtained from the Advanced Phishing Protection cloud service.
- Step 6** Click **Register** to submit your changes.

The Cisco Advanced Phishing Protection cloud service generates a Universally Unique ID (UUID) after you register your email gateway with the sensor.

**Note** After successful registration, the Cisco Advanced Phishing Protection cloud service identifies the email gateway's hostname in the cloud service.

---

## What to do next

Enable Cisco Advanced Phishing Protection engine on the email gateway. For more information, see [Enabling Advanced Phishing Protection on the Email Gateway, on page 765](#).

# Enabling Advanced Phishing Protection on the Email Gateway

## Before you begin

Make sure that you have registered your email gateway as a sensor on the Cisco Advanced Phishing Protection cloud service. For more information, see [Registering the Cisco Advanced Phishing Protection Sensor on the Email Gateway, on page 764](#).

## Procedure

---

- Step 1** Log in to the email gateway.
  - Step 2** Go to **Security Services > Advanced Phishing Protection**.
  - Step 3** Click **Enable**.
  - Step 4** Commit your changes.
- 

## What to do next

Enable forwarding of message metadata to the Cisco Advanced Phishing Protection cloud service. For more information, see [Configuring Incoming Mail Policies to Enable Forwarding of Message Metadata, on page 767](#).

# Obtaining API Access Keys from Cisco Advanced Phishing Protection Cloud Service

You can use the API access keys to perform the following tasks in your email gateway:

- Send email notification alerts about APP license expiry details to users.
- View total number of messages that are sent from all email gateways at the organizational level to the Cisco Advanced Phishing Protection cloud service in a dashboard widget. The dashboard widget is available on the Advanced Phishing Protection report page of the new web interface.

## Before you begin

Make sure that you have:

- Registered the email gateway as a sensor on the Cisco Advanced Phishing Protection cloud service. For more information, see [Registering the Cisco Advanced Phishing Protection Sensor on the Email Gateway, on page 764](#).
- Enabled Advanced Phishing Protection on the email gateway. For more information, see [Enabling Advanced Phishing Protection on the Email Gateway, on page 765](#).

## Procedure

---

- Step 1** Log in to the Cisco Advanced Phishing Protection cloud service.
- Step 2** Choose **Manage > Users**.
- Step 3** Click the required username.
- Step 4** Click **Generate API Secret** link to generate the API Access keys.
- Step 5** Copy the **API Access UID** and **API Access Secret** keys locally on your system.

**Note** In case if you do not copy the API Access keys and close the Cisco Advanced Phishing Protection cloud service, you need to follow steps **1-3** of the procedure and click **Regenerate API Secret** link to obtain new API Access keys.

- Step 6** Log in to the legacy web interface of your email gateway.
- Step 7** Go to **Security Services > Advanced Phishing Protection**.
- Step 8** Click **Edit Settings** under 'Advanced Phishing Protection API Access' section.
- Step 9** Enter the **API Access UID** key in the 'API Access UID' field.
- Step 10** Enter the **API Access Secret** key in the 'API Access key field'.
- Step 11** Click **Submit**.
- 

## What to do next

Enable forwarding of message metadata to the Cisco Advanced Phishing Protection cloud service. For more information, see [Configuring Incoming Mail Policies to Enable Forwarding of Message Metadata, on page 767](#).

## Configuring Incoming Mail Policies to Enable Forwarding of Message Metadata

You can configure mail policies to enable forwarding of message metadata to the Cisco Advanced Phishing Protection cloud service.

When you enable the Cisco Advanced Phishing Protection cloud service on your email gateway, the following message headers are shared with the Cisco Advanced Phishing Protection Cloud service :

- Authentication-Results
- Authentication-Results-original
- DMARC-result
- DKIM-domain
- DKIM-result
- DKIM-selector
- DKIM-signatures
- From-header
- Full-Header-From
- HELO\_domain
- Last-Hop-IP-Address
- List-ID
- Mail-From
- Mailing-list
- Message-ID
- Rcpt-To
- Received-Header
- Received-SPF
- Received-Timestamps
- Reply-To
- SPF-result
- Subject-header
- To-header
- Originator-Return-Address
- X-Mailer
- X-Original-Authentication-Results
- X-Original-From

- X-Original-To
- X-Original-Sender
- X-Originating-IP
- X-OriginatorOrg
- X-Received

### Before you begin

Make sure that you have:

- Registered the email gateway as a sensor on the Cisco Advanced Phishing Protection cloud service. For more information, see [Registering the Cisco Advanced Phishing Protection Sensor on the Email Gateway, on page 764](#).
- Enabled Advanced Phishing Protection on the email gateway. For more information, see [Enabling Advanced Phishing Protection on the Email Gateway, on page 765](#).

### Procedure

---

- Step 1** Log in to the email security gateway.
  - Step 2** Go to **Mail Policies > Incoming Mail Policies**.
  - Step 3** Click the link below APP Filter.
  - Step 4** Select **Enable Advanced Phishing Protection (Customize Settings)** from the drop-down list.
  - Step 5** Select the check box for **Enable Forwarding**.
  - Step 6** Click **Submit** and commit your changes.
- 

## Monitoring Message Metadata on the Cisco Advanced Phishing Protection Cloud Service

You can monitor metadata of the message that your email security gateway forwards to the Cisco Advanced Phishing Protection cloud service. The Analyze > Messages page of the cloud service provides insights on the source of the message and the risk associated with the message and the senders.

The metadata of the message on the Cisco Advanced Phishing Protection cloud service receives a trust score based on the following:

- Message Authenticity
- Domain Reputation
- Sender Legitimacy



# Advanced Phishing Protection and Clusters

If you use centralized management, you can enable the Advanced Phishing Protection at the cluster, group, and machine level. If you have registered your email gateway with the Cisco Advanced Phishing Protection cloud service in standalone mode, you can choose to join a cluster registered with the Cisco Advanced Phishing Protection cloud service.



---

**Note** When you disable the Advanced Phishing Protection at the machine level, the same is disabled on the group and cluster levels.

---

## Advanced Phishing Protection Report Page

The **Monitor > Advanced Phishing Protection** report page displays the following:

- Total number of messages successfully forwarded to the Cisco Advanced Phishing Protection cloud service.
- Total number of messages that are not forwarded to the Cisco Advanced Phishing Protection cloud service.



---

**Note** If the forwarding of message metadata has failed, you must validate the configurations of the Advanced Phishing Protection feature. For more information, see [How to Integrate Email Gateway with the Cisco Advanced Phishing Protection Cloud Service, on page 762](#).

---

You can use the Advanced Phishing Protection report page to view:

- Total number of messages attempted to be forwarded to the Cisco Advanced Phishing Protection cloud service, in a graphical format.
- Summary of messages forwarded to the Cisco Advanced Phishing Protection cloud service in a graphical format.

To view the detailed information on the metadata of the message that is forwarded to the Cisco Advanced Phishing Protection cloud service, click on the link and login to the Cisco Advanced Phishing Protection cloud service. For more information, see [Monitoring Message Metadata on the Cisco Advanced Phishing Protection Cloud Service, on page 768](#).

# Monitoring Message Metadata on the Cisco Advanced Phishing Protection Cloud Service

You can monitor metadata of the message that your email security gateway forwards to the Cisco Advanced Phishing Protection cloud service. The Analyze > Messages page of the cloud service provides insights on the source of the message and the risk associated with the message and the senders.

The metadata of the message on the Cisco Advanced Phishing Protection cloud service receives a trust score based on the following:

- Message Authenticity
- Domain Reputation
- Sender Legitimacy

# Displaying Messages Submitted to the Cisco Advanced Phishing Protection Cloud Service

You can view the metadata of the message that you forward to the Cisco Advanced Phishing Protection cloud service corresponding to the success and failure.

## Before you begin

Make sure that you enable the Message Tracking feature on the email gateway. To enable Message Tracking, go to **Security Services > Centralized Services > Message Tracking** page in the web interface.

## Procedure

---

- Step 1** Log in to the email security gateway.
  - Step 2** Go to **Monitor > Message Tracking**.
  - Step 3** Click **Advanced**.
  - Step 4** Check **Advanced Phishing Protection Forwarding** under Message Event.
  - Step 5** (Optional) Select **Select Successful** to view messages that are forwarded successfully to the Cisco Advanced Phishing Protection cloud service.
  - Step 6** (Optional) Select **Failed** to view messages that are not forwarded to the Cisco Advanced Phishing Protection cloud service.
  - Step 7** Click **Search**.
-



## CHAPTER 32

# LDAP Queries

---

This chapter contains the following sections:

- [Overview of LDAP Queries, on page 771](#)
- [Working with LDAP Queries, on page 781](#)
- [Using Acceptance Queries For Recipient Validation, on page 788](#)
- [Using Routing Queries to Send Mail to Multiple Target Addresses, on page 789](#)
- [Using Masquerading Queries to Rewrite the Envelope Sender, on page 790](#)
- [Using Group LDAP Queries to Determine if a Recipient is a Group Member, on page 792](#)
- [Using Domain-based Queries to Route to a Particular Domain, on page 795](#)
- [Using Chain Queries to Perform a Series of LDAP Queries, on page 797](#)
- [Using LDAP For Directory Harvest Attack Prevention, on page 798](#)
- [Configuring AsyncOS for SMTP Authentication, on page 800](#)
- [Configuring External LDAP Authentication for Users, on page 808](#)
- [Authenticating End-Users of the Spam Quarantine, on page 811](#)
- [Spam Quarantine Alias Consolidation Queries, on page 812](#)
- [Sample User Distinguished Name Settings, on page 814](#)
- [Configuring AsyncOS To Work With Multiple LDAP Servers, on page 814](#)
- [Testing Servers and Queries, on page 815](#)

## Overview of LDAP Queries

If you store user information within LDAP directories in your network infrastructure — for example, in Microsoft Active Directory, SunONE Directory Server, or OpenLDAP directories — you can configure the email gateway to query your LDAP servers to accept, route, and authenticate messages. You can configure the email gateway to work with one or multiple LDAP servers.

The following section provides an overview on the types of LDAP queries you can perform; how LDAP works with the email gateway to authenticate, accept, and route messages; and how to configure your email gateway to work with LDAP.

### Related Topics

- [Understanding LDAP Queries, on page 772](#)
- [Understanding How LDAP Works with AsyncOS, on page 773](#)
- [Configuring the Email Gateway to Work with an LDAP Server, on page 774](#)

- [Creating LDAP Server Profiles to Store Information About the LDAP Server, on page 774](#)
- [Testing LDAP Servers, on page 776](#)
- [Enabling LDAP Queries to Run on a Particular Listener, on page 776](#)
- [Enhanced Support for Microsoft Exchange 5.5, on page 779](#)

## Understanding LDAP Queries

If you store user information within LDAP directories in your network infrastructure, you can configure the email gateway to query your LDAP server for the following purposes:

- **Acceptance Queries.** You can use your existing LDAP infrastructure to define how the recipient email address of incoming messages (on a public listener) should be handled. For more information, see [Using Acceptance Queries For Recipient Validation, on page 788](#).
- **Routing (Aliasing).** You can configure the email gateway to route messages to the appropriate address and/or mail host based upon the information available in LDAP directories on your network. For more information, see [Using Routing Queries to Send Mail to Multiple Target Addresses, on page 789](#).
- **Certificate Authentication.** You can create a query that checks the validity of a client certificate in order to authenticate an SMTP session between the user's mail client and the email gateway. For more information, see [Checking the Validity of a Client Certificate, on page 821](#).
- **Masquerading.** You can masquerade Envelope Senders (for outgoing mail) and message headers (for incoming mail, such as To:, Reply To:, From: or CC:). For more information about masquerading, see [Using Masquerading Queries to Rewrite the Envelope Sender, on page 790](#).
- **Group Queries.** You can configure the email gateway to perform actions on messages based on the groups in the LDAP directory. You do this by associating a group query with a message filter. You can perform any message action available for message filters on messages that match the defined LDAP group. For more information, see [Using Group LDAP Queries to Determine if a Recipient is a Group Member, on page 792](#).
- **Domain-based Queries.** You can create domain-based queries to allow the email gateway to perform different queries for different domains on a single listener. When the email gateway runs the domain-based queries, it determines the query to use based on the domain, and it queries the LDAP server associated with that domain.
- **Chain Queries.** You can create a chain query to enable the email gateway to perform a series of queries in sequence. When you configure a chain query, the email gateway runs each query in sequence until the LDAP appliance returns a positive result. For chained routing queries, the email gateway re-runs the same configured chain query in sequence for each rewritten email address.
- **Directory Harvest Prevention.** You can configure the email gateway to combat directory harvest attacks using your LDAP directories. You can configure directory harvest prevention during the SMTP conversation or within the work queue. If the recipient is not found in the LDAP directory, you can configure the system to perform a delayed bounce or drop the message entirely. Consequently, spammers are not able to differentiate between valid and invalid email addresses. See [Using LDAP For Directory Harvest Attack Prevention, on page 798](#).
- **SMTP Authentication.** AsyncOS provides support for SMTP authentication. SMTP Auth is a mechanism for authenticating clients connected to an SMTP server. You can use this functionality to enable users at your organization to send mail using your mail servers even if they are connecting remotely (e.g. from home or while traveling). For more information, see [Configuring AsyncOS for SMTP Authentication, on page 800](#).
- **External Authentication.** You can configure your email gateway to use your LDAP directory to authenticate users logging in to the email gateway. For more information, see [Configuring External LDAP Authentication for Users, on page 808](#).

- **Spam Quarantine End-User Authentication.** You can configure your email gateway to validate users when they log in to the end-user quarantine. For more information, see [Authenticating End-Users of the Spam Quarantine, on page 811](#).
- **Spam Quarantine Alias Consolidation.** If you use email notifications for spam, this query consolidates the end-user aliases so that end-users do not receive quarantine notices for each aliased email address. For more information, see [Spam Quarantine Alias Consolidation Queries, on page 812](#).

## Understanding How LDAP Works with AsyncOS

When you work with LDAP directories, the email gateway can be used in conjunction with an LDAP directory server to accept recipients, route messages, and/or masquerade headers. LDAP group queries can also be used in conjunction with message filters to create rules for handling messages as they are received by the email gateway.

The following figure demonstrates how the email gateway works with LDAP:

**Figure 58: LDAP Configuration**

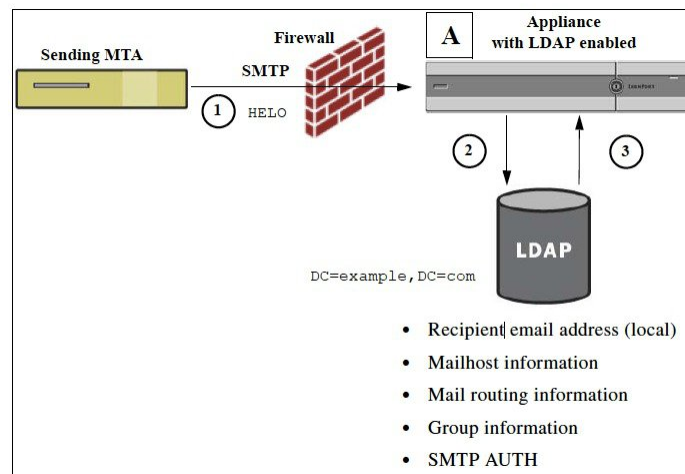

1. The sending MTA sends a message to the public listener “A” via SMTP.
2. The email gateway queries the LDAP server defined via the **System Administration > LDAP** page (or by the global `ldapconfig` command).
3. Data is received from the LDAP directory, and, depending on the queries defined on the **System Administration > LDAP** page (or in the `ldapconfig` command) that are used by the listener:
  - the message is routed to the new recipient address, or dropped or bounced
  - the message is routed to the appropriate mailhost for the new recipient
  - From:, To:, and CC: message headers are re-written based upon the query
  - further actions as defined by `rcpt-to-group` or `mail-from-group` message filter rules (used in conjunction with configured group queries).



**Note** You can configure your email gateway to connect to multiple LDAP servers. When you do this, you can configure the LDAP profile settings for load-balancing or failover. For more information about working with multiple LDAP servers, see [Configuring AsyncOS To Work With Multiple LDAP Servers, on page 814](#).

## Configuring the Email Gateway to Work with an LDAP Server

When you configure your email gateway to work with an LDAP directory, you must complete the following steps to configure your AsyncOS email gateway for acceptance, routing, aliasing, and masquerading:

### Procedure

---

**Step 1** **Configure LDAP server profiles.** The server profile contains information to enable AsyncOS to connect to the LDAP server (or servers), such as:

- the name of the server (s) and port to send queries,
- the base DN, and
- the authentication requirements for binding to the server

For more information about configuring a server profile, see [Creating LDAP Server Profiles to Store Information About the LDAP Server, on page 774](#).

When you configure the LDAP server profile, you can configure AsyncOS to connect to one or multiple LDAP servers.

For information about configuring AsyncOS to connect to multiple servers, see [Configuring AsyncOS To Work With Multiple LDAP Servers, on page 814](#).

**Step 2** **Configure the LDAP query.** You configure the LDAP queries on the LDAP server profile. The query you configure should be tailored to your particular LDAP implementation and schema.

For information on the types of LDAP queries you can create, see [Understanding LDAP Queries, on page 772](#).

For information on writing queries, see [Working with LDAP Queries, on page 781](#).

**Step 3** **Enable the LDAP server profile on a public listener or on a private listener.** You must enable the LDAP server profile on a listener to instruct the listener to run the LDAP query when accepting, routing, or sending a message.

For more information, see [Enabling LDAP Queries to Run on a Particular Listener, on page 776](#).

**Note** When you configure a group query, you need to take additional steps to configure AsyncOS to work with the LDAP server. For information on configuring a group query, see [Using Group LDAP Queries to Determine if a Recipient is a Group Member, on page 792](#). When you configure an end-user authentication or spam notification consolidation query, you must enable LDAP end-user access to the Spam Quarantine. For more information on the Spam Quarantine, see the Spam Quarantine chapter.

---

## Creating LDAP Server Profiles to Store Information About the LDAP Server

When you configure AsyncOS to use LDAP directories, you create an LDAP server profile to store the information about the LDAP server.

## Procedure

---

- Step 1** On the **System Administration > LDAP** page, click **Add LDAP Server Profile**.
- Step 2** Enter a name for the server profile.
- Step 3** Enter the host name for the LDAP server.
- You can enter multiple host names to configure the LDAP servers for failover or load-balancing. Separate multiple entries with commas. For more information, see [Configuring AsyncOS To Work With Multiple LDAP Servers, on page 814](#).
- Step 4** Select an authentication method. You can use anonymous authentication or specify a username and passphrase.
- Step 5** Select the LDAP server type: Active Directory, OpenLDAP, or Unknown or Other.
- Step 6** Enter a port number.
- The default port is 3268 without SSL and 3269 with SSL for Active Directory or any Unknown / Other server types.
- The default port is 389 without SSL and 636 with SSL, for Open LDAP server types.
- Step 7** Enter a Base DN (distinguishing name) for the LDAP server.
- If you authenticate with a username and a passphrase, the username must include the full DN to the entry that contains the passphrase. For example, a user is a member of the marketing group with an email address of joe@example.com. The entry for this user would look like the following entry:
- ```
uid=joe, ou=marketing, dc=example dc=com
```
- Step 8** Select whether to use SSL when communicating with the LDAP server.
- Note** [Optional - Only if the 'Validate LDAP Server Certificate' option is selected in the LDAP Global Settings page and FQDN validation enabled in SSL Configuration settings page]: Check whether the 'Common Name,' 'SAN: DNS Name' fields, or both present in the server certificate, are in the FQDN format.
- Note** [Optional - Only if the 'Validate LDAP Server Certificate' option is selected in the LDAP Global Settings page and X 509 validation enabled in SSL Configuration settings page]: Check for signature algorithm of the server certificate.
- Step 9** Under Advanced, enter cache time-to-live. This value represents the amount of time to retain caches.
- Step 10** Enter the maximum number of retained cache entries.
- Note** This cache is maintained per LDAP server. If you are configuring more than one LDAP servers, you must set a smaller LDAP cache value for better performance. Also, if the memory usage of various processes in the email gateway is high, increasing this value may reduce the system performance.
- Step 11** Enter the number of simultaneous connections.
- If you configure the LDAP server profile for load balancing, these connections are distributed among the listed LDAP servers. For example, if you configure 10 simultaneous connections and load balance the connections over three servers, AsyncOS creates 10 connections to each server, for a total of 30 connections.

**Note** The maximum number of simultaneous connections includes LDAP connections used for LDAP queries. However, the email gateway may open more connections if you use LDAP authentication for the Spam Quarantine.

- You can configure the maximum time (in seconds) for which the connections to the LDAP server must persist before the connections reset. Choose a value between 60 and 86400.

**Step 12** Test the connection to the server by clicking the Test Server(s) button. If you specified multiple LDAP servers, they are all tested. The results of the test appear in the Connection Status field. For more information, see [Testing LDAP Servers, on page 776](#).

**Step 13** Create queries by marking the checkbox and completing the fields. You can select Accept, Routing, Masquerade, Group, SMTP Authentication, External Authentication, Spam Quarantine End-User Authentication, and Spam Quarantine Alias Consolidation.

**Note** To allow the email gateway to run LDAP queries when you receive or send messages, you must enable the LDAP query on the appropriate listener. For more information, see [Enabling LDAP Queries to Run on a Particular Listener, on page 776](#).

**Step 14** Test a query by clicking the **Test Query** button.

Enter the test parameters and click Run Test. The results of the test appear in the Connection Status field. If you make any changes to the query definition or attributes, click **Update**. For more information, see [Testing LDAP Servers, on page 776](#).

**Note** If you have configured the LDAP server to allow binds with empty passphrases, the query can pass the test with an empty passphrase field.

**Step 15** Submit and commit your changes.

**Note** Although the number of server configurations is unlimited, you can configure only one recipient acceptance, one routing, one masquerading, and one group query per server.

---

## Testing LDAP Servers

Use the Test Server(s) button on the Add/Edit LDAP Server Profile page (or the test subcommand of the `ldapconfig` command in the CLI) to test the connection to the LDAP server. AsyncOS displays a message stating whether the connection to the server port succeeded or failed. If you configured multiple LDAP servers, AsyncOS tests each server and displays individual results.

## Enabling LDAP Queries to Run on a Particular Listener

To allow the email gateway to run LDAP queries when you receive or send messages, you must enable the LDAP query on the appropriate listener.

### Related Topics

- [Configuring Global Settings for LDAP Queries, on page 777](#)
- [Example of Creating an LDAP Server Profile, on page 777](#)



- [Enabling LDAP Queries on a Public Listener, on page 778](#)
- [Enabling LDAP Queries on a Private Listener, on page 779](#)

## Configuring Global Settings for LDAP Queries

The LDAP global settings define how the email gateway handles all LDAP traffic.

### Procedure

- 
- Step 1** On the **System Administration > LDAP** page, click **Edit Settings**.
- Step 2** Select the IP interface to use for LDAP traffic. The email gateway automatically chooses an interface by default.
- Step 3** Select the TLS certificate to use for the LDAP interface (TLS certificates added via the **Network > Certificates** page or the **certconfig** command in the CLI are available in the list, see [Overview of Encrypting Communication with Other MTAs, on page 671](#)).
- Step 4** Select appropriate option, if you want to validate the LDAP server certificate.
- Step 5** Submit and commit your changes.
- 

## Example of Creating an LDAP Server Profile

In the following example, the System Administration > LDAP page is used to define an LDAP server for the email gateway to bind to, and queries for recipient acceptance, routing, and masquerading are configured.



- Note** There is a 60 second connection attempt time-out for LDAP connections (which covers the DNS lookup, the connection itself, and, if applicable, the authentication bind for the email gateway itself). After the first failure, AsyncOS immediately starts trying other hosts in the same server (if you specified more than one in the comma separated list). If you only have one host in the server, AsyncOS continues attempting to connect to it.

**Figure 59: Configuring an LDAP Server Profile (1 of 2)**

| LDAP Server Settings      |  |
|---------------------------|--|
| Server Attributes         |  |
| LDAP Server Profile Name: | PublicLDAP   |
| Host Name(s):             | myldapsrvr.example.com<br><small>Fully qualified hostname or IP, separate multiple entries with a comma</small>                                    |
| Authentication Method:    | <input type="radio"/> Anonymous<br><input checked="" type="radio"/> Use Password<br>Username: cn=anonymous<br>Password: *****                      |
| Server Type: ?            | Active Directory   |
| Port: ?                   | 3268   |
| Base DN: ?                | dc=example, dc=com   |
| Connection Protocol:      | <input type="checkbox"/> Use SSL   |
| Advanced:                 | Cache TTL (time-to-live): 900 Seconds<br>Maximum Retained Cache Entries: 10000<br>Maximum number of simultaneous connections for each host: 10     |
| Multiple host options:    | <input checked="" type="radio"/> Load-balance connections among all hosts listed<br><input type="radio"/> Failover connections in the order listed |
| Server Attribute Testing: | <a href="#">Test Server(s)</a>   |

First, the nickname of “PublicLDAP” is given for the myldapserver.example.com LDAP server. The number of connections is set to 10 (the default), and the multiple LDAP server (hosts) load balance option is left as the default. You can specify multiple hosts here by providing a comma separated list of names. Queries are directed to port 3268 (the default). SSL is not enabled as the connection protocol for this host. The base DN of example.com is defined ( dc=example,dc=com ). The cache time-to-live is set to 900 seconds, the maximum number of cache entries is 10000, and the authentication method is set to passphrase.

Queries for recipient acceptance, mail routing, and masquerading are defined. Remember that query names are case-sensitive and must match exactly in order to return the proper results.

**Figure 60: Configuring an LDAP Server Profile (2 of 2)**

|   |  |
|---|--|
| <input checked="" type="checkbox"/> Accept Query  |  |
| Name:   | PublicLDAP.accept  |
| Query String:   | {proxyAddresses=smtp:{a}} <input type="button" value="Test Query"/>  |
| <input checked="" type="checkbox"/> Routing Query   |  |
| Name:   | PublicLDAP.routing   |
| Query String:   | {mailLocalAddress={a}} <input type="button" value="Test Query"/>   |
| Recipient Email to Rewrite the Envelope Header:   | mailRoutingAddress   |
| Alternative Mailhost Attribute:   | mailHost   |
| SMTP Call-Ahead Server Attribute (optional):  | <small>This attribute is used only if an SMTP Call-Ahead server is configured. Go to Network &gt; SMTP Call-Ahead.</small> |
| <input checked="" type="checkbox"/> Masquerade Query  |  |
| Name:   | PublicLDAP.masquerade  |
| Query String:   | {mailRoutingAddress={a}} <input type="button" value="Test Query"/>   |
| Attribute Containing Externally Visible Full Email Address:   | mailLocalAddress   |
| Do you want the results of the returned attribute to replace the entire friendly portion of the original recipient? | <input checked="" type="radio"/> Yes<br><input type="radio"/> No   |

## Enabling LDAP Queries on a Public Listener

In this example, the public listener “InboundMail” is updated to use LDAP queries for recipient acceptance. Further, recipient acceptance is configured to happen during the SMTP conversation (for more information, see [Using Acceptance Queries For Recipient Validation, on page 788](#) for more information).

**Figure 61: Enabling Acceptance and Routing Queries on a Listener**

|  |                                   |
|--|-----------------------------------|
| LDAP Queries:  | Accept                            |
| Accept Query:  | exampleTest.accept                |
| <input type="radio"/> Work Queue   |                                   |
| Non-Matching Recipients:   | Bounce                            |
| <input checked="" type="radio"/> SMTP Conversation   |                                   |
| If the LDAP server is unreachable:   |                                   |
| <input type="radio"/> Allow Mail in  |                                   |
| <input checked="" type="radio"/> Drop Connection, return error code:   |                                   |
| Code:  | 451                               |
| Text:  | Temporary recipient validation er |
| When the Directory Harvest Attack Prevention threshold (maximum invalid recipients per hour) is reached:   |                                   |
| Code:  | 550                               |
| Text:  | Too many invalid recipients       |
| <input checked="" type="checkbox"/> Drop Connection if the Directory Harvest Attack Prevention threshold (maximum invalid recipients per hour) is reached within an SMTP conversation. |                                   |
| <input type="button" value="Routing"/>   |                                   |
| <input type="button" value="Masquerade"/>  |                                   |
| <input type="button" value="Group"/>   |                                   |

## Enabling LDAP Queries on a Private Listener

In this example, the private listener “OutboundMail” is updated to use LDAP queries for masquerading. The masqueraded fields include: From, To, CC, and Reply-To.

**Figure 62: Enabling a Masquerading Query on a Listener**

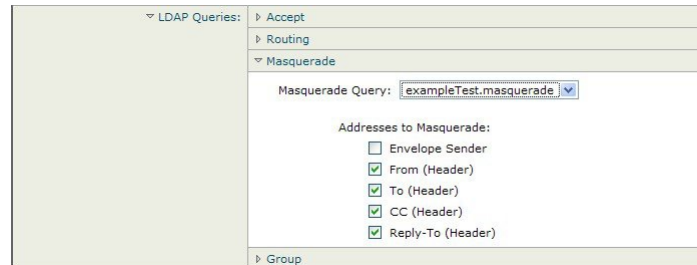

## Enhanced Support for Microsoft Exchange 5.5

AsyncOS includes a configuration option to provide support for Microsoft Exchange 5.5. If you use a later version of Microsoft Exchange, you do not need to enable this option. When configuring an LDAP server, you can elect to enable Microsoft Exchange 5.5 support by answering “y” when prompted in the `ldapconfig` `-> edit -> server -> compatibility` subcommand (this is only available via the CLI):

```
mail3.example.com> ldapconfig

Current LDAP server configurations:

1. PublicLDAP: (ldapexample.com:389)

Choose the operation you want to perform:

- NEW - Create a new server configuration.
- EDIT - Modify a server configuration.
- DELETE - Remove a server configuration.

[ ]> edit

Enter the name or number of the server configuration you wish to edit.

[ ]> 1

Name: PublicLDAP

Hostname: ldapexample.com Port 389

Authentication Type: anonymous

Base: dc=ldapexample,dc=com

Choose the operation you want to perform:

- SERVER - Change the server for the query.

- LDAPACCEPT - Configure whether a recipient address should be accepted or
bounced/dropped.
```

```
- LDAPROUTING - Configure message routing.
- MASQUERADE - Configure domain masquerading.
- LDAPGROUP - Configure whether a sender or recipient is in a specified group.
- SMTPAUTH - Configure SMTP authentication.

[]> server

Name: PublicLDAP

Hostname: ldapexample.com Port 389

Authentication Type: anonymous

Base: dc=ldapexample,dc=com

Microsoft Exchange 5.5 Compatibility Mode: Disabled

Choose the operation you want to perform:

- NAME - Change the name of this configuration.
- HOSTNAME - Change the hostname used for this query.
- PORT - Configure the port.
- AUTHTYPE - Choose the authentication type.
- BASE - Configure the query base.
- COMPATIBILITY - Set LDAP protocol compatibility options.

[]> compatibility
Would you like to enable Microsoft Exchange 5.5 LDAP compatibility mode? (This is not
recommended for versions of Microsoft Exchange later than 5.5, or other LDAP servers.)

[N]> y

Do you want to configure advanced LDAP compatibility settings? (Typically not required)

[N]>

Name: PublicLDAP

Hostname: ldapexample.com Port 389

Authentication Type: anonymous

Base: dc=ldapexample,dc=com

Microsoft Exchange 5.5 Compatibility Mode: Enabled (attribute "objectClass")

Choose the operation you want to perform:

- NAME - Change the name of this configuration.
- HOSTNAME - Change the hostname used for this query.
- PORT - Configure the port.
```

- AUTHTYPE - Choose the authentication type.
  - BASE - Configure the query base.
  - COMPATIBILITY - Set LDAP protocol compatibility options.
- [ ]>

## Working with LDAP Queries

You create an entry in the LDAP server profile for each type of LDAP query you want to perform. When you create LDAP queries, you must enter the query syntax for your LDAP server. Please note that the queries you construct should be tailored and specific to your particular implementation of LDAP directory services, particularly if you have extended your directory with new object classes and attributes to accommodate the unique needs of your directory.

### Related Topics

- [Types of LDAP Queries, on page 781](#)
- [Base Distinguishing Name \(DN\), on page 782](#)
- [LDAP Query Syntax, on page 782](#)
- [Secure LDAP \(SSL\), on page 783](#)
- [Routing Queries, on page 783](#)
- [Allowing Clients to Bind to the LDAP Server Anonymously , on page 783](#)
- [Testing LDAP Queries, on page 786](#)
- [Troubleshooting Connections to LDAP Servers, on page 787](#)

## Types of LDAP Queries

- **Acceptance queries.** For more information, see [Using Acceptance Queries For Recipient Validation, on page 788](#).
- **Routing queries.** For more information, see [Using Routing Queries to Send Mail to Multiple Target Addresses, on page 789](#).
- **Certificate Authentication queries.** For more information, see [Checking the Validity of a Client Certificate, on page 821](#).
- **Masquerading queries.** For more information, see [Using Masquerading Queries to Rewrite the Envelope Sender, on page 790](#).
- **Group queries.** For more information, see [Using Group LDAP Queries to Determine if a Recipient is a Group Member, on page 792](#).
- **Domain-based queries.** For more information, see [Using Domain-based Queries to Route to a Particular Domain, on page 795](#).
- **Chain queries.** For more information, see [Using Chain Queries to Perform a Series of LDAP Queries, on page 797](#).

You can also configure queries for the following purposes:

- **Directory harvest prevention.** For more information, see [Understanding LDAP Queries, on page 772](#).
- **SMTP authentication.** For more information, see [Configuring AsyncOS for SMTP Authentication, on page 800](#).

- **External authentication.** For more information, see [Configuring External LDAP Authentication for Users](#), on page 808.
- **Spam quarantine end-user authentication query.** For more information, see [Authenticating End-Users of the Spam Quarantine](#), on page 811.
- **Spam quarantine alias consolidation query.** For more information, see [Spam Quarantine Alias Consolidation Queries](#), on page 812.

The search queries you specify are available to all listeners you configure on the system.

## Base Distinguishing Name (DN)

The root level of the directory is called the base. The name of the base is the DN (distinguishing name). The base DN format for Active Directory (and the standard as per RFC 2247) has the DNS domain translated into domain components (dc=). For example, example.com's base DN would be: dc=example, dc=com. Note that each portion of the DNS name is represented in order. This may or may not reflect the LDAP settings for your configuration.

If your directory contains multiple domains you may find it inconvenient to enter a single BASE for your queries. In this case, when configuring the LDAP server settings, set the base to NONE. This will, however, make your searches inefficient.

## LDAP Query Syntax

Spaces are allowed in LDAP paths, and they do not need to be quoted. The CN and DC syntax is not case-sensitive.

Cn=First Last,oU=user,dc=domain,DC=COM

The variable names you enter for queries are *case-sensitive* and must match your LDAP implementation in order to work correctly. For example, entering **mailLocalAddress** at a prompt performs a different query than entering **maillocaladdress**.

### Related Topics

- [Tokens:](#), on page 782

## Tokens:

You can use the following tokens in your LDAP queries:

- {a} username@domainname
- {d} domainname
- {dn} distinguished name
- {g} groupname
- {u} username
- {f} MAIL FROM: address



---

**Note** The {f} token is valid in acceptance queries only.

---

For example, you might use the following query to accept mail for an Active Directory LDAP server:

```
((mail={a})(proxyAddresses=smtp:{a}))
```



**Note** Cisco Systems strongly recommends using the Test feature of the LDAP page (or the `test` subcommand of the `ldapconfig` command) to test all queries you construct and ensure that expected results are returned *before* you enable LDAP functionality on a listener. See [Testing LDAP Queries, on page 786](#) for more information.

## Secure LDAP (SSL)

You can use instruct AsyncOS to use SSL when communicating with the LDAP server. If you configure your LDAP server profile to use SSL:

- AsyncOS will use the LDAPS certificate configured via `certconfig` in the CLI (see [Creating a Self-Signed Certificate, on page 674](#)).

You may have to configure your LDAP server to support using the LDAPS certificate.

- If an LDAPS certificate has not been configured, AsyncOS will use the demo certificate.

## Routing Queries

There is no recursion limit for LDAP routing queries; the routing is completely data driven. However, AsyncOS does check for circular reference data to prevent the routing from looping infinitely.

## Allowing Clients to Bind to the LDAP Server Anonymously

You may need to configure your LDAP directory server to allow for anonymous queries. (That is, clients can bind to the server anonymously and perform queries.) For specific instructions on configuring Active Directory to allow anonymous queries, see the “Microsoft Knowledge Base Article - 320528” at the following URL:

<http://support.microsoft.com/default.aspx?scid=kb%3Ben-us%3B320528>

Alternately, you can configure one “user” dedicated solely for the purposes of authenticating and performing queries instead of opening up your LDAP directory server for anonymous queries from any client.

A summary of the steps is included here, specifically:

- How to set up Microsoft Exchange 2000 server to allow “anonymous” authentication.
- How to set up Microsoft Exchange 2000 server to allow “anonymous bind.”
- How to set up AsyncOS to retrieve LDAP data from a Microsoft Exchange 2000 server using both “anonymous bind” and “anonymous” authentication.

Specific permissions must be made to a Microsoft Exchange 2000 server in order to allow “anonymous” or “anonymous bind” authentication for the purpose of querying user email addresses. This can be very useful when an LDAP query is used to determine the validity of an income email message to the SMTP gateway.

### Related Topics

- [Anonymous Authentication Setup, on page 784](#)

- [Anonymous Bind Setup for Active Directory, on page 785](#)
- [Notes for Active Directory Implementations, on page 786](#)

## Anonymous Authentication Setup

The following setup instructions allow you to make specific data available to unauthenticated queries of Active Directory and Exchange 2000 servers in the Microsoft Windows Active Directory. If you wish to allow “anonymous bind” to the Active Directory, see [Anonymous Bind Setup for Active Directory, on page 785](#).

### Procedure

**Step 1** Determine required Active Directory permissions.

Using the ADSI Edit snap-in or the LDP utility, you must modify the permissions to the attributes of the following Active Directory objects:

- The root of the domain naming context for the domain against which you want to make queries.
- All OU and CN objects that contain users against which you wish to query email information.

The following table shows the required permissions to be applied to all of the needed containers.

| User Object | Permissions                 | Inheritance                 | Permission Type |
|-------------|-----------------------------|-----------------------------|-----------------|
| Everyone    | List Contents               | Container Objects           | Object          |
| Everyone    | List Contents               | Organizational Unit Objects | Object          |
| Everyone    | Read Public Information     | User Objects                | Property        |
| Everyone    | Read Phone and Mail Options | User Objects                | Property        |

**Step 2** Set Active Directory Permissions

- Open ADSIEdit from the Windows 2000 Support Tools.
- Locate the **Domain Naming Context** folder. This folder has the LDAP path of your domain.
- Right click the **Domain Naming Context** folder, and then click **Properties**.
- Click **Security**.
- Click **Advanced**.
- Click **Add**.
- Click the **User Object** Everyone, and then click **OK**.
- Click the **Permission Type** tab.
- Click **Inheritance** from the **Apply onto** box.
- Click to select the Allow check box for the **Permission** permission.

**Step 3** Configure the Cisco Messaging Gateway

Use `ldapconfig` on the Command Line Interface (CLI) to create an LDAP server entry with the following information.

- Hostname of an Active Directory or Exchange server
- Port 3268
- Base DN matching the root naming context of the domain



- Authentication type Anonymous

## Anonymous Bind Setup for Active Directory

The following setup instructions allow you to make specific data available to anonymous bind queries of Active Directory and Exchange 2000 servers in the Microsoft Windows Active Directory. Anonymous bind of an Active Directory server will send the username anonymous with a blank passphrase.



**Note** If a passphrase is sent to an Active Directory server while attempting anonymous bind, authentication may fail.

### Procedure

**Step 1** Determine required Active Directory permissions.

Using the ADSI Edit snap-in or the LDP utility, you must modify the permissions to the attributes of the following Active Directory objects.

- The root of the domain naming context for the domain against which you want to make queries.
- All OU and CN objects that contain users against which you wish to query email information.

The following table shows the required permissions to be applied to all of the needed containers.

| User Object     | Permissions                 | Inheritance                 | Permission Type |
|-----------------|-----------------------------|-----------------------------|-----------------|
| ANONYMOUS LOGON | List Contents               | Container Objects           | Object          |
| ANONYMOUS LOGON | List Contents               | Organizational Unit Objects | Object          |
| ANONYMOUS LOGON | Read Public Information     | User Objects                | Property        |
| ANONYMOUS LOGON | Read Phone and Mail Options | User Objects                | Property        |

**Step 2** Set Active Directory Permissions

- Open ADSIEdit from the Windows 2000 Support Tools.
- Locate the **Domain Naming Context** folder. This folder has the LDAP path of your domain.
- Right click the **Domain Naming Context** folder, and then click **Properties**.
- Click **Security**.
- Click **Advanced**.
- Click **Add**.
- Click the **User Object** ANONYMOUS LOGON, and then click **OK**.
- Click the **Permission Type** tab.
- Click **Inheritance** from the **Apply** onto box.
- Click to select the **Allow** check box for the **Permission** permission.

**Step 3** Configure the Cisco Messaging Gateway

Use the **System Administration > LDAP** page (or `ldapconfig` in the CLI) to create an LDAP server entry with the following information.

- Hostname of an Active Directory or Exchange server
- Port 3268
- Base DN matching the root naming context of the domain
- Authentication type passphrase based using `cn=anonymous` as the user with a blank passphrase

## Notes for Active Directory Implementations

- Active Directory servers accept LDAP connections on ports 3268 and 389. The default port for accessing the global catalog is port 3268.
- Active Directory servers accept LDAPS connections on ports 636 and 3269. Microsoft supports LDAPS on Windows Server 2003 and higher.
- The email gateway should connect to a domain controller that is also a global catalog so that you can perform queries to different bases using the same server.
- Within Active Directory, you may need to grant read permissions to the group “Everyone” to directory objects to yield successful queries. This includes the root of the domain naming context.
- Generally, the value of the mail attribute entry in many Active Directory implementations has a matching value “ProxyAddresses” attribute entry.
- Microsoft Exchange environments that are aware of each other within the infrastructure can usually route mail between each other without involving a route back to the originating MTA.

## Testing LDAP Queries

Use the Test Query button on the Add/Edit LDAP Server Profile page (or the `test` sub command in the CLI) of each query type to test the query to the LDAP server you configured. In addition to displaying the result, AsyncOS also displays the details on each stage of the query connection test. You can test each of the query types.

The `ldaptest` command is available as a batch command, for example:

```
ldaptest LDAP.ldapaccept foo@ironport.com
```

If you entered multiple hosts in the Host Name field of the LDAP server attributes, the email gateway tests the query on each LDAP server.

**Table 67: Testing LDAP Queries**

| Query type   | If a recipient matches (PASS)...                                   | If a recipient does not match (FAIL)...  |
|--|--|--|
| Recipient Acceptance<br>(Accept, <code>ldapaccept</code> ) | Accept the message.  | Invalid Recipient: Conversation or delayed bounce or drop the message per listener settings. DHAP: Drop. |
| Routing<br>(Routing, <code>ldaprouting</code> )            | Route based on the query settings.                                 | Continue processing the message.   |
| Masquerade (Masquerade,<br><code>masquerade</code> )       | Alter the headers with the variable mappings defined by the query. | Continue processing the message.   |

| Query type   | If a recipient matches (PASS)...  | If a recipient does not match (FAIL)...   |
|--|---|---|
| Group Membership (Group, <code>ldapgroup</code> )                | Return “true” for message filter rules.   | Return “false” for message filter rules.  |
| SMTP Auth (SMTP Authentication, <code>smtpauth</code> )          | A passphrase is returned from the LDAP server and is used for authentication; SMTP Authentication occurs. | No passphrase match can occur; SMTP Authentication attempts fail.                                       |
| External Authentication ( <code>externalauth</code> )            | Individually returns a “match positive” for the bind, the user record, and the user’s group membership.   | Individually returns a “match negative” for the bind, the user record, and the user’s group membership. |
| Spam Quarantine End-User Authentication ( <code>isqauth</code> ) | Returns a “match positive” for the end-user account.  | No passphrase match can occur; End-User Authentication attempts fail.                                   |
| Spam Quarantine Alias Consolidation ( <code>isqalias</code> )    | Returns the email address that the consolidated spam notifications will be sent to.                       | No consolidation of spam notifications can occur.   |



**Note** The variable names you enter for queries are *case-sensitive* and must match your LDAP implementation in order to work correctly. For example, entering `mailLocalAddress` at a prompt performs a different query than entering `maillocaladdress`. Cisco Systems strongly recommends using the test subcommand of the `ldapconfig` command to test all queries you construct and ensure the proper results are returned.

## Troubleshooting Connections to LDAP Servers

If the LDAP server is unreachable by the email gateway, one of the following errors will be shown:

- Error: LDAP authentication failed: <LDAP Error "invalidCredentials" [0x31]>
- Error: Server unreachable: unable to connect
- Error: Server unreachable: DNS lookup failure

Note that a server may be unreachable because the wrong port was entered in the server configuration, or the port is not opened in the firewall. LDAP servers typically communicate over port 3268 or 389. Active Directory uses port 3268 to access the global catalog used in multi-server environments (See the “Firewall Information” appendix for more information.) In AsyncOS 4.0, the ability to communicate to the LDAP server via SSL (usually over port 636) was added. For more information, see [Secure LDAP \(SSL\), on page 783](#).

A server may also be unreachable because the hostname you entered cannot be resolved.

You can use the Test Server(s) on the Add/Edit LDAP Server Profile page (or the `test` subcommand of the `ldapconfig` command in the CLI) to test the connection to the LDAP server. For more information, see [Testing LDAP Servers, on page 776](#).

If the LDAP server is unreachable:

- If LDAP Accept or Masquerading or Routing is enabled on the work queue, mail will remain within the work queue.

- If LDAP Accept is not enabled but other queries (group policy checks, etc.) are used in filters, the filters evaluate to false.

## Using Acceptance Queries For Recipient Validation

You can use your existing LDAP infrastructure to define how the recipient email address of incoming messages (on an public listener) should be handled. Changes to user data in your directories are updated the next time the email gateway queries the directory server. You can specify the size of the caches and the amount of time the email gateway stores the data it retrieves.



**Note** You may wish to bypass LDAP acceptance queries for special recipients (such as administrator@example.com ). You can configure this setting from the Recipient Access Table (RAT). For information about configuring this setting, see the “Configuring the Gateway to Receive Email” chapter.

### Related Topics

- [Sample Acceptance Queries, on page 788](#)
- [Configuring Acceptance Queries for Lotus Notes, on page 789](#)

## Sample Acceptance Queries

The following table shows sample acceptance queries.

**Table 68: Example LDAP Query Strings for Common LDAP Implementations: Acceptance**

| Query for:  | Recipient validation   |
|---|--|
| <b>OpenLDAP</b>   | (mailLocalAddress={a})<br>(mail={a})<br>(mailAlternateAddress={a})   |
| <b>Microsoft Active Directory Address Book<br/>Microsoft Exchange</b> | ( (mail={a})(proxyAddresses=smtp:{a}))   |
| <b>SunONE Directory Server</b>  | (mail={a})<br>(mailAlternateAddress={a})<br>(mailEquivalentAddress={a})<br>(mailForwardingAddress={a})<br>(mailRoutingAddress={a}) |
| <b>Lotus Notes/Lotus Domino</b>                                       | ( (  (mail={a})(uid={u})(cn={u}))<br>( (ShortName={u})(InternetAddress={a})(FullName={u}))   |

You can also validate on the username (Left Hand Side). This is useful if your directory does not contain all the domains you accept mail for. Set the Accept query to `(uid={u})`.

## Configuring Acceptance Queries for Lotus Notes

Note that there is a potential complication with LDAPACCEPT and Lotus Notes. If Notes LDAP contains a person with attributes like these:

```
mail=juser@example.com
```

```
cn=Joe User
```

```
uid=juser
```

```
cn=123456
```

```
location=New Jersey
```

Lotus accepts email for this person for various different forms of email addresses, other than what is specified, such as “`Joe_User@example.com`” — which do not exist in the LDAP directory. So AsyncOS may not be able to find all of the valid user email addresses for that user.

One possible solution is to try to publish the other forms of addresses. Please contact your Lotus Notes administrator for more details.

## Using Routing Queries to Send Mail to Multiple Target Addresses

AsyncOS supports alias expansion (LDAP routing with multiple target addresses). AsyncOS replaces the original email message with a new, separate message for each alias target (for example, `recipient@yoursite.com` might be replaced with new separate messages to `newrecipient1@hotmail.com` and `recipient2@internal.yourcompany.com`, etc.). Routing queries are sometimes known as aliasing queries on other mail processing systems.

### Related Topics

- [Sample Routing Queries, on page 789](#)

## Sample Routing Queries

*Table 69: Example LDAP Query Strings for Common LDAP Implementations: Routing*

| Query for: | Route to another mailhost           |
|------------|-------------------------------------|
| OpenLDAP   | <code>(mailLocalAddress={a})</code> |

| Query for:  | Route to another mailhost   |
|---|---|
| Microsoft Active Directory Address Book<br>Microsoft Exchange | May not be applicable   |
| SunONE Directory Server                                       | <pre>(mail={a}) (mailForwardingAddress={a}) (mailEquivalentAddress={a}) (mailRoutingAddress={a}) (otherMailbox={a}) (rfc822Mailbox={a})</pre> |

a. Active Directory implementations can have multiple entries for the `proxyAddresses` attribute, but because AD formats this attribute value as `smtp:user@domain.com`, that data cannot be used for LDAP routing/alias expansion. Each target address must be in a separate `attribute:value` pair. Microsoft Exchange environments that are aware of each other within the infrastructure can usually route mail between each other without involving a route back to the originating MTA.

#### Related Topics

- [Routing: MAILHOST and MAILROUTINGADDRESS, on page 790](#)

## Routing: MAILHOST and MAILROUTINGADDRESS

For Routing queries, the value of MAILHOST cannot be an IP address; it must be a resolvable hostname. This usually requires the use of an Internal DNSconfig.

MAILHOST is optional for the routing query. MAILROUTINGADDRESS is mandatory if MAILHOST is not set.

## Using Masquerading Queries to Rewrite the Envelope Sender

Masquerading is a feature that rewrites the Envelope Sender (also known as the sender, or MAIL FROM) and the To:, From:, and/or CC: headers on email based on queries you construct. A typical example implementation of this feature is “Virtual Domains,” which allows you to host multiple domains from a single site. Another typical implementation is “hiding” your network infrastructure by “stripping” the subdomains from strings in email headers.

#### Related Topics

- [Sample Masquerading Queries , on page 791](#)
- [Masquerading “Friendly Names”, on page 791](#)

## Sample Masquerading Queries

Table 70: Example LDAP Query Strings for Common LDAP Implementation: Masquerading

| Query for:                              | Masquerade   |
|---|--|
| OpenLDAP                                | (mailRoutingAddress={a})   |
| Microsoft Active Directory Address Book | (proxyaddresses=smtp:{a})  |
| SunONE Directory Server                 | (mail={a})<br>(mailAlternateAddress={a})<br>(mailEquivalentAddress={a})<br>(mailForwardingAddress={a})<br>(mailRoutingAddress={a}) |

## Masquerading “Friendly Names”

In some user environments, an LDAP directory server schema may store a “friendly name” in addition to a mail routing address or a local mail address. AsyncOS allows you to masquerade Envelope Senders (for outgoing mail) and message headers (for incoming mail, such as To:, Reply To:, From: or CC:) with this “friendly address” — even if the friendly address contains special characters that are not normally permitted in a valid email address (for example, quotation marks, spaces, and commas).

When using masquerading of headers via an LDAP query, you now have the option to configure whether to replace the entire friendly email string with the results from the LDAP server. Note that even with this behavior enabled, only the user@domain portion will be used for the Envelope Sender (the friendly name is illegal).

As with the normal LDAP masquerading, if empty results (zero length or entire white space) are returned from the LDAP query, no masquerading occurs.

To enable this feature, answer “y” to the following question when configuring an LDAP-based masquerading query for a listener (LDAP page or `ldapconfig` command):

```
Do you want the results of the returned attribute to replace the entire
friendly portion of the original recipient? [N]
```

For example, consider the following example LDAP entry:

| Attribute           | Value   |
|---------------------|---|
| mailRoutingAddress  | admin\@example.com  |
| mailLocalAddress    | joe.smith\@example.com                                    |
| mailFriendlyAddress | “Administrator for example.com,” <joe.smith\@example.com> |

If this feature is enabled, an LDAP query of (mailRoutingAddress={a}) and a masquerading attribute of (mailLocalAddress) would result in the following substitutions:

| Original Address (From, To, CC, Reply-to) | Masqueraded Headers   | Masqueraded Envelope Sender           |
|---|---|---------------------------------------|
| admin@example.com                         | From: "Administrator for example.com,"<br><joe.smith@example.com> | MAIL FROM:<br><joe.smith@example.com> |

## Using Group LDAP Queries to Determine if a Recipient is a Group Member

You can define a query to your LDAP servers to determine if a recipient is a member of a group as defined by your LDAP directory.

### Procedure

- 
- Step 1** Create a message filter that uses a rcpt-to-group or mail-from-group rule to act upon the message.
- Step 2** Then, use the **System Administration > LDAP** page (or the `ldapconfig` command) to define the LDAP server for the email gateway to bind to and configure a query for a group membership.
- Step 3** Use the **Network > Listeners** page (or the `listenerconfig -> edit -> ldapgroup` subcommand) to enable the group query for the listener.
- 

### What to do next

#### Related Topics

- [Sample Group Queries](#) , on page 792
- [Configuring a Group Query](#), on page 793

## Sample Group Queries

*Table 71: Example LDAP Query Strings for Common LDAP Implementation: Group*

| Query for:                 | Group   |
|----------------------------|---|
| OpenLDAP                   | OpenLDAP does not support the memberOf attribute by default. Your LDAP Administrator may add this attribute or a similar attribute to the schema. |
| Microsoft Active Directory | <code>(&amp;(memberOf={g})(proxyAddresses=smtp:{a}))</code>   |
| SunONE Directory Server    | <code>(&amp;(memberOf={g})(mailLocalAddress={a}))</code>  |



For example, suppose that your LDAP directory classifies members of the “Marketing” group as `ou=Marketing`. You can use this classification to treat messages sent to or from members of this group in a special way. Step 1 creates a message filter to act upon the message, and Steps 2 and 3 enable the LDAP lookup mechanism.

## Configuring a Group Query

In the following example, mail from members of the Marketing group (as defined by the LDAP group “Marketing”) will be delivered to the alternate delivery host `marketingfolks.example.com`.

### Procedure

#### Step 1

First, a message filter is created to act upon messages that match positively for group membership. In this example, a filter is created that uses the `mail-from-group` rule. All messages whose Envelope Sender is found to be in the LDAP group “marketing-group1” will be delivered with an alternate delivery host (the filters `alt-mailhost` action).

The group membership field variable (`groupName`) will be defined in step 2. The group attribute “groupName” is defined with the value `marketing-group1`.

```
mail3.example.com> filters
```

```
Choose the operation you want to perform:
```

- NEW - Create a new filter.
- IMPORT - Import a filter script from a file.

```
[ ]> new
```

```
Enter filter script. Enter '.' on its own line to end.
```

```
MarketingGroupfilter:
```

```
if (mail-from-group == "marketing-group1") {
alt-mailhost ('marketingfolks.example.com');}
.
```

```
1 filters added.
```

```
Choose the operation you want to perform:
```

- NEW - Create a new filter.
- DELETE - Remove a filter.
- IMPORT - Import a filter script from a file.
- EXPORT - Export filters to a file
- MOVE - Move a filter to a different position.
- SET - Set a filter attribute.
- LIST - List the filters.

## Example: Using a Group Query to Skip Spam and Virus Checking

- DETAIL - Get detailed information on the filters.
- LOGCONFIG - Configure log subscriptions used by filters.
- ROLLOVERNOW - Roll over a filter log file.

[ ]>

For more information on the `mail-from-group` and `rcpt-to-group` message filter rules, see [Message Filter Rules, on page 128](#).

**Step 2** Next, the Add LDAP Server Profile page is used to define an LDAP server for the email gateway to bind to, and an initial query for a group membership is configured.

**Step 3** Next, the public listener “InboundMail” is updated to use LDAP queries for group routing. The Edit Listener page is used to enable the LDAP query specified above.

As a result of this query, messages accepted by the listener trigger a query to the LDAP server to determine group membership. The `PublicLDAP2.group` query was defined previously via the **System Administration > LDAP** page.

**Figure 63: Specifying a Group Query on a Listener**

**Edit Listener**

| Listener Settings   |  |
|---|--|
| Name:   | IncomingMail   |
| Type of Listener:   | Public   |
| Interface:  | Data 1 TCP Port: 25  |
| Bounce Profile:   | Default  |
| Disclaimer Above:   | None<br><small>Disclaimer text will be applied above the message body.</small> |
| Disclaimer Below:   | None<br><small>Disclaimer text will be applied below the message body.</small> |
| SMTP Authentication Profile:  | None   |
| Certificate:  | test   |
| ▶ SMTP Address Parsing Options: Optional settings for controlling parsing in SMTP "MAIL FROM" and "RCPT TO" |  |
| ▶ Advanced: Optional settings for customizing the behavior of the Listener                                  |  |
| ▾ LDAP Queries:   |  |
| ▶ Accept  |  |
| ▶ Routing   |  |
| ▶ Masquerade  |  |
| ▾ Group   |  |
| Group Query: PublicLDAP2.group  |  |
| SMTP Call-Ahead Profile:  | SMTP_Call_Ahead  |

**Step 4** Submit and commit your changes.

## Example: Using a Group Query to Skip Spam and Virus Checking

Because message filters occurs early in the pipeline, you can use a group query to skip virus and spam checking for specified groups. For example, you want your IT group to receive all messages and to skip spam and virus checking. In your LDAP record, you create a group entry that uses the DN as the group name. The group name consists of the following DN entry:

```
cn=IT, ou=groups, o=sample.com
```

You create an LDAP server profile with the following group query:

```
(&(memberOf={g})(proxyAddresses=smtp:{a}))
```

You then enable this query on a listener so that when a message is received by the listener, the group query is triggered.

To skip virus and spam filtering for members of the IT group, you create the following message filter to check incoming messages against LDAP groups.

```
[ ]> - NEW - Create a new filter.

- IMPORT - Import a filter script from a file.

[ ]> new

Enter filter script. Enter '.' on its own line to end.

IT_Group_Filter:

if (rcpt-to-group == "cn=IT, ou=groups, o=sample.com"){

skip-spamcheck();

skip-viruscheck();

deliver();

}

.

1 filters added.
```



---

**Note** The rcpt-to-group in this message filter reflects the DN entered as the group name: cn=IT, ou=groups, o=sample.com. Verify that you use the correct group name in the message filter to ensure that your filter matches the name in your LDAP directory.

---

Messages accepted by the listener trigger a query to the LDAP server to determine group membership. If the message recipient is a member of the IT group, the message filter skips both virus and spam checking and delivers the message to the recipient. To enable the filter to check the results of the LDAP query, you must create the LDAP query on the LDAP server and enable the LDAP query on a listener.

## Using Domain-based Queries to Route to a Particular Domain

Domain-based queries are LDAP queries grouped by type, associated with a domain, and assigned to a particular listener. You might want to use domain-based queries if you have different LDAP servers associated with different domains but you want to run queries for all your LDAP servers on the same listener. For example, the company “MyCompany” purchases company “HisCompany” and company “HerCompany” MyCompany maintains its domain, MyCompany.example.com as well as domains for HisCompany.example.com and HerCompany.example.com, and it maintains a different LDAP server for employees associated with each domain. To accept mail for all three of these domains, MyCompany creates domain-based queries. This allows MyCompany.example.com to accept emails for Mycompany.example.com, HisCompany.example.com, and HerCompany.example.com on the same listener.

### Procedure

---

- Step 1** Create a server profile for each of the domains you want to use in the domain-based queries. For each of the server profiles, configure the queries you want to use for a domain-based query (acceptance, routing, etc.). For more information, see [Creating LDAP Server Profiles to Store Information About the LDAP Server, on page 774](#).
- Step 2** Create the domain-based query. When you create the domain-based query, you select queries from each server profile, and enable the email gateway to determine which query to run based on the domain in the Envelope To field. For more information about creating the query, see [Creating a Domain-Based Query, on page 796](#).
- Step 3** Enable the domain-based query on the public or private listener. For more information about configuring listeners, see the “Configuring the Gateway to Receive Mail” chapter.

**Note** You can also enable domain-based queries for LDAP end-user access or spam notifications for the Spam Quarantine. For more information, see the Spam Quarantine chapter.

---

### What to do next

#### Related Topics

- [Creating a Domain-Based Query, on page 796](#)

## Creating a Domain-Based Query

You create a domain-based query from the System Administration > LDAP > LDAP Server Profiles page.

### Procedure

---

- Step 1** From the LDAP Server Profiles page, click **Advanced**.
- Step 2** Click **Add Domain Assignments**.
- Step 3** Enter a name for the domain-based query.
- Step 4** Select the query type.
- Note** When you create domain-based queries, you cannot select different types of queries. Once you select a query type, the email gateway populates the query field with queries of that type from the available server profiles.
- Step 5** In the Domain Assignments field, enter a domain.
- Step 6** Select a query to associate with the domain.
- Step 7** Continue to add rows until you have added all the domains to your query.
- Step 8** You can enter a default query to run if all other queries fail. If you do not want to enter a default query, select **None**.
- Step 9** Test the query by clicking the Test Query button and entering a user login and passphrase or an email address to test in the Test Parameters fields. The results appear in the Connection Status field.
- Step 10** Optionally, if you use the {f} token in an acceptance query, you can add an envelope sender address to the test query.

**Note** Once you create the domain-based query, you need to associate it with a public or private listener.

**Step 11** Submit and commit your changes.

---

## Using Chain Queries to Perform a Series of LDAP Queries

A chain query is a series of LDAP queries that the email gateway attempts to run in succession. The email gateway attempts to run each query in the “chain” until the LDAP server returns a positive response (or the final query in the “chain” returns a negative response or fails). For chained routing queries, the email gateway re-runs the same configured chain query in sequence for each rewritten email address. Chain queries can be useful if entries in your LDAP directory use different attributes to store similar (or the same) values. For example, you might have used the attributes maillocaladdress and mail to store user email addresses. To ensure that your queries run against both these attributes, you can use chain queries.

### Procedure

---

- Step 1** Create server profiles for each of the queries you want to use in the chain queries. For each of the server profiles, configure the queries you want to use for a chain query. For more information, see [Creating LDAP Server Profiles to Store Information About the LDAP Server, on page 774](#).
- Step 2** Create the chain query. For more information, see [Creating a Chain Query, on page 797](#).
- Step 3** Enable the chain query on the public or private listener. For more information about configuring listeners, see the “Configuring the Gateway to Receive Mail” chapter.

**Note** You can also enable domain-based queries for LDAP end-user access or spam notifications for the Spam Quarantine. For more information, see the Spam Quarantine chapter.

---

### What to do next

#### Related Topics

- [Creating a Chain Query, on page 797](#)

## Creating a Chain Query

You create a chain query from the System Administration > LDAP > LDAP Server Profiles page.

### Procedure

---

- Step 1** From the LDAP Server Profiles page, click **Advanced**.
- Step 2** Click **Add Chain Query**.
- Step 3** Add a name for the chain query.
- Step 4** Select the query type.

When you create chain queries, you cannot select different types of queries. Once you select a query type, the email gateway populates the query field with queries of that type from available server profiles.

**Step 5** Select a query to add to the chain query.

The email gateway runs the queries in the order you configure them. Therefore, if you add multiple queries to the chain query, you might want to order the queries so that more specific queries are followed by more general queries.

**Step 6** Test the query by clicking the Test Query button and entering a user login and passphrase or an email address to test in the Test Parameters fields. The results appear in the Connection Status field.

**Step 7** Optionally, if you use the {f} token in an acceptance query, you can add an envelope sender address to the test query.

**Note** Once you create the chain query, you need to associate it with a public or private listener.

**Step 8** Submit and commit your changes.

## Using LDAP For Directory Harvest Attack Prevention

Directory Harvest Attacks occur when a malicious sender attempts to send messages to recipients with common names, and the email gateway responds by verifying that a recipient has a valid mailbox at that location. When performed on a large scale, malicious senders can determine who to send mail to by “harvesting” these valid addresses for spamming.

The email gateway can detect and prevent Directory Harvest Attack (DHA) when using LDAP acceptance validation queries. You can configure LDAP acceptance to prevent directory harvest attacks within the SMTP conversation or within the work queue.

### Related Topics

- [Directory Harvest Attack Prevention within the SMTP Conversation, on page 798](#)
- [Directory Harvest Attack Prevention within the Work Queue, on page 799](#)

## Directory Harvest Attack Prevention within the SMTP Conversation

You can prevent DHAs by entering only domains in the Recipient Access Table (RAT), and performing the LDAP acceptance validation in the SMTP conversation.

To drop messages during the SMTP conversation, configure an LDAP server profile for LDAP acceptance. Then, configure the listener to perform an LDAP accept query during the SMTP conversation.

**Figure 64: Configuring the Acceptance Query in the SMTP Conversation**

The screenshot shows the configuration interface for LDAP Queries. The 'LDAP Queries' section is expanded to show the 'SMTP Conversation' settings. The 'Accept Query' is set to 'redfish.accept'. The 'Work Queue' section is collapsed. The 'SMTP Conversation' section is expanded, showing the 'If the LDAP server is unreachable' options. The 'Return error code' is set to '451' and the 'Text' is 'Temporary recipient validation er'.

Once you configure LDAP acceptance queries for the listener, you must configure DHAP settings in the mail flow policy associated with the listener.

**Figure 65: Configuring the Mail Flow Policy to Drop Connections in the SMTP Conversation**

| Mail Flow Limits                            |  |
|---|--|
| Rate Limiting:                              | Max. Recipients Per Hour: <input checked="" type="radio"/> Unlimited<br><input type="radio"/> <input type="text"/>   |
|   | Max. Recipients Per Hour Code: <input type="text" value="452"/>  |
|   | Max. Recipients Per Hour Text: <input type="text" value="Too many recipients received this hour"/>   |
| Flow Control:                               | Use SenderBase for Flow Control: <input checked="" type="radio"/> On <input type="radio"/> Off   |
|   | Group by Similarity of IP Addresses: <i>This Feature can only be used if Senderbase Flow Control is off.</i><br><input checked="" type="radio"/> Off<br><input type="radio"/> <input type="text"/><br><small>(significant bits 0-32)</small> |
| Directory Harvest Attack Prevention (DHAP): | Max. Invalid Recipients Per Hour: <input type="radio"/> Unlimited<br><input checked="" type="radio"/> <input type="text" value="5"/>   |
|   | Drop Connection if DHAP threshold is Reached within an SMTP Conversation: <input checked="" type="radio"/> On <input type="radio"/> Off  |
|   | Max. Invalid Recipients Per Hour Code: <input type="text" value="550"/>  |
|   | Max. Invalid Recipients Per Hour Text: <input type="text" value="Too many invalid recip"/>   |

In the mail flow policy associated with the listener, configure the following Directory Harvest Attack Prevention settings:

- **Max. Invalid Recipients Per hour.** The maximum number of invalid recipients per hour this listener will receive from a remote host. This threshold represents the total number of RAT rejections combined with the total number of messages to invalid LDAP recipients dropped in the SMTP conversation or bounced in the work queue. For example, you configure the threshold as five, and the counter detects two RAT rejections and three dropped messages to invalid LDAP recipients. At this point, the email gateway determines that the threshold is reached, and the connection is dropped. By default, the maximum number of recipients per hour for a public listener is 25. For a private listener, the maximum number of recipients per hour is unlimited by default. Setting it to “Unlimited” means that DHAP is not enabled for that mail flow policy.
- **Drop Connection if DHAP Threshold is reached within an SMTP conversation.** Configure the email gateway to drop the connection if the Directory Harvest Attack Prevention threshold is reached.
- **Max. Recipients Per Hour Code.** Specify the code to use when dropping connections. The default code is 550.
- **Max. Recipients Per Hour Text.** Specify the text to use for dropped connections. The default text is “Too many invalid recipients.”

If the threshold is reached, the Envelope Sender of the message does not receive a bounce message when a recipient is invalid.

## Directory Harvest Attack Prevention within the Work Queue

You can prevent most DHAs by entering only domains in the Recipient Access Table (RAT), and performing the LDAP acceptance validation within the work queue. This technique prevents the malicious senders from knowing if the recipient is valid during the SMTP conversation. (When acceptance queries are configured, the system accepts the message and performs the LDAP acceptance validation within the work queue.) However, the Envelope Sender of the message will still receive a bounce message if a recipient is not valid.

### Related Topics

- [Configuring Directory Harvest Prevention in the Work Queue, on page 800](#)

## Configuring Directory Harvest Prevention in the Work Queue

To prevent Directory Harvest Attacks, you first configure an LDAP server profile, and enable LDAP Accept. Once you have enabled LDAP acceptance queries, configure the listener to use the accept query, and to bounce mail for non-matching recipients:

Next, configure the Mail Flow Policy to define the number of invalid recipient addresses the system will allow per sending IP address for a specific period of time. When this number is exceeded, the system will identify this condition as a DHA and send an alert message. The alert message will contain the following information:

```
LDAP: Potential Directory Harvest Attack from host=('IP-address', 'domain_name'), dhap_limit=n, sender_group=sender_group,
```

```
listener=listener_name, reverse_dns=(reverse_IP_address, 'domain_name', 1), sender=envelope_sender, rcpt=envelope_recipients
```

The system will bounce the messages up to the threshold you specified in the mail flow policy and then it will silently accept and drop the rest, thereby informing legitimate senders that an address is bad, but preventing malicious senders from determining which receipts are accepted.

This invalid recipients counter functions similarly to the way Rate Limiting is currently available in AsyncOS: you enable the feature and define the limit as part of the mail flow policy in a public listener's HAT (including the default mail flow policy for the HAT).

You can also configure this in the command-line interface using the `listenerconfig` command.

This feature is also displayed when editing any mail flow policy in the GUI, providing that LDAP queries have been configured on the corresponding listener:

Entering a number of invalid recipients per hour enables DHAP for that mail flow policy. By default, 25 invalid recipients per hour are allowed for public listeners. For private listeners, the maximum invalid recipients per hour is unlimited by default. Setting it to “Unlimited” means that DHAP is not enabled for that mail flow policy.

## Configuring AsyncOS for SMTP Authentication

AsyncOS provides support for SMTP authentication. SMTP Auth is a mechanism for authenticating clients connected to an SMTP server.

The practical use of this mechanism is that users at a given organization are able to send mail using that entity's mail servers even if they are connecting remotely (e.g. from home or while traveling). Mail User Agents (MUAs) can issue an authentication request (challenge/response) when attempting to send a piece of mail.

Users can also use SMTP authentication for outgoing mail relays. This allows the email gateway to make a secure connection to a relay server in configurations where the email gateway is not at the edge of the network.

AsyncOS supports two methods to authenticate user credentials:

- You can use an LDAP directory.
- You can use a different SMTP server (SMTP Auth forwarding and SMTP Auth outgoing).



Figure 66: SMTP Auth Support: LDAP Directory Store or SMTP Server

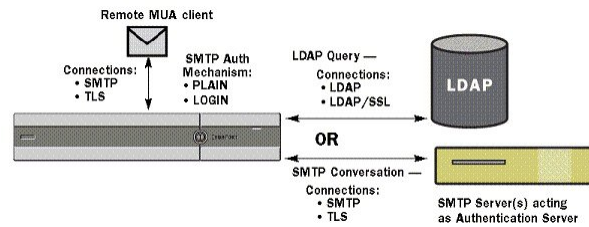

Configured SMTP Authentication methods are then used to create SMTP Auth profiles via the `smtpauthconfig` command for use within HAT mail flow policies (see [Enabling SMTP Authentication on a Listener](#), on page 804).

### Related Topics

- [Configuring SMTP Authentication](#), on page 801
- [Configuring an SMTP Authentication Query](#), on page 802
- [SMTP Authentication via Second SMTP Server \(SMTP Auth with Forwarding\)](#), on page 803
- [SMTP Authentication with LDAP](#), on page 803
- [Authenticating SMTP Sessions Using Client Certificates](#), on page 807
- [Outgoing SMTP Authentication](#), on page 807
- [Logging and SMTP Authentication](#), on page 808

## Configuring SMTP Authentication

If you are going to authenticate with an LDAP server, select the SMTPAUTH query type on the Add or Edit LDAP Server Profile pages (or in the `ldapconfig` command) to create an SMTP Authentication query. For each LDAP server you configure, you can configure a SMTPAUTH query to be used as an SMTP Authentication profile.

There are two kinds of SMTP authentication queries: LDAP bind and passphrase as attribute. When you use passphrase as attribute, the email gateway will fetch the passphrase field in the LDAP directory. The passphrase may be stored in plain text, encrypted, or hashed. When you use LDAP bind, the email gateway attempts to log into the LDAP server using the credentials supplied by the client.

### Related Topics

- [Specifying a Passphrase as Attribute](#), on page 801

## Specifying a Passphrase as Attribute

The convention in OpenLDAP, based on RFC 2307, is that the type of coding is prefixed in curly braces to the encoded passphrase (for example, “{SHA}5en6G6MezRroT3XKqkdPOmY/BfQ=”). In this example, the passphrase portion is a base64 encoding of a plain text passphrase after application of SHA.

The email gateway negotiates the SASL mechanism with the MUA before getting the passphrase, and the email gateway and the MUA decide on what method (LOGIN, PLAIN, MD5, SHA, SSHA, and CRYPT SASL mechanisms are supported). Then, the appliance queries the LDAP database to fetch a passphrase. In LDAP, the passphrase can have a prefix in braces.

- If there is no prefix, the email gateway assumes that the passphrase was stored in LDAP in plaintext.

- If there is a prefix, the appliance will fetch the hashed passphrase, perform the hash on the username and/or passphrase supplied by the MUA, and compare the hashed versions. The email gateway supports SHA1 and MD5 hash types based on the RFC 2307 convention of prepending the hash mechanism type to the hashed passphrase in the passphrase field.
- Some LDAP servers, like the OpenWave LDAP server, do not prefix the encrypted passphrase with the encryption type; instead, they store the encryption type as a separate LDAP attribute. In these cases, you can specify a default SMTP AUTH encryption method the email gateway will assume when comparing the passphrase with the passphrase obtained in the SMTP conversation.

The email gateway takes an arbitrary username from the SMTP Auth exchange and converts that to an LDAP query that fetches the clear or hashed passphrase field. It will then perform any necessary hashing on the passphrase supplied in the SMTP Auth credentials and compare the results with what it has retrieved from LDAP (with the hash type tag, if any, removed). A match means that the SMTP Auth conversation shall proceed. A failure to match will result in an error code.

## Configuring an SMTP Authentication Query

Table 72: SMTP Auth LDAP Query Fields

| Name                           | A name for the query.   |
|--------------------------------|---|
| Query String                   | <p>You can select whether to authenticate via LDAP bind or by fetching the passphrase as an attribute.</p> <p><b>Bind:</b> Attempt to log into the LDAP server using the credentials supplied by the client (this is called an LDAP bind).</p> <p>Specify the maximum number of concurrent connections to be used by the SMTP Auth query. This number should not exceed the number specified in the LDAP server attributes above. Note, to avoid large number of session time-outs for bind authentication, increase the maximum number of concurrent connections here (typically nearly all of the connections can be assigned to SMTP Auth). A new connection is used for each bind authentication. The remainder of the connections are shared by the other LDAP query types.</p> <p><b>Passphrase as Attribute:</b> To authenticate by fetching passphrases, specify the passphrase in the SMTP Auth passphrase attribute field below.</p> <p>Specify the LDAP query to use for either kind of authentication. Active Directory example query:<br/> <code>(&amp;(samaccountname={u})(objectCategory=person)(objectClass=user))</code></p> |
| SMTP Auth Passphrase Attribute | If you have selected “Authenticate by fetching the passphrase as an attribute,” you can specify the passphrase attribute here.  |

In the following example, the System Administration > LDAP page is used to edit the LDAP configuration named “PublicLDAP” to include an SMTPAUTH query. The query string ( uid={u} ) is constructed to match against userPassword attribute.

Figure 67: SMTP Authentication Query

| SMTP Authentication Query |   |
|---------------------------|---|
| Name:                     | PublicLDAP.smtpauth   |
| Query String:             | {uid=(u)}   |
|                           | User Identity for Test Queries: <input type="text"/> <input type="button" value="Test Query"/>                                  |
|                           | Test SMTP Authentication Password: <input type="text"/> ?   |
| Authentication Method:    | <input type="radio"/> Authenticate via LDAP BIND<br><input type="radio"/> Authenticate by fetching the password as an attribute |
|                           | Maximum number of concurrent connections for this query: <input type="text"/>   |
|                           | SMTP Authentication Password Attribute: <input type="text" value="userPassword"/>   |

When an SMTPAUTH profile has been configured, you can specify that the listener uses that query for SMTP authentication.

## SMTP Authentication via Second SMTP Server (SMTP Auth with Forwarding)

You can configure the email gateway to verify the username and passphrase that have been provided to another SMTP authenticated conversation with a different SMTP server.

The authenticating server is not the server that transfers mail; rather, it only responds to SMTP Authentication requests. When authentication has succeeded, the SMTP transfer of mail with the dedicated mail server can proceed. This feature is sometimes referred to as “SMTP Authentication with forwarding” because only the credentials are forwarded (or “proxied”) to another SMTP server for authentication.

### Procedure

- 
- Step 1** Choose **Network > SMTP Authentication**.
  - Step 2** Click **Add Profile...**
  - Step 3** Enter a unique name for the SMTP authentication profile.
  - Step 4** For the **Profile Type**, select **Forward**.
  - Step 5** Click **Next**.
  - Step 6** Enter the hostname/IP address and port of the forwarding server. Select a forwarding interface to use for forwarding authentication requests. Specify the number of maximum simultaneous connections. Then, you can configure whether TLS is required for connections from the email gateway to the forwarding server. You can also select a SASL method to use (PLAIN or LOGIN), if available. This selection is configured for each forwarding server.
  - Step 7** Submit and commit your changes.
  - Step 8** After creating the authentication profile, you can enable the profile on a listener. See [Enabling SMTP Authentication on a Listener, on page 804](#) for more information.
- 

## SMTP Authentication with LDAP

To create an LDAP-based SMTP Authentication profile, you must have previously created an SMTP Authentication query in conjunction with an LDAP server profile using the System Administration > LDAP

page. You can then use this profile to create an SMTP Authentication profile. For more information about creating an LDAP profile, see [Understanding LDAP Queries, on page 772](#).

### Procedure

- 
- Step 1** Choose **Network > SMTP Authentication**.
- Step 2** Click **Add Profile**.
- Step 3** Enter a unique name for the SMTP authentication profile.
- Step 4** For the Profile Type, select **LDAP**.
- Step 5** Click **Next**.
- Step 6** Select the LDAP query you would like to use for this authentication profile.
- Step 7** Select a default encryption method from the drop-down menu. You can select from SHA, Salted SHA, Crypt, Plain, or MD5. If your LDAP servers prefix an encrypted passphrase with the encryption type, leave 'None' selected. If your LDAP server saves the encryption type as a separate entity (OpenWave LDAP servers, for example), then select an encryption method from the menu. The default encryption setting will not be used if the LDAP query is using bind.
- Step 8** Click **Finish**.
- Step 9** Submit and commit your changes.
- Step 10** After creating the authentication profile, you can enable the profile on a listener. See [Enabling SMTP Authentication on a Listener, on page 804](#) for more information.
- 

### What to do next

#### Related Topics

- [Enabling SMTP Authentication on a Listener, on page 804](#)

## Enabling SMTP Authentication on a Listener

After using the **Network > SMTP Authentication** page to create an SMTP authentication “profile” that specifies the type of SMTP authentication you want to perform (LDAP-based or SMTP forwarding-based), you must associate that profile with a listener using the **Network > Listeners** page (or the `listenerconfig` command).



- 
- Note** An authenticated user is granted RELAY connection behavior within their current Mail Flow Policy.
- You may specify more than one forwarding server in a profile. SASL mechanisms CRAM-MD5 and DIGEST-MD5 are not supported between the email gateway and a forwarding server.
- 

In the following example, the listener “InboundMail” is edited to use the SMTPAUTH profile configured via the Edit Listener page:

Figure 68: Selecting an SMTP Authentication Profile via the Edit Listener page

**Edit Listener**

| Listener Settings               |  |
|---------------------------------|--|
| Name:                           | IncomingMail   |
| Type of Listener:               | Public   |
| Interface:                      | Data 1 TCP Port: 25  |
| Bounce Profile:                 | Default  |
| Disclaimer Above:               | None<br><i>Disclaimer text will be applied above the message body.</i>       |
| Disclaimer Below:               | None<br><i>Disclaimer text will be applied below the message body.</i>       |
| SMTP Authentication Profile:    | forwarding_based   |
| Certificate:                    | test   |
| ▶ SMTP Address Parsing Options: | Optional settings for controlling parsing in SMTP "MAIL FROM" and "RCPT TO"  |
| ▶ Advanced:                     | Optional settings for customizing the behavior of the Listener               |
| ▶ LDAP Queries:                 | Optional settings for controlling LDAP queries associated with this Listener |
| SMTP Call-Ahead Profile:        | None   |

Cancel Submit

Once a listener is configured to use the profile, the Host Access Table default settings can be changed so that the listener allows, disallows, or requires SMTP Authentication:

Figure 69: Enabling SMTP Authentication on a Mail Flow Policy

|                                |  |   |
|--------------------------------|--|---|
| Encryption and Authentication: | TLS:   | <input type="radio"/> Use Default (Off) <input checked="" type="radio"/> Off <input type="radio"/> Preferred <input type="radio"/> Required |
|                                | SMTP Authentication:                             | <input checked="" type="radio"/> Use Default (Off) <input type="radio"/> Off <input type="radio"/> Preferred <input type="radio"/> Required |
|                                | If Both TLS and SMTP Authentication are enabled: | <input type="checkbox"/> Require TLS To Offer SMTP Authentication   |

| Number | Description  |
|--------|--|
| 1.     | The SMTP Authentication field provides listener-level control for SMTP authentication. If you select “No,” authentication will not be enabled on the listener, regardless of any other SMTP authentication settings you configure. |
| 2.     | If “Required” is selected in the second prompt (SMTP Authentication:), no AUTH keyword will be issued until TLS is negotiated (after the client issues a second EHLO command).   |

### Related Topics

- [SMTP Authentication and HAT Policy Settings, on page 805](#)
- [HAT Delayed Rejection, on page 806](#)

## SMTP Authentication and HAT Policy Settings

Because senders are grouped into the appropriate sender group before the SMTP Authentication negotiation begins, Host Access Table (HAT) settings, are not affected. When a remote mail host connects, the email gateway first determines which sender group applies and imposes the Mail Policy for that sender group. For example, if a remote MTA “suspicious.com” is in your SUSPECTLIST sender group, the THROTTLE policy will be applied, regardless of the results of “suspicious.com’s” SMTPAUTH negotiation.

However, senders that do authenticate using SMTPAUTH are treated differently than “normal” senders. The connection behavior for successful SMTPAUTH sessions changes to “RELAY,” effectively bypassing the Recipient Access Table (RAT) and LDAPACCEPT. This allows the sender to relay messages through the email gateway. As stated, any Rate Limiting or throttling that applies will remain in effect.

## HAT Delayed Rejection

When HAT Delayed Rejection is configured, connections that would get dropped based on the HAT Sender Group and Mail Flow Policy configuration can still authenticate successfully and get the RELAY mail flow policy granted.

Configure whether to perform HAT rejection at the message recipient level. By default, HAT rejected connections will be closed with a banner message at the start of the SMTP conversation.

When an email is rejected due to HAT “Reject” settings, AsyncOS can perform the rejection at the message recipient level (RCPT TO), rather than at the start of the SMTP conversation. Rejecting messages in this way delays the message rejection and bounces the message, allowing AsyncOS to retain more detailed information about the rejected messages. For example, you can see the mail from address and each recipient address of the message which is blocked. Delaying HAT rejections also makes it less likely that the sending MTA will perform multiple retries.

When you enable HAT delayed rejection, the following behavior occurs:

- The MAIL FROM command is accepted, but no message object is created.
- All RCPT TO commands are rejected with text explaining that access to send e-mail is refused.
- If the sending MTA authenticates with SMTP AUTH, they are granted a RELAY policy and are allowed to deliver mail as normal.

You can configure delayed rejection using the `listenerconfig --> setup` CLI command. This behavior is disabled by default.

The following table shows how to configure delayed rejection for HAT.

```
example.com> listenerconfig
```

```
Currently configured listeners:
```

1. listener1 (on main, 172.22.138.17) QMQP TCP Port 628 Private
2. listener2 (on main, 172.22.138.17) SMTP TCP Port 25 Private

```
Choose the operation you want to perform:
```

- NEW - Create a new listener.
- EDIT - Modify a listener.
- DELETE - Remove a listener.
- SETUP - Change global settings.

```
[ ]> setup
```

```
Enter the global limit for concurrent connections to be allowed across all listeners.
```

```
[300]>
```

```
[...]
```

By default HAT rejected connections will be closed with a banner message at the start of the SMTP conversation. Would you like to do the rejection at the

```
message recipient level instead for more detailed logging of rejected mail?
[N]> y
Do you want to modify the SMTP RCPT TO reject response in this case?
[N]> y
Enter the SMTP code to use in the response. 550 is the standard code.
[550]> 551
Enter your custom SMTP response. Press Enter on a blank line to finish.
Sender rejected due to local mail policy.
Contact your mail admin for assistance.
```

## Authenticating SMTP Sessions Using Client Certificates

The email gateway supports the use of client certificates to authenticate SMTP sessions between the email gateway and users' mail clients.

When creating an SMTP authentication profile, you select the Certificate Authentication LDAP query to use for verifying the certificate. You can also specify whether the email gateway falls back to the SMTP AUTH command to authenticate the user if a client certificate isn't available.

If your organization uses client certificates to authenticate users, you have the option of using the SMTP Authentication query to check whether a user who doesn't have a client certificate can send mail as long as their record specifies that it's allowed.

## Outgoing SMTP Authentication

SMTP Authentication can also be used to provide validation for an outbound mail relay, using a username and passphrase. Create an 'outgoing' SMTP authentication profile and then attach the profile to an SMTP route for the ALL domain. On each mail delivery attempt, the email gateway will log on to the upstream mail relay with the necessary credentials. SMTP authentication supports the following authorization protocols: PLAIN and LOGIN.

### Procedure

---

- Step 1** Create an outgoing SMTP authentication profile.
- Choose **Network > SMTP Authentication**.
  - Click **Add Profile**.
  - Enter a unique name for the SMTP authentication profile.
  - For the Profile Type, select **Outgoing**.
  - Click **Next**.
  - Enter an authentication username and passphrase for the authentication profile.
  - Click **Finish**.
- Step 2** Configure SMTP routes to use the outgoing SMTP authentication profile that you created in Step 1.

- a. Choose **Network > SMTP Routes**.
  - b. Click the **All Other Domains** link in the **Receiving Domain** column of the table.
  - c. Enter the name of the Destination Host for the SMTP route. This is the hostname of your external mail relay used to deliver outgoing mail.
  - d. Select the outgoing SMTP authentication profile from the drop-down menu.
  - e. Submit and commit your changes.
- 

## Logging and SMTP Authentication

The following events will be logged in the mail logs when the SMTP Authentication mechanism (either LDAP-based, SMTP forwarding server based, or SMTP outgoing) is configured on the email gateway:

- [Informational] Successful SMTP Authentication attempts — including the user authenticated and the mechanism used. (No plaintext passphrases will be logged.)
- [Informational] Unsuccessful SMTP Authentication attempts — including the user authenticated and the mechanism used.
- [Warning] Inability to connect to the authentication server — including the server name and the mechanism.
- [Warning] A time-out event when the forwarding server (talking to an upstream, injecting email gateway) times out while waiting for an authentication request.

## Configuring External LDAP Authentication for Users

You can configure the email gateway to use an LDAP directory on your network to authenticate users by allowing them to log in with their LDAP usernames and passphrases. After you configure the authentication queries for the LDAP server, enable the email gateway to use external authentication on the **System Administration > Users** page in the GUI (or use the `userconfig` command in the CLI).

### Procedure

---

- Step 1** **Create a query to find user accounts.** In an LDAP server profile, create a query to search for user accounts in the LDAP directory.
- Step 2** **Create group membership queries.** Create a query to determine if a user is a member of a directory group.
- Step 3** **Set up external authentication to use the LDAP server.** Enable the email gateway to use the LDAP server for user authentication and assign user roles to the groups in the LDAP directory. For more information, see “Adding Users” in the “Distributing Administrative Tasks” chapter.

**Note** Use the Test Query button on the LDAP page (or the `ldaptest` command) to verify that your queries return the expected results. For more information, see [Testing LDAP Queries, on page 786](#).

---

### What to do next

#### Related Topics

- [User Accounts Query, on page 809](#)



- [Group Membership Queries](#), on page 809

## User Accounts Query

To authenticate external users, AsyncOS uses a query to search for the user record in the LDAP directory and the attribute that contains the user's full name. Depending on the server type you select, AsyncOS enters a default query and a default attribute. You can choose to have your email gateway deny users with expired accounts if you have attributes defined in RFC 2307 in your LDAP user records ( `shadowLastChange` , `shadowMax` , and `shadowExpire` ). The base DN is required for the domain level where user records reside.

The following table shows the default query string and full username attribute that AsyncOS uses when it searches for a user account on an Active Directory server.

**Table 73: Default User Account Query String and Attribute: Active Directory**

| Server Type                               | Active Directory   |
|---|--|
| Base DN                                   | [blank] (You need to use a specific base DN to find the user records.) |
| Query String                              | (&(objectClass=user)(sAMAccountName={u}))                              |
| Attribute containing the user's full name | displayName  |

The following table shows the default query string and full username attribute that AsyncOS uses when it searches for a user account on an OpenLDAP server.

**Table 74: Default User Account Query String and Attribute: OpenLDAP**

| Server Type                               | OpenLDAP   |
|---|--|
| Base DN                                   | [blank] (You need to use a specific base DN to find the user records.) |
| Query String                              | (&(objectClass=posixAccount)(uid={u}))                                 |
| Attribute containing the user's full name | gecos  |

## Group Membership Queries

AsyncOS also uses a query to determine if a user is a member of a directory group. Membership in a directory group determines the user's permissions within the system. When you enable external authentication on the System Administration > Users page in the GUI (or `userconfig` in the CLI), you assign user roles to the groups in your LDAP directory. User roles determine the permissions that users have in the system, and for externally authenticated users, the roles are assigned to directory groups instead of individual users. For example, you can assign users in the IT directory group the Administrator role and users in the Support directory group to the Help Desk User role.

If a user belongs to multiple LDAP groups with different user roles, AsyncOS grants the user the permissions for the most restrictive role. For example, if a user belongs to a group with Operator permissions and a group with Help Desk User permissions, AsyncOS grants the user the permissions for the Help Desk User role.

When you configure the LDAP profile to query for group membership, enter the base DN for the directory level where group records can be found, the attribute that holds the group member's username, and the attribute that contains the group name. Based on the server type that you select for your LDAP server profile, AsyncOS enters default values for the username and group name attributes, as well default query strings.



**Note** For Active Directory servers, the default query string to determine if a user is a member of a group is (&(objectClass=group)(member={u})). However, if your LDAP schema uses distinguished names in the “memberof” list instead of usernames, you can use {dn} instead of {u}.

The following table shows the default query strings and attributes that AsyncOS uses when it searches for group membership information on an Active Directory server.

**Table 75: Default Group Membership Query Strings and Attribute: Active Directory**

| Server Type   | Active Directory   |
|---|--|
| Base DN   | [blank] (You need to use a specific base DN to find the group records.)  |
| Query string to determine if a user is a member of a group                  | (&(objectClass=group)(member={u}))<br><b>Note</b> If your LDAP schema uses distinguished names in the memberOf list instead of usernames, you can replace {u} with {dn}. |
| Attribute that holds each member's username (or a DN for the user's record) | member   |
| Attribute that contains the group name                                      | cn   |

The following table shows the default query strings and attributes that AsyncOS uses when it searches for group membership information on an OpenLDAP server.

**Table 76: Default Group Membership Query Strings and Attributes: OpenLDAP**

| Server Type   | OpenLDAP  |
|---|---|
| Base DN   | [blank] (You need to use a specific base DN to find the group records.) |
| Query string to determine if a user is a member of a group                  | (&(objectClass=posixGroup)(memberUid={u}))                              |
| Attribute that holds each member's username (or a DN for the user's record) | memberUid   |
| Attribute that contains the group name                                      | cn  |

# Authenticating End-Users of the Spam Quarantine

Spam quarantine end-user authentication queries validate users when they log in to the Spam Quarantine. The token {u} specifies the user (it represents the user's login name). The token {a} specifies the user's email address. The LDAP query does not strip "SMTP:" from the email address; AsyncOS strips that portion of the address.

If you want the Spam Quarantine to use an LDAP query for end-user access, check the "Designate as the active query" check box. If there is an existing active query, it is disabled. When you open the **System Administration > LDAP** page, an asterisk (\*) is displayed next to the active queries.

Based on the server type, AsyncOS uses one of the following default query strings for the end-user authentication query:

- **Active Directory:** (sAMAccountName={u})
- **OpenLDAP:** (uid={u})
- **Unknown or Other:** [Blank]

By default, the primary email attribute is proxyAddresses for Active Directory servers and mail for OpenLDAP servers. You can enter your own query and email attributes. To create the query from the CLI, use the isqauth subcommand of the ldapconfig command.



**Note** If you want users to log in with their full email address, use (mail=smtp:{a}) for the Query String.

## Related Topics

- [Sample Active Directory End-User Authentication Settings, on page 811](#)
- [Sample OpenLDAP Alias Consolidation Settings, on page 813](#)
- [Configuring End-User Access to the Spam Quarantine , on page 962](#)

## Sample Active Directory End-User Authentication Settings

This section shows sample settings for an Active Directory server and the end-user authentication query. This example uses passphrase authentication for the Active Directory server, the mail and proxyAddresses email attributes, and the default query string for end-user authentication for Active Directory servers.

**Table 77: Example LDAP Server and Spam Quarantine End-User Authentication Settings: Active Directory**

| Authentication Method | Use Passphrase (Need to create a low-privilege user to bind for searching, or configure anonymous searching.) |
|-----------------------|---|
| Server Type           | Active Directory  |
| Port                  | 3268  |
| Base DN               | [Blank]   |
| Connection Protocol   | [Blank]   |
| Query String          | (sAMAccountName={u})  |

| Authentication Method | Use Passphrase (Need to create a low-privilege user to bind for searching, or configure anonymous searching.) |
|-----------------------|---|
| Email Attribute(s)    | mail,proxyAddresses   |

## Sample OpenLDAP End-User Authentication Settings

This section shows sample settings for an OpenLDAP server and the end-user authentication query. This example uses anonymous authentication for the OpenLDAP server, the mail and mailLocalAddress email attributes, and the default query string for end-user authentication for OpenLDAP servers.

*Table 78: Example LDAP Server and Spam Quarantine End-User Authentication Settings: OpenLDAP*

| Authentication Method | Anonymous   |
|-----------------------|---|
| Server Type           | OpenLDAP  |
| Port                  | 389   |
| Base DN               | [Blank] (Some older schemas will want to use a specific Base DN.) |
| Connection Protocol   | [Blank]   |
| Query String          | (uid={u})   |
| Email Attribute(s)    | mail,mailLocalAddress   |

## Spam Quarantine Alias Consolidation Queries

If you use spam notifications, the spam quarantine alias consolidation query consolidates the email aliases so that recipients do not receive quarantine notices for each alias. For example, a recipient might receive mail for the following email addresses: john@example.com, jsmith@example.com, and john.smith@example.com. When you use alias consolidation, the recipient receives a single spam notification at a chosen primary email address for messages sent to all of the user's aliases.

To consolidate messages to a primary email address, create a query to search for a recipient's alternate email aliases, and then enter the attribute for the recipient's primary email address in the Email Attribute field.

If you want the Spam Quarantine to use an LDAP query for spam notifications, check the "Designate as the active query" check box. If there is an existing active query, it is disabled. When you open the System Administration > LDAP page, an asterisk (\*) is displayed next to the active queries.

For Active Directory servers, the default query string is `((proxyAddresses={a})(proxyAddresses=smtp:{a}))` and the default email attribute is `mail`. For OpenLDAP servers, the default query string is `(mail={a})` and the default email attribute is `mail`. You can define your own query and email attributes, including multiple attributes separated by commas. If you enter more than one email attribute, Cisco recommends entering a unique attribute that uses a single value, such as `mail`, as the first email attribute instead of an attribute with multiple values that can change, such as `proxyAddresses`.

To create the query in the CLI, use the `isqalias` subcommand of the `ldapconfig` command.

**Related Topics**

- [Sample Active Directory Alias Consolidation Settings, on page 813](#)
- [Sample OpenLDAP Alias Consolidation Settings, on page 813](#)

## Sample Active Directory Alias Consolidation Settings

This section shows sample settings for an Active Directory server and the alias consolidation query. This example uses anonymous authentication for the Active Directory server, a query string for alias consolidation for Active Directory servers, and the mail email attribute.

**Table 79: Example LDAP Server and Spam Quarantine Alias Consolidation Settings: Active Directory**

| Authentication Method | Anonymous                               |
|-----------------------|---|
| Server Type           | Active Directory                        |
| Port                  | 3268                                    |
| Base DN               | [Blank]                                 |
| Connection Protocol   | Use SSL                                 |
| Query String          | (<br>  (mail={a}) (mail=smtpp:{a})<br>) |
| Email Attribute       | mail                                    |



**Note** This example is for representational purposes only. Queries and OU or tree settings may vary depending on the environment and configuration.

## Sample OpenLDAP Alias Consolidation Settings

This section shows sample settings for an OpenLDAP server and the alias consolidation query. This example uses anonymous authentication for the OpenLDAP server, a query string for alias consolidation for OpenLDAP servers, and the mail email attribute.

**Table 80: Example LDAP Server and Spam Quarantine Alias Consolidation Settings: OpenLDAP**

| Authentication Method | Anonymous   |
|-----------------------|---|
| Server Type           | OpenLDAP  |
| Port                  | 389   |
| Base DN               | [Blank] (Some older schemas will want to use a specific Base DN.) |
| Connection Protocol   | Use SSL   |

| Authentication Method | Anonymous  |
|-----------------------|------------|
| Query String          | (mail={a}) |
| Email Attribute       | mail       |



**Note** This example is for representational purposes only. Queries and OU or tree settings may vary depending on the environment and configuration.

## Sample User Distinguished Name Settings

This section shows sample settings for an Active Directory server and the user distinguished name query. This example uses anonymous authentication for the Active Directory server and a query string for user distinguished name retrieval for Active Directory servers.

*Table 81: Example LDAP Server and Spam Quarantine Alias Consolidation Settings: Active Directory*

| Authentication Method | Anonymous                 |
|-----------------------|---------------------------|
| Server Type           | Active Directory          |
| Port                  | 3268                      |
| Base DN               | [Blank]                   |
| Connection Protocol   | Use SSL                   |
| Query String          | (proxyAddresses=smtp:{a}) |



**Note** This example is for representational purposes only. Queries and OU or tree settings may vary depending on the environment and configuration.

## Configuring AsyncOS To Work With Multiple LDAP Servers

When you configure an LDAP profile, you can configure the email gateway to connect to a list of multiple LDAP servers. To use multiple LDAP servers, you must configure LDAP servers to contain the same information, use the same structure, and use the same authentication information. (third party products exist that can consolidate the records).

When you configure the email gateway to connect to redundant LDAP servers, you can configure the LDAP configuration for failover or load balancing.

You can use multiple LDAP servers to achieve the following results:

- **Failover.** When you configure the LDAP profile for failover, the email gateway fails over to the next LDAP server in the list if it cannot connect to the first LDAP server.

- **Load Balancing.** When you configure the LDAP profile for load balancing, the email gateway distributes connections across the list of LDAP servers when it performs LDAP queries.

You can configure redundant LDAP servers from the System Administration > LDAP page or from the CLI `ldapconfig` command.

## Testing Servers and Queries

Use the **Test Server(s)** button on the Add (or Edit) LDAP Server Profile page (or the `test` subcommand in the CLI) to test the connection to an LDAP server. If you use multiple LDAP servers, AsyncOS tests each server and displays individual results for each server. AsyncOS will also test the query on each LDAP server and display the individual results.

### Related Topics

- [Failover, on page 815](#)
- [Load Balancing, on page 816](#)

## Failover

To ensure that LDAP queries are resolved, you can configure your LDAP profile for failover. If the connection to the LDAP server fails, or the query returns certain error codes (for example, Unavailable or Busy), the email gateway attempts to query the next LDAP server specified in the list.

The email gateway attempts to connect to the first server in the list of LDAP servers for a specified period of time. If the email gateway cannot connect to the first LDAP server in the list, or the query returns certain error codes (for example, Unavailable or Busy), the email gateway attempts to connect to the next LDAP server in the list. By default, the email gateway always attempts to connect to the first server in the list, and it attempts to connect to each subsequent server in the order they are listed. To ensure that the email gateway connects to your primary LDAP server by default, ensure that you enter it as the first server in your list of LDAP servers.

If the email gateway connects to a second or subsequent LDAP server, it remains connected to that server until it reaches a timeout period. After it reaches the timeout, it attempts to reconnect to the first server in the list.



---

**Note** Only attempts to query a specified LDAP server fail over. Attempts to query referral or continuation servers associated with the specified LDAP server do not fail over.

---

### Related Topics

- [Configuring the Email Gateway for LDAP Failover, on page 815](#)

## Configuring the Email Gateway for LDAP Failover

To configure the email gateway for LDAP failover, complete the following steps in the GUI:

## Procedure

---

**Step 1** From System Administration > LDAP, select the LDAP server profile you want to edit.

**Step 2** From the LDAP server profile, configure the following settings:

| Number | Description                    |
|--------|--------------------------------|
| 1      | List LDAP Servers.             |
| 2      | Configure Maximum Connections. |

**Step 3** Configure other LDAP settings and commit the changes.

---

## Load Balancing

To distribute LDAP connections among a group of LDAP servers, you can configure your LDAP profile for load balancing.

When you configure your LDAP profile for load balancing, the email gateway distributes connections among the LDAP servers listed. If a connection fails or times out, the email gateway determines which LDAP servers are available and reconnects to available servers. The email gateway determines the number of simultaneous connections to establish based on the maximum number of connections you configure.

If one of the listed LDAP servers does not respond, the email gateway distributes the connection load among the remaining LDAP servers.

### Reliance Topics

- [Configuring the Email Gateway for Load Balancing, on page 816](#)

## Configuring the Email Gateway for Load Balancing

### Procedure

---

**Step 1** From System Administration > LDAP, select the LDAP server profile you want to edit.

**Step 2** From the LDAP server profile, configure the following settings:



| Server Attributes               |  |
|---------------------------------|--|
| LDAP Server Configuration Name: | <input type="text" value="example.com"/>   |
| Host Name(s):                   | <input type="text" value="ldapsrv1.example.com, ldapsrv2.example.com, ldapsrv3.example.com"/><br><small>Separate multiple entries with commas.</small> |
|                                 | Maximum number of simultaneous connections for all hosts: <input type="text" value="10"/>  |
|                                 | Multiple host options:   |
|                                 | <input checked="" type="radio"/> Load-balance connections among all hosts listed   |
|                                 | <input type="radio"/> Failover connections in the order listed   |

| Number | Description                   |
|--------|-------------------------------|
| 1      | List LDAP Servers             |
| 2      | Configure Maximum Connections |

**Step 3** Configure other LDAP settings and commit the changes.

---





## CHAPTER 33

# Authenticating SMTP Sessions Using Client Certificates

---

This chapter contains the following sections:

- [Overview of Certificates and SMTP Authentication, on page 819](#)
- [Checking the Validity of a Client Certificate, on page 821](#)
- [Authenticating a User Using an LDAP Directory, on page 822](#)
- [Authenticating an SMTP Connection Over TLS Using a Client Certificate, on page 823](#)
- [Establishing a TLS Connection from the Email Gateway, on page 823](#)
- [Updating a List of Revoked Certificates, on page 824](#)

## Overview of Certificates and SMTP Authentication

The email gateway supports the use of client certificates to authenticate SMTP sessions between the email gateway and users' mail clients. The email gateway can request a client certificate from a user's mail client when the application attempts to connect to the email gateway to send messages. When the email gateway receives the client certificate, it verifies that the certificate is valid, has not expired, and has not been revoked. If the certificate is valid, the email gateway allows an SMTP connection from the mail application over TLS.

Organizations that require their users to use a Common Access Card (CAC) for their mail clients can use this feature to configure the email gateway to request a certificate that the CAC and ActivClient middleware application will provide to the email gateway.

You can configure the email gateway to require users to provide a certificate when sending mail, but still allow exceptions for certain users. For these users, you can configure the email gateway to use the SMTP authentication LDAP query to authenticate the user.

Users must configure their mail client to send messages through a secure connection (TLS) and accept a server certificate from the email gateway.

### Related Topics

- [How to Authenticate a User with a Client Certificate, on page 820](#)
- [How to Authenticate a User with an SMTP Authentication LDAP Query, on page 820](#)
- [How to Authenticate a User with an LDAP SMTP Authentication Query if the Client Certificate is Invalid, on page 821](#)

## How to Authenticate a User with a Client Certificate

**Table 82: How to Authenticate a User with a Client Certificate**

|        | Do This  | More Info  |
|--------|--|--|
| Step 1 | Define a certificate query for your LDAP server.   | <a href="#">Checking the Validity of a Client Certificate, on page 821</a>                               |
| Step 2 | Create a certificate-based SMTP authentication profile.  | <a href="#">Authenticating an SMTP Connection Over TLS Using a Client Certificate, on page 823</a>       |
| Step 3 | Configure a listener to use the certificate SMTP authentication profile.                           | <a href="#">Listening for Connection Requests by Creating a Listener Using Web Interface, on page 71</a> |
| Step 4 | Modify the RELAYED mail flow policy to require TLS, a client certificate, and SMTP authentication. | <a href="#">Establishing a TLS Connection from the Email Gateway, on page 823</a>                        |

## How to Authenticate a User with an SMTP Authentication LDAP Query

**Table 83: How to Authenticate a User with an SMTP Authenticate LDAP Query**

|        | Do This   | More Info   |
|--------|---|---|
| Step 1 | Define an SMTP authentication query for your server that uses an allowance query string and Bind for the authentication method. | <a href="#">Authenticating a User Using an LDAP Directory, on page 822</a>  |
| Step 2 | Create an LDAP-based SMTP authentication profile.   | <a href="#">Configuring AsyncOS for SMTP Authentication, on page 800</a>  |
| Step 3 | Configure a listener to use the LDAP SMTP authentication profile.   | If the user is not allowed to use LDAP-based SMTP authentication for their connection, you can select whether the email gateway rejects the connection or temporarily allows it while logging all activity. |
| Step 4 | Modify the RELAYED mail flow policy to require TLS and SMTP authentication.   | <a href="#">Establishing a TLS Connection from the Email Gateway, on page 823</a>   |

## How to Authenticate a User with an LDAP SMTP Authentication Query if the Client Certificate is Invalid

Table 84: How to Authenticate a User with a Client Certificate or an LDAP SMTP Authentication Query

|        | Do This  | More Info  |
|--------|--|--|
| Step 1 | Define an SMTP authentication query for your server that uses an allowance query string and Bind for the authentication method.  | <a href="#">Authenticating a User Using an LDAP Directory, on page 822</a>                               |
| Step 2 | Define a certificate-based query for your LDAP server.   | <a href="#">Checking the Validity of a Client Certificate, on page 821</a>                               |
| Step 3 | Create a certificate-based SMTP authentication profile   | <a href="#">Authenticating an SMTP Connection Over TLS Using a Client Certificate, on page 823</a>       |
| Step 4 | Create an LDAP SMTP authentication profile.  | <a href="#">Configuring AsyncOS for SMTP Authentication, on page 800</a>                                 |
| Step 5 | Configure a listener to use the certificate SMTP authentication profile.   | <a href="#">Listening for Connection Requests by Creating a Listener Using Web Interface, on page 71</a> |
| Step 6 | <ol style="list-style-type: none"> <li>1. Modify the RELAYED mail flow policy to use the following settings:</li> <li>2. TLS Preferred</li> <li>3. SMTP authentication required</li> <li>4. Require TLS for SMTP authentication</li> </ol> | <a href="#">Establishing a TLS Connection from the Email Gateway, on page 823</a>                        |

## Checking the Validity of a Client Certificate

The Certificate Authentication LDAP query checks the validity of a client certificate in order to authenticate an SMTP session between the user's mail client and the email gateway. When creating this query, you select a list of certificate fields for authentication, specify the User ID attribute (the default is uid), and enter the query string.

For example, a query string that searches for the certificate's common name and serial number may look like `(&(objectClass=posixAccount)(caccn={cn})(cacserial={sn}))`. After you have created the query, you can use it in a Certificate SMTP Authentication Profile. This LDAP query supports OpenLDAP, Active Directory, and Oracle Directory.

See [LDAP Queries, on page 771](#) for more information on configuring LDAP servers.

### Procedure

- 
- Step 1** Select **System Administration > LDAP**.
  - Step 2** Create a new LDAP profile. See [Creating LDAP Server Profiles to Store Information About the LDAP Server, on page 774](#) for more information.
  - Step 3** Check the **Certificate Authentication Query** checkbox.

- Step 4** Enter the query name.
- Step 5** Enter the query string to authenticate the user's certificate. For example, `(&(objectClass=user)(cn={cn}))`.
- Step 6** Enter the user ID attribute, such as `sAMAccountName`.
- Step 7** Submit and commit your changes.

## Authenticating a User Using an LDAP Directory

The SMTP Authentication LDAP query has an Allowance Query String that allows the email gateway to check whether the user's mail client is allowed to send mail through the email gateway based on the user's record in the LDAP directory. This allows users who don't have a client certificate to send mail as long as their record specifies that it's allowed.

You can also filter out results based on other attributes. For example, the query string `(&(uid={u})(|(! (caccn=*)) (cacexempt=*) (cacemerGENCY>={t})))` checks to see if any of the following conditions are true for the user:

- CAC is not issued to the user ( `caccn=*`  )
- CAC is exempt ( `cacexempt=*`  )
- the time period that a user may temporarily send mail without a CAC expires in the future ( `cacemerGENCY>={t}`  )

See [Configuring AsyncOS for SMTP Authentication, on page 800](#) for more information on using the SMTP Authentication query.

### Procedure

- Step 1** Select **System Administration > LDAP**.
- Step 2** Define an LDAP profile. See [Creating LDAP Server Profiles to Store Information About the LDAP Server, on page 774](#) for more information.
- Step 3** Define an SMTP authentication query for the LDAP profile.
- Step 4** Check the SMTP Authentication Query checkbox.
- Step 5** Enter the query name.
- Step 6** Enter the string to query for the user's ID. For example, `(uid={u})`.
- Step 7** Select LDAP BIND for the authentication method.
- Step 8** Enter an allowance query string. For example, `(&(uid={u})(|(! (caccn=*)) (cacexempt=*) (cacemerGENCY>={t})))`.
- Step 9** Submit and commit your changes.

# Authenticating an SMTP Connection Over TLS Using a Client Certificate

The certificate-based SMTP authentication profile allows the email gateway to authenticate an SMTP connection over TLS using a client certificate. When creating the profile, you select the Certificate Authentication LDAP query to use for verifying the certificate. You can also specify whether the email gateway falls back to the **SMTP AUTH** command to authenticate the user if a client certificate is not available.

For information on authenticating an SMTP connection by using LDAP, see [Configuring AsyncOS for SMTP Authentication, on page 800](#).

## Procedure

---

- Step 1** Select **Network > SMTP Authentication**.
  - Step 2** Click **Add Profile**.
  - Step 3** Enter the name for the SMTP authentication profile.
  - Step 4** Select **Certificate** for the Profile Type.
  - Step 5** Click **Next**.
  - Step 6** Enter the profile name.
  - Step 7** Select the certificate LDAP query you want to use with this SMTP authentication profile.  
**Note** Do not select the option to allow the SMTP AUTH command if a client certificate is not available.
  - Step 8** Click **Finish**.
  - Step 9** Submit and commit your changes.
- 

## Establishing a TLS Connection from the Email Gateway

The Verify Client Certificate option in the RELAYED mail flow policy directs the email gateway to establish a TLS connection to the user's mail application if the client certificate is valid. If you select this option for the TLS Preferred setting, the email gateway still allows a non-TLS connection if the user doesn't have a certificate, but rejects a connection if the user has an invalid certificate. For the TLS Required setting, selecting this option requires the user to have a valid certificate in order for the email gateway to allow the connection.

To authenticate a user's SMTP session with a client certificate, select the following settings:

- TLS - Required
- Verify Client Certificate
- Require SMTP Authentication



---

**Note** Although SMTP authentication is required, the email gateway will not use the SMTP authentication LDAP query because it is using certificate authentication.

---

To authenticate a user's SMTP session using the SMTP authentication query instead of a client certificate, select the following settings for the RELAYED mail flow policy:

- TLS - Required
- Require SMTP Authentication

If you require the email gateway to ask for a client certificate from certain users while allowing LDAP-based SMTP authentication from others, select the following settings for the RELAYED mail flow policy:

- TLS - Preferred
- Require SMTP Authentication
- Require TLS to Offer SMTP Authentication

## Updating a List of Revoked Certificates

The Email Security appliance checks a list of revoked certificates (called a Certificate Revocation List) as part of its certificate verification to make sure that the user's certificate hasn't been revoked. You keep an up-to-date version of this list on a server and the email gateway downloads it on a schedule that you create.

### Procedure

---

- Step 1** Go to **Network > CRL Sources**.
- Step 2** Enable CRL checking for SMTP TLS connections:
- a) Click Edit Settings under Global Settings.
  - b) (Optional) Select the **Global Settings** checkbox if you want to select all options:
    - CRL check for inbound SMTP TLS.
    - CRL check for outbound SMTP TLS
    - CRL Check for Web Interface
  - c) Select the checkbox for either 'CRL check for inbound SMTP TLS', 'CRL check for outbound SMTP TLS' or 'CRL Check for Web Interface' options.
  - d) Submit your change.
- Step 3** Click **Add CRL Source**.
- Step 4** Enter a name for the CRL source.
- Step 5** Select the file type. This can be either ASN.1 or PEM.
- Step 6** Enter the URL for the primary source for the file, including the filename. For example, **https://crl.example.com/certs.crl**
- Step 7** Optionally, enter the URL for a secondary source in case the email gateway cannot contact the primary source.
- Step 8** Specify a schedule for downloading the CRL source.
- Step 9** Enable the CRL source.
- Step 10** Submit and commit your changes.
-



## Authenticating a User's SMTP Session With a Client Certificate

### Procedure

---

- Step 1** Go to **System Administration > LDAP** to configure an LDAP server profile.
- Step 2** Define a certificate query for the LDAP profile.
- Enter the query name.
  - Choose the certificate fields to authenticate, such as the serial number and common name.
  - Enter the query string. For example, `(&(caccn={cn})(cacserial={sn}))`.
  - Enter the user ID field, such as uid.
  - Submit your changes.
- Step 3** Go to **Network > SMTP Authentication** to configure a Certificate SMTP authentication profile.
- Enter the profile name.
  - Select the certificate LDAP query you want to use.
  - Do not select the option to allow the **SMTP AUTH** command if a client certificate is not available.
  - Submit your changes.
- Step 4** Go to **Network > Listeners** to configure a listener to use the certificate SMTP authentication profile that you created.
- Step 5** Modify the RELAYED mail flow policy to require TLS and a client certificate, as well as require SMTP authentication.
- Note** Although SMTP authentication is required, the email gateway will not use the SMTP AUTH command because it is using certificate authentication. The email gateway will require a client certificate from the mail application to authenticate the user.
- Step 6** Submit and commit your changes.
- 

## Authenticating a User's SMTP Session with the SMTP AUTH Command

The email gateway can use the SMTP AUTH command to authenticate a user's SMTP session instead of a client certificate. If you user is not allowed to use SMTP AUTH for their connection, you can select whether the email gateway rejects the connection or temporarily allows it while logging all activity.

### Procedure

---

- Step 1** Go to **System Administration > LDAP** to configure an LDAP server profile.
- Step 2** Define an SMTP authentication query for the LDAP profile.
- Enter the query name.
  - Enter the query string. For example, `(uid={u})`.
  - Select LDAP Bind for the authentication method.
  - Enter an allowance query string. For example, `(&(uid={u})(!(caccn=*)(cacexempt=*)(cacemergency>={t})))`.
  - Submit your changes.

- Step 3** Go to **Network > SMTP Authentication** to configure an LDAP SMTP authentication profile.
- Enter the profile name.
  - Select the SMTP authentication LDAP query you want to use.
  - Select the Check with LDAP if user is allowed to use SMTP AUTH Command and choose to monitor and report the user's activity.
  - Submit your changes.
- Step 4** Go to **Network > Listeners** to configure a listener to use the LDAP SMTP authentication profile that you created.
- Step 5** Modify the RELAYED mail flow policy to require TLS and SMTP authentication.
- Step 6** Submit and commit your changes.
- 

## Authenticating a User's SMTP Session with Either a Client Certificate or SMTP AUTH

This configuration requires the email gateway to ask for a client certificate from users with a client certificate while allowing SMTP AUTH for users without one, or who cannot use one for sending email.

Any attempt to use the SMTP AUTH command by a user who is not allowed will be prohibited.

### Procedure

---

- Step 1** Go to **System Administration > LDAP** to configure an LDAP server profile.
- Step 2** Define an SMTP authentication query for the profile.
- Enter the query name.
  - Enter the query string. For example, `(uid={u})`.
  - Select LDAP Bind for the authentication method.
  - Enter an allowance query string. For example, `(&(uid={u})(!(caccn=*)(cacexempt=*)(cacemergency>={t})))`.
- Step 3** Define a certificate query for the LDAP profile.
- Enter the query name.
  - Choose the client certificate fields to authenticate, such as the serial number and common name.
  - Enter the query string. For example, `(&(caccn={cn})(cacserial={sn}))`.
  - Enter the user ID field, such as uid.
  - Submit your changes.
- Step 4** Go to **Network > SMTP Authentication** to configure an LDAP SMTP authentication profile.
- Enter the profile name.
  - Select the SMTP authentication LDAP query you want to use.
  - Select the Check with LDAP if user is allowed to use SMTP AUTH Command and choose to reject the connection.
  - Enter a custom SMTP AUTH response. For example, 525, "Dear user, please use your CAC to send email."
  - Submit your changes.

- Step 5** Configure a Certificate SMTP authentication profile.
- Enter the profile name.
  - Select the certificate LDAP query you want to use.
  - Select the option to allow the SMTP AUTH command if a client certificate is not available.
  - Select your LDAP SMTP authentication profile for the email gateway to use if the user does not have a client certificate.
  - Submit your changes.
- Step 6** Go to **Network > Listeners** to configure a listener to use the certificate SMTP authentication profile you created.
- Step 7** Modify the RELAYED mail flow policy to select the following options:
- TLS Preferred
  - SMTP authentication required
  - Require TLS for SMTP Authentication
- Step 8** Submit and commit your changes.
-





## CHAPTER 34

# Using Email Security Monitor

---

This chapter contains the following sections:

- [Email Security Monitor Overview, on page 829](#)
- [Email Security Monitor Pages, on page 830](#)
- [Email Security Monitor Pages on the New Web Interface, on page 863](#)
- [Reporting Overview, on page 904](#)
- [Managing Reports, on page 906](#)
- [Troubleshooting Email Reports, on page 909](#)

## Email Security Monitor Overview

The Email Security Monitor feature collects data from every step in the email delivery process. The database identifies and records each email sender by IP address, while interfacing with the IP Reputation Service for real-time identity information. You can instantly report on any email sender's local mail flow history and show a profile that includes the sender's global record on the Internet. The Email Security Monitor feature allows your security team to “close the loop” on who is sending mail to your users, the amount of mail sent from and received by your users, and the effectiveness of your security policies.

This chapter explains how to:

- Access the Email Security Monitor feature to monitor inbound and outbound message flow.
- Make mail flow policy decisions (update allowed lists, blocked lists, and greylists) by querying for a sender's IP Reputation Score. You can query on network owners, domains, and even individual IP addresses.
- Report on mail flow, system status, and mail sent to and from your network.

For any given email sender for incoming mail, the Email Security Monitor database captures critical parameters such as:

- Message volume
- Connection history
- Accepted vs. rejected connections
- Acceptance rates and throttle limits
- Sender reputation filter matches
- Number of anti-spam messages for suspected spam and positively identified spam
- Number of virus-positive message detected by anti-virus scanning

See [Managing Spam and Graymail, on page 379](#) for more information on Anti-Spam scanning and [Anti-Virus, on page 361](#) for more information on anti-virus scanning.

The Email Security Monitor feature also captures information on which content filter a particular message triggers, including the internal user (email recipient) to or from which the message was sent.

The Email Security Monitor feature is available in the GUI only, and provides a view into your email traffic and the status of your email gateway (including quarantines, work queues, and outbreaks). The email gateway identifies when a sender falls outside of the normal traffic profile. Senders that do are highlighted in the interface, allowing you to take corrective action by assigning that sender to a sender group or refining the access profile of the sender; or, you can let AsyncOS's security services continue to react and respond. Outbound mail has a similar monitoring capability, providing you a view into the top domains in the mail queue and the status of receiving hosts (see [Delivery Status Details Page, on page 845](#)).



---

**Note** Information for messages present in the work queue when the email gateway is rebooted is not reported by the Email Security Monitor feature.

---

#### Related Topics

- [Email Security Monitor and Centralized Management, on page 830](#)

## Email Security Monitor and Centralized Management

To view aggregated report data, deploy a Cisco Secure Email and Web Manager.

You cannot aggregate Email Security Monitor reports of clustered appliances. All reports are restricted to machine level. This means they cannot be run at the group or cluster levels — only on individual machines.

The same is true of the Archived Reports page — each machine in effect has its own archive. Thus, the “Generate Report” feature runs on the selected machine.

The Scheduled Reports page is not restricted to machine level; therefore, settings can be shared across multiple machines. Individual scheduled reports run at machine level just like interactive reports, so if you configure your scheduled reports at cluster level, every machine in the cluster will send its own report.

The “Preview This Report” button always runs against the login-host.

## Email Security Monitor Pages

The Email Security Monitor feature is comprised of all the pages available on the Monitor menu except the Quarantines pages.

You use these pages in the GUI to monitor domains that are connecting to the appliance's listeners. You can monitor, sort, analyze, and classify the “mail flow” of your email gateway and differentiate between high-volume senders of legitimate mail and potential “spammers” (senders of high-volume, unsolicited commercial email) or virus senders. These pages can also help you troubleshoot inbound connections to the system (including important information such as IP Reputation score and most recent sender group match for domains).

These pages help you classify mail relative to the email gateway, and also relative to the services that exist beyond the scope of the gateway, such as the IP Reputation Service, the Anti-Spam scanning service, the Anti-Virus scanning security services, content filters, and Outbreak Filters.

You can generate a printer-friendly formatted .PDF version of any of the Email Security Monitor pages by clicking on the Printable PDF link at the top-right of the page. For information about generating PDFs in languages other than English, see the [Notes on Reports, on page 906](#).

You can export graphs and other data to CSV (comma separated values) format via the **Export** link.

The exported CSV data will display all message tracking and reporting data in GMT regardless of what is set on the email gateway. The purpose of the GMT time conversion is to allow data to be used independently from the email gateway or when referencing data from appliances in multiple time zones.



---

**Note** If you export localized CSV data, the headings may not render properly in some browsers. This occurs because some browsers may not use the correct character set for the localized text. To work around this problem, you can save the file to disk, and open the file using File > Open. When you open the file, select the character set to display the localized text.

---

For more information about automating the export of report data, see [Retrieving CSV Data, on page 861](#)).

#### List of Email Security Monitor Pages

- [My Dashboard Page](#) , on page 833
- [Overview Page](#), on page 834
- [Incoming Mail Page](#), on page 837
- [Outgoing Destinations](#), on page 843
- [Outgoing Senders](#), on page 843
- [Delivery Status Page](#), on page 844
- [Internal Users Page](#), on page 845
- [DLP Incidents Page](#), on page 846
- [Content Filters Page](#), on page 848
- [DMARC Verification Page](#), on page 848
- [Outbreak Filters Page](#), on page 849
- [Virus Types Page](#), on page 851
- [URL Filtering Page](#) , on page 851
- [Web Interaction Tracking Page](#), on page 852
- [File Reputation and File Analysis Reports](#), on page 853
- [TLS Connections Page](#), on page 853
- [Inbound SMTP Authentication Page](#), on page 854
- [Rate Limits Page](#) , on page 855

- [System Capacity Page](#), on page 855
- [System Status Page](#), on page 858
- [High Volume Mail Page](#), on page 860
- [Message Filters Page](#), on page 860
- [Geo Distribution Page](#), on page 844
- [Safe Print Page](#), on page 861

## Searching and Email Security Monitor

Many of the Email Security Monitor pages include a search form. You can search for different types of items:

- IP Address (IPv4 and IPv6)
- domain
- network owner
- internal users
- destination domain
- internal sender domain
- internal sender IP address
- outgoing domain deliver status

For domain, network owner, and internal user searches, choose whether to exactly match the search text or look for items starting with the entered text (for instance, starts with “ex” will match “example.com”).

For IPv4 address searches, the entered text is always interpreted as the beginning of up to four IP octets in dotted decimal format. For instance, “17” will search in the range 17.0.0.0 through 17.255.255.255, so it will match 17.0.0.1 but not 172.0.0.1. For an exact match search, simply enter all four octets. IP address searches also support CIDR format (17.16.0.0/12).

For IPv6 address searches, AsyncOS supports the following formats:

- 2001:db8:2004:4202::0-2001:db8:2004:4202::ff
- 2001:db8:2004:4202::
- 2001:db8:2004:4202::23
- 2001:db8:2004:4202::/64

All searches are bounded by the time range currently selected on the page.

## Viewing Details of Messages Included in Reports

This functionality works only if reporting and tracking are both local (not centralized on a Cisco Secure Email and Web Manager.)

### Procedure

- 
- Step 1** Click any blue number in a table on a report page.  
(Not all tables have these links.)



The messages included in that number are displayed in Message Tracking.

**Step 2** Scroll down to see the list.

### What to do next

#### Related Topics

- [Working with Message Tracking Search Results](#) , on page 917

## My Dashboard Page

You can create a custom email security report page by assembling charts (graphs) and tables from existing report pages.

| To                                     | Do This  |
|--|--|
| Add modules to your custom report page | <ol style="list-style-type: none"> <li>1. Go to <b>Monitor &gt; My Dashboard</b> and delete any sample modules that you do not need by clicking the [X] in the top right corner of the module.</li> <li>2. Do one of the following: <ul style="list-style-type: none"> <li>• Click the [+] button on a module in a report page under the Monitor menu to add it to your custom report.</li> <li>• Go to <b>Monitor &gt; My Dashboard</b>, click the [+] button in one of the sections, then select the report module that you want to add. You may need to check the + <b>Report Module in</b> each section to find the report that you are looking for.</li> </ul> </li> <li>3. Modules are added with default settings. If you add a module that you have customized (for example, by adding, deleting, or reordering columns), customize these modules again after adding them. Time range of the original module is not maintained.</li> <li>4. If you add a chart that includes a separate legend (for example, a graph from the Overview page), add the legend separately. If necessary, drag and drop it into position beside the data it describes.</li> </ol> <p>Notes:</p> <ul style="list-style-type: none"> <li>• Some modules on some report pages are available only using one of the above methods. If you cannot add a module using one method, try the other method.</li> <li>• You can add each module only once; if you have already added a particular module to your report, the option to add it will not be available.</li> </ul> |
| View your custom report page           | <ol style="list-style-type: none"> <li>1. Choose <b>Monitor &gt; My Dashboard</b></li> <li>2. For reports in the Time Range section: The time range selected for all report pages applies to all modules on the My Dashboard page. Select the time range to view.</li> </ol> <p>Newly-added modules appear at the top of the relevant section.</p>   |

| To   | Do This  |
|--|--|
| Rearrange modules on your custom report page | Drag and drop modules into the desired location.     |
| Delete modules from your custom report page  | Click the [X] in the top right corner of the module. |

## Overview Page

The Overview page provides a synopsis of the message activity of your email gateway, including an overview of your quarantines and Outbreak Filters status (in the System Overview section of the page). The Overview page also includes graphs and detailed message counts for incoming and outgoing messages. You can use this page to monitor the flow of all mail into and out of your gateway.

The Overview page highlights how the email gateway is integrated with the IP Reputation Service for incoming mail (messages stopped by reputation filtering, for example). On the **Overview** page, you can:

- View a mail trend graph of all mail “flowing” into or out of your gateway.
- View a graph showing the number of attempted messages, messages stopped by IP reputation filtering, messages with invalid recipients, messages marked as spam, messages marked as virus positive, and clean messages, over time.
- View the summary of the system status and local quarantines.
- See current virus and non-virus outbreak information based on information available at the Threat Operations Center (TOC).

The Overview page is divided into two sections: System Overview and Incoming and Outgoing Mail graphs and summary.

### Related Topics

- [System Overview, on page 834](#)
- [Incoming and Outgoing Summary and Graph, on page 835](#)
- [Categorizing Email, on page 836](#)
- [How Messages are Categorized, on page 837](#)

## System Overview

The System Overview section of the Overview page serves as a system dashboard, providing details about the email gateway including system and work queue status, quarantine status, and outbreak activity.

### Related Topics

- [Status, on page 834](#)
- [System Quarantines, on page 835](#)
- [Virus Threat Level, on page 835](#)

## Status

This section provides an overview of the current state of the email gateway and inbound mail processing.

**System Status:** One of the following states:

- Online
- Resource Conservation
- Delivery Suspended
- Receiving Suspended
- Work Queue Paused
- Offline

See the [Managing and Monitoring Using the CLI, on page 1095](#) for more information.

**Incoming Messages:** The average rate of incoming mail per hour.

**Work Queue:** The number of messages awaiting processing in the work queue.

Click the System Status Details link to navigate to the System Status page.

## System Quarantines

This section displays information about the top three quarantines by disk usage on the email gateway, including the name of the quarantine, how full the quarantine is (disk space), and the number of messages currently in the quarantine.

Click the Local Quarantines link to navigate to the Local Quarantines page.

## Virus Threat Level

This section shows the Outbreak status as reported by the Threat Operations Center (TOC). Also shown is the status of the Outbreak quarantine, including how full it is (disk space) and the number of messages in the quarantine. The Outbreak quarantine is only displayed if you have enabled the Outbreak Filters feature on your email gateway.



---

**Note** In order for the Threat Level indicator to function, you need to have port 80 open on your firewall to “[downloads.ironport.com](#).” Alternatively, if you have specified a local update server, the Threat Level indicator will attempt to use that address. The Threat Level indicator will also update correctly if you have configured a proxy for downloads via the Service Updates page. For more information, see [Service Updates , on page 1029](#).

---

Click the Outbreak Details link to view the external Threat Operations Center web site. Note that in order for this link to work, your email gateway must be able to access the Internet. Note that the Separate Window icon indicates that a link will open in a separate window when clicked. You may need to configure your browser’s pop-up blocker settings to allow these windows.

## Incoming and Outgoing Summary and Graph

The Incoming and Outgoing summary sections provide access to real-time activity of all mail activity on your system and is comprised of the Incoming and Outgoing Mail Graphs and Mail Summaries. You can select the time frame on which to report via the Time Range menu. The time range you select is used throughout all of the Email Security Monitor pages. The explanations of each type or category of message are below (see [Categorizing Email, on page 836](#)).

While the mail trend graph displays a visual representation of the mail flow, the summary table provides a numeric breakdown of the same information. The summary table includes the percentage and actual number of each type of message, including the total number of attempted, threat, and clean messages.

The outgoing graph and summary show similar information for outbound mail.

### Related Topics

- [Notes on Counting Messages in Email Security Monitor, on page 836](#)

## Notes on Counting Messages in Email Security Monitor

The method Email Security Monitor uses to count incoming mail depends on the number of recipients per message. For example, an incoming message from example.com sent to three recipients would count as three messages coming from that sender.

Because messages blocked by sender reputation filtering do not actually enter the work queue, the email gateway does not have access to the list of recipients for an incoming message. In this case, a multiplier is used to estimate the number of recipients. This multiplier was determined by Cisco and based upon research of a large sampling of existing customer data.

## Categorizing Email

Messages reported in the Overview and Incoming Mail pages are categorized as follows:

- **Stopped by IP Reputation Filtering:** All connections blocked by HAT policies multiplied by a fixed multiplier (see [Notes on Counting Messages in Email Security Monitor, on page 836](#)) plus all recipients blocked by recipient throttling.
- **Stopped by Domain Reputation Filtering:** The total count of messages blocked based on the reputation verdict of the sender domain.
- **Invalid Recipients:** All recipients rejected by conversational LDAP rejection plus all RAT rejections.
- **Spam Messages Detected:** The total count of messages detected by the anti-spam scanning engine as positive or suspect and also those that were both spam and virus positive.
- **Virus Messages Detected:** The total count and percentage of messages detected as virus positive and not also spam.



---

**Note** If you have configured your anti-virus settings to deliver unscannable or encrypted messages, these messages will be counted as clean messages and not virus positive. Otherwise, the messages are counted as virus positive.

---

- **Detected by Advanced Malware Protection:** A message attachment was found to be malicious by file reputation filtering. This value does not include verdict updates or files found to be malicious by file analysis.
- **Messages with Malicious URLs:** One or more URLs in the message were found to be malicious by URL filtering.
- **Stopped by Content Filter:** The total count of messages that were stopped by a content filter.
- **Stopped by DMARC:** The total count of messages that were stopped after DMARC verification.



---

**Note** The email gateway displays the total count of 'Stopped by DMARC' messages based on the 'Failed - Rejected,' 'Failed - Quarantined,' and 'Failed - No Action' results.

---

- **S/MIME Verification/Decryption Failed:** The total count of messages that failed S/MIME verification, decryption, or both.
- **S/MIME Verification/Decryption Successful:** The total count of messages that were successfully verified, decrypted, or decrypted and verified using S/MIME.
- **Clean Messages:** Mail that is accepted and is deemed to be virus and spam free — the most accurate representation of clean messages accepted when taking per-recipient scanning actions (such as splintered messages being processed by separate mail policies) into account. However, because messages that are marked as spam or virus positive and still delivered are not counted, the actual number of messages delivered may differ from the clean message count.
- **Graymail Messages**
  - **Marketing Messages:** The total count of advertising messages sent by professional marketing groups, for example Amazon.com.
  - **Social Networking Messages:** The total count of notification messages from social networks, dating websites, forums, and so on. Examples include LinkedIn and CNET forums.
  - **Bulk Messages:** The total count of advertising messages sent by unrecognized marketing groups, for example, TechTarget, a technology media company.

Click on the number corresponding to any of the above mentioned graymail categories to view a list of messages belonging to that category using Message Tracking.



---

**Note** Messages that match a *message* filter and are not dropped or bounced by the filter are treated as clean. Messages dropped or bounced by a message filter are not counted in the totals.

---

## How Messages are Categorized

As messages proceed through the email pipeline, they can apply to multiple categories. For example, a message can be marked as spam, virus, or malware positive, and it can also match a content filter. The various verdicts follow these rules of precedence: Outbreak Filters quarantining (in this case the message is not counted until it is released from the quarantine and again processed through the work queue), followed by spam positive, virus positive, malware positive, and matching a content filter.

For example, if a message is marked as spam positive, and the anti-spam settings are set to drop spam positive messages, the message is dropped and the spam counter is incremented. Further, if the anti-spam settings are set to let the spam positive message continue on in the pipeline, and a subsequent content filter drops, bounces, or quarantines the message, the spam count is still incremented. The content filter count is only incremented if the message is not spam, virus, or malware positive.

## Incoming Mail Page

The **Incoming Mail** page provides a mechanism to report on the real-time information being collected by the Email Security Monitor feature for all remote hosts connecting to your email gateway. This allows you to gather more information about an IP address, domain, and organization (network owner) sending mail to you. You can perform a Sender Profile search on IP addresses, domains, or organizations that have sent mail to you.

The Incoming Mail page has three views: Domain, IP Address, and Network Owner and provides a snapshot of the remote hosts connecting to the system in the context of the selected view.

It displays a table (Incoming Mail Details) of the top domains (or IP addresses, or network owners, depending on the view) that have sent mail to all public listeners configured on the email gateway. You can monitor the flow of all mail into your gateway. You can click on any domain/IP/network owner to drill down to access details about this sender on a Sender Profile page (this is an Incoming Mail page, specific to the domain/IP/network owner you clicked on).

Not all available columns are displayed by default. You can show a different set of information by clicking the Columns link below the table. For example, you can show the "Detected by Advanced Malware Protection" column, which is hidden by default.

The Incoming Mail page extends to include a group of pages (Incoming Mail, Sender Profiles, and the Sender Group Report). From the **Incoming Mail** pages, you can:

- Perform a search on IP addresses, domains, or organizations (network owners) that have sent mail to you.
- View the Sender Groups report to see connections via a specific sender group and mail flow policy actions. See [Sender Groups Report, on page 842](#) for more information.
- See detailed statistics on senders which have sent mail to you, including the number of attempted messages broken down by security service (sender reputation filtering, anti-spam, anti-virus, graymail, and so on).
- Sort by senders who have sent you a high volume of spam or virus email, as determined by anti-spam or anti-virus security services.
- Use the IP Reputation service to drill down on and examine the relationship between specific IP addresses, domains, and organizations to obtain more information about a sender.
- Drill down on specific senders to obtain more information about a sender from the IP Reputation Service, including a sender's IP Reputation Score and which sender group the domain matched most recently. Add senders to sender groups.
- Drill down on a specific sender who sent a high volume of spam or virus email, as determined by the anti-spam or anti-virus security services.
- Once you have gathered information on a domain, you can add the IP address, domain, or organization to an existing sender group (if necessary) by clicking "Add to Sender Group" from a domain, IP address, or network owner profile page. See [Configuring the Gateway to Receive Email, on page 65](#).

### Related Topics

- [Incoming Mail, on page 838](#)
- [Incoming Mail Details Listing, on page 839](#)
- [Reporting Pages Populated with Data: Sender Profile Pages, on page 841](#)
- [Sender Groups Report, on page 842](#)

## Incoming Mail

The Incoming Mail page provides access to real-time activity of all public listeners configured on your system and is comprised of two main sections: the mail trend graphs summarizing the top sender domains received (by total threat messages, total clean messages, and total graymail messages) and the Incoming Mail Details listing.

See [Incoming Mail Details Listing, on page 839](#) for an explanation of the data included in the Incoming Mail Details listing.

### Related Topics

[Notes on Time Ranges in the Mail Trend Graph, on page 839](#)

## Notes on Time Ranges in the Mail Trend Graph

The Email Security Monitor feature constantly records data about the mail flowing into your gateway. The data are updated every 60 seconds, but the display shown is delayed by 120 seconds behind the current system time. You can specify the time range to include in the results shown. Because the data is monitored in real time, information is periodically updated and summarized in the database.

Choose from the time range options in the following table.

**Table 85: Time Ranges Available in the Email Security Monitor Feature**

| This time range selected in the GUI | ...is defined as:  |
|-------------------------------------|--|
| Hour                                | the last 60 minutes + up to 5 minutes  |
| Day                                 | the last 24 hours + the last 60 minutes  |
| Week                                | the last 7 days + the elapsed hours of the current day                                   |
| 30 days                             | the last 30 days + the elapsed hours of the current day                                  |
| 90 days                             | the last 90 days + the elapsed hours of the current day                                  |
| Yesterday                           | 00:00 to 23:59 (midnight to 11:59 PM)  |
| Previous Calendar Month             | 00:00 of the first day of the month to 23:59 of the last day of the month                |
| Custom Range                        | the range enclosed by the start date and hour and the end date and hour that you specify |

The time range options that you see will differ if you have enabled Centralized Reporting. For details, see information about Centralized Reporting Mode in [Centralizing Services on a Cisco Secure Email and Web Manager \(M-Series\)](#), on page 1291

## Incoming Mail Details Listing

The top senders which have connected to public listeners of the email gateway are listed in the External Domains Received listing table at the bottom of the Incoming Mail page, based on the view selected. Click the column headings to sort the data. See [Categorizing Email](#), on page 836 for an explanation of the various categories.

The system acquires and verifies the validity of the remote host's IP address (that is, the domain) by performing a *double DNS lookup*. For more information about double DNS lookups and sender verification, see [Configuring the Gateway to Receive Email](#), on page 65.

The Sender Detail listing has two views, Summary and All.

The default Sender Detail view shows the total number of attempted messages for each sender, and includes a breakdown by category (the same categories as the Incoming Mail Summary graph on the Overview page.

The value for Stopped by IP Reputation Filtering is calculated based on several factors:

- Number of “throttled” messages from this sender.
- Number of rejected or TCP refused connections (may be a partial count).
- A conservative multiplier for the number of messages per connection.

When the email gateway is under heavy load, an exact count of rejected connections is not maintained on a per-sender basis. Instead, rejected connections counts are maintained only for the most significant senders in each time interval. In this situation, the value shown can be interpreted as a "floor"; in other words, at least this many messages were stopped.



---

**Note** The Stopped by IP Reputation Filtering total on the Overview page is always based on a complete count of all rejected connections. Only the per-sender connection counts are ever limited due to load.

---

Additional columns that you can display are:

**Connections Rejected:** All connections blocked by HAT policies. When the email gateway is under heavy load, an exact count of rejected connections is not maintained on a per-sender basis. Instead, rejected connections counts are maintained only for the most significant senders in each time interval.

**Connections Accepted:** All connections accepted

**Stopped by Domain Reputation Filtering:** All messages blocked by the reputation verdict of the sender domain.

**Stopped by Recipient Throttling:** This is a component of Stopped by Reputation Filtering. It represents the number of recipient messages stopped because any of the following HAT limits have been exceeded: maximum recipients per hour, maximum recipients per message, or maximum messages per connection. This is summed with an estimate of the recipient messages associated with rejected or TCP refused connections to yield Stopped by Reputation Filtering.

**Detected by Advanced Malware Protection:** Messages with attachments that were found to be malicious by file reputation filtering. This value does not include verdict updates or files found to be malicious by file analysis.

**Total Threat:** Total number of threat messages (stopped by sender reputation, stopped as invalid recipient, spam, plus virus).

Show or hide columns by clicking the Column link at the bottom of the table.

Sort the listing by clicking the column header links. A small triangle beside the column header indicates the column by which the data is currently sorted.

#### Related Topics

- ["No Domain Information", on page 840](#)
- [Querying for More Information, on page 840](#)

#### "No Domain Information"

Domains which have connected to the email gateway and could not be verified with a double-DNS lookup are automatically grouped into the special domain "No Domain Information." You can control how these types of unverified hosts are managed via Sender Verification. See [Configuring the Gateway to Receive Email, on page 65](#).

You can select the number of senders to show in the listing via the Items Displayed menu.

#### Querying for More Information

For senders listed in the Email Security Monitor table, click the sender (or "No Domain Information" link) to drill down for more information on the particular sender. The results are displayed on a Sender Profile page



which includes real-time information from the IP Reputation Service. From the Sender Profile page, you can drill down for more information on specific IP addresses or network owners (see [Reporting Pages Populated with Data: Sender Profile Pages, on page 841](#)).

You can also view another report, the Sender Groups report, by clicking the Sender Groups report link at the bottom of the Incoming Mail page. For more information about Sender Groups reports, see [Sender Groups Report, on page 842](#).

## Reporting Pages Populated with Data: Sender Profile Pages

If you clicked a sender in the Incoming Mail Details table on an Incoming Mail page, the resulting *Sender Profile page* is listed with data for the particular IP address, domain, or organization (network owner). Sender Profile pages show detailed information for the sender. You can access a Sender Profile page for any network owner, domain, or IP address by clicking on the specified item in the Incoming Mail or other Sender Profile pages. Network owners are entities that contain domains; domains are entities that contain IP addresses. For more information on this relationship and how it relates to the IP Reputation Service, see [Configuring the Gateway to Receive Email, on page 65](#).

The Sender Profile pages displayed for IP addresses, network owners, and domains vary slightly. For each, the page contains a graph and summary table for incoming mail from this sender. Below the graph is a table listing domains or IP addresses associated with the sender (the Sender Profile page for individual IP addresses does not contain the detailed listing) and an information section with the current SenderBase, sender group, and network information for the sender.

- Network Owner profile pages contain information for the network owner, as well as the domains and IP addresses associated with that network owner.
- Domain profile pages contain information for the domains and IP addresses associated with that domain.
- IP address profile pages contain information about the IP address only.

Each sender profile page contains the following data in the Current Information table at the bottom of the page:

- The **Global** information from the IP Reputation Service, including:
  - IP Address, Domain Name, and/or Network Owner
  - Network Owner Category (Network Owner Only)
  - CIDR Range (IP addresses only)
  - Daily Magnitude and Monthly Magnitude for the IP address, Domain, and/or Network Owner
  - Days since the first message was received from this sender
  - Last sender group and whether DNS verified (IP Address sender profile page only)

Daily magnitude is a measure of how many messages a domain has sent over the last 24 hours. Similar to the Richter scale used to measure earthquakes, SenderBase magnitude is a measure of message volume calculated using a log scale with a base of 10. The maximum theoretical value of the scale is set to 10, which equates to 100% of the world's email message volume (approximately 10 billion messages/day). Using the log scale, a one-point increase in magnitude equates to a 10x increase in actual volume.

Monthly magnitude is calculated using the same approach as daily magnitude, except the percentages are calculated based on the volume of email sent over the last 30 days.

- Average Magnitude (IP addresses only)
- Lifetime Volume / 30 Day Volume (IP address profile pages only)
- Bonded Sender Status (IP address profile pages only)
- IP Reputation Score (IP address profile pages only)

- Days Since First Message (network owner and domain profile pages only)
- Number of Domains Associated with this Network Owner (network owner and domain profile pages only)
- Number of IP Addresses in this Network Owner (network owner and domain profile pages only)
- Number of IP Addresses used to Send Email (network owner pages only)

Click the “More from SenderBase” link to see a page with all information supplied by the IP Reputation Service.

- The **Mail Flow Statistics** information, with Email Security Monitor information collected about the sender over the time range that you specify.
- **Details** about the domains and IP addresses controlled by this network owner are displayed on network owner profile pages. Details about the IP addresses in the domain are displayed on domain pages.

From a domain profile page, you can drill down to a specific IP address, or drill up to view an organization profile page. You can also display the DNS Verified status, IP Reputation Score, and Last Sender Group for each sender address in the IP Addresses table by clicking the Columns link at the bottom of that table. You can also hide any columns in that table.

From a network owner profile page, you can display information such as Connections Rejected, Connections Accepted, Stopped by Recipient Throttling, and Detected by Advanced Malware Protection for each domain in the Domains table by clicking the Columns link at the bottom of that table. You can also hide any columns in that table.

If you are an administrator of the system, on each of these pages, you can choose to add the network owner, domain, or IP address to a sender group by clicking the check box for the entity (if necessary) and then clicking Add to Sender Group.

You can also add a sender to a sender group by clicking the **Add to Sender Group** link below the Sender Group Information in the Current Information table for the sender and clicking Add to Sender Group. For more information about adding senders to sender groups, see [Configuring the Gateway to Receive Email, on page 65](#). Of course, you do not have to make any changes — you can let the security services handle incoming mail.

### Related Topics

- [Sender Profile Search, on page 842](#)

### Sender Profile Search

Type an IP address, a domain, or an organization name in the Quick Search box to search for a specific sender.

A Sender Profile page is displayed with the information for sender. See [Reporting Pages Populated with Data: Sender Profile Pages, on page 841](#).

## Sender Groups Report

The Sender Groups report provides a summary of connections by sender group and mail flow policy action, allowing you to review SMTP connection and mail flow policy trends. The Mail Flow by Sender Group listing shows the percentage and number of connections for each sender group. The Connections by Mail Flow Policy Action chart shows the percentage of connections for each mail flow policy action. This page provides an overview of the effectiveness of your Host Access Table (HAT) policies. For more information about the HAT, see [Configuring the Gateway to Receive Email, on page 65](#).

## Sender Domain Reputation Page

You can use the Sender Domain Reputation report page to view:

- Incoming messages based on the verdict received from the SDR service in graphical format.
- Summary of incoming messages based on the threat category and verdict received from the SDR service in tabular format.
- Incoming messages based on the threat category received from the SDR service in graphical format.



---

**Note** Only the messages whose SDR verdict is 'untrusted' or 'questionable' are classified under the SDR threat category, such as, 'spam,' 'malicious,' and so on.

---

- Summary of incoming messages based on the threat category received from the SDR service in tabular format.

In the Summary of Incoming Messages handled by SDR section, you can click on the number of messages corresponding to a particular verdict to view the related messages in Message Tracking.

## Outgoing Destinations

The Outgoing Destinations page provides information about the domains your company sends mail to. The page consists of two sections. The top half of the page consists of graphs depicting the top destinations by outgoing threat messages and top destinations by outgoing clean messages on the top half of the page. The bottom half of the page displays a chart showing all the columns sorted by total recipients (default setting).

You can select a time range on which to report, such as an hour, a week, or a custom range. As with all reports, you can export the data for the graphs or the details listing to CSV format via the **Export** link.

The Outgoing Destinations page can be used to answer the following types of questions:

- What domains is the email gateway sending mail to?
- How much mail is sent to each domain?
- How much of that mail is clean, spam-positive, virus-positive, malware or stopped by a content filter?
- How many messages are delivered and how many messages are hard-bounced by the destination server?

## Outgoing Senders

The Outgoing Senders page provides information about the quantity and type of mail being sent from IP addresses and domains in your network. You can view the results by domain or IP address when you view this page. You might want to view the results by domain if you want to see what volume of mail is being sent by each domain, or you might want to view the results by IP address if you want to see which IP addresses are sending the most virus messages or triggering content filters.

The page consists of two sections. On the left side of the page is a graph depicting the top senders by total threat messages. Total threat messages include messages that are spam-positive, virus-positive, malware or triggered a content filter. On the right side of the page is a graph displaying top senders by clean messages on the top half of the page. The bottom half of the page displays a chart showing all the columns sorted by total messages (default setting).



---

**Note** This page does not display information about message delivery. Delivery information, such as how many messages from a particular domain were bounced can be tracked using the Delivery Status page.

---

You can select a time range on which to report, such as an hour, a week, or a custom range. As with all reports, you can export the data for the graphs or the details listing to CSV format via the **Export** link.

The Outgoing Senders page can be used to answer the following types of questions:

- Which IP addresses are sending the most virus-positive, spam-positive or malware email?
- Which IP addresses trigger content filters the most frequently?
- Which domains are sending the most mail?

## Geo Distribution Page

You can use the Geo Distribution report page to view:

- Top incoming mail connections based on country of origin in graphical format.
- Total incoming mail connections based on country of origin in tabular format.

You can click on the number of incoming mail connections of a specific geolocation to view the related messages in Message Tracking.

The "Total Messages" column only displays those messages that are accepted at the SMTP connection level.



---

**Note** During report generation:

- If one or more incoming mail connections are detected as private IP address, the incoming mail connections are categorized as "Private IP Addresses" in the report.
  - If one or more incoming mail connections are detected as not a valid IP Reputation score, the incoming mail connections are categorized as "No Country Info" in the report.
- 

## Delivery Status Page

If you suspect delivery problems to a specific recipient domain or if you want to gather information on a Virtual Gateway address, the Monitor > Delivery Status Page provides monitoring information about email operations relating to a specific recipient domain.

The **Delivery Status Page** displays the same information as the tophosts command within the CLI. (For more information, see "Determining the Make-up of the Email Queue" in [Managing and Monitoring Using the CLI, on page 1095](#))

This page displays a list of the top 20, 50, or 100 recipient domains for messages delivered by the system within the last three hours. You can sort by latest host status, active recipients (the default), connections out, delivered recipients, soft bounced events, and hard bounced recipients by clicking the links in the column heading for each statistic.

- To search for a specific domain, type the name of the domain in the Domain Name: field and click **Search**.

- To drill down on a domain shown, click the domain name link.

The results are shown in an Delivery Status Details Page.



---

**Note** Any activity for a recipient domain results in that domain being “active” and thus present in the overview page. For example, if mail remains in the outbound queue due to delivery problems, that recipient domain continues to be listed in the outgoing mail overview.

---

#### Related Topics

- [Retrying Delivery, on page 845](#)
- [Delivery Status Details Page, on page 845](#)

## Retrying Delivery

Messages that are scheduled for later delivery can be immediately retried by clicking **Retry All Delivery**. Retry All Delivery allows you to reschedule messages in the queue for immediate delivery. All domains that are marked as “down” and any scheduled or soft bounced messages are queued for immediate delivery.

To retry delivery to a specific destination domain, click the domain name link. On the Delivery Status Details page, click **Retry Delivery**.

You can also use the `delivernow` command in the CLI to reschedule messages for immediate delivery. For more information, see [Scheduling Email for Immediate Delivery, on page 1116](#).

## Delivery Status Details Page

Use the **Delivery Status Details Page** to look up statistics on a specific recipient domain. This page displays the same information as the `hoststatus` command within the CLI: Mail Status, Counters and Gauges. (For more information, see [Managing and Monitoring Using the CLI, on page 1095](#)) To search for a specific domain, type the name of the domain in the Domain Name: field and click **Search**. Virtual Gateway address information appears if you are using the `altsrchost` feature.

## Internal Users Page

The Internal Users page provides information about the mail sent and received by your internal users, *per email address* (a single user may have multiple email addresses listed — the email addresses are not combined in the report).

The page consists of two sections:

- Graphs depicting the top users by clean incoming and outgoing messages and top users receiving graymail.
- User mail flow details

You can select a time range on which to report (hour, day, week, or month). As with all reports, you can export the data for the graphs or the details listing to CSV format via the **Export** link. You can also display hidden table columns or hide default columns by clicking the Columns link below the table.

The User Mail Flow Details listing breaks down the mail received and sent by each email address into clean, spam (incoming only), virus, malware, content filter matches, and graymail (incoming only). You can sort the listing by clicking on the column headers.

Using the Internal Users report, you can answer these kinds of questions:

- Who is sending the most external email?
- Who receives the most clean email?
- Who receives the most number of graymail messages?
- Who receives the most spam?
- Who is triggering which content filters?
- Whose email is getting caught by content filters?

Inbound Internal Users are the users for which you received email, based on the Rcpt To: address. Outbound Internal Users are based on the Mail From: address and are useful when tracking the types of email that senders on your internal network are sending.

Note that some outbound mail (like bounces) have a null sender. They are counted under outbound and “unknown.”

Click on an internal user to view the Internal User detail page for that user.

Click the Columns link below the table to show columns that are hidden by default, such as the Incoming Detected by Advanced Malware Protection column or Outgoing Detected by Advanced Malware Protection column.

### Related Topics

- [Internal User Details, on page 846](#)
- [Searching for a Specific Internal User, on page 846](#)

## Internal User Details

The Internal User detail page shows detailed information about the specified user, including a breakdown of incoming and outgoing messages showing the number of messages in each category (spam detected, virus detected, detected by Advanced Malware Protection, stopped by content filter, graymail detected, and clean). Optionally, for incoming messages, you can click the Columns link below the table to show the Incoming Detected by Advanced Malware Protection column. This value reflects the number messages that contained attachments that were determined by file reputation filtering to be malicious. It does not include verdict updates or files found to be malicious by file analysis. Incoming and outgoing content filter and DLP policy matches are also shown.

Click on a content filter name to view detailed information for that filter in the corresponding content filter information page (see [Content Filters Page, on page 848](#)). You can use this method to get a list of users who also sent or received mail that matched that particular content filter.

## Searching for a Specific Internal User

You can search for a specific internal user (email address) via the search form at the bottom of the Internal Users page and the Internal User detail page. Choose whether to exactly match the search text or look for items starting with the entered text (for instance, starts with “ex” will match “example.com”).

## DLP Incidents Page

The DLP Incidents page shows information on the incidents of data loss prevention (DLP) policy violations occurring in outgoing mail. The email gateway uses the DLP email policies enabled in the Outgoing Mail Policies table to detect sensitive data sent by your users. Every occurrence of an outgoing message violating a DLP policy is reported as an incident.

Using the DLP Incidents report, you can answer these kinds of questions:

- What type of sensitive data is being sent by your users?
- How severe are these DLP incidents?
- How many of these messages are being delivered?
- How many of these messages are being dropped?
- Who is sending these messages?

The DLP Incidents page is comprised of two main sections:

- the DLP incident trend graphs summarizing the top DLP incidents by severity (Low, Medium, High, Critical) and policy matches, and
- the DLP Incidents Details listing.

You can select a time range on which to report, such as an hour, a week, or a custom range. As with all reports, you can export the data for the graphs or the details listing to CSV format via the **Export** link or PDF format by clicking the **Printable (PDF)** link. For information about generating PDFs in languages other than English, see the [Notes on Reports, on page 906](#).

Click on the name of a DLP policy to view detailed information on the DLP incidents detected by the policy. You can use this method to get a list of users who sent mail that contained sensitive data detected by the policy.

#### Related Topics

- [DLP Incidents Details, on page 847](#)
- [DLP Policy Detail Page, on page 847](#)

## DLP Incidents Details

The DLP policies currently enabled in the email gateway's outgoing mail policies are listed in the DLP Incidents Details table at the bottom of the DLP Incidents page. Click on the name of a DLP policy to view more detailed information.

The DLP Incidents Details table shows the total number of DLP incidents per policy, with a breakdown by severity level. The severity level also includes the number of bounced messages and the number of messages delivered in the clear, delivered encrypted, or dropped. Click on the column headings to sort the data.

## DLP Policy Detail Page

If you clicked the name of a DLP policy in the DLP Incidents Details table, the resulting DLP Policy Detail page displays the DLP incidents data for the policy. The page displays graphs on the DLP incidents based on severity.

The page also includes an Incidents by Sender listing at the bottom of the page that lists each internal user who has sent a message that violated the DLP policy. The listing also shows the total number of DLP incidents for this policy per user, with a breakdown by severity level, and whether any of the messages were delivered in the clear, delivered encrypted, or dropped. You can use the Incidents by Sender listing to find out which users may be sending your organization's sensitive data to people outside your network.

Clicking on the sender name opens up the Internal Users page. See [Internal Users Page, on page 845](#) for more information.

## Content Filters Page

The Content Filters page shows information about the top incoming and outgoing content filter matches (which content filter had the most matching messages) in two forms: a bar chart and a listing. Using the Content Filters page, you can review your corporate policies on a per-content filter or per-user basis and answer questions like:

- Which content filter is being triggered the most by incoming or outgoing mail?
- Who are the top users sending or receiving mail that is triggering a particular content filter?

You can click the name of the content filter in the listing to view more information about that filter on the Content Filter detail page.

### Related Topics

- [Content Filter Details, on page 848](#)

## Content Filter Details

The Content Filter detail page displays matches for that filter over time, as well as matches by internal user.

In the Matches by Internal User section, you can click the name of a user to view that internal user's (email address) Internal User details page (see [Internal User Details, on page 846](#)).

## DMARC Verification Page

The DMARC Verification page shows the top domains that failed DMARC verification and the details of actions AsyncOS performed on the messages that failed DMARC verification. You can use this report to fine-tune your DMARC settings and answer these kinds of questions:

- Which are the domains that sent maximum number of messages that are not DMARC compliant?
- For each domain, what are the actions AsyncOS performed on the messages that failed DMARC verification?

The DMARC Verification page contains:

- A bar chart showing top domains by DMARC verification failures.
- Tabular representation of the following, for each domain:
  - Number of messages that were rejected, quarantined, or accepted without taking any action. Click on the number to view a list of messages under the selected category.
  - Number messages that passed DMARC verification.
  - Total number of DMARC verification attempts.

You can select a time range on which to report, such as an hour, a week, or a custom range. As with all reports, you can export the data for the graphs or the details listing to CSV format via the **Export** link or PDF format by clicking the **Printable (PDF)** link.

## Macro Detection Page

You can use the Macro Detection report page to view:

- Top Incoming Macro-Enabled Attachments by File Type in graphical and tabular format.



- Top Outgoing Macro-Enabled Attachments by File Type in graphical and tabular format.

You can click on the number of macro-enabled attachments to view the related messages in Message Tracking.



---

**Note** During report generation:

- If one or more macros are detected within an archive file, the Archive Files file type is incremented by one. The number of macro-enabled attachments within an archive file are not counted.
  - If one or more macros are detected within an embedded file, the parent file type is incremented by one. The number of macro-enabled attachments within an embedded file are not counted.
- 

## External Threat Feeds Page

You can use the External Threat Feeds report page to view:

- Top ETF sources used to detect threats in messages in graphical format
- Summary of ETF sources used to detect threats in messages in tabular format.
- Top IOCs that matched threats detected in messages in graphical format.
- Top ETF sources used to filter malicious incoming mail connections in graphical format.
- Summary of ETF sources used to filter malicious incoming mail connections in tabular format.

In the ‘Summary of External Threat Feed Sources’ section:

- You can click on the number of messages for a particular ETF source to view the related messages in Message Tracking.
- You can click on a particular threat feed source to view the distribution of the ETF source based on the IOCs.

In the ‘Summary of Indicator of Compromise (IOC) Matches’ section:

- You can click on the number of IOCs for a particular ETF source to view the related messages in Message Tracking.
- You can click on a particular IOC to view the distribution of the IOC based on the ETF sources.

## Outbreak Filters Page

The Outbreak Filters page shows the current status and configuration of Outbreak Filters on your email gateway as well as information about recent outbreaks and messages quarantined due to Outbreak Filters. You can use this page to monitor your defense against targeted virus, scam, and phishing attacks.

The Threats By Type section shows the different types of threat messages received by the email gateway.

The Threat Summary section shows a breakdown of the threat messages by Malware, Phish, Scam, and Virus. Click on the number to view a list of all the messages that are included in that number using Message Tracking.

The Past Year Outbreak Summary lists global as well as local outbreaks over the past year, allowing you to compare local network trends to global trends. The listing of global outbreaks is a superset of all outbreaks, both viral and non-viral, whereas local outbreaks are limited to virus outbreaks that have affected your email gateway. Local outbreak data does not include non-viral threats. Global outbreak data represents all outbreaks detected by the Threat Operations Center which exceeded the currently configured threshold for the outbreak quarantine. Local outbreak data represents all virus outbreaks detected on this appliance which exceeded the currently configured threshold for the outbreak quarantine. The Total Local Protection Time is always based on the difference between when each virus outbreak was detected by the Threat Operations Center and the release of an anti-virus signature by a major vendor. Note that not every global outbreak affects your email gateway. A value of "--" indicates either a protection time does not exist, or the signature times were not available from the anti-virus vendors (some vendors may not report signature times). This does not indicate a protection time of zero, rather it means that the information required to calculate the protection time is not available.

The Quarantined Messages section summarizes Outbreak Filters quarantining, and is a useful gauge of how many potential threat messages Outbreak Filters are catching. Quarantined messages are counted at time of release. Typically, messages will be quarantined before anti-virus and anti-spam rules are available. When released, they will be scanned by the anti-virus and anti-spam software and determined to be positive or clean. Because of the dynamic nature of Outbreak tracking, the rule under which a message is quarantined (and even the associated outbreak) may change while the message is in the quarantine. Counting the messages at the time of release (rather than the time of entry into the quarantine) avoids the confusion of having counts that increase and decrease.

The Threat Details listing displays information about specific outbreaks, including the threat category (virus, scam, or phishing), threat name, a description of the threat, and the number of messages identified. For virus outbreaks, the Past Year Virus Outbreaks include the Outbreak name and ID, time and date a virus outbreak was first seen globally, the protection time provided by Outbreak filters, and the number of quarantined messages. You can select either global or local outbreaks as well as the number of messages to display via the menu on the left. You can sort the listing by clicking on the column headers. Click on the number to view a list of all the messages that are included in that number using Message Tracking.

The First Seen Globally time is determined by the Threat Operations Center, based on data from SenderBase, the world's largest email and web traffic monitoring network. The Protection Time is based on the difference between when each threat was detected by the Threat Operations Center and the release of an anti-virus signature by a major vendor.

A value of "--" indicates either a protection time does not exist, or the signature times were not available from the anti-virus vendors (some vendors may not report signature times). This does not indicate a protection time of zero. Rather, it means that the information required to calculate the protection time is not available.

Hit Messages from Incoming Messages section shows the percentage and number of viral attachment, other threats (non-viral), and clean incoming messages.

Hit Messages by Threat Level section shows the percentage and number of incoming threat messages (viral and non-viral) based on threat levels (Level 1 through 5).

Messages resided in Outbreak Quarantine section shows the number of threat messages resided in the Outbreak Quarantine based on the duration.

Top URL's Rewritten section shows the list of top 10 URLs that were rewritten based on the number of occurrences. Use the Items Displayed drop-down to view more rewritten URLs. Click on the number to view a list of all the messages that contain the selected rewritten URL on the Message Tracking page.

Using the Outbreak Filters page, you can answer questions like:

- How many messages are being quarantined and what type of threats were they?

- How much lead time has the Outbreak Filter feature been providing for virus outbreaks?
- How do my local virus outbreaks compare to the global outbreaks?

## Virus Types Page

The Virus Types page provides an overview of the viruses entering and being sent from your network. The Virus Types page displays the viruses that have been detected by the virus scanning engines running on your email gateway. You might want to use this report to take a specific action against a particular virus. For example, if you see that you are receiving a high volume of a viruses known to be embedded in PDF files, you might want to create a filter action to quarantine messages with PDF attachments.

If you run multiple virus scanning engines, the Virus Types page includes results from all enabled virus scanning engines. The name of the virus displayed on the page is a name determined by the virus scanning engines. If more than one scanning engine detects a virus, it is possible to have more than one entry for the same virus.

The Virus Types page gives you an overview of the viruses entering or being sent from or to your network. The Top Incoming Virus Detected section shows a chart view of the viruses that have been sent to your network in descending order. The Top Outgoing Virus Detected section shows a chart view of the viruses that have been sent from your network in descending order.



---

**Note** To see which hosts sent virus-infected messages to your network, you can go to the Incoming Mail page, specify the same reporting period and sort by virus-positive. Similarly, to see which IP addresses have sent virus-positive email within your network, you can view the Outgoing Senders page and sort by virus-positive messages.

---

The VirusTypes Details listing displays information about specific viruses, including the infected incoming and outgoing messages, and the total infected messages. The details listing for infected incoming messages displays the name of the virus and the number of incoming messages infected with this virus. Similarly, the outgoing messages displays the name of the virus and the number of outgoing messages infected with the virus. You can sort the Virus Type details by Incoming Messages, Outgoing Messages, or Total Infected Messages.

## URL Filtering Page

- URL Filtering report modules are populated only if URL filtering is enabled.
- URL Filtering reports are available for incoming and outgoing messages.
- Only messages that are scanned by the URL filtering engine (either as part of anti-spam/outbreak filter scanning or through message/content filters) are included in these modules. However, not all of the results are necessarily specifically attributable to the URL Filtering feature.
- The Top URL Categories module includes all categories found in messages that have been scanned, whether or not they match a content or message filter.
- Each message can be associated with only one URL reputation level. For messages with multiple URLs, the statistics reflect the lowest reputation of any URL in the message.
- URLs in the global allowed list configured at Security Services > URL Filtering are not included in reports.

URLs in allowed lists used in individual filters are included in reports.

- Malicious URLs are URLs that Outbreak Filters have determined to have poor reputation. Neutral URLs are those that Outbreak Filters have determined to require click-time protection. Neutral URLs have therefore been rewritten to redirect them to the Cisco Web Security proxy.
- Results of URL category-based filters are reflected in content and message filter reports.
- Results of click-time URL evaluations by the Cisco Web Security proxy are not reflected in reports.

## Web Interaction Tracking Page

- Web Interaction Tracking report modules are populated only if the web interaction tracking feature is enabled.
- Web Interaction Tracking report modules are not updated in real-time and are refreshed every 30 minutes. Also, after clicking a rewritten URL, it may take up to two hours for the Web Interaction Tracking report to report this event.
- Web Interaction Tracking report is not updated in real-time. After clicking a cloud re-directed rewritten URL, it may take up to two hours for the Web Interaction Tracking report to report this event.
- Web Interaction Tracking reports are available for incoming and outgoing messages.
- Only cloud re-directed rewritten URLs (either by policy or Outbreak Filter) clicked by the end users are included in these modules.
- Web Interaction Tracking page includes the following reports:

**Top Rewritten Malicious URLs clicked by End Users.** Click on a URL to view a detailed report that contains the following information:

- A list of end users who clicked on the rewritten malicious URL.
- Date and time at which the URL was clicked.
- Whether the URL was rewritten by a policy or an outbreak filter.
- Action taken (allow, block, or unknown) when the rewritten URL was clicked. Note that, if a URL was rewritten by outbreak filter and the final verdict is unavailable, the status is shown as unknown.

### Top End Users who clicked on Rewritten Malicious URLs

**Web Interaction Tracking Details.** Includes the following information:

- A list of all the cloud re-directed rewritten URLs (malicious and unmalicious). Click on a URL to view a detailed report.
- Action taken (allow, block, or unknown) when a cloud re-directed rewritten URL was clicked.

For the data to show up, perform the following:

- Choose **Incoming Mail Policies > Outbreak Filters** to configure an outbreak filter and enable message modification and URL rewriting.
- Configure a content filter with the "**Redirect to Cisco Security Proxy**" action.

Note that, if the verdict of a URL (clean or malicious) was unknown at the time when the end user clicked it, the status is shown as unknown. This could be because the URL was under further scrutiny or the web server was down or not reachable at the time of the user click.

- The number of times end users clicked on a rewritten URL. Click on a number to view a list of all the messages that contain the clicked URL.
- While using Web Interaction Tracking reports, keep in mind the following limitations:

- If you have configured a content or message filter to deliver messages after rewriting malicious URLs and notify another user (for example, an administrator), the web interaction tracking data of the original recipient is incremented even if the notified user clicks on the rewritten URLs.
- If you are sending a copy of quarantined messages containing rewritten URLs to a user (for example, an administrator) using web interface, the web interaction tracking data of the original recipient is incremented even if the user (to whom the copy of the messages were sent) clicks on the rewritten URLs.
- At any point, if you plan to modify the time of your email gateway, make sure that the system time is synchronized with Coordinated Universal Time (UTC).

## Forged Email Matches Report

See [Monitoring Forged Email Detection Results](#), on page 637.

## File Reputation and File Analysis Reports

For the following reports, see [File Reputation and File Analysis Reporting and Tracking](#), on page 499:

- Advanced Malware Protection
- File Analysis
- AMP Verdict Updates

## Mailbox Auto Remediation Report

You can view the details of the mailbox remediation results using the Mailbox Auto Remediation report page (**Monitor > Mailbox Auto Remediation**). Use this report to view details such as:

- Remedial actions taken on messages
- The filenames associated with a SHA-256 hash
- A list of profile names defined for the recipients for whom the mailbox remediation was successful or unsuccessful
- Reason for the remediation failure
- No profile mapped to the domain

Click on a SHA-256 hash to view the related messages in Message Tracking.

For more information, see [Remediating Messages in Mailboxes](#), on page 573

## TLS Connections Page

The TLS Connections pages shows the overall usage of TLS connections for sent and received mail. The report also shows details for each domain sending mail using TLS connections.

The TLS Connections page can be used to determine the following information:

- Overall, what portion of incoming and outgoing connections use TLS?
- What partners do I have successful TLS connections with?
- What partners do I have unsuccessful TLS connections with?

- What partners do I have successful TLS connections with DANE support?
- What partners do I have unsuccessful TLS connections with DANE support?
- What partners have issue with their TLS certificates?
- What percent of overall mail with a partner uses TLS?
- What percent of outgoing TLS connections with DANE support are successful?
- What percent of outgoing connections with DANE support are unsuccessful?

The TLS Connections page is divided into a section for incoming connections and a section for outgoing connections. Each section includes a graph, summaries, and a table with details.

The graph displays a view of incoming or outgoing TLS-encrypted and non-encrypted connections over the time range you specify. The graph displays the total volume of messages, the volume of encrypted and unencrypted messages, the volume of successful and failed TLS encrypted messages and the volume of successful and failed DANE connections. The graphs distinguish between connections in which TLS was required and connections in which TLS was merely preferred.

The table displays details for domains sending or receiving encrypted messages. For each domain, you can view the number of required and preferred TLS connections that were successful and that failed, the total number of TLS connections attempted (whether successful or failed), the total number of unencrypted connections, and the total number of unencrypted connections, and the total number of DANE connections (depending on whether successful or failed). You can also view the percentage of all connections in which TLS was attempted, and the total number of encrypted messages sent successfully, regardless of whether TLS was preferred or required. You can show or hide columns by clicking the Columns link at the bottom of this table.

## Inbound SMTP Authentication Page

The Inbound SMTP Authentication page shows the use of client certificates and the SMTP AUTH command to authenticate SMTP sessions between the email gateway and users' mail clients. If the email gateway accepts the certificate or SMTP AUTH command, it will establish a TLS connection to the mail client, which the client will use to send a message. Since it is not possible for the email gateway to track these attempts on a per-user basis, the report shows details on SMTP authentication based on the domain name and domain IP address.

Use this report to determine the following information:

- Overall, how many incoming connection use SMTP authentication?
- How many connections use a client certificated?
- How many connections use SMTP AUTH?
- What domains are failing to connect when attempting to use SMTP authentication?
- How many connections are successfully using the fall-back when SMTP authentication fails?

The Inbound SMTP Authentication page includes a graph for received connections, a graph for mail recipients who attempted an SMTP authentication connection, and a table with details on the attempts to authenticate connections.

The Received Connections graph shows the incoming connections from mail clients that attempt to authentication their connections using SMTP authentication over the time range you specify. The graph displays the total number of connections the email gateway received, the number that did not attempt to authenticating using SMTP authentication, the number that failed and succeeded to authenticate the connection

using a client certificate, and the number that failed and succeeded to authenticate using the SMTP AUTH command.

The Received Recipients graph displays the number of recipients whose mail clients attempted to authenticate their connections to the email gateways to send messages using SMTP authentication. The graph also shows the number of recipients whose connections were authenticated and the number of recipients whose connections were not authenticated.

The SMTP Authentication details table displays details for the domains whose users attempt to authenticate their connections to the email gateway to send messages. For each domain, you can view the number of connection attempts using a client certificate that were successful or failed, the number of connection attempts using the SMTP AUTH command that were successful or failed, and the number that fell back to the SMTP AUTH after their client certificate connection attempt failed. You can use the links at the top of the page to display this information by domain name or domain IP address.

## Rate Limits Page

Rate Limiting by envelope sender allows you to limit the number of email message recipients per time interval from an individual sender, based on the mail-from address. The Rate Limits report shows you the senders who most egregiously exceed this limit.

Use this report to help you identify the following:

- Compromised user accounts that might be used to send spam in bulk.
- Out-of-control applications in your organization that use email for notifications, alerts, automated statements, etc.
- Sources of heavy email activity in your organization, for internal billing or resource-management purposes.
- Sources of large-volume inbound email traffic that might not otherwise be considered spam.

Note that other reports that include statistics for internal senders (such as Internal Users or Outgoing Senders) measure only the number of messages sent; they do not identify senders of a few messages to a large number of recipients.

The Top Offenders by Incident chart shows the envelope senders who most frequently attempted to send messages to more recipients than the configured limit. Each attempt is one incident. This chart aggregates incident counts from all listeners.

The Top Offenders by Rejected Recipients chart shows the envelope senders who sent messages to the largest number of recipients above the configured limit. This chart aggregates recipient counts from all listeners.

To configure rate limiting by envelope sender or modify the existing rate limit, see [Defining Rules for Incoming Messages Using a Mail Flow Policy, on page 103](#).

## System Capacity Page

The System Capacity page provides a detailed representation of the system load, including messages in the work queue, average time spent in the work queue, incoming and outgoing messages (volume, size, and number), overall CPU usage, CPU usage by function, and memory page swapping information.

The system capacity page can be used to determine the following information:

- Identify when an email gateway is exceeding recommended capacity and configuration optimization or additional email gateways are needed.
- Identify historical trends in system behavior which point to upcoming capacity issues.

- Identify which part of the system is using the most resources to assist with troubleshooting.

It is important to monitor your email gateway to ensure that your capacity is appropriate to your message volumes. Over time, volume will inevitably rise and appropriate monitoring will ensure that additional capacity or configuration changes can be applied proactively. The most effective way to monitor system capacity is to track overall volume, messages in the work queue and incidents of Resource Conservation Mode.

- **Volume:** It is important to have an understanding of the “normal” message volume and the “usual” spikes in your environment. Track this data over time to measure volume growth. You can use the Incoming Mail and Outgoing Mail pages to track volume over time. For more information, see [System Capacity-Incoming Mail, on page 857](#) and [System Capacity-Outgoing Mail, on page 857](#).
- **Work Queue:** The work queue is designed to work as a “shock absorber”-- absorbing and filtering spam attacks and processing unusual increases in ham messages. However, the work queue is also the best indicator of a system under stress, prolonged and frequent work queue backups may indicate a capacity problem. You can use the WorkQueue page to track the average time messages spend in the work queue and the activity in your work queue. For more information, see [System Capacity- Workqueue, on page 856](#).
- **Resource Conservation Mode:** When an email gateway becomes overloaded, it will enter “Resource Conservation Mode” (RCM) and send a CRITICAL system alert. This is designed to protect the device and allow it to process any backlog of messages. Your email gateway should enter RCM infrequently and only during a very large or unusual increase in mail volume. Frequent RCM alerts may be an indication that the system is becoming overloaded. See [System Capacity-System Load, on page 857](#).

### Related Topics

- [System Capacity- Workqueue, on page 856](#)
- [System Capacity- Incoming Mail, on page 857](#)
- [System Capacity-Outgoing Mail, on page 857](#)
- [System Capacity-System Load, on page 857](#)
- [Note about Memory Page Swapping, on page 858](#)
- [System Capacity- All, on page 858](#)

## System Capacity- Workqueue

The Workqueue page shows the average time a message spends in the work queue, excluding any time spent in the Spam quarantine or in a policy, virus, or outbreak quarantine. You can view time periods from an hour up to one month. This average can help in identifying both short term events delaying mail delivery and identify long term trends in the workload on the system.



---

**Note** If a message is released from the quarantine into the work queue, the “average time in work queue” metric ignores this time. This prevents double-counting and distorted statistics due to extended time spent in a quarantine.

---

The report also shows the volume of messages in the work queue over a specified time period, and it shows the maximum messages in the work queue over the same time period. The graphical representation of the maximum messages in the work queue also shows the work queue threshold level.

Occasional spikes in the Workqueue graphs are normal and expected. If the messages in the work queue remain higher than the configured threshold for a long duration, this may indicate a capacity issue. In this scenario, consider tuning the threshold level or review the system configuration.



For instructions to change the work queue threshold level, see [Setting Thresholds for System Health Parameters, on page 1045](#).



---

**Tip** When reviewing the work queue page, you may want to measure the frequency of work queue backups, and take note of work queue backups that exceed 10,000 messages.

---

## System Capacity- Incoming Mail

The incoming mail page shows incoming connections, the total number of incoming messages, the average message size, and the total incoming message size. You can limit the results to the time range that you specify. It is important to have an understanding of the trends of normal message volume and spikes in your environment. You can use the incoming mail page to help track volume growth over time and plan for system capacity. You might also want to compare the Incoming Mail data with the Sender Profile data to view the trends in volumes of emails that are being sent from specific domains to your network.



---

**Note** An increased number of incoming connections may not necessarily affect system load.

---

## System Capacity-Outgoing Mail

The outgoing mail page shows outgoing connections, the total number of outgoing messages, the average message size, and the total outgoing message size. You can limit the results to the time range that you specify. It is important to have an understanding of the trends of normal message volume and spikes in your environment. You can use the outgoing mail page to help track volume growth over time and plan for system capacity. You might also want to compare the Outgoing Mail data with the Outgoing Destinations data to view the trends in volumes of emails that are being sent from specific domains or IP addresses.

## System Capacity-System Load

The system load report shows the following:

- Overall CPU Usage
- Memory Page Swapping
- Resource Conservation Activity

### Overall CPU Usage

The email gateway is optimized to use idle CPU resources to improve message throughput. High CPU usage may not indicate a system capacity problem. If the high CPU usage is coupled with consistent, high-volume memory page swapping, you may have a capacity problem.



---

**Note** This graph also shows the threshold level for CPU usage. If you want to change the threshold level, use the **System Administration > System Health** page in web interface or **healthconfig** command in CLI. See [Setting Thresholds for System Health Parameters, on page 1045](#).

---

This page also shows a graph that displays the amount of CPU used by different functions, including mail processing, spam and virus engines, reporting, and quarantines. The CPU-by-function graph is a good indicator

of which areas of the product use the most resources on your system. If you need to optimize your email gateway, this graph can help you determine which functions may need to be tuned or disabled.

### Memory Page Swapping

The memory page swapping graph shows how frequently the system must page to disk. This graph also shows the threshold level for memory page swapping. If you want to change the threshold level, use the **System Administration > System Health** page in web interface or `healthconfig` command in CLI. See [Setting Thresholds for System Health Parameters, on page 1045](#).

### Resource Conservation Activity

The resource conservation activity graph shows the number of times the email gateway entered Resource Conservation Mode (RCM). For example, if the graph shows *n* times, it means that the email gateway has entered RCM *n* times and exited at least *n*-1 times.

Your email gateway should enter RCM infrequently and only during a very large or unusual increase in mail volume. If the Resource Conservation Activity graph shows that your email gateway is entering RCS frequently, it may be an indication that the system is becoming overloaded.

## Note about Memory Page Swapping

The system is designed to swap memory regularly, so some memory swapping is expected and is not an indication of problems with your email gateway. Unless the system *consistently* swaps memory in high volumes, memory swapping is normal and expected behavior, especially on C170 and C190 appliances. To improve performance, you may need to add email gateways to your network or tune your configuration to ensure maximum throughput.

## System Capacity- All

The All page consolidates all the previous system capacity reports onto a single page so you can view the relationship between the different reports. For example, you might view the message queue is high at the same time that excessive memory swapping takes place. This might be an indication that you have a capacity problem. You may want to save this page as PDF to preserve a snapshot of system performance for later reference (or to share with support staff). For information about generating PDFs in languages other than English, see the [Notes on Reports, on page 906](#).

## System Status Page

The **System Status** page provides a detailed representation of all real-time mail and DNS activity for the system. The information displayed is the same information that is available by using the status detail and `dnsstatus` commands in the CLI. For more information, see “Monitoring Detailed Email Status” for the status detail command and “Checking the DNS Status” for the `dnsstatus` command in [Managing and Monitoring Using the CLI, on page 1095](#)

The System Status page is comprised of four sections: System Status, Gauges, Rates, and Counters.

### Related Topics

- [System Status, on page 859](#)
- [Gauges, on page 859](#)
- [Rates, on page 859](#)

- [Counters, on page 860](#)

## System Status

The system status section shows Mail System Status and Version Information.

### Related Topics

- [Mail System Status, on page 859](#)
- [Version Information, on page 859](#)

## Mail System Status

The Mail System Status section includes:

- System Status (for more information about system status, see [Status, on page 834](#))
- The last time the status was reported.
- The uptime for the email gateway.
- The oldest message in the system, including messages that have not yet been queued for delivery.

## Version Information

The Version Information section includes:

- The email gateway model name.
- The version and build date of the AsyncOS operating system installed.
- The installation date of the AsyncOS operating system.
- The serial number of the system to which you are connected.

This information is useful if you are contacting Cisco Customer Support. (See [Working with Technical Support, on page 1275](#).)

## Gauges

The Gauges section shows queue and resource utilization.

- Mail Processing Queue
- Active Recipients in Queue
- Queue Space
- CPU Utilization

Mail Gateway Appliance refers to the percentage of the CPU that AsyncOS processes are consuming. CASE refers to several items, including the Anti-Spam scanning engine and Outbreak Filters processes.

- General Resource Utilization
- Logging Disk Utilization

## Rates

The Rates section shows rate handling for recipients.

- Mail Handling Rates
- Completion Rates

## Counters

You can reset the cumulative email monitoring counters for system statistics and view the last time the counters were reset. The reset affects system counters as well as per-domain counters. The reset does not affect the counters on messages in the delivery queue related to retry schedules.



---

**Note** Only user accounts that are in the administrator or operator group have access to reset the counters. User accounts you create in the guest group will not be able to reset the counters. For more information, see [Working with User Accounts, on page 973](#).

---

Click Reset Counters to reset the counters. This button offers the same functionality as the `resetcounters` command in the CLI. For more information, see [Resetting Email Monitoring Counters, on page 1110](#).

- Mail Handling Events
- Completion Events
- Domain Key Events
- DNS Status

## High Volume Mail Page



---

**Note** The High Volume Mail page shows data only from message filters that use Header Repeats rule.

---

The High Volume Mail page contains the following reports in the form of bar charts:

- **Top Subjects.** You can use this chart to understand the top subjects of messages that AsyncOS received.
- **Top Envelope Senders.** You can use this chart to understand the top envelope senders of messages that AsyncOS received.
- **Top Message Filters by Number of Matches.** You can use this chart to understand the top message filter (that uses Header Repeats rule) matches.

The High Volume Mail page also provides a tabular representation of the top message filters and the number of matches for the respective message filters. Click on the number to view a list of all the messages that are included in that number using Message Tracking.

You can select a time range on which to report, such as an hour, a week, or a custom range. As with all reports, you can export the data for the graphs or the details listing to CSV format via the **Export** link or PDF format by clicking the **Printable (PDF)** link.

## Message Filters Page

The Message Filters page shows information about the top message filter matches (which message filter had the most matching messages) in two forms: a bar chart and a tabular representation.

Using the bar chart, you can find the message filters that are being triggered the most by incoming and outgoing messages. The tabular representation shows the top message filters and the number of matches for the respective message filters. Click on the number to view a list of all the messages that are included in that number using Message Tracking.

You can select a time range on which to report, such as an hour, a week, or a custom range. As with all reports, you can export the data for the graphs or the details listing to CSV format via the **Export** link or PDF format by clicking the **Printable (PDF)** link.

## Safe Print Page

You can use the Safe Print report page to view:

- Number of safe-printed attachments based on the file type in graphical format.
- Summary of safe-printed attachments based on the file type in tabular format.

In the ‘Summary of Safe Print File Types’ section, click the total number of safe-printed attachments to view the message details in Message Tracking.

## Retrieving CSV Data

You can retrieve the data used to build the charts and graphs in the Email Security Monitor in CSV format. The CSV data can be accessed in two ways:

- **CSV reports delivered via email.** You can generate a CSV report that is delivered via email or archived. This delivery method is useful when you want separate reports for each table represented on an Reports page, or when you want to send CSV data to users who do not have access to internal networks.

The comma-separated values (CSV) Report Type is an ASCII text file which contains the tabular data of the scheduled report. Each CSV file may contain up to 100 rows. If a report contains more than one type of table, a separate CSV file will be created for each table. Multiple CSV files for a single report will be compressed into a single .zip file for the archived file storage option or will all be attached to separate e-mail messages for e-mail delivery.

- **CSV files retrieved via HTTP.** You can retrieve the data used to build the charts and graphs in the Email Security Monitor feature via HTTP. This delivery method is useful if you plan to perform further analysis on the data via other tools. You can automate the retrieval of this data, for example, by an automatic script that will download raw data, process, and then display the results in some other system.

### Related Topics

- [Retrieving CSV Data Via Automated Processes, on page 861](#)

## Retrieving CSV Data Via Automated Processes

The easiest way to get the HTTP query you will need is to configure one of the Email Security Monitor pages to display the type of data you want. You can then copy the **Export** link. This is the download URL. When automating data retrieval like this it is important to note which parameters in the download URL should be fixed and which should change (see below).

The download URL is encoded in such a way that it can be copied to an external script that can execute the same query (using proper HTTP authentication) and get a similar data set. The script can use Basic HTTP Authentication or cookie authentication. Keep the following in mind when retrieving CSV data via automated processes:

- Time range selection (past hour, day, week, etc) in relation to when the URL is used again. If you copy the URL to retrieve a CSV data set for “Past Day,” the next time you use that URL you will get a new

data set that covers the “Past Day” from the time you send the URL again. The date range selection is retained, and appears in the CSV query string (e.g. `date_range=current_day`).

- Filtering and grouping preferences for the data set. Filters are retained and appear in the query string. Note that filters in reports are rare — one example is the “Global / Local” outbreaks selector in the Outbreaks report.
- The CSV download returns all rows of data in the table for the selected time range.
- The CSV download returns the rows of data in the table ordered by timestamp and key. You can perform further sorting in a separate step such as via a spreadsheet application.
- The first row contains column headers that match the display names shown in the report. Note that timestamps (see [Timestamps, on page 862](#)) and keys (see [Keys, on page 863](#)) also appear.

### Related Topics

- [Sample URL, on page 862](#)
- [Adding Basic HTTP Authentication credentials, on page 862](#)
- [File Format, on page 862](#)
- [Timestamps, on page 862](#)
- [Keys, on page 863](#)
- [Streaming, on page 863](#)

### Sample URL

```
http://example.com/monitor/content_filters?format=csv&sort_col_ss_0_0_0=
MAIL_CONTENT_FILTER_INCOMING.RECIPIENTS_MATCHED&section=ss_0_0_0
&date_range=current_day&sort_order_ss_0_0_0=desc&report_def_id=mga_content_filters
```

### Adding Basic HTTP Authentication credentials

To specify basic HTTP Authentication credentials to the URL:

```
http://example.com/monitor/
```

becomes:

```
http://username:password@example.com/monitor/
```

### File Format

The downloaded file is in CSV format and has a .csv file extension. The file header has a default filename, which starts with the name of the report, then the section of the report.

### Timestamps

Exports that stream data show begin and end timestamps for each raw “interval” of time. Two begin and two end timestamps are provided — one in numeric format and the other in human-readable string format. The timestamps are in GMT time, which should make log aggregation easier if you have email gateways in multiple time zones.

Note that in some rare cases where the data has been merged with data from other sources, the export file does not include timestamps. For example, the Outbreak Details export merges report data with Threat Operations Center (TOC) data, making timestamps irrelevant because there are no intervals.

## Keys

Exports also include the report table key(s), even in cases where the keys are not visible in the report. In cases where a key is shown, the display name shown in the report is used as the column header. Otherwise, a column header such as “key0,” “key1,” etc. is shown.

## Streaming

Most exports stream their data back to the client because the amount of data is potentially very large. However, some exports return the entire result set rather than streaming data. This is typically the case when report data is aggregated with non-report data (e.g. Outbreaks Detail.)

# Email Security Monitor Pages on the New Web Interface

To access the new web interface, click the **Secure Email Gateway is getting a new look. Try it!!** link on the legacy web interface. For more information, see [Accessing the Web-Based Graphical User Interface \(GUI\), on page 26](#).

You can view the reports for the email gateway using the **Reports** drop-down as shown in the following figure:



**Note** The Mail Flow Summary report page is the landing page (the page displayed after login).

**Figure 70: Reports Drop-down**

| Reports / Mail Flow Summary: Incoming |                          | Data in time range: 100% COMPLETE 22 Jul 2019 14:00 to 23 Jul 2019 14:53 (GMT +05:30) |                   |
|---------------------------------------|--------------------------|---|-------------------|
| Mail Flow Summary                     |                          | Time Range  | Day               |
| My Reports                            | Email Threat Reports     | Connection and Flow Reports   | User Reports      |
| Mail Flow Summary                     | DMARC Verification       | Mail Flow Details   | User Mail Summary |
| System Capacity                       | Outbreak Filtering       | Sender Groups   | DLP Incidents     |
|                                       | URL Filtering            | Outgoing Destinations   | Web Interaction   |
| File and Malware Reports              | Forged Email Detection   | TLS Encryption  | Filter Reports    |
| Advanced Malware Protection           | Sender Domain Reputation | Inbound SMTP Authentication   | Message Filters   |
| Virus Filtering                       | External Threat Feeds    | Rate Limits   | High Volume Mail  |
| Macro Detection                       |                          | Connections by Country  | Content Filters   |

You use these pages in the GUI to monitor domains that are connecting to the email gateway listeners. You can monitor, sort, analyze, and classify the “mail flow” of your email gateway and differentiate between high-volume senders of legitimate mail and potential “spammers” (senders of high-volume, unsolicited commercial email) or virus senders. These pages can also help you troubleshoot inbound connections to the system (including important information such as IP Reputation score and most recent sender group match for domains).

These pages help you classify mail relative to the email gateway, and also relative to the services that exist beyond the scope of the gateway, such as the IP Reputation Service, the Anti-Spam scanning service, the Anti-Virus scanning security services, content filters, and Outbreak Filters.

You can export graphs and other data to CSV (comma separated values) format via the **Export** link.

The exported CSV data will display all message tracking and reporting data in GMT regardless of what is set on the email gateway. The purpose of the GMT time conversion is to allow data to be used independently from the email gateway or when referencing data from email gateways in multiple time zones.



---

**Note** If you export localized CSV data, the headings may not render properly in some browsers. This occurs because some browsers may not use the correct character set for the localized text. To work around this problem, you can save the file to disk, and open the file using File > Open. When you open the file, select the character set to display the localized text.

---

For more information about automating the export of report data, see [Retrieving CSV Data, on page 861](#)).

### List of Email Security Monitor Pages

- [My Favorite Reports Page, on page 866](#)
- [Mail Flow Summary Page, on page 868](#)
- [System Capacity Page, on page 855](#)
- [Advanced Malware Protection Page, on page 877](#)
- [Virus Filtering Page, on page 881](#)
- [Macro Detection Page, on page 882](#)
- [DMARC Verification Page, on page 882](#)
- [Outbreak Filtering Page, on page 883](#)
- [URL Filtering Page, on page 883](#)
- [Forged Email Detection Page, on page 885](#)
- [Sender Domain Reputation Page, on page 885](#)
- [External Threat Feeds Page, on page 886](#)
- [Mail Flow Details Page, on page 886](#)
- [Sender Groups Report, on page 894](#)
- [Outgoing Destinations, on page 894](#)
- [TLS Encryption Page, on page 894](#)
- [Inbound SMTP Authentication Page, on page 895](#)
- [Rate Limits Page, on page 896](#)
- [Connections by Country Page, on page 896](#)
- [User Mail Summary Page, on page 897](#)
- [DLP Incident Summary Page, on page 898](#)
- [Web Interaction Page, on page 899](#)
- [Message Filters Page, on page 902](#)
- [High Volume Mail Page, on page 902](#)
- [Content Filters Page, on page 903](#)



- [Advanced Phishing Protection Report Page, on page 903](#)
- [Mail Policy Details Report Page, on page 904](#)

## Searching and the Interactive Email Report Pages

Many of the interactive email reporting pages include a ‘**Search For:**’ drop-down menu at the bottom of the page.

From the drop-down menu, you can search for several types of criteria, including the following:

- IP address
- Domain
- Network owner
- Internal user
- Destination domain
- Internal sender domain
- Internal sender IP address
- Incoming TLS domain
- Outgoing TLS domain
- SHA-256

For most searches, choose whether to exactly match the search text or look for items starting with the entered text (for example, starts with “ex” will match “example.com”).

For IPv4 searches, the entered text is always interpreted as the beginning of up to four IP octets in dotted decimal format. For example, ‘17.\*’ will search in the range 17.0.0.0 through 17.255.255.255, so it will match 17.0.0.1 but not 172.0.0.1. For an exact match search, enter all four octets. IP address searches also support Classless Inter-Domain Routing (CIDR) format (17.16.0.0/12).

For IPv6 searches, you can enter addresses using the formats in the following examples:

- 2001:db8:2004:4202::0-2001:db8:2004:4202::ff
- 2001:db8:2004:4202::
- 2001:db8:2004:4202::23
- 2001:db8:2004:4202::/64

## Viewing Details of Messages Included in Reports

This functionality works only if reporting and tracking are both local (not centralized on a Cisco Secure Email and Web Manager.)

### Procedure

---

**Step 1** Click any blue number in a table on a report page.

(Not all tables have these links.)

The messages included in that number are displayed in Message Tracking.

**Step 2** Scroll down to see the list.

### What to do next

### Related Topics

- [Working with Message Tracking Search Results](#) , on page 917

## Time Range for Reports

The Email Security Monitor feature constantly records data about the mail flowing into your gateway. The data are updated every 60 seconds, but the display shown is delayed by 120 seconds behind the current system time. You can specify the time range to include in the results shown. Because the data is monitored in real time, information is periodically updated and summarized in the database.

Choose from the time range options in the following table.

**Table 86: Time Ranges Available in the Email Security Monitor Feature**

| This time range selected in the GUI | ...is defined as:  |
|-------------------------------------|--|
| Hour                                | the last 60 minutes + up to 5 minutes  |
| Day                                 | the last 24 hours + the last 60 minutes  |
| Week                                | the last 7 days + the elapsed hours of the current day                                   |
| 30 days                             | the last 30 days + the elapsed hours of the current day                                  |
| 90 days                             | the last 90 days + the elapsed hours of the current day                                  |
| Yesterday                           | 00:00 to 23:59 (midnight to 11:59 PM)  |
| Previous Calendar Month             | 00:00 of the first day of the month to 23:59 of the last day of the month                |
| Custom Range                        | the range enclosed by the start date and hour and the end date and hour that you specify |

## My Favorite Reports Page

You can create a custom report page by assembling charts (graphs) and tables from all your existing email security reports, on the My Reports page.

| To  | Do This  |
|---|--|
| Add modules to My Favorite Reports page           | See: <ul style="list-style-type: none"> <li>• <a href="#">Modules That Cannot Be Added to the My Reports Page, on page 867</a></li> <li>• <a href="#">Adding Reports on the My Favorite Reports Page, on page 868</a></li> </ul>   |
| View My Favorite Reports page                     | <ol style="list-style-type: none"> <li>1. Select <b>My Favorite Reports</b> from the Reports drop-down.</li> <li>2. Select the time range to view. The time range selected applies to all reports, including all modules on the My Favorite Reports page.</li> </ol> <p>Newly-added modules appear at the top of the custom report.</p> <p><b>Note</b> The report modules that you add on the My Favorite Reports page of the new web interface differs from the report modules added on the legacy web interface. It can also differ based on the User roles that you assign.</p> |
| Rearrange modules on the My Favorite Reports page | On the My Favorite Reports page, drag and drop the modules into the desired location.  |
| Delete modules from the My Favorite Reports page  | <p>You can delete the report modules from the My Favorite Reports page in any one of the following ways:</p> <ul style="list-style-type: none"> <li>• Click the  in the top right corner of the required report module.</li> <li>• Go to the <b>My Favorite Reports</b> page and select <b>Manage Favorites</b> to remove the required report module.</li> </ul>  |

## Modules That Cannot Be Added to the My Reports Page

- All modules on the System Status page.
- All modules on the Reporting Data Availability page.
- All modules on the Message Tracking Data Availability page.
- The following per-domain modules from the Sender Profile detail report page: Current Information from SenderBase, Sender Group Information, and Network Information.
- The Past Year Virus Outbreak Summary chart and Past Year Virus Outbreaks table on the Outbreak Filters report page.

## Adding Reports on the My Favorite Reports Page

### Before you begin

- Ensure that the modules that you want to add can be added. See [Modules That Cannot Be Added to the My Reports Page, on page 867](#).
- Click  on the top right corner of a module to delete any default modules that you do not need.

### Procedure

---

**Step 1** You can add a report module on the My Favorite Reports page in any one of the following ways:

**Note** Some modules are available only using one of these methods. If you cannot add a module using one method, try another method.

- Go to the report page under the Reports drop-down and click  on the top of the report module.
- From the Reports drop-down, select **My Reports** and click **Manage Favorites**.

The report modules are listed as per the tables and charts on email report pages. Select the required report modules and click **Add** to add to the My Favorite Reports page. If you do not want any reports to be displayed on the My Favorite Report page, select the report module and click **Remove**.

You can add each module only once; if you have already added a particular module to your report, the option to add it will not be available.

**Note** You can add a maximum of 10 report modules on the My Favorite Reports page.

**Step 2** If you add a report module that you have customized (for example, by adding, deleting, or reordering columns, or by displaying non-default data in the chart), customize the modules on the My Favorite Reports page.

Modules are added with default settings. Time range of the original module is not maintained.

**Step 3** If you add a chart that includes a separate legend (for example, a graph from the Mail Flow Summary page), add the legend separately. If necessary, drag and drop it into position beside the data it describes.

---

## Mail Flow Summary Page

The Mail Flow Summary report page provides a synopsis of the email message activity from your email gateway. The Mail Flow Summary report page includes graphs and summary tables for the incoming and outgoing messages.

The Mail Flow Summary: Incoming report page shows the incoming mail graphs for the total number of messages that are processed and blocked by the email gateway, as well as the summary of the incoming mails.

You can use the mail trend graphs on this page to monitor the flow of all the incoming mails that are processed and blocked by your email gateways, based on the selected time range. For more information, see [Time Range for Reports, on page 866](#).

To search for specific information within your data, see [Searching and the Interactive Email Report Pages](#), on page 865

The following mail trend graphs provide a visual representation of the incoming mail flow:

- Threat Detection Summary
- Content Summary

You can view the mail trend of the incoming messages based on the required counters for the respective categories. For more information, see [Using Counters to Filter Data on the Trend Graphs](#), on page 874.

The Mail Flow Summary: Outgoing report page shows the outgoing mail graphs for the total number of messages that are processed and delivered by the email gateway, as well as the summary of the outgoing mail.

You can use the mail trend graphs on this page to monitor the flow of all the outgoing mails that are processed and delivered by your email gateways, based on the selected time range. For more information, see [Time Range for Reports](#), on page 866.

The following mail trend graphs provide a visual representation of the mail flow of the Outgoing Mails.

You can view the mail trend of the outgoing messages based on the required counters of the processed messages. For more information, see [Using Counters to Filter Data on the Trend Graphs](#), on page 874.

The following list explains the various sections on the Mail Flow Summary report page:

**Table 87: Details on the Mail Flow Summary Page**

| Section                            | Description  |
|------------------------------------|--|
| <b>Mail Flow Summary: Incoming</b> |  |
| Number of Messages                 | The Number of Messages graph provides a visual representation of the total number of messages processed, including the messages that are processed as threat messages. |
| Threat Messages                    | The Threat Messages graph provides a visual representation of the total number of messages that are blocked by the email gateway.                                      |

| Section                            | Description   |
|------------------------------------|---|
| Threat Detection Summary           | <p>The Threat Detection Summary mail trend graph provides a visual representation based on the following categories:</p> <ul style="list-style-type: none"> <li>• <b>Connection and IP Reputation Filtering:</b> Messages that are categorized as threat by the IP Reputation Filtering and Invalid Recipients.</li> <li>• <b>Spam Detection:</b> Messages that are categorized as threat by the Anti-spam scanning engine.</li> <li>• <b>Email Spoofing:</b> Messages which are categorized as threat due to DMARC Verification failure.</li> <li>• <b>Outbreak Threat Summary:</b> Messages which are categorized as phishing, scam, virus or malware, by the Outbreak Filtering engine.</li> <li>• <b>Attachment and Malware Detection:</b> Messages that are categorized as threat by the Anti-virus and AMP engines.</li> <li>• <b>All Categories:</b> All the messages that are categorized as threat.</li> </ul> |
| Content Summary                    | <p>The Content Summary mail trend graph provides a visual representation based on the following categories:</p> <ul style="list-style-type: none"> <li>• <b>Graymail:</b> Messages that are categorized as marketing, bulk or social networking.</li> <li>• <b>Content Filters:</b> Messages that are categorized by the content filters.</li> <li>• <b>All Categories:</b> All the messages that are categorized by graymail engines and content filters.</li> </ul>   |
| <b>Mail Flow Summary: Outgoing</b> |   |
| Number of Messages                 | The Number of Messages graph provides a visual representation of the total number of messages processed, including the messages that are processed as clean.  |
| Message Delivery                   | The Message Delivery graph provides a visual representation of the total number of messages that are delivered, including hard bounces.   |
| Outgoing Mails                     | <p>The Outgoing Mails trend graph provides a visual representation based on the following categories:</p> <ul style="list-style-type: none"> <li>• Spam Detected</li> <li>• Virus Detected</li> <li>• Detected by AMP</li> <li>• Stopped by Content Filters</li> <li>• Stopped by DLP</li> </ul>  |

### Related Topics

- [How Email Messages Are Categorized by the Email Gateways, on page 871](#)
- [Incoming and Outgoing Summary and Graph, on page 835](#)
- [Categorizing Email Messages on the Mail Flow Summary Page, on page 872](#)
- [Using Counters to Filter Data on the Trend Graphs, on page 874](#)

## How Email Messages Are Categorized by the Email Gateways

As messages proceed through the email pipeline, they can apply to multiple categories. For example, a message can be marked as spam or virus positive; it can also match a content filter. The precedence of the various filters and scanning activities greatly impacts the results of message processing.

In the example above, the various verdicts follow these rules of precedence:

- Spam positive
- Virus positive
- Matching a content filter

Following these rules, if a message is marked as spam positive, and your anti-spam settings are set to drop spam positive messages, the message is dropped and the spam counter is incremented.

Further, if your anti-spam settings are set to let the spam positive message continue on in the email pipeline, and a subsequent content filter drops, bounces, or quarantines the message, the spam count is still incremented. The content filter count is only incremented if the message is not spam or virus positive.

Alternately, if the message were quarantined by Outbreak Filters, it would not be counted until it was released from the quarantine and again processed through the work queue.

For complete information about message processing precedence, see the chapter about the email pipeline in the online help or user guide for your email gateway.

## Incoming and Outgoing Summary and Graph

The Incoming and Outgoing summary sections provide access to real-time activity of all mail activity on your system and is comprised of the Incoming and Outgoing Mail Graphs and Mail Summaries. You can select the time frame on which to report via the Time Range menu. The time range you select is used throughout all of the Email Security Monitor pages. The explanations of each type or category of message are below (see [Categorizing Email, on page 836](#)).

While the mail trend graph displays a visual representation of the mail flow, the summary table provides a numeric breakdown of the same information. The summary table includes the percentage and actual number of each type of message, including the total number of attempted, threat, and clean messages.

The outgoing graph and summary show similar information for outbound mail.

### Related Topics

- [Notes on Counting Messages in Email Security Monitor, on page 836](#)

## Notes on Counting Messages in Email Security Monitor

The method Email Security Monitor uses to count incoming mail depends on the number of recipients per message. For example, an incoming message from example.com sent to three recipients would count as three messages coming from that sender.

Because messages blocked by sender reputation filtering do not actually enter the work queue, the email gateway does not have access to the list of recipients for an incoming message. In this case, a multiplier is used to estimate the number of recipients. This multiplier was determined by Cisco and based upon research of a large sampling of existing customer data.

## Categorizing Email Messages on the Mail Flow Summary Page

Incoming messages that are considered as threat, and outgoing messages that are delivered in the Mail Flow Summary report page are categorized as follows:

**Table 88: Email Categories on Mail Flow Summary Page**

| Category                           | Description   |
|------------------------------------|---|
| <b>Mail Flow Summary: Incoming</b> |   |
| IP Reputation Filtering            | <p>All connections blocked by HAT policies, multiplied by a fixed multiplier, and added with all recipients blocked by recipient throttling.</p> <p>The value for Stopped by IP Reputation Filtering is calculated based on the following factors:</p> <ul style="list-style-type: none"> <li>• Number of “throttled” messages from this sender.</li> <li>• Number of rejected or TCP refused connections (may be a partial count).</li> <li>• A conservative multiplier for the number of messages per connection.</li> </ul> <p>When the email gateway is under heavy load, an exact count of rejected connections is not maintained on a per-sender basis. Instead, rejected connections counts are maintained only for the most significant senders in each time interval. In this situation, the value shown can be interpreted as an indicative value of the least number of messages are stopped.</p> <p>The IP Reputation Filtering total count and percentage on the Mail Flow Summary report page is always based on a complete count of all rejected connections. Only the per-sender connection counts are limited due to load.</p> |
| Sender Domain Reputation Filtering | The total count of messages blocked based on the reputation verdict of the sender domain.   |
| Invalid Recipients                 | The total count and percentage of all mail recipients rejected by conversational LDAP rejection in addition to all RAT rejections.  |
| Anti-Spam                          | The total count and percentage of incoming messages detected by the anti-spam scanning engine as positive or suspect. Additionally, messages that are both spam and virus positive.   |



| Category                              | Description   |
|---------------------------------------|---|
| Anti-Virus                            | <p>The total count and percentage of incoming messages detected as virus positive and not also spam.</p> <p>The following messages are counted in the “Virus Detected” category:</p> <ul style="list-style-type: none"> <li>• Messages with a virus scan result of “Repaired” or “Infectious”</li> <li>• Messages with a virus scan result of “Encrypted” when the option to count encrypted messages as containing viruses is selected</li> <li>• Messages with a virus scan result of “Unscannable” when the action for unscannable messages is NOT “Deliver”</li> <li>• Messages with a virus scan result of “Unscannable” or “Encrypted” when the option to deliver to an alternate mail host or an alternate recipient is selected</li> <li>• Messages that are deleted from the Outbreak quarantine, either manually or by timing out.</li> </ul> |
| Advanced Malware Protection           | <p>The total count and percentage of incoming messages blocked by the file analysis service.</p> <p>A message attachment was found to be malicious by file reputation filtering. This value does not include verdict updates or files found to be malicious by file analysis.</p>   |
| Content Filter                        | The total count and percentage of incoming messages that are stopped by message and content filters.  |
| DMARC Policy                          | The total count and percentage of incoming messages that failed DMARC verification policy.  |
| S/MIME Verification/Decryption Failed | The total count and percentage of incoming messages that failed S/MIME verification, decryption, or both.   |
| <b>Mail Flow Summary: Outgoing</b>    |   |
| Hard Bounces                          | The total count and percentage of outgoing messages that are permanently undeliverable.   |
| Delivered                             | The total count and percentage of outgoing messages that are delivered.   |



**Note** If you have configured your anti-virus settings to deliver unscannable or encrypted messages, these messages will be counted as clean messages and not virus positive. Otherwise, the messages are counted as virus positive.

Additionally, if messages match a message filter and are not dropped or bounced by the filter, they are treated as clean. Messages dropped or bounced by a message filter are not counted in the totals.

### Related Topics

[Mail Flow Details Page, on page 886](#)

## Using Counters to Filter Data on the Trend Graphs

You can filter data based on the required time range and available counters on a trend graph.

The time range that you select in the Time Range drop-down, is used for a trend graph until you select a different value.

A counters on a trend graph of the Mail Flow Summary report page is used to view data specific to different filters. Click on an available counter to filter the data.

## System Capacity Page

The System Capacity page provides a detailed representation of the system load, including messages in the work queue, average time spent in the work queue, incoming and outgoing messages (volume, size, and number), overall CPU usage, CPU usage by function, and memory page swapping information.

The system capacity page can be used to determine the following information:

- Identify when an email gateway is exceeding recommended capacity and configuration optimization or additional email gateways are needed.
- Identify historical trends in system behavior which point to upcoming capacity issues.
- Identify which part of the system is using the most resources to assist with troubleshooting.

It is important to monitor your email gateway to ensure that your capacity is appropriate to your message volumes. Over time, volume will inevitably rise and appropriate monitoring will ensure that additional capacity or configuration changes can be applied proactively. The most effective way to monitor system capacity is to track overall volume, messages in the work queue and incidents of Resource Conservation Mode.

- **Volume:** It is important to have an understanding of the “normal” message volume and the “usual” spikes in your environment. Track this data over time to measure volume growth. You can use the Incoming Mail and Outgoing Mail pages to track volume over time. For more information, see [System Capacity-Incoming Mail, on page 857](#) and [System Capacity-Outgoing Mail, on page 857](#).
- **Work Queue:** The work queue is designed to work as a “shock absorber”-- absorbing and filtering spam attacks and processing unusual increases in ham messages. However, the work queue is also the best indicator of a system under stress, prolonged and frequent work queue backups may indicate a capacity problem. You can use the WorkQueue page to track the average time messages spend in the work queue and the activity in your work queue. For more information, see [System Capacity- Workqueue, on page 856](#).
- **Resource Conservation Mode:** When an email gateway becomes overloaded, it will enter “Resource Conservation Mode” (RCM) and send a CRITICAL system alert. This is designed to protect the device and allow it to process any backlog of messages. Your email gateway should enter RCM infrequently and only during a very large or unusual increase in mail volume. Frequent RCM alerts may be an indication that the system is becoming overloaded. See [System Capacity-System Load, on page 857](#).

### Related Topics

- [System Capacity- Workqueue, on page 856](#)
- [System Capacity- Incoming Mail, on page 857](#)
- [System Capacity-Outgoing Mail, on page 857](#)
- [System Capacity-System Load, on page 857](#)
- [Note about Memory Page Swapping, on page 858](#)

- [System Capacity- All, on page 858](#)

## System Capacity- Workqueue

The Workqueue page shows the average time a message spends in the work queue, excluding any time spent in the Spam quarantine or in a policy, virus, or outbreak quarantine. You can view time periods from an hour up to one month. This average can help in identifying both short term events delaying mail delivery and identify long term trends in the workload on the system.



---

**Note** If a message is released from the quarantine into the work queue, the “average time in work queue” metric ignores this time. This prevents double-counting and distorted statistics due to extended time spent in a quarantine.

---

The report also shows the volume of messages in the work queue over a specified time period, and it shows the maximum messages in the work queue over the same time period. The graphical representation of the maximum messages in the work queue also shows the work queue threshold level.

Occasional spikes in the Workqueue graphs are normal and expected. If the messages in the work queue remain higher than the configured threshold for a long duration, this may indicate a capacity issue. In this scenario, consider tuning the threshold level or review the system configuration.

For instructions to change the work queue threshold level, see [Setting Thresholds for System Health Parameters, on page 1045](#).



---

**Tip** When reviewing the work queue page, you may want to measure the frequency of work queue backups, and take note of work queue backups that exceed 10,000 messages.

---

## System Capacity- Incoming Mail

The incoming mail page shows incoming connections, the total number of incoming messages, the average message size, and the total incoming message size. You can limit the results to the time range that you specify. It is important to have an understanding of the trends of normal message volume and spikes in your environment. You can use the incoming mail page to help track volume growth over time and plan for system capacity. You might also want to compare the Incoming Mail data with the Sender Profile data to view the trends in volumes of emails that are being sent from specific domains to your network.



---

**Note** An increased number of incoming connections may not necessarily affect system load.

---

## System Capacity-Outgoing Mail

The outgoing mail page shows outgoing connections, the total number of outgoing messages, the average message size, and the total outgoing message size. You can limit the results to the time range that you specify. It is important to have an understanding of the trends of normal message volume and spikes in your environment. You can use the outgoing mail page to help track volume growth over time and plan for system capacity. You might also want to compare the Outgoing Mail data with the Outgoing Destinations data to view the trends in volumes of emails that are being sent from specific domains or IP addresses.

## System Capacity-System Load

The system load report shows the following:

- Overall CPU Usage
- Memory Page Swapping
- Resource Conservation Activity

### Overall CPU Usage

The email gateway is optimized to use idle CPU resources to improve message throughput. High CPU usage may not indicate a system capacity problem. If the high CPU usage is coupled with consistent, high-volume memory page swapping, you may have a capacity problem.



---

**Note** This graph also shows the threshold level for CPU usage. If you want to change the threshold level, use the **System Administration > System Health** page in web interface or **healthconfig** command in CLI. See [Setting Thresholds for System Health Parameters, on page 1045](#).

---

This page also shows a graph that displays the amount of CPU used by different functions, including mail processing, spam and virus engines, reporting, and quarantines. The CPU-by-function graph is a good indicator of which areas of the product use the most resources on your system. If you need to optimize your email gateway, this graph can help you determine which functions may need to be tuned or disabled.

### Memory Page Swapping

The memory page swapping graph shows how frequently the system must page to disk. This graph also shows the threshold level for memory page swapping. If you want to change the threshold level, use the **System Administration > System Health** page in web interface or **healthconfig** command in CLI. See [Setting Thresholds for System Health Parameters, on page 1045](#).

### Resource Conservation Activity

The resource conservation activity graph shows the number of times the email gateway entered Resource Conservation Mode (RCM). For example, if the graph shows *n* times, it means that the email gateway has entered RCM *n* times and exited at least *n*-1 times.

Your email gateway should enter RCM infrequently and only during a very large or unusual increase in mail volume. If the Resource Conservation Activity graph shows that your email gateway is entering RCS frequently, it may be an indication that the system is becoming overloaded.

## Note about Memory Page Swapping

The system is designed to swap memory regularly, so some memory swapping is expected and is not an indication of problems with your email gateway. Unless the system *consistently* swaps memory in high volumes, memory swapping is normal and expected behavior, especially on C170 and C190 appliances. To improve performance, you may need to add email gateways to your network or tune your configuration to ensure maximum throughput.

## System Capacity- All

The All page consolidates all the previous system capacity reports onto a single page so you can view the relationship between the different reports. For example, you might view the message queue is high at the same time that excessive memory swapping takes place. This might be an indication that you have a capacity problem. You may want to save this page as PDF to preserve a snapshot of system performance for later reference (or to share with support staff). For information about generating PDFs in languages other than English, see the [Notes on Reports, on page 906](#).

## Reporting Data Availability

The **Reporting Data Availability** page allows you to view data to provide real-time visibility into resource utilization and email traffic trouble spots.

All data resource utilization and email traffic trouble spots are shown from this page, including the data availability for the overall email gateways that are managed by the Cisco Secure Email and Web Manager.

From this report page you can also view the data availability for a specific email gateway and time range.

## Advanced Malware Protection Page

Advanced Malware Protection protects against zero-day and targeted file-based threats in email attachments by:

- Obtaining the reputation of known files.
- Analyzing behavior of certain files that are not yet known to the reputation service.
- Evaluating emerging threats as new information becomes available, and notifying you about files that are determined to be threats after they have entered your network.

This feature is available for incoming and outgoing messages.

For more information on the file reputation filtering and file analysis, see the *User Guide or Online Help for AsyncOS for Cisco Secure Email Gateway*.

To view the report page, select **Advanced Malware Protection** from the File and Malware Reports section of the Reports drop-down.

The Advanced Malware Protection report page shows the following reporting views:

- [Advanced Malware Protection – Summary, on page 878](#)
- [Advanced Malware Protection – AMP Reputation, on page 878](#)
- [Advanced Malware Protection – File Analysis, on page 879](#)
- [Advanced Malware Protection – File Retrospection, on page 880](#)
- [Advanced Malware Protection – Mailbox Auto Remediation, on page 880](#)

The Advanced Malware Protection report page displays a metrics bar that provides real time data of the email gateway connected to the Cisco Threat Grid appliance.

**Note**

- You must use the `trailblazerconfig > enable` command on the CLI to populate data on the metrics bar. For more information, see the *Cisco Email Security Command Reference Guide*.
- You can only view the data from the Cisco Threat Grid appliance for the day, week and month.

**Related Topics**

- [Identifying Files by SHA-256 Hash , on page 881](#)
- [Viewing File Reputation Filtering Data in Other Reports , on page 881](#)

## Advanced Malware Protection – Summary

The Advanced Malware Protection - Summary page shows the complete summary of the incoming and outgoing file-based threats that are identified by the file reputation and file analysis service.

For more information, see [Advanced Malware Protection – AMP Reputation, on page 878](#) and [Advanced Malware Protection – File Analysis, on page 879](#).

## Advanced Malware Protection – AMP Reputation

The Advanced Malware Protection - AMP Reputation page shows incoming and outgoing file-based threats that were identified by the file reputation service.

For files with changed verdicts, see the AMP Verdict updates report. Those verdicts are not reflected in the Advanced Malware Protection report.

If a file extracted from a compressed or archived file is malicious, only the SHA value of the compressed or archived file is included in the Advanced Malware Protection report.

The **Incoming files handled by AMP** section shows the incoming malware files by different categories such as malicious, clean, unknown, unscannable, and low risk.

Incoming malicious files are categorized as the following:

- The percentage of block listed file SHAs received from the AMP reputation server that are categorized as **Malware**.
- The percentage of block listed file SHAs received from the AMP for Endpoints console that are categorised as **Custom Detection**. The threat name of a block listed file SHA obtained from AMP for Endpoints console is displayed as **Simple Custom Detection** in the Incoming Malware Threat Files section of the report.
- The percentage of block listed file SHAs based on the threshold settings that are categorised as **Custom Threshold**.

You can click on the link in the More Details section of the report to view the file trajectory details of a block listed file SHA in the AMP for Endpoints console.

You can view the **Low Risk** verdict details in the Incoming Files Handed by AMP section of the report.

You can use the AMP Reputation view of the Advanced Malware Protection: Incoming report page to view:

- The summary of incoming files that are identified by file reputation service of the Advanced Malware Protection engine, in a graphical format.
- A trend graph for all the incoming malware threat files based on the selected time range.
- The top incoming malware threat files.
- The top incoming threat files based on the file types.
- The Incoming Malware Threat Files interactive table that lists the top incoming malware threat files.

Drill down to view detailed analysis results, including the threat characteristics for each file.

If your access privileges allow you to view Message Tracking data for the messages that populate this report, click a blue number link in the table.

You can use the AMP Reputation view of the Advanced Malware Protection: Outgoing report page to view:

- The summary of outgoing files that are identified by file reputation service of the Advanced Malware Protection engine, in a graphical format.
- A trend graph for all the outgoing malware threat files based on the selected time range.
- The top outgoing malware threat files.
- The top outgoing threat files based on the file types.
- The Outgoing Malware Threat Files interactive table that lists the top outgoing malware threat files that are identified by the file reputation service.

Drill down to view detailed analysis results, including the threat characteristics for each file.

If your access privileges allow you to view Message Tracking data for the messages that populate this report, click a blue number link in the table.

## Advanced Malware Protection – File Analysis

The Advanced Malware Protection - File Analysis page shows the time and verdict (or interim verdict) for each file sent for analysis. The email gateway checks for analysis results every 30 minutes.

To view more than 1000 File Analysis results, export the data as a .csv file.

For deployments with an on-premises Cisco AMP Threat Grid Appliance: Files that are allow listed on the AMP Threat Grid appliance show as "clean". For information about allow listing, see the AMP Threat Grid documentation or online help.

Drill down to view detailed analysis results, including the threat characteristics for each file.

You can also search for additional information about an SHA, or click the link at the bottom of the file analysis details page to view additional details on the server that analyzed the file. For more information, see [Identifying Files by SHA-256 Hash](#), on page 881.

If your access privileges allow you to view Message Tracking data for the messages that populate this report, click the **Details** link in the table.

If a file extracted from a compressed or archived file is sent for analysis, only the SHA value of the extracted file is included in the File Analysis report.

You can use the File Analysis view of the Advanced Malware Protection report page to view:

- The number of incoming and outgoing files that are uploaded for file analysis by file analysis service of the Advanced Malware Protection engine.
- A list of incoming and outgoing files that have completed file analysis requests.
- A list of incoming and outgoing files that have pending file analysis requests.

## Advanced Malware Protection – File Retrospection

The Advanced Malware Protection - File Retrospection page lists the files processed by this email gateway for which the verdict has changed since the message was received. For more information about on this scenario, see the documentation for your email gateway.

As Advanced Malware Protection is focused on targeted and zero-day threats, threat verdicts can change as aggregated data might unviel more information.

To view more than 1000 verdict updates, export the data as a .csv file.

In the case of multiple verdict changes for a single SHA-256, this report shows only the latest verdict, not the verdict history.

To view all affected messages for a particular SHA-256 within the maximum available time range (regardless of the time range selected for the report) click a SHA-256 link.

You can use the File Retrospection view of the Advanced Malware Protection report page to view:

- A list of incoming and outgoing files with retrospective verdict changes.

## Advanced Malware Protection – Mailbox Auto Remediation

The Advanced Malware Protection - Mailbox Auto Remediation report page shows the details of the mailbox remediation results for the incoming files.

You can use the Advanced Malware Protection - Mailbox Auto Remediation page to view retrospective security details such as:

- A list of recipients for whom the mailbox remediation was successful or unsuccessful
- Remedial actions taken on messages
- The filenames associated with a SHA-256 hash
- A list of profile names defined for the recipients for whom the mailbox remediation was successful or unsuccessful
- Reason for the remediation failure
- No profile mapped to the domain

The Recipients for whom remediation was unsuccessful field is updated in the following scenario:

- *Invalid Mailbox*: The recipient is not a valid Microsoft Exchange online or Microsoft Exchange on-premise user, or the recipient does not belong to the Microsoft Exchange online or an Microsoft Exchange on-premise domain account configured on your email gateway.
- The message containing the attachment is no longer available in the mailbox, for example, the end user deleted the message.



- *Authentication Error*: The user account provided on your email gateway to connect to the Microsoft Exchange on-premise mailbox is incorrect.
- *Connection Error*: There is a connectivity issue between your email gateway and Microsoft Exchange online or Microsoft Exchange on-premise services when the email gateway attempts to perform the remedial action.
- *Permission Error*:
  - In case of a Microsoft Exchange on-premise account, the user account provided on your email gateway to connect to the Microsoft Exchange on-premise mailbox is not assigned the impersonator role.
  - In case of a Microsoft Exchange online account, the Office 365 application does not have the required permission to access the recipient mailbox.
- *No Profile Mapped for domain*: There is no profile mapped to the recipient domain.
- *Mailbox is Inaccessible or Invalid*:
  - The profile type of the account profile that is used to access the mailbox is incorrect.
  - The recipient is not a valid Microsoft Exchange online or Microsoft Exchange on-premise user.
  - The recipient does not belong to the Microsoft Exchange online or an Microsoft Exchange on-premise domain account configured on your email gateway.

Click on a SHA-256 hash to view the related messages in Message Tracking.

## Identifying Files by SHA-256 Hash

Because filenames can easily be changed, the appliance generates an identifier for each file using a Secure Hash Algorithm (SHA-256). If an appliance processes the same file with different names, all instances are recognized as the same SHA-256. If multiple appliances process the same file, all instances of the file have the same SHA-256 identifier.

In most reports, files are listed by their SHA-256 value (in an abbreviated format).

## Viewing File Reputation Filtering Data in Other Reports

Data for file reputation and analysis is available in other reports where relevant. A Detected by Advanced Malware Protection column may be hidden by default in applicable reports. To display additional columns, click the Customize Columns icon at the top right side of the table.

## Virus Filtering Page

The Virus Filtering page provides an overview of the viruses entering and being sent from your network. The Virus Filtering page displays the viruses that have been detected by the virus scanning engines running on your email gateway. You might want to use this report to take a specific action against a particular virus. For example, if you see that you are receiving a high volume of a viruses known to be embedded in PDF files, you might want to create a filter action to quarantine messages with PDF attachments.

If you run multiple virus scanning engines, the Virus Filtering page includes results from all enabled virus scanning engines. The name of the virus displayed on the page is a name determined by the virus scanning engines. If more than one scanning engine detects a virus, it is possible to have more than one entry for the same virus.

The Virus Filtering page gives you an overview of the viruses entering or being sent from or to your network. The Top Incoming Virus Detected section shows a chart view of the viruses that have been sent to your

network in descending order. The Top Outgoing Virus Detected section shows a chart view of the viruses that have been sent from your network in descending order.



---

**Note** To see which hosts sent virus-infected messages to your network, you can go to the Incoming Mail page, specify the same reporting period and sort by virus-positive. Similarly, to see which IP addresses have sent virus-positive email within your network, you can view the Outgoing Senders page and sort by virus-positive messages.

---

The VirusTypes Details listing displays information about specific viruses, including the infected incoming and outgoing messages, and the total infected messages. The details listing for infected incoming messages displays the name of the virus and the number of incoming messages infected with this virus. Similarly, the outgoing messages displays the name of the virus and the number of outgoing messages infected with the virus. You can sort the Virus Type details by Incoming Messages, Outgoing Messages, or Total Infected Messages.

## Macro Detection Page

You can use the Macro Detection report page to view:

- Top and summary of Incoming Macro-Enabled Attachments by File Type in graphical and tabular format.
- Top and summary Outgoing Macro-Enabled Attachments by File Type in graphical and tabular format.

You can click on the number of macro-enabled attachments to view the related messages in Message Tracking.

To view the Macro Detection report page on the email gateway, select **Macro Detection** from the Reports drop-down.



---

**Note** During report generation:

- If one or more macros are detected within an archive file, the Archive Files file type is incremented by one. The number of macro-enabled attachments within an archive file are not counted.
- If one or more macros are detected within an embedded file, the parent file type is incremented by one. The number of macro-enabled attachments within an embedded file are not counted.

---

## DMARC Verification Page

The DMARC Verification page shows the top domains that failed DMARC verification and the details of actions AsyncOS performed on the messages that failed DMARC verification. You can use this report to fine-tune your DMARC settings and answer these kinds of questions:

- Which are the domains that sent maximum number of messages that are not DMARC compliant?
- For each domain, what are the actions AsyncOS performed on the messages that failed DMARC verification?

The DMARC Verification page contains:

- A graphical representation showing top domains by DMARC verification failures.

- Tabular representation of the following, for each domain:
  - Number of messages that were rejected, quarantined, or accepted without taking any action. Click the number to view a list of messages under the selected category.
  - Number messages that passed DMARC verification.
  - Total number of DMARC verification attempts.

You can select a time range on which to report, such as an hour, a week, or a custom range. As with all reports, you can export the data for the graphs or the details listing to CSV format via the **Export** link.

## URL Filtering Page

- URL Filtering report modules are populated only if URL filtering is enabled.
- URL Filtering reports are available for incoming and outgoing messages.
- Only messages that are scanned by the URL filtering engine (either as part of anti-spam/outbreak filter scanning or through message/content filters) are included in these modules. However, not all of the results are necessarily specifically attributable to the URL Filtering feature.
- The Top URL Categories module includes all categories found in messages that have been scanned, whether or not they match a content or message filter.
- Each message can be associated with only one URL reputation level. For messages with multiple URLs, the statistics reflect the lowest reputation of any URL in the message.
- URLs in the global allowed list configured at Security Services > URL Filtering are not included in reports.  
URLs in allowed lists used in individual filters are included in reports.
- Malicious URLs are URLs that Outbreak Filters have determined to have poor reputation. Neutral URLs are those that Outbreak Filters have determined to require click-time protection. Neutral URLs have therefore been rewritten to redirect them to the Cisco Web Security proxy.
- Results of URL category-based filters are reflected in content and message filter reports.
- Results of click-time URL evaluations by the Cisco Web Security proxy are not reflected in reports.

## Outbreak Filtering Page

The Outbreak Filtering report page shows information about recent outbreaks and messages quarantined due to Outbreak Filters. You can use this page to monitor your defense against targeted virus, scam, and phishing attacks.

Use the Outbreak Filtering report page to answer the following types of questions:

- How many messages are quarantined and by which Outbreak Filters rule?
- How long do messages stay in the Outbreak Quarantine?
- Which potentially malicious URLs are most frequently seen?

To view the Outbreak Filtering report page, select **Outbreak Filtering** from the Reports drop-down.

The following table explains the various sections on the Outbreak Filtering report page:

Table 89: Details on the Outbreak Filtering Page

| Section                                 | Description  |
|---|--|
| Time Range (drop-down list)             | A drop-down list with options for choosing a time range to view.   |
| Threats By Type                         | The Threats by Type section shows the different types of threat messages received by the email gateway.  |
| Threat Summary                          | <p>The Threat Summary section shows a breakdown of the messages by Malware, Phish, Scam and Virus.</p> <p>To view Message Tracking details for the messages that populate this report, click a blue number link in the table.</p>  |
| Threat Details                          | <p>The Threat Details interactive table shows details about specific outbreaks, including the threat category (virus, scam, or phishing), threat name, a description of the threat, and the number of messages identified.</p> <p>To view Message Tracking details for the messages that populate this report, click a blue number link in the table.</p>  |
| Hit Messages from Incoming Messages     | <p>The Hit Messages from Incoming Messages section shows the chart and summary of the number of incoming messages processed by Outbreak Filters in the selected time period.</p> <p>Non-viral threats include phishing emails, scams, and malware distribution using links to an external website.</p>   |
| Hit Messages by Threat Level            | <p>The Hit Messages by Threat Level section shows the chart and summary of the severity of threats caught by Outbreak Filters.</p> <p>Level 5 threats are severe in scope or impact, while Level 1 represents low threat risk. For descriptions of threat levels, see the online help or user guide for your email gateway.</p>  |
| Messages resided in Outbreak Quarantine | <p>The Messages resided in Outbreak Quarantine shows the length of time messages spent in the Outbreak Quarantine.</p> <p>This duration is determined by the time it takes the system to compile enough data about the potential threat to make a verdict on its safety. Messages with viral threats typically spend more time in the quarantine than those with non-viral threats, because they must wait for anti-virus program updates. The maximum retention time that you specify for each mail policy is also reflected.</p> |

| Section             | Description   |
|---------------------|---|
| Top URL's Rewritten | <p>The Top URL's Rewritten section shows the URLs that are most frequently rewritten to redirect message recipients to the Cisco Web Security Proxy for click-time evaluation of the site if and when the recipient clicks a potentially malicious link in a message.</p> <p>This list may include URLs that are not malicious, because if any URL in a message is deemed malicious, then all URLs in the message are rewritten.</p> <p>To view Message Tracking details for the messages that populate this report, click a blue number link in the table.</p> |



---

**Note** In order to correctly populate the tables on the Outbreak Filtering report page, the email gateway must be able to communicate with the Cisco update servers.

---

## Forged Email Detection Page

The Forged Email Detection page includes the following reports:

- **Top Forged Email Detection.** Displays the top ten users in the content dictionary that matched the forged From: header in the incoming messages.
- **Forged Email Detection: Details.** Displays a list of all the users in the content dictionary that matched the forged From: header in the incoming messages and for a given user, the number of messages matched.

To view the Forged Email Detection report page on the Security Management appliance, select **Forged Email Detection** from the Reports drop-down.

The Forged Email Detection reports are populated only if you are using the Forged Email Detection content filter or the `forged-email-detection` message filter.

From the Forged Email Detection report page you can export raw data to a CSV file. Click **Export** link on the top of a report page. Select the required report module that you want to export and click **Download**.

## Sender Domain Reputation Page

You can use the Sender Domain Reputation report page to view:

- Incoming messages based on the verdict received from the SDR service in graphical format.
- Incoming messages based on the threat category received from the SDR service in graphical format.



---

**Note** Only the messages whose SDR verdict is 'untrusted' or 'questionable' are classified under the SDR threat category, such as, 'spam,' 'malicious,' and so on.

---

- Summary of incoming messages based on the threat category received from the SDR service in tabular format.

To view the Sender Domain Reputation report page on the Security Management appliance, select **Sender Domain Reputation** from the Reports drop-down.

## External Threat Feeds Page

You can use the External Threat Feeds report page to view:

- Top ETF sources used to detect threats in messages in graphical format
- Summary of ETF sources used to detect threats in messages in tabular format.
- Top IOCs that matched threats detected in messages in graphical format.
- Top ETF sources used to filter malicious incoming mail connections in graphical format.
- Summary of ETF sources used to filter malicious incoming mail connections in tabular format.

In the 'Summary of External Threat Feed Sources' section:

- You can click on the number of messages for a particular ETF source to view the related messages in Message Tracking.
- You can click on a particular threat feed source to view the distribution of the ETF source based on the IOCs.

In the 'Summary of Indicator of Compromise (IOC) Matches' section:

- You can click on the number of IOCs for a particular ETF source to view the related messages in Message Tracking.
- You can click on a particular IOC to view the distribution of the IOC based on the ETF sources.

To view the External Threat Feeds report page, select **External Threat Feeds** from the Reports drop-down.

## Mail Flow Details Page

The Mail Flow Details report page provides interactive reporting on the real-time information for all remote hosts connecting to your managed Cisco Secure Email and Web Manager. You can gather information about the IP addresses, domains, and network owners (organizations) sending mail to your system. You can also gather information about the IP addresses and domains of the outgoing senders.

To view the Mail Flow Details report page, select **Mail Flow Details** from the Reports drop-down.

The Mail Flow Details report page has the following tabs:

- Incoming Mails
- Outgoing Senders

To search for specific information within your data, see [Searching and the Interactive Email Report Pages](#), on page 865.

From the Incoming Mails tab, you can:

- View the top senders by total threat messages in graphical format.
- View the top senders by clean messages in graphical format.
- View the top senders by graymail messages in graphical format.
- See the IP addresses, domains, or network owners (organizations) that have sent mail to your Cisco Secure Email and Web Manager.
- See detailed statistics on senders that have sent mail to your email gateways. The statistics include the number of connections (accepted or rejected), attempted messages broken down by security service (sender reputation filtering, anti-spam, anti-virus, and so forth), total threat messages, total graymails and clean messages.
- See the Incoming Mails interactive table for the detailed information about the particular IP address, domain, or network owner (organization). For more information, see [Incoming Mails Table, on page 889](#).

If your access privileges allow you to view Message Tracking data for the messages that populate this report, click a number hyperlink in the table.

From the Outgoing Senders tab, you can:

- View the top senders by total threat messages in graphical format.
- View the top senders by clean messages in graphical format.
- View the top senders (by IP address or domain) of outgoing threat messages (spam, antivirus, etc.) in your organization.
- See detailed statistics on senders that have sent mail from your email gateways. The statistics include the total threat messages broken down by security service (sender reputation filtering, anti-spam, anti-virus, and so forth) and clean messages.
- See the Sender Details interactive table for detailed information about the particular IP address or domain. For more information, see [Sender Details Table, on page 893](#).

If your access privileges allow you to view Message Tracking data for the messages that populate this report, click a number hyperlink in the table.

### Related Topics

- [Incoming Mails Table, on page 889](#)
- [“No Domain Information”, on page 888](#)
- [Time Range for Reports, on page 866](#)
- [Views Within the Mail Flow Details Page, on page 887](#)

## Views Within the Mail Flow Details Page

The Mail Flow Details: Incoming report page has three different views:

- IP Addresses
- Domains
- Network Owners

These views provide a snapshot of the remote hosts connecting to the system in the context of the selected view.

Additionally, in the Incoming Mail table of the Mail Flow Details page, you can click on a Sender's IP Address, Domain name, or Network Owner Information to retrieve specific Sender Profile Information. For more information on Sender Profile information, see the [Sender Profile Pages, on page 892](#).



---

**Note** Network owners are entities that contain domains. Domains are entities that contain IP addresses.

---

Depending on the view you select, the Incoming Mail Details interactive table displays the top IP addresses, domains, or network owners that have sent mail to all public listeners configured on the email gateways. You can monitor the flow of all mail into your email gateways.

Click an IP address, domain, or network owner to access details about the sender on the Sender Profile page. The Sender Profile page is an Mail Flow Details page that is specific to a particular IP address, domain, or network owner.

See the [Incoming Mails Table, on page 889](#) for an explanation of the data included in the Incoming Mails interactive table.

From the Mail Flow Details page you can export raw data to a CSV file.



---

**Note** You can generate a scheduled report for the Mail Flow Details report page. See the [Scheduled Reports, on page 906](#).

---

The Mail Flow Details: Outgoing report page has two different views:

- IP Addresses
- Domains

These views provide a snapshot of the remote hosts connecting to the system in the context of the selected view.

Depending on the view you select, the Sender Details interactive table displays the top IP addresses or domains of the senders that have sent mail from the public listeners configured from the Email Security appliances. You can monitor the flow of all mail from your email gateways.

See the [Sender Details Table, on page 893](#) for an explanation of the data included in the Sender Details interactive table.

## "No Domain Information"

Domains which have connected to the email gateway and could not be verified with a double-DNS lookup are automatically grouped into the special domain "No Domain Information." You can control how these types of unverified hosts are managed via Sender Verification. See [Configuring the Gateway to Receive Email, on page 65](#).

You can select the number of senders to show in the listing via the Items Displayed menu.



## Time Range for Reports

The Email Security Monitor feature constantly records data about the mail flowing into your gateway. The data are updated every 60 seconds, but the display shown is delayed by 120 seconds behind the current system time. You can specify the time range to include in the results shown. Because the data is monitored in real time, information is periodically updated and summarized in the database.

Choose from the time range options in the following table.

**Table 90: Time Ranges Available in the Email Security Monitor Feature**

| This time range selected in the GUI | ...is defined as:  |
|-------------------------------------|--|
| Hour                                | the last 60 minutes + up to 5 minutes  |
| Day                                 | the last 24 hours + the last 60 minutes  |
| Week                                | the last 7 days + the elapsed hours of the current day                                   |
| 30 days                             | the last 30 days + the elapsed hours of the current day                                  |
| 90 days                             | the last 90 days + the elapsed hours of the current day                                  |
| Yesterday                           | 00:00 to 23:59 (midnight to 11:59 PM)  |
| Previous Calendar Month             | 00:00 of the first day of the month to 23:59 of the last day of the month                |
| Custom Range                        | the range enclosed by the start date and hour and the end date and hour that you specify |

## Incoming Mails Table

The interactive Incoming Mails table at the bottom of the Mail Flow Details: Incoming Mails page lists the top senders that have connected to public listeners on the email gateways. The table shows domains, IP addresses, or network owners, based on the view selected.

The system acquires and verifies the validity of the remote host's IP address by performing a double DNS lookup. For more information about *double DNS lookups* and sender verification, see the user guide or online help for the email gateway

For senders, that is Network Owner, IP Address or Domain, listed in the first column of the Incoming Mails table, or on the Top Senders by Total Threat Messages, click the Sender or No Domain Information link to view more information about the sender. The results appear on a Sender Profile page, which includes real-time information from the IP Reputation Service. From the Sender Profile page, you can view for more information about specific IP addresses or network owners. For more information, see the [Sender Profile Pages, on page 892](#).

You can also view the Sender Groups report, by clicking Sender Groups report at the bottom of the Mail Flow Details page. For more information about the Sender Groups report page, see the [Sender Groups Report, on page 894](#).

To view Message Tracking details for the messages that populate this report, click a number hyperlink in the table.

The following table shows the table column descriptions for the Incoming Mails table:

Table 91: Table Column Descriptions for Incoming Mail Table

| Column Name  | Description   |
|--|---|
| Sender Domain (Domains)                                      | The domain name of the sender.  |
| Sender IP Address (IP Addresses)                             | The IP address of the sender.   |
| Hostname (IP Addresses)                                      | The hostname of the sender.   |
| DNS Verified (IP Addresses)                                  | The IP addresses that are verified by the DNS.  |
| IP Reputation Score (IP Addresses)                           | The IP Reputation Score of the sender.  |
| Last Sender Group (IP Addresses)                             | The details of the last sender group.   |
| Last Sender Group (IP Addresses)                             | The details of the last sender group.   |
| Network Owner (Network Owners)                               | The network owner of the sender.  |
| Connections Rejected (Domains and Network Owners)            | All connections blocked by HAT policies. When the email gateway is under heavy load, an exact count of rejected connections is not maintained on a per-sender basis. Instead, rejected connections counts are maintained only for the most significant senders in each time interval.   |
| Connections Accepted (Domains and Network Owners)            | All connections accepted,   |
| Total Attempted  | All accepted and blocked connections attempted.   |
| Stopped by Recipient Throttling (Domains and Network Owners) | This is a component of Stopped by Reputation Filtering. It represents the number of recipient messages stopped because any of the following HAT limits have been exceeded: maximum recipients per hour, maximum recipients per message, or maximum messages per connection. This is summed with an estimate of the recipient messages associated with rejected or TCP refused connections to yield Stopped by Reputation Filtering. |

| Column Name                             | Description   |
|---|---|
| Stopped by IP Reputation Filtering      | <p>The value for Stopped by IPReputation Filtering is calculated based on several factors:</p> <ul style="list-style-type: none"> <li>• Number of “throttled” messages from this sender</li> <li>• Number of rejected or TCP refused connections (may be a partial count)</li> <li>• A conservative multiplier for the number of messages per connection.</li> </ul> <p>When the email gateway is under heavy load, an exact count of rejected connections is not maintained on a per-sender basis. Instead, rejected connections counts are maintained only for the most significant senders in each time interval. In this situation, the value shown can be interpreted as a “floor”; that is, at least this many messages are stopped.</p> <p><b>Note</b> The IP Reputation Filtering total on the Mail Flow Summary page is always based on a complete count of all rejected connections. Only the per-sender connection counts are limited due to load.</p> |
| Stopped by Domain Reputation Filtering  | The total count of messages blocked based on the reputation verdict of the sender domain.   |
| Stopped as Invalid Recipients           | All mail recipients rejected by conversational LDAP rejection plus all RAT rejections.  |
| Spam Detected                           | Any spam that has been detected.  |
| Virus Detected                          | Any viruses that have been detected   |
| Detected by Advanced Malware Protection | The total count of messages detected by Advanced Malware Protection engines.  |
| Stopped by Content Filter               | The total count of messages that are stopped by a content filter.   |
| Stopped by DMARC                        | <p>The total count of messages that failed Domain-based Message Authentication, Reporting and Conformance (DMARC) verification.</p> <p><b>Note</b> The email gateway displays the total count of 'Stopped by DMARC' messages based on the 'Failed - Rejected,' 'Failed - Quarantined,' and 'Failed - No Action' results.</p>  |
| Total Threat                            | Total number of threat messages (stopped by reputation, stopped as invalid recipient, spam, plus virus)   |
| Marketing                               | Number of messages detected as unwanted marketing messages.   |
| Social                                  | Number of messages detected as social messages.   |
| Bulk                                    | Number of messages detected as bulk.  |
| Total Graymails                         | Number of messages detected as graymails.   |

| Column Name | Description  |
|-------------|--|
| Clean       | All clean messages.<br>Messages processed on email gateways on which the graymail feature is not enabled are counted as clean. |

## Sender Profile Pages

When you click a sender in the Incoming Mail Details interactive table, on the **Mail Flow Details** [New Web Interface] or **Incoming Mail** page, the Sender Profile page appears. It shows detailed information about the particular IP address, domain, or network owner (organization). You can access a Sender Profile page for any IP address, domain, or network owner by clicking the corresponding link on the Incoming Mail page or on other Sender Profile pages.

*Network owners* are entities that contain domains. *Domains* are entities that contain IP addresses.

The Sender Profile pages displayed for IP addresses, domains, and network owners vary slightly. For each, the page contains a graph and summary table for incoming mail from the particular sender. Below the graph, a table lists the domains or IP addresses associated with the sender. (The Sender Profile page for an individual IP address does not contain a more granular listing.) The Sender Profile page also includes an information section with the current SenderBase, sender group, and network information for the sender.

- Network Owner profile pages contain information for the network owner, as well as the domains and IP addresses associated with that network owner.
- Domain profile pages contain information for the domains and IP addresses associated with that domain.
- IP address profile pages contain information about the IP address only.

Each Sender Profile page contains the following data in the Current Information table at the bottom of the page:

- The global information from the IP Reputation Service, including:
  - IP address, domain name, and/or network owner
  - Network owner category (network owner only)
  - CIDR range (IP addresses only)
  - Daily magnitude and monthly magnitude for the IP address, domain, and/or network owner
  - Days since the first message was received from this sender
  - Last sender group and whether DNS verified (IP address sender profile page only)

Daily magnitude is a measure of how many messages a domain has sent over the last 24 hours. Similar to the Richter scale used to measure earthquakes, SenderBase magnitude is a measure of message volume calculated using a log scale with a base of 10. The maximum theoretical value of the scale is set to 10, which equates to 100% of the world's email message volume. Using the log scale, a one-point increase in magnitude equates to a 10x increase in actual volume.

Monthly magnitude is calculated using the same approach as daily magnitude, except the percentages are calculated based on the volume of email sent over the last 30 days.

- Average magnitude (IP addresses only)

- Lifetime volume / 30 day volume (IP address profile pages only)
- Bonded sender status (IP address profile pages only)
- IP Reputation Score (IP address profile pages only)
- Days since first message (network owner and domain profile pages only)
- Number of domains associated with this network owner (network owner and domain profile pages only)
- Number of IP addresses in this network owner (network owner and domain profile pages only)
- Number of IP addresses used to send email (network owner pages only)

Click **More from SenderBase** to see a page with all information supplied by the IP Reputation Service.

- Details about the domains and IP addresses controlled by this network owner appear on network owner profile pages. Details about the IP addresses in the domain appear on domain pages.

From a domain profile page, you can click on a specific IP address to view specific information, or view an organization profile page.

## Sender Details Table

The interactive Sender Details table at the bottom of the Mail Flow Details: Outgoing page lists the top senders that have connected to public listeners on the email gateways. The table shows domains or IP addresses, based on the view selected.

To view Message Tracking details for the messages that populate this report, click a number hyperlink in the table.

The following table shows the table column descriptions for the Sender Details table:

**Table 92: Table Column Descriptions for Sender Details Table**

| Column Name                             | Description  |
|---|--|
| Sender Domain (Domains)                 | The domain name of the sender.   |
| Sender IP Address (IP Addresses)        | The IP address of the sender.  |
| Hostname (IP Addresses)                 | The hostname of the sender.  |
| Spam Detected                           | Any spam that has been detected.   |
| Virus Detected                          | Any viruses that have been detected.   |
| Detected by Advanced Malware Protection | The total count of messages detected by Advanced Malware Protection engines. |
| Stopped by Content Filter               | The total count of messages that are stopped by a content filter.            |
| Stopped by DLP                          | The total count of messages that are stopped by DLP engine.                  |
| Total Threat                            | Total number of threat messages (spam, virus)                                |

| Column Name    | Description  |
|----------------|--|
| Clean          | All clean messages.<br>Messages processed on email gateways on which the graymail feature is not enabled are counted as clean. |
| Total Messages | The total count of all the messages.   |

## Sender Groups Report

The Sender Groups report provides a summary of connections by sender group and mail flow policy action, allowing you to review SMTP connection and mail flow policy trends. The Mail Flow by Sender Group listing shows the percentage and number of connections for each sender group. The Connections by Mail Flow Policy Action chart shows the percentage of connections for each mail flow policy action. This page provides an overview of the effectiveness of your Host Access Table (HAT) policies. For more information about the HAT, see [Configuring the Gateway to Receive Email, on page 65](#).

## Outgoing Destinations

The Outgoing Destinations page provides information about the domains your company sends mail to. The page consists of two sections. The top half of the page consists of graphs depicting the top destinations by outgoing threat messages and top destinations by outgoing clean messages on the top half of the page. The bottom half of the page displays a chart showing all the columns sorted by total recipients (default setting).

You can select a time range on which to report, such as a day, a week, or a custom range. As with all reports, you can export the data for the graphs or the details listing to CSV format via the **Export** link.

The Outgoing Destinations page can be used to answer the following types of questions:

- What domains is the email gateway sending mail to?
- How much mail is sent to each domain?
- How much of that mail is clean, spam-positive, virus-positive, malware or stopped by a content filter?
- How many messages are delivered and how many messages are hard-bounced by the destination server?

## TLS Encryption Page

The TLS Encryption pages shows the overall usage of TLS Encryption for sent and received mail. The report also shows details for each domain sending mail using TLS connections.

The TLS Encryption page can be used to determine the following information:

- Overall, what portion of incoming and outgoing connections use TLS?
- What partners do I have successful TLS connections with?
- What partners do I have unsuccessful TLS connections with?
- What partners do I have successful TLS connections with DANE support?
- What partners do I have unsuccessful TLS connections with DANE support?
- What partners have issue with their TLS certificates?

- What percent of overall mail with a partner uses TLS?
- What percent of outgoing TLS connections with DANE support are successful?
- What percent of outgoing connections with DANE support are unsuccessful?

The TLS Encryption page is divided into a section for incoming connections and a section for outgoing connections. Each section includes a graph, summaries, and a table with details.

The graph displays a view of incoming or outgoing TLS-encrypted and non-encrypted connections over the time range you specify. The graph displays the total volume of messages, the volume of encrypted and unencrypted messages, the volume of successful and failed TLS encrypted messages and the volume of successful and failed DANE connections. The graphs distinguish between connections in which TLS was required and connections in which TLS was merely preferred.

The table displays details for domains sending or receiving encrypted messages. For each domain, you can view the number of required and preferred TLS connections that were successful and that failed, the total number of TLS connections attempted (whether successful or failed), the total number of unencrypted connections, and the total number of unencrypted connections, and the total number of DANE connections (depending on whether successful or failed). You can also view the percentage of all connections in which TLS was attempted, and the total number of encrypted messages sent successfully, regardless of whether TLS was preferred or required. You can show or hide columns by Customize Columns icon at the top right side of the table.

## Inbound SMTP Authentication Page

The Inbound SMTP Authentication page shows the use of client certificates and the SMTP AUTH command to authenticate SMTP sessions between the email gateway and users' mail clients. If the email gateway accepts the certificate or SMTP AUTH command, it will establish a TLS connection to the mail client, which the client will use to send a message. Since it is not possible for the email gateway to track these attempts on a per-user basis, the report shows details on SMTP authentication based on the domain name and domain IP address.

Use this report to determine the following information:

- Overall, how many incoming connection use SMTP authentication?
- How many connections use a client certificated?
- How many connections use SMTP AUTH?
- What domains are failing to connect when attempting to use SMTP authentication?
- How many connections are successfully using the fall-back when SMTP authentication fails?

The Inbound SMTP Authentication page includes a graph for received connections, a graph for mail recipients who attempted an SMTP authentication connection, and a table with details on the attempts to authenticate connections.

The Received Connections graph shows the incoming connections from mail clients that attempt to authentication their connections using SMTP authentication over the time range you specify. The graph displays the total number of connections the email gateway received, the number that did not attempt to authenticate using SMTP authentication, the number that failed and succeeded to authenticate the connection using a client certificate, and the number that failed and succeeded to authenticate using the SMTP AUTH command.

The Received Recipients graph displays the number of recipients whose mail clients attempted to authenticate their connections to the email gateways to send messages using SMTP authentication. The graph also show

the number of recipients whose connections were authenticated and the number of recipients whose connections were not authenticated.

The SMTP Authentication details table displays details for the domains whose users attempt to authenticate their connections to the email gateway to send messages. For each domain, you can view the number of connection attempts using a client certificate that were successful or failed, the number of connection attempts using the SMTP AUTH command that were successful or failed, and the number that fell back to the SMTP AUTH after their client certificate connection attempt failed. You can use the tabs at the top of the page to display this information by domain name or domain IP address.

## Rate Limits Page

Rate Limiting by envelope sender allows you to limit the number of email message recipients per time interval from an individual sender, based on the mail-from address. The Rate Limits report shows you the senders who most egregiously exceed this limit.

Use this report to help you identify the following:

- Compromised user accounts that might be used to send spam in bulk.
- Out-of-control applications in your organization that use email for notifications, alerts, automated statements, etc.
- Sources of heavy email activity in your organization, for internal billing or resource-management purposes.
- Sources of large-volume inbound email traffic that might not otherwise be considered spam.

Note that other reports that include statistics for internal senders (such as Internal Users or Outgoing Senders) measure only the number of messages sent; they do not identify senders of a few messages to a large number of recipients.

The Top Offenders by Incident chart shows the envelope senders who most frequently attempted to send messages to more recipients than the configured limit. Each attempt is one incident. This chart aggregates incident counts from all listeners.

The Top Offenders by Rejected Recipients chart shows the envelope senders who sent messages to the largest number of recipients above the configured limit. This chart aggregates recipient counts from all listeners.

To configure rate limiting by envelope sender or modify the existing rate limit, see [Defining Rules for Incoming Messages Using a Mail Flow Policy, on page 103](#).

## Connections by Country Page

You can use the Connections by Country report page to view:

- Top incoming mail connections based on country of origin in graphical format.
- Total incoming mail connections based on country of origin in tabular format.

You can click on the number of incoming mail connections of a specific geolocation to view the related messages in Message Tracking.

The "Total Messages" column only displays those messages that are accepted at the SMTP connection level.





---

**Note** During report generation:

- If one or more incoming mail connections are detected as private IP address, the incoming mail connections are categorized as “Private IP Addresses” in the report.
  - If one or more incoming mail connections are detected as not a valid IP Reputation score, the incoming mail connections are categorized as ‘No Country Info’ in the report.
- 

## User Mail Summary Page

The User Mail Summary page provides information about the mail sent and received by your internal users, *per email address* (a single user may have multiple email addresses listed — the email addresses are not combined in the report).

The page consists of two sections:

- Graphs depicting the top users by clean incoming and outgoing messages and top users receiving graymail.
- User mail flow details

You can select a time range on which to report (hour, day, week, or month). As with all reports, you can export the data for the graphs or the details listing to CSV format via the **Export** link. You can also display hidden table columns or hide default columns by clicking the Customize Column icon on the top right side of the table.

The User Mail Flow Details listing breaks down the mail received and sent by each email address into clean, spam (incoming only), virus, malware, content filter matches, and graymail (incoming only). You can sort the listing by clicking on the column headers.

Using the Internal Users report, you can answer these kinds of questions:

- Who is sending the most external email?
- Who receives the most clean email?
- Who receives the most number of graymail messages?
- Who receives the most spam?
- Who is triggering which content filters?
- Whose email is getting caught by content filters?

Inbound Internal Users are the users for which you received email, based on the Rcpt To: address. Outbound Internal Users are based on the Mail From: address and are useful when tracking the types of email that senders on your internal network are sending.

Note that some outbound mail (like bounces) have a null sender. They are counted under outbound and “unknown.”

Click on an internal user to view the Internal User detail page for that user.

Click the Customize Columns icon on the top right side of the table to show columns that are hidden by default, such as the Incoming Spam Detected by Intelligent Multi-Scan column or Outgoing Spam Detected by Intelligent Multi-Scan column.

### Related Topics

- [User Mail Flow Details, on page 898](#)
- [Searching for a Specific Internal User, on page 846](#)

## User Mail Flow Details

The User Mail Flow details section shows detailed information about the specified user, including a breakdown of incoming and outgoing messages showing the number of messages in each category (spam detected, virus detected, detected by Advanced Malware Protection, stopped by content filter, graymail detected, and clean). Optionally, for incoming messages, you can click the Customize Columns icon on the top right side of the table to show the Incoming Spam Detected by Intelligent Multi-Scan column. This value reflects the number messages that contained attachments that were determined by file reputation filtering to be malicious. It does not include verdict updates or files found to be malicious by file analysis. Incoming and outgoing content filter and DLP policy matches are also shown.

Click a content filter name to view detailed information for that filter in the corresponding content filter information page (see [Content Filters Page, on page 848](#)). You can use this method to get a list of users who also sent or received mail that matched that particular content filter.

## Searching for a Specific Internal User

You can search for a specific internal user (email address) via the search form at the bottom User Mail Summary page. Choose whether to exactly match the search text or look for items starting with the entered text (for instance, starts with “ex” will match “example.com”).

## DLP Incident Summary Page

The DLP Incident Summary page shows information on the incidents of data loss prevention (DLP) policy violations occurring in outgoing mail. The email gateway uses the DLP email policies enabled in the Outgoing Mail Policies table to detect sensitive data sent by your users. Every occurrence of an outgoing message violating a DLP policy is reported as an incident.

Using the DLP Incidents report, you can answer these kinds of questions:

- What type of sensitive data is being sent by your users?
- How severe are these DLP incidents?
- How many of these messages are being delivered?
- How many of these messages are being dropped?
- Who is sending these messages?

The DLP Incident Summary page is comprised of two main sections:

- the DLP incident trend graphs summarizing the top DLP incidents by severity (Low, Medium, High, Critical) and policy matches, and

- the DLP Incidents Details listing.

You can select a time range on which to report, such as an hour, a week, or a custom range. As with all reports, you can export the data for the graphs or the details listing to CSV format via the **Export** link. For information about generating PDFs in languages other than English, see the [Notes on Reports, on page 906](#).

Click the name of a DLP policy to view detailed information on the DLP incidents detected by the policy. You can use this method to get a list of users who sent mail that contained sensitive data detected by the policy.

### Related Topics

- [DLP Incident Details, on page 899](#)
- [DLP Policy Detail Page, on page 899](#)

## DLP Incident Details

The DLP policies currently enabled in the email gateway's outgoing mail policies are listed in the DLP Incident Details table. Click the name of a DLP policy to view more detailed information.

The DLP Incident Details table shows the total number of DLP incidents per policy, with a breakdown by severity level. The severity level also includes the number of bounced messages and the number of messages delivered in the clear, delivered encrypted, or dropped. Click the column headings to sort the data.

## DLP Policy Detail Page

If you clicked the name of a DLP policy in the DLP Incident Details table, the resulting DLP Policy Detail page displays the DLP incidents data for the policy. The page displays graphs on the DLP incidents based on severity.

The page also includes an Incidents by Sender listing at the bottom of the page that lists each internal user who has sent a message that violated the DLP policy. The listing also shows the total number of DLP incidents for this policy per user, with a breakdown by severity level, and whether any of the messages were delivered in the clear, delivered encrypted, or dropped. You can use the Incidents by Sender listing to find out which users may be sending your organization's sensitive data to people outside your network.

Clicking on the sender name opens up the Internal Users page. See [#unique\\_1508](#) for more information.

## Web Interaction Page

- Web Interaction Tracking report modules are populated only if the web interaction tracking feature is enabled.
- Web Interaction Tracking report modules are not updated in real-time and are refreshed every 30 minutes. Also, after clicking a rewritten URL, it may take up to two hours for the Web Interaction Tracking report to report this event.
- Web Interaction Tracking report is not updated in real-time. After clicking a cloud re-directed rewritten URL, it may take up to two hours for the Web Interaction Tracking report to report this event.
- Web Interaction Tracking reports are available for incoming and outgoing messages.
- Only cloud re-directed rewritten URLs (either by policy or Outbreak Filter) clicked by the end users are included in these modules.

- Web Interaction Tracking page includes the following reports:

**Top Malicious URLs clicked by End Users.** Click on a URL to view a detailed report that contains the following information:

- A list of end users who clicked on the rewritten malicious URL.
- Date and time at which the URL was clicked.
- Whether the URL was rewritten by a policy or an outbreak filter.
- Action taken (allow, block, or unknown) when the rewritten URL was clicked. Note that, if a URL was rewritten by outbreak filter and the final verdict is unavailable, the status is shown as unknown.

#### **Top End Users who clicked on Malicious URLs**

This section displays the summary of the top end users who clicked on the Rewritten Malicious URLs, for incoming and outgoing messages.

**Web Interaction Tracking Details.** Includes the following information:

- A list of all the cloud re-directed rewritten URLs (malicious and unmalicious). Click on a URL to view a detailed report.
- Action taken (allow, block, or unknown) when a cloud re-directed rewritten URL was clicked.

For the data to show up, perform the following:

- Choose **Incoming Mail Policies > Outbreak Filters** to configure an outbreak filter and enable message modification and URL rewriting.
- Configure a content filter with the "**Redirect to Cisco Security Proxy**" action.

Note that, if the verdict of a URL (clean or malicious) was unknown at the time when the end user clicked it, the status is shown as unknown. This could be because the URL was under further scrutiny or the web server was down or not reachable at the time of the user click.

- The number of times end users clicked on a rewritten URL. Click on a number to view a list of all the messages that contain the clicked URL.
- While using Web Interaction Tracking reports, keep in mind the following limitations:
  - If you have configured a content or message filter to deliver messages after rewriting malicious URLs and notify another user (for example, an administrator), the web interaction tracking data of the original recipient is incremented even if the notified user clicks on the rewritten URLs.
  - If you are sending a copy of quarantined messages containing rewritten URLs to a user (for example, an administrator) using web interface, the web interaction tracking data of the original recipient is incremented even if the user (to whom the copy of the messages were sent) clicks on the rewritten URLs.
  - At any point, if you plan to modify the time of your email gateway, make sure that the system time is synchronized with Coordinated Universal Time (UTC).

## Remediation Report Page

You can use the Remediation report to monitor the remediation results for Mailbox Auto Remediation and Mailbox Search and Remediate.

Use this report:

- To view the list of messages that are attempted for Mailbox Auto Remediation and Mailbox Search and Remediate.
- To know the reason for remediation failure. For example, connections errors, authentication errors, and so on.

The following list explains the various sections on the Rate Limit report:

| Section                  | Description  |
|--------------------------|--|
| Summary                  | <p>The Summary section displays the following:</p> <ul style="list-style-type: none"> <li>• Total number of messages attempted for remediation using Mailbox Auto Remediation and Mailbox Search and Remediate.</li> <li>• Number of messages successfully remediated for a configured remedial action.</li> <li>• Number of messages for which the remediation failed.</li> </ul>   |
| Mailbox Auto Remediation | <p>The Mailbox Auto Remediation report section displays the following:</p> <ul style="list-style-type: none"> <li>• A list of recipients for whom the mailbox auto remediation was successful or unsuccessful.</li> <li>• Auto Remedial actions taken on messages.</li> <li>• The filenames associated with a SHA-256 hash. Click the SHA-256 hash to view the related messages in the Message Tracking page.</li> <li>• A list of profile names defined for the recipients for whom the mailbox auto remediation was successful or unsuccessful.</li> <li>• Reason for the auto remediation failure.</li> </ul> |

| Section                      | Description  |
|------------------------------|--|
| Mailbox Search and Remediate | <p>The Mailbox Search and Remediate section displays the following details:</p> <ul style="list-style-type: none"> <li>• The list of remediation batches that are in progress or completed.</li> <li>• The remediation status of the messages in the batches.</li> <li>• The batch name and the batch ID. Click the batch name to view the batch details: <ul style="list-style-type: none"> <li>• The date and time when the Mailbox Search and Remediate was initiated.</li> <li>• The source from which the Mailbox Search and Remediate was initiated.</li> <li>• The host who initiated the Mailbox Search and Remediate.</li> <li>• The remedial action taken on the messages.</li> <li>• The Cisco Ironport Message ID of the message.</li> <li>• A read receipt icon to show if the message was read by the recipient before the message was remediated successfully.</li> <li>• The remediation status of the message in the particular batch as Success, Failed, or In Progress.</li> <li>• The email address of the sender who sent the message.</li> <li>• The email addresses of the recipients for whom the message was delivered and later attempted for remediation.</li> <li>• The date and time when the message was sent to the recipient.</li> </ul> </li> </ul> |

## Message Filters Page

The Message Filters page shows information about the top message filter matches (which message filter had the most matching messages) in two forms: a bar chart and a tabular representation.

Using the bar chart, you can find the message filters that are being triggered the most by incoming and outgoing messages. The tabular representation shows the top message filters and the number of matches for the respective message filters. Click on the number to view a list of all the messages that are included in that number using Message Tracking.

You can select a time range on which to report, such as an hour, a week, or a custom range. As with all reports, you can export the data for the graphs or the details listing to CSV format via the **Export** link.

## High Volume Mail Page



---

**Note** The High Volume Mail page shows data only from message filters that use Header Repeats rule.

---

The High Volume Mail page contains the following reports in the form of bar charts:

- **Top Subjects.** You can use this chart to understand the top subjects of messages that AsyncOS received.
- **Top Envelope Senders.** You can use this chart to understand the top envelope senders of messages that AsyncOS received.

- **Top Message Filters by Number of Matches.** You can use this chart to understand the top message filter (that uses Header Repeats rule) matches.

The High Volume Mail page also provides a tabular representation of the top message filters and the number of matches for the respective message filters. Click the number to view a list of all the messages that are included in that number using Message Tracking.

You can select a time range on which to report, such as an hour, a week, or a custom range. As with all reports, you can export the data for the graphs or the details listing to CSV format via the **Export** link.

## Content Filters Page

The Content Filters page shows information about the top incoming and outgoing content filter matches (which content filter had the most matching messages) in two forms: a bar chart and a listing. Using the Content Filters page, you can review your corporate policies on a per-content filter or per-user basis and answer questions like:

- Which content filter is being triggered the most by incoming or outgoing mail?
- Who are the top users sending or receiving mail that is triggering a particular content filter?

You can click the name of the content filter in the listing to view more information about that filter on the Content Filter detail page.

### Related Topics

- [Content Filter Details, on page 903](#)

## Content Filter Details

Click the content filter name link to view the content filter details. The Content Filter detail page displays matches for that filter over time, as well as matches by internal user.

In the Matches by Internal Users section, you can click the name of a user to view that internal user's (email address) Internal User details page (see [#unique\\_1508](#)).

## Safe Print Page

You can use the Safe Print report page to view:

- Number of safe-printed attachments based on the file type in graphical format.
- Summary of safe-printed attachments based on the file type in tabular format.

In the 'Summary of Safe Print File Types' section, click the total number of safe-printed attachments to view the message details in Message Tracking.

## Advanced Phishing Protection Report Page

The **Reports > Mail Flow Summary > Advanced Phishing Protection** report page displays the following:

- Total number of messages successfully forwarded to the Cisco Advanced Phishing Protection cloud service.

- Total number of messages that are not forwarded to the Cisco Advanced Phishing Protection cloud service.



---

**Note** If the forwarding of message metadata has failed, you must validate the configurations of the Advanced Phishing Protection feature. For more information, see [How to Integrate Email Gateway with the Cisco Advanced Phishing Protection Cloud Service, on page 762](#)

---

You can use the Advanced Phishing Protection report page to view:

- Total number of messages that are sent from all email gateways at the organizational level to the Cisco Advanced Phishing Protection cloud service in a dashboard.
- Total number of messages attempted to be forwarded to the Cisco Advanced Phishing Protection cloud service, in a graphical format.

To view the detailed information on the metadata of the message that is forwarded to the Cisco Advanced Phishing Protection cloud service, click on the link and login to the Cisco Advanced Phishing Protection cloud service. For more information, see [Monitoring Message Metadata on the Cisco Advanced Phishing Protection Cloud Service, on page 768](#).

## Mail Policy Details Report Page

You can use the Mail Policy Details report page to view:

- Top incoming messages that matched a configured mail policy in graphical and tabular format.
- Top outgoing messages that matched a configured mail policy in graphical and tabular format.

In the ‘Incoming Policies’ section, click the total number of incoming messages that matched a specific mail policy to view the message details in Message Tracking.

In the ‘Outgoing Policies’ section, click the total number of incoming messages that matched a specific mail policy to view the message details in Message Tracking.

## Reporting Overview

Reporting in AsyncOS involves three basic actions:

- You can create Scheduled Reports to be run on a daily, weekly, or monthly basis.
- You can generate a report immediately (“on-demand” report).
- You can view archived versions of previously run reports (both scheduled and on-demand).

Configure scheduled and on-demand reports via the Monitor > Scheduled Reports page. View archived reports via the Monitor > Archived Reports page.

Your email gateway will retain the most recent reports it generates, up to 1000 total versions for all reports. You can define as many recipients for reports as you want, including zero recipients. If you do not specify an email recipient, the system will still archive the reports. If you need to send the reports to a large number of addresses, however, it may be easier to create a mailing list rather than listing the recipients individually.



By default, the email gateway archives the twelve most recent reports of each scheduled report. Reports are stored in the /saved\_reports directory of the email gateway. (See [FTP, SSH, and SCP Access](#), on page 1303 for more information.)

### Related Topics

- [Scheduled or Archived Report Types](#), on page 905
- [Setting the Return Address for Reports](#), on page 906

## Scheduled or Archived Report Types

You can choose from the following report types:

- AMP Reputation
- Advanced Malware Protection File Analysis
- Advanced Malware Protection File Retrospection
- Connections by Country
- Content Filters
- DLP Incident Summary
- DMARC Verification Report
- Delivery Status
- Executive Summary
- External Threat Feeds
- Forged Email Detection
- High Volume Mail
- Inbound SMTP Authentication
- Marco Detection
- Mail Flow Summary: Incoming
- Mailbox Auto Remediation
- Mail Flow Details (Outgoing senders: domain)
- Mail Flow Summary: Outgoing
- Message Filters
- My Email Reports
- Outgoing Destinations
- Rate Limits
- Sender Domain Reputation
- Sender Groups
- System Capacity
- TLS Encryption
- User Mail Summary
- URL Filtering
- Outbreak Filters
- Virus Filtering
- Web Interaction

Each of the reports consists of a summary of the corresponding Email Security Monitor page.

### Related Topics

- [Notes on Reports, on page 906](#)

## Notes on Reports

Content Filter reports in a PDF format are limited to a maximum of 40 content filters. You can obtain the full listing via reports in a CSV format.



---

**Note** To generate PDFs in Chinese, Japanese, or Korean on Windows computers, you must also download the applicable Font Pack from Adobe.com and install it on your local computer.

---

## Setting the Return Address for Reports

To set the return address for reports, see [Configuring the Return Address for Email Gateway Generated Messages, on page 1044](#). From the CLI, use the `addressconfig` command.

## Managing Reports

You can create, edit, delete, and view archived scheduled reports. You can also run a report immediately (on-demand report). Managing and viewing these reports is discussed below.



---

**Note** When in Cluster Mode, you are unable to view reports. You may view reports when in machine mode.

---

The Monitor > Scheduled Reports page shows a listing of the scheduled reports already created on the email gateway.

### Related Topics

- [Scheduled Reports, on page 906](#)
- [Archived Reports, on page 908](#)

## Scheduled Reports

Scheduled reports can be scheduled to run on a daily, weekly, or monthly basis. You can select a time at which to run the report. Regardless of when you run a report, it will only include data for the time period that you specify, for example the past 3 days or the previous calendar month. Note that a daily report scheduled to run at 1AM will contain data for the previous day, midnight to midnight.

Your email gateway ships with a default set of scheduled reports—you can use, modify, or delete any of them.

### Related Topics

- [Scheduling a Report to be Generated Automatically , on page 907](#)
- [Editing Scheduled Reports , on page 907](#)

- [Deleting Scheduled Reports, on page 908](#)

## Scheduling a Report to be Generated Automatically

### Procedure

---

- Step 1** On the Monitor > Scheduled Reports page, click **Add Scheduled Report**.
- Step 2** Select a report type. Depending on the report type you select, different options may be available. For more information about the available types of scheduled reports, see [Scheduled or Archived Report Types, on page 905](#).
- Step 3** Enter a descriptive title for the report. AsyncOS does not verify the uniqueness of report names. To avoid confusion, do not create multiple reports with the same name.
- Step 4** Select a time range for the report data. (This option is not available for Outbreak Filters reports.)
- Step 5** Select a format for the report:
- PDF. Create a formatted PDF document for delivery, archival, or both. You can view the report as a PDF file immediately by clicking Preview PDF Report. For information about generating PDFs in languages other than English, see the [Notes on Reports, on page 906](#).
  - CSV. Create an ASCII text file that contains the tabular data as comma-separated values. Each CSV file may contain up to 100 rows. If a report contains more than one type of table, a separate CSV file is created for each table.
- Step 6** Specify the report options, if available. Some reports do not have report options.
- Step 7** Specify scheduling and delivery options. If you do not specify an email address, the report is archived but is not sent to any recipients.
- Note** If you are sending reports to an external account (such as Yahoo or Gmail, etc.), you may need to add the reporting return address to the external account's allowed list to prevent report emails from being incorrectly classified as spam.
- Step 8** Click **Submit**. Commit your changes.
- 

## Editing Scheduled Reports

### Procedure

---

- Step 1** Click the report title in the listing on the Services > Centralized Reporting page.
- Step 2** Make your changes.
- Step 3** Submit and commit your changes.
-

## Deleting Scheduled Reports

### Procedure

---

**Step 1** On the Services > Centralized Reporting page, select the check boxes corresponding to the reports that you want to delete.

**Note** Select the All check box to remove all scheduled reports.

**Step 2** Click **Delete**.

**Step 3** Confirm the deletion and then commit your changes.

Any archived versions of deleted reports are *not* automatically deleted.

---

## Archived Reports

The **Monitor > Archived Reports** page lists the available archived reports. You can view a report by clicking its name in the Report Title column. You can generate a report immediately by clicking **Generate Report Now**.

Use the Show menu to filter which type of reports is listed. Click the column headings to sort the listing.

Archived reports are deleted automatically — up to 30 instances of each scheduled report (up to 1000 reports) are kept and as new reports are added, older ones are deleted to keep the number at 1000. The 30 instances limit is applied to each individual scheduled report, not report type.

### Related Topics

- [Generating On-Demand Reports, on page 908](#)

## Generating On-Demand Reports

You can generate a report without scheduling it. These on-demand reports are still based on a specified time frame, but they are generated immediately.

### Procedure

---

**Step 1** Click **Generate Report Now** on the Archived Reports page.

**Step 2** Select a report type and edit the title if desired. AsyncOS does not verify the uniqueness of report names. To avoid confusion, do not create multiple reports with the same name.

For more information about the available types of scheduled reports, see [Scheduled or Archived Report Types, on page 905](#).

**Step 3** Select a time range for the report data. (This option is not available for Virus Outbreak reports.)

If you create a custom range, the range will appear as a link. To modify the range, click the link.

**Step 4** Select a format for the report.

- PDF. Create a formatted PDF document for delivery, archival, or both. You can view the report as a PDF file immediately by clicking Preview PDF Report.

For information about generating PDFs in languages other than English, see the [Notes on Reports, on page 906](#).

- CSV. Create an ASCII text file that contains the tabular data as comma-separated values. Each CSV file may contain up to 100 rows. If a report contains more than one type of table, a separate CSV file is created for each table. Specify any report options.

- Step 5** Select whether to archive the report (if so, the report will shown on the Archived Reports page).
- Step 6** Specify whether to email the report and to which email addresses to send the report.
- Step 7** Click **Deliver this Report** to generate the report and deliver it to recipients or archive it.
- Step 8** Commit your changes.

---

## Troubleshooting Email Reports

- [Link to Message Tracking Gives Unexpected Results , on page 909](#)
- [File Analysis Details in the Cloud Are Incomplete, on page 909](#)

### Link to Message Tracking Gives Unexpected Results

#### Problem

Drilling down from a report to view details in message tracking yields unexpected results.

#### Solution

This can occur if reporting and message tracking were not simultaneously enabled, functioning properly, and storing data locally (as opposed to being stored centrally on a Cisco Secure Email and Web Manager). Data for each feature (reporting and message tracking) is stored only while that feature is enabled and functioning on that email gateway, independently of whether the other feature (reporting or message tracking) is enabled and functioning. Therefore, reports may include data that is not available in Message Tracking and vice-versa.

### File Analysis Details in the Cloud Are Incomplete

#### Problem

Complete file analysis results in the public cloud are not available for files uploaded from other email gateways in my organization.

#### Solution

Be sure to group all email gateways that will share file analysis result data. See [\(Public Cloud File Analysis Services Only\) Configuring Appliance Groups , on page 489](#). This configuration must be done on each appliance in the group.





## CHAPTER 35

# Tracking Messages

---

This chapter contains the following sections:

- [Message Tracking Overview](#) , on page 911
- [Enabling Message Tracking](#), on page 911
- [Searching for Messages on the Legacy Interface](#) , on page 912
- [Searching for Email Messages on the New Web Interface](#), on page 915
- [Working with Message Tracking Search Results](#) , on page 917
- [Checking Message Tracking Data Availability](#) , on page 920
- [Troubleshooting Message Tracking](#), on page 921

## Message Tracking Overview

Message tracking helps resolve help desk calls by giving a detailed view of message flow. For example, if a message was not delivered as expected, you can determine if it was found to contain a virus or placed in a spam quarantine — or if it is located somewhere else in the mail stream.

You can search for a particular email message or a group of messages that match criteria that you specify.



---

**Note** You cannot use message tracking to read the content of messages.

---

## Enabling Message Tracking



---

**Note** Message tracking data is preserved only for messages that are processed after you enable this feature.

---

### Before you Begin

- In order to search for and display attachment names in Message Tracking and view attachment names in log files, you must configure and enable at least one body scanning process, such as a message filter or content filter.

- To support searching by subject, log files must be configured to record subject headers. For more information, see [Logging, on page 1145](#).
- If you are setting up Centralized Tracking: Set up your Cisco Secure Manager Email and Web Gateway to support centralized message tracking for this email gateway. See the Cisco Secure Manager Email and Web Gateway User Guide.

### Procedure

---

**Step 1** Click **Security Services > Message Tracking**.

Use this path even if you do not plan to centralize this service.

**Step 2** Select **Enable Message Tracking Service**.

**Step 3** If you are enabling message tracking for the first time after running the System Setup Wizard, review the end-user license agreement, and click **Accept**.

**Step 4** Choose a Message Tracking Service:

| Option               | Description  |
|----------------------|--|
| Local Tracking       | Use message tracking on this email gateway.  |
| Centralized Tracking | Use Cisco Secure Manager Email and Web Gateway to track messages for multiple email gateways including this one. |

**Step 5** (Optional) Select the check box to save information for rejected connections.

For best performance, leave this setting disabled.

**Step 6** Submit and commit your changes.

---

### What to do next

If you selected Local Tracking:

- Choose who can access content related to DLP violations. See [Controlling Access to Sensitive Information in Message Tracking, on page 977](#).
- (Optional) Adjust the disk space allocation for storing messages. See [Managing Disk Space , on page 1026](#).

## Searching for Messages on the Legacy Interface

### Procedure

---

**Step 1** Choose **Monitor > Message Tracking**

**Step 2** Enter search criteria.



- To view all options, click the **Advanced** link.
- Tracking does not support wildcard characters or regular expressions.
- Tracking searches are not case sensitive.
- Unless otherwise specified, the query is an “AND” search: The query returns messages that match *all* conditions specified in the search fields. For example, if you specify text strings for the envelope recipient and the subject line parameters, the query returns only messages that match *both* the specified envelope recipient *and* the subject line.
- Search criteria include:

| Option   | Description   |
|--|---|
| <b>Envelope Sender</b>                           | Select <b>Begins With</b> , <b>Is</b> , or <b>Contains</b> , then enter an email address, username, or domain of a message sender to find.<br><br>You can enter any character(s). No validation of your entry is performed.   |
| <b>Envelope Recipient</b>                        | Select <b>Begins With</b> , <b>Is</b> , or <b>Contains</b> , and enter an email address, username, or domain of a message recipient to find.<br><br>You can enter any character(s). No validation of your entry is performed.   |
| <b>Subject</b>                                   | Select <b>Begins With</b> , <b>Is</b> , or <b>Contains</b> , and enter a text string to search for in the message subject line.<br><br><b>Warning:</b> Do not use this type of search in environments where regulations prohibit such tracking.   |
| <b>Message Received</b>                          | Specify a date and time range.<br><br>If you do not specify a date, the query returns data for all dates. If you specify a time range only, the query returns data for that time range across all available dates.<br><br>Use the local date and time that the message was received by the email gateway. |
| <b>Advanced options:</b>                         |   |
| <b>Sender IP Address/ Domain / Network Owner</b> | Specify the IP address, domain, or network owner of a remote host.<br><br>You can search within rejected connections only or search all messages.   |

| Option                           | Description   |
|----------------------------------|---|
| <p><b>Attachment</b></p>         | <p>Select <b>Begins With</b>, <b>Is</b>, or <b>Contains</b>, and enter an ASCII or Unicode text string for one attachment to find. Leading and trailing spaces are <i>not</i> stripped from the text you enter.</p> <p>You can search for messages by attachment filenames only if you have performed:</p> <ul style="list-style-type: none"> <li>• Body scan using a message filter</li> <li>• Body scan using a content filter</li> <li>• Advanced Malware Protection (AMP) scan.</li> </ul> <p>For more information about identifying files based on SHA-256 hash, see <a href="#">Identifying Files by SHA-256 Hash</a> , on page 499.</p> <p>You can search for messages that are detected as malicious by the Advanced Malware Protection engine based on the threat name. In the <b>Threat Name</b> field, enter <i>Simple_Custom_Detection</i> or <i>Custom_Threshold</i> to search for messages that are detected as malicious based on the Custom Detection and Custom Threshold categories. You can also search for messages by the virus name if a particular file is detected as virus positive by the Advanced Malware Protection engine.</p> |
| <p><b>Message Event</b></p>      | <p>Select one or more message processing events. For example, you can search for messages that have been delivered, quarantined, or hard bounced.</p> <p>Message events are added with an “OR” operator: Selecting multiple events finds messages that match <i>any</i> of the conditions you specify.</p>  |
| <p><b>Message ID Header</b></p>  | <p>Enter a text string for the SMTP Message-ID header.</p> <p>This RFC 822 message header uniquely identifies each email message. It is inserted in the message when the message is first created.</p>  |
| <p><b>Cisco IronPort MID</b></p> | <p>Enter a message number to search for. An IronPort MID uniquely identifies each email message on the email gateway.</p>   |
| <p>Cisco IronPort Host</p>       | <p>Select an Email Security appliance to restrict the search to messages processed by that email gateway, or select all email gateways.</p>   |

**Step 3** Click **Search** to submit the query.

The query results are displayed at the bottom of the page.

**What to do next**

**Related Topics**

- [Working with Message Tracking Search Results](#) , on page 917

# Searching for Email Messages on the New Web Interface

The tracking service of the email gateway lets you search for a particular email message or group of messages that match specified criteria, such as the message subject line, date and time range, envelope sender or recipient, or processing event (for example, whether the message was virus positive, spam positive, hard bounced, delivered, and so forth). Message tracking gives you a detailed view of message flow. You can also drill down on particular email messages to see message details, such as the processing events, attachment names, or the envelope and header information.



---

**Note** Although the tracking component provides detailed information about individual email messages, you cannot use it to read the content of messages.

---

## Procedure

---

**Step 1** Click **Tracking** tab.

**Step 2** Select **Messages** tab or **Rejected Connections** tab to narrow your search results.

**Note** You can search for rejected connections based on the sender IP address, domain or network owner.

**Step 3** (Optional) Click the **Advanced Search** to display additional search options.

**Step 4** Enter the following search criteria:

**Note** Tracking searches do not support wildcard characters or regular expressions. Tracking searches are not case sensitive.

- [For Messages and Rejected Connections] **Message Received:** Specify a date and time range for the query using “Last Day,” “Last 7 Days,” or “Custom Range.” Use the “Last Day” option to search for messages within the past 24 hours, and use the “Last 7 Days” option to search for messages within the past full seven days, plus the time that has passed on the current day.

If you do not specify a date, the query returns data for all dates. If you specify a time range only, the query returns data for that time range across all available dates. If you specify the current date and 23:59 as the end date and time, the query returns all data for the current date.

Dates and times are converted to GMT format when they are stored in the database. When you view dates and times on an email gateway, they are displayed in the local time of the email gateway.

Messages appear in the results only after they have been logged on the email gateway and retrieved by the Cisco Secure Email and Web Gateway. Depending on the size of logs and the frequency of polling, there could be a small gap between the time when an email message was sent and when it actually appears in tracking and reporting results.

- **Envelope Sender:** Select Begins With, Is, or Contains, and enter a text string to search for in the envelope sender. You can enter email addresses, user names, or domains. Use the following formats:
  - For email domains: *example.com*, *[203.0.113.15]*, *[ipv6:2001:db8:80:1::5]*
  - For full email addresses: *user@example.com*, *user@[203.0.113.15]* or *user@[ipv6:2001:db8:80:1::5]*.

- You can enter any character(s). No validation of your entry is performed.
- **Subject:** Select Begins With, Is, Contains, or Is Empty, and enter a text string to search for in the message subject line.
- **Envelope Recipient:** Select Begins With, Is, or Contains, and enter text to search for in the envelope recipient. You can enter email addresses, user names, or domains.

If you use the alias table for alias expansion on your email gateways, the search finds the expanded recipient addresses rather than the original envelope addresses. In all other cases, message tracking queries find the original envelope recipient addresses.

Otherwise, valid search criteria for Envelope Recipient are the same as those for Envelope Sender.

You can enter any character(s). No validation of your entry is performed.

- **Attachment Name:** Select Begins With, Is, or Contains, and enter an ASCII or Unicode text string for one Attachment Name to find. Leading and trailing spaces are not stripped from the text you enter.
- **Reply-To:** Select Begins With, Is, or Contains, and enter a text string to search for messages based on the `Reply-To` header of the message.
- **File SHA256:** Enter a File SHA-256 value of the message.

For more information about identifying files based on SHA-256 hash, see [Identifying Files by SHA-256 Hash](#), on page 881.

- **Cisco Host:** Select All Host to search across all email gateways or select the required email gateway from the drop-down menu.
- **Message ID Header and Cisco MID:** Enter a text string for the message ID header, the Cisco IronPort message ID (MID), or both.
- [For Messages and Rejected Connections] **Sender IP Address/ Domain/ Network Owner:** Enter a sender IP address, domain or network owner details.
  - An IPv4 address must be 4 numbers separated by a period. Each number must be a value from 0 to 255. (Example: 203.0.113.15).
  - An IPv6 address consists of 8 sets of 16-bit hexadecimal values separated by colons.
 

You can use zero compression in one location, such as 2001:db8:80:1::5.
  - **Message Event:** Select the events to track. For example, you can search for messages that have been delivered, quarantined, or hard bounced. Message events are added with an “OR” operator: Selecting multiple events finds messages that match any of the conditions you specify.

You do not need to complete every field. Except for the Message Event options, the query is an “AND” search. The query returns messages that match the “AND” conditions specified in the search fields. For example, if you specify text strings for the envelope recipient and the subject line parameters, the query returns only messages that match both the specified envelope recipient and the subject line.

#### Step 5 Click **Search**.

Each row corresponds to an email message. Scroll down to load more messages in the view.

If necessary, you can refine your search by entering new search criteria, and run the query again. Alternatively, you can refine the search by narrowing the result set, as described in the following section.

---

#### What to do next

- [Working with Message Tracking Search Results](#) , on page 917

## Working with Message Tracking Search Results

Keep the following points in mind:

- Messages appear in the results only after they have been logged on the email gateway and retrieved by the Cisco Secure Manager Email and Web Gateway. Depending on the size of logs and the frequency of polling, there could be a small gap between the time when an email message was sent and when it actually appears in tracking and reporting results.
- For information about searches involving Advanced Malware Protection (file reputation scanning and file analysis), see [About Message Tracking and Advanced Malware Protection Features](#) , on page 500.

Actions you can take when working with search results:

- Show more than 250 search results by returning to the search criteria, clicking Advanced, scrolling to the Query Settings, and setting the maximum number of results to 1000.
- Show more results per page by choosing an option from the top right side of the search results section.
- Navigate through multiple pages of search results from the top right side of the search results section.
- Narrow your search results by floating the cursor over a value in the search results that you want to add as a condition. If an orange highlight appears, you can click that value to narrow the search by that criterion. This adds the additional criterion to the search criteria. For example, if you search for messages sent to a particular recipient, you can then click on a sender name in the search results to find all messages to that recipient from that sender within the time range (and meeting any other criteria) that you originally specified.
- If more than 1000 messages match your search criteria, you can click Export All (a link at the top right of the search results section) and export up to 50,000 search results as a comma-separated values file and work with the data in another application.
- View more details for a message by clicking Show Details in the row for that message. A new browser window opens with the message details.
- For quarantined messages, you can click a link in the message tracking search results to view details such as the reason the message was quarantined.
- Remediate the malicious messages from the user mailbox using the Mailbox Search and Remediate action. For more information, see [Search and Remediate Messages in the Mailboxes](#), on page 590



---

#### Note

If you clicked a link in a report page to view message details in Message Tracking, and the set of results is not what you expected, this can occur if reporting and tracking were not both simultaneously and continuously enabled during the time period you are reviewing.

---

**Related Topics**

- [Message Tracking Details](#) , on page 918

**Message Tracking Details**

| Item                                 | Description   |
|--------------------------------------|---|
| Envelope and Header Summary section: |   |
| <b>Received Time</b>                 | Time that the email gateway received the message.<br>Dates and times are displayed using the local time configured on the email gateway.  |
| <b>MID</b>                           | Unique IronPort message ID.   |
| <b>Message Size</b>                  | Message size.   |
| <b>Subject</b>                       | Subject line of the message.<br>The subject line in the tracking results may have the value “(No Subject)” if the message does not have a subject, or if log files are not configured to record subject headers. For more information, see <a href="#">Logging, on page 1145</a>  |
| <b>Envelope Sender</b>               | Address of the sender in the SMTP envelope.   |
| <b>Envelope Recipients</b>           | If your deployment uses the alias table for alias expansion, the search finds the expanded recipient addresses rather than the original envelope addresses. For more information about Alias Tables, see “Creating Alias Tables” in the “Configuring Routing and Delivery Features” chapter .<br><br>In all other cases, message tracking queries find the original envelope recipient addresses. |
| <b>Message ID Header</b>             | The RFC 822 message header.   |
| <b>SMTP Auth User ID</b>             | SMTP authenticated username of the sender, if the sender used SMTP authentication to send the message. Otherwise, the value is “N/A.”   |

| Item   | Description   |
|--|---|
| <b>Attachments</b>   | <p>The names of files attached to the message.</p> <p>Messages that contain at least one attachment with the queried name will appear in the search results.</p> <p>Some attachments may not be tracked. For performance reasons, scanning of attachment names occurs only as part of other scanning operations, for example message or content filtering, DLP, or disclaimer stamping. Attachment names are available only for messages that pass through body scanning while the attachment is still attached. Situations in which an attachment name will not appear in search results include (but are not limited to):</p> <ul style="list-style-type: none"> <li>• If the system only uses content filters, and a message is dropped or its attachment is stripped by anti-spam or anti-virus filters</li> <li>• If message splintering policies strip the attachment from some messages before body scanning occurs.</li> </ul> <p>For performance reasons, the names of files within attachments, such as OLE objects or archives such as .ZIP files, are not searched.</p> |
| [New Web Interface Only] <b>Message Event</b>  | Select multiple events to include messages that match each event type.  |
| Sending Host Summary section   |   |
| <b>Reverse DNS Hostname</b>  | Name of the sending host, as verified by reverse DNS (PTR) lookup.  |
| <b>IP Address</b>  | IP address of the sending host.   |
| <b>IP Reputation Score</b>   | <p>IP reputation score. The range is from 10 (likely a trustworthy sender) to -10 (apparent spammer). A score of “None” indicates that there was no information about this host at the time the message was processed.</p> <p>For more information about IP Reputation Service, see <a href="#">IP Reputation Filtering</a> , on page 81</p>  |
| Processing Details section   |   |
| <p><b>Summary information</b></p> <p>(If one of the tabs below is displayed, this information is displayed in a tab. Summary information always displays.)</p> | <p>The Summary tab displays status events logged during the processing of the message.</p> <p>Entries include information about Mail Policy processing, such as Anti-Spam and Anti-Virus scanning, and other events such as message splitting and custom log entries added by a content or message filter.</p> <p>If the message was delivered, the details of the delivery are displayed here.</p> <p>The last recorded event is highlighted in the processing details.</p>  |

| Item                           | Description  |
|--------------------------------|--|
| <b>DLP Matched Content tab</b> | <p>This tab displays only for messages that were caught by DLP policies.</p> <p>This tab includes information about the match, as well as the sensitive content that triggered the DLP policy match.</p> <p>You must configure the email gateway to display this information. See <a href="#">Displaying Sensitive DLP Data in Message Tracking</a> , on page 531.</p> <p>To control access to this tab, see <a href="#">Controlling Access to Sensitive Information in Message Tracking</a>, on page 977.</p>   |
| <b>URL Details tab</b>         | <p>This tab displays only for messages caught by URL Reputation and URL Category content filters and by outbreak filters.</p> <p>This tab displays the following information:</p> <ul style="list-style-type: none"> <li>• The reputation score or category associated with the URL</li> <li>• The action performed on the URL (rewrite, defang, or redirect)</li> <li>• If a message contains multiple URLs, which URL has triggered the filter action.</li> </ul> <p>You must configure the email gateway to display this information. See <a href="#">Displaying URL Details in Message Tracking</a> , on page 457.</p> <p>To control access to this tab, see <a href="#">Controlling Access to Sensitive Information in Message Tracking</a>, on page 977.</p> |

#### Related Topics

- [Searching for Messages on the Legacy Interface](#) , on page 912

## Checking Message Tracking Data Availability

You can determine the date range that your message tracking data includes, as well as identify any missing intervals in that data.

#### Procedure

- 
- Step 1** [New Web Interface Only] Click the gear icon on the upper right corner of the page to load the legacy web interface.
- Step 2** Select **Monitor > Message Tracking**.
- Step 3** Look for **Data in time range:** in the upper right corner of the Search box.
- Step 4** Click the value shown for **Data in time range:**.
- 

#### What to do next

#### Related Topics



- [About Message Tracking and Upgrades](#) , on page 921

## About Message Tracking and Upgrades

New message tracking features may not apply to messages that were processed before upgrade, because the required data may not have been retained for those messages. For possible limitations related to message tracking data and upgrades, see the Release Notes for your release.

## Troubleshooting Message Tracking

### Related Topics

- [Attachments Do Not Appear in Search Results](#) , on page 921
- [Expected Messages Are Missing from Search Results](#) , on page 921

## Attachments Do Not Appear in Search Results

### Problem

Attachment names are not found and displayed in search results.

### Solution

See configuration requirements at [Enabling Message Tracking, on page 911](#) . Also see limitations for attachment name searches in [Message Tracking Details](#) , on page 918.

## Expected Messages Are Missing from Search Results

### Problem

Search results did not include messages that should have met the criteria.

### Solution

- Results for many searches, and especially searches that involve Message Events, depend on your email gateway configuration. For example, if you search for a URL Category for which you have not filtered, no results will be found, even if a message contains a URL in that category. Verify that you have configured the email gateway properly to achieve the behavior that you expected. For example, check your mail policies, content and message filters, and quarantine settings.
- If expected information is missing after you clicked a link in a report, see [Troubleshooting Email Reports, on page 909](#).





## CHAPTER 36

# Policy, Virus, and Outbreak Quarantines

---

This chapter contains the following sections:

- [Overview of Policy, Virus, and Outbreak Quarantines, on page 923](#)
- [Managing Policy, Virus, and Outbreak Quarantines, on page 925](#)
- [Working with Messages in Policy, Virus, or Outbreak Quarantines, on page 933](#)

## Overview of Policy, Virus, and Outbreak Quarantines

“Policy, virus and outbreak quarantines” includes all non-spam quarantines, including the File Analysis quarantine.

When an email gateway detects possible malware or content that is not allowed by your organization in incoming or outgoing messages, it can send those messages to a quarantine instead of deleting them immediately. A quarantine holds these messages safely on the email gateway or on a Cisco Secure Email and Web Manager for a period of time, to allow a human being to review them, or to await an update that will better evaluate the safety of the message.

Examples of how non-spam quarantines can be used in your organization:

- **Policy enforcement.** Let Human Resources personnel or the Legal department review messages that may contain offensive, confidential, or otherwise disallowed information.
- **Virus quarantine.** Store messages that are marked as infected, encrypted, or not scannable by the anti-virus scanning engine to prevent the spread of viruses to your users.
- **Outbreak prevention.** Hold messages that are flagged by the Outbreak Filters as possibly being part of a viral outbreak or small-scale malware attack until an anti-virus or anti-spam update is released.
- **File Analysis quarantine.** Store messages that have attachments that may contain malware, and that have been sent for analysis, until a verdict is reached.

### Related Topic

- [Spam Quarantine, on page 943](#)

## Quarantine Types

| Quarantine Type             | Quarantine Name                      | Created by the System by Default? | Description  | More Information  |
|-----------------------------|--------------------------------------|-----------------------------------|--|---|
| Advanced Malware Protection | File Analysis                        | Yes                               | Holds messages that are sent for file analysis, until a verdict is returned.   | <ul style="list-style-type: none"> <li>• <a href="#">Managing Policy, Virus, and Outbreak Quarantines</a></li> <li>• <a href="#">Working with Messages in Policy, Virus, or Outbreak Quarantines</a></li> </ul> |
| Virus                       | Virus                                | Yes                               | Holds messages that may be transmitting malware, as determined by the anti-virus engine.   |   |
| Outbreak                    | Outbreak                             | Yes                               | Holds messages caught by Outbreak Filters as potentially being spam or malware.  |   |
| Policy                      | Policy                               | Yes                               | Holds messages caught by message filters, content filters, and DLP message actions.<br><br>A default Policy quarantine has been created for you.   |   |
|                             | Unclassified                         | Yes                               | Holds messages only if a quarantine that is specified in a message filter, content filter, or DLP message action has been deleted.<br><br>You cannot assign this quarantine to any filter or message action. |   |
|                             | (Policy quarantines that you create) | No                                | Policy quarantines that you create for use in message filters, content filters, and DLP message actions.   |   |

| Quarantine Type | Quarantine Name | Created by the System by Default? | Description  | More Information                             |
|-----------------|-----------------|-----------------------------------|--|--|
| Spam            | Spam            | Yes                               | <p>Holds spam or suspected spam messages for the message's recipient or an administrator to review.</p> <p>The spam quarantine is not included in the group of policy, virus, and outbreak quarantines and is managed separately from all other quarantines.</p> | <a href="#">Spam Quarantine, on page 943</a> |

## Managing Policy, Virus, and Outbreak Quarantines

- [Disk Space Allocation for Policy, Virus, and Outbreak Quarantines](#) , on page 925
- [Retention Time for Messages in Quarantines](#) , on page 926
- [Default Actions for Automatically Processed Quarantined Messages](#) , on page 927
- [Checking the Settings of System-Created Quarantines](#) , on page 927
- [Configuring Policy, Virus, and Outbreak Quarantines](#) , on page 927
- [About Editing Policy, Virus, and Outbreak Quarantine Settings](#) , on page 929
- [Determining the Filters and Message Actions to Which a Policy Quarantine Is Assigned](#) , on page 929
- [About Deleting Policy Quarantines](#) , on page 930
- [Monitoring Quarantine Status, Capacity, and Activity](#) , on page 930
- [Policy Quarantine Performance](#) , on page 931
- [Alerts About Quarantine Disk-Space Usage](#) , on page 932
- [Policy Quarantines and Logging](#) , on page 932
- [About Distributing Message Processing Tasks to Other Users](#) , on page 932
- [About Policy, Virus, and Outbreak Quarantines in Cluster Configurations](#) , on page 933
- [About Centralized Policy, Virus, and Outbreak Quarantines](#) , on page 933

## Disk Space Allocation for Policy, Virus, and Outbreak Quarantines

For disk space information for policy, virus, and outbreak quarantines, see [Managing Disk Space](#) , on page 1026.

Policy, virus, and outbreak quarantines consume some disk space on the email gateway even if the quarantines are centralized.

Messages in multiple quarantines consume the same amount of disk space as a message in a single quarantine.

If Outbreak Filters and Centralized Quarantines are both enabled:

- All disk space on the email gateway that would have been allocated to local policy, virus, and outbreak quarantines is used instead to hold copies of messages in the Outbreak quarantine, in order to scan those messages each time outbreak rules are updated.
- The disk space on the Cisco Secure Email and Web Manager for messages in the Outbreak quarantine from a particular managed

### Related Topics

- [Monitoring Quarantine Status, Capacity, and Activity](#) , on page 930
- [Alerts About Quarantine Disk-Space Usage](#) , on page 932
- [Retention Time for Messages in Quarantines](#) , on page 926

## Retention Time for Messages in Quarantines

Messages are automatically removed from the quarantine under the following circumstances:

- Normal Expiration—the configured retention time is met for a message in the quarantine. You specify a retention time for messages in each quarantine. Each message has its own specific expiration time, displayed in the quarantine listing. Messages are stored for the amount of time specified unless another circumstance described in this topic occurs.



---

**Note** The normal retention time for messages in the Outbreak Filters quarantine is configured in the Outbreak Filters section of each mail policy, not in the outbreak quarantine.

---

- Early Expiration—messages are forced from quarantines before the configured retention time is reached. This can happen when:

- The size limit for all quarantines, as defined in [Disk Space Allocation for Policy, Virus, and Outbreak Quarantines](#) , on page 925, is reached.

If the size limit is reached, the oldest messages, regardless of quarantine, are processed and the default action is performed for each message, until the size of all quarantines is again less than the size limit. The policy is First In First Out (FIFO). Messages in multiple quarantines will be expired based on their latest expiration time.

(Optional) You can configure individual quarantines to be exempt from release or deletion because of insufficient disk space. If you configure all quarantines to be exempt and the disk space reaches capacity, messages in the quarantine will be delivered to make room for new messages.

You will receive alerts at disk-space milestones. See [Alerts About Quarantine Disk-Space Usage](#) , on page 932.

- You delete a quarantine that still holds messages.

When a message is automatically removed from a quarantine, the default action is performed on that message. See [Default Actions for Automatically Processed Quarantined Messages](#) , on page 927.



---

**Note** In addition to the above scenarios, messages can be automatically removed from quarantine based on the result of scanning operations (outbreak filters or file analysis.)

---

#### Effects of Time Adjustments on Retention Time

- Daylight savings time and email gateway time zone changes do not affect the retention period.
- If you change the retention time of a quarantine, only new messages will have the new expiration time.
- If the system clock is changed, messages that should have expired in the past will expire at the next most appropriate time.
- System clock changes do not apply to messages that are in the process of being expired.

## Default Actions for Automatically Processed Quarantined Messages

The default action is performed on messages in a policy, virus, or outbreak quarantine when any situation described in [Retention Time for Messages in Quarantines](#) , on page 926, occurs.

There are two primary default actions:

- Delete—The message is deleted.
- Release—The message is released for delivery.

Upon release, messages may be rescanned for threats. For more information, see [About Rescanning of Quarantined Messages](#) , on page 939.

In addition, messages released before their expected retention time has passed can have additional operations performed on them, such as adding an X-Header. For more information, see [Configuring Policy, Virus, and Outbreak Quarantines](#) , on page 927.

## Checking the Settings of System-Created Quarantines

Before you use quarantines, customize the settings of the default quarantines, including the Unclassified quarantine.

#### Related Topics

- [Configuring Policy, Virus, and Outbreak Quarantines](#) , on page 927

## Configuring Policy, Virus, and Outbreak Quarantines

#### Before you begin

- If you are editing an existing quarantine, see [About Editing Policy, Virus, and Outbreak Quarantine Settings](#) , on page 929.
- Understand how messages in quarantines are automatically managed, including retention times and default actions. See [Retention Time for Messages in Quarantines](#) , on page 926, and [Default Actions for Automatically Processed Quarantined Messages](#) , on page 927.

- Determine which users you want to have access to each quarantine, and create users and custom user roles accordingly. For details, see [Which User Groups Can Access Policy, Virus, and Outbreak Quarantines](#), on page 932.

## Procedure

**Step 1** You can configure Policy, Virus, and Outbreak Quarantines in any one of the following ways:

- [ New Web Interface Only] Choose **Quarantine > Other Quarantine > View > +**.
- Choose **Monitor > Policy, Virus, and Outbreak Quarantines** and do one of the following.
  - Click **Add Policy Quarantine**.
  - Click a quarantine to edit.

**Step 2** Enter the following information:

Keep the following in mind:

- Changing the retention time of the File Analysis quarantine from the default of one hour is not recommended.
- If you do *not* want messages in this quarantine to be processed before the end of the Retention Period you specify, even when quarantine disk space is full, deselect **Free up space by applying default action on messages upon space overflow**.

Do not select this option for all quarantines. The system must be able to make space by deleting messages from at least one quarantine.

- If you select **Release** as the default action, you can specify additional actions to apply to messages that are released before their retention period has passed:

| Option            | Information   |
|-------------------|---|
| Modify Subject    | Type the text to add and specify whether to add it to the beginning or the end of the original message subject.<br><br>For example, you might want to warn the recipient that the message may contain inappropriate content.<br><br><b>Note</b> In order for a subject with non-ASCII characters to display correctly it must be represented according to RFC 2047. |
| Add X-Header      | An X-Header can provide a record of actions taken on a message. This can be helpful for example when handling inquiries about why a particular message was delivered.<br><br>Enter a name and value.<br><br>Example:<br>Name = Inappropriate-release-early<br>Value = True  |
| Strip Attachments | Stripping attachments protects against viruses that may be in such files.   |



**Step 3** Specify the users who can access this quarantine:

| User                           | Information  |
|--------------------------------|--|
| Local Users                    | The list of local users includes only users with roles that can access quarantines. The list excludes users with Administrator privileges, because all Administrators have full access to quarantines. |
| Externally Authenticated Users | You must have configured external authentication.  |
| Custom User Roles              | You see this option only if you have created at least one custom user role with quarantine access.   |

**Step 4** Submit and commit your changes.

#### What to do next

Create message and content filters and DLP message actions that will move messages to the quarantine.

## About Editing Policy, Virus, and Outbreak Quarantine Settings



- Note**
- You cannot rename a quarantine.
  - See also [Retention Time for Messages in Quarantines](#), on page 926.

To change quarantine settings, choose **Monitor > Policy, Virus, and Outbreak Quarantines**, and then click the name of a quarantine.

To change quarantine settings on the new web interface, navigate to **Quarantine > Other Quarantine > View** and click  on the required quarantine or

## Determining the Filters and Message Actions to Which a Policy Quarantine Is Assigned

You can view the message filters, content filters, Data Loss Prevention (DLP) message actions, and DMARC verification profiles that are associated with a policy quarantine.

#### Procedure



- Step 1** [New Web Interface Only] On the email gateway, click **Quarantine > Other Quarantine > View**.
- Step 2** [New Web Interface Only] Select the required quarantine and click on the  button.
- Step 3** Choose **Monitor > Policy, Virus, and Outbreak Quarantines**.



- Step 4** Click the name of the policy quarantine to check.
- Step 5** Scroll to the bottom of the page and view the **Associated Message Filters/Content Filters/DLP Message Actions**.

## About Deleting Policy Quarantines

- Before you delete a policy quarantine, see if it is associated with any active filters or message actions. See [Determining the Filters and Message Actions to Which a Policy Quarantine Is Assigned](#), on page 929.
- You can delete a policy quarantine even if it is assigned to a filter or message action.
- If you delete a quarantine that is not empty, the default action defined in the quarantine will be applied to all messages, even if you have selected the option not to delete messages if the disk is full. See [Default Actions for Automatically Processed Quarantined Messages](#), on page 927.
- After you delete the quarantine associated with a filter or message action, any messages subsequently quarantined by that filter or message action will be sent to the Unclassified quarantine. You should customize the default settings of the Unclassified quarantine before you delete quarantines.
- You cannot delete the Unclassified quarantine.

## Monitoring Quarantine Status, Capacity, and Activity

| To View   | Do This   |
|---|---|
| Total space allocated for all non-spam quarantines      | [New Web Interface Only] On the email gateway, click  to load the legacy web interface.<br>Choose <b>Monitor &gt; Policy, Virus, and Outbreak Quarantines</b> and look in the first section on the page.<br>To change allocations, see <a href="#">Managing Disk Space</a> , on page 1026. |
| Currently available space for all non-spam quarantines  | [New Web Interface Only] Choose <b>Quarantine &gt; Other Quarantine</b> .<br>Choose <b>Monitor &gt; Policy, Virus, and Outbreak Quarantines</b> and look just below the table.  |
| Total amount of space currently used by all quarantines | [New Web Interface Only] On the email gateway, click  to load the legacy web interface.<br>Choose <b>Monitor &gt; System Status</b> and look for <b>Queue Space Used by Quarantine</b> .   |
| Amount of space currently used by each quarantine       | [New Web Interface Only] Choose <b>Quarantines Quarantine &gt; Other Quarantine &gt; View</b> .<br>Choose <b>Monitor &gt; Policy, Virus, and Outbreak Quarantines</b> , click the quarantine name, and look for this information in the table row directly below the quarantine name.   |

| To View  | Do This   |
|--|---|
| Total number of messages currently in all quarantines  | [New Web Interface Only] On the email gateway, click  to load the legacy web interface.<br><br>Choose <b>Monitor &gt; System Status</b> and look for <b>Active Messages in Quarantine</b> .  |
| Number of messages currently in each quarantine  | [New Web Interface Only] Choose <b>Quarantines Quarantine &gt; Other Quarantine &gt; View</b> .<br><br>Choose <b>Monitor &gt; Policy, Virus, and Outbreak Quarantines</b> and look at the table row for the quarantine.   |
| Total CPU usage by all quarantines   | [New Web Interface Only] On the email gateway, click  to load the legacy web interface.<br><br>Choose <b>Monitor &gt; System Status</b> and look in the <b>CPU Utilization</b> section.  |
| Date and time when the last message entered each quarantine (excluding moves between policy quarantines) | [New Web Interface Only] Choose <b>Quarantines &gt; Other Quarantine &gt; View</b> .<br><br>Choose <b>Monitor &gt; Policy, Virus, and Outbreak Quarantines</b> and look at the table row for the quarantine.  |
| Date a policy quarantine was created   | [New Web Interface Only] On the email gateway, click  to load the legacy web interface.<br><br>Choose <b>Monitor &gt; Policy, Virus, and Outbreak Quarantines</b> , click the quarantine name, and look for this information in the table row directly below the quarantine name.<br><br>Creation date and creator name are not available for system-created quarantines. |
| Name of policy quarantine creator  |   |
| Filters and message actions associated with a policy quarantine  | See <a href="#">Determining the Filters and Message Actions to Which a Policy Quarantine Is Assigned</a> , on page 929.   |

## Policy Quarantine Performance

Messages stored in policy quarantines use system memory in addition to hard-drive space. Storing hundreds of thousands of messages in policy quarantines on a single email gateway may cause a decrease in the email gateway's performance due to excessive memory usage. The email gateway takes more time to quarantine, delete, and release messages, which causes message processing to slow down and the email pipeline to back up.

Cisco recommends storing an average of less than 20,000 messages in your policy quarantines to ensure that the email gateway processes email at a normal rate.

To check the number of messages in quarantines, see [Monitoring Quarantine Status, Capacity, and Activity](#), on page 930.

## Alerts About Quarantine Disk-Space Usage

An alert is sent whenever the total size of the policy, virus, and outbreak quarantine reaches or passes 75 percent, 85 percent, and 95 percent of its capacity. The check is performed when a message is placed in the quarantine. For example, if adding a message to a quarantine increases the size to or past 75 percent of the total capacity, an alert is sent.

## Policy Quarantines and Logging

AsyncOS individually logs all messages that are quarantined:

Info: MID 482 quarantined to "Policy" (message filter:policy\_violation)

The message filter or Outbreak Filters feature rule that caused the message to be quarantined is placed in parentheses. A separate log entry is generated for each quarantine in which the message is placed.

AsyncOS also individually logs messages that are removed from quarantine:

Info: MID 483 released from quarantine "Policy" (queue full)

Info: MID 484 deleted from quarantine "Anti-Virus" (expired)

The system individually logs messages after they are removed from all quarantines and either permanently deleted or scheduled for delivery, for example

Info: MID 483 released from all quarantines

Info: MID 484 deleted from all quarantines

When a message is re-injected, the system creates a new Message object with a new Message ID (MID). This is logged using an existing log message with a new MID “byline”, for example:

Info: MID 483 rewritten to 513 by Policy Quarantine

## About Distributing Message Processing Tasks to Other Users

You can distribute message review and processing tasks to other administrative users. For example:

- The Human Resources team can review and manage the Policy Quarantine.
- The Legal team can manage the Confidential Material Quarantine.

You assign access privileges to these users when you specify settings for a quarantine. In order to add users to quarantines, the users must already exist.

Each user may have access to all, some, or none of the quarantines. A user who is not authorized to view a quarantine will not see any indication of its existence anywhere in the GUI or CLI listings of quarantines.

### Related Topics

- [Which User Groups Can Access Policy, Virus, and Outbreak Quarantines](#), on page 932
- [Distributing Administrative Tasks](#), on page 973

## Which User Groups Can Access Policy, Virus, and Outbreak Quarantines

When you allow administrative users to access a quarantine, the actions that they can perform depend on their user group:

- Users in the Administrators groups can create, configure, delete, and centralize quarantines and can manage quarantined messages.
- Users in the Operators, Guests, Read-Only Operators, and Help Desk Users groups, as well as custom user roles with quarantine management privileges, can search for, view, and process messages in a quarantine, but cannot change the quarantine's settings, create, delete, or centralize quarantines. You specify in each quarantine which of these users have access to that quarantine.
- Users in the Technicians group cannot access quarantines.

Access privileges for related features, such as Message Tracking and Data Loss Prevention, also affect the options and information that an administrative user sees on Quarantine pages. For example, if a user does not have access to Message Tracking, that user will not see message tracking links and information for quarantined messages.

End users do not have see or have access to policy, virus, and outbreak quarantines.

## About Policy, Virus, and Outbreak Quarantines in Cluster Configurations

Policy, virus, and outbreak quarantines are configurable only at machine level in deployments with centralized management.

## About Centralized Policy, Virus, and Outbreak Quarantines

You can centralize policy, virus, and outbreak quarantines on a Cisco Secure Email and Web Manager. For more information, see [Centralized Policy, Virus, and Outbreak Quarantines](#) , on page 1295.

# Working with Messages in Policy, Virus, or Outbreak Quarantines

### Related Topics

- [Viewing Messages in Quarantines](#) , on page 934
- [Finding Messages in Policy, Virus, and Outbreak Quarantines](#) , on page 934
- [Manually Processing Messages in a Quarantine](#), on page 935
- [Messages in Multiple Quarantines](#) , on page 937
- [Message Details and Viewing Message Content](#), on page 937
- [About Rescanning of Quarantined Messages](#) , on page 939
- [The Outbreak Quarantine](#), on page 940

## Viewing Messages in Quarantines

| To   | Do This   |
|--|---|
| View all messages in a quarantine                          | [New Web Interface Only] Choose <b>Quarantine &gt; Other Quarantine &gt; View</b> .<br>Choose <b>Monitor &gt; Policy, Virus, and Outbreak Quarantines</b> .<br>In the row for the relevant quarantine, click the blue number in the <b>Messages</b> column of the table.  |
| View messages in the Outbreak quarantine                   | [New Web Interface] Choose <b>Quarantine &gt; Other Quarantine &gt; View</b> .<br>Choose <b>Monitor &gt; Policy, Virus, and Outbreak Quarantines</b> .<br>In the row for the relevant quarantine, click the blue number in the <b>Messages</b> column of the table.<br>See <a href="#">Manage by Rule Summary Link</a> , on page 941. |
| Navigate through the list of messages in a quarantine      | Click Previous, Next, a page number, or double-arrow link. The double arrows take you to the first (<<) or last (>>) page in the listing.   |
| Sort the list of messages in a quarantine                  | Click a column heading (except columns that could include multiple items or the “In other quarantines” column).   |
| Resize table columns                                       | Drag the divider between column headings.   |
| View the content that caused the message to be quarantined | See <a href="#">Viewing Matched Content</a> , on page 938.  |

### Related Topics

- [Quarantined Messages and International Character Sets](#), on page 934

## Quarantined Messages and International Character Sets

For messages with subjects that contain characters from international character sets (double-byte, variable length, and non-ASCII encoded), the Policy Quarantine pages display subject lines in non-ASCII characters in their decoded form.

## Finding Messages in Policy, Virus, and Outbreak Quarantines



### Note

- Users can find and see only the messages in quarantines to which they have access.
- Searches in Policy, Virus, and Outbreak quarantines do not find messages in the spam quarantine.

## Procedure

---

- Step 1** [New Web Interface Only] Click the blue number link of the corresponding quarantine.
- Tip** [New Web Interface Only] For the Outbreak Quarantine, you can also find all messages quarantined by each outbreak rule: Click the **Rule Summary** tab in the Outbreak quarantine, and then click the relevant rule.
- Step 2** [New Web Interface Only] Choose **Quarantine > Other Quarantine > Search**.
- Step 3** [New Web Interface Only] Click the blue number link of the corresponding quarantine.
- Tip** [New Web Interface Only] For the Outbreak Quarantine, you can also find all messages quarantined by each outbreak rule: Click the **Rule Summary** tab in the Outbreak quarantine, and then click the relevant rule.
- Step 4** Choose **Monitor > Policy, Virus, and Outbreak Quarantines**.
- Step 5** Click the **Search Across Quarantines** button.
- Tip** For the Outbreak Quarantine, you can also find all messages quarantined by each outbreak rule: Click the **Manage by Rule Summary** link in the Outbreak table row, and then click the relevant rule.
- Step 6** (Optional) Enter other search criteria.
- For Envelope Sender and Envelope Recipient: You can enter any character(s). No validation of your entry is performed.
  - Search results include only messages that match *all* of the criteria you specify. For example, if you specify an Envelope Recipient and a Subject, only messages that match the terms specified in both the Envelope Recipient *and* the Subject are returned.
- 

## What to do next

You can use the search results in the same way that you use the quarantine listings. For more information, see [Manually Processing Messages in a Quarantine, on page 935](#).

# Manually Processing Messages in a Quarantine

Manually processing messages means to manually select a Message Action for the message from the Message Actions page.

You can perform the following actions on messages:

- Delete
- Release
- Delay Scheduled Exit from quarantine
- Send a Copy of messages to email addresses that you specify

- Move a message from one quarantine to another

Generally, you can perform actions on messages in the lists that are displayed when you do the following. However, not all actions are available in all situations.

- From the list of quarantines on the **Monitor > Policy, Virus, and Outbreak Quarantines** or [New Web Interface Only] **Quarantine > Other Quarantine > View** page, click the number of messages in a quarantine.
- Click **Search Across Quarantines**.
- Click a quarantine name and search within a quarantine.

You can perform these actions on multiple messages at one time by:

- Choosing an option from the pick list at the top of the list of messages.
- Selecting the check box beside each message listed on a page.
- Selecting the check box in the table heading at the top of a list of messages. This applies the action to all messages visible on the screen. Messages on other pages are not affected.

Additional options are available for messages in the outbreak quarantine. See

#### Related Topics

- [Sending a Copy of the Message, on page 936](#)
- [About Moving Messages Between Policy Quarantines , on page 936](#)
- [Messages in Multiple Quarantines , on page 937](#)
- [Default Actions for Automatically Processed Quarantined Messages , on page 927](#)

## Sending a Copy of the Message

Only users who belong to the Administrators group may send copies of a message.

To send a copy of the message, enter an email address in the Send Copy To: field and click **Submit**. Sending a copy of a message does not cause any other action to be performed on the message.

## About Moving Messages Between Policy Quarantines

You can manually move messages from one policy quarantine to another on a single email gateway.

When you move a message to a different quarantine:

- The expiration time is unchanged. The message keeps the retention time of the original quarantine.
- The reason the message was quarantined, including the matched content and other relevant details, does not change.
- If a message is in multiple quarantines and you move the message to a destination that already holds a copy of that message, the expiration time and reason for quarantine of the moved copy of the message overwrite those of the copy of the message that was originally in the destination quarantine.



## Messages in Multiple Quarantines

If a message is present in one or more other quarantines, the “In other quarantines” column in the quarantine message list will show “Yes,” regardless of whether you have permissions to access those other quarantines.

A message in multiple quarantines:

- Is not delivered unless it has been released from all of the quarantines in which it resides. If it is deleted from any quarantine, it will never be delivered.
- Is not deleted from any quarantine until it has been deleted or released from all quarantines in which it resides.

Because a user wanting to release a message may not have access to all of the quarantines in which it resides, the following rules apply:

- A message is not released from any quarantine until it has been released from all of the quarantines in which it resides.
- If a message is marked as Deleted in any quarantine, it cannot be delivered from any other quarantine in which it resides. (It can still be released.)

If a message is queued in multiple quarantines and a user does not have access to one or more of the other quarantines:

- The user will be informed whether the message is present in each of the quarantines to which the user has access.
- The GUI shows only the scheduled exit time from the quarantines to which the user has access. (For a given message, there is a separate exit time for each quarantine.)
- The user will not be told the names of the other quarantine(s) holding the message.
- The user will not see matched content that caused the message to be placed into quarantines that the user does not have access to.
- Releasing a message affects only the queues to which the user has access.
- If the message is also queued in other quarantines not accessible to the user, the message will remain in quarantine, unchanged, until acted upon by users who have the required access to the remaining quarantines (or until the message is released “normally” via early or normal expiration).

## Message Details and Viewing Message Content

Click on the subject line of a message to view that message’s content and to access the Quarantined Message page.

The Quarantined Message page has two sections: Quarantine Details and Message Details.

From the Quarantined Message page, you can read the message, select a Message Action, send a copy of the message, or test for viruses. You can also see if a message will be encrypted upon release from the quarantine due to the Encrypt on Delivery filter action.

The Message Details section displays the message body, message headers, and attachments. Only the first 100 K of the message body is displayed. If the message is longer, the first 100 K is shown, followed by an ellipsis (...). The actual message is not truncated. This is for display purposes only. You can download the message body by clicking [message body] in the Message Parts section at the bottom of Message Details. You can also download any of the message’s attachments by clicking the attachment’s filename.

If you view a message that contains a virus and you have desktop anti-virus software installed on your computer, your anti-virus software may complain that it has found a virus. This is not a threat to your computer and can be safely ignored.

To view additional details about the message, click the **Message Tracking** link.



---

**Note** For the special Outbreak quarantine, additional functionality is available. See [The Outbreak Quarantine, on page 940](#).

---

#### Related Topics

- [Viewing Matched Content](#) , on page 938
- [Downloading Attachments](#) , on page 939
- [Testing for Viruses](#), on page 939

## Viewing Matched Content

When you configure a quarantine action for messages that match Attachment Content conditions, Message Body or Attachment conditions, Message body conditions, or the Attachment content conditions, you can view the matched content in the quarantined message. When you display the message body, the matched content is highlighted in yellow, except for DLP policy violation matches. You can also use the \$MatchedContent action variable to include the matched content from message or content filter matches in the message subject.

If the attachment contains the matched content, the attachment's contents are displayed, as well as the reason it was quarantined, whether it was due to a DLP policy violation, content filter condition, message filter condition, or Image Analysis verdict.

When you view messages in the local quarantine that have triggered message or content filter rules, the GUI may display content that did not actually trigger the filter action (along with content that triggered the filter action). The GUI display should be used as a guideline for locating content matches, but does not necessarily reflect an exact list of content matches. This occurs because the GUI uses less strict content matching logic than is used in the filters. This issue applies only to the highlighting in the message body. The table that lists the matched strings in each part of the message, along with the associated filter rule, is correct.

Figure 71: Matched Content Viewed in the Policy Quarantine

The screenshot displays the 'Matched Content' interface. At the top, a table lists attachments. The selected attachment is 'FP1.1.txt', which is linked to a list of email addresses and a 'DLP Classifier: Contact Information'.

Below the table, the 'Headers' section shows the following text:

```
X-IronPort-AV: E=Sophos;i="4.43,282,1246818600";
d="txt?scan?208";a="178202"
Received: from d2.vmw023-bsd04.ibqa (HELO vmw023-bsd04.ibqa) ([172.22.107.1])
by c360002.ibqa with ESMTP; 28 Jul 2009 16:25:03 +0530
Message-ID: <792087.518002035-sendEmail@vmw023-bsd04>
From: "user@test.com" <user@test.com>
To: "user1@test.com" <user1@test.com>
Subject: DLPTTEST
Date: Tue, 28 Jul 2009 08:42:11 +0000
X-Mailer: sendEmail-1.55
MIME-Version: 1.0
Content-Type: multipart/mixed; boundary="----MIME delimiter for sendEmail-538525.714612664"
```

The 'Message' section shows the body text: 'Test'.

At the bottom, the 'Message Parts' table is shown:

| Name           | Size | Details                                |
|----------------|------|--|
| [message body] | 6    | ASCII text, with CRLF line terminators |
| FP1.1.txt      | 1K   | ASCII text                             |

## Downloading Attachments

You can download a message attachment by clicking the attachment's file name in the Message Parts or Matched Content section. AsyncOS displays a warning that attachments from unknown sources may contain viruses and asks you if you want to continue. Download attachments that may contain viruses at your own risk. You can also download the message body by clicking [message body] in the Message Parts section.

## Testing for Viruses

To test the message for viruses, click **Start Test**. Use a quarantine to hold messages until you are sure that your anti-virus signatures have been updated.

Testing for viruses sends a copy of the message to the anti-virus engine, not the message itself. The verdict from the anti-virus engine is returned and displayed above the Quarantines area.

## About Rescanning of Quarantined Messages

When a message is released from all queues in which it has been quarantined, the following rescanning occurs, depending on the features enabled for the email gateway and for the mail policy that originally quarantined the message:

- Messages released from Policy and Virus quarantines are rescanned by the anti-virus, advanced malware protection, and graymail engines.

- Messages released from the Outbreak quarantine are rescanned by the anti-spam, AMP, and anti-virus engines. (For information about rescanning of messages while in the Outbreak quarantine, see )
- Messages released from the File Analysis quarantine are rescanned for threats.
- Messages with attachments are rescanned by the file reputation service upon release from Policy, Virus, and Outbreak quarantines.

Upon rescanning, if the verdict produced matches the verdict produced the previous time the message was processed, the message is not re-quarantined. Conversely, if the verdict is different, the message could be sent to another quarantine.

The rationale is to prevent messages from looping back to the quarantine indefinitely. For example, suppose a message is encrypted and therefore sent to the Virus quarantine. If an administrator releases the message, the anti-virus engine will still not be able to decrypt it; however, the message should not be re-quarantined or a loop will be created and the message will never be released from the quarantine. Since the two verdicts are the same, the system bypasses the Virus quarantine the second time.

## The Outbreak Quarantine

The Outbreak quarantine is present when a valid Outbreak Filters feature license key has been entered. The Outbreak Filters feature sends messages to the Outbreak quarantine, depending on the threshold set. For more information, see

The Outbreak quarantine functions just like other quarantines—you can search for messages, release or delete messages, and so on.

- Standard
- Rule Summary

The Outbreak quarantine has some additional features not available in other quarantines: the Manage by Rule Summary link, the Send to Cisco feature when viewing message details, and the option to sort messages in search results by the Scheduled Exit time.

If the license for the Outbreak Filters feature expires, you will be unable to add more messages to the Outbreak quarantine. Once the messages currently in the quarantine have expired and the Outbreak quarantine becomes empty, it is no longer shown in the Quarantines listing in the GUI.

### Related Topics

- [Rescanning Messages in an Outbreak Quarantine](#) , on page 940
- [Manage by Rule Summary Link](#), on page 941
- [Reporting False Positives or Suspicious Messages to Cisco Systems](#), on page 941

## Rescanning Messages in an Outbreak Quarantine

Messages placed in the Outbreak quarantine are automatically released if newly published rules deem the quarantined message no longer a threat.

If anti-spam and anti-virus are enabled on the email gateway, the scanning engines scan every message released from the Outbreak quarantine based on the mail flow policy that applies to the message.

## Manage by Rule Summary Link

Click the Manage by Rule Summary link next to the Outbreak quarantine in the quarantine listing to view the Manage by Rule Summary page. You can perform message actions (Release, Delete, Delay Exit) on all of the messages in the quarantine based on which outbreak rule caused the message to be quarantined. This is ideal for clearing out large numbers of messages from the Outbreak quarantine. For more information, see the topics under Outbreak Quarantine and the Manage by Rule Summary View

## Reporting False Positives or Suspicious Messages to Cisco Systems

When viewing message details for a message in the Outbreak quarantine, you can send the message to Cisco to report false positives or suspicious messages.

### Procedure

---

- Step 1** Navigate to a message in the Outbreak quarantine.
  - Step 2** In the Message Details section, select the **Send a Copy to Cisco Systems** check box.
  - Step 3** In the new web interface, click the blue number in the Message column of the outbreak filters entry in the table and select the check box of the message(s) and select Send a Copy .
  - Step 4** Enter the recipient address and click **Send**.
-





## CHAPTER 37

# Spam Quarantine

This chapter contains the following sections:

- [Overview of the Spam Quarantine](#) , on page 943
- [Local Versus External Spam Quarantine](#) , on page 943
- [Setting Up the Local Spam Quarantine](#), on page 944
- [Using Safelists and Blocklists to Control Email Delivery Based on Sender](#) , on page 949
- [Configuring Spam Management Features for End Users](#) , on page 960
- [Managing Messages in the Spam Quarantine](#) , on page 968
- [Disk Space for the Spam Quarantine](#) , on page 970
- [About Disabling the External Spam Quarantine](#) , on page 971
- [Troubleshooting Spam Quarantine Features](#) , on page 971

## Overview of the Spam Quarantine

The Spam Quarantine (also known as ISQ) and End-User Quarantine (also known as EUQ) provides a safeguard mechanism for organizations that are concerned about “false positives” — that is, legitimate email messages that the email gateway has deemed to be spam. When the email gateway determines that a message is spam or suspected spam, you may want to let the recipient or an administrator review the message before delivering or deleting it. The spam quarantine stores messages for this purpose.

Administrative users of the email gateway can view all messages in a spam quarantine. End users, usually the message recipients, can view their own quarantined messages in a slightly different web interface.

The spam quarantine is separate from policy, virus, and outbreak quarantines.

### Related Topics

- [Managing Spam and Graymail](#), on page 379
- [Policy, Virus, and Outbreak Quarantines](#), on page 923

## Local Versus External Spam Quarantine

A local spam quarantine stores spam and suspect spam on the email gateway. An external spam quarantine can store these messages on a separate Cisco Secure Email and Web Manager.

Consider using an external spam quarantine if:

- You want a centralized location to store and manage spam from multiple email gateways.
- You want to store more spam than the email gateway can hold.
- You want to regularly back up the spam quarantine and its messages.

#### Related Topics

- [Disk Space for the Spam Quarantine](#) , on page 970
- [Working with an External Spam Quarantine](#) , on page 1292

## Setting Up the Local Spam Quarantine

The following table shows how to send messages to a Spam Quarantine

#### Procedure

|               | Command or Action   | Purpose   |
|---------------|---|---|
| <b>Step 1</b> | Enable the Anti-Spam feature if you have not yet done so.   | For more information, see <a href="#">Managing Spam and Graymail</a> , on page 379.   |
| <b>Step 2</b> | Enable and configure quarantine settings.   | For more information, see <a href="#">Enabling and Configuring the Spam Quarantine on the Legacy Web Interface</a> , on page 945.   |
| <b>Step 3</b> | Adjust the disk space allocated to the spam quarantine  | For more information, see <a href="#">Managing Disk Space</a> , on page 1026  |
| <b>Step 4</b> | Enable browser access to the quarantine.  | For more information, see <a href="#">Configuring the IP Interface for Browser Access to the Spam Quarantine</a> , on page 946  |
| <b>Step 5</b> | Configure the email gateway to send spam to the quarantine.   | For more information, see <ul style="list-style-type: none"> <li>• <a href="#">Configuring a Mail Policy to Quarantine Spam</a> , on page 948</li> <li>• <a href="#">Limiting Which Recipients Have Mail Quarantined</a> , on page 948</li> </ul> |
| <b>Step 6</b> | Specify a default character encoding for messages that do not have this information in the heading. | For more information, see <a href="#">Ensuring That Message Text Displays Correctly</a> , on page 948   |

#### What to do next

#### Related Topics

- [Configuring the IP Interface for Browser Access to the Spam Quarantine](#) , on page 946
- [Configuring Administrative User Access to the Spam Quarantine](#) , on page 947
- [Configuring a Mail Policy to Quarantine Spam](#) , on page 948
- [Limiting Which Recipients Have Mail Quarantined](#) , on page 948



- [Ensuring That Message Text Displays Correctly](#) , on page 948
- [Spam Quarantine Language](#), on page 949

## Enabling and Configuring the Spam Quarantine on the Legacy Web Interface

### Procedure

- Step 1** [New Web Interface Only] On the email gateway, click  to load the legacy web interface.
- Step 2** Select **Spam Quarantine**.
- Step 3** If you have not previously enabled the spam quarantine, select **Enable Spam Quarantine**.  
If you are editing spam quarantine settings, click the **Spam Quarantine** link in the Quarantine Name column of the Spam Quarantine section.
- Step 4** Specify options:

| Option                            | Description  |
|-----------------------------------|--|
| Deliver Messages Via              | <p>All outgoing quarantine-related email (such as spam notifications and messages released from the spam quarantine) must be delivered via another email gateway or server that is configured to send messages.</p> <p>You can route these messages through an SMTP or groupware server, or you can specify the outbound listener interface of an email gateway (typically the Data 2 interface).</p> <p>The alternate address is used for load balancing and failover.</p> <p>If you have multiple email gateways, you can use the outbound listener interface of any managed email gateways for the primary and alternate addresses. Both must use the same interface (either Data 1 or Data 2) as the outbound listener.</p> <p>Read instructions on the screen for additional caveats about these addresses.</p> |
| Schedule Delete After             | <p>Specify the number of days to hold messages before deleting them.</p> <p>Cisco recommends that you configure the quarantine to delete older messages to prevent the quarantine from filling to capacity, but you can elect not to schedule automatic deletion.</p>  |
| Notify Cisco Upon Message Release | <p>Check the <b>Send a copy of released messages to Cisco for analysis(recommended)</b> checkbox if you wish to notify Cisco upon message release.</p>   |

| Option                     | Description   |
|----------------------------|---|
| Spam Quarantine Appearance | <p><b>Logo</b></p> <p>By default, the Cisco logo is displayed at the top of the spam quarantine page when the user logs in to view quarantined messages.</p> <p>To use a custom logo instead, upload the logo. The logo should be a .jpg, .gif, or .png file that is at most 50 pixels high by 500 pixels wide.</p>   |
|                            | <p><b>Login page message</b></p> <p>(Optional) Specify a login page message. This message is shown to end users and administrators when they log in to view the quarantine.</p> <p>If you do not specify a message, the following message appears:</p> <p>Enter your login information below. If you are unsure what to enter, please contact your administrator.</p> |
| Administrative Users       | See <a href="#">Configuring Administrative User Access to the Spam Quarantine</a> , on page 947.  |

**Step 5** Submit and commit your changes.

---

#### What to do next

- Return to [Setting Up the Local Spam Quarantine, on page 944](#)

## Configuring the IP Interface for Browser Access to the Spam Quarantine

When administrators and end users access the spam quarantine, a separate browser window opens.

#### Procedure

---

**Step 1** [New Web Interface Only] On the email gateway, click  to load the legacy web interface.

**Step 2** Choose **Network > IP Interfaces**.

**Step 3** Click the interface name (for this example, we will use the Management interface).

**Step 4** In the Spam Quarantine section, configure settings for access to the spam quarantine:

- By default, HTTP uses port 82 and HTTPS uses port 83.
- Specify the URL that appears in notifications and in the spam quarantine browser window.

If you do not want to expose the hostname of your Cisco Secure Email and Web Manager to end users, you can specify an alternate hostname.

**Step 5** Submit and commit your changes.

---

#### What to do next

Ensure that your DNS server can resolve the hostname that you specified for spam quarantine access.

## Configuring Administrative User Access to the Spam Quarantine

All users with administrator privileges can change spam quarantine settings and view and manage messages in the spam quarantine. You do not need to configure spam quarantine access for administrator users.

If you configure access to the spam quarantine for users with the following roles, they can view, release, and delete messages in the spam quarantine:

- Operator
- Read-only operator
- Help desk user
- Guest
- Custom user roles that have spam quarantine privileges

These users cannot access spam quarantine settings.

#### Before you begin

Create users or custom user roles that have access to the spam quarantine. For more information, see [Distributing Administrative Tasks, on page 973](#)

#### Procedure

---

**Step 1** On the Cisco Secure Email and Web Manager, click **Service Status** and hover over the  corresponding to **Spam Quarantine** and click **Edit Spam Quarantine Settings**.

**Step 2** Click the toggle switch to enable Spam Quarantine.

**Step 3** Click the link for the type of user to add: local, externally authenticated, or custom role.

If you have already added users or roles, click a username or role to view all eligible users or roles.

**Step 4** Select the users or roles that you want to add.

Users with Administrator privileges are not listed because they automatically have full access to the spam quarantine.

**Step 5** Click **OK**.

**Step 6** Click **Submit**.

---

#### What to do next

#### Related Topics

[Configuring End-User Access to the Spam Quarantine](#) , on page 962

## Configuring a Mail Policy to Quarantine Spam

Once you have enabled the spam quarantine, you can configure a mail policy to send spam or suspected spam to that quarantine. Anti-spam scanning must be enabled on the mail policy in order to send mail to the spam quarantine.

### Procedure

---

- Step 1** On the **Mail Policies > Incoming Mail Policies** page, click the link in the Anti-Spam column for the corresponding mail policy.
  - Step 2** In the Anti-Spam Settings section, select **Use IronPort Anti-Spam service**.
  - Step 3** In the Positively-Identified Spam Settings section, select **Spam Quarantine** for the **Apply This Action to Message** option.
  - Step 4** Configure settings for suspected spam and marketing email.
  - Step 5** Submit and commit your changes.
- 

## Limiting Which Recipients Have Mail Quarantined

You can use multiple mail policies on the email gateway (Mail Policies > Incoming Mail Policy) to specify a list of recipient addresses for which mail will not be quarantined. Select 'Deliver' or 'Drop' instead of quarantine when configuring the anti-spam settings for the mail policy.

## Ensuring That Message Text Displays Correctly

AsyncOS attempts to determine the character set of a message based on the encoding that is specified in the message headers. However, if the encoding specified in the headers does not match that of the actual text, the message will not be displayed properly when viewed in the spam quarantine. This situation is more likely to occur with spam messages.

To ensure that message text displays correctly for these messages, see .

### Related Topic

- [Specifying a Default Encoding](#) , on page 948

## Specifying a Default Encoding

If an incoming message does not have a character set encoding specified in the headers, you can configure your email gateway to specify a default encoding.

Doing so will help ensure that these types of messages display properly in the spam quarantine. However, specifying a default encoding can cause messages in other character sets to display incorrectly. This setting applies only to messages that do not specify the encoding in the message headers. Generally, you would only set a default encoding if you expect the majority of your mail that falls into this category to be of one specific encoding.

For example, if most quarantined messages that do not specify the character set encoding in the message headers are in Japanese (ISO-2022-JP), you can set the encoding on the Scan Behavior page as **Japanese (ISO-2022-JP)**.

## Procedure

---

- Step 1** Click **Security Services > Scan Behavior**.
  - Step 2** Under Global Settings, click **Edit Global Settings**.
  - Step 3** From the **Encoding to use when none is specified** drop-down list, select the desired encoding type.
  - Step 4** Click **Submit**.
  - Step 5** Click **Commit Changes**.
- 

## Spam Quarantine Language

Each user selects a language in the spam quarantine from the Options menu at the top right of the window.

## Using Safelists and Blocklists to Control Email Delivery Based on Sender

Administrators and end users can use safelists and blocklists to help determine which messages are spam. Safelists specify senders and domains that are never treated as spam. Blocklists specify senders and domains that are always treated as spam.

You can allow end users (email users) to manage the safelist and blocklist for their own email accounts. For example, an end user may receive email from a mailing list that no longer interests him. He may decide to add this sender to his blocklist to prevent emails from the mailing list from being sent to his inbox. On the other hand, end users may find that emails from specific senders are sent to their spam quarantine when they do not want them to be treated as spam. To ensure that messages from these senders are not quarantined, they may want to add the senders to their safelists.

Changes that end users and administrators make are visible to and can be changed by either.

### Related Topics

- [Message Processing of Safelists and Blocklists](#) , on page 949
- [Enabling Safelists and Blocklists on the Legacy Web Interface](#), on page 950
- [External Spam Quarantine and Safelist/Blocklists](#) , on page 951
- [Adding Senders and Domains to Safelists and Blocklists \(Administrators\)](#) , on page 951
- [About End-User Access to Safelists and Blocklists](#) , on page 956
- [Synchronizing Safelists or Blocklists on Multiple Email Gateways \(Deployments Without a Cisco Secure Email and Web Manager\)](#) , on page 958
- [Backing Up and Restoring the Safelist/Blocklist](#) , on page 958
- [Troubleshooting Safelists and Blocklists](#), on page 959

## Message Processing of Safelists and Blocklists

A sender's being on a safelist or blocklist does not prevent the email gateway from scanning a message for viruses or determining if the message meets the criteria for a content-related mail policy. Even if the sender

of a message is on the recipient's safelist, the message may not be delivered to the end user depending on other scanning settings and results.

When you enable safelists and blocklists, the email gateway scans the messages against the safelist/blocklist database immediately before anti-spam scanning. If the email gateway detects a sender or domain that matches a safelist or blocklist entry, the message will be splintered if there are multiple recipients (and the recipients have different safelist/blocklist settings). For example, a message is sent to both recipient A and recipient B. Recipient A has safelisted the sender, whereas recipient B does not have an entry for the sender in the safelist or the blocklist. In this case, the message may be split into two messages with two message IDs. The message sent to recipient A is marked as safelisted with an *X-SLBL-Result-Safelist* header and skips anti-spam scanning, whereas the message bound for recipient B is scanned by the anti-spam scanning engine. Both messages then continue along the pipeline (through anti-virus scanning, content policies, and so on) and are subject to any configured settings.

If a message sender or domain is blocklisted, the delivery behavior depends on the blocklist action that you specify when you enable the safelist/blocklist feature. Similar to safelist delivery, the message is splintered if there are different recipients with different safelist/blocklist settings. The blocklisted message splinter is then quarantined or dropped, depending on the blocklist action settings. If the blocklist action is configured to quarantine, the message is scanned and eventually quarantined. If the blocklist action is configured to delete, the message is dropped immediately after safelist/blocklist scanning.

Because safelists and blocklists are maintained in the spam quarantine, delivery behavior is also contingent on other anti-spam settings. For example, if you configure the "Accept" mail flow policy in the Host Access Table (HAT) to skip anti-spam scanning, then users who receive mail on that listener will not have their safelist and blocklist settings applied to mail received on that listener. Similarly, if you create a mail flow policy that skips anti-spam scanning for certain message recipients, these recipients will not have their safelist and blocklist settings applied.

### Related Topics

- [Enabling Safelists and Blocklists on the Legacy Web Interface, on page 950](#)
- [External Spam Quarantine and Safelist/Blocklists , on page 951](#)

## Enabling Safelists and Blocklists on the Legacy Web Interface

### Before you begin

- The spam quarantine must be enabled. See [Setting Up the Local Spam Quarantine, on page 944](#).
- Configure the email gateway to use an external safelist/blocklist. See instructions for setting up an external spam quarantine in the documentation for your email gateway.

### Procedure

---

- Step 1** [New Web Interface Only] On the email gateway, click  to load the legacy web interface.
- Step 2** Navigate to **Spam Quarantine**.
- Step 3** Under **End-User Safelist/Blocklist**, click **Edit Settings**.
- Step 4** Select **Enable End User Safelist/Blocklist Feature**.
- Step 5** Select **Quarantine** or **Delete** for the Blocklist Action.

**Step 6** Specify **Maximum List Items Per User**.

This is the maximum number of addresses or domains for each list, for each recipient. If you allow a large number of list entries per user, system performance might be adversely affected.

**Step 7** Select **Update Frequency**.

This value determines how often AsyncOS updates the safelists/blocklists on the email gateways that use the external spam quarantine. The significance of this setting is described in [External Spam Quarantine and Safelist/Blocklists](#) , on page 951.

**Step 8** Select the update frequency. This value determines how often AsyncOS updates the safelists/blocklists on the email gateways that use the external spam quarantine. The significance of this setting is described in [External Spam Quarantine and Safelist/Blocklists](#) , on page 951.**Step 9** Submit and commit your changes.

## External Spam Quarantine and Safelist/Blocklists

If you use an external spam quarantine on a Cisco Secure Email and Web Manager, the safelist/blocklist is saved on the management appliance. This gives you a single location to manage safe and blocked senders for all appliances.

Because the email gateway evaluates senders in safelists and blocklists when processing incoming mail, safelists and blocklists that are stored on a Cisco Secure Email and Web Manager must be sent to the email gateway in order to be applied to incoming mail. When you configure the safelist/blocklist feature on a Cisco Secure Email and Web Manager, you configure the frequency of these updates.

For more information about working with external safelists and blocklists on a Cisco Secure Email and Web Manager, see the topics under the *Cisco Secure Email and Web Manager User Guide*

## Adding Senders and Domains to Safelists and Blocklists (Administrators)

Manage safelists and blocklists via the spam quarantine interface.

You can also see whether many recipients (end users in your organization) have included a particular sender or domain in allowed list or blocked list.

Administrators see and work with the superset of the same entries that each end user sees and works with.

**Before you begin**

- Ensure that you can access the spam quarantine. See [Accessing the Spam Quarantine \(Administrative Users\)](#), on page 968.
- Enable access to the safelist/blocklist. See [Enabling Safelists and Blocklists on the Legacy Web Interface](#), on page 950.
- (Optional) To import safelist/blocklists instead of building these lists using the procedure in this section, use the process described in [Backing Up and Restoring the Safelist/Blocklist](#) , on page 958.
- Understand the required format of safelist and blocklist entries. See [Syntax for Safelists and Blocklist Entries](#) , on page 955.

## Procedure

**Step 1** [New Web Interface Only] On the email gateway, click **Quarantine > Spam Quarantine > Search**.

Or

Choose **Monitor > Spam Quarantine** and select the **Options** drop-down menu in the upper right corner of the page.

**Step 2** Choose **Safelist** or **Blocklist**.

**Step 3** (Optional) Search for a sender or recipient.

**Step 4** Do one or more of the following:

| To                                   | Do This   |
|--------------------------------------|---|
| Add multiple senders for a recipient | <p>To add multiple senders for a recipient on the new web interface:</p> <ol style="list-style-type: none"> <li>a. Select <b>Recipient</b> tab.</li> <li>b. Click on the + icon to add a recipient address and sender list.</li> <li>c. Enter the recipient email address.</li> <li>d. Enter the sender email addresses and domains.<br/>Put each entry on a separate line, or separate each entry with a comma.</li> <li>e. Click <input checked="" type="checkbox"/> to save the entry.</li> </ol> <p>To modify an existing sender address, select the checkbox next to the required recipient address, click the edit icon, modify the sender address and click <input checked="" type="checkbox"/> to save the entry.</p> <p>To add multiple senders for a recipient on the legacy web interface:</p> <ol style="list-style-type: none"> <li>a. Select <b>View by: Recipient</b></li> <li>b. Click <b>Add</b>, or click <b>Edit</b> for a recipient.</li> <li>c. Enter or edit the recipient email address.</li> <li>d. Enter sender email addresses and domains.<br/>Put each entry on a separate line, or separate each entry with a comma.</li> <li>e. Click <b>Submit</b>.</li> </ol> |



| To   | Do This  |
|--|--|
| Add multiple recipients for a sender           | <p>To add multiple recipient for a sender on the new web interface:</p> <ol style="list-style-type: none"> <li>Select <b>Sender</b> tab.</li> <li>Click + to add a sender address and recipient list.</li> <li>Enter the sender address or domain.</li> <li>Enter the recipient email addresses.<br/>Put each entry on a separate line, or separate each entry with a comma.</li> <li>Click <input checked="" type="checkbox"/> to save the entry.</li> </ol> <p>To modify an existing recipient address, select the checkbox next to the required sender address, click the edit icon, modify the sender address and click <input checked="" type="checkbox"/> to save the entry.</p> <p>To add multiple recipient for a sender on the legacy web interface:</p> <ol style="list-style-type: none"> <li>Select <b>View by: Sender</b></li> <li>Click <b>Add</b>, or click <b>Edit</b> for a sender.</li> <li>Enter or edit the sender address or domain.</li> <li>Enter recipient email addresses.<br/>Put each entry on a separate line, or separate each entry with a comma.</li> <li>Click <b>Submit</b>.</li> </ol> |
| Delete all senders associated with a recipient | <p>To delete all senders associated with a recipient on the new web interface:</p> <ol style="list-style-type: none"> <li>Select the checkbox next to the recipient or sender address to select the entry.<br/>You can select and delete all entries.</li> <li>Click on the trash can icon to delete an entire table row.</li> </ol> <p>To delete all senders associated with a recipient on the legacy web interface:</p> <ol style="list-style-type: none"> <li>Select a <b>View by</b> option.</li> <li>Click a trash can icon to delete an entire table row.</li> </ol>  |

| To   | Do This  |
|--|--|
| Delete all recipients associated with a sender | <p>To delete all recipients associated with a sender on the new web interface:</p> <ol style="list-style-type: none"> <li>a. Select the checkbox next to the recipient or sender address to select the entry.<br/>You can select and delete all entries.</li> <li>b. Click on the trash can icon to delete an entire table row.</li> </ol> <p>To delete all recipients associated with a sender on the legacy web interface:</p> <ol style="list-style-type: none"> <li>a. Select a <b>View by</b> option.</li> <li>b. Click a trash can icon to delete an entire table row.</li> </ol>  |
| Delete individual senders for a recipient      | <p>To delete individual senders for a recipient on the new web interface:</p> <ol style="list-style-type: none"> <li>a. Select the checkbox next to the recipient or sender address to select the entry.<br/>You can select and delete multiple entries.</li> <li>b. Click on the edit icon to modify an individual recipient or sender.</li> <li>c. Add or remove entries from the text box. You must leave at least one entry.</li> <li>d. Click <input checked="" type="checkbox"/> to save the entry.</li> </ol> <p>To delete individual senders for a recipient on the legacy web interface:</p> <ol style="list-style-type: none"> <li>a. Select a <b>View by</b> option.</li> <li>b. Click <b>Edit</b> for an individual recipient or sender.</li> <li>c. Add or remove entries from the text box. You must leave at least one entry.</li> <li>d. Click <b>Submit</b>.</li> </ol> |

| To  | Do This   |
|---|---|
| Delete individual recipients for a sender | <p>To delete individual recipient for a sender on the new web interface:</p> <ol style="list-style-type: none"> <li>Select the checkbox next to the recipient or sender address to select the entry.<br/>You can select and delete multiple entries.</li> <li>Click on the edit icon to modify an individual recipient or sender.</li> <li>Add or remove entries from the text box. You must leave at least one entry.</li> <li>Click <input checked="" type="checkbox"/> to save the entry.</li> </ol> <p>To delete individual senders for a recipient on the legacy web interface:</p> <ol style="list-style-type: none"> <li>Select a <b>View by</b> option.</li> <li>Click <b>Edit</b> for an individual recipient or sender.</li> <li>Add or remove entries from the text box. You must leave at least one entry.</li> <li>Click <b>Submit</b>.</li> </ol> |

### What to do next

#### Related Topics

- [Syntax for Safelists and Blocklist Entries](#) , on page 955
- [Clearing All Safelists and Blocklists](#) , on page 956

## Syntax for Safelists and Blocklist Entries

Senders can be added to safelists and blocklists using the following formats:

- user@domain.com
- server.domain.com
- domain.com
- [10.1.1.0]
- [ipv6:2001:DB8:1::1]
- user@[1.2.3.4]
- user@[ipv6:2001:db8::1]

An identical entry, such as a sender address or a domain, cannot be included on both the safelist and the blocklist at the same time. However, a domain can be on a safelist while an email address for a sender belonging to that domain is on the blocklist (or vice versa), and both rules apply. For example, if *example.com* is on the

safelist, *george@example.com* can be on the blocklist. In this case, the email gateway delivers all mail from *example.com* without scanning for spam, except mail from *george@example.com*, which is treated as spam.

It is not possible allow or block a range of subdomains using the following syntax: *.domain.com* . However, it is possible to block a specific domain using the following syntax: *server.domain.com* .

## Clearing All Safelists and Blocklists

If you need to delete all safelist and blocklist entries, including all senders and all recipients, import a file with no entries using the procedure in [Backing Up and Restoring the Safelist/Blocklist](#) , on page 958.

## About End-User Access to Safelists and Blocklists

End users access their safelist and blocklist via the spam quarantine. To configure end-user access to the spam quarantine, see [Setting Up End-User Access to the Spam Quarantine via Web Browser](#) .

You may want to give your end users the URL of the spam quarantine and the instructions below, as applicable.

### Related Topics

- [Adding Entries to Safelists \(End Users\)](#)
- [Adding Senders to Blocklists \(End Users\)](#)

## Adding Entries to Safelists (End Users)



---

**Note** Delivery of messages from safelisted senders depends on other settings that are configured in the system. See [Message Processing of Safelists and Blocklists](#) , on page 949.

---

End users can add senders to safelists in two ways:

- [Adding the Sender of a Quarantined Message to the Safelist](#) , on page 956
- [Adding Senders to the Safelist Without a Quarantined Message](#) , on page 957

### Adding the Sender of a Quarantined Message to the Safelist

End users can add senders to the safelist if the message has been sent to the spam quarantine.

#### Procedure

---

**Step 1** [New Web Interface Only] Choose **Quarantine > Spam Quarantine > Safelist**.

Or

Choose **Monitor > Spam Quarantine > Safelist**.

**Step 2** [New Web Interface Only] Click **Release and Add to Safelist** icon to release the message and add it to the safelist.

Or

Select **Release and Add to Safelist** from the drop-down menu.

The envelope sender and the from header for the specified mail are both added to the safelist, and the released messages proceed directly to the destination queue, skipping any further work queue processing in the email pipeline.

---

## Adding Senders to the Safelist Without a Quarantined Message

### Procedure

---

- Step 1** [New Web Interface Only] Choose **Quarantine > Spam Quarantine > Safelist** and click the plus icon on the top right side page.
- Step 2** [New Web Interface Only] Enter the email address or domain. You can enter multiple domains and email addresses, separated by commas.
- Step 3** [New Web Interface Only] Click  to save the entry.
- Step 4** Optionally you can perform this task from the legacy interface:
- Choose **Monitor > Spam Quarantine**.
  - Select the **Options** drop-down menu in the upper right corner of the page
  - Choose **Safelist**.
  - From the Safelist dialog box, enter the email address or domain. You can enter multiple domains and email addresses, separated by commas.
  - Click **Add to List**.

---

## Adding Senders to Blocklists (End Users)

Messages from blocklisted senders may be rejected or quarantined, depending on the safelist/blocklist action settings defined by your administrator.



---

**Note** You can add blocklist entries only using this procedure.

---

### Procedure

---

- Step 1** [New Web Interface Only] Choose **Quarantine > Spam Quarantine** .
- Step 2** [New Web Interface Only] Choose **Blocklist**, click the + icon and enter the domain or email address that you want to blocklist. You can enter multiple domains and email addresses, separated by commas.
- Step 3** [New Web Interface Only] Click  to save the entry.
- Step 4** Optionally you can perform this task from the legacy interface:
- Choose **Monitor > Spam Quarantine**.
  - Choose **Blocklist** from the **Options** drop-down menu in the upper right corner of the page.

- c) Enter the domain or email address that you want to blocklist. You can enter multiple domains and email addresses, separated by commas.
- d) Click **Add to List**.

## Synchronizing Safelists or Blocklists on Multiple Email Gateways (Deployments Without a Cisco Secure Email and Web Manager)

If you use multiple email gateways without a Cisco Secure Email and Web Manager, you may need to manually synchronize the safelist/blocklist and its configuration settings across the different email gateways.

You can export and import a .csv file using the procedure described in [Backing Up and Restoring the Safelist/Blocklist](#), on page 958, then use FTP to upload and download the file.

## Backing Up and Restoring the Safelist/Blocklist

Before you upgrade your email gateway or run the installation wizard, you should back up the safelist/blocklist database. Safelist/blocklist information is not included in the main XML configuration file that contains your appliance configuration settings.

You can also use this procedure to save a copy of the safelist/blocklist to synchronize multiple email gateways.

### Procedure

- Step 1** [New Web Interface Only] On the email gateway, click  to load the legacy web interface.
- Step 2** Select **System Administration > Configuration File**.
- Step 3** Scroll to the **End-User Safelist/Blocklist Database (Spam Quarantine)** section.

| To                            | Do This   |
|-------------------------------|---|
| Export the safelist/blocklist | <p>Note the path and filename of the .csv file, and modify as needed.</p> <p>Click <b>Backup Now</b>.</p> <p>The email gateway saves a .csv file to the /configuration directory of the email gateway using the following naming convention:</p> <p><i>slbl&lt;serial number&gt;&lt;timestamp&gt;.csv</i></p> |

| To                            | Do This  |
|-------------------------------|--|
| Import the safelist/blocklist | <p><b>Caution</b> This process will overwrite all existing entries in safelists and blocklists for all users.</p> <p>Click <b>Select File to Restore</b>.</p> <p>Select the desired file from the list of files in your configuration directory.</p> <p>Select the safelist/blocklist backup file that you want to restore.</p> <p>Click <b>Restore</b>.</p> |

## Troubleshooting Safelists and Blocklists

To troubleshoot issues with safelists and blocklists, you can view the log files or system alerts.

When an email is blocked due to safelist/blocklist settings, the action is logged in the ISQ\_log files or the antispam log files. Emails that are safelisted are marked as safelisted with an *X-SLBL-Result-Safelist* header. Emails that are blocklisted are marked as blocklisted with an *X-SLBL-Result-Blocklist* header.

Alerts are sent out when the database is created or updated, or if there are errors in modifying the database or running the safelist/blocklist processes.

For more information about alerts, see [Alerts, on page 1047](#).

For more information about log files, see [Logging, on page 1145](#).

### Related Topics

- [Message from Safelisted Sender Was Not Delivered , on page 959](#)

## Message from Safelisted Sender Was Not Delivered

### Problem

Message from a safelisted sender was not delivered.

### Solution

Possible causes:

- The message was dropped for malware or content violations. See [Message Processing of Safelists and Blocklists , on page 949](#).
- If you have multiple email gateways and the sender was recently added to the safelist, then safelist/blocklists might not have been synchronized at the time the message was processed. See [External Spam Quarantine and Safelist/Blocklists , on page 951](#) and [Synchronizing Safelists or Blocklists on Multiple Email Gateways \(Deployments Without a Cisco Secure Email and Web Manager\) , on page 958](#).

## Configuring Spam Management Features for End Users

| To   | See  |
|--|--|
| Understand the benefits and limitations of the different authentication methods for end-user access to spam management features.                                       | <a href="#">Configuring End-User Access to the Spam Quarantine</a> , on page 962 and subsections       |
| Allow end users to access the spam quarantine directly via browser.  | <a href="#">Authentication Options for End Users Accessing Spam Management Features</a> , on page 960  |
| Send users a notification when messages addressed to them are routed to the spam quarantine.<br><br>Notifications can include links for access to the spam quarantine. | <a href="#">Notifying End Users About Quarantined Messages</a> , on page 964                           |
| Allow users to specify email addresses and domains of senders whom they know to be safe, and of senders whom they know to be sending spam or other unwanted mail.      | <a href="#">Using Safelists and Blocklists to Control Email Delivery Based on Sender</a> , on page 949 |

### Related Topics

- [Authentication Options for End Users Accessing Spam Management Features](#) , on page 960
- [Setting Up End-User Access to the Spam Quarantine via Web Browser](#) , on page 962
- [Notifying End Users About Quarantined Messages](#) , on page 964

## Authentication Options for End Users Accessing Spam Management Features



**Note** Mailbox authentication does not allow users to view messages addressed to an email alias.

| For End-User Spam Quarantine Access   | Do This  |
|---|--|
| Directly via web browser, authentication required<br>and<br>Via a link in a notification, authentication required     | <ol style="list-style-type: none"> <li>1. In the End User Quarantine Access settings, choose <b>LDAP</b>, or <b>Mailbox (IMAP/POP)</b>.</li> <li>2. In the Spam Notifications settings, deselect <b>Enable login without credentials for quarantine access</b>.</li> </ol> |
| Directly via web browser, authentication required<br>and<br>Via a link in a notification, authentication not required | <ol style="list-style-type: none"> <li>1. In the End User Quarantine Access settings, choose <b>LDAP</b>, or <b>Mailbox (IMAP/POP)</b>.</li> <li>2. In the Spam Notifications settings, select <b>Enable login without credentials for quarantine access</b>.</li> </ol>   |



| For End-User Spam Quarantine Access                            | Do This   |
|--|---|
| Only via a link in a notification, authentication not required | In the End User Quarantine Access settings, choose <b>None</b> as the authentication method.    |
| No access  | In the End User Quarantine Access settings, deselect <b>Enable End-User Quarantine Access</b> . |

### Related Topics

- [LDAP Authentication Process](#) , on page 961
- [Configuring End-User Access to the Spam Quarantine](#) , on page 962
- [Notifying End Users About Quarantined Messages](#) , on page 964
- [Authentication Options for End Users Accessing Spam Management Features](#) , on page 960
- [About End-User Access to Safelists and Blocklists](#) , on page 956

## LDAP Authentication Process

1. A user enters his or her username and passphrase into the web UI login page.
2. The spam quarantine connects to the specified LDAP server either to perform an anonymous search or as an authenticated user with the specified “Server Login” DN and passphrase. For Active Directory, you will usually need to have the server connect on the “Global Catalog port” (it is in the 6000s) and you need to create a low privilege LDAP user that the spam quarantine can bind as in order to execute the search.
3. The spam quarantine then searches for the user using the specified BaseDN and Query String. When a user’s LDAP record is found, the spam quarantine then extracts the DN for that record and attempts bind to the directory using the user records’ DN and the passphrase they entered originally. If this passphrase check succeeds then the user is properly authenticated, but the spam quarantine still needs to determine which mailboxes’ contents to show for that user.
4. Messages are stored in the spam quarantine using the recipient's envelope address. After a user's passphrase is validated against LDAP, the spam quarantine then retrieves the “Primary Email Attribute” from the LDAP record to determine which envelope address they should show quarantined messages for. The “Primary Email Attribute” can contain multiple email addresses which are then used to determine what envelope addresses should be displayed from the quarantine for the authenticated user.

### Related Topics

- [Authentication Options for End Users Accessing Spam Management Features](#) , on page 960

## IMAP/POP Authentication Process

1. Depending on your mail server configuration, a user enters their username ( joe ) or email address ( joe@example.com ) and passphrase into the web UI login page. You can modify the Login Page Message to tell your users whether they should enter a full email address or just their username (see [Configuring End-User Access to the Spam Quarantine](#) , on page 962).
2. The spam quarantine connects to the IMAP or POP server and uses the entered login (either username or email address) and passphrase to try to log into the IMAP/POP server. If the passphrase is accepted then the user is considered authenticated and the spam quarantine immediately logs out of the IMAP/POP server.
3. Once the user is authenticated, the spam quarantine lists email for the user, based on the email address:

- If you have configured the spam quarantine to specify a domain to append to bare usernames (like joe ), then this domain is appended and that fully qualified email address is used to search for matching envelopes in the quarantine.
- Otherwise, the spam quarantine uses the entered email address to search for matching envelopes.

For more information about IMAP, see the University of Washington web site:

<http://www.washington.edu/imap/>

## Setting Up End-User Access to the Spam Quarantine via Web Browser

### Procedure

---

- Step 1** Understand the benefits and limitations of the different authentication methods for end-user access to spam management features.
- Step 2** If you will authenticate end users using LDAP, configure an LDAP server profile, including the **Spam Quarantine End-User Authentication Query** settings on the **System Administration > LDAP > LDAP Server Profile** page.

#### Example:

If you will authenticate end users using SAML 2.0 (SSO), configure the settings on the **System Administration > SAML** page.

- Step 3** Configure end-user access to the spam quarantine.  
[Configuring End-User Access to the Spam Quarantine](#) , on page 962
- Step 4** Determine the URL for end-user access to the spam quarantine.  
[Determining the URL for End-User Access to the Spam Quarantine](#), on page 963
- 

### What to do next

#### Related Topics

- [Configuring End-User Access to the Spam Quarantine](#) , on page 962
- [Determining the URL for End-User Access to the Spam Quarantine](#), on page 963
- [Which Messages an End User Sees](#) , on page 964

## Configuring End-User Access to the Spam Quarantine

Administrative users can access the spam quarantine whether or not end-user access is enabled.

### Before you begin

See requirements in [Authentication Options for End Users Accessing Spam Management Features](#) , on page 960.

## Procedure

- Step 1** If you are on the legacy interface, navigate to **Management Appliance > Centralized Services > Monitor > Spam Quarantine > Edit Settings**, and then scroll down to **End-User Quarantine Access**. If you are on the new web interface, then navigate to Cisco Secure Email and Web Manager, click **Service Status** and hover on  icon and click **Edit End-User Quarantine Settings**. You will be redirected to the legacy interface.
- Step 2** Select **Enable End-User Quarantine Access**.
- Step 3** Specify the method to use to authenticate end users when they attempt to view their quarantined messages.

| Select This Option | More Information  |
|--------------------|---|
| None               | Choose this option to make the quarantined messages accessible to the end-users via links in the spam notification without additional authentication.   |
| Mailbox (IMAP/POP) | <p>For sites without an LDAP directory to use for authentication, the quarantine can validate user email addresses and passphrases against a standards-based IMAP or POP server that holds their mailbox.</p> <p>When logging in to the spam quarantine, end users enter their full email address and mailbox passphrase.</p> <p>If the POP server advertises APOP support in the banner, then for security reasons (i.e., to avoid sending the passphrase in the clear) the Cisco appliance will only use APOP. If APOP is not supported for some or all users then the POP server should be reconfigured to not advertise APOP.</p> <p>Select SSL if you have configured your server to use it. If users enter username only, you can specify a domain to add to automatically complete the email address. Enter the domain of the envelope for users logging in to “Append Domain to Unqualified Usernames.”</p> |
| LDAP               | Configure LDAP settings as described in the sections referenced in the Before You Begin section of this topic.  |

- Step 4** Specify whether or not to display message bodies before messages are released.
- If this box is selected, users may not view the message body via the spam quarantine page. Instead, to view the body of a quarantined message, users must release the message and view it in their mail application (such as Microsoft Outlook). You can use this feature for policy and regulation compliance — for example, if a regulation requires that all viewed email be archived.
- Step 5** Submit and commit your changes.

## Determining the URL for End-User Access to the Spam Quarantine

The URL that end users can use to directly access the spam quarantine is formed from the hostname of the machine and the settings (HTTP/S and port numbers) configured on the IP interface on which the quarantine has been enabled. For example, `HTTP://mail3.example.com:82`.

The end-users can now access the Spam Quarantine on the new web interface in any one of the following ways:

- When `trailblazerconfig` CLI command is enabled, use the following URL -  
`https://example.com:<trailblazer-https-port>/euq-login.`  
 where `example.com` is the appliance host name and `<trailblazer-https-port>` is the trailblazer HTTPS port configured on the appliance.
- When `trailblazerconfig` CLI command is disabled, use the following URL -  
`https://example.com:<https-port>/euq-login.`  
 where `example.com` is the appliance host name and `<https-port>` is the HTTPS port configured on the appliance.



---

**Note** Local and externally-authenticated users cannot log into the end-user Spam Quarantine portal.

---

## Which Messages an End User Sees

Generally, end users see only their own messages in the spam quarantine.

Depending on the method of access (via notification or directly via web browser) and authentication method (LDAP or IMAP/POP), users may see mail for multiple email addresses in the spam quarantine.

When LDAP authentication is used, if the Primary Email attribute has multiple values in the LDAP directory, all of those values (addresses) will be associated with the user. Therefore, quarantined messages addressed to all email addresses associated with the end user in the LDAP directory are present in the quarantine.

If the authentication method is IMAP/POP, or the user accesses the quarantine directly via a notification, then the quarantine will display only messages for that user's email address (or the address to which the notification was sent).

For information about messages that are sent to aliases of which the user is a member, see [Recipient Email Mailing List Aliases and Spam Notifications](#), on page 967.

### Related Topics

- [Configuring End-User Access to the Spam Quarantine](#), on page 962
- [Recipient Email Mailing List Aliases and Spam Notifications](#), on page 967

## Notifying End Users About Quarantined Messages

You can configure the system to send a notification email to some or all users when they have spam and suspected spam messages in the spam quarantine.

By default, spam notifications lists the end user's quarantined messages. Notifications include a link that you can use to view the quarantined messages in the spam quarantine. You can then decide whether to have the quarantined messages delivered to the inbox or to delete them.



---



**Note** In cluster configurations, you can choose which users receive notifications only at the machine level.

---

### Before you begin

- For end users to manage messages listed in notifications, they must be able to access the spam quarantine. See [Configuring End-User Access to the Spam Quarantine](#) , on page 962.
- Understand and implement the authentication options for managing spam using notifications. See [Authentication Options for End Users Accessing Spam Management Features](#) , on page 960.
- If end users receive email at multiple aliases, see [Recipient Email Mailing List Aliases and Spam Notifications](#) , on page 967.

### Procedure

- 
- Step 1** [New Web Interface Only] On the email gateway, click  to load the legacy web interface.
- Step 2** If you are on the legacy interface, navigate to **Management Appliance > Centralized Services > Spam Quarantine > Edit Settings**, and then scroll down to **Spam Notifications**. However if you are on the new web interface, navigate to Cisco Secure Email and Web Manager, click **Service Status**, hover over the  icon, and click **Edit Spam Notification Settings**. You will be redirected to the legacy interface.
- Step 3** Select **Enable Spam Notification**.
- Step 4** Enter a From: address for the notifications.
- Step 5** Specify the end-users whom you want to notify.
- Step 6** (Optional) Customize the subject for the notification.
- Step 7** (Optional) Customize the title for the notification.
- Step 8** Select the default language for notifications.
- Step 9** Configure the quarantine access for the end-users.
- a) Check the **Login without credentials** check box to automatically log users into the spam quarantine when they access it by clicking a link in a notification. The end-users can release messages by clicking the **Release** links in the notification. If you uncheck this option, the end-users cannot release messages by clicking the **Release** links in the notification.  
  
This option is visible only if you choose one of the following end-user authentication methods: Mailbox (IMAP/POP), LDAP, or SAML 2.0. If you have chosen None as the authentication method, when the end-users click on the links in the spam notification, they are automatically logged into the spam quarantine.
  - b) Set an expiration period (in days) for the links in the notification. Enter a number between 0 and 365. These links will expire automatically after the specified period. Enter 0 if you do not want the links to expire.  
  
(For Mailbox (IMAP/POP), LDAP, and SAML 2.0) This option is configurable only if you check the **Login without credentials** check box.  
  
You can also set the expiration period using the **spamdigestconfig** command in the CLI.
- Step 10** Customize the message body:
- a) (Optional) Customize the default text and variables.  
  
To insert a variable, place the cursor where you would like the variable inserted and then click the name of the variable in the Message Variables listing on the right. Or type in the variable.  
  
The following message variables are expanded to the actual value for the specific end user:

- **New Message Count** ( %new\_message\_count% )— The number of new messages since the user last logged in.
- **Total Message Count** ( %total\_message\_count% )— The number of messages for the user in the spam quarantine.
- **Days Until Message Expires** ( %days\_until\_expire% )
- **Quarantine URL** ( %quarantine\_url% )— URL to log in to the quarantine and view messages.
- **Username** ( %username% )
- **New Message Table** ( %new\_quarantine\_messages% )— A list of the user’s new quarantined messages, showing sender, message subject, date, and a link to release the message. The user clicks a message subject to view the message in the spam quarantine.
- **New Message Table without Subject** ( %new\_quarantine\_messages\_no\_subject% ) — Similar to New Message Table, but only a “View Message” link is shown in place of the subject for each message.

- b) Choose whether to show or hide the links to view all the quarantined messages in a spam notification. Under **Show link to see all quarantined messages in Notification Mails**, choose **Yes** or **No** depending on your requirement.

(For Mailbox (IMAP/POP), LDAP, and SAML 2.0). This option is visible only if you check the **Login without credentials** check box (under Quarantine Access).

If you choose **Yes**, you can force the end-user to authenticate before accessing the spam quarantine. Check **Challenge Access**. This option is not available if you have chosen None as the end-user authentication method.

You can also show or hide the links using the **spamdigestconfig** command in the CLI.

- c) Click **Preview Message** to verify that the message is as you want it to be.

- Step 11** Select a message format (HTML, Text, or HTML/Text).
- Step 12** Specify the address to which bounced notifications will be sent.
- Step 13** (Optional) Select **Consolidate messages sent to the same LDAP user at different addresses**.
- Step 14** Set the notification schedule.
- Step 15** Submit and commit your changes.

---

### What to do next

To ensure that end users receive these notifications, consider recommending that they add the From: address for the spam quarantine notification emails to the “allowed list” in the junk mail settings of their mail application (such as Microsoft Outlook or Mozilla Thunderbird.)

### Related Topics

- [Recipient Email Mailing List Aliases and Spam Notifications](#) , on page 967
- [Testing Notifications](#), on page 967
- [Troubleshooting Spam Notifications](#) , on page 967

## Recipient Email Mailing List Aliases and Spam Notifications

Notifications can be sent to each Envelope Recipient that has quarantined email, including mailing lists and other aliases. Each mailing list receives a single digest. If you send notifications to a mailing list, all subscribers to the list will receive the notification. Users who belong to multiple email aliases, or who belong to LDAP groups that receive notifications, or who use several email addresses, may receive multiple spam notifications. The following table shows example situations in which users may receive multiple notifications.

**Table 93: Notifications per Address/Alias**

| User | Email Addresses                    | Aliases   | Notifications |
|------|------------------------------------|---|---------------|
| Sam  | sam@example.com                    | —   | 1             |
| Mary | mary@example.com                   | dev@example.com<br>qa@example.com<br>pm@example.com | 4             |
| Joe  | joe@example.com, admin@example.com | hr@example.com                                      | 3             |

If you use LDAP authentication, you can choose not to send notifications to mailing list aliases. Or, if you choose to send spam notifications to mailing list aliases, you can prevent some occurrences of multiple notifications. See [Spam Quarantine Alias Consolidation Queries](#), on page 812.

Users who access the spam quarantine by clicking a link in a notification will not see quarantined messages for any other aliases that the end-user may have, unless the appliance is using a spam quarantine alias consolidation query for email notifications. If the notification was sent to a distribution list that is expanded after processing by the appliance, then multiple recipients may have access to the same quarantine for that list.

This means that all subscribers to a mailing list will receive the notification and can log in to the quarantine to release or delete messages. In this case, end users visiting the quarantine to view messages mentioned in a notification may find that those messages have already been deleted by other users.



---

**Note** If you do not use LDAP and you do not want your end users to receive multiple email notifications, consider disabling notifications and instead allow end users to access the quarantine directly and authenticate via LDAP or POP/IMAP.

---

## Testing Notifications

You can test notifications by configuring a testing mail policy, and having spam quarantined for just a single user. Then, configure the spam quarantine notification settings: Select the **Enable Spam Notification** checkbox and do not select **Enable End-User Quarantine Access**. Then only the administrator configured in the **Deliver Bounced Messages To** field is notified of new spam in the quarantine.

## Troubleshooting Spam Notifications

### Related Topics

- [User Receives Multiple Notifications](#) , on page 968

- [Recipient Does Not Receive Notifications](#) , on page 968
- [User Receives Multiple Notifications](#) , on page 968
- [Recipient Does Not Receive Notifications](#) , on page 968

### User Receives Multiple Notifications

#### Problem

A user receives multiple spam notifications for a single message.

#### Solution

Possible causes:

- The user has multiple email addresses and the spam message was sent to more than one of those addresses.
- The user is a member of one or more email aliases that received the spam message. To minimize duplications, and for more information, see [Recipient Email Mailing List Aliases and Spam Notifications](#) , on page 967.

### Recipient Does Not Receive Notifications

#### Problem

Recipient is not receiving spam notifications.

#### Solution

- If notifications are being sent to the “Deliver Bounce Messages To:” address instead of to spam recipients, this means that spam notifications are enabled, but spam quarantine access is not enabled. See [Authentication Options for End Users Accessing Spam Management Features](#) , on page 960.
- Have the user check the junk mail settings of their email client.

## Managing Messages in the Spam Quarantine

This section explains how to work with messages in local or external spam quarantines.

Administrative users can see and manage all messages in the spam quarantine.

#### Related Topics

- [Accessing the Spam Quarantine \(Administrative Users\)](#), on page 968
- [Searching for Messages in the Spam Quarantine](#), on page 969
- [Viewing Messages in the Spam Quarantine](#), on page 969
- [Delivering Messages in the Spam Quarantine](#), on page 970
- [Deleting Messages from the Spam Quarantine](#), on page 970

## Accessing the Spam Quarantine (Administrative Users)

Administrative users can see and manage all messages in the spam quarantine.



### Procedure

---

- Step 1** [New Web Interface Only] Choose **Quarantine > Spam Quarantine > Search**.
- Step 2** Select **Monitor > Spam Quarantine**, then click the number in the Messages column.
- 

## Searching for Messages in the Spam Quarantine

### Procedure

---

- Step 1** Specify an envelope recipient.
- Note** You can enter a partial address.
- Step 2** Select whether the search results should match the exact recipient you entered, or whether the results should contain, start with, or end with your entry.
- Step 3** Enter a date range to search through. Click the calendar icons to select a date.
- Step 4** Specify a From: address, and select whether the search results should contain, match exactly, start with, or end with the value you entered.
- Step 5** Click **Search**. Messages matching your search criteria are displayed below the Search section of the page.
- 

### What to do next

#### Related Topics

[Searching Very Large Message Collections, on page 969](#)

## Searching Very Large Message Collections

If you have a very large collection of messages in the spam quarantine, and if your search terms are not narrowly defined, your query may take a very long time to return information, or it may time out.

You will be prompted to confirm whether you want to resubmit your search. Please note that having multiple large searches running simultaneously can impact performance.

## Viewing Messages in the Spam Quarantine

The message listing shows messages in the spam quarantine. You can select how many messages are shown at one time. You can sort the display by clicking on the column headings. Click the same column again to reverse the sorting.

Click the subject of a message to view the message, including the body and headers. The message is displayed in the Message Details page. The first 20K of the message is displayed. If the message is longer, it is truncated at 20K and you can download the message via the link at the bottom of the message.

From the Message Details page you can delete a message (select **Delete**) or select **Release** to release the message. Releasing a message causes it to be delivered.

To view additional details about the message, click the **Message Tracking** link.

Note the following:

- **Viewing Messages with Attachments**

When viewing a message that includes an attachment, the body of the message is displayed, followed by a list of attachments.

- **Viewing HTML Messages**

The spam quarantine attempts to render an approximation of HTML-based messages. Images are not displayed.

- **Viewing Encoded Messages**

Base64-encoded messages are decoded and then displayed.

## Delivering Messages in the Spam Quarantine

To release a message for delivery, click the checkbox next to the message or messages that you want to release and select **Release** from the drop-down menu. Then click **Submit**.

Click the checkbox in the heading row to automatically select all messages currently displayed on the page.

Released messages proceed directly to the destination queue, skipping any further work queue processing in the email pipeline.

## Deleting Messages from the Spam Quarantine

The spam quarantine can be configured to automatically delete messages after a certain amount of time. Also, the spam quarantine can be configured to automatically delete the oldest messages once the quarantine has reached its maximum size. You may also delete messages from the spam quarantine manually.

To delete specific messages, click the checkbox next to the messages that you want to delete and then select **Delete** from the drop-down menu. Then click **Submit**. Click the checkbox in the heading row to automatically select all of the messages currently displayed on the page.

To delete all messages in the spam quarantine, disable the quarantine (see [About Disabling the External Spam Quarantine](#), on page 971) and then click the **Delete All Messages** link. The number in parenthesis at the end of the link is the number of messages in the spam quarantine.

## Disk Space for the Spam Quarantine

By default, messages in the spam quarantine are automatically deleted after a set amount of time. If the quarantine gets full, older spam is deleted.

### Related Topics

- [Managing Disk Space](#), on page 1026

## About Disabling the External Spam Quarantine

If you disable the spam quarantine:

- If messages are present in the spam quarantine when it is disabled, you can opt to delete all of the messages.
- Any mail policies set to quarantine spam or suspected spam will instead be set to deliver the message. You may need to adjust mail policies .
- To completely disable an external spam quarantine, disable it on both the email gateway and the Cisco Secure Email and Web Manager.

Disabling an external spam quarantine on the email gateway only does not delete the external quarantine or its messages and data.

## Troubleshooting Spam Quarantine Features

- [Troubleshooting Safelists and Blocklists](#), on page 959
- [Troubleshooting Spam Notifications](#) , on page 967
- [Ensuring That Message Text Displays Correctly](#) , on page 948



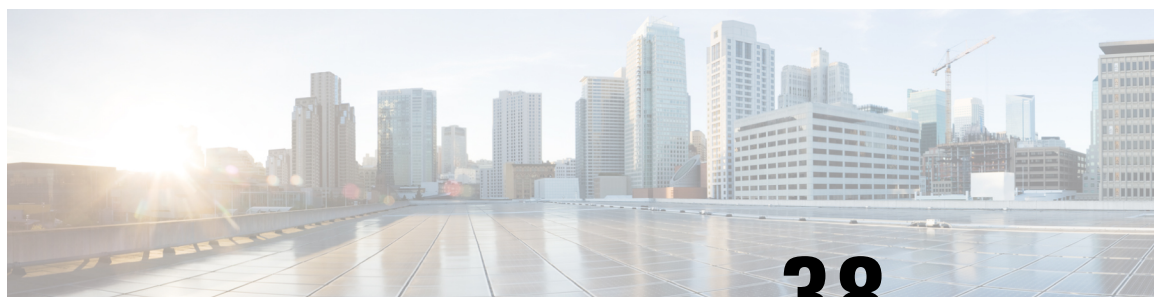

## CHAPTER 38

# Distributing Administrative Tasks

This chapter contains the following sections:

- [Working with User Accounts, on page 973](#)
- [Managing Custom User Roles for Delegated Administration, on page 978](#)
- [Passphrases, on page 986](#)
- [Configuring Access to the Email Gateway, on page 993](#)
- [Displaying Messages to Administrative Users , on page 997](#)
- [Managing Secure Shell \(SSH\) Keys, on page 997](#)
- [Monitoring Administrative User Access , on page 1000](#)

## Working with User Accounts

The email gateway provides two methods for adding user accounts: creating user accounts on the email gateways itself, and enabling user authentication using your own centralized authentication system, which can be either an LDAP or RADIUS directory. You can manage users and connections to external authentication sources on the **System Administration > Users** page in the GUI (or by using the `userconfig` command in the CLI). For information about using an external directory to authenticate users, see [External Authentication, on page 988](#).

Optionally, you can enable two-factor authentication for specific user roles through:

- The System Administration > Users page in the web interface. See [Two-Factor Authentication, on page 992](#).
- The `userconfig > twofactorauth` command in the CLI. See the *CLI Reference Guide for AsyncOS for Cisco Secure Email Gateway*.

The default user account for the system, admin, has all administrative privileges. The admin user account cannot be deleted, but you can change the passphrase and lock the account.

When you create a new user account, you assign the user to a predefined or a custom user role. Each role contains differing levels of permissions within the system.

Although there is no limit to the number of user accounts that you can create on the email gateway, you cannot create user accounts with names that are reserved by the system. For example, you cannot create the user accounts named “operator” or “root.”

# User Roles

Table 94: User Roles Listing

| User Role     | Description   |
|---------------|---|
| admin         | <p>The admin user is the default user account for the system and has all administrative privileges. The admin user account is listed here for convenience, but it cannot be assigned via a user role, and it cannot be edited or deleted, aside from changing the passphrase.</p> <p>Only the admin user can issue the <b>resetconfig</b> and <b>revert</b> commands.</p>   |
| Administrator | <p>User accounts with the Administrator role have full access to all configuration settings of the system. However, only the admin user has access to the <b>resetconfig</b> and <b>revert</b> commands.</p> <p><b>Note</b> AsyncOS does not support multiple administrators configuring the email gateway from the GUI simultaneously.</p>   |
| Technician    | <p>User accounts with the Technician role can perform system upgrades, reboot the email gateway, and manage feature keys. Technicians can also perform the following actions in order to upgrade the email gateway:</p> <ul style="list-style-type: none"> <li>• Suspend email delivery and receiving.</li> <li>• View status of workqueue and listeners.</li> <li>• Save and email configuration files.</li> <li>• Back up safelists and blocklists. Technicians cannot restore these lists.</li> <li>• Disconnect the email gateway from a cluster.</li> <li>• Enable or disable remote service access for Cisco technical support.</li> <li>• Raise a support request.</li> </ul>  |
| Operator      | <p>User accounts with the Operator role are restricted from:</p> <ul style="list-style-type: none"> <li>• Creating or editing user accounts.</li> <li>• Issuing the <b>resetconfig</b> command.</li> <li>• Upgrading the email gateway.</li> <li>• Issuing the <b>systemsetup</b> command or running the System Setup Wizard.</li> <li>• Issuing the <b>adminaccessconfig</b> command.</li> <li>• Performing some quarantine functions (including creating, editing, deleting, and centralizing quarantines).</li> <li>• Modifying LDAP server profile settings other than username and passphrase, if LDAP is enabled for external authentication.</li> </ul> <p>Otherwise, they have the same privileges as the Administrator role.</p> |
| Guest         | <p>Users accounts with the Guest role can only view status information and reports. Users with the Guest role can also manage messages in quarantines, if access is enabled in a quarantine. Users with the Guest role cannot access Message Tracking.</p>  |

| User Role          | Description  |
|--------------------|--|
| Read-Only Operator | <p>User accounts with the Read-Only Operator role have access to view configuration information. Users with the Read-Only Operator role can make and submit changes to see how to configure a feature, but they cannot commit them. Users with this role can manage messages in quarantines, if access is enabled in a quarantine.</p> <p>Users with this role cannot access the following:</p> <ul style="list-style-type: none"> <li>• File system, FTP, or SCP.</li> <li>• Settings for creating, editing, deleting, or centralizing quarantines.</li> </ul>  |
| Help Desk User     | <p>User accounts with the Help Desk User role are restricted to:</p> <ul style="list-style-type: none"> <li>• Message tracking.</li> <li>• Managing messages in quarantines.</li> </ul> <p>Users with this role cannot access to the rest of the system, including the CLI. You need to enable access in each quarantine before a user with this role can manage them.</p>   |
| Custom user role   | <p>User accounts with a custom user role can only access email security features assigned to the role. These features can be any combination of DLP policies, email policies, reports, quarantines, local message tracking, encryption profiles, Trace debugging tool, and access log subscriptions, Logging APIs, and log files. The users cannot access system configuration features, including enabling features globally. Only administrators can define custom user roles. See <a href="#">Managing Custom User Roles for Delegated Administration, on page 978</a> for more information.</p> <p><b>Note</b> Users assigned to custom roles cannot access the CLI.</p> |

All roles defined in the above table can access both the GUI and the CLI, except the Help Desk User role and custom user roles, which can only access the GUI.

If you use an LDAP directory to authenticate users, you assign directory groups to user roles instead of individual users. When you assign a directory group to a user role, each user in that group receives the permissions defined for the user role. For more information, see [External Authentication, on page 988](#).

### Related Topics

- [Managing Users, on page 975](#)

## Managing Users

The Users page lists the existing users for the system, including the username, full name, and user type or group.

From the Users page, you can:

- Add new users. For more information, see [Adding Users , on page 976](#).
- Delete users. For more information, see [Deleting Users, on page 977](#).

- Edit users, such as changing a user’s passphrase and locking and unlocking a user’s account. For more information, see [Editing Users, on page 976](#).
- Force users to change their passphrases. See [Force Users To Change Their Passphrases, on page 977](#).
- Configure user account and passphrase settings for local accounts. For more information, see [Configuring Restrictive User Account and Passphrase Settings, on page 987](#).
- Enable the email gateway to use an LDAP or RADIUS directory to authenticate users. For more information, see [External Authentication, on page 988](#).
- Enable two-factor authentication for specific user roles. For more information, see [Two-Factor Authentication, on page 992](#).
- Enable access for non-administrators to DLP Matched Content in Message Tracking. See [Controlling Access to Sensitive Information in Message Tracking, on page 977](#) for more information.

## Adding Users

### Before You Begin

- Determine the user roles you will use.
  - For descriptions of predefined user roles, see [User Roles , on page 974](#).
  - To create custom roles, see [Managing Custom User Roles for Delegated Administration, on page 978](#).
- Specify your passphrase requirements. See [Configuring Restrictive User Account and Passphrase Settings, on page 987](#).

### Procedure

---

**Step 1** Choose **System Administration > Users**.

**Step 2** Click **Add User**.

**Step 3** Enter a login name for the user. Some words are reserved (such as “operator” or “root”).

**Step 4** Enter the user’s full name.

**Step 5** Select a predefined or custom user role.

**Step 6** Enter a passphrase.

**Note** In addition to creating a login passphrase manually, you can also create a system-generated passphrase to log in to your email gateway.

**Step 7** Submit and commit your changes.

---

## Editing Users

Use this procedure to change a passphrase, etc.



### Procedure

---

- Step 1** Choose **System Administration > Users**.
  - Step 2** Click the user's name in the Users listing.
  - Step 3** Make changes to the user.
  - Step 4** Submit and commit your changes.
- 

## Force Users To Change Their Passphrases

### Procedure

---

- Step 1** Choose **System Administration > Users**.
  - Step 2** Select the users from the Users listing.
  - Step 3** Click **Enforce Passphrase Change**.
  - Step 4** Choose whether the users must change the passphrase during the next login or after a specified duration (in days).
  - Step 5** (Optional) If you are enforcing a passphrase change after a specified duration, set the grace period (in days) to reset the passphrase after the passphrase expires.
  - Step 6** Click **OK**.
  - Step 7** Submit and commit your changes.
- 

## Deleting Users

### Procedure

---

- Step 1** Click the trash can icon corresponding to the user's name in the Users listing.
  - Step 2** Confirm the deletion by clicking **Delete** in the warning dialog that appears.
  - Step 3** Commit your changes.
- 

## Controlling Access to Sensitive Information in Message Tracking

You may want to restrict administrative access to message details that are likely to include sensitive information:

- Messages that violate Data Loss Prevention (DLP) policies may include information such as corporate confidential information or personal information including credit card numbers and health records. By default, this content is visible to all users who have access to the email gateway.
- URLs that are caught by outbreak filters or by content filters that are based on URL reputation or category may also be considered sensitive. By default, only users with Administrator privileges can view this content.

This sensitive content appears in dedicated tabs on the Message Details page for messages listed in Message Tracking results.

You can hide these tabs and their content from administrative users based on their user role. However, although there is an option to hide this sensitive content from users who have the Administrator role, any user with the Administrator role can change these permissions and thus view sensitive information at any time.

### Before You Begin

Ensure that you have met the prerequisites for these features. See [Displaying URL Details in Message Tracking](#), on page 457.

### Procedure

---

- Step 1** Go to the **System Administration > Users** page.
  - Step 2** Under **Access to Sensitive Information in Message Tracking**, click **Edit Settings**.
  - Step 3** Select the roles for which you want to grant access to each type of sensitive information.  
Custom roles without access to Message Tracking can never view this information and thus are not listed.
  - Step 4** Submit and commit your changes.
- 

### What to do next

#### Related Topics

- [Message Tracking Details](#), on page 918
- [Displaying Sensitive DLP Data in Message Tracking](#), on page 531
- [Displaying URL Details in Message Tracking](#), on page 457

## Managing Custom User Roles for Delegated Administration

You can design custom user roles and delegate specific responsibilities to users that align with their roles within your organization, allowing these *delegated administrators* access only to the email security features they are responsible for and not the system configuration features that are not related to their roles. Delegated administration provides more flexible control over your users' access to the email security features on the email gateway than the predefined administrator, operator, and help desk user roles.

For example, you may have users who are responsible for managing mail policies for specific domains on the email gateway, but you do not want these users to access the system administration and security services configuration features, which the predefined administrator and operator roles grant. You can create a custom user role for mail policy administrators who can grant these users access to the mail policies they manage, along with other email security features that they can use to manage messages processed by these policies, such as Message Tracking and policy quarantines.

Use the **System Administration > User Roles** page in the GUI (or the `userconfig -> role` command in the CLI) to define custom user roles and manage the email security features for which they are responsible, such as mail policies, DLP policies, email reports, and quarantines. For a full list of email security features that delegated administrators can manage, see [Assigning Access Privileges](#), on page 980. Custom roles can also be created when adding or editing a local user account using the **System Administration > Users** page. See [Defining a Custom User Role When Adding a User Account](#), on page 984 for more information.

You should make sure when creating a custom user role so that its responsibilities don't overlap too much with the responsibilities of other delegated administrators. If multiple delegated administrators are responsible for the same content filter, for example, and use the content filter in different mail policies, the changes made to the filter by one delegated administrator may cause unintended side effects for the mail policies managed by other delegated administrators.

When you have created the custom user roles, you can assign local users and external authentication groups to them like any other user role. See [Working with User Accounts, on page 973](#) for more information. Please note that users assigned to custom roles cannot access the CLI.

### Related Topics

- [Account Privileges Page, on page 979](#)
- [Assigning Access Privileges, on page 980](#)
- [Defining a Custom User Role, on page 984](#)
- [Defining a Custom User Role When Adding a User Account, on page 984](#)
- [Updating Responsibilities for a Custom User Role, on page 985](#)
- [Editing a Custom User Role, on page 985](#)
- [Duplicating a Custom User Role, on page 985](#)
- [Deleting a Custom User Role, on page 986](#)

## Account Privileges Page

When a delegated administrator logs into the email gateway, the Account Privileges page displays links to the security features for which the delegated administrator is responsible and brief descriptions of their access privileges. A delegated administrator can return to this page by selecting Account Privileges in the Options menu. Delegated administrators can also access the features that they manage using the menu at the top of the web page.

The following figure shows an Account Privileges page for a delegated administrator with access to mail policies, email reporting, message tracking, and quarantines.

**Figure 72: Account Privileges Page for a Delegated Administrator**

| Account Privileges (bob1) |  |
|---------------------------|--|
| <b>Mail Policies</b>      | Incoming Mail Policies (1)<br>Incoming Content Filters (1)<br>Outgoing Mail Policies (1)<br>Outgoing Content Filters (None Assigned)<br><i>Configure Email Policies and Content Filters.</i> |
| <b>Email Reporting</b>    | Policy Reporting and DLP Reporting<br><i>View and analyze email traffic.</i>   |
| <b>Message Tracking</b>   | Message Tracking<br><i>Track messages.</i>   |
| <b>Quarantine</b>         | Manage Message Quarantines (1)<br><i>Manage messages in assigned Quarantines.</i>  |

## Assigning Access Privileges

When creating a custom user role, you define the levels of access to the security features for which delegated administrators are responsible.

The security features available for delegated administrators to manage are:

- Incoming and outgoing mail policies and content filters
- Data Loss Prevention (DLP) policies
- Email reporting
- Message Tracking
- The Trace debugging tool
- Spam, policy, virus, and outbreak quarantines
- Cisco Email Encryption profiles
- Log Subscription

After defining the access levels for a custom user role, you need to assign the specific mail policies, content filters, DLP policies, quarantines, or encryption profiles for which the delegated administrators will be responsible.

For example, you can create two different DLP policy administrator roles that are responsible for different DLP policies. One role is only responsible for DLP violations related to company confidentiality and acceptable use, while the other is responsible for DLP violations related to privacy protection. In addition to DLP policies access, these custom user roles can also be assigned privileges for tracking message data and viewing quarantines and reports. They can search for DLP violations related to the policies that they are responsible for in using Message Tracking.

You can view which responsibilities are available to assign to a custom user role by clicking on the links for the assigned privileges in the Custom User Roles for Delegated Administration table on the User Roles page. See [Updating Responsibilities for a Custom User Role](#), on page 985.

### Related Topics

- [Mail Policies and Content Filters](#), on page 980
- [DLP Policies](#), on page 981
- [Email Reporting](#), on page 982
- [Message Tracking](#), on page 983
- [Trace](#), on page 983
- [Quarantines](#), on page 983
- [Encryption Profiles](#), on page 983
- [Log Subscription](#), on page 984

## Mail Policies and Content Filters

The Mail Policies and Content Filters access privileges define a delegated administrator's level of access to the incoming and outgoing mail policies and content filters on the email gateway. You can assign specific mail policies and content filters to a custom user role, allowing only the delegated administrators belonging to this role, along with operators and administrators, to manage the mail policies and content filters.

All delegated administrators with this access privilege can view the default incoming and outgoing mail policies but they can only edit these policies if they have full access.

All delegated administrators with access privileges can create new content filters to use with their mail policies. A content filter created by a delegated administrator is available to the other delegated administrators assigned to the custom user role. Content filters that are not assigned to any custom user role are public and can be viewed by all delegated administrators with the mail policy access privilege. Content filters created by operators and administrators are *public* by default. Delegated administrators can enable or disable any existing content filters on mail policies assigned to their custom user role, but they cannot modify or delete public content filters.

If a delegated administrator deletes a content filter used by mail policies other than their own, or if the content filter is assigned to other custom user roles, AsyncOS does not delete the content filter from the system. AsyncOS instead unlinks the content filter from the custom user role and removes it from the delegated administrator's mail policies. The content filter remains available to other custom user roles and mail policies.

Delegated administrators can use any text resource or dictionary in their content filters, but they cannot access the Text Resources or Dictionaries pages in the GUI to view or modify them. Delegated administrators also cannot create new text resources or dictionaries.

For outgoing mail policies, delegated administrators can enable or disable DLP policies but they cannot customize the DLP settings unless they also have DLP policy privileges.

You can assign one of the following access levels for mail policies and content filters to a custom user role:

- **No access:** Delegated administrators cannot view or edit mail policies and content filters on the email gateway.
- **View assigned, edit assigned:** Delegated administrators can view and edit the mail policies and content filters assigned to the custom user role and create new content filters. Delegated administrators can edit a policy's Anti-Spam, Anti-Virus, and Outbreak Filters settings. They can enable their content filters for the policy, as well as disable any existing content filter assigned to the policy, regardless of whether they are responsible for it. Delegated administrators cannot modify a mail policy's name or its senders, recipients, or groups. Delegated administrators can modify the order of the content filters for mail policies assigned to their custom user role.
- **View all, edit assigned:** Delegated administrators can view all mail policies and content filters on the email gateway, but they can only edit the ones assigned to the custom user role.

**View all, edit all (full access):** Delegated administrators have full access to all of the mail policies and content filters on the email gateway, including the default mail policies, and have the ability to create new mail policies. Delegated administrators can modify the senders, recipients, and groups of all mail policies. They can also reorder mail policies.

You can assign individual mail policies and content filters to the custom user role using either the Email Security Manager or the Custom User Roles for Delegated Administration table on the User Roles page.

See [Updating Responsibilities for a Custom User Role](#), on page 985 for information on using the Custom User Roles for Delegated Administration table to assign mail policies and content filters.

## DLP Policies

The DLP Policies access privileges define a delegated administrator's level of access to the DLP policies via the DLP Policy Manager on the email gateway. You can assign DLP policies to specific custom user roles, allowing delegated administrators, in addition to operators and administrators, to manage these policies. Delegated administrators with DLP access can also export DLP configuration files from the Data Loss Prevention Global Settings page.

If a delegated administrator also has mail policy privileges, they can customize the DLP policies. Delegated administrators can use any custom DLP dictionary for their DLP policies, but they cannot view or modify the custom DLP dictionaries.

You can assign one of the following access levels for DLP policies to a custom user role:

- **No access:** Delegated administrators cannot view or edit DLP policies on the email gateway.
- **View assigned, edit assigned:** Delegated administrators can use the DLP Policy Manager to view and edit the DLP policies assigned to the custom user role. Delegated administrators cannot rename or reorder DLP policies in the DLP Policy Manager. Delegated administrators can export DLP configurations.
- **View all, edit assigned:** Delegated administrators can view and edit the DLP policies assigned to the custom user role. They can export DLP configurations. They can also view all DLP policies that are not assigned to the custom user role but they cannot edit them. Delegated administrators cannot reorder DLP policies in the DLP Policy Manager or rename the policy.
- **View all, edit all (full access):** Delegated administrators have full access to all of the DLP policies on the email gateway, including the ability to create new ones. Delegated administrators can reorder DLP policies in the DLP Policy Manager. They cannot change the DLP mode that the email gateway uses.

You can assign individual DLP policies to the custom user role using either the DLP Policy Manager or the Custom User Roles for Delegated Administration table on the User Roles page.

See [Data Loss Prevention, on page 505](#) for more information on DLP policies and the DLP Policy Manager.

See [Updating Responsibilities for a Custom User Role, on page 985](#) for information on using the Custom User Roles for Delegated Administration list to assign DLP policies.

## Email Reporting

The Email Reporting access privileges define which reports and Email Security Monitor pages a delegated administrator can view, depending on the custom user role's access to mail policies, content filters, and DLP policies. These reports are not filtered for assigned policies; delegated administrators can view reports for mail and DLP policies that for which they are not responsible.

You can assign one of the following access levels for email reporting to a custom user role:

- **No access:** Delegated administrators cannot view reports on the email gateway.
- **View relevant reports:** Delegated administrators can view reports on the Email Security Monitor pages related to their Mail Policies and Content Filters and DLP Policies access privileges. Delegated administrators with Mail Policies and Content Filters access privileges can view the following Email Security Monitor pages:
  - Overview
  - Incoming Mail
  - Outgoing Destinations
  - Outgoing Senders
  - Internal Users
  - Content Filters
  - Virus Outbreaks
  - Virus Types
  - Archived Reports

Delegated administrators with DLP Policies access privileges can view the following Email Security Monitor pages:

- Overview
  - DLP Incidents
  - Archived Reports
- **View all reports:** Delegated administrators can view all reports and Email Security Monitor pages on the email gateway.

See the [Using Email Security Monitor, on page 829](#) chapter for more information on email reporting and the Email Security Monitor.

## Message Tracking

The Message Tracking access privileges define whether delegated administrators assigned to the custom user role have access to Message Tracking, including message content that may violate your organization's DLP policies if the DLP Tracking Policies option has been enabled on the **System Administration > Users** page and the custom user role also has DLP policies access privileges.

Delegated administrators can only search for the DLP violations for the DLP policies assigned to them.

See [Tracking Messages, on page 911](#) for more information on Message Tracking.

See [Controlling Access to Sensitive Information in Message Tracking, on page 977](#) for information for allowing delegated administrators access to viewing matched DLP content in Message Tracking.

## Trace

The Trace access privileges define whether delegated administrators assigned to the custom user role can use Trace to debug the flow of messages through the system. Delegated administrators with access can run Trace and view all of the generated output. Trace results are not filtered based on the delegated administrator's mail or DLP policy privileges.

See [Debugging Mail Flow Using Test Messages: Trace, on page 1255](#) for more information on using Trace.

## Quarantines

The Quarantines access privileges define whether delegated administrators can manage assigned quarantines. Delegated administrators can view and take actions on any message in an assigned quarantine, such as releasing or deleting messages, but cannot change the quarantine's configuration (e.g. the size, retention period, etc.), or create or delete quarantines.

You can assign any of the quarantines to the custom user role using either the Monitor > Quarantines page or the Custom User Roles for Delegated Administration table on the User Roles page.

See [About Distributing Message Processing Tasks to Other Users , on page 932](#) and [Configuring Administrative User Access to the Spam Quarantine , on page 947](#) for more information on assigning Quarantine management tasks to administrative users.

See [Updating Responsibilities for a Custom User Role , on page 985](#) for information on using the Custom User Roles for Delegated Administration list to assign quarantines.

## Encryption Profiles

The Encryption Profiles access privileges define whether delegated administrators can use encryption profiles assigned to their custom user role when editing content filters or DLP policies. Encryption profiles can only be assigned to custom user roles with mail or DLP policy access privileges. Encryption profiles that are not

assigned to a custom role are available for use by all delegated administrators with mail or DLP policy privileges. Delegated administrators cannot view or modify any encryption profiles.

You can assign encryption profiles when creating or editing an encryption profile using the Security Services > IronPort Email Encryption page.

## Log Subscription

The Log Subscription access privileges define whether delegated administrators assigned to the custom user role can access log subscriptions or Logging APIs to view or download log files.

## Defining a Custom User Role

User the User Roles page in the GUI (or the `userconfig -> role` command in the CLI) to define a new user role and assign its access privileges. The User Roles page displays all existing custom user roles on the email gateway and the access privileges for each role.

### Procedure

---

- Step 1** Choose **System Administration > User Roles**.
  - Step 2** Click **Add User Role**.
  - Step 3** Enter a name for the user role.
  - Step 4** Enter a description of the user role and its privileges.
  - Step 5** Select the user role's access privileges. (See [Assigning Access Privileges, on page 980](#) for more information on each type of access privilege.)
  - Step 6** Submit and commit your changes.
- 

## Defining a Custom User Role When Adding a User Account

You can create a new custom user role when adding or editing a local user account on the email gateway. See [Managing Users, on page 975](#) for more information on adding a user account.

### Procedure

---

- Step 1** Go to the **System Administration > Users** page.
- Step 2** Click **Add User**.
- Step 3** When creating the user account, select Custom Roles.
- Step 4** Select **Add Role**.
- Step 5** Enter the name for the new role.
- Step 6** Submit the new user account.  
  
AsyncOS displays a notification that the new user account and custom user role have been added.
- Step 7** Go to the **System Administration > User Roles** page.



- Step 8** Click on the name of the custom user role in the Custom User Roles for Delegated Administration table.
  - Step 9** Enter a description of the user role and its privileges.
  - Step 10** Select the user role's access privileges. (See [Assigning Access Privileges, on page 980](#) for more information on each type of access privilege.)
  - Step 11** Submit and commit your changes.
- 

## Updating Responsibilities for a Custom User Role

### Procedure

---

- Step 1** Go to the **System Administration > User Roles** page.
  - Step 2** Click the name of the access privilege for the custom user role you want to update.  
  
AsyncOS displays a list of all the mail policies, content filters, DLP policies, or quarantines available on the email gateway, along with the names of any other assigned custom user roles.
  - Step 3** Select the mail policies, content filters, DLP policies, or quarantines for which you want the delegated administrators assigned to be responsible.
  - Step 4** Submit and commit your changes.
- 

## Editing a Custom User Role

### Procedure

---

- Step 1** Go to the **System Administration > User Roles** page.
  - Step 2** Click the user role's name in the Custom User Roles for Delegated Administration listing.
  - Step 3** Make changes to the user role.
  - Step 4** Submit and commit your changes.
- 

## Duplicating a Custom User Role

You may want to create multiple custom user roles with similar access privileges but assign different responsibilities to different sets of users. For example, if the email gateway handles messages for multiple domains, you may want to create custom user roles with similar access rights but for different mail policies based on the domain. This allows delegated administrators to manage mail policies for their domains without interfering with the responsibilities of other delegated administrators.

### Procedure

---

- Step 1** Go to the **System Administration > User Roles** page.
  - Step 2** Click the duplicate icon corresponding to the user role you want to duplicate in the Custom User Roles for Delegated Administration listing.
  - Step 3** Change the name of the custom user role.
  - Step 4** Make any access privilege changes required for the new custom user role.
  - Step 5** Submit and commit your changes.
- 

## Deleting a Custom User Role

When a custom role is deleted, users become unassigned and do not have access to the email gateway. If you delete a custom user role that is assigned to one or more users, you do not receive a warning message. You should reassign any users that were assigned to the custom user role that you deleted.

### Procedure

---

- Step 1** Go to the **System Administration > User Roles** page.
  - Step 2** Click the trash can icon corresponding to the user role you want to delete in the Custom User Roles for Delegated Administration list.
  - Step 3** Confirm the deletion by clicking **Delete** in the warning dialog that appears.
  - Step 4** Commit your changes.
- 

## Passphrases

- [Changing Your Passphrase, on page 986](#)
- [Locking and Unlocking a User Account, on page 987](#)
- [Configuring Restrictive User Account and Passphrase Settings, on page 987](#)
- [External Authentication, on page 988](#)
- [Two-Factor Authentication, on page 992](#)

## Changing Your Passphrase

Administrative users can change their own passphrases via the Options > Change Passphrase link at the top of the GUI.

As soon as you submit a new passphrase, you are logged out and taken to the log in screen.

In the CLI, use the passphrase or passwd command to change your passphrase. If you forget the passphrase for the admin user account, contact your customer support provider to reset the passphrase.



---

**Note** In addition to creating a login passphrase manually, you can also create a system-generated passphrase to log in to your email gateway.

---

The passphrase command requires you to enter the old passphrase for security.



---

**Note** Changes to the passphrase take effect immediately and do not require you commit the change.

---

## Locking and Unlocking a User Account

Locking a user account prevents a local user from logging into the email gateway. A user account can be locked in one of the following ways:

- AsyncOS locks a user account if the user exceeded the maximum number of failed login attempts defined in the Local User Account & Passphrase Settings section.
- Administrators can manually lock user accounts for security purposes using the System Administration > Users page.

AsyncOS displays the reason why the user account was locked when you view the user account on the Edit User page.

To unlock a user account, open the user account by clicking on the user name in the Users listing and click **Unlock Account**.

To manually lock a local user account, open the user account by clicking on the user name in the Users listing and click **Lock Account**. AsyncOS displays a message saying that the user will be unable to log into the email gateway and asks if you want to continue.

You can also configure all local user accounts to lock after users fail to login successfully after a configured number of attempts. For more information, see [Configuring Restrictive User Account and Passphrase Settings, on page 987](#).



---

**Note** If you lock the admin account, you can only unlock it by logging in as the admin through a serial communications connection to the serial console port. The admin user can always access the email gateway using the serial console port, even when the admin account is locked. See [Connecting to the Email Gateway, on page 21](#) for more information on accessing the email gateway using the serial console port.

---

## Configuring Restrictive User Account and Passphrase Settings

You can define user account and passphrase restrictions to enforce organizational passphrase policies. The user account and passphrase restrictions apply to local users defined on the email gateway. You can configure the following settings:

- **User account locking.** You can define how many failed login attempts cause the user to be locked out of the account.

- **Passphrase lifetime rules.** You can define how long a passphrase can exist before the user is required to change the passphrase after logging in.
- **Passphrase rules.** You can define what kinds of passphrases users can choose, such as which characters are optional or mandatory.

You define user account and passphrase restrictions on the System Administration > Users page in the Local User Account & Passphrase Settings section.

## External Authentication

If you store user information in an LDAP or RADIUS directory on your network, you can configure your email gateway to use the external directory to authenticate users who log in to the email gateway. To set up the email gateway to use an external directory for authentication, use the System Administration > Users page in the GUI or the `userconfig` command and the `external` subcommand in the CLI.

When external authentication is enabled and a user logs into the email gateway, the email gateway first determines if the user is the system defined “admin” account. If not, then the email gateway checks the first configured external server to determine if the user is defined there. If the email gateway cannot connect to the first external server, the email gateway checks the next external server in the list.

For LDAP servers, if the user fails authentication on any external server, the email gateway tries to authenticate the user as a local user defined on the email gateway. If the user does not exist on any external server or on the email gateway, or if the user enters the wrong passphrase, access to the email gateway is denied.

If an external RADIUS server cannot be contacted, the next server in the list is tried. If all servers cannot be contacted, the email gateway tries to authenticate the user as a local user defined on the email gateway. However, if an external RADIUS server rejects a user for any reason, such as an incorrect passphrase or the user being absent, access to the email gateway is denied.

### Related Topics

- [Enabling LDAP Authentication, on page 988](#)
- [Enabling RADIUS Authentication, on page 989](#)
- [Enable SAML Authentication, on page 991](#)

## Enabling LDAP Authentication

In addition to using an LDAP directory to authenticate users, you can assign LDAP groups to Cisco user roles. For example, you can assign users in the IT group to the Administrator user role, and you can assign users in the Support group to the Help Desk User role. If a user belongs to multiple LDAP groups with different user roles, AsyncOS grants the user the permissions for the most restrictive role. For example, if a user belongs to a group with Operator permissions and a group with Help Desk User permissions, AsyncOS grants the user the permissions for the Help Desk User role.



---

**Note** If an external user changes the user role for their LDAP group, the user should log out of the email gateway and then log back in. The user will have the permissions of their new role.

---

### Before You Begin

Define an LDAP server profile and an external authentication query for the LDAP server. For more information, see [LDAP Queries, on page 771](#)

## Procedure

---

- Step 1** Choose **System Administration > Users**.
  - Step 2** Scroll down to the **External Authentication** section.
  - Step 3** Click **Enable**.
  - Step 4** Select the **Enable External Authentication** check box.
  - Step 5** Select **LDAP** for the authentication type.
  - Step 6** Enter the amount of time to store external authentication credentials in the web user interface.
  - Step 7** Select the LDAP external authentication query that authenticates users.
  - Step 8** Enter the number of seconds that the email gateway waits for a response from the server before timing out.
  - Step 9** Enter the name of a group from the LDAP directory that you want the email gateway to authenticate, and select the role for the users in the group.
  - Step 10** Optionally, click **Add Row** to add another directory group. Repeat steps 9 and 10 for each directory group that the email gateway authenticates.
  - Step 11** Submit and commit your changes.
- 

## Enabling RADIUS Authentication

You can also use a RADIUS directory to authenticate users and assign groups of users to Cisco roles. The RADIUS server should support the CLASS attribute, which AsyncOS uses to assign users in the RADIUS directory to Cisco user roles. AsyncOS supports two authentication protocols for communicating with the RADIUS server: Password Authentication Protocol (PAP) and Challenge Handshake Authentication Protocol (CHAP).

To assign RADIUS users to Cisco user roles, first set the CLASS attribute on the RADIUS server with a string value of <radius-group>, which will be mapped to Cisco user roles. The CLASS attribute may contain letters, numbers, and a dash, but cannot start with a dash. AsyncOS does not support multiple values in the CLASS attribute. RADIUS users belonging to a group without a CLASS attribute or an unmapped CLASS attribute cannot log into the email gateway.

If the email gateway cannot communicate with the RADIUS server, the user can log in with a local user account on the email gateway.



- 
- Note** If an external user changes the user role for their RADIUS group, the user should log out of the appliance and then log back in. The user will have the permissions of their new role.
- 

## Procedure

---

- Step 1** On the **System Administration > Users** page, click **Enable**.
- Step 2** Check the Enable External Authentication option if it is not enabled already.
- Step 3** Enter the hostname for the RADIUS server.
- Step 4** Enter the port number for the RADIUS server. The default port number is 1812.
- Step 5** Enter the Shared Secret password for the RADIUS server.

- Step 6** Enter the number of seconds for the email gateway to wait for a response from the server before timing out.
- Step 7** (Optional) Click **Add Row** to add another RADIUS server. Repeat steps 3 – 6 for each RADIUS server.

**Note** You can add up to ten RADIUS servers.

- Step 8** Enter the number of seconds AsyncOS stores the external authentication credentials before contacting the RADIUS server again to re-authenticate in the “External Authentication Cache Timeout” field. Default is zero (0).

**Note** If the RADIUS server uses one-time passwords, for example passwords created from a token, enter zero (0). When the value is set to zero, AsyncOS does not contact the RADIUS server again to authenticate during the current session.

- Step 9** Configure Group Mapping:

| Setting   | Description   |
|---|---|
| Map externally authenticated users to multiple local roles.       | <p>AsyncOS assigns RADIUS users to email gateway roles based on the RADIUS CLASS attribute. CLASS attribute requirements:</p> <ul style="list-style-type: none"> <li>• 3 character minimum</li> <li>• 253 character maximum</li> <li>• no colons, commas, or newline characters</li> <li>• one or more mapped CLASS attributes for each RADIUS user (With this setting, AsyncOS denies access to RADIUS users without a mapped CLASS attribute.)</li> </ul> <p>For RADIUS users with multiple CLASS attributes, AsyncOS assigns the most restrictive role. For example, if a RADIUS user has two CLASS attributes, which are mapped to the Operator and Read-Only Operator roles, AsyncOS assigns the RADIUS user to the Read-Only Operator role, which is more restrictive than the Operator role.</p> <p>These are the email gateway roles ordered from least restrictive to most restrictive:</p> <ul style="list-style-type: none"> <li>• admin</li> <li>• Administrator</li> <li>• Technician</li> <li>• Operator cloudadmin</li> <li>• Read-only Operator</li> <li>• Help Desk User</li> <li>• Guest</li> </ul> |
| Map all externally authenticated users to the Administrator role. | AsyncOS assigns RADIUS users to the Administrator role.   |

- Step 10** Choose whether to map all externally authenticated users to the Administrator role or to different email gateway user role types.

- Step 11** If you map users to different role types, enter the group name as defined in the RADIUS CLASS attribute in the Group Name or Directory field, and choose an email gateway role type from the Role field. You can add more role mappings by clicking **Add Row**.

For more information on user role types, see [Working with User Accounts, on page 973](#).

**Step 12** Submit and commit your changes.

---

## Enable SAML Authentication

You can enable Single Sign On using SAML to authenticate users and assign groups of users to Cisco rules.

### Before you begin

Make sure that you have configured the SAML profiles with Service Provider and Identity Provider settings. See [How to Configure SSO on your Email Gateway, on page 1077](#).

### Procedure

---

- Step 1** Navigate to **System Administration > Users**.
- Step 2** Scroll down to the **External Authentication** section.
- Step 3** Click **Enable**.
- Step 4** Select the **Enable External Authentication** check box.
- Step 5** Select **SAML** as the authentication type from the drop-down list.
- Step 6** **(Optional)** In the **External Authentication Attribute Name Map** field, enter the attribute name to search from the Group Mapping.
- The Attribute Name depends on the attributes that you configure for the Identity Provider to relay the SAML response. The email gateway will search for matching entries of the Attribute Name from SAML response against the attributes that you configure in the **Group Mapping** field. This is optional and if you do not configure, the email gateway will search for matching entries of all attributes present in SAML response against configured Group Mapping field.
- Step 7** In the **Group Mapping** field, enter the group name attribute as defined in the SAML directory based on the predefined or custom user role. You can click **Add Row** to add multiple role mappings.
- The Group Mapping must contain a group attribute. You can add 'Unspecified Groups' attribute to authenticate SAML assertions or response.
- For more information on types of user roles, see [Working with User Accounts, on page 973](#).
- Note** The Group Mapping attributes are case-sensitive and must match exactly in order to return the proper results.
- Step 8** Submit and commit your changes.
- 

### What to do next

After you enable SAML external authentication, you can use the **Use Single Sign On** link on the login page of the email gateway and enter the username to log in to the email gateway.

## Two-Factor Authentication

You can use a RADIUS directory to configure two-factor authentication for specific user roles. The email gateway supports the following authentication protocols for communicating with the RADIUS server:

- Password Authentication Protocol (PAP)
- Challenge Handshake Authentication Protocol (CHAP)

You can enable two-factor authentication for the following user roles:

- predefined
- custom

The feature has been tested with:

- RSA Authentication Manager v8.2
- FreeRADIUS v1.1.7 and above
- ISE v1.4 and above

### Related Topics

- [Enabling Two-Factor Authentication, on page 992](#)
- [Disabling Two-Factor Authentication, on page 993](#)

## Enabling Two-Factor Authentication

### Before You Begin

Make sure that you get the required RADIUS server details for two-factor authentication from your IT administrator.

### Procedure

---

- Step 1** On the **System Administration > Users** page, click **Enable** under Two-Factor Authentication.
  - Step 2** Enter the hostname or IP address of the RADIUS server.
  - Step 3** Enter the port number of the RADIUS server.
  - Step 4** Enter the Shared Secret password of the RADIUS server.
  - Step 5** Enter the number of seconds to wait for a response from the server before timing out.
  - Step 6** Select the appropriate authentication protocol.
  - Step 7** (Optional) Click **Add Row** to add another RADIUS server. Repeat steps 2 to 6 for each RADIUS server.  
**Note** You can add up to ten RADIUS servers.
  - Step 8** Select the required user roles for which you want to enable two-factor authentication.
  - Step 9** Submit and commit your changes.
-



When two-factor authentication is enabled, the user is prompted to enter a passcode after entering the username and passphrase, to login to the email gateway.

## Disabling Two-Factor Authentication

### Before You Begin

Make sure you have enabled two-factor authentication on your email gateway.

### Procedure

- 
- |               |  |
|---------------|--|
| <b>Step 1</b> | On the <b>System Administration &gt; Users</b> page, click <b>Edit Global Settings</b> under Two-Factor Authentication |
| <b>Step 2</b> | Deselect <b>Enable Two-Factor Authentication</b> .   |
| <b>Step 3</b> | Submit and commit your changes.  |
- 

## Configuring Access to the Email Gateway

AsyncOS provides administrators controls to manage users' access to the email gateway, including a timeout for Web UI session and an access list that specifies the IP addresses from which users and your organization's proxy servers can access the email gateway.

### Related Topics

- [Configuring IP-Based Network Access, on page 993](#)
- [Configuring Session Timeouts, on page 996](#)

## Configuring IP-Based Network Access

You can control from which IP addresses users access the email gateway by creating access lists for users who connect directly to the appliance and users who connect through a reverse proxy, if your organization uses reverse proxies for remote users.

### Related Topics

- [Direct Connections, on page 993](#)
- [Connecting Through a Proxy, on page 994](#)
- [Important Precautions When Restricting Network Access , on page 994](#)
- [Creating the Access List , on page 994](#)

## Direct Connections

You can specify the IP addresses, subnets, or CIDR addresses for machines that can connect to the email gateway. Users can access the email gateway from any machine with IP address from the access list. Users attempting to connect to the email gateway from an address not included in the list are denied access.

## Connecting Through a Proxy

If your organization's network uses reverse proxy servers between remote users' machines and the email gateway, AsyncOS allows you create an access list with the IP addresses of the proxies that can connect to the email gateway.

Even when using a reverse proxy, AsyncOS still validates the IP address of the remote user's machine against a list of IP addresses allowed for user connections. To send the remote user's IP address to the email gateway, the proxy needs to include the `x-forwarded-for` HTTP header in its connection request to the email gateway.

The `x-forwarded-for` header is a non-RFC standard HTTP header with the following format:

```
x-forwarded-for: client-ip, proxy1, proxy2,... CRLF .
```

The value for this header is a comma-separated list of IP addresses with the left-most address being the address of the remote user's machine, followed by the addresses of each successive proxy that forwarded the connection request. (The header name is configurable.) The email gateway matches the remote user's IP address from the header and the connecting proxy's IP address against the allowed user and proxy IP addresses in the access list.



---

**Note** AsyncOS supports only IPv4 addresses in the `x-forwarded-for` header.

---

## Important Precautions When Restricting Network Access

**Caution!** You may lose access to the email gateway after submitting and committing network access changes if one of the following conditions is true:

- If you select **Only Allow Specific Connections** and do not include the IP address of your current machine (PC, email gateway in a clustered environment, or Cisco Secure Manager Email and Web Gateway, etc.) in the list.
- If you select **Only Allow Specific Connections Through Proxy** and the IP address of the proxy currently connected to the email gateway is not in the proxy list and the value of the Origin IP header is not in the list of allowed IP addresses.
- If you select **Only Allow Specific Connections Directly or Through Proxy** and
  - the value of the Origin IP header is not in the list of allowed IP addresses
  - OR
  - the value of the Origin IP header is not in the list of allowed IP Addresses and the IP address of the proxy connected to the email gateway is not in the list of allowed proxies.

## Creating the Access List

You can create the network access list either via the GUI or the `adminaccessconfig > ipaccess` CLI command.

### Before You Begin

Ensure that you will not lock yourself out of the email gateway after changing network access settings. See [Important Precautions When Restricting Network Access](#) , on page 994.

## Procedure

**Step 1** Select **System Administration > Network Access**.

**Step 2** Click **Edit Settings**.

**Step 3** Select the mode of control for the access list:

| Option   | Description   |
|--|---|
| <b>Allow All</b>   | This mode allows all connections to the email gateway.<br>This is the default mode of operation.  |
| <b>Only Allow Specific Connections</b>                           | This mode allows a user to connection to the email gateway if the user's IP address matches the IP addresses, IP ranges, or CIDR ranges included in the access list.  |
| <b>Only Allow Specific Connections Through Proxy</b>             | This mode allows a user to connect to the email gateway through a reverse proxy if the following conditions are met: <ul style="list-style-type: none"> <li>• The connecting proxy's IP address is included in the access list's IP Address of Proxy Server field.</li> <li>• The proxy includes the <b>x-forwarded-header</b> HTTP header in its connection request.</li> <li>• The value of <b>x-forwarded-header</b> is not empty.</li> <li>• The remote user's IP address is included in x-forwarded-header and it matches the IP addresses, IP ranges, or CIDR ranges defined for users in the access list.</li> </ul> |
| <b>Only Allow Specific Connections Directly or Through Proxy</b> | This mode allows users to connect through a reverse proxy or directly to the email gateway if their IP address matches the IP addresses, IP ranges, or CIDR ranges included in the access list. The conditions for connecting through a proxy are the same as in the Only Allow Specific Connections Through Proxy mode.  |

**Step 4** Enter the IP addresses from which users will be allowed to connect to the email gateway.

You can enter an IP address, IP address range or CIDR range. Use commas to separate multiple entries.

**Step 5** If connecting through a proxy is allowed, enter the following information:

- a. The IP addresses of the proxies allowed to connect to the email gateway. Use commas to separate multiple entries.
- b. The name of the origin IP header that the proxy sends to the email gateway, which contains the IP addresses of the remote user's machine and the proxy servers that forwarded the request. By default, the name of the header is x-forwarded-for .

**Step 6** Ensure that you have not configured a change that will lock you out of the email gateway after you submit and commit your changes.

**Step 7** Submit and commit your changes.

## Configuring Session Timeouts

- [Configuring the Web UI Session Timeout, on page 996](#)
- [Configuring the CLI Session Timeout, on page 996](#)

### Configuring the Web UI Session Timeout

You can specify how long a user can be logged into the email gateway's Web UI before AsyncOS logs the user out due to inactivity. This Web UI session timeout applies to:

- All users, including administrator
- HTTP and HTTPS sessions
- Cisco Spam Quarantine

Once AsyncOS logs a user out, the email gateway redirects the user's web browser to login page.

#### Procedure

---

- Step 1** Select **System Administration > Network Access**.
- Step 2** Click **Edit Settings**.
- Step 3** In the **Web UI Inactivity Timeout** field, enter the number of minutes users can be inactive before being logged out. You can define a timeout period between 5 and 1440 minutes.
- Step 4** Submit and commit your changes.
- 

#### What to do next

You can also use the `adminaccessconfig` command in CLI to configure Web UI session timeout. See *CLI Reference Guide for AsyncOS for Cisco Secure Email Gateway*.

### Configuring the CLI Session Timeout

You can specify how long a user can be logged into the email gateway's CLI before AsyncOS logs the user out due to inactivity. The CLI session timeout applies:

- To all users, including administrator
- Only to the connections using Secure Shell (SSH), SCP, and direct serial connection



---

**Note** Any uncommitted configuration changes at the time of CLI session timeout will be lost. Make sure that you commit the configuration changes as soon as they are made.

---

#### Procedure

---

- Step 1** Select **System Administration > Network Access**.
- Step 2** Click **Edit Settings**.

- Step 3** In the **CLI Inactivity Timeout** field, enter the number of minutes users can be inactive before being logged out. You can define a timeout period between 5 and 1440 minutes.
- Step 4** Submit and commit your changes.

---

**What to do next**

You can also use the `adminaccessconfig` command in CLI to configure CLI session timeout. See *CLI Reference Guide for AsyncOS for Cisco Secure Email Gateway*.

## Displaying Messages to Administrative Users

- [Displaying a Message Before Login](#), on page 997
- [Displaying a Message After Login](#), on page 997

### Displaying a Message Before Login

You can configure the email gateway to display a message before a user attempts to log into the email gateway through SSH, FTP, or Web UI. The login banner is customizable text that appears above the login prompt. You can use the login banner to display internal security information or best practice instructions for the email gateway. For example, you can create a simple note that saying that unauthorized use of the email gateway is prohibited or a detailed warning concerning the organization's right to review changes made by the user to the email gateway.

Use the `adminaccessconfig > banner` command in the CLI to create the login banner. The maximum length of the login banner is 2000 characters to fit 80x25 consoles. A login banner can be imported from a file in the `/data/pub/configuration` directory on the email gateway. After creating the banner, commit your changes.

### Displaying a Message After Login

You can configure AsyncOS to display a welcome banner after a user successfully logs into the email gateway through SSH, FTP, or Web UI. You can use the welcome banner to display internal security information or best practice instructions for the email gateway.

Use the `adminaccessconfig > welcome` command in CLI to create the welcome banner. The maximum length of the welcome banner is 1600 characters.

You can import a welcome banner from a file in the `/data/pub/configuration` directory on your email gateway. After creating the banner, commit your changes.

For more information, see *CLI Reference Guide for AsyncOS for Cisco Secure Email Gateway*.

## Managing Secure Shell (SSH) Keys

Use the `sshconfig` command to:

- Add or delete secure shell (SSH) public User keys to the `authorized_keys` file of user accounts that have been configured on the system, including the admin account. This allows authentication to user accounts using SSH keys rather than passphrase challenge.
- Edit the following SSH server configuration settings:

- Public Key Authentication Algorithms
- Cipher Algorithms
- KEX Algorithms
- MAC Methods
- Minimum Server Key Size.



**Note** To configure Host keys, which are used when performing SCP pushes of log files from the email gateway to other host machines, use `logconfig -> hostkeyconfig`. For more information, see [Logging, on page 1145](#).

Using `hostkeyconfig`, you can scan for keys of remote hosts and add them to the email gateway.

#### Related Topics

- [Example: Install a New Public Key, on page 998](#)
- [Example: Edit SSH Server Configuration, on page 998](#)

## Example: Install a New Public Key

In the following example, a new public key is installed for the administrator account:

```
mail.example.com> sshconfig
Choose the operation you want to perform:
- SSHD - Edit SSH server settings.
- USERKEY - Edit SSH User Key settings
[ ]> userkey
Currently installed keys for admin:
Choose the operation you want to perform:
- NEW - Add a new key.
- USER - Switch to a different user to edit.
[ ]> new
Please enter the public SSH key for authorization.
Press enter on a blank line to finish.
[-paste public key for user authentication here-]
Choose the operation you want to perform:
- SSHD - Edit SSH server settings.
- USERKEY - Edit SSH User Key settings
[ ]>
```

## Example: Edit SSH Server Configuration

The following example shows how to edit the SSH server configuration.

```
mail.example.com> sshconfig
Choose the operation you want to perform:
- SSHD - Edit SSH server settings.
- USERKEY - Edit SSH User Key settings
[ ]> sshd
ssh server config settings:
Public Key Authentication Algorithms:
    rsal
    ssh-dss
```

```

    ssh-rsa
Cipher Algorithms:
  aes128-ctr
  aes192-ctr
  aes256-ctr
  arcfour256
  arcfour128
  aes128-cbc
  3des-cbc
  blowfish-cbc
  cast128-cbc
  aes192-cbc
  aes256-cbc
  arcfour
  rijndael-cbc@lysator.liu.se
MAC Methods:
  hmac-md5
  hmac-shal
  umac-64@openssh.com
  hmac-ripemd160
  hmac-ripemd160@openssh.com
  hmac-shal-96
  hmac-md5-96
Minimum Server Key Size:
  1024
KEX Algorithms:
  diffie-hellman-group-exchange-sha256
  diffie-hellman-group-exchange-shal
  diffie-hellman-group14-shal
  diffie-hellman-group1-shal
Choose the operation you want to perform:
- SETUP - Setup SSH server configuration settings
[]> setup
Enter the Public Key Authentication Algorithms do you want to use
[rsal,ssh-dss,ssh-rsa]> rsal
Enter the Cipher Algorithms do you want to use
[aes128-ctr,aes192-ctr,aes256-ctr,arcfour256,arcfour128,aes128-cbc,3des-cbc,blowfish-cbc,
cast128-cbc,aes192-cbc,aes256-cbc,arcfour,rijndael-cbc@lysator.liu.se]> aes192-ctr
Enter the MAC Methods do you want to use
[hmac-md5,hmac-shal,umac-64@openssh.com,hmac-ripemd160,hmac-ripemd160@openssh.com,hmac-shal-96,
hmac-md5-96]> hmac-shal
Enter the Minimum Server Key Size do you want to use
[1024]> 2048
Enter the KEX Algorithms do you want to use
[diffie-hellman-group-exchange-sha256,diffie-hellman-group-exchange-shal,diffie-hellman-group14-shal,
diffie-hellman-group1-shal]> diffie-hellman-group-exchange-shal
ssh server config settings:
Public Key Authentication Algorithms:
  rsal
Cipher Algorithms:
  aes192-ctr
MAC Methods:
  hmac-shal
Minimum Server Key Size:
  2048
KEX Algorithms:
  diffie-hellman-group-exchange-shal
Choose the operation you want to perform:
- SETUP - Setup SSH server configuration settings
[]>

```

## Remote SSH Command Execution

The CLI allows commands to be run via remote SSH command execution. For example, the following command can be run from a remote host unchallenged if an SSH public key has been configured for the admin account on the email gateway:

```
# ssh admin@mail3.example.com status

Enter "status detail" for more information.

Status as of: Mon Jan 20 17:24:15 2003

Last counter reset: Mon Jan 20 17:08:21 2003

System status: online

[rest of command deleted]
```

## Monitoring Administrative User Access

| To  | Do This  |
|---|--|
| View session details of all active users of the email gateway   | Click <b>Options &gt; Active Sessions</b> at the top right of the page<br><br>In the command-line interface, use the <code>w</code> , <code>whoami</code> and <code>who</code> commands. |
| View users who have recently logged into the email gateway.<br><br>The IP address of the remote host, and the login, logout, and total time are also displayed. | In the command-line interface, use the <code>last</code> command.  |





## CHAPTER 39

# System Administration

---

This chapter contains the following sections:



---

**Note** Several of the features or commands described in this section will affect, or be affected by routing precedence. Please see *Appendix B "IP Addresses Interfaces and Routing"* for more information.

---

- [Management of the Email Gateway, on page 1002](#)
- [Email Gateway Licensing, on page 1004](#)
- [Virtual Email Gateway License, on page 1020](#)
- [Managing the Configuration File, on page 1021](#)
- [Configuration File Page, on page 1026](#)
- [Managing Disk Space , on page 1026](#)
- [Managing Security Services, on page 1028](#)
- [Service Updates , on page 1029](#)
- [Setting Up to Obtain Upgrades and Updates , on page 1030](#)
- [Upgrading AsyncOS, on page 1038](#)
- [Enabling Remote Power Cycling , on page 1042](#)
- [Reverting to a Previous Version of AsyncOS, on page 1043](#)
- [Configuring the Return Address for Email Gateway Generated Messages, on page 1044](#)
- [Setting Thresholds for System Health Parameters, on page 1045](#)
- [Checking the Health of Email Gateway, on page 1046](#)
- [Alerts, on page 1047](#)
- [Changing Network Settings, on page 1069](#)
- [Single Sign-On \(SSO\) Using SAML 2.0, on page 1075](#)
- [Configuring OpenID Connect 1.0 on Email Gateway for AsyncOS APIs, on page 1084](#)
- [System Time, on page 1087](#)
- [Customizing Your View , on page 1089](#)
- [General Settings, on page 1090](#)
- [Configuring Maximum HTTP Header Size, on page 1091](#)
- [Restarting and Viewing Status of Service Engines, on page 1091](#)
- [Receiving and Delivering Messages with Internationalised Domain Names \(IDNs\), on page 1092](#)

# Management of the Email Gateway

The following tasks allow you to easily manage the common functions within the email gateway.

- [Shutting Down or Rebooting the Email Gateway](#) , on page 1002
- [Suspending Email Receiving and Delivery](#) , on page 1002
- [Resuming Suspended Email Receiving and Delivery](#) , on page 1003

## Shutting Down or Rebooting the Email Gateway

After you shut down or reboot, you may restart the email gateway later without losing any messages in the delivery queue.

You can use the `s hutdown` or `s reboot` command in the CLI, or use the web interface:

### Procedure

---

- Step 1** Select **System Administration** > **Shutdown/Suspend**.
  - Step 2** In the **System Operations** section, choose **Shutdown** or **Reboot** from the **Operation** drop-down list.
  - Step 3** Enter a number of seconds to wait to allow open connections to complete before forcing them to close. The default delay is thirty (30) seconds.
  - Step 4** Click **Commit**.
- 

## Suspending Email Receiving and Delivery

AsyncOS allows you to suspend receiving and delivering of emails. You can suspend:

- Receiving of emails on a particular listener or multiple listeners.
- Delivery of all emails or emails to a particular domain or multiple domains.

Use the `suspend` command in the CLI, or use the web interface:

### Procedure

---

- Step 1** Select **System Administration** > **Shutdown/Suspend**.
- Step 2** Suspend receiving of emails on a particular listener or multiple listeners.  
In the **Mail Operations** section, select the functions and/or listeners to suspend. If the email gateway has multiple listeners, you can suspend email receiving on individual listeners.
- Step 3** Suspend the delivery of all emails or emails to a particular domain or multiple domains. Depending on your requirements, do one of the following:
  - a. To suspend the delivery of all emails, in **Specify Domain(s)/Subdomain(s)** field, enter ALL, and press **Enter**.

- b. To suspend the delivery of emails to a specific domain or subdomain, in **Specify Domain(s)/Subdomain(s)** field, enter the domain or subdomain name or IP address, and press **Enter**. Use comma-separated text to add multiple entries.

**Step 4** Enter number of seconds to wait to allow open connections to complete before forcing them to close. If there are no open connections, the system goes offline immediately. The default delay is 30 seconds.

**Step 5** Click **Commit**.

---

#### What to do next

When you are ready to resume suspended services, see [Resuming Suspended Email Receiving and Delivery](#), on page 1003.

## Resuming Suspended Email Receiving and Delivery

Use the Shutdown/Suspend page or the `resume` command to resume the suspended receiving and delivery of emails.

#### Procedure

---

- Step 1** Select **System Administration > Shutdown/Suspend**.
  - Step 2** In the **Mail Operations** section, select the functions and/or listeners to resume. If the email gateway has multiple listeners, you can resume email receiving on individual listeners.
  - Step 3** Resume the delivery of all emails or emails to a particular domain or multiple domains. In **Specify Domain(s)/Subdomain(s)** field, click the close icon on the intended entry.
  - Step 4** Click **Commit**.
- 

## Resetting to Factory Defaults



**Caution** Do not reset to factory defaults if you are not able to reconnect to the web interface or CLI using the Serial interface or the default settings on the Management port through the default Admin user account.

---

When physically transferring the email gateway, you may want to start with factory defaults. Resetting to factory settings is extremely destructive, and it should only be used when you are transferring the unit or as a last resort to solving configuration issues. Resetting to factory defaults disconnects you from the web interface or CLI, disabling services that you used to connect to the email gateway (FTP, SSH, HTTP, HTTPS), and even removing additional user accounts you had created. You can reset to factory default:

- On web interface, click the Reset button in the **System Administration > Configuration File** page, or click the Reset Configuration button in the **System Administration > System Setup Wizard**.
- On CLI, use the `resetconfig` command.



---

**Note** The `resetconfig` command only works when the email gateway is in the offline state. The email gateway returns to the online state after resetting to factory settings.

---

## Next Steps

- Run the System Setup wizard. For more information, refer to [Using the System Setup Wizard](#) , on page 26
- Turn on mail delivery to resume mail delivery.

## Displaying the Version Information for AsyncOS

To determine which version of AsyncOS is currently installed on your email gateway, use the System Overview page from the Monitor menu in the web interface (see [System Status, on page 859](#)), or use the version command in the CLI.

## Email Gateway Licensing

- [Feature Keys, on page 1004](#)
- [Smart Software Licensing, on page 1006](#)

## Feature Keys

- [Adding and Managing Feature Keys](#) , on page 1004
- [Automating Feature Key Download and Activation](#) , on page 1005
- [Expired Feature Keys, on page 1006](#)

## Adding and Managing Feature Keys

For physical email gateways, feature keys are specific to the serial number of the email gateway and specific to the feature being enabled (you cannot re-use a key from one system on another system).

To work with feature keys in the CLI, use the `featurekey` command.

### Procedure

---

- Step 1** Select **System Administration > Feature Keys**.
- Step 2** Perform actions:

| To   | Do This   |
|--|---|
| View the status of active feature keys   | Look at the <b>Feature Keys for &lt;serial number&gt;</b> section.  |
| View feature keys that have been issued for your email gateway but are not yet activated | Look at the <b>Pending Activation</b> section.<br>If you have enabled automatic download and activation, feature keys will never appear in this list.   |
| Check for recently-issued feature keys   | Click the <b>Check for New Keys</b> button in the Pending Activation section.<br><br>This is useful if you have not enabled automatic download and activation of feature keys, or if you need to download feature keys before the next automatic check. |
| Activate an issued feature key   | Select the key in the <b>Pending Activation</b> list and click <b>Activate Selected Keys</b> .  |
| Add a new feature key  | Use the <b>Feature Activation</b> section.  |

---

### What to do next

#### Related Topics

- [Automating Feature Key Download and Activation](#) , on page 1005
- [Configuration File Page](#), on page 1026

## Automating Feature Key Download and Activation

You can set the email gateway to automatically check for, download, and activate feature keys that are issued for this email gateway.

### Procedure

- 
- Step 1** Select **System Administration > Feature Key Settings**.
  - Step 2** Click **Edit Feature Key Settings**.
  - Step 3** To see frequency of checks for new feature keys, click the (?) help button.
  - Step 4** Specify settings.
  - Step 5** Submit and commit your changes.
- 

### What to do next

#### Related Topics

- [Adding and Managing Feature Keys](#) , on page 1004

## Expired Feature Keys

If a feature key is expiring, the email gateway sends out alerts 90 days, 60 days, 30 days, 15 days, 5 days, one day prior to the key expiration, and at the time of key expiration. To receive these alerts, make sure that you have subscribed to the System Alerts. For more information, see [Alerts, on page 1047](#).

If the feature key for the feature you are trying to access (using the web interface) has expired, please contact your Cisco representative or support organization.

## Smart Software Licensing

- [Overview, on page 1006](#)
- [Enabling Smart Software Licensing, on page 1009](#)
- [Registering the Email Gateway with Cisco Smart Software Manager, on page 1010](#)
- [Requesting for Licenses, on page 1011](#)
- [Deregistering the Email Gateway from Smart Cisco Software Manager , on page 1011](#)
- [Reregistering the Email Gateway with Smart Cisco Software Manager , on page 1012](#)
- [Changing Transport Settings, on page 1012](#)
- [Renewing Authorization and Certificate, on page 1012](#)
- [Reserving Feature Licenses, on page 1013](#)
- [Updating Smart Agent, on page 1019](#)
- [Alerts, on page 1018](#)
- [Smart Licensing in Cluster Mode, on page 1019](#)

## Overview

Smart Software Licensing enables you to manage and monitor email gateway licenses seamlessly. To activate Smart Software licensing, you must register your email gateway with Cisco Smart Software Manager (CSSM) which is the centralized database that maintains the licensing details about all the Cisco products that you purchase and use. With Smart Licensing, you can register with a single token rather than registering them individually on the website using Product Authorization Keys (PAKs).

Once you register the email gateway, you can track your email gateway licenses and monitor license usage through the CSSM portal. The Smart Agent installed on the email gateway connects the appliance with CSSM and passes the license usage information to the CSSM to track the consumption.

See [https://www.cisco.com/c/en/us/td/docs/wireless/technology/mesh/8-2/b\\_Smart\\_Licensing\\_Deployment\\_Guide.html](https://www.cisco.com/c/en/us/td/docs/wireless/technology/mesh/8-2/b_Smart_Licensing_Deployment_Guide.html) to know about Cisco Smart Software Manager.

### License Reservation

You can reserve licenses for features enabled in your email gateway without connecting to the Cisco Smart Software Manager (CSSM) portal. This is mainly beneficial for covered users that deploy the email gateway in a highly secured network environment with no communication to the Internet or external devices.

The feature licenses can be reserved in any one of the following modes:

- **Specific License Reservation (SLR)** – use this mode to reserve licenses for individual features (for example, ‘Mail Handling’) for a given time-period.
- **Permanent License Reservation (PLR)** – use this mode to reserve licenses for all features permanently.

For more information on how to reserve the licenses in your email gateway, see [Reserving Feature Licenses, on page 1013](#).

### Device Led Conversion

After you register your email gateway with smart licensing, all existing, valid classical licenses are automatically converted to smart licenses using the Device Led Conversion (DLC) process. These converted licenses are updated in the virtual account of the CSSM portal.



---

**Note** The DLC process is initiated if the email gateway contains valid feature licenses.

---



---

**Note** After the DLC process is complete, you will not be able to convert the smart licenses to classic licenses. Contact Cisco TAC for assistance.

---



---

**Note** The DLC process takes approximately an hour to complete.

---

You can view the status of the DLC process – ‘success’ or ‘failed’ in any one of the following ways:

- Device Led Conversion status field under the 'Smart Software Licensing Status' section in the **System Administration > Smart Software Licensing** page of the web interface.
- Conversion Status entry in the `license_smart > status` sub command in the CLI.



---

**Note** When the DLC process fails, the system sends a system alert that details the reason for the failure. You need to fix the issue and then use the `license_smart > conversion_start` sub command in the CLI to manually convert the classical licenses to smart licenses.

---



---

**Note** The DLC process is applicable only for classic licenses and not for the SLR or PLR modes of license reservation.

---

### Before you begin

- Make sure that your email gateway has internet connectivity.
- Contact Cisco sales team to create a smart account in Cisco Smart Software Manager portal (<https://software.cisco.com/#module/SmartLicensing>) or install a Cisco Smart Software Manager Satellite on your network.

See [https://www.cisco.com/c/en/us/td/docs/wireless/technology/mesh/8-2/b\\_Smart\\_Licensing\\_Deployment\\_Guide.html](https://www.cisco.com/c/en/us/td/docs/wireless/technology/mesh/8-2/b_Smart_Licensing_Deployment_Guide.html) to know more about Cisco Smart Software Manager covered user account creation or installing a Cisco Smart Software Manager Satellite.



---

**Note** A covered user is the total number of internet-connected employees, subcontractors, and other authorized individuals covered by your email gateway deployment (on-premises or cloud, whichever is applicable.)

---

For covered users who do not want to directly send the license usage information to the internet, the Smart Software Manager Satellite can be installed on the premises, and it provides a subset of CSSM functionality. Once you download and deploy the satellite application, you can manage licenses locally and securely without sending data to CSSM using the internet. The CSSM Satellite periodically transmits the information to the cloud.



---

**Note** If you want to use Smart Software Manager Satellite, use Smart Software Manager Satellite Enhanced Edition 6.1.0.

---

- The existing covered users of classical licenses (traditional) should migrate their classical licenses to smart licenses.

See <https://video.cisco.com/detail/video/5841741892001/convert-classic-licenses-to-smart-licenses?autoStart=true&q=classic>.

- The system clock of the email gateway must be in sync with that of the CSSM. Any deviation in the system clock of the email gateway with that of the CSSM, will result in failure of smart licensing operations.



---

**Note** If you have internet connectivity and want to connect to the CSSM through a proxy, you must use the same proxy that is configured for the email gateway using **Security Services -> Service updates**

---



---

**Note** For virtual covered users, every time you receive a new PAK file (new or renewal), generate the license file and load the file on the email gateway. After loading the file, you must convert the PAK to Smart Licensing. In Smart Licensing mode, the feature keys section in the license file will be ignored while loading the file and only the certificate information will be used.

---



---

**Note** If you already have a Cisco SecureX account, make sure you first register your email gateway with Cisco SecureX before you enable the Smart Licensing mode on your email gateway.

---

You must perform the following procedures to activate Smart Software Licensing for your email gateway:



|                   | Do This  | More Informaton   |
|-------------------|--|---|
| Step 1            | Enable Smart Software Licensing                                  | <a href="#">Enabling Smart Software Licensing, on page 1009</a>                               |
| Step 2            | Register the email gateway with Cisco Smart Software Manager     | <a href="#">Registering the Email Gateway with Cisco Smart Software Manager, on page 1010</a> |
| [Optional] Step 3 | Reserve the feature licenses in your email gateway, if required. | <a href="#">Reserving Feature Licenses, on page 1013</a>                                      |
| Step 4            | Request for licenses (feature keys)                              | <a href="#">Requesting for Licenses, on page 1011</a>   |

## Enabling Smart Software Licensing

### Procedure

- 
- Step 1** Choose **System Administration > Smart Software Licensing**.
- Step 2** Click **Enable Smart Software Licensing**.  
To know about Smart Software Licensing, click on the Learn More about Smart Software Licensing link.
- Step 3** Click **OK** after reading the information about Smart Software Licensing.
- Step 4** Commit your changes.
- 

### What to do next

After you enable Smart Software Licensing, all the features in the Classic Licensing mode will be automatically available in the Smart Licensing mode. If you are an existing covered user in Classic Licensing mode, you have 90-days evaluation period to use the Smart Software Licensing feature without registering your email gateway with the CSSM.

You will get notifications on regular intervals (90th, 60th, 30th, 15th, 5th, and last day) prior to the expiry and also upon expiry of the evaluation period. You can register your email gateway with the CSSM during or after the evaluation period.



**Note** New virtual email gateway covered users with no active licenses in Classic Licensing mode will not have the evaluation period even if they enable the Smart Software Licensing feature. Only the existing virtual email gateway covered users with active licenses in Classic Licensing mode will have evaluation period. If new virtual email gateway covered users want to evaluate the smart licensing feature, contact Cisco Sales team to add the evaluation license to the smart account. The evaluation licenses are used for evaluation purpose after registration.

---



---

**Note** After you enable the Smart Licensing feature on your email gateway, you will not be able to roll back from Smart Licensing to Classic Licensing mode.

---

## Registering the Email Gateway with Cisco Smart Software Manager

You must enable the Smart Software Licensing feature under System Administration menu in order to register your email gateway with the Cisco Smart Software Manager.

### Procedure

---

- Step 1** Go to **System Administration > Smart Software Licensing** page in your email gateway.
- Step 2** Select the **Smart License Registration** option.
- Step 3** Click **Confirm**.
- Step 4** Click **Edit**, if you want to change the **Transport Settings**. The available options are:
- **Direct**: Connects the email gateway directly to the Cisco Smart Software Manager through HTTPs. This option is selected by default.
  - **Transport Gateway**: Connects the email gateway to the Cisco Smart Software Manager through a Transport Gateway or Smart Software Manager Satellite. When you choose this option, you must enter the URL of the Transport Gateway or the Smart Software Manager Satellite and click OK. This option supports HTTP and HTTPS. In FIPS mode, Transport Gateway supports only HTTPS. See [https://www.cisco.com/c/en/us/td/docs/wireless/technology/mesh/8-2/b\\_Smart\\_Licensing\\_Deployment\\_Guide.html](https://www.cisco.com/c/en/us/td/docs/wireless/technology/mesh/8-2/b_Smart_Licensing_Deployment_Guide.html) to know about Transport Gateway.
- Access the Cisco Smart Software Manager portal
- (<https://software.cisco.com/#module/SmartLicensing> using your login credentials. Navigate to the Virtual Account page of the portal and access the General tab to generate a new token. Copy the Product Instance Registration Token for your email gateway.
- See [https://www.cisco.com/c/en/us/td/docs/wireless/technology/mesh/8-2/b\\_Smart\\_Licensing\\_Deployment\\_Guide.html](https://www.cisco.com/c/en/us/td/docs/wireless/technology/mesh/8-2/b_Smart_Licensing_Deployment_Guide.html) to know about Product Instance Registration Token creation.
- Step 5** Switch back to your email gateway and paste the Product Instance Registration Token.
- Step 6** Click **Register**.
- Step 7** On the Smart Software Licensing page, you can check the Reregister this product instance if it is already registered check box to reregister your email gateway. See [Reregistering the Email Gateway with Smart Cisco Software Manager](#) , on page 1012.
- 

### What to do next

The product registration process takes a few minutes and you can view the registration status on the Smart Software Licensing page.



---

**Note** After you have enabled smart software licensing and registered your email gateway with the Cisco Smart Software Manager, the Cisco Cloud Services portal is automatically enabled and registered on your email gateway.

---

## Requesting for Licenses

Once you complete the registration process successfully, you must request for licenses for the email gateway's features as required.

### Procedure

---

- Step 1** Choose **System Administration > Licenses**.
- Step 2** Click **Edit Settings**.
- Step 3** Check the checkboxes under the License Request/Release column corresponding to the licenses you want to request for.
- Step 4** Click **Submit**.

**Note** By default the licenses for Mail Handling and Cisco Secure Email Gateway Bounce Verification are available. You cannot activate, deactivate, or release these licenses.

There is no evaluation period or out of compliance for Mail Handling and Cisco Secure Email Gateway Bounce Verification licenses. This is not applicable for virtual email gateways.

---

### What to do next

When the licenses are overused or expired, they will go into out of compliance (OOC) mode and 30-days grace period is provided to each license. You will get notifications on regular intervals (30th, 15th, 5th, and last day) prior to the expiry and also upon the expiry of the OOC grace period.

After the expiry of the OOC grace period, you cannot use the licenses and the features will be unavailable. To access the features again, you must update the licenses on the CSSM portal and renew the authorization.

## Deregistering the Email Gateway from Smart Cisco Software Manager

### Procedure

---

- Step 1** Choose **System Administration > Smart Software Licensing**.
  - Step 2** From the **Action** drop-down list, choose **Deregister** and click **Go**.
  - Step 3** Click **Submit**.
-

## Reregistering the Email Gateway with Smart Cisco Software Manager

### Procedure

---

- Step 1** Choose **System Administration > Smart Software Licensing**.
- Step 2** From the **Action** drop-down list, choose **Reregister** and click **Go**.
- 

### What to do next

See [Registering the Email Gateway with Cisco Smart Software Manager, on page 1010](#) to know about registration process.

You can reregister the email gateway after you reset the email gateway configurations during unavoidable scenarios.

## Changing Transport Settings

You can change the transport settings only before registering the email gateway with CSSM.



**Note** You can change the transport settings only when the smart licensing feature is enabled. If you have already registered your email gateway, you must deregister the email gateway to change the transport settings. After changing the transport settings, you must register the email gateway again.

---

See [Registering the Email Gateway with Cisco Smart Software Manager](#) to know how to change the transport settings.

## Renewing Authorization and Certificate

After you register your email gateway with the Smart Cisco Software Manager, you can renew the certificate.



**Note** You can renew authorization only after the successful registration of the email gateway.

---

### Procedure

---

- Step 1** Choose **System Administration > Smart Software Licensing**.
- Step 2** From the **Action** drop-down list, choose the appropriate option:
- Renew Authorization Now
  - Renew Certificates Now
- Step 3** Click **Go**.
-

## Reserving Feature Licenses

- [Enabling License Reservation, on page 1013](#)
- [Registering License Reservation, on page 1013](#)
- [Updating License Reservation, on page 1015](#)
- [Removing License Reservation, on page 1016](#)
- [Disabling License Reservation, on page 1017](#)
- [Enabling License Reservation in Cluster Mode, on page 1017](#)
- [Disabling License Reservation in Cluster Mode, on page 1018](#)

### Enabling License Reservation

#### Before you begin

Make sure you have already enabled the Smart Licensing mode in your email gateway.



---

**Note** You can also enable the feature licenses using the `license_smart > enable_reservation` sub command in the CLI. For more information, see the ‘Smart Software Licensing’ section in ‘The Commands: Reference Examples’ chapter of the CLI Reference Guide.

---

#### Procedure

- 
- Step 1** Go to **System Administration > Smart Software Licensing** page in your email gateway.
  - Step 2** Select the **Specific/Permanent License Reservation** option.
  - Step 3** Click **Confirm**.
- 

The license reservation (SLR or PLR) is enabled in your email gateway.

#### What to do next

- You need to register the license reservation. For more information, see [Registering License Reservation, on page 1013](#).
- You can disable the license reservation in your email gateway, if required. For more information, see [Disabling License Reservation, on page 1017](#).

### Registering License Reservation

#### Before you begin

Make sure you have already enabled the required license reservation (SLR or PLR) in your email gateway.



---

**Note** You can also register the feature licenses using the `license_smart > request_code` and `license_smart > install_authorization_code` sub commands in the CLI. For more information, see the ‘Smart Software Licensing’ section in ‘The Commands: Reference Examples’ chapter of the CLI Reference Guide.

---

### Procedure

---

- Step 1** Go to **System Administration > Smart Software Licensing** page in your email gateway.
- Step 2** Click **Register**.
- Step 3** Click **Copy Code** to copy the request code.
- Note** You need to use the request code in the CSSM portal to generate an authorization code.
- Note** A system alert is sent every 24 hours to indicate that you need to install an authorization code.
- Step 4** Click **Next**.
- Note** The request code is canceled when you click the Cancel button. You cannot install the authorization code (generated in the CSSM portal) in the email gateway. Contact Cisco TAC to assist you in removing the reserved license after the request code is canceled in the email gateway.
- Step 5** Go to the CSSM portal to generate an authorization code to reserve licenses for specific or all features.
- Note** For more information on how to generate an authorization code, go to the *Inventory: License Tab > Reserve Licenses* section of the Help documentation at [Smart Software Licensing Online Help \(cisco.com\)](https://www.cisco.com).
- Step 6** Paste the authorization code obtained from the CSSM portal in your email gateway in any one of the following ways:
- Select the **Copy and Paste authorization code** option and paste the authorization code in the text box under the ‘Copy and Paste authorization code’ option.
  - Select the **Upload authorization code from the system** option and click **Choose File** to upload the authorization code.
- Step 7** Click **Install Authorization Code**.
- Note** After you install the authorization code, you receive a system alert that indicates Smart Agent successfully installed the license reservation.

---

The required license reservation (SLR or PLR) is registered in your email gateway. In SLR, only the reserved license is moved to the ‘Reserved in Compliance’ state. For PLR, all the licenses in the email gateway are moved to the ‘Reserved in Compliance’ state.



---

**Note** The ‘Reserved In Compliance:’ state indicates that the email gateway is authorized to use the license.

---

**What to do next**

- [Applicable for SLR only]: You can update the license reservation, if required. For more information, see [Updating License Reservation, on page 1015](#).
- [Applicable for SLR and PLR]: You can remove the license reservation, if required. For more information, see [Removing License Reservation, on page 1016](#).
- You can disable the license reservation in your email gateway. For more information, see [Disabling License Reservation, on page 1017](#).

**Updating License Reservation**

You can reserve license for a new feature or modify the existing license reservation for a feature.



---

**Note** You can only update the Specific License reservations and not the Permanent License reservations.

---



---

**Note** You can also update the license reservation using the `license_smart > reauthorize` sub command in the CLI. For more information, see the ‘Smart Software Licensing’ section in ‘The Commands: Reference Examples’ chapter of the CLI Reference Guide.

---

**Procedure**

- 
- Step 1** Go to the CSSM portal to generate an authorization code to update the already reserved licenses.
- Note** For more information on how to generate an authorization code, go to the *Inventory: Product Instances Tab > Update Reserved Licenses* section of the Help documentation at [Smart Software Licensing Online Help \(cisco.com\)](#).
- Step 2** Copy the authorization code obtained from the CSSM portal.
- Step 3** Go to **System Administration > Smart Software Licensing** page in your email gateway.
- Step 4** Select **Reauthorize** from the 'Action' drop-down list and click **GO**.
- Step 5** Paste the authorization code obtained from the CSSM portal in your email gateway in any one of the following ways:
- Select the **Copy and Paste authorization code** option and paste the authorization code in the text box under the ‘Copy and Paste authorization code’ option.
  - Select the **Upload authorization code from the system** option and click **Choose File** to upload the authorization code.
- Step 6** Click **Re-authorize**.
- Step 7** Click **Copy Code** to copy the confirmation code.
- Note** You need to use the confirmation code in the CSSM portal to update the license reservations.
- Step 8** Click **OK**.

**Step 9** Add the confirmation code obtained from the email gateway in the CSSM portal.

**Note** For more information on how to add the confirmation code, go to the *Inventory: Product Instances Tab > Update Reserved Licenses* section of the Help documentation at [Smart Software Licensing Online Help \(cisco.com\)](#).

---

The license reservations are updated. The reserved license is moved to the 'Reserved in Compliance' state. The licenses that are not reserved are moved to the "Not Authorized" state.



---

**Note** The 'Not Authorized' state indicates that the email gateway has not reserved any feature licenses.

---

#### What to do next

- [Applicable for SLR and PLR]: You can remove the license reservation, if required. For more information, see [Removing License Reservation, on page 1016](#).
- You can disable the license reservation in your email gateway. For more information, see [Disabling License Reservation, on page 1017](#).

## Removing License Reservation

You can remove the specific or permanent license reservation for the features enabled in your email gateway.



---

**Note** You can also remove the license reservation using the `license_smart > return_reservation` sub command in the CLI. For more information, see the 'Smart Software Licensing' section in 'The Commands: Reference Examples' chapter of the CLI Reference Guide.

---

#### Procedure

---

**Step 1** Go to **System Administration > Smart Software Licensing** page in your email gateway.

**Step 2** Select **Return code** from the 'Action' drop-down list and click **GO**.

**Step 3** Click **Copy Code** to copy the return code.

**Note** You need to use the return code in the CSSM portal to remove the license reservations.

**Note** An alert is sent to the user to indicate that Smart Agent successfully generated the return code for the product.

**Step 4** Click **OK**.

**Step 5** Add the return code obtained from the email gateway in the CSSM portal.

**Note** For more information on how to add the return code, go to the *Inventory: Product Instances Tab > Removing a Product Instance* section of the Help documentation at [Smart Software Licensing Online Help \(cisco.com\)](#).

---



The licenses reserved in your email gateway are removed and moved to the evaluation period.



---

**Note** If you have already installed the authorization code and enabled license reservation, the device is automatically moved to the 'registered' state with a valid license.

---

## Disabling License Reservation

You can disable the license reservation in your email gateway.



---

**Note** You can also disable the license reservation using the `license_smart > disable_reservation sub` command in the CLI. For more information, see the 'Smart Software Licensing' section in 'The Commands: Reference Examples' chapter of the CLI Reference Guide.

---

### Procedure

---

**Step 1** Go to **System Administration > Smart Software Licensing** page in your email gateway.

**Step 2** Click **Change Type** under the 'Registration Mode' field.

**Step 3** Click **Submit** in the 'Change registration mode' dialog box.

- Note**
- After you generate a request code and you disable the license reservation, the generated request code is canceled automatically.
  - After you install the authorization code and disable the license reservation, the reserved license is maintained in the email gateway.
  - If an authorization code is installed and the Smart Agent is in the Authorized state, it moves back to the 'Unidentified' (enabled) state.

---

The license reservation is disabled on your email gateway.

## Enabling License Reservation in Cluster Mode

You can enable the license reservation for all machines in the cluster.



---

**Note** You can also enable the license reservation for all machines in the cluster using the `license_smart > enable_reservation sub` command in the CLI. For more information, see the 'Smart Software Licensing' section in 'The Commands: Reference Examples' chapter of the CLI Reference Guide.

---

### Procedure

---

**Step 1** Switch from the cluster mode to the machine mode in the logged-in email gateway.

- Step 2** Go to **System Administration > Smart Software Licensing** page in your logged-in email gateway.
- Step 3** Select the **Specific/Permanent License Reservation** option.
- Step 4** Select the **Enable license reservation for all machines in the cluster** check box.
- Step 5** Click **Confirm**.
- The license reservation is enabled for all machines in the cluster.
- Step 6** Refer to the procedure in [Registering License Reservation, on page 1013](#) to reserve the feature licenses for the logged-in email gateway.
- Step 7** [Optional] Repeat **step 6** for all other machines in the cluster.

---

### What to do next

- [Applicable for SLR only]: You can update the license reservation for all the machines in the cluster, if required. For more information, see [Updating License Reservation, on page 1015](#).

### Disabling License Reservation in Cluster Mode

You can disable the license reservation for all machines in the cluster.



---

**Note** You can also disable the license reservation for all machines in the cluster using the `license_smart > disable_reservation` sub command in the CLI. For more information, see the ‘Smart Software Licensing’ section in ‘The Commands: Reference Examples’ chapter of the CLI Reference Guide.

---

### Procedure

- 
- Step 1** Go to **System Administration > Smart Software Licensing** page in your logged-in email gateway.
- Step 2** Select the **Disable license reservation for all machines in the cluster** check box.
- Step 3** Click **Change Type** under the ‘Registration Mode’ field.
- Step 4** Click **Submit** in the ‘Change registration mode’ dialog box.
- 

The license reservation is disabled for all machines in the cluster.

### Alerts

You will receive notifications on the following scenarios:

- Smart Software Licensing successfully enabled
- Smart Software Licensing enabling failed
- Beginning of the evaluation period
- Expiry of evaluation period (on regular intervals during evaluation period and upon expiry)
- Successfully registered

- Registration failed
- Successfully authorized
- Authorization failed
- Successfully deregistered
- Deregistration failed
- Successfully renewed Id certificate
- Renewal of Id certificate failed
- Expiry of authorization
- Expiry of Id certificate
- Expiry of out of compliance grace period (on regular intervals during out of compliance grace period and upon expiry)
- First instance of the expiry of a feature
- [Applicable for SLR and PLR only]: Authorization code is installed after generation of request code.
- [Applicable for SLR and PLR only]: Authorization code is installed successfully.
- [Applicable for SLR and PLR only]: Return code is generated successfully.
- [Applicable for SLR only]: Reservation of specific feature license is expired.
- [Applicable for SLR only]: Frequency of alerts sent before expiry of specific feature license reserved.

## Updating Smart Agent

To update the Smart Agent version installed on your email gateway, perform the following steps:

### Procedure

---

**Step 1** Choose **System Administration > Smart Software Licensing**.

**Step 2** In the **Smart Agent Update Status** section, click **Update Now** and follow the process.

**Note** If you try to save any configuration changes using the CLI command `saveconfig` or through the web interface using **System Administration > Configuration Summary**, then Smart Licensing related configuration will not be saved.

---

## Smart Licensing in Cluster Mode

In a clustered configuration, you can enable smart software licensing and register all the machines simultaneously with the Cisco Smart Software Manager.

### Procedure:

1. Switch from the cluster mode to the machine mode in the logged-in email gateway.

2. Go to **System Administration** > **Smart Software Licensing** page.
3. Click **Enable**.
4. Check the **Enable Smart Software Licensing on all machines in the cluster** check box.
5. Click **OK**.
6. Check the **Register Smart Software Licensing across machines in cluster** check box.
7. Click **Register**.



---

**Note** You can use the `license_smart` command in the CLI to enable smart software licensing and register all the machines simultaneously with the Cisco Smart Software Manager.

---



---

**Note** In a clustered configuration, you can also enable smart software licensing and register all the machines individually with the Cisco Smart Software Manager. In smart licensing cluster mode, you can log into any of the email gateways and configure smart licensing feature. You can log into an email gateway and access other email gateways one by one in the cluster and configure the smart licensing feature without logging off from the first email gateway.

---

For more information, see [Centralized Management Using Clusters](#), on page 1225.

## Virtual Email Gateway License

To set up and license a virtual email gateway, see the *Cisco Content Security Virtual Appliance Installation Guide*. This document is available from the location specified in [Documentation](#).



---

**Note** You cannot open a Technical Support tunnel or run the System Setup Wizard before installing the virtual email gateway license.

---

## Virtual Email Gateway License Expiration

After the virtual email gateway license expires, the email gateway will continue to deliver mail without security services for 180 days. Security service updates do not occur during this period.

Alerts will be sent 180 days, 150 days, 120 days, 90 days, 60 days, 30 days, 15 days, 5 days, 1 day and 0 seconds before the license expires, and at the same intervals before the grace period ends. These alerts will be of type “System” at severity level “Critical.” To ensure that you receive these alerts, see [Adding Alert Recipients](#), on page 1048.

These alerts are also logged in the system log.

Individual feature keys may expire earlier than the virtual email gateway license. You will also receive alerts when these approach their expiration dates.

### Related Topics

- [Reverting AsyncOS on Virtual Email Gateways May Impact the License](#) , on page 1043

## Managing the Configuration File

All configuration settings within the email gateway can be managed via a single configuration file. The file is maintained in XML (Extensible Markup Language) format.

You can use this file in several ways:

- You can save the configuration file to a different system to back up and preserve crucial configuration data. If you make a mistake while configuring your email gateway, you can “roll back” to the most recently saved configuration file.
- You can download the existing configuration file to view the entire configuration for an email gateway quickly. (Many newer browsers include the ability to render XML files directly.) This may help you troubleshoot minor errors (like typographic errors) that may exist in the current configuration.
- You can download an existing configuration file, make changes to it, and upload it to the same email gateway. This, in effect, “bypasses” both the CLI and the web interface for making configuration changes.
- You can upload entire configuration file via FTP access, or you can paste portions of or an entire configuration file directly into the CLI.
- Because the file is in XML format, an associated DTD (document type definition) that describes all of the XML entities in the configuration file is also provided. You can download the DTD to validate an XML configuration file before uploading it. (XML Validation tools are readily available on the Internet.)

## Managing Multiple Email Gateways with XML Configuration Files

- You can download an existing configuration file from one email gateway, make changes to it, and upload it to a different email gateway. This lets you manage an installation of multiple email gateways more easily. Currently you may not load configuration files from C/X-Series email gateways onto an M-Series Cisco Secure Manager Email and Web Gateway.
- You can divide an existing configuration file downloaded from one email gateway into multiple subsections. You can modify those sections that are common among all email gatewayS (in a multiple email gateway environment) and load them onto other email gateways as the subsections are updated.

For example, you could use an email gateway in a test environment for testing the Global Unsubscribe command. When you feel that you have configured the Global Unsubscribe list appropriately, you could then load the Global Unsubscribe configuration section from the test email gateway to all of your production email gateways.

## Managing Configuration Files

To manage configuration files on your email gateway, click the System Administration> Configuration File.

The Configuration File page contains the following sections:

- **Current Configuration** - used to save and export the current configuration file.
- **Load Configuration** - used to load a complete or partial configuration file.
- **End-User Safelist/Blocklist Database (Spam Quarantine)** - For information, see [Using Safelists and Blocklists to Control Email Delivery Based on Sender](#) , on page 949 and [Backing Up and Restoring the Safelist/Blocklist](#) , on page 958.

- **Reset Configuration** - used to reset the current configuration back to the factory defaults (you should save your configuration prior to resetting it).



---

**Note** The private keys and certificates are included in unencrypted PEM format along with the configuration file with encrypted passphrase.

---

### Related Topics

- [Saving and Exporting the Current Configuration File, on page 1022](#)
- [Loading a Configuration File, on page 1023](#)
- [Mailing the Configuration File, on page 1022](#)
- [Resetting the Current Configuration, on page 1025](#)

## Saving and Exporting the Current Configuration File

Using the **Current Configuration** section of the **System Administration > Configuration File** page, you can save the current configuration file to your local machine, save it on the email gateway (placed in the configuration directory in the FTP/SCP root), or email it to the address specified.

The following information is not saved with the configuration file:

- Certificates used for secure communications with services used by the URL filtering feature.
- CCO User IDs and Contract ID saved on the Contact Technical Support page.

You can mask the user's passphrases by clicking the **Mask passphrases in the Configuration Files** checkbox. Masking a passphrase causes the original, encrypted passphrase to be replaced with "\*\*\*\*\*" in the exported or saved file. Please note, however, that configuration files with masked passphrases cannot be loaded back into AsyncOS.

You can encrypt the user's passphrases by clicking the **Encrypt passphrases in the Configuration Files** checkbox. The following are the critical security parameters in the configuration file that will be encrypted.

- Certificate private keys
- RADIUS passwords
- LDAP bind passwords
- Local users' password hashes
- SNMP password
- DK/DKIM signing keys
- Outgoing SMTP authentication passwords
- PostX encryption keys
- PostX encryption proxy password
- FTP Push log subscriptions' passwords
- IPMI LAN password
- Updater server URLs

You can also configure this in the command-line interface using the `saveconfig` command.

## Mailing the Configuration File

Use the Email file to field in the **System Administration > Configuration File** or use the `m ailconfig` command to email the current configuration to a user as an attachment.

## Loading a Configuration File

Use the Load Configuration section of the **System Administration > Configuration File** page to load new configuration information into the email gateway. You can also configure this in the command-line interface using the `loadconfig` command.

You can load information in one of three methods:

- Placing information in the `configuration` directory and uploading it.
- Uploading the configuration file directly from your local machine.
- Pasting configuration information directly.



---

**Note** Configuration files with masked passphrases cannot be loaded.

In cluster mode, you can either choose to load the configuration for a cluster or an email gateway. For instructions to load cluster configuration, see [Loading a Configuration in Clustered Email Gateway, on page 1247](#).

---

Regardless of the method, you must include the following tags at the top of your configuration:

```
<?xml version="1.0" encoding="ISO-8859-1"?>

<!DOCTYPE config SYSTEM "config.dtd">

<config>

... your configuration information in valid XML

</config>
```

The closing `</config>` tag should follow your configuration information. The values in XML syntax are parsed and validated against the DTD (document type definition) located in the `configuration` directory on your email gateway. The DTD file is named `config.dtd`. If validation errors are reported at the command line when you use the `loadconfig` command, the changes are not loaded. You can download the DTD to validate configuration files outside of the email gateway before uploading them.

In either method, you can import an entire configuration file (the information defined between the highest level tags: `<config></config>`), or a *complete* and *unique* sub-section of the configuration file, as long as it contains the declaration tags (above) and is contained within the `<config></config>` tags.

“Complete” means that the entire start and end tags for a given subsection as defined by the DTD are included. For example, uploading or pasting this:

```
<?xml version="1.0" encoding="ISO-8859-1"?>

<!DOCTYPE config SYSTEM "config.dtd">

<config>

<autosupport_enabled>0</autosu
```

```
</config>
```

will cause validation errors, while uploading. This, however:

```
<?xml version="1.0" encoding="ISO-8859-1"?>
<!DOCTYPE config SYSTEM "config.dtd">
<config>
<autosupport_enabled>0</autosupport_enabled>
</config>
```

will not.

“Unique” means that the subsection of the configuration file being uploaded or pasted is not ambiguous for the configuration. For example, a system can have only one hostname, so uploading this (including the declarations and `<config></config>` tags):

```
<hostname>mail4.example.com</hostname>
```

is allowed. However, a system can have multiple listeners defined, each with different Recipient Access Tables defined, so uploading only this:

```
<rat>
  <rat_entry>
    <rat_address>ALL</rat_address>
    <access>RELAY</access>
  </rat_entry>
</rat>
```

is considered ambiguous and is not allowed, even though it is “complete” syntax.



---

**Caution** When uploading or pasting a configuration file or subsections of a configuration file, you have the potential to erase uncommitted changes that may be pending.

If disk space allocations in the configuration file are smaller than the amount of data currently stored on the email gateway, the oldest data will be deleted to meet the quota specified in the configuration file.

---

## Empty vs. Omitted Tags

Use caution when uploading or pasting sections of configuration files. If you do not include a tag, then its value in the configuration is not modified when you load a configuration file. However, if you include an empty tag, then its configuration setting is cleared.

For example, uploading this:

```
<listeners></listeners>
```



will remove all listeners from the system!

**Caution**

When uploading or pasting subsections of a configuration file, you have the potential to disconnect yourself from the web interface or CLI and to destroy large amounts of configuration data. Do not disable services with this command if you are not able to reconnect to the email gateway using another protocol, the Serial interface, or the default settings on the Management port. Also, do not use this command if you are unsure of the exact configuration syntax as defined by the DTD. Always back up your configuration data prior to loading a new configuration file.

**Note About Loading Passphrases for Log Subscriptions**

If you attempt to load a configuration file that contains a log subscription that requires a passphrase (for example, one that will use FTP push), the `loadconfig` command does not warn you about the missing passphrase. The FTP push will fail and alerts will be generated until you configure the correct passphrase using the `logconfig` command.

**Note About Character Set Encoding**

The “encoding” attribute of the XML configuration file must be “ `ISO-8859-1` ” regardless of the character set you may be using to manipulate the file offline. Note that the encoding attribute is specified in the file whenever you issue the `showconfig`, `saveconfig`, or `mailconfig` commands:

```
<?xml version="1.0" encoding="ISO-8859-1"?>
```

Currently, only configuration files with this encoding can be loaded.

**Related Topics**

- [Loading a Configuration in Clustered Email Gateway, on page 1247](#)

**Resetting the Current Configuration**

Resetting the current configuration causes your email gateway to revert back to the original factory defaults. You should save your configuration prior to resetting it. Resetting the configuration via this button in the GUI is not supported in a clustering environment.

See [Resetting to Factory Defaults, on page 1003](#).

**Viewing the Configuration File**

You can view the configuration file details using the `showconfig` command only. The `showconfig` command prints the current configuration to the screen.

```
mail3.example.com> showconfig
```

```
Do you want to include passphrases? Please be aware that a configuration without  
passphrases will fail when reloaded with loadconfig.
```

```
<?xml version="1.0" encoding="ISO-8859-1"?>
```

```
<!DOCTYPE config SYSTEM "config.dtd">
```

```
<!--
```

```
Product: IronPort model number Messaging Gateway Appliance (tm)
```

```
Model Number: model number
```

```
Version: version of AsyncOS installed
```

Serial Number: serial number

Current Time: current time and date

[The remainder of the configuration file is printed to the screen.]

## Configuration File Page

- [Managing the Configuration File, on page 1021](#)
- [Resetting to Factory Defaults, on page 1003](#)
- [Backing Up and Restoring the Safelist/Blocklist , on page 958](#)

## Managing Disk Space

- [\(Virtual Email Gateways Only\) Increasing Available Disk Space , on page 1026](#)
- [Viewing and Allocating Disk Space Usage , on page 1027](#)
- [Managing Disk Space for the Miscellaneous Quota , on page 1027](#)
- [Ensuring That You Receive Alerts About Disk Space , on page 1027](#)

### (Virtual Email Gateways Only) Increasing Available Disk Space

For virtual email gateways running ESXi 5.5 and VMFS 5, you can allocate more than 2TB of disk space. For email gateways running ESXi 5.1, the limit is 2 TB.

To add disk space to the virtual email gateway instance:



---

**Note** Disk space reduction is not supported. See the VMWare documentation for information.

---

#### Before You Begin

Carefully determine the disk space increase needed.

#### Procedure

---

**Step 1** Bring down the email gateway instance.

**Step 2** Increase disk space using utilities or administrative tools provided by VMWare.

See information about changing the virtual disk configuration in the VMWare documentation. At time of release, this information for ESXi 5.5 was available here: <http://pubs.vmware.com/vsphere-55/index.jsp?topic=%2Fcom.vmware.vsphere.hostclient.doc%2FGUID-81629CAB-72FA-42F0-9F86-F8FD0DE39E57.html>.

**Step 3** Go to **System Administration > Disk Management** and verify that your change has taken effect.

---

## Viewing and Allocating Disk Space Usage

You can optimize disk usage by allocating disk space on the email gateway among the features that your deployment uses.

To	Do This
<ul style="list-style-type: none"> <li>• View disk space quotas and current usage for each service</li> <li>• Reallocate disk space on your email gateway at any time</li> </ul>	Go to <b>System Administration &gt; Disk Management</b> .
Manage data volume	<ul style="list-style-type: none"> <li>• For reporting and tracking services and the spam quarantine, the oldest data will be deleted automatically.</li> <li>• For Policy, Virus and Outbreak quarantines, the default action configured in the quarantine will be taken. See <a href="#">Default Actions for Automatically Processed Quarantined Messages</a>, on page 927.</li> <li>• For the Miscellaneous quota, you must first manually delete data to reduce usage below the new quota you will set. See <a href="#">Managing Disk Space for the Miscellaneous Quota</a>, on page 1027.</li> </ul>

## Managing Disk Space for the Miscellaneous Quota

The Miscellaneous quota includes System data and User data. You cannot delete System data. User data that you can manage includes the following types of files:

To Manage	Do this
Log files	Go to <b>System Administration &gt; Log Subscriptions</b> and: <ul style="list-style-type: none"> <li>• Look to see which log directories consume the most disk space.</li> <li>• Verify that you need all of the log subscriptions that are being generated.</li> <li>• Verify that the log level is no more verbose than necessary.</li> <li>• If feasible, reduce the rollover file size.</li> </ul>
Packet captures	Go to <b>Help and Support</b> (near the upper right side of your screen) > <b>Packet Capture</b> .
Configuration files (These files are unlikely to consume much disk space.)	FTP to the /data/pub directory on the email gateway. To configure FTP access to the email gateway, see <a href="#">FTP, SSH, and SCP Access</a> , on page 1303
Quota size	Go to <b>System Administration &gt; Disk Management</b> .

## Ensuring That You Receive Alerts About Disk Space

You will begin to receive system alerts at warning level when Miscellaneous disk usage reaches 75% of the quota. You should take action when you receive these alerts.

To ensure that you receive these alerts, see [Alerts, on page 1047](#).

## Disk Space and Centralized Management

Disk space management is available only in machine mode, not in group or cluster mode.

## Managing Security Services

The Services Overview page lists the current service and rule versions of the following engines:

- Graymail
- McAfee
- Sophos

You can perform the following tasks in the Services Overview page:

- Manually update the engines. For more information, see [Manually Updating the Engines, on page 1028](#)
- Rollback to previous version of the engine. For more information, see [Rollback to Previous Version of Engine, on page 1029](#)

The **Auto Update** column shows the status of the automatic updates of a particular engine. If you want to enable or disable Automatic Updates, go to the **Global Settings** page of particular engine.

When automatic updates are disabled for a specific service engine, you will receive alerts periodically. If you want to change the alert interval, use the **Alert Interval for Disabled Automatic Engine Updates** option in the Security Services > Service Updates page.



---

**Note** Auto Updates are disabled automatically for the engine on which the rollback is applied.

---

### Related Topics

- [Manually Updating the Engines, on page 1028](#)
- [Rollback to Previous Version of Engine, on page 1029](#)
- [Viewing Logs, on page 1029](#)
- [System Alerts, on page 1055](#)

## Manually Updating the Engines

### Procedure

---

- Step 1** Go to **Security Services > Services Overview** page.
- Step 2** Click **Update** in the **Available Updates** column for the latest service or rule version of the service engine.

**Note** The **Update** option is available only if new updates are available for the particular engine.

---

## Rollback to Previous Version of Engine

### Procedure

---

- Step 1** Go to **Security Services > Services Overview** page.
- Step 2** Click **Change** in the **Modify Versions** column.
- Step 3** Select the required rule and service version of the update and click **Apply**.

The email gateway rolls back the engine to the previous version.

**Note** A Service Updates includes the service version and the rule version together as a package.

Once you click **Apply**, the automatic updates for the particular engine is automatically disabled. To enable the automatic updates, go to the Global Settings page of the particular engine.

---

## Viewing Logs

The information about engine rollback and disabling automatic updates is posted to the following logs:

- **Updater Logs:** Contains information about the engine rollback and automatic updating of the engine. Most information is at Info or Debug level.

For more information, see [Updater Log Example, on page 1197](#).

## Service Updates

The following services require updates for maximum effectiveness:

- Feature Keys
- McAfee Anti-Virus definitions
- PXE Engine
- Sophos Anti-Virus definitions
- IronPort Anti-Spam rules
- Outbreak Filters rules
- Time zone rules
- URL categories (Used for URL filtering features. For details, see [Future URL Category Set Changes](#) , on page 475)
- Enrollment client (Used for updating certificates needed for communication with cloud-based services used for URL filtering features. For information, see [About the Connection to Talos Intelligence Services](#) , on page 446.)
- Graymail rules



---

**Note** Settings for the DLP engine and content matching classifiers are handled on the **Security Services > Data Loss Prevention** page. See [About Updating the DLP Engine and Content Matching Classifiers, on page 532](#) for more information.

---

Service update settings are used for all services that receive updates except DLP updates. You cannot specify unique settings for any individual service except DLP updates.

To set up the network and the email gateway to obtain these critical updates, see [Setting Up to Obtain Upgrades and Updates](#) , on page 1030.

## Setting Up to Obtain Upgrades and Updates

- [Options for Distributing Upgrades and Updates](#) , on page 1030
- [Configuring Your Network to Download Upgrades and Updates from the Cisco Servers](#) , on page 1030
- [Configuring the Email Gateway for Upgrades and Updates in Strict Firewall Environments](#), on page 1031
- [Upgrading and Updating from a Local Server](#), on page 1031
- [Hardware and Software Requirements for Upgrading and Updating from a Local Server](#), on page 1032
- [Hosting an Upgrade Image on a Local Server](#), on page 1033
- [Configuring Server Settings for Downloading Upgrades and Updates](#) , on page 1034
- [Configuring Automatic Updates](#) , on page 1036
- [Configuring the Email Gateway to Verify the Validity of Updater Server Certificate](#), on page 1036
- [Configuring the Appliance to Trust Proxy Server Communication](#), on page 1037

## Options for Distributing Upgrades and Updates

There are several ways to distribute AsyncOS upgrade and update files to your email gateways:

- Each email gateway can download the files directly from the Cisco update servers. This is the default method.
- You can download the files from Cisco once, and then distribute them to your email gateways from a server within your network. See [Upgrading and Updating from a Local Server, on page 1031](#).

To choose and configure a method, see [Configuring Server Settings for Downloading Upgrades and Updates](#) , on page 1034.

## Configuring Your Network to Download Upgrades and Updates from the Cisco Servers

The email gateway connect directly to the Cisco update servers to find and download upgrades and updates:

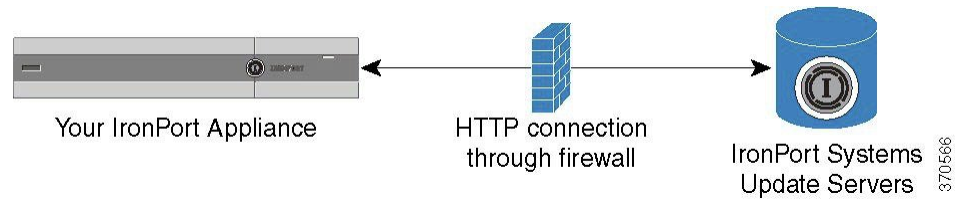
**Figure 73: Streaming Update Method**

Cisco update servers use dynamic IP addresses. If you have strict firewall policies, you may need to configure a static location instead. For more information, see [Configuring the Email Gateway for Upgrades and Updates in Strict Firewall Environments, on page 1031](#).

Create a firewall rule to allow downloading of upgrades from Cisco update servers on ports 80 and 443.

## Configuring the Email Gateway for Upgrades and Updates in Strict Firewall Environments

The Cisco IronPort upgrade and update servers use dynamic IP addresses. If you have strict firewall policies, you may need to configure a static location for updates and AsyncOS upgrades.

### Procedure

- 
- Step 1** Contact Cisco Customer support to obtain the static URL address.
  - Step 2** Create a firewall rule to allow downloading of upgrades and updates from the static IP address on port 80.
  - Step 3** Choose **Security Services > Service Updates**.
  - Step 4** Click **Edit** Update Settings.
  - Step 5** On the Edit Update Settings page, in the “Update Servers (images)” section, choose Local Update Servers and enter the static URL received in step 1 in the Base URL field for AsyncOS upgrades and McAfee Anti-Virus definitions.
  - Step 6** Verify that IronPort Update Servers is selected for the “Update Servers (list)” section.
  - Step 7** Submit and commit your changes.
- 

## Upgrading and Updating from a Local Server

You can download AsyncOS upgrade images to a local server and host upgrades from within your own network rather than obtaining upgrades directly from Cisco’s update servers. Using this feature, an upgrade image is downloaded via HTTP to any server in your network that has access to the Internet. If you choose to download the upgrade image, you can then configure an internal HTTP server (an “update manager”) to host the AsyncOS images to your appliances.

Use a local server if your email gateway does not have access to the internet, or if your organization restricts access to mirror sites used for downloads. Downloading AsyncOS upgrades to each email gateway from a local server is generally faster than downloading from the Cisco IronPort servers.



**Note** Cisco recommends using a local server only for AsyncOS upgrades. If you use a local update server for security update images, the local server does not automatically receive security updates from Cisco IronPort, so the email gateways in your network may not always have the most current security services.

**Figure 74: Remote Update Method**

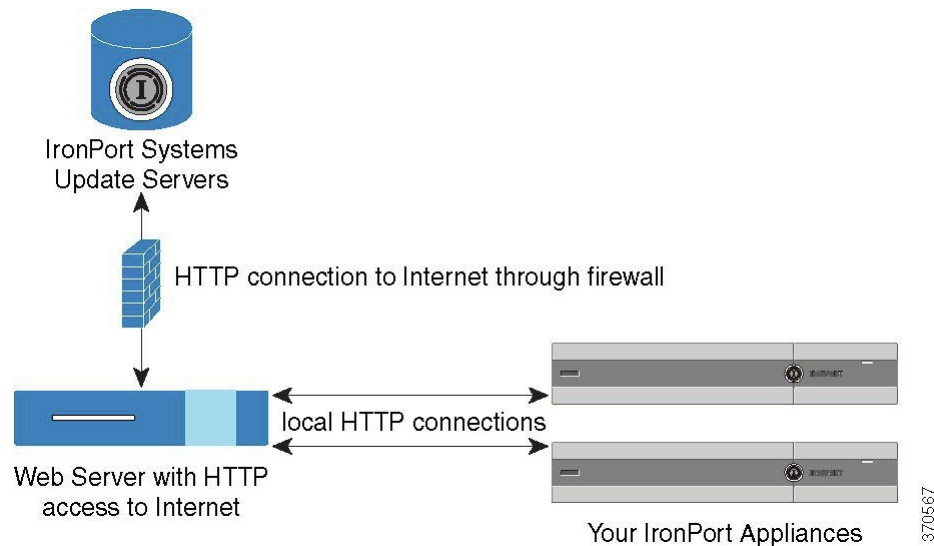

### Procedure

- Step 1** Configure a local server to retrieve and serve the upgrade files.
- Step 2** Download the upgrade files.
- Step 3** Configure the appliance to use the local server using either the **Security Services > Service Updates** page in the GUI or the `updateconfig` command in the CLI.
- Step 4** Upgrade the appliance using either the **System Administration > System Upgrade** page or the upgrade command in the CLI.

## Hardware and Software Requirements for Upgrading and Updating from a Local Server

For *downloading* AsyncOS upgrade and update files, you must have a system in your internal network that has:

- Internet access to the Cisco Systems update servers.
- A web browser (see [Browser Requirements, on page 9](#)).





---

**Note** For this release, if you need to configure a firewall setting to allow HTTP access to this address, you must configure it using the DNS name and not a specific IP address.

---

For *hosting* AsyncOS update files, you must have a server in your internal network that has:

- A web server — for example, Microsoft IIS (Internet Information Services) or the Apache open source server — which:
  - supports the display of directory or filenames in excess of 24 characters
  - has directory browsing enabled
  - is configured for anonymous (no authentication) or basic (“simple”) authentication
  - contains at least 350MB of free disk space for each AsyncOS update image

## Hosting an Upgrade Image on a Local Server

After setting up a local server, go to [http://updates.ironport.com/fetch\\_manifest.html](http://updates.ironport.com/fetch_manifest.html) to download a ZIP file of an upgrade image. To download the image, enter your serial number (for a physical email gateway) or a VLN (for a virtual email gateway) and the version number of the email gateway. You will then be presented with a list of available upgrades. Click on the upgrade version that you want to download, and unzip the ZIP file in the root directory on the local server while keeping the directory structure intact. To use the upgrade image, configure the email gateway to use the local server on the Edit Update Settings page (or use `updateconfig` in the CLI).

The local server also hosts an XML file that limits the available AsyncOS upgrades for the email gateways on your network to the downloaded upgrade image. This file is called the “manifest.” The manifest is located in the `asyncos` directory of the upgrade image ZIP file. After unzipping the ZIP file in the root directory of the local server, enter the full URL for the XML file, including the filename, on the Edit Update Settings page (or use `updateconfig` in the CLI).

For more information about remote upgrades, please see the Knowledge Base or contact your Cisco Support provider.

## Updates Through a Proxy Server

The email gateway is configured (by default) to connect directly to Cisco’s update servers to receive updates. This connection is made by HTTP on port 80 and the content is encrypted. If you do not want to open this port in your firewall, you can define a proxy server and specific port from which the email gateway can receive updated rules.

If you choose to use a proxy server, you can specify an optional authentication and port.



---

**Note** If you define a proxy server, it will *automatically* be used for all service updates that are configured to use a proxy server. There is no way to turn off the proxy server for updates to any individual service.

---

## Configuring Server Settings for Downloading Upgrades and Updates

Specify the server and connection information required to download upgrades and updates to your email gateway.

You can use the same or different settings for AsyncOS upgrades and for service updates.

### Before You Begin

Determine whether the email gateway will download upgrades and updates directly from Cisco, or whether you will host these images from a local server on your network instead. Then set up your network to support the method you choose. See all topics under [Setting Up to Obtain Upgrades and Updates](#), on page 1030.

### Procedure

**Step 1** Choose **Security Services > Service Updates**.

**Step 2** Click **Edit Update Settings**.

**Step 3** Enter options:

Setting	Description
<b>Update Servers (images)</b>	<p>Choose whether to download Cisco IronPort AsyncOS upgrade images and service updates from the Cisco IronPort update servers or a from a local server on your network. The default is the Cisco IronPort update servers for both upgrades and updates.</p> <p>To use the same settings for upgrades and updates, enter information in the visible fields.</p> <p>If you choose a local update server, enter the base URL and port number for the servers used to download the upgrades and updates. If the server requires authentication, you can also enter a valid username and passphrase.</p> <p>To enter separate settings solely for AsyncOS upgrades and McAfee Anti-Virus definitions, click the <b>Click to use different settings for AsyncOS</b> link.</p> <p><b>Note</b> Cisco Intelligent Multi-Scan requires a second local server to download updates for third-party anti-spam rules.</p>

Setting	Description
Update Servers (lists)	<p>To ensure that only upgrades and updates that are appropriate to your deployment are available to each email gateway, Cisco IronPort generates a manifest list of the relevant files.</p> <p>Choose whether to download the lists of available upgrades and service updates (the manifest XML files) from the Cisco IronPort update servers or from a local server on your network.</p> <p>There are separate sections for specifying servers for updates and for AsyncOS upgrades. The default for upgrades and updates is the Cisco IronPort update servers.</p> <p>If you choose local update servers, enter the full path to the manifest XML file for each list, including the file name and HTTP port number for the server. If you leave the port field blank, AsyncOS uses port 80. If the server requires authentication, enter a valid user name and passphrase.</p>
<b>Automatic Updates</b>	<p>Enable automatic updates and the update interval (how often the email gateway checks for updates) for Sophos and McAfee Anti-Virus definitions, Cisco Anti-Spam rules, Cisco Intelligent Multi-Scan rules, PXE Engine updates, Outbreak Filter rules, and time zone rules.</p> <p>Include a trailing s, m, or h to indicate seconds, minutes, or hours. Enter 0 (zero) to disable automatic updates.</p> <p><b>Note</b> You can only turn on automatic updates for DLP using the <b>Security Services &gt; Data Loss Prevention</b> page. However, you must enable automatic updates for all services first. See <a href="#">About Updating the DLP Engine and Content Matching Classifiers</a>, on page 532 for more information.</p>
<b>Alert Interval for Disabled Automatic Engine Updates</b>	<p>Enter specific frequency of alerts to be sent when the ‘Automatic Updates’ feature is disabled for a specific engine.</p> <p>Include a trailing m, h, or d to indicate months, hours, or days. The default value is 30 days.</p>
<b>Interface</b>	<p>Choose which network interface to use when contacting the update servers for the listed security component updates. The available proxy data interfaces are shown. By default, the email gateway selects an interface to use.</p>
<b>HTTP Proxy Server</b>	<p>An optional proxy server used for the services listed in the GUI.</p> <p>If you specify a proxy server, it will be used to update ALL services.</p>
<b>HTTPS Proxy Server</b>	<p>An optional proxy server using HTTPS. If you define the HTTPS proxy server, it will be used to update the services listed in the GUI.</p>

**Step 4** Submit and commit your changes.

## Configuring Automatic Updates

### Procedure

- 
- Step 1** Navigate to the **Security Services > Service Updates** page, and click **Edit Update Settings**.
  - Step 2** Select the check box to enable automatic updates.
  - Step 3** Enter an update interval (time to wait between checks for updates). Add a trailing **m** for minutes and **h** for hours. The maximum update interval is 1 hour.
- 

## Configuring the Email Gateway to Verify the Validity of Updater Server Certificate

The email gateway can check the validity of Cisco updater server certificate every time the email gateway communicates the updater server. If you configure this option and the verification fails, updates are not downloaded and the details are logged in Updater Logs.

Use the `updateconfig` command to configure this option. The following example shows how to configure this option.

```
mail.example.com> updateconfig
Service (images):                               Update URL:
-----
Feature Key updates                             http://downloads.ironport.com/asyncos
Timezone rules                                 Cisco IronPort Servers
Enrollment Client Updates                     Cisco IronPort Servers
Support Request updates                       Cisco IronPort Servers
Cisco IronPort AsyncOS upgrades              Cisco IronPort Servers
Service (list):                               Update URL:
-----
Timezone rules                                 Cisco IronPort Servers
Enrollment Client Updates                     Cisco IronPort Servers
Support Request updates                       Cisco IronPort Servers
Service (list):                               Update URL:
-----
Cisco IronPort AsyncOS upgrades              Cisco IronPort Servers
Update interval: 5m
Proxy server: not enabled
HTTPS Proxy server: not enabled
Choose the operation you want to perform:
- SETUP - Edit update configuration.
- VALIDATE_CERTIFICATES - Validate update server certificates
- TRUSTED_CERTIFICATES - Manage trusted certificates for updates
[ ]> validate_certificates
Should server certificates from Cisco update servers be validated?
[Yes]>
Service (images):                               Update URL:
-----
Feature Key updates                             http://downloads.ironport.com/asyncos
Timezone rules                                 Cisco IronPort Servers
Enrollment Client Updates                     Cisco IronPort Servers
Support Request updates                       Cisco IronPort Servers
Cisco IronPort AsyncOS upgrades              Cisco IronPort Servers
Service (list):                               Update URL:
```

```

-----
Timezone rules                                Cisco IronPort Servers
Enrollment Client Updates                    Cisco IronPort Servers
Support Request updates                       Cisco IronPort Servers
Service (list):                              Update URL:
-----

Cisco IronPort AsyncOS upgrades              Cisco IronPort Servers
Update interval: 5m
Proxy server: not enabled
HTTPS Proxy server: not enabled
Choose the operation you want to perform:
- SETUP - Edit update configuration.
- VALIDATE_CERTIFICATES - Validate update server certificates
- TRUSTED_CERTIFICATES - Manage trusted certificates for updates
[ ]>

```

## Configuring the Appliance to Trust Proxy Server Communication

If you are using a non-transparent proxy server, you can add the CA certificate used to sign the proxy certificate to the email gateway. By doing so, the email gateway trusts the proxy server communication.

Use the `updateconfig` command to configure this option. The following example shows how to configure this option.

```

mail.example.com> updateconfig
...
...
...
Choose the operation you want to perform:
- SETUP - Edit update configuration.
- VALIDATE_CERTIFICATES - Validate update server certificates
- TRUSTED_CERTIFICATES - Manage trusted certificates for updates
[ ]> trusted_certificates
Choose the operation you want to perform:
- ADD - Upload a new trusted certificate for updates.
[ ]> add
Paste certificates to be trusted for secure updaters connections, blank to quit
Trusted Certificate for Updater:
Paste cert in PEM format (end with '.'):
-----BEGIN CERTIFICATE-----
MMIICiDCCAFgGAWIBAgIBATANBgkqhkiG9w0BAQUFADCBgDELMAkGA1UEBhmCSU4x
DDAKBgNVBAGTA0tBUjENM.....
-----END CERTIFICATE-----
.
Choose the operation you want to perform:
- ADD - Upload a new trusted certificate for updates.
- LIST - List trusted certificates for updates.
- DELETE - Delete a trusted certificate for updates.
[ ]>

```

# Upgrading AsyncOS

## Procedure

	Command or Action	Purpose
<b>Step 1</b>	If you have not yet done so, configure settings that apply to all update and upgrade downloads, and set up your network to support and optionally distribute these downloads.	<a href="#">Setting Up to Obtain Upgrades and Updates</a> , on page 1030
<b>Step 2</b>	Understand when an upgrade is available and determine whether to install it.	<a href="#">Notifications of Available Upgrades</a> , on page 1038
<b>Step 3</b>	Perform required and recommended tasks before each upgrade.	<a href="#">Preparing to Upgrade AsyncOS</a> , on page 1039 <a href="#">Upgrading Machines in a Cluster</a> , on page 1237
<b>Step 4</b>	Perform the upgrade.	<a href="#">Downloading and Installing the Upgrade</a> , on page 1039

## About Upgrading Clustered Systems

If you are upgrading clustered machines, please see [Upgrading Machines in a Cluster](#), on page 1237.

## About Batch Commands for Upgrade Procedures

Batch commands for upgrade procedures are documented in the *CLI Reference Guide for AsyncOS for Cisco Email Security Appliances* at [http://www.cisco.com/en/US/products/ps10154/prod\\_command\\_reference\\_list.html](http://www.cisco.com/en/US/products/ps10154/prod_command_reference_list.html).

## Notifications of Available Upgrades

By default, users with administrator and technician privileges will see a notification at the top of the web interface when an AsyncOS upgrade is available for the email gateway.

On clustered machines, actions apply only to the machine to which you are logged in.

To	Do This
View more information about the latest upgrade	Hover over the upgrade notification.
View a list of all available upgrades	Click the down arrow in the notification.
Dismiss a current notification. The email gateway will not display another notification until a new upgrade becomes available.	Click the down arrow, then select <b>Clear the notification</b> , then click <b>Close</b> .
Prevent future notifications (Users with Administrator privileges only.)	Go to <b>Management Appliance &gt; System Administration &gt; System Upgrade</b> .

## Notifications of Available Upgrades

By default, users with administrator and technician privileges will see a notification at the top of the web interface when an AsyncOS upgrade is available for the email gateway.

On clustered machines, actions apply only to the machine to which you are logged in.

To	Do This
View more information about the latest upgrade	Hover over the upgrade notification.
View a list of all available upgrades	Click the down arrow in the notification.
Dismiss a current notification. The email gateway will not display another notification until a new upgrade becomes available.	Click the down arrow, then select <b>Clear the notification</b> , then click <b>Close</b> .
Prevent future notifications (Users with Administrator privileges only.)	Go to <b>Management Appliance &gt; System Administration &gt; System Upgrade</b> .

## Preparing to Upgrade AsyncOS

As a best practice, Cisco recommends preparing for an upgrade by taking the following steps.

### Before you begin

Clear all the messages in your work queue. You cannot perform the upgrade without clearing your work queue.

### Procedure

- 
- Step 1** Save the XML configuration file off-box. If you need to revert to the pre-upgrade release for any reason, you will need this file.
  - Step 2** If you are using the Safelist/Blocklist feature, export the list off-box.
  - Step 3** Suspend all listeners. If you perform the upgrade from the CLI, use the suspendlistener command. If you perform the upgrade from the GUI, listener suspension occurs automatically.
  - Step 4** Wait for the queue to empty. You can use the workqueue command to view the number of messages in the work queue or the rate command in the CLI to monitor the message throughput on your email gateway.

**Note** Re-enable the listeners post-upgrade.

---

## Downloading and Installing the Upgrade

You can download and install in a single operation, or download in the background and install later.



**Note** When downloading and upgrading AsyncOS in a single operation from a local server instead of from a Cisco IronPort server, the upgrade installs immediately *while downloading*. A banner displays for 10 seconds at the beginning of the upgrade process. While this banner is displayed, you have the option to type Control-C to exit the upgrade process before downloading starts.

### Before You Begin

- Choose whether you will download upgrades directly from Cisco or will host upgrade images from a server on your network. Then set up your network to support the method you choose. Then configure the email gateway to obtain upgrades from your chosen source. See [Setting Up to Obtain Upgrades and Updates](#), on page 1030 and [Configuring Server Settings for Downloading Upgrades and Updates](#), on page 1034.
- If you will install the upgrade now, follow the instructions in [Preparing to Upgrade AsyncOS](#), on page 1039.
- If you are installing the upgrade in a clustered system, see [Upgrading Machines in a Cluster](#), on page 1237.
- If you will only download the upgrade, there are no prerequisites until you are ready to install it.
- After you upgrade, you cannot use TLS v1.0 in FIPS mode. However, you can re-enable TLS v1.0 on the email gateway, if necessary.

### Procedure

**Step 1** Choose **System Administration > System Upgrade**.

**Step 2** Click **Upgrade Options**.

**Step 3** Click **Upgrade** to proceed with the upgrade process.

**Step 4** Choose an option:

To	Do This
Download and install the upgrade in a single operation	Click <b>Download and Install</b> . If you have already downloaded an installer, you will be prompted to overwrite the existing download.
Download an upgrade installer	Click <b>Download only</b> . If you have already downloaded an installer, you will be prompted to overwrite the existing download. The installer downloads in the background without interrupting service.
Install a downloaded upgrade installer	Click <b>Install</b> . This option appears only if an installer has been downloaded. The AsyncOS version to be installed is noted below the Install option.

**Step 5** Unless you are installing a previously-downloaded installer, select an AsyncOS version from the list of available upgrades.



- Step 6** If you are installing:
- Choose whether or not to save the current configuration to the configuration directory on the email gateway.
  - Choose whether or not to mask the passphrases in the configuration file.  
**Note** You cannot load a configuration file with masked passphrases using the Configuration File page in the GUI or the loadconfig command in the CLI.
  - If you want to email copies of the configuration file, enter the email addresses to which you want to email the file. Use commas to separate multiple email addresses.
- Step 7** Click **Proceed**.
- Step 8** If you are installing:
- Be prepared to respond to prompts during the process.  
The process pauses until you respond.  
A progress bar appears near the top of the page.
  - At the prompt, click **Reboot Now**.
  - After about 10 minutes, access the email gateway again and log in.  
If you feel you need to power-cycle the email gateway to troubleshoot an upgrade issue, do not do so until at least 20 minutes have passed since you rebooted.

---

### What to do next

- If the process was interrupted, you must start the process again.
- If you downloaded but did not install the upgrade:  
When you are ready to install the upgrade, follow these instructions from the beginning, including the prerequisites in the Before You Begin section, but choose the Install option.
- If you installed the upgrade:
  - Re-enable (resume) the listeners.
  - Save a configuration file for the new system. For information, see [Managing the Configuration File, on page 1021](#).
- After upgrade is complete, re-enable listeners.

## Viewing Status of, Canceling, or Deleting a Background Download

### Procedure

---

- Step 1** Choose **System Administration > System Upgrade**.
- Step 2** Click **Upgrade Options**.
- Step 3** Choose an option:

To	Do This
View download status	Look in the middle of the page. If there is no download in progress and no completed download waiting to be installed, you will not see download status information.
Cancel a download	Click the <b>Cancel Download</b> button in the middle of the page. This option appears only while a download is in progress.
Delete a downloaded installer	Click the <b>Delete File</b> button in the middle of the page. This option appears only if an installer has been downloaded.

**Step 4** (Optional) View the Upgrade Logs.

## Enabling Remote Power Cycling

The ability to remotely reset the power for the email gateway chassis is available only on 80 - and 90- series hardware.

If you want to be able to remotely reset email gateway power, you must enable and configure this functionality in advance, using the procedure described in this section.

### Before You Begin

- Cable the dedicated Remote Power Cycle (RPC) port directly to a secure network. For information, see the Hardware Installation Guide.
- Ensure that the email gateway is accessible remotely; for example, open any necessary ports through the firewall.
- This feature requires a unique IPv4 address for the dedicated Remote Power Cycle interface. This interface is configurable only via the procedure described in this section; it cannot be configured using the `ipconfig` command.
- In order to cycle email gateway power, you will need a third-party tool that can manage devices that support the Intelligent Platform Management Interface (IPMI) version 2.0. Ensure that you are prepared to use such a tool.
- For more information about accessing the command-line interface, see the CLI reference guide.

### Procedure

**Step 1** Use SSH or the serial console port to access the command-line interface.

**Step 2** Sign in using an account with Administrator access.

**Step 3** Enter the following commands:

```
remotepower
```

```
setup
```

**Step 4** Follow the prompts to specify the following:

- a. The dedicated IP address for this feature, plus netmask and gateway.

- b. The username and passphrase required to execute the power-cycle command.

These credentials are independent of other credentials used to access your email gateway.

**Step 5** Enter commit to save your changes.

**Step 6** Test your configuration to be sure that you can remotely manage email gateway power.

**Step 7** Ensure that the credentials that you entered will be available to you in the indefinite future. For example, store this information in a safe place and ensure that administrators who may need to perform this task have access to the required credentials.

---

### What to do next

#### Related Topics

- [Remotely Resetting Email Gateway Power](#) , on page 1275

## Reverting to a Previous Version of AsyncOS

AsyncOS includes the ability to revert the AsyncOS operating system to a previous qualified build for emergency uses.

### Reversion Impact

Using the revert command on an email gateway is a very destructive action. This command destroys all configuration logs and databases. Only the network information for the management interface is preserved--all other network configuration is deleted. In addition, reversion disrupts mail handling until the email gateway is reconfigured. Because this command destroys network configuration, you may need physical local access to the email gateway when you want to issue the revert command.



---

**Caution** You must have a configuration file for the version you want to revert to. Configuration files are *not* backwards-compatible.

---

### Reverting AsyncOS on Virtual Email Gateways May Impact the License

If you revert from AsyncOS 9.0 for Email to AsyncOS 8.5 for Email, the license does not change.

If you revert from AsyncOS 9.0 for Email to AsyncOS 8.0 for Email, there is no longer a 180-day grace period during which the email gateway delivers mail without security features.

Feature key expiration dates do not change in either case.

#### Related Topics

- [Virtual Email Gateway License Expiration](#) , on page 1020

## Reverting AsyncOS

### Procedure

---

- Step 1** Ensure that you have the configuration file for the version you wish to revert to. Configuration files are not backwards-compatible. To do this, you can email the file to yourself or FTP the file. For information, see [Mailing the Configuration File, on page 1022](#).
- Step 2** Save a backup copy of the current configuration of your email gateway (with passphrases unmasked) on another machine.
- Note** This is not the configuration file you will load after reverting.
- Step 3** If you use the Safelist/Blocklist feature, export the Safelist/Blocklist database to another machine.
- Step 4** Wait for the mail queue to empty.
- Step 5** Log into the CLI of the email gateway you want to revert.
- When you run the revert command, several warning prompts are issued. After these warning prompts are accepted, the revert action takes place immediately. Therefore, do not begin the reversion process until after you have completed the pre-reversion steps.
- Step 6** From the CLI, Issue the **revert** command.
- Note** The reversion process is time-consuming. It may take fifteen to twenty minutes before reversion is complete and console access to the email gateway is available again.
- Step 7** Wait for the email gateway to reboot twice.
- Step 8** After the machine reboots twice, use the serial console to configure an interface with an accessible IP address using the **interfaceconfig** command.
- Step 9** Enable FTP or HTTP on one of the configured interfaces.
- Step 10** Either FTP the XML configuration file you created, or paste it into the GUI interface.
- Step 11** Load the XML configuration file of the version you are reverting to.
- Step 12** If you use the Safelist/Blocklist feature, import and restore the Safelist/Blocklist database.
- Step 13** Commit your changes.
- The reverted email gateway should now run using the selected AsyncOS version.
- 

## Configuring the Return Address for Email Gateway Generated Messages

You can configure the envelope sender for mail generated by AsyncOS for the following circumstances:

- Anti-Virus notifications
- Bounces
- DMARC feedback
- Notifications ( `notify()` and `notify-copy()` filter actions)
- Quarantine notifications (and “Send Copy” in quarantine management)

- Reports
- All other messages

You can specify the display, user, and domain names of the return address. You can also choose to use the Virtual Gateway domain for the domain name.

You can modify the return address for system-generated email messages in the GUI or in the CLI using the `addressconfig` command.

### Procedure

- 
- Step 1** Navigate to the System Administration > Return Addresses page.
  - Step 2** Click **Edit Settings**.
  - Step 3** Make changes to the address or addresses you want to modify
  - Step 4** Submit and commit your changes.
- 

## Setting Thresholds for System Health Parameters

Depending on your organization's requirements, you can configure the threshold for various health parameters of your email gateway such as CPU usage, maximum messages in the workqueue, and so on. You can also configure the email gateway to send alerts when the specified threshold values are crossed.



---

**Note** To configure the threshold for system health parameters using CLI, use the `healthconfig` command. For more information, see the CLI inline help or *CLI Reference Guide for AsyncOS for Cisco Email Security Appliances*.

---

### Before You Begin

Carefully determine the threshold values.

### Procedure

- 
- Step 1** Click **System Administration > System Health**.
  - Step 2** Click **Edit Settings**.
  - Step 3** Configure the following options:
    - Specify the threshold level for CPU usage (in percent).
 

Also, specify if you want to receive an alert if the current CPU usage has crossed the configured threshold value. After the first alert is sent, if the CPU usage crosses the running average from the time the first alert was triggered by five percent in 15 minutes, an additional alert is sent.

**Note** These alerts are triggered based only on the CPU usage of the mail handling process.
    - Specify the threshold level for memory page swapping (in percent).

Also, specify if you want to receive an alert if the overall memory swap usage crosses the configured threshold value. After the first alert is sent, if the memory page swapping crosses the value that triggered the first alert by 150 percent or after a 15 minutes alert interval, an additional alert is sent. For example, if the threshold is set to 10,

- When the memory swap usage reaches 10.1%, the first alert is sent.
- When the memory swap usage reaches 15.1% in 15 minutes, one more alert is sent.
- Specify the threshold level for maximum messages in workqueue (in number of messages).

Also, specify if you want to receive an alert if the number of messages in work queue has crossed the configured threshold value. After the first alert is sent, if the maximum messages in work queue crosses the value that triggered the first alert by 150 percent within 15 minutes, an additional alert is sent. For example, if the threshold is set to 1000,

- When the maximum messages in work queue reached 1002, the first alert was sent.
- When the maximum messages in work queue reached 1510 with 15 minutes, one more alert is sent.

**Note** All the alerts for this feature belong to the System Alert category.

**Step 4** Submit and commit your changes.

---

#### What to do next

If you have configured alerts for this feature, make sure that you subscribe to the System Alerts. For instructions, see [Adding Alert Recipients, on page 1048](#).

## Checking the Health of Email Gateway

You can use the health check functionality to check the health of your email gateway. When you run the health check, the system analyzes historical data (up to three months) in the current Status Logs to determine the health of the email gateway.



**Note** For the system to perform this analysis, the Status Logs must contain a minimum of one month of logging data.

---

To run the health check,

- On web interface, go to **System Administration > System Health** page and click **Run Health Check**.
- On CLI, run the command: `healthcheck` .

The analysis results will indicate whether system has experienced one or more of the following problems in the last few months:

- Resource conservation mode
- Delay in mail processing
- High CPU usage
- High memory usage
- High memory page swapping

If the health check is indicating that your email gateway has experienced one or more of the above problems, consider reviewing and fine-tuning your system configuration. For more information, see: <http://www.cisco.com/c/en/us/support/docs/security/email-security-appliance/118881-technote-esa-00.html>

## Alerts

Alert messages are automatically-generated standard email messages that contain information about events occurring on the email gateways. These events can be of varying levels of importance (or severity) from minor to major and pertain generally to a specific component or feature on your email gateway. Alerts are generated by the email gateway. You can specify, at a much more granular level, which alert messages are sent to which users and for which severity of event they are sent. Manage alerts via the System Administration > Alerts page in the GUI (or via the `alertconfig` command in the CLI).

## Alert Severities

Alerts can be sent for the following severities:

- Critical: Requires immediate attention.
- Warning: Problem or error requiring further monitoring and potentially immediate attention.
- Information: Information generated in the routine functioning of this device.

## AutoSupport

To allow Cisco to better support and design future system changes, the email gateway can be configured to send Cisco Systems a copy of all alert messages generated by the system. This feature, called AutoSupport, is a useful way to allow our team to be proactive in supporting your needs. AutoSupport also sends weekly reports noting the uptime of the system, the output of the `status` command, and the AsyncOS version used.

By default, alert recipients set to receive Information severity level alerts for System alert types will receive a copy of every message sent to Cisco. This can be disabled if you do not want to send the weekly alert messages internally. To enable or disable this feature, see [Configuring Alert Settings, on page 1049](#).

## Alert Delivery

Alerts sent from the email gateway to addresses specified in the Alert Recipient follow SMTP routes defined for those destinations

Since alert messages can be used to inform you of problems within your email gateway, they are not sent using AsyncOS's normal mail delivery system. Instead, alert messages pass through a separate and parallel email system designed to operate even in the face of significant system failure in AsyncOS.

The alert mail system does not share the same configuration as AsyncOS, which means that alert messages may behave slightly differently from other mail delivery:

- Alert messages are delivered using standard DNS MX and A record lookups.
- They do cache the DNS entries for 30 minutes and the cache is refreshed every 30 minutes, so in case of DNS failure the alerts still go out.

- Alert messages do not pass through the work queue, so they are not scanned for viruses or spam. They are also not subjected to message filters or content filters.
- Alert messages do not pass through the delivery queue, so they are not affected by bounce profiles or destination control limits.



---

**Note** [Optional - Only if TLS support is enabled using the `alertconfig` CLI command and FQDN validation enabled in the SSL Configuration settings page]: Check whether the 'Common Name,' 'SAN: DNS Name' fields, or both present in the server certificate, are in the FQDN format.

---



---

**Note** [Optional - Only if TLS support is enabled using the `alertconfig` CLI command and X 509 validation enabled in the SSL Configuration settings page]: Check for signature algorithm of the server certificate.

---

## Example Alert Message

```
Date: 23 Mar 2005 21:10:19 +0000

To: joe@example.com

From: IronPort C60 Alert [alert@example.com]

Subject: Critical-example.com: (Anti-Virus) update via http://newproxy.example.com
failed

The Critical message is:

update via http://newproxy.example.com failed

Version: 4.5.0-419

Serial Number: XXXXXXXXXXXX-XXXXXXXX

Timestamp: Tue May 10 09:39:24 2005

For more information about this error, please see
http://support.ironport.com

If you desire further information, please contact your support provider.
```

## Adding Alert Recipients

The alerting engine allows for granular control over which alerts are sent to which alert recipients. For example, you can configure the system to send only specific alerts to an alert recipient, configuring an alert recipient to receive notifications only when Critical (severity) information about the System (alert type) is sent.



---

**Note** If you enabled AutoSupport during System Setup, the email address specified will receive alerts for all severities and classes by default. You can change this configuration at any time.

---



### Procedure

---

- Step 1** Select **System Administration > Alerts**.
  - Step 2** Click **Add Recipient**.
  - Step 3** Enter the recipient's email address. You can enter multiple addresses, separated by commas.
  - Step 4** (Optional) If you want to receive software release and critical support notification alerts from Cisco Support, check the **Release and Support Notifications** checkbox.
  - Step 5** Select the alert types and severities that this recipient will receive.
  - Step 6** Submit and commit your changes.
- 

## Configuring Alert Settings

The following settings apply to all alerts.



- 
- Note** Use the alertconfig CLI command to define the number of alerts to save on the email gateway to view later.
- 

### Procedure

---

- Step 1** Click **Edit Settings** on the Alerts page.
  - Step 2** Enter a Header From: address to use when sending alerts, or select Automatically Generated ("alert@<hostname>").
  - Step 3** Mark the checkbox if you want to specify the number of seconds to wait between sending duplicate alerts. For more information, see [Sending Duplicate Alerts, on page 1050](#).
    - Specify the initial number of seconds to wait before sending a duplicate alert.
    - Specify the maximum number of seconds to wait before sending a duplicate alert.
  - Step 4** You can enable AutoSupport by checking the IronPort AutoSupport option. For more information about AutoSupport, see [AutoSupport, on page 1047](#).
    - If AutoSupport is enabled, the weekly AutoSupport report is sent to alert recipients set to receive System alerts at the Information level. You can disable this via the checkbox.
  - Step 5** Submit and commit your changes.
- 

## Alert Settings

Alert settings control the general behavior and configuration of alerts, including:

- The RFC 2822 Header From: when sending alerts (enter an address or use the default "alert@<hostname>"). You can also set this via the CLI, using the alertconfig -> from command.

- The initial number of seconds to wait before sending a duplicate alert.
- The maximum number of seconds to wait before sending a duplicate alert.
- The status of AutoSupport (enabled or disabled).
- The sending of AutoSupport's weekly status reports to alert recipients set to receive System alerts at the Information level.

## Sending Duplicate Alerts

You can specify the initial number of seconds to wait before AsyncOS will send a duplicate alert. If you set this value to 0, duplicate alert summaries are not sent and instead, all duplicate alerts are sent without any delay (this can lead to a large amount of email over a short amount of time). The number of seconds to wait between sending duplicate alerts (alert interval) is increased after each alert is sent. The increase is the number of seconds to wait plus twice the last interval. So a 5 second wait would have alerts sent at 5 seconds, 15, seconds, 35 seconds, 75 seconds, 155 seconds, 315 seconds, etc.

Eventually, the interval could become quite large. You can set a cap on the number of seconds to wait between intervals via the maximum number of seconds to wait before sending a duplicate alert field. For example, if you set the initial value to 5 seconds, and the maximum value to 60 seconds, alerts would be sent at 5 seconds, 15 seconds, 35 seconds, 60 seconds, 120 seconds, etc.

## Viewing Recent Alerts

The email gateway saves the latest alerts so you can view them in both the GUI and the CLI in case you lose or delete the alert messages. These alerts cannot be downloaded from the email gateway.

To view a list of the latest alerts, click the **View Top Alerts** button on the Alerts page or use the `displayalerts` command in the CLI. You can arrange the alerts in the GUI by date, level, class, text, and recipient.

By default, the email gateway saves a maximum of 50 alerts to displays in the **Top Alerts** window. Use the `alertconfig -> setup` command in the CLI to edit the number of alerts that the email gateway saves. If you want to disable this feature, change the number of alerts to 0.

## Alert Descriptions

The following tables list alerts by classification, including the alert name (internal descriptor used by Cisco), actual text of the alert, description, severity (critical, information, or warning) and the parameters (if any) included in the text of the message. The value of the parameter is replaced in the actual text of the alert. For example, an alert message below may mention "\$ip" in the message text. "\$ip" is replaced by the actual IP address when the alert is generated.

- [Anti-Spam Alerts, on page 1051](#)
- [Anti-Virus Alerts, on page 1051](#)
- [Directory Harvest Attack Prevention \(DHAP\) Alerts, on page 1052](#)
- [Hardware Alerts, on page 1052](#)
- [Spam Quarantine Alerts, on page 1053](#)
- [Safelist/Blocklist Alerts, on page 1054](#)
- [System Alerts, on page 1055](#)
- [Updater Alerts, on page 1066](#)

- [Outbreak Filter Alerts, on page 1066](#)
- [Clustering Alerts, on page 1067](#)

## Anti-Spam Alerts

The following table contains a list of the various anti-spam alerts that can be generated by AsyncOS, including a description of the alert and the alert severity.

**Table 95: Listing of Possible Anti-Spam Alerts**

Alert Name	Message and Description	Parameters
AS.SERVER.ALERT	\$engine anti-spam - \$message \$tb	'engine' - The type of anti-spam engine.
	Critical. Sent when the anti-spam engine fails.	'message' - The log message. 'tb' - Traceback of the event.
AS.TOOL.INFO_ALERT	Update - \$engine - \$message	'engine' - The anti-spam engine name
	Information. Sent when there is a problem with the anti-spam engine.	'message' - The message
AS.TOOL.ALERT	Update - \$engine - \$message	'engine' - The anti-spam engine name
	Critical. Sent when an update is aborted due to a problem with one of the tools used to manage the anti-spam engine.	'message' - The message

## Anti-Virus Alerts

The following table contains a list of the various Anti-Virus alerts that can be generated by AsyncOS, including a description of the alert and the alert severity.

**Table 96: Listing of Possible Anti-Virus Alerts**

Alert Name	Message and Description	Parameters
AV.SERVER.ALERT /AV.SERVER.CRITICAL	\$engine antivirus - \$message \$tb	'engine' - The type of anti-virus engine.
	Critical. Sent when there is a critical problem with the anti-virus scanning engine.	'message' - The log message. 'tb' - Traceback of the event.
AV.SERVER.ALERT.INFO	\$engine antivirus - \$message \$tb	'engine' - The type of anti-virus engine.
	Information. Sent when an informational event occurs with the anti-virus scanning engine.	'message' - The log message. 'tb' - Traceback of the event.
AV.SERVER.ALERT.WARN	\$engine antivirus - \$message \$tb	'engine' - The type of anti-virus engine.
	Warning. Sent when there is a problem with the anti-virus scanning engine.	'message' - The log message. 'tb' - Traceback of the event.

Alert Name	Message and Description	Parameters
MAIL.ANTIVIRUS.ERROR_MESSAGE	MID \$mid antivirus \$what error \$tag	'mid' - MID
	Critical. Sent when anti-virus scanning produces an error while scanning a message.	'what' - The error that happened. 'tag' - Virus outbreak name if set.
MAIL.SCANNER.PROTOCOL_MAX_RETRY	MID \$mid is malformed and cannot be scanned by \$engine.	'mid' - MID
	Critical. The scanning engine attempted to scan the message unsuccessfully because the message is malformed. The maximum number of retries has been exceeded, and the message will be processed without being scanned by this engine.	'engine' - The engine being used

## Directory Harvest Attack Prevention (DHAP) Alerts

The following table contains a list of the various DHAP alerts that can be generated by AsyncOS, including a description of the alert and the alert severity.

*Table 97: Listing of Possible Directory Harvest Attack Prevention Alerts*

Alert Name	Message and Description	Parameters
LDAP.DHAP_ALERT	LDAP: Potential Directory Harvest Attack detected. See the system mail logs for more information about this attack.	
	Warning. Sent when a possible directory harvest attack is detected.	

## Hardware Alerts

The following table contains a list of the various Hardware alerts that can be generated by AsyncOS, including a description of the alert and the alert severity.

*Table 98: Listing of Possible Hardware Alerts*

Alert Name	Message and Description	Parameters
INTERFACE.ERRORS	Port \$port: has detected \$in_err input errors, \$out_err output errors, \$col collisions please check your media settings.	'port' - Interface name. 'in_err' - The number of input errors since the last message.
	Warning. Sent when interface errors are detected.	'out_err' - The number of output errors since the last message. 'col' - The number of packet collisions since the last message.

Alert Name	Message and Description	Parameters
MAIL.MEASUREMENTS_FILESYSTEM	The \$file_system partition is at \$capacity% capacity	'file_system' - The name of the filesystem 'capacity' - How full the filesystem is in percent.
	Warning. Sent when a disk partition is nearing capacity (75%).	
MAIL.MEASUREMENTS_FILESYSTEM.CRITICAL	The \$file_system partition is at \$capacity% capacity	'file_system' - The name of the filesystem 'capacity' - How full the filesystem is in percent.
	Critical. Sent when a disk partition reaches 90% capacity (and at 95%, 96%, 97%, etc.).	
SYSTEM.RAID_EVENT_ALERT	A RAID-event has occurred: \$error	'error' - The text of the RAID error.
	Warning. Sent when a critical RAID-event occurs.	
SYSTEM.RAID_EVENT_ALERT_INFO	A RAID-event has occurred: \$error	'error' - The text of the RAID error.
	Information. Sent when a RAID-event occurs.	

## Spam Quarantine Alerts

The following table contains a list of the various spam quarantine alerts that can be generated by AsyncOS, including a description of the alert and the alert severity.

*Table 99: Listing of Possible Spam Quarantine Alerts*

Alert Name	Message and Description	Parameters
ISQ.CANNOT_CONNECT_OFF_BOX	ISQ: Could not connect to off-box quarantine at \$host:\$port	'host' - address of off-box quarantine 'port' - port to connect to on off-box quarantine
	Information. Sent when AsyncOS was unable to connect to the (off-box) IP address.	
ISQ.CRITICAL	ISQ: \$msg	'msg' - message to be displayed
	Critical. Sent when a critical spam quarantine error is encountered.	
ISQ.DB_APPROACHING_FULL	ISQ: Database over \$threshold% full	'threshold' - the percent full threshold at which alerting begins
	Warning. Sent when the spam quarantine database is nearly full.	
ISQ.DB_FULL	ISQ: database is full	
	Critical. Sent when the spam quarantine database is full.	

Alert Name	Message and Description	Parameters
ISQ.MSG_DEL_FAILED	ISQ: Failed to delete MID \$mid for \$rcpt: \$reason	'mid' - MID
	Warning. Sent when an email is not successfully deleted from the spam quarantine.	'rcpt' - Recipient or "all" 'reason' - Why the message was not deleted
ISQ.MSG_NOTIFICATION_FAILED	ISQ: Failed to send notification message: \$reason	'reason' - Why the notification was not sent
	Warning. Sent when a notification message is not successfully sent.	
ISQ.MSG_QUAR_FAILED	Warning. Sent when a message is not successfully quarantined.	
ISQ.MSG_RLS_FAILED	ISQ: Failed to release MID \$mid to \$rcpt: \$reason	'mid' - MID
	Warning. Sent when a message is not successfully released.	'rcpt' - Recipient or "all" 'reason' - Why the message was not released
ISQ.MSG_RLS_FAILED_UNK_RCPTS	ISQ: Failed to release MID \$mid: \$reason	'mid' - MID
	Warning. Sent when a message is not successfully released because the recipient is unknown.	'reason' - Why the message was not released
ISQ.NO_EU_PROPS	ISQ: Could not retrieve \$user's properties. Setting defaults	'user' - end user name
	Information. Sent when AsyncOS is unable to retrieve information about a user.	
ISQ.NO_OFF_BOX_HOST_SET	ISQ: Setting up off-box ISQ without setting host	
	Information. Sent when AsyncOS is configured to reference an external quarantine, but the external quarantine is not defined.	

## Safelist/Blocklist Alerts

The following table contains a list of the various Safelist/Blocklist alerts that can be generated by AsyncOS, including a description of the alert and the alert severity

*Table 100: Listing of Possible Safelist/Blocklist Alerts*

Alert Name	Message and Description	Parameters
SLBL.DB.RECOVERY_FAILED	SLBL: Failed to recover End-User Safelist/Blocklist database: '\$error'.	'error' - error reason
	Critical. Failed to recover the Safelist/Blocklist database.	

Alert Name	Message and Description	Parameters
SLBL.DB.SPACE_LIMIT	SLBL: End-User Safelist/Blocklist database exceeded allowed disk space: \$current of \$limit.	'current' - how much it has used, in MB
	Critical. The safelist/blocklist database exceeded the allowed disk space.	'limit' - the configured limit, in MB

## System Alerts

The following table contains a list of the various System alerts that can be generated by AsyncOS, including a description of the alert and the alert severity.

**Table 101: Listing of Possible System Alerts**

Component/Alert Name	Message and Description	Parameters
AMP.ENGINE.ALERT	See <a href="#">Ensuring That You Receive Alerts About Advanced Malware Protection Issues, on page 498</a>	-
AMP.ENGINE.ALERT.WARN	Alert text: Failed to register the file analysis group name with Cisco Threat Grid server. Contact Cisco TAC for assistance.  Alert level: WARNING.  Description: Alert is sent when the email gateway fails to register the Appliance Group Name using the Smart Account ID with the Cisco Thread Grid server.	Parameter: reason for the failure
AsyncOS API Alerts	See “Alerts” section in the <i>AsyncOS API for Cisco Secure Email Gateway - Getting Started Guide</i> .	-
Mailbox Auto Remediation Alerts	See “Alerts” section in <a href="#">Remediating Messages in Mailboxes, on page 573</a>	-
COMMON.APP_FAILURE	An application fault occurred: \$error	'error' - The text of the error, typically a traceback.
	Warning. Sent when there is an unknown application failure.	
COMMON.ENGINE_AUTO_UPDATE_ENABLED	<\$level>: <\$class>	'\$engine' - The name of the Service Engine. The values can be: <ul style="list-style-type: none"> <li>• Sophos</li> <li>• McAfee</li> <li>• Graymail</li> </ul>
	Information: Automatic updates have been enabled for the particular engine <\$engine>. You will now receive automatic engine updates for this engine.	

Component/Alert Name	Message and Description	Parameters
COMMON.ENGINE_AUTO_UPDATE_DISABLED	<\$level>: <\$class>	' <b>engine</b> ' - The name of the Service Engine. The values can be: <ul style="list-style-type: none"> <li>• Sophos</li> <li>• McAfee</li> <li>• Graymail</li> </ul>
	Information: Automatic updates have been disabled for the particular engine <\$engine>. You will not receive any automatic updates for this engine, unless you enable automatic updates in the global setting page of the particular engine.	
COMMON.KEY_EXPIRED_ALERT	Your "\$feature" key has expired. Please contact your authorized Cisco sales representative.	' <b>feature</b> ' - The name of the feature that is about to expire.
	Warning. Sent when a feature key has expired.	
COMMON.KEY_EXPIRING_ALERT	Your "\$feature" key will expire in under \$days day(s). Please contact your authorized Cisco sales representative.	' <b>feature</b> ' - The name of the feature that is about to expire. ' <b>days</b> ' - The number of days it will expire.
	Warning. Sent when a feature key is about to expire.	
COMMON.KEY_FINAL_EXPIRING_ALERT	This is a final notice. Your "\$feature" key will expire in under \$days day(s). Please contact your authorized Cisco sales representative.	' <b>feature</b> ' - The name of the feature that is about to expire. ' <b>days</b> ' - The number of days it will expire.
	Warning. Sent as a final notice that a feature key is about to expire.	
KEYS.GRACE_EXPIRING_ALERT	All security services licenses for this email gateway have expired. The email gateway will continue to deliver mail without security services for \$days days.	' <b>days</b> ' - The number of days remaining in the grace period at the time the alert was sent.  For more information about the grace period, see <a href="#">Virtual Email Gateway License Expiration</a> , on page 1020.
	To renew security services licenses, Please contact your authorized Cisco sales representative.  Critical. Sent periodically from the start of the grace period for virtual email gateway license expiration.	
KEYS.GRACE_FINAL_EXPIRING_ALERT	This is the final notice. All security services licenses for this email gateway have expired. The email gateway will continue to deliver mail without security services for 1 day.	For more information about the grace period, see <a href="#">Virtual Email Gateway License Expiration</a> , on page 1020.
	To renew security services licenses, Please contact your authorized Cisco sales representative.  Critical. Sent one day before the virtual email gateway license expires.	



Component/Alert Name	Message and Description	Parameters
KEYS.GRACE_EXPIRED_ALERT	<p>Your grace period has expired. All security service have expired, and your email gateway is non-functional. The email gateway will no longer deliver mail until a new license is applied.</p> <p>To renew security services licenses, Please contact your authorized Cisco sales representative.</p> <p>Critical. Sent when the grace period for virtual email gateway has expired.</p>	For more information about the grace period, see <a href="#">Virtual Email Gateway License Expiration</a> , on page 1020.
DNS.BOOTSTRAP_FAILED	<p>Failed to bootstrap the DNS resolver. Unable to contact root servers.</p> <p>Warning. Sent when the email gateway is unable to contact the root DNS servers.</p>	
COMMON.INVALID_FILTER	<p>Invalid \$class: \$error</p> <p>Warning. Sent when an invalid filter is encountered.</p>	<p>'<b>class</b>' - Either "Filter", "SimpleFilter", etc.</p> <p>'<b>error</b>' - Additional why-filter-is-invalid info.</p>
IPBLOCKD.HOST_ADDED_TO_ALLOWED_LIST IPBLOCKD.HOST_ADDED_TO_BLOCKED_LIST IPBLOCKD.HOST_REMOVED_FROM_BLOCKED_LIST	<p>The host at \$ip has been added to the blocked list because of an SSH DOS attack.</p> <p>The host at \$ip has been permanently added to the ssh allowed list.</p> <p>The host at \$ip has been removed from the blocked list.</p> <p>Warning.</p> <p>IP addresses that try to connect to the email gateway over SSH but do not provide valid credentials are added to the SSH blocked list if more than 10 failed attempts occur within two minutes.</p> <p>When a user logs in successfully from the same IP address, that IP address is added to the allowed list.</p> <p>Addresses on the allowed list. are allowed access even if they are also on the blocked list.</p> <p>Entries are automatically removed from the blocked list after about a day.</p>	' <b>ip</b> ' - IP address from which a login attempt occurred.
LDAP.GROUP_QUERY_FAILED_ALERT	<p>LDAP: Failed group query \$name, comparison in filter will evaluate as false</p> <p>Critical. Sent when an LDAP group query fails.</p>	' <b>name</b> ' - The name of the query.

Component/Alert Name	Message and Description	Parameters
LDAP.HARD_ERROR	LDAP: work queue processing error in \$name reason \$why	'name' - The name of the query. 'why' - Why the error happened.
	Critical. Sent when an LDAP query fails completely (after trying all servers).	
LOG.ERROR.*	Critical. Various logging errors.	
MAIL.FILTER.RULE_MATCH_ALERT	MID \$mid matched the \$rule_name rule. \n Details: \$details	'mid' - Unique identification number of the message. 'rule_name' - The name of the rule that matched. 'details' - More information about the message or the rule.
	Information. Sent every time when a Header Repeats rule evaluates to true .	
MAIL.PERRCPT.LDAP_GROUP_QUERY_FAILED	LDAP group query failure during per-recipient scanning, possible LDAP misconfiguration or unreachable server.	
	Critical. Sent when an LDAP group query fails during per-recipient scanning.	
MAIL.QUEUE.ERROR.*	Critical. Various mail queue hard errors.	
MAIL.OMH.DELIVERY_RETRY	Subject - 'Alert: Message Delivery failed for \$hostname. DANE verification failed for one or more Domain(s).'  Message - The message delivery failed due to DANE verification failure for all mail exchange (MX) hosts in \$hostname. The email gateway will attempt message delivery again or bounce the message.	'host' - The host for which the DANE verification has failed.
MAIL.RES_CON_START_ALERT.MEMORY	This system (hostname: \$hostname) has entered a 'resource conservation' mode in order to prevent the rapid depletion of critical system resources. RAM utilization for this system has exceeded the resource conservation threshold of \$memory_threshold_start%. The allowed receiving rate for this system will be gradually decreased as RAM utilization approaches \$memory_threshold_halt%.	'hostname' - The name of the host. 'memory_threshold_start' - The percent threshold where memory tarpitting starts. 'memory_threshold_halt' - The percent threshold where the system will halt due to memory being too full.
	Critical. Sent when RAM utilization has exceeded the system resource conservation threshold.	

Component/Alert Name	Message and Description	Parameters
MAIL.RES_CON_START_ALERT.QUEUE_SLOW	This system (hostname: \$hostname) has entered a 'resource conservation' mode in order to prevent the rapid depletion of critical system resources. The queue is overloaded and is unable to maintain the current throughput.	'hostname' - The name of the host.
	Critical. Sent when the mail queue is overloaded and system resource conservation is enabled.	
MAIL.RES_CON_START_ALERT.QUEUE	This system (hostname: \$hostname) has entered a 'resource conservation' mode in order to prevent the rapid depletion of critical system resources. Queue utilization for this system has exceeded the resource conservation threshold of \$queue_threshold_start%. The allowed receiving rate for this system will be gradually decreased as queue utilization approaches \$queue_threshold_halt%.	'hostname' - The name of the host. 'queue_threshold_start' - The percent threshold where queue tarpitting starts. 'queue_threshold_halt' - The percent threshold where the system will halt due to the queue being too full.
	Critical. Sent when queue utilization has exceeded the system resource conservation threshold.	
MAIL.RES_CON_START_ALERT.WORKQ	This system (hostname: \$hostname) has entered a 'resource conservation' mode in order to prevent the rapid depletion of critical system resources. Listeners have been suspended because the current work queue size has exceeded the threshold of \$suspend_threshold. Listeners will be resumed once the work queue size has dropped to \$resume_threshold. These thresholds may be altered via use of the 'tarpit' command on the system CLI.	'hostname' - The name of the host. 'suspend_threshold' - Work queue size above which listeners are suspended. 'resume_threshold' - Work queue size below which listeners are resumed.
	Information. Sent when listeners are suspended because the work queue size is too big.	
MAIL.RES_CON_START_ALERT	This system (hostname: \$hostname) has entered a 'resource conservation' mode in order to prevent the rapid depletion of critical system resources.	'hostname' - The name of the host.
	Critical. Sent when the email gateway enters "resource conservation" mode.	
MAIL.RES_CON_STOP_ALERT	This system (hostname: \$hostname) has exited 'resource conservation' mode as resource utilization has dropped below the conservation threshold.	'hostname' - The name of the host.
	Information. Sent when the email gateway leaves 'resource conservation' mode.	

Component/Alert Name	Message and Description	Parameters
MAIL.URL_REP_CLIENT.CATEGORY_CHANGE	See <a href="#">Future URL Category Set Changes</a> , on page 475.	—
MAIL.BEAKER_CONNECTOR.CERTIFICATE_INVALID	See <a href="#">Troubleshooting URL Filtering</a> , on page 458.	
MAIL.BEAKER_CONNECTOR.ERROR_FETCHING_CERTIFICATE		
MAIL.WORK_QUEUE_PAUSED_NATURAL	work queue paused, \$num msgs, \$reason Critical. Sent when the work queue is paused.	'num' - The number of messages in the work queue. 'reason' - The reason the work queue is paused.
MAIL.WORK_QUEUE_UNPAUSED_NATURAL	work queue resumed, \$num msgs Critical. Sent when the work queue is resumed.	'num' - The number of messages in the work queue.
NTP.NOT_ROOT	Not running as root, unable to adjust system time Warning. Sent when the email gateway is unable to adjust time because NTP is not running as root.	
QUARANTINE.ADD_DB_ERROR	Unable to quarantine MID \$mid - quarantine system unavailable Critical. Sent when a message cannot be sent to a quarantine.	'mid' - MID
QUARANTINE.DB_UPDATE_FAILED	Unable to update quarantine database (current version: \$version; target \$target_version) Critical. Sent when a quarantine database cannot be updated.	'version' - The schema version detected. 'target_version' - The target schema version.
QUARANTINE.DISK_SPACE_LOW	The quarantine system is unavailable due to a lack of space on the \$file_system partition. Critical. Sent when the disk space for quarantines is full.	'file_system' - The name of the filesystem.
QUARANTINE.THRESHOLD_ALERT	Quarantine "\$quarantine" is \$full% full Warning. Sent when a quarantine reaches 5%, 50%, or 75% of capacity.	'quarantine' - The name of the quarantine. 'full' - The percentage of how full the quarantine is.
QUARANTINE.THRESHOLD_ALERT.SERIOUS	Quarantine "\$quarantine" is \$full% full Critical. Sent when a quarantine reaches 95% of capacity.	'quarantine' - The name of the quarantine. 'full' - The percentage of how full the quarantine is.

Component/Alert Name	Message and Description	Parameters
REPORTD.DATABASE_OPEN_FAILED_ALERT	The reporting system has encountered a critical error while opening the database. In order to prevent disruption of other services, reporting has been disabled on this machine. Please contact customer support to have reporting enabled. The error message is: \$err_msg	'err_msg' - The error message raised
	Critical. Sent if the reporting engine is unable to open the database.	
REPORTD.AGGREGATION_DISABLED_ALERT	Processing of collected reporting data has been disabled due to lack of logging disk space. Disk usage is above \$threshold percent. Recording of reporting events will soon become limited and reporting data may be lost if disk space is not freed up (by removing old logs, etc.). Once disk usage drops below \$threshold percent, full processing of reporting data will be restarted automatically.	'threshold' - The threshold value
	Warning. Sent if the system runs out of disk space. When the disk usage for a log entry exceeds the log usage threshold, reportd disables aggregation and sends the alert.	
REPORTING.CLIENT.UPDATE_FAILED_ALERT	Reporting Client: The reporting system has not responded for an extended period of time (\$duration).	'duration' - Length of time the client has been trying to contact the reporting daemon. This is a string in a human readable format ('1h 3m 27s').
	Warning. Sent if the reporting engine was unable to save reporting data.	
REPORTING.CLIENT.JOURNAL_FULL	Reporting Client: The reporting system is unable to maintain the rate of data being generated. Any new data generated will be lost.	
	Critical. Sent if the reporting engine is unable to store new data.	
REPORTING.CLIENT.JOURNAL_FREE	Reporting Client: The reporting system is now able to handle new data.	
	Information. Sent when the reporting engine is again able to store new data.	
PERIODIC_REPORTS.REPORT_TASK.BUILD_FAILURE	A failure occurred while building periodic report '\$report_title'. This subscription has been removed from the scheduler.	'report_title' - the report title
	Critical. Sent when the reporting engine is unable to build a report.	

Component/Alert Name	Message and Description	Parameters
PERIODIC_REPORTS.REPORT_TASK.EMAIL_FAILURE	A failure occurred while emailing periodic report '\$report_title'. This subscription has been removed from the scheduler.	'report_title' - the report title
	Critical. Sent when a report could not be emailed.	
PERIODIC_REPORTS.REPORT_TASK.ARCHIVE_FAILURE	A failure occurred while archiving periodic report '\$report_title'. This subscription has been removed from the scheduler.	'report_title' - the report title
	Critical. Sent when a report could not be archived.	
SENDERBASE.ERROR	Error processing response to query \$query: response was \$response	'query' - The query address. 'response' - Raw data of response received.
	Information. Sent when an error occurred while processing a response from SenderBase.	
SMTPAUTH.FWD_SERVER_FAILED_ALERT	SMTP Auth: could not reach forwarding server \$ip with reason: \$why	'ip' - The IP of the remote server. 'why' - Why the error happened.
	Warning. Sent when the SMTP Authentication forwarding server is unreachable.	
SMTPAUTH.LDAP_QUERY_FAILED	SMTP Auth: LDAP query failed, see LDAP debug logs for details.	
	Warning. Sent when an LDAP query fails.	
SYSTEM.HERMES_SHUTDOWN_FAILURE. REBOOT	While preparing to \${what}, failed to stop mail server gracefully: \${error}\${what}:=reboot	'error' - The error that happened.
	Warning. Sent when there was a problem shutting down the system on reboot.	
SYSTEM.HERMES_SHUTDOWN_FAILURE. SHUTDOWN	While preparing to \${what}, failed to stop mail server gracefully: \${error}\${what}:=shut down	'error' - The error that happened.
	Warning. Sent when there was a problem shutting down the system.	
SYSTEMLOGIN_FAILURES_LOCK_ALERT	User "\$user" is locked after \$numlogins consecutive login failures. Last login attempt was from \$rhost  Information: Sent when the user account is locked because of maximum number of failed login attempts	'user' - The name of the user 'numlogins' - The configured alert threshold 'rhost' - The address of the remote host
SYSTEMRCPTVALIDATION.UPDATE_FAILED	Error updating recipient validation data: \$why	'why' - The error message.
	Critical. Sent when a recipient validation update failed.	

Component/Alert Name	Message and Description	Parameters
SYSTEM.SERVICE_TUNNEL.DISABLED	Tech support: Service tunnel has been disabled	
	Information. Sent when a tunnel created for Cisco Support Services is disabled.	
SYSTEM.SERVICE_TUNNEL.ENABLED	Tech support: Service tunnel has been enabled, port \$port	'port' - The port used for the service tunnel.
	Information. Sent when a tunnel created for Cisco Support Services is enabled.	
IPBLOCKD.HOST_ADDED_TO_ALLOWED_LIST	The host at \$ip has been added to the blocked list because of an SSH DOS attack.	'ip' - IP address from which a login attempt occurred.
IPBLOCKD.HOST_ADDED_TO_BLOCKED_LIST	The host at \$ip has been permanently added to the ssh allowed list.	
IPBLOCKD.HOST_REMOVED_FROM_BLOCKED_LIST	The host at \$ip has been removed from the blocked list.	
	<p>Warning.</p> <p>IP addresses that try to connect to the email gateway over SSH but do not provide valid credentials are added to the SSH blocked list if more than 10 failed attempts occur within two minutes.</p> <p>When a user logs in successfully from the same IP address, that IP address is added to the allowed list.</p> <p>Addresses on the allowed list are allowed access even if they are also on the blocked list .</p> <p>Entries are automatically removed from the blocked list after about a day.</p>	

Component/Alert Name	Message and Description	Parameters
WATCHDOG_RESTART_ALERT_MSG	<p>&lt;\$level&gt;: &lt;\$class&gt;, &lt;\$hostname&gt;: \$subject \$text</p> <p>Warning.</p> <p>The email gateway uses the watchdog service to monitor the health condition of the following engines:</p> <ul style="list-style-type: none"> <li>• Anti-Spam</li> <li>• Anti-Virus</li> <li>• Anti Malware Protection</li> <li>• Graymail</li> </ul> <p>If any of the above engines does not respond to the watchdog service for a certain duration, the watchdog service restarts the engine(s) and sends an alert to the administrator.</p>	<p>'<b>subject</b>' - Watchdog alert subject specific to the engine</p> <p>'<b>text</b>' - Watchdog alert text specific to the engine</p>
MAIL.IMH.GEODB_UPDATE_COUNTRIES'	<p>Warning. Geolocation Update - the list of supported countries has changed.</p> <p>Added Countries - &lt;\$added&gt;</p> <p>Deleted Countries - &lt;\$deleted&gt;</p> <p>Review your HAT sender groups, Message Filters, and Content Filters settings accordingly.</p>	<p>'added' - The following countries are added: &lt;iso_code1&gt;:&lt;country_name1&gt;,&lt;iso_code2&gt;:&lt;country_name2&gt;,</p> <p>'deleted' - The following countries are deleted: &lt;iso_code1&gt;:&lt;country_name1&gt;:&lt;iso_code2&gt;:&lt;country_name2&gt;,</p>
MAILUPDAIED_SHORT_URL_DOMAIN_LIST	<p>Info. The list of shortened URL domains has been updated..</p> <p>Added Domains: &lt;\$added_domains&gt;</p> <p>Deleted Domains - &lt;\$deleted_domains&gt;</p>	<p>'added_domains': The following domains are added: &lt;domains_1&gt;, &lt;domain_2&gt;</p> <p>'deleted_domains': The following domains are deleted: &lt;domain_3&gt;, &lt;domain_4&gt;</p>
MAIL.DOMAINS_NOT_REACHABLE	<p>Warning. The following domains are not reachable by the email gateway for shortened URL support: &lt;\$domains&gt;</p> <p>Check your firewall rules to allow your email gateway to connect to these domains.</p>	<p>&lt;\$domains&gt;: comma separated list of domains</p>
MAILUPGRADE_CONFIG_CHANGEALERT	<p>Info. Sent when the user configured value is changed by the system during the upgrade.</p>	<p>'<b>text</b>' - The Intelligent Multi-Scan and the Graymail global configuration settings have been modified during the upgrade. Please review the global settings for the Intelligent Multi-Scan and the Graymail configurations.</p>
CERTIFICATE.CERT_EXPIRING_ALERT	<p>Your certificate "\$certificate" will expire in \$days day(s).</p> <p>Alert level : WARNING</p>	<p>'<b>certificate</b>', 'The name of the certificate that is about to expire.</p> <p>'<b>days</b>', 'The number of days it will expire.'</p>



Component/Alert Name	Message and Description	Parameters
CERTIFICATE.CERT_CRITICAL_EXPIRING_ALERT	Your certificate "\$certificate" will expire in \$days hour(s).  Alert level : CRITICAL A 'CRITICAL' certificate validity period is less than 5 days.	'certificate', 'The name of the certificate that is about to expire.'  'days', 'The number of days with remaining time (HH:MM:SS), for example, 4 days 10:12:20 hour(s).'
CERTIFICATE.CERT_EXPIRED_ALERT	Your certificate "\$certificate" has expired.  Alert level : CRITICAL	'certificate', 'The name of the certificate that has expired.'
MAIL.APP.NO_ACCESS_KEY	Alert text: 'Failed to poll for the Cisco Advanced Phishing Protection Cloud Service expiry date, add API AccessUID and API Access secret key.'  Description: Alert is sent when a query for the APP expiry date failed because the API Access key and the secret key was not entered.	N/A
MAIL.APP.INVALID_KEY	Alert text: Failed to poll for the Cisco Advanced Phishing Protection Cloud Service expiry date because the API Access Key is invalid. You need to re-configure the API Access UID and secret key.  Description: Alert is sent when a query for the APP expiry date failed because the API Access key and the secret key was not entered.	N/A
MAIL.APP.EXPIRED	Alert text: The Cisco Advanced Phishing Protection Cloud Service has expired and is disabled. Contact your Cisco Account Manager to renew the service and enable it.  Description: The Cisco Advanced Phishing Protection Cloud Service has expired and is disabled. You need to renew the APP license and enable the APP service.	N/A
MAIL.APP.EXPIRY_REMINDER	Alert text: Cisco Advanced Phishing Protection Cloud Service expires on \$eas_expiry_date. You need to contact your Cisco Account Manager to renew the service.  Description: Alert is sent each day, starting from three days before the expiry period.	Parameters: eas_expiry_date eas_expiry_date - date on which Cisco Advanced Phishing Protection Cloud Service will expire
MAIL.APP.SERVICE_UNAVAILABLE	Alert text: Cisco Advanced Phishing Protection Cloud Service update. Unable to establish communication with the cloud service.  Description: 'APP cloud service is unavailable because ten consecutive mails failed to forward to APP.	N/A

Component/Alert Name	Message and Description	Parameters
MAIL.APP.SERVICE_AVAILABLE	Alert text: Cisco Advanced Phishing Protection Cloud Service update. Communication with the cloud service has been established.  Description: APP cloud service is available.	N/A

## Updater Alerts

The following table contains a list of the various Updater alerts that can be generated by AsyncOS.

**Table 102: Listing of Possible Updater Alerts**

Alert Name	Message and Description	Parameters
UPDATER.APP.UPDATE_ABANDONED	\$app abandoning updates until a new version is published. The \$app application tried and failed \$attempts times to successfully complete an update. This may be due to a network configuration issue or temporary outage	'app' - The application name. 'attempts' - The number of attempts tried.
	Warning. The application is abandoning the update.	
UPDATER.UPDATERD.ANIFEST_FAILED_ALERT	The updater has been unable to communicate with the update server for at least \$threshold.	'threshold' - Human readable threshold string.
	Warning. Failed to acquire a server manifest.	
UPDATER.UPDATERD.RELEASE_NOTIFICATION	\$mail_text	'mail_text' - The notification text. 'notification_subject' - The notification text.
	Warning. Release notification.	
UPDATER.UPDATERD.UPDATE_FAILED	Unknown error occurred: \$traceback	'traceback' - The traceback.
	Critical. Failed to run an update.	

## Outbreak Filter Alerts

The following table contains a list of the various Outbreak Filter alerts that can be generated by AsyncOS, including a description of the alert and the alert severity. Please note that Outbreak Filters can also be referenced in system alerts for quarantines (the Outbreak quarantine, specifically).

**Table 103: Listing of Possible Outbreak Filter Alerts**

Alert Name	Message and Description	Parameters
VOF.GTL_THRESHOLD_ALERT	Outbreak Filters Rule Update Alert:\$text All rules last updated at: \$time on \$date.	'text' - Update alert text. 'time' - Time of last update. 'date' - Date of last update.
	Information. Sent when the Outbreak Filters threshold has changed.	

Alert Name	Message and Description	Parameters
AS.UPDATE_FAILURE	Engine update unsuccessful. This may be due to transient network or DNS issues, HTTP proxy configuration causing update transmission errors or unavailability of downloads.ironport.com. The specific error on the email gateway for this failure is: \$error	'engine' - The engine that failed to update. 'error' - The error that happened.
	Warning. Sent when the anti-spam engine or CASE rules fail to update.	

## Clustering Alerts

The following table contains a list of the various clustering alerts that can be generated by AsyncOS, including a description of the alert and the alert severity.

*Table 104: Listing of Possible Clustering Alerts*

Alert Name	Message and Description	Parameters
CLUSTER.CC_ERROR.AUTH_ERROR	Error connecting to cluster machine \$name at IP \$ip - \$error - \$why\$error:=Machine does not appear to be in the cluster	'name' - The hostname and/or serial number of the machine. 'ip' - The IP of the remote host.
	Critical. Sent when there was an authentication error. This can occur if a machine is not a member of the cluster.	'why' - Detailed text about the error.
CLUSTER.CC_ERROR.DROPPED	Error connecting to cluster machine \$name at IP \$ip - \$error - \$why\$error:=Existing connection dropped	'name' - The hostname and/or serial number of the machine. 'ip' - The IP of the remote host.
	Warning. Sent when the connection to the cluster was dropped.	'why' - Detailed text about the error.
CLUSTER.CC_ERROR.FAILED	Error connecting to cluster machine \$name at IP \$ip - \$error - \$why\$error:=Connection failure	'name' - The hostname and/or serial number of the machine. 'ip' - The IP of the remote host.
	Warning. Sent when the connection to the cluster failed.	'why' - Detailed text about the error.
CLUSTER.CC_ERROR.FORWARD_FAILED	Error connecting to cluster machine \$name at IP \$ip - \$error - \$why\$error:=Message forward failed, no upstream connection	'name' - The hostname and/or serial number of the machine. 'ip' - The IP of the remote host.
	Critical. Sent when the email gateway was unable to forward data to a machine in the cluster.	'why' - Detailed text about the error.
CLUSTER.CC_ERROR.NOROUTE	Error connecting to cluster machine \$name at IP \$ip - \$error - \$why\$error:=No route found	'name' - The hostname and/or serial number of the machine. 'ip' - The IP of the remote host.
	Critical. Sent when the machine was unable to obtain a route to another machine in the cluster.	'why' - Detailed text about the error.

Alert Name	Message and Description	Parameters
CLUSTER.CC_ERROR.SSH_KEY	Error connecting to cluster machine \$name at IP \$ip - \$error - \$why\$error:=Invalid host key	'name' - The hostname and/or serial number of the machine.
	Critical. Sent when there was an invalid SSH host key.	'ip' - The IP of the remote host. 'why' - Detailed text about the error.
CLUSTER.CC_ERROR.TIMEOUT	Error connecting to cluster machine \$name at IP \$ip - \$error - \$why\$error:=Operation timed out	'name' - The hostname and/or serial number of the machine.
	Warning. Sent when the specified operation timed out.	'ip' - The IP of the remote host. 'why' - Detailed text about the error.
CLUSTER.CC_ERROR_NOIP	Error connecting to cluster machine \$name - \$error - \$why	'name' - The hostname and/or serial number of the machine.
	Critical. Sent when the email gateway could not obtain a valid IP address for another machine in the cluster.	'why' - Detailed text about the error.
CLUSTER.CC_ERROR_NOIP.AUTH_ERROR	Error connecting to cluster machine \$name - \$error - \$why\$error:=Machine does not appear to be in the cluster	'name' - The hostname and/or serial number of the machine.
	Critical. Sent when there was an authentication error connecting to a machine in a cluster. This can occur if a machine is not a member of the cluster.	'why' - Detailed text about the error.
CLUSTER.CC_ERROR_NOIP.DROPPED	Error connecting to cluster machine \$name - \$error - \$why\$error:=Existing connection dropped	'name' - The hostname and/or serial number of the machine.
	Warning. Sent when the machine was unable to obtain a valid IP address for another machine in the cluster and the connection to the cluster was dropped.	'why' - Detailed text about the error.
CLUSTER.CC_ERROR_NOIP.FAILED	Error connecting to cluster machine \$name - \$error - \$why\$error:=Connection failure	'name' - The hostname and/or serial number of the machine.
	Warning. Sent when there was an unknown connection failure and the machine was unable to obtain a valid IP address for another machine in the cluster.	'why' - Detailed text about the error.

Alert Name	Message and Description	Parameters
CLUSTER.CC_ERROR_NOIP.FORWARD_FAILED	Error connecting to cluster machine \$name - \$error - \$why\$error:=Message forward failed, no upstream connection	'name' - The hostname and/or serial number of the machine.  'why' - Detailed text about the error.
	Critical. Sent when the machine was unable to obtain a valid IP address for another machine in the cluster and the email gateway was unable to forward data to the machine.	
CLUSTER.CC_ERROR_NOIP.NOROUTE	Error connecting to cluster machine \$name - \$error - \$why\$error:=No route found	'name' - The hostname and/or serial number of the machine.  'why' - Detailed text about the error.
	Critical. Sent when the machine was unable to obtain a valid IP address for another machine in the cluster and it was unable to obtain a route to the machine.	
CLUSTER.CC_ERROR_NOIP.SSH_KEY	Error connecting to cluster machine \$name - \$error - \$why\$error:=Invalid host key	'name' - The hostname and/or serial number of the machine.  'why' - Detailed text about the error.
	Critical. Sent when the machine was unable to obtain a valid IP address for another machine in the cluster and was unable to obtain a valid SSH host key.	
CLUSTER.CC_ERROR_NOIP.TIMEOUT	Error connecting to cluster machine \$name - \$error - \$why\$error:=Operation timed out	'name' - The hostname and/or serial number of the machine.  'why' - Detailed text about the error.
	Warning. Sent when the machine was unable to obtain a valid IP address for another machine in the cluster and the specified operation timed out.	
CLUSTER.SYNC.PUSH_ALERT	Overwriting \$sections on machine \$name	'name' - The hostname and/or serial number of the machine.
	Critical. Sent when configuration data has gotten out of sync and has been sent to a remote host.	'sections' - List of cluster sections being sent.

## Changing Network Settings

This section describes the features used to configure the network operation of the email gateway. These features give you direct access to the hostname, DNS, and routing settings that you configured via the System Setup Wizard (or the **systemsetup** command) in [Using the System Setup Wizard](#), on page 26.

The following features are described:

- **sethostname**
- DNS Configuration (GUI and via the **dnsconfig** command)
- Routing Configuration (GUI and via the **routeconfig** and **setgateway** commands)
- **dnsflush**

- Passphrase
- Network Access
- Login Banner

## Changing the System Hostname

The hostname is used to identify the system. You must enter a fully-qualified hostname. To change the hostname:

- On the web interface, click Network > IP Interfaces, click the Management and in the Hostname, change the hostname.
- On the CLI, use the `set hostname` command.



---

**Note** The new hostname does not take effect until you commit changes.

---

## Configuring Domain Name System (DNS) Settings

You can configure the DNS settings for your email gateway through the DNS page on the Network menu of the GUI, or via the `dnsconfig` command.

You can configure the following settings:

- whether to use the Internet's DNS servers or your own, and which specific server(s) to use
- which interface to use for DNS traffic
- the number of seconds to wait before timing out a reverse DNS lookup
- clear DNS cache

### Specifying DNS Servers

AsyncOS can use the Internet root DNS servers, your own DNS servers, or the Internet root DNS servers and authoritative DNS servers you specify. When using the Internet root servers, you may specify alternate servers to use for specific domains. Since an alternate DNS server applies to a single domain, it must be authoritative (provide definitive DNS records) for that domain.

AsyncOS supports “splitting” DNS servers when not using the Internet's DNS servers. If you are using your own internal server, you can also specify exception domains and associated DNS servers.

When setting up “split DNS,” you should set up the `in-addr.arpa` (PTR) entries as well. So, for example, if you want to redirect “.eng” queries to the nameserver 1.2.3.4 and all the .eng entries are in the 172.16 network, then you should specify “eng,16.172.in-addr.arpa” as the domains in the split DNS configuration.

### Multiple Entries and Priority

For each DNS server you enter, you can specify a numeric priority. AsyncOS will attempt to use the DNS server with the priority closest to 0. If that DNS server is not responding AsyncOS will attempt to use the server at the next priority. If you specify multiple entries for DNS servers with the same priority, the system randomizes the list of DNS servers at that priority every time it performs a query. The system then waits a short amount of time for the first query to expire or “time out” and then a slightly longer amount of time for the second, etc. The amount of time depends on the exact total number of DNS servers and priorities that have been configured. The timeout length is the same for all IP addresses at any particular priority. The first priority

gets the shortest timeout, each subsequent priority gets a longer timeout. Further, the timeout period is roughly 60 seconds. If you have one priority, the timeout for each server at that priority will be 60 seconds. If you have two priorities, the timeout for each server at the first priority will be 15 seconds, and each server at the second priority will be 45 seconds. For three priorities, the timeouts are 5, 10, 45.

For example, suppose you configure four DNS servers, with two of them at priority 0, one at priority 1, and one at priority 2:

**Table 105: Example of DNS Servers, Priorities, and Timeout Intervals**

Priority	Server(s)	Timeout (seconds)
0	1.2.3.4, 1.2.3.5	5, 5
1	1.2.3.6	10
2	1.2.3.7	45

AsyncOS will randomly choose between the two servers at priority 0. If one of the priority 0 servers is down, the other will be used. If both of the priority 0 servers are down, the priority 1 server (1.2.3.6) is used, and then, finally, the priority 2 (1.2.3.7) server.

The timeout period is the same for both priority 0 servers, longer for the priority 1 server, and longer still for the priority 2 server.

## Using the Internet Root Servers

The AsyncOS DNS resolver is designed to accommodate the large number of simultaneous DNS connections required for high-performance email delivery.



**Note** If you choose to set the default DNS server to something other than the Internet root servers, that server must be able to recursively resolve queries for domains for which it is not an authoritative server.

## Reverse DNS Lookup Timeout

The email gateway attempts to perform a “double DNS lookup” on all remote hosts connecting to a listener for the purposes of sending or receiving email. [That is: the system acquires and verifies the validity of the remote host’s IP address by performing a double DNS lookup. This consists of a reverse DNS (PTR) lookup on the IP address of the connecting host, followed by a forward DNS (A) lookup on the results of the PTR lookup. The system then checks that the results of the A lookup match the results of the PTR lookup. If the results do not match, or if an A record does not exist, the system only uses the IP address to match entries in the Host Access Table (HAT).] This particular timeout period applies only to this lookup and is not related to the general DNS timeout discussed in [Multiple Entries and Priority, on page 1070](#).

The default value is 20 seconds for each DNS server. When there are multiple entries for DNS servers, the total timeout value is (number of DNS servers multiplied by the Reverse DNS Lookup Timeout value) seconds. For example, if there are 8 DNS servers and the Reverse DNS Lookup Timeout value is 20 seconds, the total timeout value is  $(8 * 20) = 160$  seconds.

You can disable the reverse DNS lookup timeout globally across all listeners by entering '0' as the number of seconds. If the value is set to 0 seconds, the reverse DNS lookup is not attempted, and instead the standard timeout response is returned immediately. This also prevents the email gateway from delivering mail to domains that require TLS-verified connections if the receiving host's certificate has a common name (CN) that maps to the host's IP lookup.

## DNS Alert

Occasionally, an alert may be generated with the message "Failed to bootstrap the DNS cache" when an email gateway is rebooted. The message means that the system was unable to contact its primary DNS servers, which can happen at boot time if the DNS subsystem comes online before network connectivity is established. If this message appears at other times, it could indicate network issues or that the DNS configuration is not pointing to a valid server.

## Clearing the DNS Cache

The Clear Cache button from the GUI, or the `dnsflush` command (for more information about the `dnsflush` command, see the CLI Reference Guide for AsyncOS for Cisco Secure Email Gateway), clears all information in the DNS cache. You may choose to use this feature when changes have been made to your local DNS system. The command takes place immediately and may cause a temporary performance degradation while the cache is repopulated.

## Configuring DNS Settings via the Graphical User Interface

### Procedure

- 
- Step 1** Select **Network > DNS**.
  - Step 2** Click **Edit Settings**.
  - Step 3** Select whether to use the Internet's root DNS servers or your own internal DNS server or the Internet's root DNS servers and specify alternate DNS servers.
  - Step 4** If you want to use your own DNS server(s) enter the server ID and click **Add Row**. Repeat this for each server. When entering your own DNS servers, specify a priority as well. For more information, see [Specifying DNS Servers, on page 1070](#).
  - Step 5** If you want to specify alternate DNS servers for certain domains, enter the domain and the alternate DNS server IP address. Click **Add Row** to add additional domains.
    - Note** You can enter multiple domains for a single DNS server by using commas to separate domain names. You can also enter multiple DNS servers by using commas to separate IP addresses.
  - Step 6** Choose an interface for DNS traffic.
  - Step 7** Enter the number of seconds to wait before cancelling a reverse DNS lookup.
  - Step 8** You can also clear the DNS cache by clicking **Clear Cache**.
  - Step 9** Submit and commit your changes.
- 

## Configuring TCP/IP Traffic Routes

Some network environments require the use of traffic routes other than the standard default gateway.



The email gateway can use both Internet Protocol version 4 (IPv4) and Internet Protocol version 6 (IPv6) static routes.

You can manage static routes via the CLI, using the `routeconfig` command, or use the following procedure.

#### Procedure

---

- Step 1** Select **Network > Routing**.
  - Step 2** Click **Add Route** for the type of static route you want to create (IPv4 or IPv6).
  - Step 3** Enter a name for the route.
  - Step 4** Enter the destination IP address.
  - Step 5** Enter the Gateway IP address.
  - Step 6** Submit and commit your changes.
- 

## Configuring the Default Gateway

You can configure the default gateway using the `setgateway` command in the CLI or use the following procedure.

#### Procedure

---

- Step 1** Select **Network > Routing**.
  - Step 2** Click **Default Route** in the route listing for the Internet Protocol version you want to modify.
  - Step 3** Change the Gateway IP address.
  - Step 4** Submit and commit your changes.
- 

## Configuring SSL Settings

You can configure the SSL settings for the email gateway using SSL Configuration Settings page or `sslconfig` command.

#### Procedure

---

- Step 1** Click **System Administration > SSL Configuration Settings**.
- Step 2** Click **Edit Settings**.

**Important** If you have upgraded from a lower AsyncOS version (for example, 12.0 or 12.1), the default SSL ciphers are changed in AsyncOS 14.x and later as follows:

- **For GUI HTTPS-**

```
AES128:AES256:!SRP:!AESGCM+DH+aRSA:!AESGCM+RSA:
!aNULL:!kRSA:@STRENGTH:-aNULL:-EXPORT:-IDEA:!DHE-RSA-AES256-SHA
```

- **For Inbound SMTP -**

```
AES128:AES256:!SRP:!AESGCM+DH+aRSA:!AESGCM+RSA:
!aNULL:!kRSA:@STRENGTH:-aNULL:-EXPORT:-IDEA:!DHE-RSA-AES256-SHA
```

- **For Outbound SMTP -**

```
ECDH+aRSA:ECDH+ECDSA:DHE+DSS+AES:AES128:AES256:!SRP:
!AESGCM+DH+aRSA:!AESGCM+RSA:!aNULL:!eNULL:!kRSA:@STRENGTH:-aNULL:-EXPORT
:-IDEA:!DHE-RSA-AES256-SHA
```

**Step 3** Depending on your requirements, do the following:

- Set GUI HTTPS SSL settings. Under GUI HTTPS, specify the SSL methods and ciphers that you want to use.
- Set Inbound SMTP SSL settings. Under Inbound SMTP, specify the SSL methods and ciphers that you want to use.
- Set Outbound SMTP SSL settings. Under Outbound SMTP, specify the SSL methods and ciphers that you want to use.
- Set other TLS Client Services. Under 'Other TLS Client Services,' the TLS v1.0 method is disabled by default if your email gateway is in the non-FIPS mode. You can enable the TLS v1.0 method on your email gateway for the following TLS client services - 'LDAP' and 'Updater.'

Keep in mind that,

- [In non-FIPS mode] You cannot enable TLS v1.0 and v1.1 methods simultaneously. However, you can enable these methods in conjunction with TLS v1.2 method.
- If you plan to upgrade from a lower AsyncOS version (for example, 12.x or 13.0) in non-FIPS mode with TLS v1.0 enabled, to AsyncOS 13.5.1 and later, then TLS v1.0 is disabled by default. You need to enable TLS v1.0 method on your email gateway after upgrade.
- From AsyncOS 13.5.1 and later, there is no support for SSLv2 and SSL v3 methods.
- There is no support for the TLS v1.0 method if your email gateway is in the FIPS mode.
- The TLS v1.0 method is disabled by default if your email gateway is in the non-FIPS mode.

**Step 4** [Optional] Check the **Enable** check box to allow the email gateway to perform a FQDN validation on the peer certificate for 'Alerts over TLS,' 'Outbound SMTP,' 'Updater,' and 'LDAP' server services.

**Step 5** [Optional] Check the **Enable** check box to allow the email gateway to perform a X.509 validation on the peer certificate for 'Alerts over TLS,' 'Outbound SMTP,' 'Updater,' and 'LDAP' server services.

**Step 6** Click **Submit**.

**Step 7** Click **Commit Changes**.

# Single Sign-On (SSO) Using SAML 2.0

- [About Single Sign-On \(SSO\) and SAML 2.0, on page 1075](#)
- [SAML 2.0 SSO Workflow, on page 1075](#)
- [Guidelines and Limitations for SAML 2.0, on page 1076](#)
- [How to Configure SSO on your Email Gateway, on page 1077](#)

## About Single Sign-On (SSO) and SAML 2.0

The email gateway now supports SAML 2.0 SSO so that the administrative users can log in to the web interface of the email gateway using the same credentials that are used to access other SAML 2.0 SSO enabled services within their organization. For instance, if you enable Duo, Microsoft AD FS or Azure as your SAML Identity Provider (IdP), then you can configure your email gateway as a Service Provider (SP) to support SAML 2.0 SSO. Users can sign in once and have access to all SAML 2.0 SSO enabled services.

## SAML 2.0 SSO Workflow

The SAML 2.0 SSO workflow is displayed in the following figure:

Figure 75: SAML Workflow

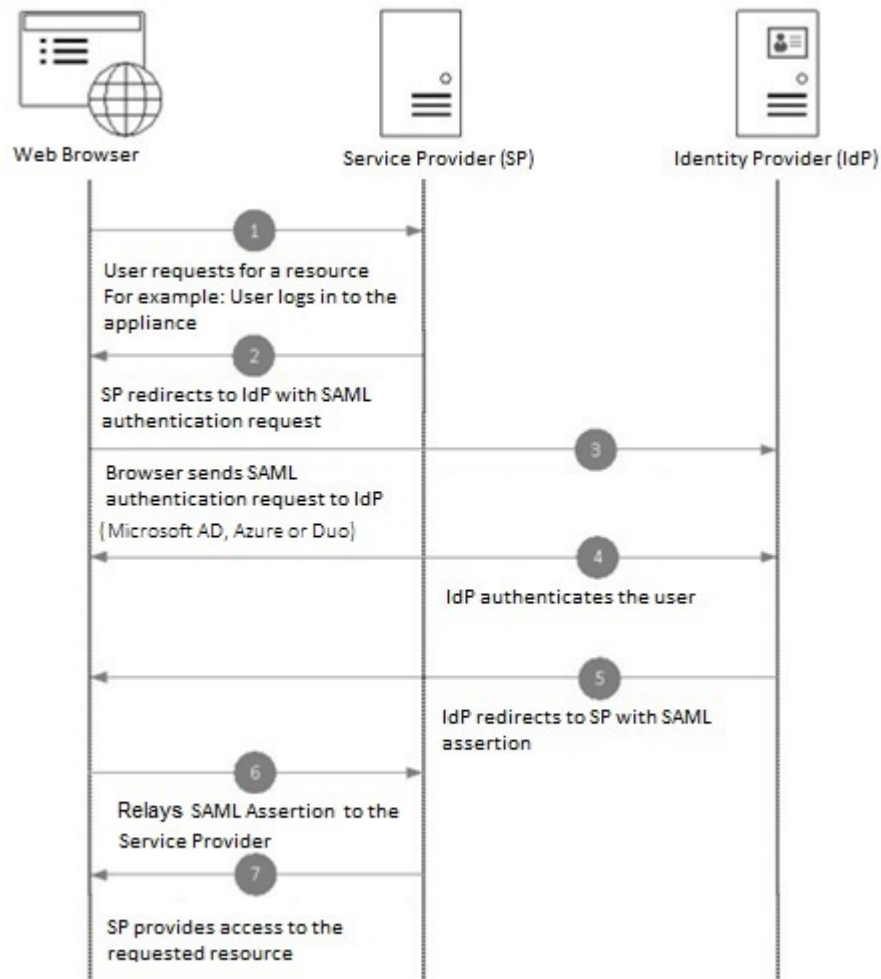

## Guidelines and Limitations for SAML 2.0

- [General](#), on page 1076
- [Logout](#), on page 1077
- [Limitations](#), on page 1077

### General

You can use Single Sign-On using SAML only on the graphical user interface (GUI). You can use the GUI and the command line interface (CLI) to configure SAML profiles.

You can configure only one instance of service provider and identity provider on the email gateway.

## Logout

When a user logs out of the email gateway, they are not logged out of other SAML 2.0 SSO enabled applications.

## Limitations

You cannot configure SAML profiles at cluster level. All SAML configurations are restricted to machine level.

## How to Configure SSO on your Email Gateway

### Procedure

	Command or Action	Purpose
<b>Step 1</b>	Review the prerequisites.	<a href="#">Prerequisites, on page 1077</a>
<b>Step 2</b>	Configure your email gateway as a service provider.	<a href="#">Configuring Email Gateway as a Service Provider, on page 1078</a>
<b>Step 3</b>	[On IDP] Configure the identity provider to work with your email gateway.	<a href="#">Configuring the Identity Provider to Communicate with Email Gateway, on page 1081</a>
<b>Step 4</b>	Configure identity provider settings on your email gateway.	<a href="#">Configure Identity Provider Settings on Email Gateway, on page 1083</a>
<b>Step 5</b>	Enable External Authentication using SAML on your email gateway.	<a href="#">Enable SAML Authentication, on page 991</a>

## Prerequisites

- [Supported Identity Providers, on page 1077](#)
- [Certificates for Secure Communication, on page 1078](#)

## Supported Identity Providers

Verify whether the identity provider used by your organization is supported by the email gateway. The following are the pre-qualified identity providers:

- Microsoft Active Directory Federation Services (AD FS) 2.0 and later
- Duo Access Gateway
- Azure AD



**Note** You can use any standard SAML 2.0 identity provider to configure SSO using SAML on your email gateway.

## Certificates for Secure Communication

Obtain the following certificates that are required to secure the communication between your email gateway and the identity provider:

- If you want your email gateway to sign SAML authentication requests or if you want your identity provider to encrypt SAML assertions, obtain a self-signed certificate or a certificate from a trusted CA and the associated private key.
- If you want the identity provider to sign SAML assertions, obtain the identity provider's certificate and import the same to your email gateway. Your email gateway will use this certificate to verify the signed SAML assertions.

### Converting Certificates

To create and export certificates from your email gateway, see [Working with Certificates, on page 672](#). Normally, the certificates obtained from the email gateway are in .pfx format and must be converted to .pem format when you configure your email gateway as a service provider.

To convert the certificates from .pfx format to .pem format, do the following:

- Download and install OpenSSL tool and import the certificate file (.pfx) obtained from your email gateway.
- Run the following command to export the certificate in .pem format: `openssl pkcs12 -in <certname>.pfx -nokeys -out cert.pem`
- Run the following command to export the private key in .pem format: `openssl pkcs12 -in certname.pfx -nocerts -out key.pem -nodes`
- Run the following command to remove the passphrase from the private key: `openssl rsa -in key.pem -out server.key`

## Configuring Email Gateway as a Service Provider



---

**Note** The service provider settings on the identity provider is configured based on the service provider configurations on the email gateway.

---

### Before you begin

Make sure that you review the [Prerequisites, on page 1077](#).

### Procedure

---

- Step 1** Log in to your email gateway using the web interface.
- Step 2** Navigate to **System Administration > SAML**.
- Step 3** Click **Add Service Provider**.
- Step 4** Enter the following details:

Field	Description
Profile Name	Enter a name for the service provider profile.
<b>Configuration Settings</b>	
Entity ID	Enter a globally unique name for the service provider (in this case, your email gateway). The format of the service provider Entity ID is typically a URI.
Name ID Format	<p>The format that the identity provider should use to specify the user in the SAML assertion.</p> <p>This field is not configurable. You will need this value while configuring the service provider settings on the identity provider.</p>
Assertion Consumer URL	<p>Enter the URL to which the identity provider should send the SAML assertion after authentication has successfully completed.</p> <p>The Assertion Consumer URL is the URL that is used to access your email gateway. You will need this value while configuring the service provider settings on the identity provider.</p>

Field	Description
SP Certificate	<p>You can choose to import service provider certificates in any one of the following ways:</p> <ul style="list-style-type: none"> <li>• Select a signed certificate available on your email gateway, from the drop-down list.</li> <li>• Import a certificate and the associated private key. The certificate must be in (.cert) format and the private key in (.key) format.</li> <li>• Import a certificate in PKCS #12 file format. Password is mandatory for PKCS #12 format certificates.</li> </ul> <p>(Optional) <b>Signing Authentication Requests</b></p> <p>If you want the appliance to sign the SAML authentication requests:</p> <ol style="list-style-type: none"> <li>a. Upload the certificate obtained from the email gateway and the associated private key.  You must upload the certificate in (.cert) format. For more information, see <a href="#">Certificates for Secure Communication, on page 1078</a>.</li> <li>b. Enter the passphrase for the private key.</li> <li>c. Select <b>Sign Requests</b>.</li> </ol> <p>(Optional) <b>Decrypt Encrypted Assertions</b></p> <p>If you plan to configure your identity provider to encrypt SAML assertions:</p> <ol style="list-style-type: none"> <li>a. Upload the certificate obtained from the email gateway and the associated private key.</li> <li>b. Enter the passphrase for the private key.</li> </ol> <p><b>Note</b> The private key must be in .key format. For information on the usage of certificates, see <a href="#">Certificates for Secure Communication, on page 1078</a>.</p>
Sign Assertions	<p>If you want the identity provider to sign the SAML assertions, select <b>Sign Assertions</b>.</p> <p>If you select this option, you must add the identity provider's certificate to the email gateway. See <a href="#">Configure Identity Provider Settings on Email Gateway, on page 1083</a>.</p>
Organization Details	<p>Enter the details of your organization. Identity provider uses this information in the error logs.</p>
Technical Contact	<p>Enter the email address of the technical contact. Identity provider uses this information in the error logs.</p>

**Step 5** Click **Submit** and commit your changes.



**Step 6** Note down the service provider metadata (Entity ID and Assertion Customer URL) displayed on the SSO Settings page and the Name ID Format displayed on the Service Provider Settings page. You will need these details while configuring the service provider settings on the identity provider.

Optionally, you can export the metadata as a file. After you configure the settings, click **Export Metadata** and save the metadata file. Some identity providers allow you to load service provider details from a metadata file.

---

#### What to do next

Configure the identity provider to communicate with your email gateway. See [Configuring the Identity Provider to Communicate with Email Gateway, on page 1081](#).

## Configuring the Identity Provider to Communicate with Email Gateway

### Before you begin

Make sure that you have:

- Configured your email gateway as a service provider. See [Configuring Email Gateway as a Service Provider, on page 1078](#).
- Copied the service provider metadata details or exported the metadata file. See [Configuring Email Gateway as a Service Provider, on page 1078](#).

### Procedure

---

**Step 1** On the identity provider, do one of the following:

- Manually configure the details of the service provider (your email gateway).
- If your identity provider allows you to load the service provider details from a metadata file, import the metadata file.

If you have configured your email gateway to sign the SAML authentication requests or you plan to encrypt SAML assertions, make sure that you add the relevant certificate to the identity provider.

For identity provider-specific instructions, see:

- [Configure AD FS to Communicate with Email Gateway, on page 1082](#).
- [Configure Duo Access Gateway to Communicate with Email Gateway, on page 1082](#).
- [Configure Azure AD to Communicate with Email Gateway, on page 1083](#).

**Step 2** Note down the identity provider metadata or export the metadata as a file.

---

### What to do next

Configure the identity provider settings on your email gateway. See [Configure Identity Provider Settings on Email Gateway](#), on page 1083.

### Configure AD FS to Communicate with Email Gateway

The following are the high level tasks you need to perform to configure AD FS (2.0 and later) to communicate with your email gateway. For complete and detailed instructions, see *Microsoft documentation*.

- Add the service provider's ( email gateway's) Assertion Consumer URL as a relaying party.
- Enter the service provider's ( email gateway's) Entity ID under Relaying Party Trusts > Properties > Identifiers > Relaying Party Identifier. Make sure that this value is same as the Entity ID value in the Service Provider settings on your email gateway.
- If you have configured your service provider (appliance) to send signed SAML authentication requests, upload the service provider's certificate (used to sign authentication requests) in .cer format under Relaying Party Trusts > Properties > Signature.
- If you plan to configure AD FS to send encrypted SAML assertions, upload the service provider's ( email gateway's) certificate in .cer format under Relaying Party Trusts > Properties > Encryption.
- Set the Secure-hash Algorithm to SHA-1 under Relaying Party Trusts > Properties > Advanced.
- Add a custom rule to include SPNameQualifier in the response. The following is a sample custom rule:
 

```
c:[Type == "http://schemas.xmlsoap.org/ws/2005/05/identity/claims/emailaddress"] =>
issue(Type = "http://schemas.xmlsoap.org/ws/2005/05/identity/claims/nameidentifier",
Issuer=
c.Issuer, OriginalIssuer = c.OriginalIssuer, Value = c.Value, ValueType = c.ValueType,
Properties["http://schemas.xmlsoap.org/ws/2005/05/identity/claimproperties/format"] =
"urn:oasis:names:tc:SAML:1.1:nameid-format:emailAddress",
Properties ["http://schemas.xmlsoap.org/ws/2005/05/identity/claimproperties/format"] =
"urn:oasis:names:tc:SAML:1.1:nameid-format:unspecified");
```
- Edit the Claim Rule and add an Issuance Transform Rule to send the LDAP attribute for email address as an outgoing claim type (email address). Also ensure that you add an Issuance Transform Rule to send the LDAP attribute for group attribute as an outgoing claim type (unspecified groups).

### Configure Duo Access Gateway to Communicate with Email Gateway

The following are the high level tasks you need to perform to Duo Access Gateway to communicate with your email gateway. For complete and detailed instructions, see *Duo Security Documentation*.

- Add the service provider's ( email gateway's) Assertion Consumer URL as the service provider endpoint that receives and processes SAML assertions.
- Enter the service provider's ( email gateway's) Entity ID under Duo Admin Panel > Applications > Protect an Application > SAML Service Provider. Make sure that this value is same as the Entity ID value in the Service Provider settings on your email gateway.
- If you have configured your service provider ( email gateway) to send signed SAML authentication requests, upload the service provider's certificate (used to sign authentication requests) in .cer format when you configure the authentication source on the Duo Access Gateway.

- If you plan to configure Duo to send encrypted SAML assertions, upload the service provider's ( email gateway's) certificate in .cer format when you configure the authentication source on the Duo Access Gateway.
- Select the NameID format as "unspecified" under Duo Admin Panel > Applications > Protect an Application > SAML Service Provider > SAML Response.
- Set the Secure-hash Algorithm to SHA-256 under Duo Admin Panel > Applications > Protect an Application > SAML Service Provider > SAML Response.
- Save the SAML - Service Provider Setting as a configuration file on the Duo Admin Panel and import the configuration file as a SAML application on the Duo Access Gateway.

## Configure Azure AD to Communicate with Email Gateway

The following are the high level tasks you need to perform to Azure AD to communicate with your email gateway. For complete and detailed instructions, see *Microsoft Azure AD Documentation*.

- Add the service provider's ( email gateway's) Assertion Consumer URL as the service provider identifier that receives and processes SAML assertions.
- Enter the service provider's (email gateway's) Entity ID in the Azure Portal under Enterprise Application > New Application > Non-gallery application > Single Sign-On > Basic SAML Configuration. Make sure that this value is same as the Entity ID value in the Service Provider settings on your email gateway.
- If you have configured your service provider ( email gateway) to send signed SAML authentication requests, upload the service provider's certificate (used to sign authentication requests) under SAML Signing Certificate section (Enterprise Application > New Application > Non-gallery application > Single Sign-On > SAML Signing Certificate).
- Configure a Group Claim under User Attributes and Claims section (Enterprise Application > New Application > Non-gallery application > Single Sign-On > User Attributes and Claims) and add the group attribute.
- Add users and/or groups under Azure Application created for SAML > Users & Groups to control users who can login to this Azure SAML application..

## Configure Identity Provider Settings on Email Gateway

### Before you begin

Make sure that you have:

- Configured the identity provider to communicate with your email gateway. See [Configuring the Identity Provider to Communicate with Email Gateway, on page 1081](#).
- Copied the identity provider metadata details or exported the identity provider metadata as file.

### Procedure

- 
- Step 1** Log in to your email gateway on the web interface.
- Step 2** Navigate to **System Administration > SAML**.

**Step 3** Click **Add Identity Provider**.

**Step 4** Enter the following details:

Field	Description
Profile Name	Enter a name for the identity provider profile.
Configuration Settings (Manually Configure Identity Provider Settings)	
Entity ID	Enter a globally unique name for the identity provider. The format of the identity provider Entity ID is typically a URI.
SSO URL	Specify the URL to which the service provider must send the SAML authentication requests.
Certificate	If the identity provider signs the SAML assertion, you must upload the identity provider's signing certificate.
Configuration Settings (Importing Identity Provider Metadata)	
Import IDP Metadata	Click <b>Import Metadata</b> and select the metadata file.

**Step 5** Submit and commit your changes.

#### What to do next

[Enable SAML Authentication, on page 991.](#)

## Configuring OpenID Connect 1.0 on Email Gateway for AsyncOS APIs

- [Overview, on page 1084](#)
- [Workflow, on page 1085](#)
- [Sample Access Token, on page 1085](#)
- [Prerequisites, on page 1086](#)
- [Configuring OpenID Connect on Email Gateway, on page 1086](#)

### Overview

The Cisco Secure Email Gateway supports integration with applications or clients that use Identity Providers (IDPs) with OpenID Connect 1.0 authentication to connect seamlessly with AsyncOS APIs available in your email gateway. Currently, your email gateway has been certified with OpenID Connect using Microsoft AD FS only.

## Workflow

In the following workflow, AD FS is used as an identity provider, external application as a client, and your email gateway as a resource provider.

### Steps:

1. [One-time activity] Configure your email gateway to validate the access token. For more information, see [Configuring OpenID Connect on Email Gateway, on page 1086](#).
2. [One-time activity] The email gateway fetches the OpenID Connect configuration metadata and the required keys to validate the access token based on the configuration done in step1.
3. Obtain the access token after you authenticate the external application with AD FS. For more information on how to authenticate and receive the access token, see your Authentication Provider or Identity Provider documentation.
4. Send the API request along with the access token to the email gateway.
5. The email gateway validates the access token in the API request using the key set retrieved from step2.
6. The email gateway validates the required claim (issuer, audience) in the access token.
7. The email gateway uses the role claim value to authorize and allocate the user role privileges to access the AsyncOS APIs.
8. The email gateway provides an appropriate response for the AsyncOS API request.

## Sample Access Token

The following is the format of a sample access token:

```
Header
alg:RSA256
typ:JWT
[...]
Payload
claim: aud: CiscoEmailAPICaller
claim: iss: http://adfserver/adfs/services/trust
claim: iat: 1594712147
claim: exp: 1594712807
claim: CustomOrgIdentifier: MyCustomOrgId
claim: LastName: Fernandes
claim: FirstName: Erik
claim: Email: erik.fernandes@customorg.com
claim: Role: LogCollector
claim: Role: ReadOnly
[...]
```

The email gateway supports the validation of access tokens signed by the following algorithms only:

- RSA256
- RSA384
- RSA512

## Prerequisites

Make sure that you have met the following prerequisites before you configure your email gateway with OpenID Connect:

- The authentication provider used by your organization is supported by the email gateway.
- The application can authenticate with the authentication provider and retrieve the access token.
- The email gateway can connect to the authentication provider over HTTPs to fetch the OpenID Connect metadata configuration.

## Configuring OpenID Connect on Email Gateway

### Before you begin

Make sure that you have the following:

- A valid access token issued by the authentication provider (based on your authentication provider setup).
- The access token must include the role information to allow the email gateway to perform the required authorization checks.

### Procedure

**Step 1** Click **System Administration** > **OpenID Connect**.

**Step 2** Click **Edit Settings**.

**Step 3** Enter the required parameters described in the following table to configure OpenID Connect:

OpenID Connect Parameters	Description
Identity Provider Metadata URL	<p>Enter the identity provider URL used to fetch the Open ID Connect configuration metadata. The metadata is used to validate the access token.</p> <p>The following is an example of an identity provider URL -  <a href="https://example.com/adfs/well-known/openid-configuration">https://example.com/adfs/well-known/openid-configuration</a>.</p>
Issuer	<p>Enter the value of the issuer of the access token.</p> <p><b>Note</b> The value must match the issuer claim value of the access token when validating the access token.</p> <p>The following is an example of an issuer -  <a href="http://example.com/adfs/services/trust">http://example.com/adfs/services/trust</a>.</p>

OpenID Connect Parameters	Description
Audience	Enter the value of the audience that must match the audience claim value of the access token.  <b>Note</b> Click <b>Add Row</b> if you want to add more than one audience value.
Claim Name	Enter the name of the claim in the access token, which contains the user role information. The claim name is used to retrieve the role information from the access token.
Identity Provider to Appliance Role Mapping	Enter a user group role defined in the Identity Provider Server and choose a corresponding local user role configured in the email gateway to map both roles.  <b>Note</b> Click <b>Add Row</b> if you want to add more than one role mapping record.

**Step 4** Submit and commit your changes.

### What to do next

Include the access token in the Authorization Bearer header of the AsyncOS API call and send the API request.

The following is an example of invoking an AsyncOS API with the access token in the Authorization Bearer header of the API.

```
curl --location --request
GET 'https://esa.com/esa/api/v2.0/config/logs/subscriptions?retrievalMethod=manual'
--header 'Authorization: Bearer <add access_token here>'
```

## System Time

To set the System Time on your email gateway, set the Time Zone used, or select an NTP server and query interface, use the Time Zone or Time Settings page from the System Administration menu in the GUI or use the following commands in the CLI: `ntpconfig`, `settime`, and `settz`.

You can also verify the time zone files used by AsyncOS on the **System Administration > Time Settings** page or using the `tzupdate` CLI command.

## Selecting a Time Zone

The Time Zone page (available via the System Administration menu in the GUI) displays the time zone for your email gateway. You can select a specific time zone or GMT offset.

### Procedure

---

- Step 1** Click **Edit Settings** on the **System Administration > Time Zone** page.
  - Step 2** Select a Region, country, and time zone from the pull-down menus.
  - Step 3** Submit and commit your changes.
- 

## Selecting a GMT Offset

### Procedure

---

- Step 1** Click **Edit Settings** on the **System Administration > Time Zone** page.
  - Step 2** Select GMT Offset from the list of regions.
  - Step 3** Select an offset in the Time Zone list. The offset refers to the amount of hours that must be added/subtracted in order to reach GMT (the Prime Meridian). Hours preceded by a minus sign (“-”) are east of the Prime Meridian. A plus sign (“+”) indicates west of the Prime Meridian.
  - Step 4** Submit and commit your changes.
- 

## Editing Time Settings

You can edit the time settings for the email gateway using one of the following methods:

- [\(Recommended\) Setting Email Gateway System Time Using the Network Time Protocol \(NTP\), on page 1088](#)
- [Setting Email Gateway System Time Manually , on page 1089](#)

### (Recommended) Setting Email Gateway System Time Using the Network Time Protocol (NTP)

This is the recommended time keeping method, especially if your email gateway is integrated with other devices. All integrated devices should use the same NTP server.

### Procedure

---

- Step 1** Navigate to the System Administration > Time Settings page.
  - Step 2** Click **Edit Settings**.
  - Step 3** In the Time Keeping Method section, select Use Network Time Protocol.
  - Step 4** Enter an NTP server address and click **Add Row**. You can add multiple NTP servers.
  - Step 5** To delete an NTP server from the list, click the trash can icon for that server.
  - Step 6** Select an interface for NTP queries. This is the IP address from which NTP queries should originate.
  - Step 7** Submit and commit your changes.
-



## Setting Email Gateway System Time Manually

This time keeping method is generally not recommended. Use a Network Time Protocol server instead.

### Procedure

- 
- Step 1** Navigate to the System Administration > Time Settings page.
  - Step 2** Click **Edit Settings**.
  - Step 3** In the Time Keeping Method section, select Set Time Manually.
  - Step 4** Enter the month, day, year, hour, minutes, and seconds.
  - Step 5** Select A.M or P.M.
  - Step 6** Submit and commit your changes.
- 

## Customizing Your View

- [Using Favorite Pages](#) , on page 1089
- [Setting User Preferences](#), on page 1089

## Using Favorite Pages

(Locally-authenticated administrative users only.) You can create a quick-access list of the pages you use most.

To	Do This
Add pages to your favorites list	Navigate to the page to add, then choose <b>Add This Page To My Favorites</b> from the My Favorites menu near the top right corner of the window.  No commit is necessary for changes to My Favorites.
Reorder favorites	Choose <b>My Favorites &gt; View All My Favorites</b> and drag favorites into the desired order.
Delete favorites	Choose <b>My Favorites &gt; View All My Favorites</b> and delete favorites.
Go to a favorite page	Choose a page from the <b>My Favorites</b> menu near the top right corner of the window.
View or build a custom reporting page	See <a href="#">My Dashboard Page</a> , on page 833.

## Setting User Preferences

Local users can define preference settings, such as language, specific to each account. These settings apply by default when the user first logs into the email gateway. The preference settings are stored for each user and are the same regardless from which client machine the user logs into the email gateway.

When users change these settings but do not commit the changes, the settings revert to the default values when they log in again.



**Note** This feature is not available to externally-authenticated users. These users can choose a language directly from the Options menu.

**Procedure**

- Step 1** Log into the appliance with the user account for which you want to define preference settings.
- Step 2** Choose **Options > Preferences**. The options menu is at the top right side of the window.
- Step 3** Click **Edit Preferences**.
- Step 4** Configure settings:

Preference Setting	Description
Language Display	The language AsyncOS for Web uses in the web interface and CLI.
Landing Page	The page that displays when the user logs into the email gateway.
Reporting Time Range Displayed (default)	The default time range that displays for reports on the Reporting tab.
Number of Reporting Rows Displayed	The number of rows of data shown for each report by default.

- Step 5** Submit and commit your changes.
- Step 6** Click the **Return to previous page** link at the bottom of the page.

## General Settings

You can edit the following general settings for the email gateway:

- [Overriding Internet Explorer Compatibility Mode, on page 1090](#)
- [Collecting Usage Statistics of the Email Gateway on the New Web Interface , on page 1091](#)

## Overriding Internet Explorer Compatibility Mode

For better web interface rendering, Cisco recommends that you enable Internet Explorer Compatibility Mode Override.



**Note** If enabling this feature is against your organizational policy, you may disable this feature.

### Procedure

---

- Step 1** Click System **Administration** > **General Settings**.
  - Step 2** Select **Override IE Compatibility Mode** check box.
  - Step 3** Submit and commit your changes.
- 

## Collecting Usage Statistics of the Email Gateway on the New Web Interface

Usage Analytics is used to provide insight into your site activity data for analytical statistics. If Usage Analytics is enabled, the email gateway collects the feature usage data of the email gateway on the new web interface. The usage statistics are used to analyze and provide insight to improve the user experience of the email gateway.

Usage Analytics is enabled on the email gateway by default. If you want to disable Usage Analytics, do the following:

### Procedure

---

- Step 1** Click System **Administration** > **General Settings**.
  - Step 2** Clear the **Usage Analytics** check box.
  - Step 3** Submit and commit your changes.
- 

## Configuring Maximum HTTP Header Size

You can now use the `adminaccessconfig > maxhttpheaderfieldsize` command in the CLI to configure the maximum HTTP header size of an HTTP request sent to the email gateway.

The default value for the HTTP header field size is 4096 (4 KB) and the maximum value is 33554432 (32 MB).

## Restarting and Viewing Status of Service Engines

You can use the `diagnostic > servicessub` command in the CLI to:

- Restart the service engines enabled on your email gateway without having to reboot your email gateway.
- View the status of service engines enabled on your email gateway.

For more information, refer to the CLI Reference Guide for Cisco Secure Email Gateway.

# Receiving and Delivering Messages with Internationalised Domain Names (IDNs)

The email gateway can receive and deliver messages with email addresses that contain IDN domains.

Currently, your email gateway provides support of IDN domains for the following languages only:

**Indian Regional Languages:** Hindi, Tamil, Telugu, Kannada, Marati, Punjabi, Malayalam, Bengali, Gujarati, Urdu, Assamese, Nepali, Bangla, Bodo, Dogri, Kashmiri, Konkani, Maithili, Manipuri, Oriya, Sanskrit, Santali, Sindhi, and Tulu.

**European and Asian Languages:** French, Russian, Japanese, German, Ukrainian, Korean, Spanish, Italian, Chinese, Dutch, Thai, Arabic, and Kazakh.

## Related Topics:

- [Prerequisites, on page 1092](#)
- [Features Configurable using IDN Domains in Email Gateway, on page 1092](#)

## Prerequisites

Make sure you have met the following prerequisites before you use the Internationalised Domain Names (IDN) feature:

- All incoming messages must have IDNs encoded in UTF-8.  
For Example: An MTA that sends messages to the email gateway must support IDNs and make sure the domains in the messages are in the UTF-8 format.
- All outgoing messages must have IDNs encoded in UTF-8, and the destination server must accept and support IDNs accordingly.  
For Example: An MTA that accepts messages from the email gateway must support IDNs and domains encoded in the UTF-8 format.
- In all applicable DNS records, IDNs must be configured using the Punycode format  
For Example: When you configure an MX record for an IDN, the domain in the DNS record must be in the Punycode format.

## Features Configurable using IDN Domains in Email Gateway

For this release, you can **only** configure the following features using IDN domains in your email gateway:

- **SMTP Routes Configuration Settings:**
  - Add or edit IDN domains.
  - Export or import SMTP routes using IDN domains.
- **DNS Configuration Settings:** Add or edit the DNS server using IDN domains.

- **Listener Configuration Settings:**
  - Add or edit IDN domains for the default domain in inbound or outbound listeners.
  - Add or edit IDN domains in the HAT or RAT tables.
  - Export or import HAT or RAT tables using IDN domains.
  
- **Mail Policies Configuration Settings**
  - Add or edit domains using IDN domains for senders ('Following Senders' or 'Following Senders are not' options) and recipients ('Following Recipients' or 'Recipients are not' options) in Incoming Mail Policies.
  - Add or edit domains using IDN domains for senders ('Following Senders' or 'Following Senders are not' options) and recipients ('Following Recipients' or 'Recipients are not' options) in Outgoing Mail Policies.
  - Find senders or recipients using IDN domains in Incoming or Outgoing Mail Policies.
  - Define Sender Verification Exception table using IDN domains.
  - Create an address list using IDN domains.
  - Add or edit the destination domain using IDN domains for destination controls.
  
- **Bounce Profiles Configuration Settings:** Add or edit the alternate email address using IDN domains.
- **Sender Domain Reputation Configuration Settings:** Define sender domain reputation scores for IDN domains.
- **IP Reputation Configuration Settings:** Define IP reputation scores for IDN domains.
- **LDAP Configuration Settings:** Create LDAP group queries, accept queries, routing queries, and masquerade queries for incoming and outgoing messages using IDN domains.
- **Reporting Configuration Settings:** View IDN data - usernames, email addresses, and domains) in the reports.
- **Message Tracking Configuration Settings:** View IDN data- usernames, email addresses, and domains) in message tracking.
- **Policy, Virus, and Outbreak Quarantine Configuration Settings:**
  - View messages with IDN domains that may be transmitting malware, as determined by the anti-virus engine.
  - View messages with IDN domains caught by Outbreak Filters as potentially being spam or malware.
  - View messages with IDN domains caught by message filters, content filters, and DLP message actions.
  
- **Spam Quarantine Configuration Settings:**
  - View messages with IDN domains detected as spam or suspected spam.
  - Add email addresses with IDN domains to the safelist and blocklist categories.



---

**Note** Currently, recipients with IDN domains can access the End-User Quarantine only if the end-user authentication method is set to 'None' under the 'End-User Quarantine Access' section in the 'Spam Quarantine' settings page.

---

- **SPF Configuration Settings:** Perform SPF verification of messages using IDN domains.
- **DKIM Configuration Settings:** Perform DKIM signing and verification of messages using IDN domains
- **DMARC Configuration Settings:** Perform DMARC verification of messages using IDN domains.



## CHAPTER 40

# Managing and Monitoring Using the CLI

This chapter contains the following sections:

- [Overview of Managing and Monitoring Using the CLI, on page 1095](#)
- [Reading the Available Components of Monitoring, on page 1096](#)
- [Monitoring Using the CLI, on page 1101](#)
- [Managing the Email Queue, on page 1111](#)
- [Monitoring System Health and Status Using SNMP, on page 1120](#)

## Overview of Managing and Monitoring Using the CLI

Managing and monitoring the email gateway using the CLI includes these types of tasks:

- Monitoring message activity.
  - The raw number of messages, recipients, and bounce recipients that the email gateway is processing in the email pipeline
  - The hourly rate of message delivery or message bounces based on the last one-minute, five-minute, or fifteen-minute period
- Monitoring system resources. Examples:
  - Memory usage
  - Disk space
  - Number of connections
- Monitoring possible system disfunction using the Simple Network Management Protocol (SNMP). Examples:
  - Fan failure
  - Update failure
  - Abnormally high email gateway temperature
- Managing email within the pipeline. Examples:
  - Deleting recipients in the queue
  - Redirecting messages to another host
  - Clear the queue by deleting recipients or redirecting the messages
  - Suspend or resume email receiving, delivery, or work queue processing
  - Locate specific messages

# Reading the Available Components of Monitoring

- [Reading the Event Counters, on page 1096](#)
- [Reading the System Gauges, on page 1098](#)
- [Reading the Rates of Delivered and Bounced Messages, on page 1100](#)

## Reading the Event Counters

Counters provide a running total of various events in the system. For each counter, you can view the total number of events that have occurred since the counter was reset, since the last system reboot, and over the system's lifetime.

Counters increment each time an event occurs and are displayed in three versions:

Reset	Since the last counter reset with the <code>resetcounters</code> command
Uptime	Since the last system reboot
Lifetime	Total through the lifetime of the email gateway

The following table lists the available counters and their description when monitoring the email gateway.



**Note** This is the entire list. The displayed counters vary depending on which display option or command you choose. Use this list as a reference.

**Table 106: Counters**

Statistic	Description
Receiving	
Messages Received	Messages received into the delivery queue.
Recipients Received	Recipients on all received messages.
Generated Bounce Recipients	Recipients for which bounces have been generated by the system and inserted into the delivery queue.
Rejection	
Rejected Recipients	Recipients that have been denied receiving into the delivery queue due to the Recipient Access Table (RAT), or unexpected protocol negotiation including premature connection termination.



Statistic	Description
Dropped Messages	Messages that have been denied receiving into the delivery queue due to a filter drop action match or have been received by a Sinkhole queuing listener. Messages directed to /dev/null entries in the alias table also are considered dropped messages. Messages dropped by anti-spam filtering (if it has been enabled on the system) also increment this counter.
Queue	
Soft Bounced Events	Number of soft bounce events — a message that soft bounces multiple times has multiple soft bounce events.
Completion	
Completed Recipients	Total of all hard bounced recipients, delivered recipients, and deleted recipients. Any recipient that is removed from the delivery queue.
Hard Bounced Recipients	Total of all DNS hard bounces, 5XX hard bounces, filter hard bounces, expired hard bounces and other hard bounces. A failed attempt to deliver message to a recipient that results in immediate termination of that delivery.
DNS Hard Bounces	DNS error encountered while trying to deliver a message to a recipient.
5XX Hard Bounces	The destination mail server returned a “5XX” response code while trying to deliver a message to a recipient.
Expired Hard Bounces	Message recipients that have exceeded the maximum time allowed in the delivery queue or the maximum number of connection attempts.
Filter Hard Bounces	Recipient delivery has been preempted by a matching filter bounce action. Messages dropped by anti-spam filtering (if it has been enabled on the system) also increment this counter.
Other Hard Bounces	An unexpected error during message delivery or a message recipient was explicitly bounced via the bouncerecipients command.
Delivered Recipients	Message successfully delivered to a recipient.
Deleted Recipients	Total of message recipients explicitly deleted via the deleterecipients command or was a Global Unsubscribe Hit.
Global Unsubscribe Hits	Message recipient was deleted due to a matching global unsubscribe setting.
Current IDs	

Statistic	Description
Message ID (MID)	The last Message ID to have been assigned to a message inserted into the delivery queue. A MID is associated with every message received by the email gateway and can be tracked in mail logs. The MID resets to zero at 231.
Injection Connection ID (ICID)	The last Injection Connection ID to have been assigned to a connection to a listener interface. The ICID rolls over (resets to zero) at 231.
Delivery Connection ID (DCID)	The last Delivery Connection ID to have been assigned to a connection to a destination mail server. The DCID rolls over (resets to zero) at 231.

## Reading the System Gauges

Gauges show the current utilization of a system resource such as memory, disk space, or active connections. The following table lists the available gauges and their description when monitoring the email gateway.



**Note** This is the entire list. The displayed gauges will vary depending upon which display option or command you choose. Use this list as a reference.

*Table 107: Gauges*

Statistic	Description
System Gauges	
RAM Utilization	Percentage of physical RAM (Random Access Memory) being used by the system.
CPU Utilization	Percentage of CPU usage.
Disk I/O Utilization	Percentage of Disk I/O being used.  <b>Note</b> The Disk I/O Utilization gauge does not display a reading against a scale of a known value. Rather, it displays the I/O utilization the system has seen thus far and scales against the maximum value since the last reboot. So, if the gauge displays 100%, the system is experiencing the highest level of I/O utilization seen since boot (which may not necessarily represent 100% of the physical Disk I/O of the entire system).

Statistic	Description
Resource Conservation	A value between 0 and 60 or 999 . Numbers from 0 to 60 represent the degree to which the system is decreasing its acceptance of messages in order to prevent the rapid depletion of critical system resources. Higher numbers represent a higher degree of decreased acceptance. Zero represents no decrease in acceptance. If this gauge displays 999 , the system has entered “Resource Conservation mode,” and it will accept no messages. Alert messages are sent whenever the system enters or exits Resource Conservation mode.
Disk Utilization: Logs	Percentage of disk being used for logs, displayed as LogUsd in the status logs and log_used in the XML status.
Connections Gauges	
Current Inbound Connections	Current inbound connections to the listener interfaces.
Current Outbound Connections	Current outbound connections to destination mail servers.
Queue Gauges	
Active Recipients	Message recipients in the delivery queue. Total of Unattempted Recipients and Attempted Recipients.
Unattempted Recipients	A subcategory of Active Recipients. Message recipients in queue for which delivery has not yet been attempted.
Attempted Recipients	A subcategory of Active Recipients. Message recipients in queue for which delivery has been attempted but failed due to a Soft Bounces Event.
Messages in Work Queue	The number of messages waiting to be processed by alias table expansion, masquerading, anti-spam, anti-virus scanning, message filters, and LDAP queries prior to being enqueued.
Messages in Quarantine	The unique number of messages in any quarantine, plus messages that have been released or deleted but not yet acted upon. For example, if you release all quarantined messages from Outbreak, the total messages for Outbreak would become zero immediately, but this field still reflects the quarantined messages until they were all delivered.

Statistic	Description
Destinations in Memory	The number of destinations domains in memory. For each domain with a message destined to be delivered, a destination object is created in memory. After all the mail for that domain has been delivered, the destination object is retained for another 3 hours. After 3 hours, if no new messages are bound for that domain, the object is expired so that the destination is no longer reported (for example, in the <code>tophosts</code> command). If you are delivering mail only to one domain, this counter will be “1.” If you have never received or sent any messages (or no messages have been processed by the email gateway in many hours), the counter will be “0.”  If you are using Virtual Gateways, destination domains for each Virtual Gateway will have a separate destination object. (For example, yahoo.com will count as 3 destination objects if you are delivering to yahoo.com from 3 different Virtual Gateways).
Kilobytes Used	Queue storage used in kilobytes.
Kilobytes in Quarantine	Queue storage used for quarantined messages. The value is calculated as the message size plus 30 bytes for each recipient, totaled for the “Messages in Quarantine” as counted above. Note that this calculation will usually <i>overestimate</i> the space used.
Kilobytes Free	Queue storage remaining in kilobytes.

## Reading the Rates of Delivered and Bounced Messages

All rates are shown as the average rate an event occurs per hour at the specific point in time the query is made. Rates are calculated for three intervals, the average rate per hour over the past one (1) minute, the past five (5) minutes, and the past fifteen (15) minutes.

For example, if the email gateway receives 100 recipients in a single minute, then the rate for the 1 minute interval will be 6,000 per hour. The rate for the 5-minute interval will be 1,200 per hour, and the 15-minute rate will be 400 per hour. The rates are calculated to indicate what the average rate for the hour would be if the rate for the one minute period continued. Therefore, 100 messages each minute would yield a higher rate than 100 messages over 15 minutes.

The following table lists the available rates and their description when monitoring the email gateway.



**Note** This is the entire list. The displayed rates will vary depending upon which display option or command you choose. Use this list as a reference.

**Table 108: Rates**

Statistic	Description
Messages Received	Rate of messages inserted into the delivery queue per hour.

Statistic	Description
Recipients Received	Rate of the number of recipients on all messages inserted into the delivery queue per hour.
Soft Bounced Events	Rate of the number of soft bounce events per hour. (A message that soft bounces multiple times has multiple soft bounce events.)
Completed Recipients	Rate of the total of all hard bounced recipients, delivered recipients and deleted recipients. Any recipient that is removed from the delivery queue is considered completed.
Hard Bounced Recipients	Rate of the total of all DNS hard bounces, 5XX hard bounces, filter hard bounces, expired hard bounces and other hard bounces per hour. A failed attempt to deliver a message to a recipient that results in immediate termination of that delivery is a hard bounce.
Delivered Recipients	Rate of messages successfully delivered to a recipient per hour.

## Monitoring Using the CLI

- [Monitoring the Email Status, on page 1101](#)
- [Monitoring Detailed Email Status, on page 1102](#)
- [Monitoring the Status of a Mail Host, on page 1104](#)
- [Determining the Make-up of the Email Queue, on page 1106](#)
- [Displaying Real-time Activity, on page 1107](#)
- [Monitoring Inbound Email Connections, on page 1108](#)
- [Checking the DNS Status, on page 1109](#)
- [Resetting Email Monitoring Counters, on page 1110](#)
- [Identifying Active TCP/IP Services, on page 1111](#)

## Monitoring the Email Status

You may want to monitor the status of email operations on the email gateway. The status command returns a subset of the monitored information about email operations. The statistics returned displayed in one of two fashions: counters and gauges. Counters provide a running total of various events in the system. For each counter, you can view the total number of events that have occurred since the counter was reset, since the last system reboot, and over the system's lifetime. Gauges show the current utilization of a system resource such as memory, disk space, or active connections.

For a description of each item, see [Overview of Managing and Monitoring Using the CLI, on page 1095](#).

**Table 109: Mail Status**

Statistic	Description
Status as of	Displays the current system time and date.
Last counter reset	Displays the last time the counters were reset.

## Example

Statistic	Description
System status	Online, offline, receiving suspended, or delivery suspended. Note that the status will be “receiving suspended” only when <i>all</i> listeners are suspended. The status will be “offline” when receiving and delivery are suspended for <i>all</i> listeners.
Oldest Message	Displays the oldest message waiting to be delivered by the system.
Features	Displays any special features installed on the system by the featurekey command.

## Example

```
mail3.example.com> status

Status as of:          Thu Oct 21 14:33:27 2004 PDT
Up since:              Wed Oct 20 15:47:58 2004 PDT (22h 45m 29s)
Last counter reset:   Never
System status:        Online
Oldest Message:      4 weeks 46 mins 53 secs
Counters:
  Reset              Uptime              Lifetime
Receiving
  Messages Received  62,049,822          290,920          62,049,822
  Recipients Received 62,049,823          290,920          62,049,823
Rejection
  Rejected Recipients 3,949,663           11,921           3,949,663
  Dropped Messages   11,606,037          219              11,606,037
Queue
  Soft Bounced Events 2,334,552           13,598           2,334,552
Completion
  Completed Recipients 50,441,741          332,625          50,441,741
Current IDs
  Message ID (MID)          99524480
  Injection Conn. ID (ICID) 51180368
  Delivery Conn. ID (DCID) 17550674
Gauges:
  Current
Connections
  Current Inbound Conn.    0
  Current Outbound Conn.  14
Queue
  Active Recipients        7,166
  Messages In Work Queue   0
  Messages In Quarantine   16,248
  Kilobytes Used           387,143
  Kilobytes In Quarantine  338,206
  Kilobytes Free           39,458,745
mail3.example.com>
```

## Monitoring Detailed Email Status

The status detail command returns complete monitored information about email operations. The statistics returned are displayed in one of three categories: counters, rates, and gauges. Counters provide a running total of various events in the system. For each counter, you can view the total number of events that have occurred since the counter was reset, since the last system reboot, and over the system’s lifetime. Gauges show the current utilization of a system resource such as memory, disk space, or active connections. All rates are shown as the average rate an event occurs per hour at the specific point in time the query is made. Rates are calculated for three intervals, the average rate per hour over the past one (1) minute, the past five (5) minutes, and the

past fifteen (15) minutes. For a description of each item, see [Overview of Managing and Monitoring Using the CLI, on page 1095](#).

## Example

```
mail3.example.com> status detail
Status as of:          Thu Jun 30 13:09:18 2005 PDT
Up since:              Thu Jun 23 22:21:14 2005 PDT (6d 14h 48m 4s)
Last counter reset:   Tue Jun 29 19:30:42 2004 PDT
System status:        Online
Oldest Message:       No Messages
Feature - IronPort Anti-Spam: 17 days
Feature - Sophos:     Dormant/Perpetual
Feature - Outbreak Filters: Dormant/Perpetual
Feature - Central Mgmt: Dormant/Perpetual
Counters:
  Reset              Uptime              Lifetime
Receiving
  Messages Received  2,571,967           24,760           3,113,176
  Recipients Received 2,914,875           25,450           3,468,024
  Gen. Bounce Recipients 2,165              0                7,451
Rejection
  Rejected Recipients 1,019,453           792              1,740,603
  Dropped Messages   1,209,001           66               1,209,028
Queue
  Soft Bounced Events 11,236              0                11,405
Completion
  Completed Recipients 2,591,740           49,095           3,145,002
  Hard Bounced Recipients 2,469              0                7,875
    DNS Hard Bounces   199                0                3,235
    5XX Hard Bounces   2,151              0                4,520
    Expired Hard Bounces 119                0                120
    Filter Hard Bounces 0                  0                0
    Other Hard Bounces 0                  0                0
  Delivered Recipients 2,589,270           49,095           3,137,126
  Deleted Recipients 1                  0                1
    Global Unsub. Hits 0                  0                0
  DomainKeys Signed Msgs 10                 9                10
Current IDs
  Message ID (MID)                                7615199
  Injection Conn. ID (ICID)                       3263654
  Delivery Conn. ID (DCID)                        1988479
Rates (Events Per Hour):
  1-Minute      5-Minutes      15-Minutes
Receiving
  Messages Received 180            300            188
  Recipients Received 180            300            188
Queue
  Soft Bounced Events 0              0              0
Completion
  Completed Recipients 360            600            368
  Hard Bounced Recipients 0              0              0
  Delivered Recipients 360            600            368
Gauges:
  Current
System
  RAM Utilization          1%
  CPU Utilization
    MGA                    0%
    AntiSpam               0%
    AntiVirus              0%
  Disk I/O Utilization     0%
  Resource Conservation    0
Connections
  Current Inbound Conn.   0
```

```

Current Outbound Conn.          0
Queue
  Active Recipients              0
    Unattempted Recipients      0
    Attempted Recipients        0
  Messages In Work Queue        0
  Messages In Quarantine        19
  Destinations In Memory        3
  Kilobytes Used                 473
    Kilobytes In Quarantine     473
  Kilobytes Free                 39,845,415

```



**Note** A case could exist in a newly installed email gateway where the oldest message counter shows a message but, in fact, there are no recipients shown in counters. If the remote host is connecting and in the process of receiving a message very slowly (that is, it takes minutes to receive a message), you might see that the recipients received counter displays “0” but the oldest message counter displays “1.” This is because the oldest message counter displays messages in progress. The counter will be reset if the connection is eventually dropped.

## Monitoring the Status of a Mail Host

If you suspect delivery problems to a specific recipient host or you want to gather information on a Virtual Gateway address, the `hoststatus` command displays this information. The `hoststatus` command returns monitoring information about email operations relating to a specific recipient host. The command requires that you enter the domain of the host information to be returned. DNS information stored in the AsyncOS cache and the last error returned from the recipient host is also given. Data returned is cumulative since the last `resetcounters` command. The statistics returned are displayed in two categories: counters and gauges. For a description of each item, see [Overview of Managing and Monitoring Using the CLI, on page 1095](#).

In addition, these other data are returned specific to the `hoststatus` command.

**Table 110: Additional Data in the `hoststatus` Command**

Statistic	Description
Pending Outbound Connections	Pending, or “embryonic” connections to the destination mail host, as opposed to open and working connections. Pending Outbound Connections are connections which have not yet gotten to the protocol greeting stage.
Oldest Message	The age of the oldest active recipient in the delivery queue for this domains. This counter is useful for determining the age of a message in the queue that cannot be delivered because of soft bounce events and/or a downed host.
Last Activity	This field is updated each time a message delivery is attempted to that host.
Ordered IP Addresses	This field contains the TTL (time to live) for IP addresses, their preference according to MX records, and the actual addresses. An MX record designates the mail server IP address for a domain. A domain may have multiple MX records. Each MX record mail server is assigned a priority. The MX record with the lowest priority number is given preference.



Statistic	Description
Last 5XX error	This field contains the most recent “5XX” status code and description returned by the host. This is only displayed if there is an 5XX error.
MX Records	An MX record designates the mail server IP address for a domain. A domain may have multiple MX records. Each MX record mail server is assigned a priority. The MX record with the lowest priority number is given preference.
SMTP Routes for this host	If SMTP routes are defined for this domain, they are listed here.
Last TLS Error	This field contains a description of the the most recent outgoing TLS connection error and the type of TLS connection that the email gateway tried to establish. This is only displayed if there is a TLS error.

## Virtual Gateway

The following Virtual Gateway information is only displayed if you have set up Virtual Gateway addresses (see [Configuring the Gateway to Receive Email, on page 65.](#))

**Table 111: Additional Virtual Gateway Data in the hoststatus Command**

Statistic	Description
Host up/down	Same definition as global hoststatus field of the same name — tracked per Virtual Gateway address.
Last Activity	Same definition as global hoststatus field of the same name — tracked per Virtual Gateway address.
Recipients	This field also corresponds to the same definition as the global hoststatus command. Active Recipients field — tracked per Virtual Gateway address.
Last 5XX error	This field contains the most recent 5XX status code and description returned by the host. This is only displayed if there is a 5XX error.

## Example

```
mail3.example.com> hoststatus

Recipient host:
[]> aol.com
Host mail status for: 'aol.com'
Status as of:      Tue Mar 02 15:17:32 2010
Host up/down:     up
Counters:
  Queue
    Soft Bounced Events          0
  Completion
    Completed Recipients          1
    Hard Bounced Recipients      1
    DNS Hard Bounces              0
    5XX Hard Bounces              1
    Filter Hard Bounces           0
    Expired Hard Bounces          0
```

```

        Other Hard Bounces                0
        Delivered Recipients              0
        Deleted Recipients                 0
Gauges:
Queue
  Active Recipients                      0
  Unattempted Recipients                 0
  Attempted Recipients                   0
Connections
  Current Outbound Connections           0
  Pending Outbound Connections           0
Oldest Message      No Messages
Last Activity       Tue Mar 02 15:17:32 2010
Ordered IP addresses: (expiring at Tue Mar 02 16:17:32 2010)
Preference  IPs
15          64.12.137.121    64.12.138.89    64.12.138.120
15          64.12.137.89     64.12.138.152   152.163.224.122
15          64.12.137.184    64.12.137.89    64.12.136.57
15          64.12.138.57     64.12.136.153   205.188.156.122
15          64.12.138.57     64.12.137.152   64.12.136.89
15          64.12.138.89     205.188.156.154 64.12.138.152
15          64.12.136.121    152.163.224.26  64.12.137.184
15          64.12.138.120    64.12.137.152   64.12.137.121
MX Records:
Preference  TTL      Hostname
15          52m24s  mailin-01.mx.aol.com
15          52m24s  mailin-02.mx.aol.com
15          52m24s  mailin-03.mx.aol.com
15          52m24s  mailin-04.mx.aol.com
Last 5XX Error:
-----
550 REQUESTED ACTION NOT TAKEN: DNS FAILURE
(at Tue Mar 02 15:17:32 2010 GMT) IP: 10.10.10.10
-----
Last TLS Error:          Required - Verify
-----
TLS required, STARTTLS unavailable
(at Tue Mar 02 15:17:32 2010 GMT) IP: 10.10.10.10
Virtual gateway information:
=====
example.com (PublicNet_017):
Host up/down:          up
Last Activity          Wed June 22 13:47:02 2005
Recipients              0

```



---

**Note** The Virtual Gateway address information only appears if you are using the altsrchoost feature.

---

## Determining the Make-up of the Email Queue

To get immediate information about the email queue and determine if a particular recipient host has delivery problems — such as a queue buildup — use the `tophosts` command. The `tophosts` command returns a list of the top 20 recipient hosts in the queue. The list can be sorted by a number of different statistics, including active recipients, connections out, delivered recipients, soft bounced events, and hard bounced recipients. For a description of each item, see [Overview of Managing and Monitoring Using the CLI, on page 1095](#).

## Example

```
mail3.example.com> tophosts

Sort results by:
1. Active Recipients
2. Connections Out
3. Delivered Recipients
4. Soft Bounced Events
5. Hard Bounced Recipients
[1]> 1
Status as of:           Mon Nov 18 22:22:23 2003
Active   Conn.   Deliv.   Soft   Hard
# Recipient Host Recip   Out   Recip.   Bounced   Bounced
1 aol.com          365    10    255     21         8
2 hotmail.com     290     7    198     28        13
3 yahoo.com       134     6    123     11        19
4 excite.com      98      3     84      9         4
5 msn.com         84      2     76     33        29
mail3.example.com>
```

## Displaying Real-time Activity

The email gateway offers real-time monitoring, which allows you to view the progress of email activity on the system. The `rate` command returns real-time monitoring information about email operations. The information is updated on a periodic interval as specified by you. Use Control-C to stop the `rate` command.

The data shown are listed in the following table:

**Table 112: Data in the `rate` Command**

Statistic	Description
Connections In	Number of inbound connections.
Connections Out	Number of outbound connections.
Recipients Received	Total number of recipients received into the system.
Recipients Completed	Total number of recipients completed.
Delta	The difference change in Received and Completed recipients since the last data update.
Queue Used	Size of the message queue in kilobytes.

## Example

```
mail3.example.com> rate

Enter the number of seconds between displays.
[10]> 1
Hit Ctrl-C to return to the main prompt.
Time      Connections Recipients      Recipients      Queue
          In    Out   Received   Delta Completed   Delta   K-Used
23:37:13  10    2   41708833    0   40842686    0      64
```

## Example

```

23:37:14      8      2  41708841      8  40842692      6      105
23:37:15      9      2  41708848      7  40842700      8       76
23:37:16      7      3  41708852      4  40842705      5       64
23:37:17      5      3  41708858      6  40842711      6       64
23:37:18      9      3  41708871     13  40842722     11       67
23:37:19      7      3  41708881     10  40842734     12       64
23:37:21     11      3  41708893     12  40842744     10       79
^C

```

The `hostrate` command returns real-time monitoring information about a specific mail host. This information is a subset of the status detail command. (See [Monitoring Detailed Email Status](#), on page 1102.)

**Table 113: Data in the `hostrate` Command**

Statistic	Description
Host Status	Current status of the specific host: up, down, or unknown.
Current Connections Out	Current number of outbound connections to the host.
Active Recipients in Queue	Total number of active recipients to the specific host in queue.
Active Recipients in Queue Delta	Difference in the total number of active recipients to the specific host in queue since the last known host status.
Delivered Recipients Delta	Difference in the total number of delivered recipients to the specific host in queue since the last known host status.
Hard Bounced Recipients Delta	Difference in the total number of hard bounced recipients to the specific host in queue since the last known host status.
Soft Bounce Events Delta	Difference in the total number of soft bounced recipients to the specific host in queue since the last known host status.

Use Control-C to stop the `hostrate` command.

## Example

```

mail3.example.com> hostrate
Recipient host:
[]> aol.com
Enter the number of seconds between displays.
[10]> 1
   Time   Host  CrtCncOut  ActvRcp  ActvRcp  DlvRcp  HrdBncRcp  SftBncEvt
   Status                Delta    Delta    Delta    Delta
23:38:23      up      1          0          0          4          0          0
23:38:24      up      1          0          0          4          0          0
23:38:25      up      1          0          0         12          0          0
^C

```

## Monitoring Inbound Email Connections

You may want to monitor hosts that are connecting to the email gateway to identify the large volume senders or to troubleshoot inbound connections to the system. The `topin` command provides a snapshot of the remote hosts connecting to the system. It displays a table with one row for each remote IP address connecting to a

specific listener. Two connections from the same IP address to different listeners results in 2 rows in the following table describes the fields displayed when using the `topin` command.

**Table 114: Data in the `topin` Command**

Statistic	Description
Remote Hostname	Hostname of the remote host, derived from Reverse DNS lookup.
Remote IP Address	IP address of the remote host.
listener	Nickname of the listener on the email gateway that is receiving the connection.
Connections In	The number of concurrent connections from the remote host with the specified IP address open at the time when the command is run.

The system does a reverse DNS lookup to find the remote hostname, and then a forward DNS lookup to validate the name. If the forward lookup does not result in the original IP address, or if the reverse DNS lookup fails, the table displays the IP address in the hostname column. For more information about the process of sender verification, see [Verifying Senders, on page 113](#).

## Example

```
mail3.example.com> topin
```

```
Status as of:                               Sat Aug 23 21:50:54 2003
# Remote hostname      Remote IP addr.  listener        Conn. In
1 mail.remotedomain01.com 172.16.0.2      Incoming01      10
2 mail.remotedomain01.com 172.16.0.2      Incoming02      10
3 mail.remotedomain03.com 172.16.0.4      Incoming01      5
4 mail.remotedomain04.com 172.16.0.5      Incoming02      4
5 mail.remotedomain05.com 172.16.0.6      Incoming01      3
6 mail.remotedomain06.com 172.16.0.7      Incoming02      3
7 mail.remotedomain07.com 172.16.0.8      Incoming01      3
8 mail.remotedomain08.com 172.16.0.9      Incoming01      3
9 mail.remotedomain09.com 172.16.0.10     Incoming01      3
10 mail.remotedomain10.com 172.16.0.11     Incoming01      2
11 mail.remotedomain11.com 172.16.0.12     Incoming01      2
12 mail.remotedomain12.com 172.16.0.13     Incoming02      2
13 mail.remotedomain13.com 172.16.0.14     Incoming01      2
14 mail.remotedomain14.com 172.16.0.15     Incoming01      2
15 mail.remotedomain15.com 172.16.0.16     Incoming01      2
16 mail.remotedomain16.com 172.16.0.17     Incoming01      2
17 mail.remotedomain17.com 172.16.0.18     Incoming01      1
18 mail.remotedomain18.com 172.16.0.19     Incoming02      1
19 mail.remotedomain19.com 172.16.0.20     Incoming01      1
20 mail.remotedomain20.com 172.16.0.21     Incoming01      1
```

## Checking the DNS Status

The `dnsstatus` command returns a counter displaying statistics of DNS lookup and cache information. For each counter, you can view the total number of events since the counter was last reset, since the last system reboot, and over the lifetime of the system.

The following table lists the available counters.

Table 115: Data in the `dnsstatus` Command

Statistic	Description
DNS Requests	A top-level, non-recursive request to the system DNS cache to resolve a domain name.
Network Requests	A request to the network (non-local) to retrieve DNS information.
Cache Hits	A request to the DNS cache where the record was found and returned.
Cache Misses	A request to the DNS cache where the record was not found.
Cache Exceptions	A request to the DNS cache where the record was found but the domain was unknown.
Cache Expired	A request to the DNS cache where the record was found in the cache, considered for use, and discarded because it was too old.  Many entries can exist in the cache even though their time to live (TTL) has been exceeded. As long as these entries are not used, they will not be included in the expires counter. When the cache is flushed, both valid and invalid (too old) entries are deleted. A flush operation does not change the expires counter.

## Example

```
mail3.example.com> dnsstatus
Status as of: Sat Aug 23 21:57:28 2003
Counters:
DNS Requests      211,735,710      8,269,306      252,177,342
Network Requests  182,026,818      6,858,332      206,963,542
Cache Hits        474,675,247      17,934,227     541,605,545
Cache Misses      624,023,089      24,072,819     704,767,877
Cache Exceptions  35,246,211       1,568,005      51,445,744
Cache Expired     418,369          7,800          429,015
mail3.example.com>
```

## Resetting Email Monitoring Counters

The `resetcounters` command resets cumulative email monitoring counters. The reset affects global counters as well as per host counters. The reset does not affect the counters on messages in the delivery queue related to retry schedules.



**Note** You can also reset the counters in the GUI. See [System Status Page, on page 858](#).

## Example

```
mail3.example.com> resetcounters
Counters reset: Mon Jan 01 12:00:01 2003
```

## Identifying Active TCP/IP Services

To identify active TCP/IP services used by your email gateway, use the `tcpservices` command in the command line interface.

## Managing the Email Queue

Cisco AsyncOS allows you to perform operations on messages in the email queue. You can delete, bounce, suspend, or redirect messages in the email queue. You can also locate, remove, and archive older messages in your queue.

## Deleting Recipients in Queue

If particular recipients are not being delivered or to clear the email queue, use the `deleterecipients` command. The `deleterecipients` command allows you to manage the email delivery queue by deleting specific recipients waiting for delivery. Recipients to be deleted are identified by either the recipient host that the recipient is destined for, or the message sender identified by the specific address given in the Envelope From line of the message envelope. Alternately, you can delete all messages in the delivery queue (all active recipients) at once.



---

**Note** To perform the `deleterecipients` function, it is recommended that you place the email gateway in an offline state or suspended delivery (see [Suspending Email Receiving and Delivery](#), on page 1002).

---



---

**Note** Although the function is supported in all states, certain messages may be delivered while the function is taking place.

---

Matches to recipient hosts and senders must be identical string matches. Wild cards are not accepted. The `deleterecipients` command returns the total number of messages deleted. In addition, if a mail log subscription (IronPort text format only) is configured, the message deletion is logged as a separate line.

## Example

```
mail3.example.com> deleterecipients
Please select how you would like to delete messages:
1. By recipient host.
2. By Envelope From address.
3. All.
[1]>
```

The email gateway gives you various options to delete recipients depending upon the need. The following example show deleting recipients by recipient host, deleting by Envelope From Address, and deleting all recipients in the queue.

### Delete by Recipient Domain

Please enter the hostname for the messages you wish to delete.

**Delete by Envelope From Address**

```
[ ]> example.com
Are you sure you want to delete all messages being delivered to "example.com"? [N]> Y
Deleting messages, please wait.
100 messages deleted.
```

**Delete by Envelope From Address**

```
Please enter the Envelope From address for the messages you wish to delete.
[ ]> mailadmin@example.com
Are you sure you want to delete all messages with the Envelope From address of
"mailadmin@example.com"? [N]> Y
Deleting messages, please wait.
100 messages deleted.
```

**Delete All**

```
Are you sure you want to delete all messages in the delivery queue (all active recipients)?
[N]> Y
Deleting messages, please wait.
1000 messages deleted.
```

## Bouncing Recipients in Queue

Similar to the `deleterecipients` command, the `bouncerecipients` command allows you to manage the email delivery queue by hard bouncing specific recipients waiting for delivery. Message bouncing follows regular bounce message configuration as specified in the `bounceconfig` command.



---

**Note** To perform the `bouncerecipients` function, it is recommended that you place the email gateway in an offline state or suspended delivery (see [Suspending Email Receiving and Delivery](#), on page 1002).

---



---

**Note** Although the function is supported in all states, certain messages may be delivered while the function is taking place.

---

Matches to recipient hosts and senders must be identical string matches. Wild cards are not accepted. The `bouncerecipients` command returns the total number of messages bounced.



---

**Note** The `bouncerecipients` function is resource-intensive and may take several minutes to complete. If in offline or suspended delivery state, the actual sending of bounce messages (if hard bounce generation is on) will begin only after Cisco AsyncOS is placed back into the online state by using the `resume` command.

---

## Example

```
mail3.example.com> bouncerecipients
Please select how you would like to bounce messages:
1. By recipient host.
```



```

2. By Envelope From address.
3. All.
[1]>

```

Recipients to be bounced are identified by either the destination recipient host or the message sender identified by the specific address given in the Envelope From line of the message envelope. Alternately, all messages in the delivery queue can be bounced at once.

### Bounce by Recipient Host

```

Please enter the hostname for the messages you wish to bounce.
[]> example.com
Are you sure you want to bounce all messages being delivered to "example.com"? [N]> Y
Bouncing messages, please wait.
100 messages bounced.

```

### Bounce by Envelope From Address

```

Please enter the Envelope From address for the messages you wish to bounce.
[]> mailadmin@example.com
Are you sure you want to bounce all messages with the Envelope From address of
"mailadmin@example.com"? [N]> Y
Bouncing messages, please wait.
100 messages bounced.

```

### Bounce All

```

Are you sure you want to bounce all messages in the queue? [N]> Y
Bouncing messages, please wait.
1000 messages bounced.

```

## Redirecting Messages in Queue

The `redirectrecipients` commands allow you to redirect all messages in the email delivery queue to another relay host. Please note that redirecting recipients to a host or IP address that is not prepared to accept large volumes of SMTP mail from this host will cause messages to bounce and possibly result in the loss of mail.



---

**Caution** Redirecting messages to a receiving domain that has `/dev/null` as its destination results in the loss of messages. The CLI does not display a warning if you redirect mail to such a domain. Check the SMTP route for the receiving domain before redirecting messages.

---

### Example

The following example redirects all mail to the `example2.com` host.

```

mail3.example.com> redirectrecipients
Please enter the hostname or IP address of the machine you want to send all mail to.
[]> example2.com
WARNING: redirecting recipients to a host or IP address that is not prepared to accept large
volumes of SMTP mail from this host will cause messages to bounce and possibly result in
the loss of mail.
Are you sure you want to redirect all mail in the queue to "example2.com"? [N]> y

```

```
Redirecting messages, please wait.
246 recipients redirected.
```

## Showing Messages Based on Recipient in Queue

Use the `showrecipients` command to show messages from the email delivery queue by recipient host or Envelope From address. You can also show all messages in the queue.

### Example

```
mail3.example.com> showrecipients
Please select how you would like to show messages:
1. By recipient host.
2. By Envelope From address.
3. All.
[1]> 3
Showing messages, please wait.
MID/      Bytes/      Sender/      Subject
[RID]     [Atmps]     Recipient
1527      1230        user123456@ironport.com Testing
[0]       [0]         9554@example.com
1522      1230        user123456@ironport.com Testing
[0]       [0]         3059@example.com
1529      1230        user123456@ironport.com Testing
[0]       [0]         7284@example.com
1530      1230        user123456@ironport.com Testing
[0]       [0]         8243@example.com
1532      1230        user123456@ironport.com Testing
[0]       [0]         1820@example.com
1531      1230        user123456@ironport.com Testing
[0]       [0]         9595@example.com
1518      1230        user123456@ironport.com Testing
[0]       [0]         8778@example.com
1535      1230        user123456@ironport.com Testing
[0]       [0]         1703@example.com
1533      1230        user123456@ironport.com Testing
[0]       [0]         3052@example.com
1536      1230        user123456@ironport.com Testing
[0]       [0]         511@example.com
```

The following example shows messages in the queue for all recipient hosts.

## Suspending Email Delivery

To temporarily suspend email delivery for maintenance or troubleshooting, use the `suspenddel` command. The `suspenddel` command puts Cisco AsyncOS into suspended delivery state. This state is characterized by the following:

- Outbound email delivery is halted.
- Inbound email connections are accepted.
- Log transfers continue.
- The CLI remains accessible.

The `suspenddel` command lets open outbound connections close, and it stops any new connections from opening. The `suspenddel` command commences immediately, and allows any established connections to successfully close. Use the `resumedel` command to return to regular operations from the suspended delivery state.



---

**Note** The “delivery suspend” state is preserved across system reboots. If you use the `suspenddel` command and then reboot the email gateway, you must resume delivery after the reboot using the `resumedel` command.

---

## Example

```
mail3.example.com> suspenddel
Enter the number of seconds to wait before abruptly closing connections.
[30]>
Waiting for outgoing deliveries to finish...
Mail delivery suspended.
```

## Resuming Email Delivery

The `resumedel` command returns Cisco AsyncOS to normal operating state after using the `suspenddel` command.

## Syntax

```
resumedel
```

```
mail3.example.com> resumedel
Mail delivery resumed.
```

## Suspending Receiving Email

To temporarily suspend all listeners from receiving email, use the `suspendlistener` command. While receiving is suspended, the system does not accept connections to the specific port of the listener.

This behavior has changed in this release of AsyncOS. In previous releases, the system would accept connections, respond with the following responses and disconnect:

- SMTP: 421 *hostname* Service not available, closing transaction channel
- QMQP: ZService not available



---

**Note** The “receiving suspend” state is preserved across system reboots. If you use the `suspendlistener` command and then reboot the email gateway, you must use the `resumelister` command before the listener will resume receiving messages.

---

## Syntax

```
suspendlistener mail3.example.com> suspendlistener
Choose the listener(s) you wish to suspend.
Separate multiple entries with commas.
1. All
2. InboundMail
3. OutboundMail
[1]> 1
```

```

Enter the number of seconds to wait before abruptly closing connections.
[30]>
Waiting for listeners to exit...
Receiving suspended.
mail3.example.com>

```

## Resuming Receiving Email

The `resumelistener` command returns Cisco AsyncOS to normal operating state after using the `suspendlistener` command.

### Syntax

```

resumelistener

mail3.example.com> resumelistener
Choose the listener(s) you wish to resume.
Separate multiple entries with commas.
1. All
2. InboundMail
3. OutboundMail
[1]> 1
Receiving resumed.
mail3.example.com>

```

## Resuming Delivery and Receiving of Email

The `resume` command resumes both delivery and receiving.

### Syntax

```

resume

mail3.example.com> resume
Receiving resumed.
Mail delivery resumed.
mail3.example.com>

```

## Scheduling Email for Immediate Delivery

Recipients and hosts that are scheduled for later delivery can be immediately retried by using the `delivernow` command. The `delivernow` command allows you to reschedule email in the queue for immediate delivery. All domains that are marked down and any scheduled or soft bounced messages are queued for immediate delivery.

The `delivernow` command can be invoked for all recipients or specific recipients in the queue (scheduled and active). When selecting specific recipients, you must enter the domain name of the recipients to schedule for immediate delivery. The system matches the entire string for character and length.

### Syntax

```

delivernow

```

```
mail3.example.com> delivernow
Please choose an option for scheduling immediate delivery.
1. By recipient host
2. All messages
[1]> 1
Please enter the domain to schedule for immediate delivery.
[]> recipient.example.com
Rescheduling all messages to recipient.example.com for immediate delivery.
mail3.example.com>
```

## Pausing the Work Queue

Processing for LDAP recipient access, masquerading, LDAP re-routing, Message Filters, anti-spam, and the anti-virus scanning engine are all performed in the “work queue.” Refer to [Configuring Routing and Delivery Features, on page 693](#) for the processing flow and [Reading the System Gauges, on page 1098](#) for a description of the “Messages in Work Queue” gauge. You can manually pause the work queue portion of message processing using the `workqueue` command.

For example, assume that you wanted to change the configuration of an LDAP server configuration while many messages are in the work queue. Perhaps you want to switch from bouncing to dropping messages based on an LDAP recipient access query. Or perhaps you want to pause the queue while you manually check for the latest anti-virus scanning engine definition files (via the `antivirusupdate` command). The `workqueue` command allows you to pause and resume the work queue to stop processing while you perform other configuration changes.

When you pause and resume the work queue, the event is logged. For example

```
Sun Aug 17 20:01:36 2003 Info: work queue paused, 1900 msgs S
Sun Aug 17 20:01:39 2003 Info: work queue resumed, 1900 msgs
```

In the following example, the work queue is paused:

```
mail3.example.com> workqueue
Status as of: Sun Aug 17 20:02:30 2003 GMT
Status: Operational
Messages: 1243
Choose the operation you want to perform:
- STATUS - Display work queue status
- PAUSE - Pause the work queue
- RATE - Display work queue statistics over time
[]> pause
Manually pause work queue? This will only affect unprocessed messages. [N]> y
Reason for pausing work queue:
[]> checking LDAP server
Status as of: Sun Aug 17 20:04:21 2003 GMT
Status: Paused by admin: checking LDAP server
Messages: 1243
```



---

**Note** Entering a reason is optional. If you do not enter a reason, the system logs the reason as “Manually paused by user.”

---

In this example, the work queue is resumed:

```
mail3.example.com> workqueue
```

```

Status as of: Sun Aug 17 20:42:10 2003 GMT
Status: Paused by admin: checking LDAP server
Messages: 1243
Choose the operation you want to perform:
- STATUS - Display work queue status
- RESUME - Resume the work queue
- RATE - Display work queue statistics over time
[ ]> resume
Status: Operational
Messages: 1243

```

## Locating and Archiving Older Messages

Sometimes older messages remain in the queue because they could not be delivered. You may want to remove and archive these messages. To do this, use the `showmessage` CLI command to display the message for the given message ID. Use the `oldmessage` CLI command to display the oldest non-quarantine message on the system. You can then optionally use the `removemessage` to safely remove the message for the given message ID. This command can only remove messages that are in the work queue, retry queue, or a destination queue. If the message is in none of these queues, it cannot be removed.

You can also use the `archivemessage[mid]` CLI command to archive the message for a given message ID into an mbox file in the configuration directory.

You cannot use the `oldmessage` command to get the message ID for a message in a quarantine. However, if you know the message ID, you can show or archive the specified message. Since the message is not in the work queue, retry queue, or a destination queue, you cannot remove the message with the `removemessage` command.



---

**Note** You cannot perform any of these queue management commands on a message in the Cisco Spam Quarantine.

---

## Syntax

```
archivemessage
```

```

example.com> archivemessage
Enter the MID to archive and remove.
[0]> 47
MID 47 has been saved in file oldmessage_47.mbox in the configuration directory
example.com>

```

## Syntax

```
oldmessage
```

```

example.com> oldmessage
MID 9: 1 hour 5 mins 35 secs old
Received: from example.com ([172.16.0.102])
  by example.com with SMTP; 14 Feb 2007 22:11:37 -0800
From: user123@example.com
To: 4031@test.example2.com

```

```
Subject: Testing
Message-Id: <20070215061136.68297.16346@example.com>
```

## Tracking Messages Within the System

The `findevent` CLI command simplifies the process of tracking messages within the system using the onbox mail log files. The `findevent` CLI command allows you to search through the mail logs for a particular message by searching for a message ID or a regular expression match against the subject header, envelope sender or envelope recipient. You can display results for the current log file, all the log files, or display log files by date. When you view log files by date, you can specify a date or a range of dates.

After you identify the message you want to view logs for, the `findevent` command displays the log information for that message ID including splintering information (split log messages, bounces and system generated messages). The following example shows the `findevent` CLI command tracking the receiving and delivery a message with “confidential” in the subject header:

```
example.com>
findevent
Please choose which type of search you want to perform:
1. Search by envelope FROM
2. Search by Message ID
3. Search by Subject
4. Search by envelope TO
[1]> 3
Enter the regular expression to search for.
[]> confidential
Currently configured logs:
1. "mail_logs" Type: "IronPort Text Mail Logs" Retrieval: FTP Poll
Enter the number of the log you wish to use for message tracking.
[]> 1
Please choose which set of logs to search:
1. All available log files
2. Select log files by date list
3. Current log file
[3]> 3
The following matching message IDs were found. Please choose one to
show additional log information:
1. MID 4 (Tue Jul 31 17:37:35 2007) sales: confidential
[1]> 1
Tue Jul 31 17:37:32 2007 Info: New SMTP ICID 2 interface Data 1 (172.19.1.86) address
10.251.20.180 reverse dns host unknown verified no
Tue Jul 31 17:37:32 2007 Info: ICID 2 ACCEPT SG None match ALL SBRS None
Tue Jul 31 17:37:35 2007 Info: Start MID 4 ICID 2
Tue Jul 31 17:37:35 2007 Info: MID 4 ICID 2 From: <user@example.com>
Tue Jul 31 17:37:35 2007 Info: MID 4 ICID 2 RID 0 To: <ljohnson@example02.com>
Tue Jul 31 17:37:35 2007 Info: MID 4 Subject 'sales: confidential'
Tue Jul 31 17:37:35 2007 Info: MID 4 ready 4086 bytes from <user@example.com>
Tue Jul 31 17:37:35 2007 Info: MID 4 matched all recipients for per-recipient policy DEFAULT
in the inbound table
Tue Jul 31 17:37:35 2007 Info: ICID 2 close
Tue Jul 31 17:37:37 2007 Info: MID 4 interim verdict using engine: CASE spam negative
Tue Jul 31 17:37:37 2007 Info: MID 4 using engine: CASE spam negative
Tue Jul 31 17:37:37 2007 Info: MID 4 interim AV verdict using Sophos CLEAN
Tue Jul 31 17:37:37 2007 Info: MID 4 antivirus negative
Tue Jul 31 17:37:37 2007 Info: MID 4 queued for delivery
Tue Jul 31 17:37:37 2007 Info: Delivery start DCID 0 MID 4 to RID [0]
Tue Jul 31 17:37:37 2007 Info: Message done DCID 0 MID 4 to RID [0]
Tue Jul 31 17:37:37 2007 Info: MID 4 RID [0] Response '/null'
Tue Jul 31 17:37:37 2007 Info: Message finished MID 4 done
```

# Monitoring System Health and Status Using SNMP

The AsyncOS operating system supports system status monitoring via SNMP (Simple Network Management Protocol). This release implements a read-only subset of MIB-II as defined in RFCs 1213 and 1907. (For more information on SNMP, see RFCs 1065, 1066, and 1067.) Please note:

- SNMP is **off** by default.
- When SNMP is enabled, the default version used is SNMPv3.
- SNMP SET operations (configuration) are not implemented.
- AsyncOS supports SNMPv1, v2, and v3.
- Passphrases for authentication and encryption should be different. The encryption algorithm must be AES only. The authentication algorithm must be SHA-1 only. The snmpconfig command “remembers” your passphrases the next time you run the command.
- The SNMPv3 username is: v3get

```
> snmpwalk -v 3 -l AuthNoPriv -u v3get -a SHA -A ironport mail.example.com
```

- If you use only SNMPv1 or SNMPv2, you must set a community string. The community string does not default to public .
- For SNMPv1 and SNMPv2, you must specify a network from which SNMP GET requests are accepted.
- If you use SNMPv3, you must select any one of the supported security levels shown in the following table:

Security Level	Authentication	Privacy
noAuthNoPriv	Yes The authentication is done using the SNMPv3 username.	No
authNoPriv	Yes The authentication is done using the SNMPv3 authentication passphrase.	No
authPriv	Yes The authentication is done using the SNMPv3 authentication passphrase.	Yes The privacy is activated using the SNMPv3 privacy passphrase.

- If you enable both SNMPv2 and SNMPv3, you must select the required version for traps.
- To use traps, an SNMP manager (not included in AsyncOS) must be running and its IP address entered as the trap target. (You can use a hostname, but if you do, traps will only work if DNS is working.)

Use the snmpconfig command to enable and configure SNMP monitoring for the email gateway. After you choose and configure values for an interface, the email gateway responds to SNMPv3 GET requests. These version 3 requests must include a matching passphrase. By default, version 1 and 2 requests are rejected. If enabled, version 1 and 2 requests must have a matching community string.



## MIB Files

The following MIB files for email gateways are available from <http://www.cisco.com/c/en/us/support/security/email-security-appliance/tsd-products-support-series-home.html>. Use the latest available MIB files.

- ASYNCOS-MAIL-MIB.txt — an SNMPv2 compatible description of the Enterprise MIB for email gateways.
- AsyncOS-SMI.txt (IRONPORT-SMI.txt) — a “Structure of Management Information” (SMI) file that defines the role of the ASYNCOS-MAIL-MIB in Cisco content security products.

## Hardware Objects

Hardware sensors conforming to the Intelligent Platform Management Interface Specification (IPMI) report information such as temperature, fan speed, and power supply status.

It is a good idea to poll for the hardware status and identify possible hardware failures before they become critical. Temperatures within 10 per cent of the critical value may be a cause for concern.

For information such as the number of power supplies and the range of operating temperatures for your email gateway, see the hardware guide for your model. For the location of hardware guides, see [Documentation](#), on page 4.

## Hardware Traps

Status change traps are sent when the status changes. Fan Failure and high temperature traps are sent every 5 seconds. The other traps are failure condition alarm traps — they are sent once when the state changes (healthy to failure).

For example, on C170 email gateways, traps are sent if the following thresholds are reached:

**Table 116: Hardware Traps on C170 Email Gateways: Temperature and Hardware Conditions**

Model	High Temp (CPU)	High Temp (Ambient)	High Temp (Backplane)	High Temp (Riser)	Fan Failure	Power Supply	RAID	Link
C170	90C	47C	NA	NA	0 RPMs	Status Change	Status Change	Status Change

To see the available traps and threshold values on your email gateway, run the `snmpconfig` command from the command-line interface.

Note that failure condition alarm traps represent a critical failure of the individual component, but may not cause a total system failure. For example, a single fan or power supply can fail on an email gateway with multiple fans or power supplies and the email gateway will continue to operate.

### Related Topics

- [Example: snmpconfig Command](#), on page 1122

## SNMP Traps

SNMP provides the ability to send traps, or notifications, to advise an administration application (an SNMP management console, typically) when one or more conditions have been met. Traps are network packets that contain data relating to a component of the system sending the trap. Traps are generated when a condition has been met on the SNMP agent (in this case, the email gateway). After the condition has been met, the SNMP agent then forms an SNMP packet and sends it to the host running the SNMP management console software.

To enable and configure SNMP traps, use the `snmpconfig` command.

To specify multiple trap targets: when prompted for the trap target, you may enter up to 10 comma separated IP addresses.

### Example: `snmpconfig` Command

In the following example, the `snmpconfig` command is used on a C690 hardware email gateway to enable SNMP on the “PublicNet” interface on port 161. The community string `public` is entered for GET requests from versions 1 and 2.

```
maill.example.com> snmpconfig

Current SNMP settings:
SNMP Disabled.

Choose the operation you want to perform:
- SETUP - Configure SNMP.
[]> setup

Do you want to enable SNMP? [Y]>
SNMP default version is V3

Choose an IP interface for SNMP requests.
1. Management (10.10.4.5/27: maill.example.com) [1]>

Which port shall the SNMP daemon listen on?
[161]>

Select SNMPv3 security level:
1. noAuthNoPriv - Authentication is done using the SNMPv3 username, and no privacy is
   activated.
2. authNoPriv - Authentication is done using the SNMPv3 authentication passphrase, and no
   privacy is activated.
3. authPriv - Authentication is done using the SNMPv3 authentication passphrase, and privacy
   is activated using the SNMPv3 privacy passphrase.
[3]>

Select SNMPv3 authentication type:
1. SHA
[1]>

Select SNMPv3 privacy protocol:
1. AES
[1]>

Enter the SNMPv3 authentication passphrase.
[]>

The SNMPv3 passphrase must be at least 8 characters.

Enter the SNMPv3 authentication passphrase.
[]>
```

```
Enter the SNMPv3 authentication passphrase again to confirm.
[ ]>

Enter the SNMPv3 privacy passphrase.
[ ]>

Enter the SNMPv3 privacy passphrase again to confirm.
[ ]>
Warning: The same authentication and privacy passwords reduce the security of the system.

Do you want to set other passwords? [Y]> n

Service SNMP V1/V2c requests? [N]> Y

Enter the SNMP V1/V2c community string.
[ironport]>

Shall SNMP V2c requests be serviced from IPv4 addresses? [Y]>

From which IPv4 networks shall SNMP V1/V2c requests be allowed? Separate multiple networks
with commas.
[127.0.0.1/32]>

Select the version for SNMP traps:
1. 2c
2. 3
[2]>

Enter the Trap target as a host name, IP address or list of IP addresses separated by commas
(IP address preferred). Enter "None" to disable traps.
[127.0.0.1]> 10.10.0.28

Enterprise Trap Status
1. CPUUtilizationExceeded Disabled
2. FIPSMoDeDisableFailure Enabled
3. FIPSMoDeEnableFailure Enabled
4. FailoverHealthy Enabled
5. FailoverUnhealthy Enabled
6. connectivityFailure Disabled
7. keyExpiration Enabled
8. linkUpDown Enabled
9. memoryUtilizationExceeded Disabled
10. resourceConservationMode Enabled
11. updateFailure Enabled

Do you want to change any of these settings? [N]>

Enter the System Location string.
[Unknown: Not Yet Configured]>

Enter the System Contact string.
[snmp@localhost]>

Current SNMP settings:
Listening on interface "Management" 10.10.4.5/27 port 161.
SNMP v3: Enabled.
Security level: authPriv
Authentication Protocol: SHA
Encryption Protocol: AES
SNMP v1/v2: Enabled, accepting requests from subnet 127.0.0.1/32, fe::1/64.
SNMP v1/v2 Community String: ironport
Trap version: V3
Trap target: 10.10.0.28
```

**Example: snmpconfig Command**

```
Location: Unknown: Not Yet Configured
System Contact: snmp@localhost

Choose the operation you want to perform:
- SETUP - Configure SNMP.
[]>
mail1.example.com > commit
```



## CHAPTER 41

# Improving Phishing Detection Efficacy using Service Logs

---

This chapter contains the following sections:

- [Overview, on page 1125](#)
- [Enabling Service Logs on Email Gateway, on page 1125](#)
- [Disabling Service Logs on Email Gateway, on page 1126](#)
- [Frequently Asked Questions, on page 1126](#)

## Overview

The Service Logs are used to collect personal data based on the [Cisco Email Security Appliance Data Sheet](#) guidelines.

The Service Logs are sent to the Cisco Talos Cloud service to improve Phishing detection.



---

**Note** From AsyncOS 13.5 onwards, Service Logs replaces senderbase as the telemetry data that is sent to Cisco Talos Cloud service.

---

The email gateway collects limited personal data from customer emails and offers extensive useful threat detection capabilities that can be coupled with dedicated analysis systems to collect, trend, and correlate observed threat activity. Cisco uses the personal data to improve your email gateway capabilities to analyze the threat landscape, provide threat classification solutions on malicious emails, and to protect your email gateway from new threats such as spam, virus, and directory harvest attacks.

## Enabling Service Logs on Email Gateway

### Procedure

---

- Step 1** Go to **Security Services > Service Logs**.
- Step 2** Click **Edit Global Settings**.

**Step 3** Check the **Enable sharing limited data with the Service Logs Information Service (Recommended)** check box.

Checking this box enables the feature globally for the email gateway. When enabled, the Context Adaptive Scanning Engine (CASE) is used to collect and report the data (regardless of whether or not Cisco anti-spam scanning is enabled). You can configure the same settings using the `servicelogsconfig` command in the CLI

**Step 4** Click **Submit** and commit your changes.

## Disabling Service Logs on Email Gateway

### Procedure

**Step 1** Go to **Security Services > Service Logs**.

**Step 2** Click **Disable** and commit your changes.

## Frequently Asked Questions

Cisco recognizes that privacy is important to you, so we design and operate our services with the protection of your privacy in mind. If you enroll to Cisco Talos Cloud service, Cisco will collect aggregated statistics about your organization's email traffic; however, we do not collect or use any personally identifiable information. Any information Cisco collects that would identify your users or your organization will be treated as confidential.

## What data do I share?

The data is summarized information on message attributes and information on how different types of messages were handled by email gateways. We do not collect the full body of the message. Again, information provided to Cisco that would identify your users or your organization will be treated as confidential. (See [What does Cisco do to make sure that the data I share is secure?](#), on page 1127 below).

The following tables explain a sample log entry in a “human-friendly” format.

**Table 117: Statistics Shared per Email Message Information**

Item	Sample Data
GUID for the inbound SMTP connection	0FyIkNX8ThST1 /IdfyNshg==
GUID for the email message	1Hss77LIS6u7y5 GDn0QFEQ==
Cisco Secure Email Gateway message ID	5191655

Item	Sample Data
Number of recipients and their validity	1
Scanner verdicts from non-Cisco Talos engines (for example, Anti-Virus or Advanced Malware Protection)	4
Message disposition	MSG_DISP_DROPPED
Message disposition reason	MSG_DISP_FILTER
Is the message for outbound delivery?	true
Message size	35100
Incoming mail relay	true
Mail flow direction	IP_DIR_OUT
AMP verdict information	file_sha2_256: "\217\263\037\004\374`N \3264\265\016\314\227\005E\337\373q \177A\245 \017\004\204\340\231\260!^
Sampling of dropped messages	true

**Table 118: Statistics Shared per Periodic Configuration Information**

Item	Sample Data
Outbreak Filters feature enabled	true
Sender Domain Reputation (SDR) disabled flag	true
Context Adaptive Scanning Engine (CASE) version	3.8.5-036
Talos engine	1.95.0.220
Generic list of enabled features	Sophos_enabled

## What does Cisco do to make sure that the data I share is secure?

If you agree to enroll to Cisco Talos Cloud service:

- Data sent from your email gateways will be sent to the Cisco Talos Cloud service using the secure gRPC/HTTP2 protocol.
- All customer data will be handled with care at Cisco. This data will be stored in a secure location and access to the data will be limited to employees and contractors at Cisco who require access in order to improve the company's email security products and services or provide customer support.
- No information identifying email recipients or the customer's company will be shared outside of Cisco Systems when reports or statistics are generated based on the data.

## Will sharing data impact the performance of my Cisco email gateways?

Cisco believes that there will be a minimal performance impact for most customers. We record data that already exists as part of the mail delivery process. Customer data is then aggregated on the email gateway and sent to Cisco Talos Cloud service. We anticipate that the total size of data transferred via HTTPS will be less than 1% of the bandwidth of a typical company's email traffic.

When enabled, the Context Adaptive Scanning Engine (CASE) is used to collect and report the data (regardless of whether or not Cisco anti-spam scanning is enabled).

If you have additional questions, please contact Cisco Customer Support. See [Cisco Support Community](#), on page 6.

## Are there other ways I can share data?

For customers wanting to do even more to help Cisco provide top quality security services, there is a command that allows you to share additional data. This higher level of data sharing will also provide attachment filenames in clear, unhashed text, as well as hostnames of URLs in messages. If you are interested in learning more about this feature, please talk to your Systems Engineer or contact Cisco Customer Support.





## CHAPTER 42

# Other Tasks in the GUI

---

This chapter contains the following sections:

- [The Graphical User Interface \(GUI\), on page 1129](#)
- [System Information in the GUI , on page 1130](#)
- [Gathering XML status from the GUI, on page 1130](#)

## The Graphical User Interface (GUI)

The graphical user interface (GUI) is the web-based alternative to some command line interface (CLI) commands for system monitoring and configuration. The GUI enables you to monitor the system using a simple Web-based interface without having to learn the AsyncOS command syntax. After HTTP and/or HTTPS services have been enabled for an interface, you can access the GUI and log in. See the “Accessing the Email Gateway” chapter for more information.

## Enabling the GUI on an Interface

By default, the system ships with HTTP enabled on the Management interface.

To enable the GUI, execute the `interfaceconfig` command at the command-line interface, edit the interface that you want to connect to, and then enable the HTTP services or secure HTTP services, or both.



---

**Note** You can also use the Network > IP Interfaces page to enable or disable the GUI on an interface, once you have the GUI enabled on any other interface. See [IP Interfaces, on page 1303](#) for more information.

---



---

**Note** Enabling secure HTTP on an interface requires you to install a certificate. For more information, see “Enabling a Certificate for HTTPS.”

---

For either service, you specify the port on which you want the service to be enabled. By default, HTTP is enabled on port 80 and HTTPS on port 443. If you enable both services for an interface, you can automatically redirect HTTP requests to the secure service.

In addition, all users (see [Working with User Accounts, on page 973](#)) who attempt to access the GUI on this interface (either via HTTP or HTTPS ) must authenticate themselves via a standard username and passphrase login page.



**Note** You must save the changes by using the commit command before you are able to access the GUI.

In the following example, the GUI is enabled for the Data 1 interface. The interfaceconfig command is used to enable HTTP on port 80 and HTTPS on port 443. (The demonstration certificate is temporarily used for HTTP until the certconfig command can be run. For more information, see “Installing Certificates on the Email Gateway.”) HTTP requests to port 80 are configured to be automatically redirected to port 443 for the Data1 interface.

## System Information in the GUI

- On the **System Overview** page, you can:
  - View historical graphs and tables showing some of the key system status and performance information.
  - View the version of the AsyncOS operating system installed on the email gateway.
  - View a subset of key statistics.
- The **System Status** page provides a detailed representation of all real-time mail and DNS activity for the system. You can also reset the counters for system statistics and view the last time the counters were reset.

## Gathering XML status from the GUI

View status through XML pages, or access XML status information programmatically.

The XML Status feature provides a programmatic method to access email monitoring statistics. Note that some newer browsers can also render XML data directly.

Information from the pages in the GUI in this table is also available as dynamic XML output by accessing the corresponding URL:

GUI Page Name	Corresponding XML status URL
Mail Status	<code>http:// hostname /xml/status</code>
Host Mail Status for a Specified Host	<code>http:// hostname /xml/hoststatus?hostname= host</code>
DNS Status	<code>http:// hostname /xml/dnsstatus</code>
Top Incoming Domains	<code>http:// hostname /xml/topin</code>
Top Outgoing Domains <sup>1</sup>	<code>http:// hostname /xml/tophosts</code>

<sup>1</sup> The default sort order for this page is by number of active recipients. You can change the order by appending “?sort= order ” to the URL, where order is conn\_out , deliv\_recip , soft\_bounced , or hard\_bounced .



# CHAPTER 43

## Advanced Network Configuration

---

This chapter contains the following sections:

- [Media Settings on Ethernet Interfaces, on page 1131](#)
- [Network Interface Card Pairing/Teaming, on page 1132](#)
- [Virtual Local Area Networks \(VLANs\), on page 1135](#)
- [Direct Server Return, on page 1139](#)
- [Ethernet Interface's Maximum Transmission Unit, on page 1143](#)
- [Accept or Reject ARP Replies with a Multicast Address, on page 1144](#)

### Media Settings on Ethernet Interfaces

Media settings for the ethernet interfaces can be accessed via the use of the etherconfig command. Each ethernet interface is listed with its current setting. By selecting the interface, the possible media settings are displayed. See [Example of Editing Media Settings, on page 1131](#) for an example.

### Using etherconfig to Edit Media Settings on Ethernet Interfaces

The etherconfig command can be used to set the duplex settings (full/half) as well as the speed (10/100/1000 Mbps) of ethernet interfaces. By default, interfaces automatically select the media settings; however, in some cases you may wish to override this setting.



---

**Note** If you have completed the GUI's System Setup Wizard (or the Command Line Interface systemsetup command) as described in the "Setup and Installation" chapter and committed the changes, the default ethernet interface settings should already be configured on your email gateway.

---

Some email gateways contain a fiber optic network interface option. If available, you will see two additional ethernet interfaces (Data 3 and Data 4) in the list of available interfaces on these email gateways. These gigabit fiber optic interfaces can be paired with the copper (Data 1, Data 2, and Management) interfaces in a heterogeneous configuration. See [Network Interface Card Pairing/Teaming, on page 1132](#).

### Example of Editing Media Settings

```
mail3.example.com> etherconfig
```

```

Choose the operation you want to perform:
- MEDIA - View and edit ethernet media settings.
- PAIRING - View and configure NIC Pairing.
- VLAN - View and configure VLANs.
- LOOPBACK - View and configure Loopback.
- MTU - View and configure MTU.
- MULTICAST - Accept or reject ARP replies with a multicast address.

[ ]> media
Ethernet interfaces:
1. Data 1 (Autoselect: <100baseTX full-duplex>) 00:06:5b:f3:ba:6d
2. Data 2 (Autoselect: <100baseTX full-duplex>) 00:06:5b:f3:ba:6e
3. Management (Autoselect: <100baseTX full-duplex>) 00:02:b3:c7:a2:da

Choose the operation you want to perform:
- EDIT - Edit an ethernet interface.
[ ]> edit
Enter the name or number of the ethernet interface you wish to edit.
[ ]> 2
Please choose the Ethernet media options for the Data 2 interface.
1. Autoselect
2. 10baseT/UTP half-duplex
3. 10baseT/UTP full-duplex
4. 100baseTX half-duplex

5. 100baseTX full-duplex

6. 1000baseTX half-duplex
7. 1000baseTX full-duplex
[1 ]> 5
Ethernet interfaces:
1. Data 1 (Autoselect: <100baseTX full-duplex>) 00:06:5b:f3:ba:6d
2. Data 2 (100baseTX full-duplex: <100baseTX full-duplex>) 00:06:5b:f3:ba:6e
3. Management (Autoselect: <100baseTX full-duplex>) 00:02:b3:c7:a2:da
Choose the operation you want to perform:
- EDIT - Edit an ethernet interface.
[ ]>
Choose the operation you want to perform:
- MEDIA - View and edit ethernet media settings.
- PAIRING - View and configure NIC Pairing.
- VLAN - View and configure VLANs.
- LOOPBACK - View and configure Loopback.
- MTU - View and configure MTU.
- MULTICAST - Accept or reject ARP replies with a multicast address.
[ ]>

```

## Network Interface Card Pairing/Teaming

NIC pairing allows you to combine any two physical data ports in order to provide a backup Ethernet interface if the data path from the NIC to the upstream Ethernet port should fail. Basically, pairing configures the Ethernet interfaces so that there is a primary interface and a backup interface. If the primary interface fails (i.e. if the carrier between the NIC and the upstream node is disrupted), the backup interface becomes active and an alert is sent. When the primary interface is up again, this interface will become active automatically. Within the documentation for this product, NIC pairing is synonymous with NIC teaming.



---

**Note** NIC pairing is not available on C170, C190 and C195 email gateways.

---

You can create more than one NIC pair, providing you have enough data ports. When creating pairs, you can combine any two data ports. For example:

Data 1 and Data 2

Data 3 and Data 4

Data 2 and Data 3

etc.

Some email gateways contain a fiber optic network interface option. If available, you will see two additional ethernet interfaces (Data 3 and Data 4) in the list of available interfaces on these email gateways. These gigabit fiber optic interfaces can be paired with the copper (Data 1, Data 2, and Management) interfaces in a heterogeneous configuration.

## NIC Pairing and VLANs

VLANs (see [Virtual Local Area Networks \(VLANs\), on page 1135](#)) are only allowed on the primary interface.

## NIC Pair Naming

When creating NIC pairs, you must specify a name to use to refer to the pair. NIC pairs created in versions of AsyncOS prior to version 4.5 will automatically receive the default name of 'Pair 1' following an upgrade.

Any alerts generated regarding NIC pairing will reference the specific NIC pair by name.

## NIC Pairing and Existing Listeners

If you enable NIC pairing on an interface that has listeners assigned to it, you are prompted to either delete, reassign, or disable all listeners assigned to the backup interface.

## Enabling NIC Pairing via the etherconfig Command



---

**Note** NIC pairing is not available on C170, C190 and C195 email gateways.

---

```
mail3.example.com> etherconfig
```

Choose the operation you want to perform:

- MEDIA - View and edit ethernet media settings.
- PAIRING - View and configure NIC Pairing.
- VLAN - View and configure VLANs.
- LOOPBACK - View and configure Loopback.

```
- MTU - View and configure MTU.
- MULTICAST - Accept or reject ARP replies with a multicast address.

[]> pairing

Paired interfaces:

Choose the operation you want to perform:

- NEW - Create a new pairing.

[]> new

Please enter a name for this pair (Ex: "Pair 1"):

[]> Pair 1

Warning: The backup (Data 2) for the NIC Pair is currently configured with one or more
IP addresses. If you continue, the Data 2 interface will be deleted.

Do you want to continue? [N]> y

The interface you are deleting is currently used by listener "OutgoingMail".

What would you like to do?

1. Delete: Remove the listener and all its settings.
2. Change: Choose a new interface.
3. Ignore: Leave the listener configured for interface "Data 2" (the listener will be
disabled until you add a new interface named "Data 2" or edit the listener's settings).

[1]>

Listener OutgoingMail deleted for mail3.example.com.

Interface Data 2 deleted.

Paired interfaces:

1. Pair 1:

Primary (Data 1) Active, Link is up
Backup (Data 2) Standby, Link is up

Choose the operation you want to perform:

- DELETE - Delete a pairing.
- STATUS - Refresh status.

[]>
```

## Virtual Local Area Networks (VLANs)

You can configure multiple virtual local area networks (VLANs) on any physical network port on the email gateway.

You can use VLANs to:

- Increase the number of networks the email gateway can connect to beyond the number of physical interfaces on the email gateway.
- Allow more networks to be defined on separate “ports” on existing listeners.
- Segment networks for security purposes, to ease administration, or increase bandwidth.

Example use case:

Two mail servers that are unable to communicate directly due to VLAN limitations can send mail through the email gateway. The Data 2 interface on the email gateway is configured with VLAN1 and VLAN2. The blue line shows mail coming from the sales network (VLAN1) to the appliance. The email gateway processes the mail as normal and then, upon delivery, tags the packets with the destination VLAN2 information (red line).

Using VLANs to Facilitate Communication Between Email Gateways

**Figure 76: Using VLANs to Facilitate Communication Between Email Gateways**

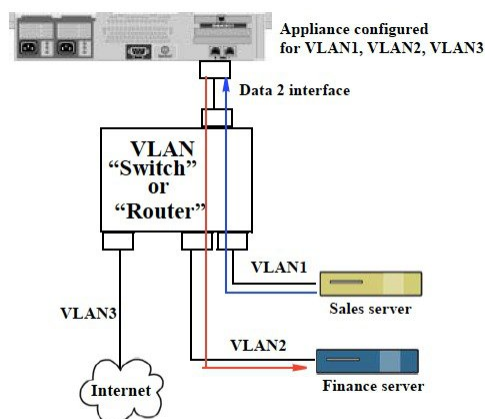

## About Configuring VLANs

You can configure multiple VLANs on any physical network port on the email gateway, including “Data” and “Management” ports and the fiber optic data ports available on some email gateway models. AsyncOS supports up to 30 VLANs.

A physical port does not need an IP address configured in order to be in a VLAN. The physical port on which a VLAN is created can have an IP that will receive non-VLAN traffic, so you can have both VLAN and non-VLAN traffic on the same interface.

VLANs can be used with NIC pairing (available on paired NICs) and with Direct Server Return (DSR).

VLANs appear as dynamic “Data Ports” labeled in the format of: “VLAN DDDD” where the “DDDD” is the ID and is an integer up to 4 digits long (VLAN 2, or VLAN 4094 for example). VLAN IDs must be unique on your appli email gateway.

### Related Topics

[FTP, SSH, and SCP Access, on page 1303](#)

## Managing VLANs

You can create, edit and delete VLANs via the etherconfig command. Once created, a VLAN can be configured via the Network > Interfaces page or the interfaceconfig command in the CLI. Remember to commit all changes.

### Creating a New VLAN via the etherconfig Command

In this example, two VLANs are created (named VLAN 31 and VLAN 34) on the Data 1 port:

```
mail3.example.com> etherconfig
```

```
Choose the operation you want to perform:
```

- MEDIA - View and edit ethernet media settings.
- PAIRING - View and configure NIC Pairing.
- VLAN - View and configure VLANs.
- LOOPBACK - View and configure Loopback.
- MTU - View and configure MTU.
- MULTICAST - Accept or reject ARP replies with a multicast address.

```
[>] vlan
```

```
VLAN interfaces:
```

```
Choose the operation you want to perform:
```

- NEW - Create a new VLAN.

```
[>] new
```

```
VLAN ID for the interface (Ex: "34"):
```

```
[>] 34
```

```
Enter the name or number of the ethernet interface you wish bind to:
```

1. Data 1
2. Data 2
3. Management

```
[1]> 1
```

```
VLAN interfaces:
```

1. VLAN 34 (Data 1)

```
Choose the operation you want to perform:
```



```
- NEW - Create a new VLAN.
- EDIT - Edit a VLAN.
- DELETE - Delete a VLAN.

[ ]> new
VLAN ID for the interface (Ex: "34"):

[ ]> 31
Enter the name or number of the ethernet interface you wish bind to:

1. Data 1
2. Data 2
3. Management

[1]> 1
VLAN interfaces:

1. VLAN 31 (Data 1)
2. VLAN 34 (Data 1)

Choose the operation you want to perform:

- NEW - Create a new VLAN.
- EDIT - Edit a VLAN.
- DELETE - Delete a VLAN.

[ ]>

Choose the operation you want to perform:

- MEDIA - View and edit ethernet media settings.
- PAIRING - View and configure NIC Pairing.
- VLAN - View and configure VLANs.
- LOOPBACK - View and configure Loopback.
- MTU - View and configure MTU.
- MULTICAST - Accept or reject ARP replies with a multicast address.

[ ]>
```

## Creating an IP Interface on a VLAN via the interfaceconfig Command

In this example, a new IP interface is created on the VLAN 31 ethernet interface. Making changes to an interface may close your connection to the email gateway.

```
mail3.example.com> interfaceconfig

Currently configured interfaces:

1. Data 1 (10.10.1.10/24: example.com)
2. Management (10.10.0.10/24: example.com)

Choose the operation you want to perform:

- NEW - Create a new interface.
- EDIT - Modify an interface.
- GROUPS - Define interface groups.
- DELETE - Remove an interface.

[ ]> new

Please enter a name for this IP interface (Ex: "InternalNet"):

[ ]> InternalVLAN31

Would you like to configure an IPv4 address for this interface (y/n)? [Y]>

IPv4 Address (Ex: 10.10.10.10):

[ ]> 10.10.31.10

Netmask (Ex: "255.255.255.0" or "0xffffffff00"):

[255.255.255.0]>

Would you like to configure an IPv6 address for this interface (y/n)? [N]>

Ethernet interface:

1. Data 1
2. Data 2
3. Management
4. VLAN 31
5. VLAN 34

[1]> 4

Hostname:

[ ]> mail31.example.com

Do you want to enable SSH on this interface? [N]>

Do you want to enable FTP on this interface? [N]>

Do you want to enable HTTP on this interface? [N]>

Do you want to enable HTTPS on this interface? [N]>
```

```
Currently configured interfaces:

1. Data 1 (10.10.1.10/24: example.com)

2. InternalVLAN31 (10.10.31.10/24: mail31.example.com)

3. Management (10.10.0.10/24: example.com)

Choose the operation you want to perform:

- NEW - Create a new interface.

- EDIT - Modify an interface.

- GROUPS - Define interface groups.

- DELETE - Remove an interface.

[ ]>
```

## Configuring VLANs Using the Web Interface

After a VLAN is created using the etherconfig command, you can configure it using the Network > Listeners page.

## Direct Server Return

Direct Server Return (DSR) is a way of providing support for a light-weight load balancing mechanism to load balance between multiple email gateways sharing the same Virtual IP (VIP).

DSR is implemented via an IP interface created on the “loopback” ethernet interface on the email gateway.



---

**Note** Configuring load balancing for email gateways is beyond the scope of this document

---

## Enabling Direct Server Return

Enable DSR by enabling the “loopback” ethernet interface on each participating email gateway. Next, create an IP interface on the loopback interface with a virtual IP (VIP) via the **interfaceconfig** command in the CLI or via the Network > Interfaces page in the GUI. Finally, create a listener on the new IP interface via the **listenerconfig** command in the CLI or via the Network > Listeners page in the GUI. Remember to commit all changes.



---

**Note** Using the loopback interface prevents the email gateway from issuing ARP replies for that specific interface

---

When enabling DSR, the following rules apply:

All systems use the same Virtual IP (VIP) address

All systems must be on the same switch and subnet as the load balancer

**Figure 77: Using DSR to Load Balance Between Multiple Email Gateways on a Switch**

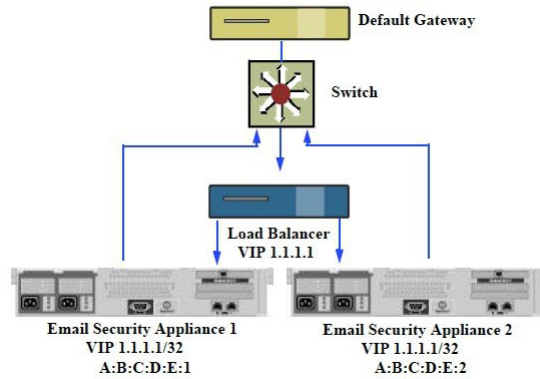

Using DSR to Load Balance Between Multiple Email Gateways on a Switch

## Enabling the Loopback Interface via the etherconfig Command

Once enabled, the loopback interface is treated like any other interface (e.g. Data 1):

```
mail3.example.com> etherconfig
```

Choose the operation you want to perform:

- MEDIA - View and edit ethernet media settings.
- PAIRING - View and configure NIC Pairing.
- VLAN - View and configure VLANs.
- LOOPBACK - View and configure Loopback.
- MTU - View and configure MTU.
- MULTICAST - Accept or reject ARP replies with a multicast address.

```
[> loopback
```

Currently configured loopback interface:

Choose the operation you want to perform:

- ENABLE - Enable Loopback Interface.

```
[> enable
```

Currently configured loopback interface:

```
1. Loopback
```

Choose the operation you want to perform:

- DISABLE - Disable Loopback Interface.

```
[>
```

Choose the operation you want to perform:

```
- MEDIA - View and edit ethernet media settings.
- PAIRING - View and configure NIC Pairing.
- VLAN - View and configure VLANs.
- LOOPBACK - View and configure Loopback.
- MTU - View and configure MTU.
- MULTICAST - Accept or reject ARP replies with a multicast address.

[]>
```

## Creating an IP Interface on Loopback via the interfaceconfig Command

Create an IP interface on the loopback interface:

```
mail3.example.com> interfaceconfig
Currently configured interfaces:
1. Data 1 (10.10.1.10/24: example.com)
2. InternalV1 (10.10.31.10/24: mail31.example.com)
3. Management (10.10.0.10/24: example.com)
Choose the operation you want to perform:
- NEW - Create a new interface.
- EDIT - Modify an interface.
- GROUPS - Define interface groups.
- DELETE - Remove an interface.

[]> new
Please enter a name for this IP interface (Ex: "InternalNet"):

[]> LoopVIP
Would you like to configure an IPv4 address for this interface (y/n)? [Y]>
IPv4 Address (Ex: 10.10.10.10):

[]> 10.10.1.11
Netmask (Ex: "255.255.255.0" or "0xffffffff00"):

[255.255.255.0]> 255.255.255.255
Would you like to configure an IPv6 address for this interface (y/n)? [N]>
Ethernet interface:
1. Data 1
2. Data 2
```

```
3. Loopback
4. Management
5. VLAN 31
6. VLAN 34
[1]> 3
Hostname:
[]> example.com
Do you want to enable SSH on this interface? [N]>
Do you want to enable FTP on this interface? [N]>
Do you want to enable HTTP on this interface? [N]>
Do you want to enable HTTPS on this interface? [N]>
Currently configured interfaces:
1. Data 1 (10.10.1.10/24: example.com)
2. InternalV1 (10.10.31.10/24: mail31.example.com)
3. LoopVIP (10.10.1.11/24: example.com)
4. Management (10.10.0.10/24: example.com)
Choose the operation you want to perform:
- NEW - Create a new interface.
- EDIT - Modify an interface.
- GROUPS - Define interface groups.
- DELETE - Remove an interface.
[]>
```

## Creating a Listener on the New IP Interface

Create a listener on the new IP interface via the GUI or the CLI. For example, the following figure shows the newly created IP interface available in the Add Listener page in the GUI.

Figure 78: Creating a Listener on the New Loopback IP Interface

**Add Listener**

Listener Settings	
Name:	<input type="text"/>
Type of Listener:	<input checked="" type="radio"/> Public <input type="radio"/> Private
Interface:	Data 1 (10.10.1.10/24; example.com) TCP Port: 25
Bounce Profile:	Data 1 (10.10.1.10/24; example.com) InternalV1 (10.10.31.10/24; mail31.example.com)
Disclaimer Above:	LoopVIP (10.10.11.10/24; mail11.example.com) Management (10.10.2.10/24; example.com) <small>Disclaimer text will be applied above the message body.</small>
Disclaimer Below:	None <small>Disclaimer text will be applied below the message body.</small>
SMTP Authentication Profile:	None
Certificate:	System Default
▶ SMTP Address Parsing Options:	Optional settings for controlling parsing in SMTP "MAIL FROM" and "RCPT TO"
▶ Advanced:	Optional settings for customizing the behavior of the Listener
▶ LDAP Queries:	No LDAP Server Profiles have been created. Profiles can be defined at System Administration > LDAP
SMTP Call-Ahead Profile:	None

Cancel Submit

## Ethernet Interface's Maximum Transmission Unit

The maximum transmission unit (MTU) is the largest unit of data that an ethernet interface will accept. You can decrease the MTU for an ethernet interface using the etherconfig command. The default MTU size is 1500 bytes, which is the largest MTU that the ethernet interface can accept.

To edit an interface's MTU:

```
mail3.example.com> etherconfig
```

Choose the operation you want to perform:

- MEDIA - View and edit ethernet media settings.
- PAIRING - View and configure NIC Pairing.
- VLAN - View and configure VLANs.
- LOOPBACK - View and configure Loopback.
- MTU - View and configure MTU.
- MULTICAST - Accept or reject ARP replies with a multicast address.

```
[ ]> mtu
```

Ethernet interfaces:

1. Data 1 mtu 1400
2. Data 2 default mtu 1500
3. Management default mtu 1500

Choose the operation you want to perform:

```

- EDIT - Edit an ethernet interface.

[]> edit

Enter the name or number of the ethernet interface you wish to edit.

[]> 2

Please enter a non-default (1500) MTU value for the Data 2 interface.

[]> 1200

Ethernet interfaces:

1. Data 1 mtu 1400

2. Data 2 mtu 1200

3. Management default mtu 1500

Choose the operation you want to perform:

- EDIT - Edit an ethernet interface.

[]>

```

## Accept or Reject ARP Replies with a Multicast Address

You can now specify whether to accept or reject ARP replies with a multicast address. Use the MULTICAST subcommand to configure this functionality.

The following example shows how to configure your email gateway to accept ARP replies with a multicast address:

```

mail.example.com> etherconfig
Choose the operation you want to perform:
- MEDIA - View and edit ethernet media settings.
- VLAN - View and configure VLANs.
- LOOPBACK - View and configure Loopback.
- MTU - View and configure MTU.
- MULTICAST - Accept or reject ARP replies with a multicast address.
[]> multicast
ARP replies with a multicast address will be rejected.
Choose the operation you want to perform:
- ACCEPT - Accept ARP replies with a multicast address.
[]> accept
ARP replies with a multicast address will be accepted.

```





## CHAPTER 44

# Logging

---

This chapter contains the following sections:

- [Overview, on page 1145](#)
- [Log Types, on page 1157](#)
- [Log Subscriptions, on page 1212](#)

## Overview

- [Understanding Log Files and Log Subscriptions, on page 1145](#)
- [Log Types, on page 1145](#)
- [Log Retrieval Methods, on page 1153](#)

## Understanding Log Files and Log Subscriptions

Logs are a compact, efficient method of gathering critical information about the email operations of AsyncOS. These logs record information regarding activity on your email gateway. The information will vary depending upon the log you view, for example, Bounce logs or Delivery logs.

Most logs are recorded in plain text (ASCII) format; however, delivery logs are formatted in binary for resource efficiency. The ASCII text information is readable in any text editor.

Cisco offers the M-Series Cisco Secure Manager Email and Web Gateway for centralized reporting and tracking tool for logs from multiple email gateways. See your Cisco representative for more information.

A log subscription associates a log type with a name, logging level, and other constraints such as size and destination information; multiple subscriptions for the same log type are permitted.

## Log Types

The log type indicates what information will be recorded within the generated log such as message data, system statistics, binary or textual data. You select the log type when creating a log subscription. See [Log Subscriptions, on page 1212](#) for more information.

AsyncOS generates the following log types:

Table 119: Log Types

Log	Description
Text Mail Logs	Text mail logs record information regarding the operations of the email system. For example, message receiving, message delivery attempts, open and closed connections, bounces, TLS connections, and others.
qmail Format Mail Logs	qmail format delivery logs record the same information regarding the operations of the email system as delivery logs following, but stored in qmail format.
Delivery Logs	Delivery logs record critical information about the email delivery operations of the email gateway — for example, information regarding each recipient delivery and bounce at the time of the delivery attempt. The log messages are “stateless,” meaning that all associated information is recorded in each log message and users need not reference previous log messages for information about the current delivery attempt. Delivery logs are recorded in a binary format for resource efficiency. Delivery Log files must be post-processed using a provided utility to convert them to XML or CSV (comma-separated values) format. The conversion tools are located at: <a href="https://supportforums.cisco.com/document/33721/cisco-ironport-systems-contributed-tools">https://supportforums.cisco.com/document/33721/cisco-ironport-systems-contributed-tools</a>
Bounce Logs	Bounce logs record information about bounced recipients. The information recorded for each bounced recipient includes: the message ID, the recipient ID, the Envelope From address, the Envelope To address, the reason for the recipient bounce, and the response code from the recipient host. In addition, you can choose to log a fixed amount of each bounced recipient message. This amount is defined in bytes and the default is zero.
Status Logs	This log file records system statistics found in the CLI status commands, including status detail and dnsstatus . The period of recording is set using the setup subcommand in logconfig . Each counter or rate reported in status logs is the value since the last time the counter was reset.
Domain Debug Logs	Domain debug logs record the client and server communication during an SMTP conversation between the email gateway and a specified recipient host. This log type can be used to debug issues with specific recipient hosts. You must specify the total number of SMTP sessions to record in the log file. As sessions are recorded, this number decreases. You can stop domain debug before all sessions have been recorded by deleting or editing the log subscription.
Injection Debug Logs	Injection debug logs record the SMTP conversation between the email gateway and a specified host connecting to the system. Injection debug logs are useful for troubleshooting communication problems between the Email Security appliance and a host on the Internet.
System Logs	System logs record the following: boot information, virtual email gateway license expiration alerts, DNS status information, and comments users typed using commit command. System logs are useful for troubleshooting the basic state of the email gateway.
CLI Audit Logs	The CLI audit logs record all CLI activity on the system.

Log	Description
FTP Server Logs	FTP logs record information about the FTP services enabled on the interface. Connection details and user activity are recorded.
GUI Logs	See HTTP Logs.
HTTP Logs	<p>HTTP logs record information about the HTTP and/or secure HTTP services enabled on the interface. Because the graphical user interface (GUI) is accessed via HTTP, the HTTP logs are ostensibly the GUI equivalent of the CLI Audit logs. Session data (new session, session expired) and pages accessed in the GUI are recorded.</p> <p>These logs also include information about SMTP transactions, for example information about scheduled reports emailed from the email gateway.</p>
NTP Logs	NTP logs record the conversation between the email gateway and any NTP (Network Time Protocol) servers configured. For more information, see “Editing the Network Time Protocol (NTP) Configuration (Time Keeping Method)” in the “System Administration” chapter.
LDAP Debug Logs	LDAP debug logs are meant for debugging LDAP installations. (See the “LDAP Queries” chapter.) Useful information about the queries that the email gateway is sending to the LDAP server are recorded here. For more information, see
Anti-Spam Logs	Anti-spam logs record the status of the anti-spam scanning feature of your system, including the status on receiving updates of the latest anti-spam rules. Also, any logs related to the Context Adaptive Scanning Engine are logged here.
Anti-Spam Archive	If you enabled an Anti-Spam scanning feature, messages that are scanned and associated with the “archive message” action are archived here. The format is an mbox-format log file. For more information about anti-spam engines, see the “Anti-Spam” chapter.
Graymail Engine Logs	Contains information about the graymail engine, status, configuration, and so on. Most information is at Info or Debug level.
Graymail Archive	Contains archived messages (the messages that are scanned and associated with the “archive message” action). The format is an mbox-format log file.
Anti-Virus Logs	AntiVirus logs record the status of the anti-virus scanning feature of your system, including the status on receiving updates of the latest anti-virus identity files.
Anti-Virus Archive	If you enabled an anti-virus engine, messages that are scanned and associated with the “archive message” action are archived here. The format is an mbox-format log file. For more information, see the “Anti-Virus” chapter.
AMP Engine Logs	The AMP Engine logs record the status of the Advanced Malware Protection features of the system. For more information, see <a href="#">File Reputation Filtering and File Analysis, on page 477</a>

Log	Description
AMP Archive	If you have configured mail policies to archive messages that Advanced Malware Protection engine has found to have attachments that are unscannable or contain malware, those messages are archived here. The format is an mbox-format log file.
Scanning Logs	The scanning log contains all LOG and COMMON messages for scanning engines (see <a href="#">Alerts, on page 1047</a> ). This is typically application faults, alert sent, alert failed, and log error messages. This log does not apply to system-wide alerts.
Spam Quarantine Logs	Spam Quarantine logs record actions associated with the Spam Quarantine processes.
Spam Quarantine GUI Logs	Spam Quarantine logs record actions associated with the Spam Quarantine including configuration via the GUI, end user authentication, and end user actions (releasing email, etc.).
SMTP Conversation Logs	The SMTP conversation log records all parts of incoming and outgoing SMTP conversations.
Safe/Block Lists Logs	Safelist/blocklist logs record data about the safelist/blocklist settings and database.
Reporting Logs	Reporting logs record actions associated with the processes of the centralized reporting service.
Reporting Query Logs	Reporting query logs record actions associated with the reporting queries that are run on the email gateway.
Updater Logs	The updater log records events related to updates for system services, such as McAfee Anti-Virus definition updates.
Tracking Logs	Tracking logs record actions associated with the processes of the tracking service. Tracking logs are a subset of the mail logs.
Authentication Logs	The authentication log records successful user logins and unsuccessful login attempts.
Configuration History Logs	Configuration history logs record the following information: What changes were made on the email gateway, and when were the changes made? A new configuration history log is created each time a user commits a change.
Upgrade Logs	Status information about upgrade download and installation.

Log	Description
API Logs	<p>API logs record various events related to the AsyncOS API for the email gateway, for example:</p> <ul style="list-style-type: none"><li>• API has started or stopped</li><li>• Connection to the API failed or closed (after providing response)</li><li>• Authentication succeeded or failed</li><li>• Request contains errors</li><li>• Error while communicating network configuration changes with AsyncOS API</li></ul>
Consolidated Event Logs	<p>The Consolidated Event Logs summarizes each message event in a single log line. Using this log type you can reduce the number of bytes of data (log information) sent to a Security Information and Event Management (SIEM) vendor or application for analysis. The logs are in the Common Event Format (CEF) log message format that is widely used by most SIEM vendors.</p>
CSN Logs	<p>The CSN logs contain details about the CSN data uploads. The CSN data (email gateway and feature usage details) can be seen at the trace level.</p>
Advanced Phishing Protection Logs	<p>The Advanced Phishing Protection logs contain information related to Cisco Advanced Phishing Protection Cloud Service. Most information is at the Info or Critical level.</p>

Log	Description
Audit Logs	<p>The Audit logs record AAA (Authentication, Authorization, and Accounting) events.</p> <p>Some of the audit log details are as follows:</p> <ul style="list-style-type: none"> <li>• User - Logon</li> <li>• User - Logon failed incorrect password</li> <li>• User - Logon failed unknown username</li> <li>• User - Logon failed account expired</li> <li>• User – Logoff</li> <li>• User - Lockout</li> <li>• User - Activated</li> <li>• User - Password change</li> <li>• User - Password reset</li> <li>• User - Security settings/profile change</li> <li>• User - Created</li> <li>• User - Deleted or modified</li> <li>• User Configuration - Configuration changes made by the user.</li> <li>• Group/Role - Deletion or modified</li> <li>• Group /Role - Permissions change</li> <li>• Quarantine - Actions performed on messages in the quarantine.</li> </ul>
CSA Logs	<p>The CSA logs contain information related to the Cisco Secure Awareness cloud service. Most information is at the Info or Debug level.</p>

## Log Type Characteristics

The following table summarizes the different characteristics of each log type.

Table 120: Log Type Comparison

						Contains								
	Transactional	Stateless	Recorded as text	Recorded as mbox file	Recorded as binary	Periodic Status Information	Message Receiving Information	Delivery Information	Individual Hard Bounces	Individual Soft Bounces	Injection SMTP Conversation	Header Logging	Delivery SMTP Conversation	Configuration Information
Mail Logs	•		•			•	•	•	•	•		•		
qmail Format Delivery Logs		•			•		•	•	•			•		
Delivery Log		•			•		•	•	•			•		
Bounce Logs	•		•						•	•		•		
Status Logs		•	•			•								
Domain Debug Logs	•		•					•	•	•			•	
Injection Debug Logs	•		•				•				•			
System Logs	•		•			•								
CLI Audit Logs	•		•			•								
FTP Server Logs	•		•			•								
HTTP Logs	•		•			•								
NTP Logs	•		•			•								

						Contains								
	Transactional	Stateless	Recorded as text	Recorded as mbox file	Recorded as binary	Periodic Status Information	Message Receiving Information	Delivery Information	Individual Hard Bases	Individual Soft Bases	Injection SMTP Conversation	Header Logging	Delivery SMTP Conversation	Configuration Information
LDAP Logs	•		•											
Anti-spam Logs	•		•			•								
Anti-Spam Archive				•										
Graymail Engine Logs	•		•			•								
Graymail Archive				•										
Anti-virus Logs	•		•			•								
Anti-Virus Archive				•										
AMP Engine Logs	•		•			•								
AMP Archive				•										
Scanning Logs	•		•			•								•
Spam Quarantine	•		•			•								
Spam Quarantine GUI	•		•			•								
Safe/Block Lists Logs	•		•			•								
Reporting Logs	•		•		•									



						Contains								
	Transactional	Stateless	Recorded as text	Recorded as mbox file	Recorded as binary	Periodic Status Information	Message Receiving Information	Delivery Information	Individual Hard Bases	Individual Soft Bases	Injection SMTP Conversation	Header Logging	Delivery SMTP Conversation	Configuration Information
Reporting Query Logs	•		•		•									
Updater Logs			•											
Tracking Logs	•				•	•	•	•	•	•		•		
Authentication Logs	•		•											
Configuration History Logs	•		•											•
API Logs	•		•											
Consolidated Event Logs	•		•				•	•						
CSN Logs	•		•			•								•
Advanced Phishing Protection Logs	•		•											
Audit Logs			•											

## Log Retrieval Methods

Log files can be retrieved based upon one of the following file transfer protocols. You set the protocol while creating or editing the log subscription in the GUI or via the logconfig command during the log subscription process.



**Note** When using a Log Push method on a particular log, that log will be locally unavailable for troubleshooting or searching via the CLI.

**Table 121: Log Transfer Protocols**

Manually Download	<p>This method lets you access log files at any time by clicking a link to the log directory on the Log Subscriptions page, then clicking the log file to access. Depending on your browser, you can view the file in a browser window, or open or save it as a text file. This method uses the HTTP(S) protocol and is the default retrieval method.</p> <p><b>Note</b> Using this method, you cannot retrieve logs for any computer in a cluster, regardless of level (machine, group, or cluster), even if you specify this method in the CLI.</p>
FTP Push	<p>This method periodically pushes log files to an FTP server on a remote computer. The subscription requires a username, passphrase, and destination directory on the remote computer. Log files are transferred based on a rollover schedule set by you.</p>
SCP Push	<p>This method periodically pushes log files to an SCP server on a remote computer. This method requires an SSH SCP server on a remote computer using the SSH1 or SSH2 protocol. The subscription requires a username, SSH key, and destination directory on the remote computer. Log files are transferred based on a rollover schedule set by you.</p>

Syslog Push	<p>This method sends log messages to a remote syslog server. This method conforms to RFC 3164.</p> <p><b>Note</b> Only text-based logs can be transferred using syslog push.</p> <p>Enter the following information in the fields below after you select the Syslog Push method:</p> <ul style="list-style-type: none"> <li>• <b>Hostname</b> – Enter the host name of the remote syslog server.</li> <li>• <b>Port</b> – Enter the port number of the remote syslog server. The default port number used is 514.</li> <li>• <b>Protocol</b> – Select the required protocol – UDP or TCP for log transmission.</li> <li>• <b>Maximum message size</b> - Enter the maximum size of the log message in bytes to send to the remote syslog server.</li> </ul> <p><b>Note</b> [For TCP protocol] The maximum message size value must be an integer from 1024 to 65535 bytes.</p> <p><b>Note</b> [For UDP protocol] The maximum message size value must be an integer from 1024 to 9216 bytes.</p> <ul style="list-style-type: none"> <li>• <b>Facility</b> - Select the required facility for the log, if required. By default, the 'Auth' facility option is selected in the drop-down list.</li> </ul> <hr/> <ul style="list-style-type: none"> <li>• <b>TLS</b> – [Applicable for TCP protocol only]: Select this option to send log messages from your email gateway to the remote syslog server over a TLS connection. <ul style="list-style-type: none"> <li>• If you select the TLS option, make sure you add a valid client certificate in your email gateway to establish a TLS connection between your email gateway and the remote syslog server.</li> <li>• The Syslog Push method uses the same TLS version selected in the 'Other TLS Client Services' option in the 'SSL Configuration' page in your email gateway.</li> <li>• TLS support for the Syslog Push method uses the DEFAULT SSL cipher list. The DEFAULT keyword is the OpenSSL DEFAULT cipher string, which is generally <code>ALL:!EXPORT:!LOW:!aNULL:!eNULL:!SSLv2</code>.</li> </ul> </li> </ul>
-------------	--

	<ul style="list-style-type: none"> <li>• <b>Syslog Disk Buffer - [Applicable for TCP protocol only]:</b> Select this check box to configure a local disk buffer for a syslog push log subscription to allow secure email gateway to cache log events when the remote syslog server is unavailable. When the syslog server becomes available, secure email gateway begins sending all the data in the buffer for that log subscription to the syslog server.</li> </ul> <p><b>Note</b></p> <ul style="list-style-type: none"> <li>• Ensure the syslog server is running before starting this procedure to avoid log data loss.</li> <li>• Determine the size of the local disk buffer, allowing enough space to accommodate the maximum expected period of down time for the syslog server. This avoids loss of log data.</li> <li>• If you have a secondary log subscription for local retention, Cisco recommends you cancel the secondary subscription to allow space for the local disk buffer for the primary subscription.</li> <li>• The secure email gateway may not be able to cache the first several seconds of log data after loss of connection to the syslog server. This is due to characteristics of syslog over TCP.</li> <li>• The default syslog disk buffer size is 100MB. The maximum disk buffer size allowed is 1GB. You can enter the size in bytes (1073741824), megabytes(1M), or gigabytes(1G).</li> </ul>
[Only for Consolidated Event Logs] AWS S3 Push	<p>This method periodically pushes log files to the Amazon Simple Storage Service (S3) Bucket available on the Amazon Web Services (AWS) public cloud. The subscription requires an S3 bucket name, access key, and a secret key to access the Amazon S3 bucket. You can set a rollover schedule to transfer the log files.</p> <p><b>Note</b> Make sure that you have a valid AWS S3 bucket to use this retrieval method. For more information, refer to the AWS user documentation at <a href="https://docs.aws.amazon.com/IAM/latest/UserGuide/id_credentials_access-keys.html">https://docs.aws.amazon.com/IAM/latest/UserGuide/id_credentials_access-keys.html</a>.</p>

## Log Filenames and Directory Structure

AsyncOS creates a directory for each log subscription based on the log subscription name. The actual name of the log file in the directory is composed of the log filename specified by you, the timestamp when the log file was started, and a single-character status code. The filename of logs are made using the following formula:

```
/LogSubscriptionName/LogFilename.@timestamp.statuscode
```

Status codes may be `.current` or `.s` (signifying saved). You should only transfer or delete log files with the saved status.

## Log Rollover and Transfer Schedule

Log files are created by log subscriptions, and are rolled over (and transferred, if a push-based retrieval option is selected) based on the first user-specified condition reached: maximum file size or scheduled rollover. Use the `logconfig` command in the CLI or the Log Subscriptions page in the GUI to configure both the maximum file size and time interval for scheduled rollovers. You can also use the **Rollover Now** button in the GUI or

the `rollovernow` command in the CLI to rollover selected log subscriptions. See [Rolling Over Log Subscriptions, on page 1217](#) for more information on scheduling rollovers.

Logs retrieved using manual download are saved until they reach the maximum number you specify (the default is 10 files) or until the system needs more space for log files.

## Logs Enabled by Default

Your email gateway is pre-configured with many log subscriptions enabled by default (other logs may be configured depending on which license keys you have applied). By default, the retrieval method is “Manually Download.”

All pre-configured log subscriptions have a Log Level of 3, except for `error_logs` which is set at 1 so that it will contain only errors. See [Log Levels, on page 1213](#) for more information. For information about creating new log subscriptions, or modifying existing ones, see [Log Subscriptions, on page 1212](#).

## Log Types

- [Using Text Mail Logs, on page 1158](#)
- [Using Delivery Logs, on page 1172](#)
- [Using Bounce Logs, on page 1174](#)
- [Using Status Logs, on page 1175](#)
- [Using Domain Debug Logs, on page 1178](#)
- [Using Injection Debug Logs, on page 1179](#)
- [Using System Logs, on page 1180](#)
- [Using CLI Audit Logs, on page 1181](#)
- [Using FTP Server Logs, on page 1181](#)
- [Using HTTP Logs, on page 1182](#)
- [Using NTP Logs, on page 1183](#)
- [Using Scanning Logs, on page 1183](#)
- [Using Anti-Spam Logs, on page 1184](#)
- [Using Graymail Logs, on page 1184](#)
- [Using Anti-Virus Logs, on page 1185](#)
- [Using AMP Engine Logs, on page 1185](#)
- [Using Spam Quarantine Logs, on page 1190](#)
- [Using Spam Quarantine GUI Logs, on page 1191](#)
- [Using LDAP Debug Logs, on page 1192](#)
- [Using Safelist/Blocklist Logs, on page 1193](#)
- [Using Reporting Logs, on page 1194](#)
- [Using Reporting Query Logs, on page 1195](#)
- [Using Updater Logs, on page 1196](#)
- [Understanding Tracking Logs, on page 1197](#)
- [Using Authentication Logs, on page 1197](#)
- [Using Configuration History Logs, on page 1198](#)
- [Using External Threat Feeds Engine Logs, on page 1199](#)
- [Using Consolidated Event Logs, on page 1200](#)
- [Using CSN Logs, on page 1207](#)

- [Using Advanced Phishing Protection Logs, on page 1208](#)
- [Using Audit Logs, on page 1208](#)
- [Using CSA Logs, on page 1211](#)

## Timestamps in Log Files

The following log files include the begin and end date of the log itself, the version of AsyncOS, and the GMT offset (provided in seconds, and only at the beginning of the log):

- Anti-Virus log
- LDAP log
- System log
- Mail log

## Using Text Mail Logs

They contain details of email receiving, email delivery and bounces. These logs are a useful source of information to understand delivery of specific messages and to analyze system performance.

These logs do not require any special configuration. However, you must configure the system properly to view attachment names, and attachment names may not always be logged. For information, see [Enabling Message Tracking, on page 911](#) and [Message Tracking Overview , on page 911](#).

Information displayed in text mail logs is shown in the following table:

**Table 122: Text Mail Log Statistics**

Statistic	Description
ICID	Injection Connection ID. This is a numerical identifier for an individual SMTP connection to the system, over which 1 to thousands of individual messages may be sent.
DCID	Delivery Connection ID. This is a numerical identifier for an individual SMTP connection to another server, for delivery of 1 to thousands of messages, each with some or all of their RIDs being delivered in a single message transmission.
RCID	RPC Connection ID. This is a numerical identifier for an individual RPC connection to the Spam quarantine. It is used to track messages as they are sent to and from the Spam Quarantine.
MID	Message ID: Use this to track messages as they flow through the logs.
RID	Recipient ID: Each message recipient is assigned an ID.
New	New connection initiated.
Start	New message started.

## Interpreting a Text Mail Log

Use the following sample as a guide to interpret log files.



**Note** Individual lines in log files are NOT numbered. They are numbered here only for sample purposes.

**Table 123: Text Mail Log Detail**

1	Mon Apr 17 19:56:22 2003 Info: New SMTP ICID 5 interface Management (10.1.1.1) address 10.1.1.209 reverse dns host remotehost.com verified yes
2	Mon Apr 17 19:57:20 2003 Info: Start MID 6 ICID 5
3	Mon Apr 17 19:57:20 2003 Info: MID 6 ICID 5 From: <sender@remotehost.com>
4	Mon Apr 17 19:58:06 2003 Info: MID 6 ICID 5 RID 0 To: <mary@yourdomain.com>
5	Mon Apr 17 19:59:52 2003 Info: MID 6 ready 100 bytes from <sender@remotehost.com>
6	Mon Apr 17 19:59:59 2003 Info: ICID 5 close
7	Mon Mar 31 20:10:58 2003 Info: New SMTP DCID 8 interface 192.168.42.42 address 10.5.3.25
8	Mon Mar 31 20:10:58 2003 Info: Delivery start DCID 8 MID 6 to RID [0]
9	Mon Mar 31 20:10:58 2003 Info: Message done DCID 8 MID 6 to RID [0]
10	Mon Mar 31 20:11:03 2003 Info: DCID 8 close

Use the following table as a guide to reading the preceding log file.

**Table 124: Detail of Text Mail Log Example**

Line Number	Description
1	A new connection is initiated into the system and assigned an Injection ID (ICID) of "5." The connection was received on the Management IP interface and was initiated from the remote host at 10.1.1.209.
2	The message was assigned a Message ID (MID) of "6" after the MAIL FROM command is issued from the client.

Line Number	Description
3	The sender address is identified and accepted.
4	The recipient is identified and assigned a Recipient ID (RID) of "0."
5	MID 5 is accepted, written to disk, and acknowledged.
6	Receiving is successful and the receiving connection closes.
7	Next the message delivery process starts. It is assigned a Delivery Connection ID (DCID) of "8" from 192.168.42.42 and to 10.5.3.25.
8	The message delivery starts to RID "0."
9	Delivery is successful for MID 6 to RID "0."
10	The delivery connection closes.

## Examples of Text Mail Log Entries

Following are some sample log entries based on various situations.

### Message Injection and Delivery

A message is injected into the email gateway for a single recipient. The message is successfully delivered.

```
Wed Jun 16 21:42:34 2004 Info: New SMTP ICID 282204970 interface mail.example.com
(1.2.3.4) address 2.3.4.5 reverse dns host unknown verified no
```

```
Wed Jun 16 21:42:34 2004 Info: ICID 282204970 SBRS None
```

```
Wed Jun 16 21:42:35 2004 Info: Start MID 200257070 ICID 282204970
```

```
Wed Jun 16 21:42:35 2004 Info: MID 200257070 ICID 282204970 From: <someone@foo.com>
```

```
Wed Jun 16 21:42:36 2004 Info: MID 200257070 ICID 282204970 RID 0 To: <user@example.com>
```

```
Wed Jun 16 21:42:38 2004 Info: MID 200257070 Message-ID
'<37gva9$5uvbhe@mail.example.com>'
```

```
Wed Jun 16 21:42:38 2004 Info: MID 200257070 Subject 'Hello'
```

```
Wed Jun 16 21:42:38 2004 Info: MID 200257070 ready 24663 bytes from <someone@foo.com>
```

```
Wed Jun 16 21:42:38 2004 Info: MID 200257070 antivirus negative
```

```
Wed Jun 16 21:42:38 2004 Info: MID 200257070 queued for delivery
```

```
Wed Jun 16 21:42:38 2004 Info: New SMTP DCID 2386069 interface 1.2.3.4 address 1.2.3.4
```

```
Wed Jun 16 21:42:38 2004 Info: Delivery start DCID 2386069 MID 200257070 to RID [0]
```

```
Wed Jun 16 21:42:38 2004 Info: ICID 282204970 close
```

```
Wed Jun 16 21:42:38 2004 Info: Message done DCID 2386069 MID 200257070 to RID [0]
[('X-SBRS', 'None')]
```

```
Wed Jun 16 21:42:38 2004 Info: MID 200257070 RID [0] Response 2.6.0
```



```
<37gva9$5uvbhe@mail.example.com> Queued mail for delivery
```

```
Wed Jun 16 21:42:43 2004 Info: DCID 2386069 close
```

### Successful Message Delivery

```
Mon Mar 31 20:10:58 2003 Info: New SMTP DCID 5 interface 172.19.0.11 address  
63.251.108.110
```

```
Mon Mar 31 20:10:58 2003 Info: Delivery start DCID 5 MID 4 to RID [0]
```

```
Mon Mar 31 20:10:58 2003 Info: Message done DCID 5 MID 4 to RID [0]
```

```
Mon Mar 31 20:11:03 2003 Info: DCID 5 close
```

### Unsuccessful Message Delivery (Hard Bounce)

A message with two recipients is injected into the email gateway. Upon delivery, the destination host returns a 5 XX error, which indicates that the message cannot be delivered to either recipient. The email gateway notifies the sender and removes the recipients from the queue.

```
Mon Mar 31 20:00:23 2003 Info: New SMTP DCID 3 interface 172.19.0.11 address  
64.81.204.225
```

```
Mon Mar 31 20:00:23 2003 Info: Delivery start DCID 3 MID 4 to RID [0, 1]
```

```
Mon Mar 31 20:00:27 2003 Info: Bounced: DCID 3 MID 4 to RID 0 - 5.1.0 - Unknown address  
error ('550', ['<george@yourdomain.com>... Relaying denied']) []
```

```
Mon Mar 31 20:00:27 2003 Info: Bounced: DCID 3 MID 4 to RID 1 - 5.1.0 - Unknown address  
error ('550', ['<jane@yourdomain.com>... Relaying denied']) []
```

```
Mon Mar 31 20:00:32 2003 Info: DCID 3 close
```

### Soft Bounce Followed by Successful Delivery

A message is injected into the email gateway. On the first delivery attempt, the message soft bounces and is queued for future delivery. On the second attempt, the message is successfully delivered.

```
Mon Mar 31 20:10:58 2003 Info: New SMTP DCID 5 interface 172.19.0.11 address  
63.251.108.110
```

```
Mon Mar 31 20:00:23 2003 Info: Delivery start DCID 3 MID 4 to RID [0, 1]
```

```
Mon Mar 31 20:00:23 2003 Info: Delayed: DCID 5 MID 4 to RID 0 - 4.1.0 - Unknown address  
error ('466', ['Mailbox temporarily full.']) []
```

```
Mon Mar 31 20:00:23 2003 Info: Message 4 to RID [0] pending till Mon Mar 31 20:01:23  
2003
```

```
Mon Mar 31 20:01:28 2003 Info: DCID 5 close
```

```
Mon Mar 31 20:01:28 2003 Info: New SMTP DCID 16 interface PublicNet address 172.17.0.113
```

```
Mon Mar 31 20:01:28 2003 Info: Delivery start DCID 16 MID 4 to RID [0]
```

```
Mon Mar 31 20:01:28 2003 Info: Message done DCID 16 MID 4 to RID [0]
```

```
Mon Mar 31 20:01:33 2003 Info: DCID 16 close
```

## Message Scanning Results for the scanconfig Command

You can use the scanconfig command to determine the system behavior when a message can not be deconstructed into its component parts (when removing attachments). The Options are Deliver , Bounce , or Drop .

The following example shows the Text Mail log with scanconfig set to Deliver .

```
Tue Aug 3 16:36:29 2004 Info: MID 256 ICID 44784 From: <test@virus.org>
Tue Aug 3 16:36:29 2004 Info: MID 256 ICID 44784 RID 0 To: <joe@example.com>
Tue Aug 3 16:36:29 2004 Info: MID 256 Message-ID '<137398.@virus.org>'
Tue Aug 3 16:36:29 2004 Info: MID 256 Subject 'Virus Scanner Test #22'
Tue Aug 3 16:36:29 2004 Info: MID 256 ready 1627 bytes from <test@virus.org>
Tue Aug 3 16:36:29 2004 Warning: MID 256, Message Scanning Problem: Continuation line
seen before first header

Tue Aug 3 16:36:29 2004 Info: ICID 44784 close
Tue Aug 3 16:36:29 2004 Info: MID 256 antivirus positive 'EICAR-AV-Test'
Tue Aug 3 16:36:29 2004 Info: Message aborted MID 256 Dropped by antivirus
Tue Aug 3 16:36:29 2004 Info: Message finished MID 256 done
```

The following example shows the Text Mail log with scanconfig set to drop .

```
Tue Aug 3 16:38:53 2004 Info: Start MID 257 ICID 44785
Tue Aug 3 16:38:53 2004 Info: MID 257 ICID 44785 From: test@virus.org
Tue Aug 3 16:38:53 2004 Info: MID 257 ICID 44785 RID 0 To: <joe@example.com>
Tue Aug 3 16:38:53 2004 Info: MID 257 Message-ID '<392912.@virus.org>'
Tue Aug 3 16:38:53 2004 Info: MID 25781 Subject 'Virus Scanner Test #22'
Tue Aug 3 16:38:53 2004 Info: MID 257 ready 1627 bytes from <test@virus.org>
Tue Aug 3 16:38:53 2004 Warning: MID 257, Message Scanning Problem: Continuation line
seen before first header
Tue Aug 3 16:38:53 2004 Info: Message aborted MID 25781 Dropped by filter 'drop_zip_c'
Tue Aug 3 16:38:53 2004 Info: Message finished MID 257 done
Tue Aug 3 16:38:53 2004 Info: ICID 44785 close
```

## Message with Attachment

In this example, a content filter with condition “Message Body Contains” has been configured to enable identification of attachment names:

```
Sat Apr 23 05:05:42 2011 Info: New SMTP ICID 28 interface Management (192.0.2.10)
address 224.0.0.10 reverse dns host test.com verified yes

Sat Apr 23 05:05:42 2011 Info: ICID 28 ACCEPT SG UNKNOWNLIST match sbrs[-1.0:10.0]
SBRS 0.0

Sat Apr 23 05:05:42 2011 Info: Start MID 44 ICID 28
Sat Apr 23 05:05:42 2011 Info: MID 44 ICID 28 From: <sender1@example.com>
Sat Apr 23 05:05:42 2011 Info: MID 44 ICID 28 RID 0 To: <recipient1@example.org>
Sat Apr 23 05:05:42 2011 Info: MID 44 Message-ID '<000001cba32e$f24ff2e0$d6efd8a0$@com>'
Sat Apr 23 05:05:42 2011 Info: MID 44 Subject 'Message 001'
```

```

Sat Apr 23 05:05:42 2011 Info: MID 44 ready 240129 bytes from <sender1@example.com>
Sat Apr 23 05:05:42 2011 Info: MID 44 matched all recipients for per-recipient
policy DEFAULT in the inbound table
Sat Apr 23 05:05:42 2011 Info: ICID 28 close
Sat Apr 23 05:05:42 2011 Info: MID 44 interim verdict using engine: CASE
spam negative
Sat Apr 23 05:05:42 2011 Info: MID 44 using engine: CASE spam negative
Sat Apr 23 05:05:43 2011 Info: MID 44 attachment 'Banner.gif'
Sat Apr 23 05:05:43 2011 Info: MID 44 attachment '=D1=82=D0=B5=D1=81=D1=82.rst'
Sat Apr 23 05:05:43 2011 Info: MID 44 attachment 'Test=20Attachment.docx'
Sat Apr 23 05:05:43 2011 Info: MID 44 queued for delivery

```

Note that the second of the three attachments is Unicode. On terminals that cannot display Unicode, these attachments are represented in quoted-printable format.

### Successful Message Delivery with DANE Support

A message reaches the email gateway for a single recipient. The email gateway requests for a secure DNS MX record, DNS A record, and a TLSA record from the DNS server. If you select DANE as "Mandatory", the TLSA record is validated against the X.509 certificate value of the recipient's domain. If the TLSA record validation is successful, the message is delivery to the recipient.

```

Tue Nov 13 12:13:33 2018 Debug: Trying DANE MANDATORY for example.org
Tue Nov 13 12:13:33 2018 Debug: SECURE MX record(mail.example.org) found for example.org
Tue Nov 13 12:13:33 2018 Debug: DNS query: Q('mail.example.org', 'CNAME')
Tue Nov 13 12:13:33 2018 Debug: DNS query: QN('mail.example.org', 'CNAME',
'recursive_nameserver0.parent')
Tue Nov 13 12:13:33 2018 Debug: DNS query: QIP ('mail.example.org', 'CNAME', '8.8.8.8', 60)
Tue Nov 13 12:13:33 2018 Debug: DNS query: Q ('mail.example.org', 'CNAME', '8.8.8.8')
Tue Nov 13 12:13:34 2018 Debug: DNSSEC Response data([], , 0, 1799)
Tue Nov 13 12:13:34 2018 Debug: Received NODATA for domain mail.example.org type CNAME
Tue Nov 13 12:13:34 2018 Debug: No CNAME record(NoError) found for domain(mail.example.org)
Tue Nov 13 12:13:34 2018 Debug: SECURE A record (4.31.198.44) found for
MX(mail.example.org) in example.org
Tue Nov 13 12:13:34 2018 Info: New SMTP DCID 92 interface 10.10.1.191 address 4.31.198.44
port 25
Tue Nov 13 12:13:34 2018 Info: ICID 13 lost
Tue Nov 13 12:13:34 2018 Info: ICID 13 close
Tue Nov 13 12:13:34 2018 Debug: DNS query: Q('_25._tcp.mail.example.org', 'TLSA')
Tue Nov 13 12:13:34 2018 Debug: DNS query: QN('_25._tcp.mail.example.org', 'TLSA',
'recursive_nameserver0.parent')
Tue Nov 13 12:13:34 2018 Debug: DNS query: QIP
('_25._tcp.mail.example.org', 'TLSA', '8.8.8.8', 60)
Tue Nov 13 12:13:34 2018 Debug: DNS query: Q ('_25._tcp.mail.example.org', 'TLSA', '8.8.8.8')
Tue Nov 13 12:13:35 2018 Debug: DNSSEC Response data(['0301010c72ac70b745ac19998811b13
1d662c9ac69dbdbe7cb23e5b514b56664c5d3d6'], secure, 0, 1799)
Tue Nov 13 12:13:35 2018 Debug: DNS encache (_25._tcp.mail.example.org, TLSA,
[(2550119024205761L, 0,
'SECURE', '0301010c72ac70b745ac19998811b131d662c9ac69dbdbe7cb23e5b514b56664c5d3d6')])
Tue Nov 13 12:13:35 2018 Debug: SECURE TLSA Record found for MX(mail.example.org) in
example.org
Tue Nov 13 12:13:36 2018 Info: DCID 92 Certificate verification successful
Tue Nov 13 12:13:36 2018 Info: DCID 92 TLS success protocol TLSv1.2 cipher
Tue Nov 13 12:13:36 2018 Info: DCID 92 TLS success protocol TLSv1.2 cipher
ECDHE-RSA-AES256-GCM-SHA384 for example.org
Tue Nov 13 12:13:36 2018 Info: Delivery start DCID 92 MID 23 to RID [0]

```

### Message Delivery Failed due to Certificate Verification Failure

A message reaches the email gateway for a single recipient. The email gateway requests for a secure DNS MX record, DNS A record, and a TLSA record from the DNS server. If you select DANE as "Mandatory",

the TLSA record is validated against the X.509 certificate value of the recipient's domain. If the certificate verification fails, the message is delivered at a later time. If secure TLSA record is not found, the message is bounced.

```

Wed Nov 14 05:52:08 2018 Debug: DNS query: QN('server1.example.net', 'CNAME',
'recursive_nameserver0.parent')
Wed Nov 14 05:52:08 2018 Debug: DNS query: QIP
('server1.example.net', 'CNAME', '10.10.2.184', 60)
Wed Nov 14 05:52:08 2018 Debug: DNS query: Q ('server1.example.net', 'CNAME', '10.10.2.184')
Wed Nov 14 05:52:08 2018 Debug: DNSSEC Response data([], , 0, 284)
Wed Nov 14 05:52:08 2018 Debug: Received NODATA for domain server1.example.net type CNAME
Wed Nov 14 05:52:08 2018 Debug: No CNAME record(NoError) found for domain(server1.example.net)
Wed Nov 14 05:52:08 2018 Debug: Secure CNAME(server1.example.net) found for
MX(someone.cs2.example.net)
in example.net
Wed Nov 14 05:52:08 2018 Debug: SECURE A record (10.10.1.198) found for
MX(someone.cs2.example.net)
in example.net
Wed Nov 14 05:52:08 2018 Info: New SMTP DCID 102 interface 10.10.1.191 address 10.10.1.198
port 25
Wed Nov 14 05:52:08 2018 Debug: Fetching TLSA records with CNAME(server1.example.net) for
MX(someone.cs2.example.net) in example.net
Wed Nov 14 05:52:08 2018 Debug: DNS query: Q('_25_tcp.server1.example.net', 'TLSA')
Wed Nov 14 05:52:08 2018 Debug: SECURE TLSA Record found for MX(server1.example.net) in
example.net
Wed Nov 14 05:52:08 2018 Debug: DCID 102 All TLSA records failed for certificate not trusted
Wed Nov 14 05:52:08 2018 Debug: Fetching TLSA records with initial
name(someone.cs2.example.net)
in example.net
Wed Nov 14 05:52:08 2018 Debug: DNS query: Q('_25_tcp.someone.cs2.example.net', 'TLSA')
Wed Nov 14 05:52:08 2018 Debug: SECURE TLSA Record found for MX(someone.cs2.example.net)
in example.net
Wed Nov 14 05:52:08 2018 Info: DCID 102 Certificate verification successful
Wed Nov 14 05:52:08 2018 Info: DCID 102 TLS success protocol TLSv1.2 cipher
DHE-RSA-AES128-SHA256
for example.net
Wed Nov 14 05:52:08 2018 Info: Delivery start DCID 102 MID 26 to RID [0]
Wed Nov 14 05:52:08 2018 Info: Message done DCID 102 MID 26 to RID [0]
Wed Nov 14 05:52:08 2018 Info: MID 26 RID [0] Response 'ok: Message 31009 accepted'
Wed Nov 14 05:52:08 2018 Info: Message finished MID 26 done

Wed Nov 14 06:36:22 2018 Debug: Trying DANE MANDATORY for example.net
Wed Nov 14 06:36:22 2018 Debug: SECURE MX record(someone.cs2.example.net) found for
example.net
Wed Nov 14 06:36:22 2018 Debug: DNS query: Q('someone.cs2.example.net', 'CNAME')
Wed Nov 14 06:36:22 2018 Debug: DNS query: QN('someone.cs2.example.net', 'CNAME',
'recursive_nameserver0.parent')
Wed Nov 14 06:36:22 2018 Debug: DNS query: QIP
('someone.cs2.example.net', 'CNAME', '10.10.2.184', 60)
Wed Nov 14 06:36:22 2018 Debug: DNS query: Q ('someone.cs2.example.net', 'CNAME',
'10.10.2.184')
Wed Nov 14 06:36:22 2018 Debug: DNSSEC Response data(['mail.example2.net.'], secure, 0,
3525)
Wed Nov 14 06:36:22 2018 Debug: DNS encache (someone.cs2.example.net, CNAME,
[(2692348132363369L, 0,
'SECURE', 'mail.example2.net')])
Wed Nov 14 06:36:22 2018 Debug: DNS query: Q('mail.example2.net', 'CNAME')
Wed Nov 14 06:36:22 2018 Debug: DNS query: QN('mail.example2.net', 'CNAME',
'recursive_nameserver0.parent')
Wed Nov 14 06:36:22 2018 Debug: DNS query: QIP ('mail.example2.net', 'CNAME', '10.10.2.184', 60)
Wed Nov 14 06:36:22 2018 Debug: DNS query: Q ('mail.example2.net', 'CNAME', '10.10.2.184')
Wed Nov 14 06:36:22 2018 Debug: DNSSEC Response data([], , 0, 225)
Wed Nov 14 06:36:22 2018 Debug: Received NODATA for domain mail.example2.net type CNAME
Wed Nov 14 06:36:22 2018 Debug: No CNAME record(NoError) found for domain(mail.example2.net)

```

```

Wed Nov 14 06:36:22 2018 Debug: Secure CNAME(mail.example2.net) found for
MX(someone.cs2.example.net)
in example.net
Wed Nov 14 06:36:22 2018 Debug: INSECURE A record (10.10.1.197) found for
MX(someone.cs2.example.net)
in example.net
Wed Nov 14 06:36:22 2018 Debug: Fetching TLSA records with initial
name(someone.cs2.example.net) in example.net
Wed Nov 14 06:36:22 2018 Info: New SMTP DCID 104 interface 10.10.1.191 address 10.10.1.197
port 25
Wed Nov 14 06:36:36 2018 Debug: DNS query: Q('_25._tcp.someone.cs2.example.net', 'TLSA')
Wed Nov 14 06:36:36 2018 Debug: SECURE TLSA Record found for MX(someone.cs2.example.net)
in example.net
Wed Nov 14 06:36:36 2018 Debug: DCID 104 All TLSA records failed for certificate not trusted
Wed Nov 14 06:36:36 2018 Info: MID 27 DCID 104 DANE failed for the domain example.net:
DANE Certificate verification failed
Wed Nov 14 06:36:36 2018 Info: Failed for all MX hosts in example.net

```

### Message Delivery Failed due to Invalid TLSA Record

A message reaches the email gateway for a single recipient. The email gateway requests for a secure DNS MX record, DNS A record, and a TLSA record from the DNS server. If you select DANE as "Mandatory", the TLSA record is validated against the X.509 certificate value of the recipient's domain. If an invalid TLSA record is found, the message delivery is attempted at a later time or the message is bounced.

```

Tue Aug 7 05:15:18 2018 Debug: Trying DANE MANDATORY for example-dane.net
Tue Aug 7 05:15:18 2018 Debug: SECURE MX record (someone.example-dane.net) found for
test-tlsabogus.net
Tue Aug 7 05:15:18 2018 Debug: DNS query: Q ('someone.example-dane.net', 'CNAME')
Tue Aug 7 05:15:18 2018 Debug: DNS query: QN ('someone.example-dane.net', 'CNAME',
'recursive_nameserver0.parent')
Tue Aug 7 05:15:18 2018 Debug: DNS query: QIP
('someone.example-dane.net', 'CNAME', '10.10.2.183', 60)
Tue Aug 7 05:15:18 2018 Debug: DNS query: Q ('someone.example-dane.net', 'CNAME',
'10.10.2.183')
Tue Aug 7 05:15:18 2018 Debug: DNSSEC Response data ([, , 0, 300)
Tue Aug 7 05:15:18 2018 Debug: SECURE A record (10.10.1.198) found for MX
(someone.example-dane.net)
in example-dane.net
Tue Aug 7 05:15:18 2018 Info: ICID 32 close
Tue Aug 7 05:15:18 2018 Info: New SMTP DCID 61 interface 10.10.1.194 address 10.10.1.198
port 25
Tue Aug 7 05:15:18 2018 Debug: DNS query: Q ('_25._tcp.someone.example-dane.net', 'TLSA')
Tue Aug 7 05:15:18 2018 Debug: DNS query: QN ('_25._tcp.someone.example-dane.net', 'TLSA',
'recursive_nameserver0.parent')
Tue Aug 7 05:15:18 2018 Debug: DNS query: QIP
('_25._tcp.someone.example-dane.net', 'TLSA', '10.10.2.183', 60)
Tue Aug 7 05:15:18 2018 Debug: DNS query: Q ('_25._tcp.someone.example-dane.net', 'TLSA',
'10.10.2.183')
Tue Aug 7 05:15:18 2018 Debug: DNSSEC Response data
(['03010160b3f16867357cdfef37bb6acd687af54f
225e3bfa945e1d37bfd37bd4eb6020'], bogus, 0, 60)
Tue Aug 7 05:15:18 2018 Debug: DNS encache (_25._tcp.someone.example-dane.net, TLSA,
[(11065394975822091L,
0, 'BOGUS', '03010160b3f16867357cdfef37bb6acd687af54f225e3bfa945e1d37bfd37bd4eb6020')])
Tue Aug 7 05:15:18 2018 Debug: BOGUS TLSA Record is found for MX (someone.example-dane.net)
in example-dane.net
Tue Aug 7 05:15:18 2018 Debug: Trying next MX record in example-dane.net
Tue Aug 7 05:15:18 2018 Info: MID 44 DCID 61 DANE failed: TLSA record BOGUS
Tue Aug 7 05:15:18 2018 Debug: Failed for all MX hosts in example-dane.net

```

## Rolling Back to Opportunistic TLS as TLSA Record Not Found

A message reaches the email gateway for a single recipient. The email gateway requests for a secure DNS MX record, DNS A record, and a TLSA record from the DNS server. If you select DANE as "Opportunistic", the TLSA record is validated against the X.509 certificate value of the recipient's domain. If TLSA record is not found for the recipient's domain, opportunistic TLS is used for encrypting SMTP conversations.

```

Wed Sep 12 06:51:32 2018 Debug: Trying DANE OPPORTUNISTIC for example-dane.com
Wed Sep 12 06:51:32 2018 Debug: SECURE MX record (mx.example-dane.com) found for
digitalhellion.com
Wed Sep 12 06:51:32 2018 Debug: DNS query: Q ('mx.example-dane.com', 'CNAME')
Wed Sep 12 06:51:32 2018 Debug: DNS query: QN ('mx.example-dane.com', 'CNAME',
'recursive_nameserver0.parent')
Wed Sep 12 06:51:32 2018 Debug: DNS query: QIP ('mx.example-dane.com', 'CNAME', '8.8.8.8', 60)
Wed Sep 12 06:51:32 2018 Debug: DNS query: Q ('mx.example-dane.com', 'CNAME', '8.8.8.8')
Wed Sep 12 06:51:32 2018 Debug: DNSSEC Response data ([], , 0, 1799)
Wed Sep 12 06:51:32 2018 Debug: Received NODATA for domain mx.example-dane.com type CNAME
Wed Sep 12 06:51:32 2018 Debug: No CNAME record (NoError) found for domain
(mx.example-dane.com)
Wed Sep 12 06:51:32 2018 Debug: SECURE A record (162.213.199.115) found for MX
(mx.example-dane.com)
in example-dane.com
Wed Sep 12 06:51:32 2018 Info: ICID 1 lost
Wed Sep 12 06:51:32 2018 Info: ICID 1 close
Wed Sep 12 06:51:33 2018 Info: New SMTP DCID 2 interface 10.10.1.173 address 162.213.199.115
port 25
Wed Sep 12 06:51:33 2018 Debug: DNS query: Q ('_25._tcp.mx.example-dane.com', 'TLSA')
Wed Sep 12 06:51:33 2018 Debug: DNS query: QN ('_25._tcp.mx.example-dane.com', 'TLSA',
'recursive_nameserver0.parent')
Wed Sep 12 06:51:33 2018 Debug: DNS query: QIP
('_25._tcp.mx.example-dane.com', 'TLSA', '8.8.8.8', 60)
Wed Sep 12 06:51:33 2018 Debug: DNS query: Q ('_25._tcp.mx.example-dane.com', 'TLSA',
'8.8.8.8')
Wed Sep 12 06:51:34 2018 Debug: DNSSEC Response data ([], , 3, 1798)
Wed Sep 12 06:51:34 2018 Debug: Received NXDomain for domain _25._tcp.mx.example-dane.com'
type TLSA
Wed Sep 12 06:51:34 2018 Debug: No TLSA record (NXDomain) found for MX (mx.example-dane.com)
Wed Sep 12 06:51:34 2018 Debug: Falling back to conventional TLS for MX (mx.example-dane.com)

in example-dane.com
Wed Sep 12 06:51:34 2018 Info: MID 1 DCID 2 DANE failed for the domain example-dane.com:
No TLSA Record
Wed Sep 12 06:51:34 2018 Info: DCID 2 TLS success protocol TLSv1.2 cipher
ECDHE-RSA-AES256-GCM-SHA384
Wed Sep 12 06:51:35 2018 Info: Delivery start DCID 2 MID 1 to RID [0]

```

## Message received based on Sender's Country of Origin

In this example, the log shows a message received based on the country of origin of a particular sender group.

```

Thu Apr 6 06:50:18 2017 Info: ICID 73 ACCEPT SG ALLOWED_LIST match country[us] SBRS -10.0
country United States

```

## Maximum URLs in Message Attachments Exceeds URL Scan Limit

In this example, the log shows the number of URLs in the message attachments that exceeded the URL scan limit

```

Wed Nov 8 13:35:48 2017 Info: MID $mid not completely scanned for URL Filtering. Error:
$error

```

## Maximum URLs in Message Body Exceeds URL Scan Limit

In this example, the log shows the number of URLs in the message body that exceeded the URL scan limit.

```
Wed Nov 8 13:37:42 2017 Info: MID 976 not completely scanned for URL Filtering.
Error: The number of URLs in the message body exceeded the URL scan limit.
```

## Malicious Shortened URL redirected to Cisco Proxy Server

In this example, the log shows a shortened URL that is marked as malicious due to a URL reputation score of -3, and redirected to the Cisco Security Proxy server.

```
Tue Nov 7 10:42:41 2017 Info: MID 9 having URL: http://ow.ly/Sb6030fJvVn has been expanded
to http://bit.ly/2frAllx
Tue Nov 7 10:42:42 2017 Info: MID 9 having URL: http://bit.ly/2frAllx has been expanded to
http://thebest01.wayisbetter.cn/?cMFN
Tue Nov 7 10:42:42 2017 Info: MID 9 URL http://thebest01.wayisbetter.cn/?cMFN has reputation
-3.854 matched Action: URL redirected to Cisco Security proxy
Tue Nov 7 10:42:42 2017 Info: MID 9 rewritten to MID 10 by
url-reputation-proxy-redirect-action filter 'aa'
```

## Unable to Expand Shortened URL in Message

In this example, the log shows that the shortened URL in the message could not be expanded to the actual URL.

```
Mon Oct 30 10:58:59 2017 Info: MID 36 having URL: http://ow.ly/P0Kw30fVst3 has been expanded
to http://bit.ly/2ymYWPR
Mon Oct 30 10:59:00 2017 Info: MID 36 having URL: http://bit.ly/2ymYWPR has been expanded
to http://ow.ly/cTS730fVssH
Mon Oct 30 10:59:01 2017 Info: MID 36 having URL: http://ow.ly/cTS730fVssH has been expanded
to http://bit.ly/2xK8PD9
Mon Oct 30 10:59:01 2017 Info: MID 36 having URL: http://bit.ly/2xK8PD9 has been expanded
to http://ow.ly/lWOi30fVssl
Mon Oct 30 10:59:02 2017 Info: MID 36 having URL: http://ow.ly/lWOi30fVssl has been expanded
to http://bit.ly/2ggHv9e
Mon Oct 30 10:59:03 2017 Info: MID 36 having URL: http://bit.ly/2ggHv9e has been expanded
to http://ow.ly/4fSO30fVsqx
Mon Oct 30 10:59:04 2017 Info: MID 36 having URL: http://ow.ly/4fSO30fVsqx has been expanded
to http://bit.ly/2hKEFcW
Mon Oct 30 10:59:05 2017 Info: MID 36 having URL: http://bit.ly/2hKEFcW has been expanded
to http://ow.ly/NyH830fVsQ6
Mon Oct 30 10:59:06 2017 Info: MID 36 having URL: http://ow.ly/NyH830fVsQ6 has been expanded
to http://bit.ly/2ysnsNi
Mon Oct 30 10:59:06 2017 Info: MID 36 having URL: http://bit.ly/2ysnsNi has been expanded
to http://ow.ly/JhUN30fVsnL
Mon Oct 30 10:59:07 2017 Info: MID 36 having URL: http://ow.ly/JhUN30fVsnL has been expanded
to http://bit.ly/2hKQmAe
Mon Oct 30 10:59:07 2017 Info: MID 36 URL http://bit.ly/2hKQmAe is marked malicious due to
: URL depth exceeded
Mon Oct 30 11:04:48 2017 Warning: MID 40 Failed to expand URL http://mail1.example.com/abcd
Reason: Error while trying to retrieve expanded URL
Mon Oct 30 11:04:48 2017 Info: MID 40 not completely scanned for URL Filtering. Error:
Message has a shortened URL that could not be expanded
```

## Log Entry for Malicious URL in Message Attachment

In this example, the log shows a URL in the message attachment that is malicious with a reputation score of -9.5.

```
Mon Nov 6 06:50:18 2017 Info: MID 935 Attachment file_1.txt URL http://jrsvyvsq.net has
reputation -9.5 matched
Condition: URL Reputation Rule
```

## Message marked as Unscannable due to Extraction Failure

In this example, the log shows a message that is not scanned by the Content Scanner due to an attachment extraction failure.

```
Tue Oct 24 08:28:58 2017 Info: Start MID 811 ICID 10
Tue Oct 24 08:28:58 2017 Info: MID 811 ICID 10 From: <sender@example.com>
Tue Oct 24 08:28:58 2017 Info: MID 811 ICID 10 RID 0 To: <recipient@example.com>
Tue Oct 24 08:28:58 2017 Info: MID 811 Message-ID '<example@cisco.com>'
Tue Oct 24 08:28:58 2017 Info: MID 811 Subject 'Test mail'
Tue Oct 24 08:28:58 2017 Info: MID 811 ready 5242827 bytes from <user2@sender.com>
Tue Oct 24 08:28:58 2017 Info: MID 811 matched all recipients for per-recipient policy
DEFAULT in the inbound table
Tue Oct 24 08:28:59 2017 Info: MID 811 attachment 'gzip.tar.gz'
Tue Oct 24 08:28:59 2017 Info: MID 811 was marked as unscannable due to extraction failures.
Reason: Error in extraction process - Decoding Errors.
Tue Oct 24 08:28:59 2017 Info: ICID 10 close
Tue Oct 24 08:28:59 2017 Info: MID 811 quarantined to "Policy" (Unscannable: due to Extraction
Failure)
Tue Oct 24 08:28:59 2017 Info: Message finished MID 811 done
```

## Message marked as Unscannable due to RFC Violation

In this example, the log shows a message that is not scanned by the Content Scanner due to an RFC violation.

```
Tue Oct 24 08:23:26 2017 Info: Start MID 807 ICID 6
Tue Oct 24 08:23:26 2017 Info: MID 807 ICID 6 From: <sender@example.com>
Tue Oct 24 08:23:26 2017 Info: MID 807 ICID 6 RID 0 To: <recipient@example.com>
Tue Oct 24 08:23:26 2017 Info: MID 807 Subject 'Test Mail'
Tue Oct 24 08:23:26 2017 Info: MID 807 ready 427 bytes from <sender@example.com>
Tue Oct 24 08:23:26 2017 Info: MID 807 matched all recipients for per-recipient policy
DEFAULT in the inbound table
Tue Oct 24 08:23:26 2017 Info: MID 807 was marked as unscannable due to an RFC violation.
Reason: A Unix-From header was found in the middle of a header block.
Tue Oct 24 08:23:26 2017 Info: MID 807 queued for delivery
Tue Oct 24 08:23:26 2017 Info: ICID 6 close
```

## Log Entries for Generated or Re-Written Messages

Some functions, such as rewrite/redirect actions ( alt-rcpt-to filters, anti-spam rcpt rewrite, bcc() actions, anti-virus redirections, etc.), create new messages. When looking through the logs, you might need to check the results and add in further MIDs and possibly DCIDs. Entries such as these are possible:

```
Tue Jun 1 20:02:16 2004 Info: MID 14 generated based on MID 13 by bcc filter 'nonetest'
OR:
Tue Jan 6 15:03:18 2004 Info: MID 2 rewritten to 3 by antispam
Fri May 14 20:44:43 2004 Info: MID 6 rewritten to 7 by alt-rcpt-to-filter filter
'testfilt'
```

An interesting point to note about 'rewritten' entries is that they can appear after lines in the log indicating use of the new MID.



## Messages Sent to the Spam Quarantine

When you send a message to the quarantine, the mail logs track the movement to and from the quarantine using the RCID (RPC connection ID) to identify the RPC connection. In the following mail log, a message is tagged as spam, and sent to the Spam Quarantine:

```
Wed Feb 14 12:11:40 2007 Info: Start MID 2317877 ICID 15726925

Wed Feb 14 12:11:40 2007 Info: MID 2317877 ICID 15726925 From: <HLD@chasehf.bfi0.com>
Wed Feb 14 12:11:40 2007 Info: MID 2317877 ICID 15726925 RID 0 To:
<stevel@healthtrust.org>
Wed Feb 14 12:11:40 2007 Info: MID 2317877 Message-ID
'<W1TH05606E5811BEA0734309D4BAF0.323.14460.pimailer44.DumpShot.2@email.chase.com>'
Wed Feb 14 12:11:40 2007 Info: MID 2317877 Subject 'Envision your dream home - Now make
it a reality'

Wed Feb 14 12:11:40 2007 Info: MID 2317877 ready 15731 bytes from <HLD@chasehf.bfi0.com>

Wed Feb 14 12:11:40 2007 Info: MID 2317877 matched all recipients for per-recipient
policy DEFAULT in the inbound table

Wed Feb 14 12:11:41 2007 Info: MID 2317877 using engine: CASE spam suspect

Wed Feb 14 12:11:41 2007 Info: EUQ: Tagging MID 2317877 for quarantine
Wed Feb 14 12:11:41 2007 Info: MID 2317877 antivirus negative
Wed Feb 14 12:11:41 2007 Info: MID 2317877 queued for delivery
Wed Feb 14 12:11:44 2007 Info: RPC Delivery start RCID 756814 MID 2317877 to local
IronPort Spam Quarantine

Wed Feb 14 12:11:45 2007 Info: EUQ: Quarantined MID 2317877

Wed Feb 14 12:11:45 2007 Info: RPC Message done RCID 756814 MID 2317877

Wed Feb 14 12:11:45 2007 Info: Message finished MID 2317877 done
```

## Example of External Threat Feeds Mail Logs

The Mail Logs contain information about threats detected in incoming messages and actions taken on such messages. Most information is at the Info or Debug level.

```
Thu Jun 7 20:48:10 2018 Info: MID 91 Threat feeds source 'S1' detected malicious URL:
'http://digimobil.mobi/' in attachment(s): malurl.txt. Action: Attachment stripped
```

## Examples of SDR Filtering Log Entries

The SDR filtering information is posted to the Mail Logs. Most information is at the Info or Debug level.

- [Sender Domain Reputation Request Timeout, on page 326](#)
- [Sender Domain Reputation General Errors, on page 326](#)

### Sender Domain Reputation Authentication Failure

In this example, the log shows a message that was not filtered based on SDR because of an authentication failure when connecting to the SDR service.

```
Mon Jul 2 08:57:18 2018 Info: New SMTP ICID 3 interface Management (192.0.2.10) address
224.0.0.10 reverse dns host unknown verified no
Mon Jul 2 08:57:18 2018 Info: ICID 3 ACCEPT SG UNKNOWNLIST match ipr[none] ipr not enabled
```

## Sender Domain Reputation Request Timeout

```

country not enabled
Mon Jul 2 08:57:18 2018 Info: Start MID 3 ICID 3
Mon Jul 2 08:57:18 2018 Info: MID 3 ICID 3 From: <sender1@example.com>
Mon Jul 2 08:57:18 2018 Info: MID 3 ICID 3 RID 0 To: <recipient1@example.com>
Mon Jul 2 08:57:18 2018 Info: MID 3 Message-ID '<000001cba32e$f24ff2e0$d6efd8a0$@com>' Mon
  Jul 2 08:57:18 2018 Info: MID 3 Subject 'Message 001'
Mon Jul 2 08:57:19 2018 Info: MID 3 SDR: Message was not scanned for Sender Domain Reputation.
  Reason: Authentication failure.

```

### Solution

Use the `sdradvancedconfig` command in the CLI to configure the required parameters when connecting your email gateway to the SDR service.

## Sender Domain Reputation Request Timeout

In this example, the log shows a message that was not filtered based on SDR because of a request timeout error when communicating with the SDR service.

```

Mon Jul 2 09:00:13 2018 Info: New SMTP ICID 4 interface Management (192.0.2.10) address
224.0.0.10 reverse dns host unknown verified no
Mon Jul 2 09:00:13 2018 Info: ICID 4 ACCEPT SG UNKNOWNLIST match ipr[none] ipr not enabled
  country not enabled
Mon Jul 2 09:00:13 2018 Info: Start MID 4 ICID 4
Mon Jul 2 09:00:13 2018 Info: MID 4 ICID 4 From: <sender1@example.com>
Mon Jul 2 09:00:13 2018 Info: MID 4 ICID 4 RID 0 To: <recipient1@example.com >
Mon Jul 2 09:00:13 2018 Info: MID 4 Message-ID '<000001cba32e$f24ff2e0$d6efd8a0$@com>'
Mon Jul 2 09:00:13 2018 Info: MID 4 Subject 'Message 001'
Mon Jul 2 09:00:13 2018 Info: MID 4 SDR: Message was not scanned for Sender Domain Reputation.
  Reason: Request timed out.

```

### Solution

When an SDR request times out, the message is marked as unscannable, and the configured actions are applied to the message.

## Sender Domain Reputation Invalid Host

In this example, the log shows a message that was not filtered based on SDR because an invalid SDR service host was configured on your email gateway.

```

Mon Jul 2 09:04:08 2018 Info: ICID 7 ACCEPT SG UNKNOWNLIST match ipr[none] ipr not enabled
  country not enabled
Mon Jul 2 09:04:08 2018 Info: Start MID 7 ICID 7
Mon Jul 2 09:04:08 2018 Info: MID 7 ICID 7 From: <sender1@example.com >
Mon Jul 2 09:04:08 2018 Info: MID 7 ICID 7 RID 0 To: <recipient1@example.com >
Mon Jul 2 09:04:08 2018 Info: MID 7 Message-ID '<000001cba32e$f24ff2e0$d6efd8a0$@com>' Mon
  Jul 2 09:04:08 2018 Info: MID 7 Subject 'Message 001'
Mon Jul 2 09:04:08 2018 Info: MID 7 SDR: Message was not scanned for Sender Domain Reputation.
  Reason: Invalid host configured.

```

### Solution

Use the `sdradvancedconfig` command in the CLI to configure the required parameters when connecting your email gateway to the SDR service.

## Sender Domain Reputation General Errors

In this example, the log shows a message that was not filtered based on SDR because of an unknown error.

```
Mon Jul 2 09:00:13 2018 Info: New SMTP ICID 4 interface Management (192.0.2.10) address
224.0.0.10 reverse dns host unknown verified no
Mon Jul 2 09:00:13 2018 Info: ICID 4 ACCEPT SG UNKNOWNLIST match ipr[none] ipr not enabled
country not enabled
Mon Jul 2 09:00:13 2018 Info: Start MID 4 ICID 4
Mon Jul 2 09:00:13 2018 Info: MID 4 ICID 4 From: <sender1@example.com >
Mon Jul 2 09:00:13 2018 Info: MID 4 ICID 4 RID 0 To: <recipient1@example.com >
Mon Jul 2 09:00:13 2018 Info: MID 4 Message-ID '<000001cba32e$f24ff2e0$d6efd8a0$@com>'
Mon Jul 2 09:00:13 2018 Info: MID 4 Subject 'Test mail'
Mon Jul 2 09:00:13 2018 Info: MID 4 SDR: Message was not scanned for Sender Domain Reputation.
Reason: Unknown error.
```

### Solution

When an unknown error occurs, the message is marked as unscannable, and the configured actions are applied to the message.

## Cisco Advanced Phishing Protection Cloud Service Expired

In this example, the log shows that the Cisco Advanced Phishing Protection Cloud Service expired.

```
Wed May 6 11:47:45 2020 Critical: The Cisco Advanced
Phishing Protection Cloud Service has expired and is disabled. Contact
your Cisco Account Manager to renew the service and enable it.
```

**Solution:** You need to contact your Cisco Account Manager to renew the service and enable it.

## Reminder about Cisco Advanced Phishing Protection Cloud Service Expiry Date

In this example, the log shows that the Cisco Advanced Phishing Protection Cloud Service will expire on a particular date.

```
Fri May 8 04:50:26 2020 Info: Cisco Advanced
Phishing Protection Cloud Service expires on
2020-05-10 07:00:00. You need to contact your Cisco Account
Manager to renew the service
```

**Solution:** You need to contact your Cisco Account Manager to renew the service.

## No API Access UID and API Access Secret Key

In this example, the log shows that the email gateway was unable to poll for the Cisco Advanced Phishing Protection Cloud Service expiry date because of no API Access UID and API Access Secret key.

```
Wed May 6 17:52:52 2020 Critical: Failed to poll
for the Cisco Advanced Phishing Protection Cloud Service
expiry date. You need to add the API Access UID and API Access
secret key.
```

**Solution:** You need to add the API Access UID and API Access secret key.

## Invalid API Access UID or API Access Secret Key

In this example, the log shows that the email gateway was unable to poll for the Cisco Advanced Phishing Protection Cloud Service expiry date because of an invalid API Access UID and API Access Secret key.

```
Wed May 6 17:52:52 2020 Critical: Failed to poll
for the Cisco Advanced Phishing Protection Cloud Service
expiry date because the API Access Key is invalid. You need
to re-configure the API Access UID and secret key
```

**Solution:** You need to re-configure the API Access UID and secret key.

## Using Delivery Logs

Delivery logs record critical information about the email delivery operations of AsyncOS. The log messages are “stateless,” meaning that all associated information is recorded in each log message and users need not reference previous log messages for information about the current delivery attempt.

The delivery log records all information pertaining to email delivery operations for each recipient. All information is laid out in a logical manner and is human-readable after conversion using a utility provided by Cisco. The conversion tools are located at: <https://supportforums.cisco.com/document/33721/cisco-ironport-systems-contributed-tools>

Delivery logs are recorded and transferred in a binary format for resource efficiency. Information recorded in delivery logs is shown in the following table:

**Table 125: Delivery Log Statistics**

Statistic	Description
Delivery status	Success (message was successfully delivered) or bounce (message was hard bounced)
Del_time	Delivery time
Inj_time	Injection time. $\text{del\_time} - \text{inj\_time}$ = time the recipient message stayed in the queue
Bytes	Message size
Mid	Message ID
Ip	Recipient host IP. The IP address of the host that received or bounced the recipient message
From	Envelope From, also known as Envelope Sender or MAIL FROM
Source_ip	Source host IP. The IP address of the host of the incoming message
Code	SMTP response code from recipient host
Reply	SMTP response message from recipient host
Rcpt Rid	Recipient ID. Recipient ID starts with <0>, messages with multiple recipients will have multiple recipient IDs
To	Envelope To
Attempts	Number of delivery attempts

If the delivery status was bounce, this additional information appears in the delivery log:

**Table 126: Delivery Log Bounce Information**

Statistic	Description
Reason	RFC 1893 Enhanced Mail Status Code interpretation of the SMTP response during the delivery
Code	SMTP response code from recipient host
Error	SMTP response message from recipient host

If you have set up logheaders (see [Logging Message Headers, on page 1216](#)), the header information appears after the delivery information:

**Table 127: Delivery Log Header Information**

Statistic	Description
Customer_data	XML tag marking the beginning of logged headers
Header Name	Name of the header
Value	Contents of the logged header

## Examples of Delivery Log Entries

The examples in this section show a variety of Delivery Log entries.

### Successful Message Delivery

```
Mon Mar 31 20:10:58 2003 Info: New SMTP DCID 5 interface 172.19.0.11 address
63.251.108.110

Mon Mar 31 20:10:58 2003 Info: Delivery start DCID 5 MID 4 to RID [0]

Mon Mar 31 20:10:58 2003 Info: Message done DCID 5 MID 4 to RID [0]

Mon Mar 31 20:11:03 2003 Info: DCID 5 close
```

### Delivery Status Bounce

```
<bounce del_time="Sun Jan 05 08:28:33.073 2003" inj_time="Mon Jan 05 08:28:32.929 2003"
bytes="4074" mid="94157762" ip="0.0.0.0" from="campaign1@yourdomain.com"
source_ip="192.168.102.1" reason="5.1.0 - Unknown address error" code="550"
error=["Requested action not taken: mailbox unavailable"]">

<rcpt rid="0" to="user@sampldomain.com" attempts="1" />

</bounce>
```

## Delivery Log Entry with Logheaders

```
<success del_time="Tue Jan 28 15:56:13.123 2003" inj_time="Tue Jan 28 15:55:17.696 2003"
bytes="139" mid="202" ip="10.1.1.13" from="campaign1@yourdomain.com"
source_ip="192.168.102.1" code="250" reply="sent">
```

```
<rcpt rid="0" to="user@sampldomain.com" attempts="1" />
```

```
<customer_data>
```

```
<header name="xname" value="sh"/>
```

```
</customer_data>
```

```
</success>
```

## Using Bounce Logs

The bounce log records all information pertaining to each bounced recipient. Information recorded in bounce logs is shown in the following table:

**Table 128: Bounce Log Statistics**

Statistic	Description
Timestamp	The time of the bounce event
Log level	The level of detail in this bounce log
Bounce type	Bounced or delayed (for example, hard or soft-bounce)
MID/RID	Message ID and recipient ID
From	Envelope From
To	Envelope To
Reason	RFC 1893 Enhanced Mail Status Code interpretation of the SMTP response during the delivery
Response	SMTP response code and message from recipient host

In addition, if you have specified message size to log or setup **logheaders** (see [Logging Message Headers, on page 1216](#)), the message and header information will appear after the bounce information:

**Table 129: Bounce Log Header Information**

Header	The header name and content in the header
Message	Content of the message logged

## Examples of Bounce Log Entries

### Soft-Bounced Recipient (Bounce Type = Delayed)

```
Thu Dec 26 18:37:00 2003 Info: Delayed: 44451135:0
From:<campaign1@yourdomain.com> To:<user@sampledomain.com>
```

```
Reason: "4.1.0 - Unknown address error" Response: "('451',
['<user@sampledomain.com> Automated block triggered by suspicious
activity from your IP address (10.1.1.1). Have your system administrator
send e-mail to postmaster@sampledomain.com if you believe this block is
in error'])"
```

### Hard-Bounced Recipient (Bounce Type = Bounced)

```
Thu Dec 26 18:36:59 2003 Info: Bounced: 45346670:0 From:<campaign1@yourdomain.com>
To:<user2@sampledomain.com>
```

```
Reason: "5.1.0 - Unknown address error" Response: "('550', ['There is no such active
account.'])"
```

### Bounce Log with Message Body and Logheaders

```
Wed Jan 29 00:06:30 2003 Info: Bounced: 203:0 From:<campaign1@yourdomain.com>
To:<user@sampledomain.com>
```

```
Reason:"5.1.2 - Bad destination host" Response: "('000', [])" Headers: ['xname:
userID2333']' Message: Message-Id:
```

```
<lu5jak$6b@yourdomain.com>\015\012xname: userID2333\015\012subject:
Greetings.\015\012\015\012Hi Tom:'
```



---

**Note** The text string \015\012 represents a line break (for example, CRLF).

---

## Using Status Logs

Status logs record system statistics found in the CLI status commands, including `status`, `status detail`, and `dnsstatus`. The period of recording is set using the `setup` subcommand in `logconfig`. Each counter or rate reported in status logs is the value since the last time the counter was reset.

## Reading Status Logs

The following table shows the status log labels and the matching system statistics.

**Table 130: Status Log Statistics**

Statistic	Description
CPULd	CPU Utilization

<b>Statistic</b>	<b>Description</b>
DskIO	Disk I/O Utilization
RAMUtil	RAM Utilization
QKUsd	Queue Kilobytes Used
QKFre	Queue Kilobytes Free
CrtMID	Message ID (MID)
CrtICID	Injection Connection ID (ICID)
CRTDCID	Delivery Connection ID (DCID)
InjBytes	Total Injected Message Size in Bytes
InjMsg	Injected Messages
InjRcp	Injected Recipients
GenBncRcp	Generated Bounce Recipients
RejRcp	Rejected Recipients
DrpMsg	Dropped Messages
SftBncEvt	Soft Bounced Events
CmpRcp	Completed Recipients
HrdBncRcp	Hard Bounced Recipients
DnsHrdBnc	DNS Hard Bounces
5XXHrdBnc	5XX Hard Bounces
FltrHrdBnc	Filter Hard Bounces
ExpHrdBnc	Expired Hard Bounces
OtrHrdBnc	Other Hard Bounces
DlvRcp	Delivered Recipients
DelRcp	Deleted Recipients
GlbUnsbHt	Global Unsubscribe Hits
ActvRcp	Active Recipients
UnatmptRcp	Unattempted Recipients
AtmptRcp	Attempted Recipients
CrtCncIn	Current Inbound Connections



<b>Statistic</b>	<b>Description</b>
CrtCncOut	Current Outbound Connections
DnsReq	DNS Requests
NetReq	Network Requests
CchHit	Cache Hits
CchMis	Cache Misses
CchEct	Cache Exceptions
CchExp	Cache Expired
CPUTTm	Total CPU time used by the application
CPUETm	Elapsed time since the application started
MaxIO	Maximum disk I/O operations per second for the mail process
RamUsd	Allocated memory in bytes
SwIn	Memory swapped in.
SwOut	Memory swapped out.
SwPgIn	Memory paged in.
SwPgOut	Memory paged out.
MMLen	Total number of messages in the system
DstInMem	Number of destination objects in memory
ResCon	Resource conservation tarpit value. Acceptance of incoming mail is delayed by this number of seconds due to heavy system load
WorkQ	This is the number of messages currently in the work queue
QuarMsgs	Number of individual messages in policy, virus, or outbreak quarantine (messages present in multiple quarantines are counted only once)
QuarQKUsd	KBytes used by policy, virus, and outbreak quarantine messages
LogUsd	Percent of log partition used
SophLd	Percent CPU used by Sophos anti-virus scanning
McaflD	Percent CPU used by McAfee anti-virus scanning
CASELd	Percent CPU used by CASE scanning
TotalLd	Total CPU consumption
LogAvail	Amount of disk space available for log files

Statistic	Description
EuQ	Estimated number of messages in the Spam quarantine
EuqRls	Estimated number of messages in the Spam quarantine release queue
RptLD	CPU load during the Reporting process
QtnLd	CPU load during the Quarantine process
EncrQ	Messages in the Encryption Queue

## Status Log Example

```

Fri Feb 28 12:11:48 2020 Info: Status: CPUld 45 DskIO 22 RAMUtil 22 QKUsd 6676975
QKFre 1711633 CrtMID 6130195 CrtICID 722770 CrtDCID 54 InjMsg 4572789 InjRcp
4575323 GenBncRcp 255536 RejRcp 20388 DrpMsg 469642 SftBncEvt 0 CmpRcp 3650806 HrdBncRcp
255536
DnsHrdBnc 23 5XXHrdBnc 28 FltrHrdBnc 255485 ExpHrdBnc 0
OtrHrdBnc 0 DlvRcp 3394965 DelRcp 305 GlbUnsbHt 0 ActvRcp 65 UnatmptRcp 65 AtmptRcp 0
CrtCncIn 9
CrtCncOut 0 DnsReq 7756744 NetReq 7769130 CchHit 8373490 CchMis
1989637 CchEct 1625236 CchExp 1569329 CPUTm 37 CPUETm 62 MaxIO 465600 RAMUsd 1473355956
MMLen 54782
DstInMem 11 ResCon 0 WorkQ 54710 QuarMsgs 375
QuarQKUsd 145096 LogUsd 26 SophLd 15 BMLd 0 CASELd 0 TotalLd 100 LogAvail 116G EuQ 64 EuqRls
0 CmrkLd 0
McafLd 9 SwIn 122 SwOut 5295 SwPgIn 368 SwPg Out 63639
SwapUsage 4% RptLd 0 QtnLd 19 EncrQ 0 InjBytes 516664777890

```

## Using Domain Debug Logs

Domain debug logs record the client and server communication during an SMTP conversation between the email gateway and a specified recipient host. This log type is primarily used to debug issues with specific recipient hosts.

**Table 131: Domain Debug Log Statistics**

Statistic	Description
Timestamp	The time of the bounce event
Log level	The level of detail in this bounce log
From	Envelope From
To	Envelope To
Reason	RFC 1893 Enhanced Mail Status Code interpretation of the SMTP response during the delivery
Response	SMTP response code and message from recipient host

## Domain Debug Log Example

```
Sat Dec 21 02:37:22 2003 Info: 102503993 Sent: 'MAIL FROM:<daily@dailyf-y-i.net>'
Sat Dec 21 02:37:23 2003 Info: 102503993 Rcvd: '250 OK'
Sat Dec 21 02:37:23 2003 Info: 102503993 Sent: 'RCPT TO:<LLLSMILE@aol.com>'
Sat Dec 21 02:37:23 2003 Info: 102503993 Rcvd: '250 OK'
Sat Dec 21 02:37:23 2003 Info: 102503993 Sent: 'DATA'
Sat Dec 21 02:37:24 2003 Info: 102503993 Rcvd: '354 START MAIL INPUT, END WITH "." ON A
LINE BY ITSELF'
Sat Dec 21 02:37:24 2003 Info: 102503993 Rcvd: '250 OK'
```

## Using Injection Debug Logs

Injection debug logs record the SMTP conversation between the email gateway and a specified host connecting to the system. Injection debug logs are useful for troubleshooting communication problems between the email gateway and a client initiating a connection from the Internet. The log records all bytes transmitted between the two systems and classifies them as “Sent to” the connecting host or “Received from” the connecting host.

You must designate the host conversations to record by specifying an IP address, an IP range, hostname, or partial hostname. Any connecting IP address within an IP range will be recorded. Any host within a partial domain will be recorded. The system performs reverse DNS lookups on connecting IP addresses to convert to hostnames. IP addresses without a corresponding PTR record in DNS will not match hostnames.

You must also specify the number of sessions to record.

Each line within an Injection Debug log contains the following information in the following table.

**Table 132: Injection Debug Log Statistics**

Statistic	Description
Timestamp	Time that the bytes were transmitted
ICID	The Injection Connection ID is a unique identifier that can be tied to the same connection in other log subscriptions
Sent/Received	Lines marked with “Sent to” are the actual bytes sent to the connecting host. Lines marked with “Received from” are the actual bytes received from the connecting host
IP Address	IP address of the connecting host

## Injection Debug Log Example

```
Wed Apr 2 14:30:04 2003 Info: 6216 Sent to '172.16.0.22': '220 postman.example.com
ESMTP\015\012'
Wed Apr 2 14:30:04 2003 Info: 6216 Rcvd from '172.16.0.22': 'HELO
mail.remotehost.com\015\012'
Wed Apr 2 14:30:04 2003 Info: 6216 Sent to '172.16.0.22': '250'
```

```

postman.example.com\015\012'
Wed Apr 2 14:30:04 2003 Info: 6216 Rcvd from '172.16.0.22': 'MAIL
FROM:<sender@remotehost.com>\015\012'
Wed Apr 2 14:30:04 2003 Info: 6216 Sent to '172.16.0.22': '250 sender
<sender@remotehost.com> ok\015\012'
Wed Apr 2 14:30:04 2003 Info: 6216 Rcvd from '172.16.0.22': 'RCPT
TO:<recipient@example.com>\015\012'
Wed Apr 2 14:30:04 2003 Info: 6216 Sent to '172.16.0.22': '250 recipient
<recipient@example.com> ok\015\012'
Wed Apr 2 14:30:04 Info: 6216 Rcvd from '172.16.0.22': 'DATA\015\012'

Wed Apr 2 14:30:04 2003 Info: 6216 Sent to '172.16.0.22': '354 go ahead\015\012'
Wed Apr 2 14:30:04 2003 Info: 6216 Rcvd from '172.16.0.22': 'To:
recipient@example.com\015\012Date: Apr 02 2003 10:09:44\015\012Subject: Test
Subject\015\012From: Sender <sender@remotehost.com>\015\012'

Wed Apr 2 14:30:04 2003 Info: 6216 Rcvd from '172.16.0.22': 'This is the content of the
message'
Wed Apr 2 14:30:04 Info: 6216 Sent to '172.16.0.22': '250 ok\015\012'

Wed Apr 2 14:30:04 Info: 6216 Rcvd from '172.16.0.22': 'QUIT\015\012'
Wed Apr 2 14:30:04 2003 Info: 6216 Sent to '172.16.0.22': '221
postman.example.com\015\012'

```

## Using System Logs

**Table 133: System Log Statistics**

Statistic	Description
Timestamp	Time that the bytes were transmitted
Message	The logged event

## System Log Example

In this example, the System log shows some commit entries, including the name of the user issuing the commit and the comment entered.

```

Wed Sep 8 18:02:45 2004 Info: Version: 4.0.0-206 SN: XXXXXXXXXXXXX-XXX

Wed Sep 8 18:02:45 2004 Info: Time offset from UTC: 0 seconds

Wed Sep 8 18:02:45 2004 Info: System is coming up

Wed Sep 8 18:02:49 2004 Info: bootstrapping DNS cache

Wed Sep 8 18:02:49 2004 Info: DNS cache bootstrapped

Wed Sep 8 18:13:30 2004 Info: PID 608: User admin commit changes: SSW>Password

Wed Sep 8 18:17:23 2004 Info: PID 608: User admin commit changes: Completed Web::SSW

Thu Sep 9 08:49:27 2004 Info: Time offset from UTC: -25200 seconds

Thu Sep 9 08:49:27 2004 Info: PID 1237: User admin commit changes: Added a second CLI
log for examples

Thu Sep 9 08:51:53 2004 Info: PID 1237: User admin commit changes: Removed example CLI

```

log.

## Using CLI Audit Logs

*Table 134: CLI Audit Log Statistics*

Statistic	Description
Timestamp	Time that the bytes were transmitted
PID	Process ID for the particular CLI session in which the command was entered
Message	The message consists of the CLI command entered, the CLI output (including menus, lists, etc.), and the prompt that is displayed

### CLI Audit Log Example

In this example, the CLI Audit log shows that, for PID 16434, the following CLI commands were entered: who, textconfig.

```
Thu Sep 9 14:35:55 2004 Info: PID 16434: User admin entered 'who'; prompt was
'\nmail3.example.com> '
```

```
Thu Sep 9 14:37:12 2004 Info: PID 16434: User admin entered 'textconfig'; prompt was
'\nUsername Login Time Idle Time Remote Host What\n=====
=====
=====
\nadmin Wed 11AM 3m 45s 10.1.3.14 tail\nadmin 02:32PM
0s 10.1.3.14 cli\nmail3.example.com> '
```

```
Thu Sep 9 14:37:18 2004 Info: PID 16434: User admin entered ''; prompt was '\nThere are
no text resources currently defined.\n\n\nChoose the operation you want to perform:\n-
NEW - Create a new text resource.\n- IMPORT - Import a text resource from a file.\n[]> '
```

## Using FTP Server Logs

*Table 135: FTP Server Log Statistics*

Statistic	Description
Timestamp	Time that the bytes were transmitted
ID	Connection ID. A separate ID for each FTP connection
Message	The message section of the log entry can be logfile status information, or FTP connection information (login, upload, download, logout, etc.)

### FTP Server Log Example

In this example, the FTP Server log records a connection (ID:1). The IP address of the incoming connection is shown, as well as the activity (uploading and downloading files) and the logout.

```

Wed Sep 8 18:03:06 2004 Info: Begin Logfile
Wed Sep 8 18:03:06 2004 Info: Version: 4.0.0-206 SN: 00065BF3BA6D-9WFWC21
Wed Sep 8 18:03:06 2004 Info: Time offset from UTC: 0 seconds
Wed Sep 8 18:03:06 2004 Info: System is coming up
Fri Sep 10 08:07:32 2004 Info: Time offset from UTC: -25200 seconds
Fri Sep 10 08:07:32 2004 Info: ID:1 Connection from 10.1.3.14 on 172.19.0.86
Fri Sep 10 08:07:38 2004 Info: ID:1 User admin login SUCCESS
Fri Sep 10 08:08:46 2004 Info: ID:1 Upload wording.txt 20 bytes
Fri Sep 10 08:08:57 2004 Info: ID:1 Download words.txt 1191 bytes
Fri Sep 10 08:09:06 2004 Info: ID:1 User admin logout

```

## Using HTTP Logs

**Table 136: HTTP Log Statistics**

Statistic	Description
Timestamp	Time that the bytes were transmitted
ID	Session ID
req	IP address of machine connecting
user	Username of user connecting
Message	Information regarding the actions performed. May include GET or POST commands or system status, etc.

## HTTP Log Example

In this example, the HTTP log shows the admin user's interaction with the GUI (running the System Setup Wizard, etc.).

```

Wed Sep 8 18:17:23 2004 Info: http service on 192.168.0.1:80 redirecting to https port 443
Wed Sep 8 18:17:23 2004 Info: http service listening on 192.168.0.1:80
Wed Sep 8 18:17:23 2004 Info: https service listening on 192.168.0.1:443
Wed Sep 8 11:17:24 2004 Info: Time offset from UTC: -25200 seconds
Wed Sep 8 11:17:24 2004 Info: req:10.10.10.14 user:admin id:iaCkEh2h5rZknQarAecg POST
/system_administration/system_setup_wizard HTTP/1.1 303
Wed Sep 8 11:17:25 2004 Info: req:10.10.10.14 user:admin id:iaCkEh2h5rZknQarAecg GET
/system_administration/ssw_done HTTP/1.1 200
Wed Sep 8 11:18:45 2004 Info: req:10.10.10.14 user:admin id:iaCkEh2h5rZknQarAecg GET
/monitor/incoming_mail_overview HTTP/1.1 200

```

```

Wed Sep 8 11:18:45 2004 Info: req:10.10.10.14 user:admin id:iaCkEh2h5rZknQarAecg GET
/monitor/mail_flow_graph?injector=&width=365&interval=0&type=recipientsin&height=190
HTTP/1.1 200

Wed Sep 8 11:18:46 2004 Info: req:10.10.10.14 user:admin id:iaCkEh2h5rZknQarAecg GET
/monitor/classification_graph?injector=&width=325&interval=0&type=recipientsin&height=190
HTTP/1.1 200

Wed Sep 8 11:18:49 2004 Info: req:10.10.10.14 user:admin id:iaCkEh2h5rZknQarAecg GET
/monitor/quarantines HTTP/1.1 200

```

## Using NTP Logs

*Table 137: NTP Log Statistics*

Statistic	Description
Timestamp	Time that the bytes were transmitted
Message	The message consists of either a Simple Network Time Protocol (SNTP) query to the server, or an adjust: message

### NTP Log Example

In this example, the NTP log shows the email gateway polling the NTP host twice.

```

Thu Sep 9 07:36:39 2004 Info: sntp query host 10.1.1.23 delay 653 offset -652

Thu Sep 9 07:36:39 2004 Info: adjust: time_const: 8 offset: -652us next_poll: 4096

Thu Sep 9 08:44:59 2004 Info: sntp query host 10.1.1.23 delay 642 offset -1152

Thu Sep 9 08:44:59 2004 Info: adjust: time_const: 8 offset: -1152us next_poll: 4096

```

## Using Scanning Logs

The scanning log contains all LOG and COMMON messages for the email gateway's scanning engines. See the Alerts section of the “System Administration” chapter for a list of available the COMMON and LOG alert messages.

*Table 138: Scanning Log Statistics*

Statistic	Description
Timestamp	Time that the bytes were transmitted
Message	The message consists of an application fault, sent alert, failed alert, or log error message for one of the scanning engines.

## Scanning Log Example

In this example, the log shows the history of an email gateway sending a warning alert concerning Sophos anti-virus.

```
Wed Feb 23 22:05:48 2011 Info: Internal SMTP system attempting to send a message to
alerts@example.com with subject 'Warning <Anti-Virus> mail3.example.com: sophos
antivirus - The Anti-Virus database on this system is...' (attempt #0).
```

```
Wed Feb 23 22:05:48 2011 Info: Internal SMTP system successfully sent a message to
alerts@example.com with subject 'Warning <Anti-Virus> mail3.example.com: sophos
antivirus - The Anti-Virus database on this system is...'
```

```
Wed Feb 23 22:05:48 2011 Info: A Anti-Virus/Warning alert was sent to alerts@example.com
with subject "Warning <Anti-Virus> mail3.example.com: sophos antivirus - The Anti-Virus
database on this system is...".
```

## Using Anti-Spam Logs

*Table 139: Anti-Spam Log Statistics*

Statistic	Description
Timestamp	Time that the bytes were transmitted
Message	The message consists of the check for the anti-spam updates, as well as the results (whether an update of the engine or the anti-spam rules was needed, etc.)

## Anti-Spam Log Example

In this example, the anti-spam log shows the anti-spam engine checking for updates to spam definitions and CASE updates:

```
Fri Apr 13 18:59:47 2007 Info: case antisipam - engine (19103) : case-daemon: server
successfully spawned child process, pid 19111
```

```
Fri Apr 13 18:59:47 2007 Info: case antisipam - engine (19111) : startup: Region profile:
Using profile global
```

```
Fri Apr 13 18:59:59 2007 Info: case antisipam - engine (19111) : fuzzy: Fuzzy plugin v7
successfully loaded, ready to roll
```

```
Fri Apr 13 19:00:01 2007 Info: case antisipam - engine (19110) : uribllocal: running URI
blocklist local
```

```
Fri Apr 13 19:00:04 2007 Info: case antisipam - engine (19111) : config: Finished loading
configuration
```

## Using Graymail Logs

Statistic	Description
Timestamp	Time that the bytes were transmitted



Statistic	Description
Message	The message contains information about the graymail engine, status, configuration, and so on.

## Graymail Log Example

```
Tue Mar 24 08:56:45 2015 Info: graymail [BASE] Logging at DEBUG level
Tue Mar 24 08:56:45 2015 Info: graymail [HANDLER] Initializing request handler
Tue Mar 24 08:56:50 2015 Info: graymail [ENGINE] Loaded graymail scanner library
Tue Mar 24 08:56:50 2015 Info: graymail [ENGINE] Created graymail scanner instance
Tue Mar 24 08:56:50 2015 Info: graymail [HANDLER] Debug mode disabled on graymail process
Tue Mar 24 08:56:50 2015 Info: graymail [HANDLER] Starting thread WorkerThread_0
```

## Using Anti-Virus Logs

*Table 140: AntiVirus Log Statistics*

Statistic	Description
Timestamp	Time that the bytes were transmitted
Message	The message consists of the check for the anti-virus update, as well as the results (whether an update of the engine or the virus definitions was needed, etc.)

## Anti-Virus Log Example

In this example, the Anti-Virus log shows the Sophos anti-virus engine checking for updates to virus definitions (IDE) and the engine itself.

```
Thu Sep 9 14:18:04 2004 Info: Checking for Sophos Update
Thu Sep 9 14:18:04 2004 Info: Current SAV engine ver=3.84. No engine update needed
Thu Sep 9 14:18:04 2004 Info: Current IDE serial=2004090902. No update needed.
```

You can temporarily set this to DEBUG level to help diagnose why the anti-virus engine returns a particular verdict for a given message. The DEBUG logging information is verbose; use with caution.

## Using AMP Engine Logs

The AMP Engine logs contain details of:

- File reputation query sent to the file reputation server and response received from the file reputation server.
- File analysis, if the file is uploaded to file analysis server. The status of the file analysis is recorded periodically until a response is received from the file analysis server.

## Examples of AMP Engine Log Entries

Following are sample AMP Engine log entries based on certain scenarios:

- [Initialization of File Reputation and File Analysis Servers, on page 1186](#)
- [File Reputation Server Not Configured, on page 1186](#)
- [Initialization of File Reputation Query, on page 1186](#)
- [Response Received for File Reputation Query from File Reputation Server, on page 1187](#)
- [File Uploaded for Analysis and File Analysis Process, on page 1188](#)
- [File Not Uploaded for Analysis, on page 1189](#)
- [File Upload Skipped for File Analysis due to File Upload Limit , on page 1189](#)
- [File Upload Skipped for File Analysis due to File Analysis Server Error, on page 1190](#)
- [File Retrospective Verdict Received, on page 1190](#)

### Initialization of File Reputation and File Analysis Servers

```
Wed Oct 5 15:17:31 2016 Info: File reputation service initialized successfully
Wed Oct 5 15:17:31 2016 Info: The following file type(s) can be sent for File Analysis:
Microsoft Windows / DOS Executable, Microsoft Office 97-2004 (OLE), Microsoft Office 2007+
(Open XML), Other potentially malicious file types, Adobe Portable Document Format (PDF).
To allow analysis of new file type(s), go to Security Services > File Reputation and
Analysis.
Wed Oct 5 15:17:31 2016 Info: File Analysis service initialized successfully
```

### File Reputation Server Not Configured

```
Tue Oct 4 23:15:24 2016 Warning: MID 12 reputation query failed for attachment 'Zombies.pdf'
with error "Cloud query failed"
```

### Initialization of File Reputation Query

```
Fri Oct 7 09:44:04 2016 Info: File reputation query initiating. File Name = 'mod-6.exe',
MID = 5, File Size = 1673216 bytes,
File Type = application/x-dosexec
```

Statistic	Description
File Name	The name of the file whose SHA-256 hash identifier is sent to the file reputation server. If the file name is not available, it is termed as unknown .
MID	The Message ID used to track messages that flow through the email pipeline.
File Size	The size of the file whose SHA-256 hash identifier is sent to the file reputation server.

Statistic	Description
File Type	<p>The type of the file whose SHA-256 hash identifier is sent to the file reputation server.</p> <p>Following are the supported file types:</p> <ul style="list-style-type: none"> <li>• Microsoft Windows / DOS Executable</li> <li>• Microsoft Office 97-2004 (OLE)</li> <li>• Microsoft Office 2007+ (Open XML)</li> <li>• Other potentially malicious file types</li> <li>• Adobe Portable Document Format (PDF)</li> </ul>

### Response Received for File Reputation Query from File Reputation Server

```
Fri Oct 7 09:44:06 2016 Info: Response received for file reputation query from Cloud. File
Name = 'mod-6.exe', MID = 5, Disposition = MALICIOUS, Malware = W32.061DEF69B5-100.SBX.TG,
Reputation Score = 73, sha256 =
061def69b5c100e9979610fa5675bd19258b19a7ff538b5c2d230b467c312f19, upload_action = 2
```

Statistic	Description
File Name	<p>The name of the file whose SHA-256 hash identifier is sent to the file reputation server.</p> <p>If the file name is not available, it is termed as unknown .</p>
MID	The message ID used to track messages that flow through the email pipeline.
Disposition	<p>The file reputation disposition values are:</p> <ul style="list-style-type: none"> <li>• MALICIOUS</li> <li>• CLEAN</li> <li>• FILE UNKNOWN - When the reputation score is zero.</li> <li>• VERDICT UNKNOWN - When the disposition is FILE UNKNOWN and score is non-zero.</li> <li>• LOW RISK - When no dynamic content is found in a file after file analysis, the verdict is Low Risk. The file is not sent for file analysis, and the message continues through the email pipeline.</li> </ul>
Malware	The name of the malware threat.
Reputation score	<p>The reputation score assigned to the file by the file reputation server.</p> <p>If the file disposition is <b>VERDICT UNKNOWN</b>, the email gateway adjusts the file reputation verdict based on the reputation score and the threshold value.</p>

Statistic	Description
Upload Action	<p>The upload action value recommended by the file reputation server to take on the given file:</p> <ul style="list-style-type: none"> <li>• 0 - Need not send for upload</li> <li>• 1 - Send file for upload.</li> </ul> <p><b>Note</b> The email gateway uploads the file when the upload action value is '1.'</p> <ul style="list-style-type: none"> <li>• 2 - Do not send file for upload</li> <li>• 3 - Send only metadata for upload</li> </ul>

### File Uploaded for Analysis and File Analysis Process

Wed Sep 28 11:31:58 2016 Info: File uploaded for analysis. SHA256: e7ae35a8227b380ca761c0317e814e4aaa3d04f362c6b913300117241800f0ea

Wed Sep 28 11:36:58 2016 Info: File Analysis is running for SHA: e7ae35a8227b380ca761c0317e814e4aaa3d04f362c6b913300117241800f0ea

Fri Oct 7 07:39:13 2016 Info: File Analysis complete. SHA256: 16454aff5082c2e9df43f3e3b9cdba3c6ae1766416e548c30a971786db570bfc, Submit Timestamp: 1475825466, Update Timestamp: 1475825953, Disposition: 3 Score: 100, run\_id: 194926004  
 Details: Analysis is completed for the File  
 SHA256[16454aff5082c2e9df43f3e3b9cdba3c6ae1766416e548c30a971786db570bfc]  
 Spyname: [W32.16454AFF50-100.SBX.TG]

Statistic	Description
SHA256	The SHA-256 hash identifier for the corresponding file.
Submit Timestamp	The date and time at which the file is uploaded to the file analysis server by the email gateway.
Update Timestamp	The date and time at which the file analysis for the file is complete
Disposition	<p>The file reputation disposition values are.</p> <ul style="list-style-type: none"> <li>• 1 - No malware detected</li> <li>• 2 - Clean</li> <li>• 3 - Malware</li> </ul>
Score	The analysis score assigned to the file by the file analysis server.
Run ID	The numeric value (ID) assigned to the file by the file analysis server for a particular file analysis.
Details	Additional information if errors are reported during file analysis, otherwise it indicates that the final analysis is complete for the file.
Spy Name	The name of the threat, if a malware is found in the file during file analysis.

## File Not Uploaded for Analysis

Wed Sep 14 12:27:52 2016 Info: File not uploaded for analysis. MID = 0 File SHA256[a5f28f1fed7c2fe88bcd403710098977fa12c32d13bfd78bbe27e95b245f82] file mime[text/plain] Reason: No active/dynamic contents exists

Statistic	Description
MID	The message ID used to track messages that flow through the email pipeline.
File MIME	The MIME type of the file.
Reason	<p>Following are one of the reason values for file not uploaded to the file analysis server even when the upload_action is set to '1':</p> <ul style="list-style-type: none"> <li>• File already uploaded by another node - The file is already uploaded to the file analysis server via another email gateway.</li> <li>• File analysis in progress - File is already selected for upload which is in progress.</li> <li>• File already uploaded to File Analysis server</li> <li>• Not a supported File type</li> <li>• File size is out of bounds - The upload file size exceeds the threshold limit set by the file analysis server.</li> <li>• Upload queue was full</li> <li>• File Analysis server error</li> <li>• No active/dynamic contents exists</li> <li>• Generic/Unknown Error</li> </ul>

## File Upload Skipped for File Analysis due to File Upload Limit

Tue Jun 20 13:22:56 2017 Info: File analysis upload skipped. SHA256: b5c7e26491983baa713c9a2910ee868efd891661c6a0553b28f17b8fdc8cc3ef, Timestamp[1454782976] details[File SHA256[b5c7e26491983baa713c9a2910ee868efd891661c6a0553b28f17b8fdc8cc3ef] file mime[application/pdf], upload priority[Low] not uploaded, re-tries[3], backoff[986] discarding ...]  
 Tue Jun 20 13:22:56 2017 Critical: The attachment could not be uploaded to the File Analysis server because the appliance exceeded the upload limit

Statistic	Description
SHA256	The SHA-256 hash identifier for the corresponding file.
Timestamp	The date and time at which the file failed to upload to the file analysis server.
Details	Details of the File Analysis server error.
File MIME	The MIME type of the file.
Upload priority	<p>Upload priority values are:</p> <ul style="list-style-type: none"> <li>• High - For all selected file types, except PDF file type.</li> <li>• Low - For only PDF file types</li> </ul>
Re-tries	<p>The number of upload attempts performed on a given file.</p> <p><b>Note</b> A maximum of three upload attempts can be performed on a given file.</p>

Statistic	Description
Backoff (x)	The number of (x) seconds before the email gateway needs to wait before it makes an attempt to upload the file to the file analysis server. This occurs when the email gateway reaches the daily upload limit.
Critical (Reason)	The attachment could not be uploaded to the File Analysis server because the email gateway exceeded the upload limit.

### File Upload Skipped for File Analysis due to File Analysis Server Error

```
Sat Feb 6 13:22:56 2016 Info:SHA256:
69e17e213732da0d0cbc48ae7030a4a18e0c1289f510e8b139945787f67692a5, Timestamp [1454959409]
details[Server Response HTTP code:[502]]
```

Statistic	Description
SHA256	The SHA-256 hash identifier for the corresponding file.
Timestamp	The date and time at which an attempt is made to upload the file to the file analysis server.
Details	Information about the File Analysis server error.

### File Retrospective Verdict Received

```
Fri Oct 7 07:39:13 2016 Info: Retrospective verdict received. SHA256:
16454aff5082c2e9df43f3e3b9cdba3c6ae1766416e548c30a971786db570bfc, Timestamp: 1475832815.7,
Verdict: MALICIOUS, Reputation Score: 0, Spyname: W32.16454AFF50-100.SBX.
```

Statistic	Description
SHA256	The SHA-256 hash identifier for the corresponding file.
Timestamp	The date and time at which a file retrospective verdict is received from the file analysis server.
Verdict	The file retrospective verdict value is malicious or clean .
Reputation Score	The reputation score assigned to the file by the file reputation server.
Spyname	The name of the threat, if a malware is found in the file during file analysis.

## Using Spam Quarantine Logs

Table 141: Spam Log Statistics

Statistic	Description
Timestamp	Time that the bytes were transmitted

Statistic	Description
Message	The message consists of actions taken (messages quarantined, released from quarantine, etc.).

## Spam Quarantine Log Example

In this example, the log shows a message (MID 8298624) being released from the quarantine to admin@example.com.

```
Mon Aug 14 21:41:47 2006 Info: ISQ: Releasing MID [8298624, 8298625] for all
Mon Aug 14 21:41:47 2006 Info: ISQ: Delivering released MID 8298624 (skipping work
queue)
Mon Aug 14 21:41:47 2006 Info: ISQ: Released MID 8298624 to admin@example.com
Mon Aug 14 21:41:47 2006 Info: ISQ: Delivering released MID 8298625 (skipping work
queue)
Mon Aug 14 21:41:47 2006 Info: ISQ: Released MID8298625 to admin@example.com
```

## Using Spam Quarantine GUI Logs

*Table 142: Spam GUI Log Statistics*

Statistic	Description
Timestamp	Time that the bytes were transmitted
Message	The message consists of actions taken, including user authentication, etc.

## Spam Quarantine GUI Log Example

In this example, the log shows a successful authentication, login and logout:

```
Fri Aug 11 22:05:28 2006 Info: ISQ: Serving HTTP on 192.168.0.1, port 82
Fri Aug 11 22:05:29 2006 Info: ISQ: Serving HTTPS on 192.168.0.1, port 83
Fri Aug 11 22:08:35 2006 Info: Authentication OK, user admin
Fri Aug 11 22:08:35 2006 Info: logout:- user:pqufOtL6vyI5StCqhCfO session:10.251.23.228
Fri Aug 11 22:08:35 2006 Info: login:admin user:pqufOtL6vyI5StCqhCfO
session:10.251.23.228
Fri Aug 11 22:08:44 2006 Info: Authentication OK, user admin
```

## Using LDAP Debug Logs

*Table 143: LDAP Debug Log Statistics*

Statistic	Description
Timestamp	Time that the bytes were transmitted
Message	LDAP Debug message

### LDAP Debug Log Example



**Note** Individual lines in log files are NOT numbered. They are numbered here only for sample purposes

1	Thu Sep 9 12:24:56 2004 Begin Logfile
2	Thu Sep 9 12:25:02 2004 LDAP: Masquerade query sun.masquerade address employee@routing.qa to employee@mail.qa
3	Thu Sep 9 12:25:02 2004 LDAP: Masquerade query sun.masquerade address employee@routing.qa to employee@mail.qa
4	Thu Sep 9 12:25:02 2004 LDAP: Masquerade query sun.masquerade address employee@routing.qa to employee@mail.qa
5	Thu Sep 9 12:28:08 2004 LDAP: Clearing LDAP cache
6	Thu Sep 9 13:00:09 2004 LDAP: Query '(&(ObjectClass={g})(mailLocalAddress={a}))' to server sun (sun.qa:389)
7	Thu Sep 9 13:00:09 2004 LDAP: After substitute, query is '(&(ObjectClass=inetLocalMailRecipient) (mailLocalAddress=rroute.d00002b.loc@ldap.route.local.add00002.qa))'
8	Thu Sep 9 13:00:09 2004 LDAP: connecting to server
9	Thu Sep 9 13:00:09 2004 LDAP: connected
10	Thu Sep 9 13:00:09 2004 LDAP: Query (&(ObjectClass=inetLocalMailRecipient) (mailLocalAddress=rroute.d00002b.loc@ldap.route.local.add00002.qa)) returned 1 results
11	Thu Sep 9 13:00:09 2004 LDAP: returning: [<LDAP:>]

Use as a guide to reading the preceding log file.



Table 144: Detail of LDAP Debug Log Example

Line Number	Description
1	The log file is initialized.
2	The listener is configured to use LDAP for masquerading, specifically with the LDAP query named "sun.masquerade."
3	
4	The address employee@routing.qa is looked up in the LDAP server, a match is found, and the resulting masquerade address is employee@mail.qa, which will be written to the message headers and/or the envelope from, depending on the masquerade configuration.
5	The user has manually run ldapflush .
6	A query is about to be sent to sun.qa, port 389. The query template is: (&(ObjectClass={g})(mailLocalAddress={a})).  The {g} will be replaced by the groupname specified in the calling filter, either a rcpt-to-group or mail-from-group rule.  The {a} will be replaced by the address in question.
7	Now the substitution (described previously) takes place, and this is what the query looks like before it is sent to the LDAP server.
8	The connection to the server is not yet established, so make a connection.
9	The data that is sent to the server.
10	The result is an empty positive, meaning one record was returned, but since the query didn't ask for any fields, there is no data to report. These are used for both group and accept queries when the query checks to see if there is a match in the database.

## Using Safelist/Blocklist Logs

The following table shows the statistics recorded in safelist/blocklist logs.

Table 145: Safelist/Blocklist Log Statistics

Statistic	Description
Timestamp	Time that the bytes were transmitted.
Message	The message consists of actions taken, including user authentication, and so forth.

## Safelist/Blocklist Log Example

In this example, the safelist/blocklist log shows the email gateway creating database snapshots every two hours. It also shows when senders were added to the database.

```
Fri Sep 28 14:22:33 2007 Info: Begin Logfile Fri Sep 28 14:22:33 2007 Info: Version:
6.0.0-425 SN: XXXXXXXXXXXX-XXX Fri Sep 28 14:22:33 2007 Info: Time offset from UTC:
10800 seconds Fri Sep 28 14:22:33 2007 Info: System is coming up.
```

```

Fri Sep 28 14:22:33 2007 Info: SLBL: The database snapshot has been created.
Fri Sep 28 16:22:34 2007 Info: SLBL: The database snapshot has been created.
Fri Sep 28 18:22:34 2007 Info: SLBL: The database snapshot has been created.
Fri Sep 28 20:22:34 2007 Info: SLBL: The database snapshot has been created.
Fri Sep 28 22:22:35 2007 Info: SLBL: The database snapshot has been created.
.....
Mon Oct 1 14:16:09 2007 Info: SLBL: The database snapshot has been created.
Mon Oct 1 14:37:39 2007 Info: SLBL: The database snapshot has been created.
Mon Oct 1 15:31:37 2007 Warning: SLBL: Adding senders to the database failed.
Mon Oct 1 15:32:31 2007 Warning: SLBL: Adding senders to the database failed.
Mon Oct 1 16:37:40 2007 Info: SLBL: The database snapshot has been created.

```

## Using Reporting Logs

The following table shows the statistics recorded in reporting logs.

**Table 146: Reporting Log Statistics**

Statistic	Description
Timestamp	Time that the bytes were transmitted.
Message	The message consists of actions taken, including user authentication, and so forth.

## Reporting Log Example

In this example, the Reporting log shows the email gateway set at the information log level.

```

Wed Oct 3 13:39:53 2007 Info: Period minute using 0 (KB)
Wed Oct 3 13:39:53 2007 Info: Period month using 1328 (KB)
Wed Oct 3 13:40:02 2007 Info: Update 2 registered appliance at 2007-10-03-13-40
Wed Oct 3 13:40:53 2007 Info: Pages found in cache: 1304596 (99%). Not found: 1692
Wed Oct 3 13:40:53 2007 Info: Period hour using 36800 (KB)
Wed Oct 3 13:40:53 2007 Info: Period day using 2768 (KB)
Wed Oct 3 13:40:53 2007 Info: Period minute using 0 (KB)
Wed Oct 3 13:40:53 2007 Info: Period month using 1328 (KB)
Wed Oct 3 13:40:53 2007 Info: HELPER checkpointed in 0.00580507753533 seconds
Wed Oct 3 13:41:02 2007 Info: Update 2 registered appliance at 2007-10-03-13-41

```

```

Wed Oct 3 13:41:53 2007 Info: Pages found in cache: 1304704 (99%). Not found: 1692
Wed Oct 3 13:41:53 2007 Info: Period hour using 36800 (KB)
Wed Oct 3 13:41:53 2007 Info: Period day using 2768 (KB)
Wed Oct 3 13:41:53 2007 Info: Period minute using 0 (KB)
Wed Oct 3 13:41:53 2007 Info: Period month using 1328 (KB)
Wed Oct 3 13:42:03 2007 Info: Update 2 registered appliance at 2007-10-03-13-42

```

## Using Reporting Query Logs

The following table shows the statistics recorded in reporting query logs.

**Table 147: Reporting Query Log Statistics**

Statistic	Description
Timestamp	Time that the bytes were transmitted.
Message	The message consists of actions taken, including user authentication, and so forth.

## Reporting Query Log Example

In this example, the reporting query log shows the email gateway running a daily outgoing email traffic query for the period from August 29 to October 10, 2007.

```

Tue Oct 2 11:30:02 2007 Info: Query: Closing interval handle 811804479.
Tue Oct 2 11:30:02 2007 Info: Query: Closing interval handle 811804480.
Tue Oct 2 11:30:02 2007 Info: Query: Closing query handle 302610228.
Tue Oct 2 11:30:02 2007 Info: Query: Merge query with handle 302610229 for
['MAIL_OUTGOING_TRAFFIC_SUMMARY.
DETECTED_SPAM', 'MAIL_OUTGOING_TRAFFIC_SUMMARY.DETECTED_VIRUS',
'MAIL_OUTGOING_TRAFFIC_SUMMARY.THREAT_CONTENT_FILTER',
'MAIL_OUTGOING_TRAFFIC_SUMMARY.TOTAL_CLEAN_RECIPIENTS',
'MAIL_OUTGOING_TRAFFIC_SUMMARY.TOTAL_RECIPIENTS_PROCESSED'] for rollup period "day" with
interval range 2007-08-29 to 2007-10-01
with key constraints
None sorting on ['MAIL_OUTGOING_TRAFFIC_SUMMARY.DETECTED_SPAM'] returning results from
0 to 2 sort_ascending=False.
Tue Oct 2 11:30:02 2007 Info: Query: Closing query handle 302610229.
Tue Oct 2 11:30:02 2007 Info: Query: Merge query with handle 302610230 for
['MAIL_OUTGOING_TRAFFIC_SUMMARY.
TOTAL_HARD_BOUNCES', 'MAIL_OUTGOING_TRAFFIC_SUMMARY.TOTAL_RECIPIENTS_DELIVERED',
'MAIL_OUTGOING_TRAFFIC_SUMMARY.TOTAL_RECIPIENTS'] for rollup period "day" with interval
range 2007-08-29 to
2007-10-01 with key constraints None sorting on
['MAIL_OUTGOING_TRAFFIC_SUMMARY.TOTAL_HARD_BOUNCES'] returning
results from 0 to 2 sort_ascending=False.

```

Tue Oct 2 11:30:02 2007 Info: Query: Closing query handle 302610230.

## Using Updater Logs

*Table 148: Updater Log Statistics*

Statistic	Description
Timestamp	Time that the bytes were transmitted.
Message	The message consists of system service update information, as well as AsyncOS checking for updates and the scheduled date and time of the next update.

## Updater Log Example

In this example, the logs show the email gateway being updated with new McAfee Anti-Virus definitions.

```

Fri Sep 19 11:07:51 2008 Info: Starting scheduled update
Fri Sep 19 11:07:52 2008 Info: Acquired server manifest, starting update 11
Fri Sep 19 11:07:52 2008 Info: Server manifest specified an update for mcafee
Fri Sep 19 11:07:52 2008 Info: mcafee was signalled to start a new update
Fri Sep 19 11:07:52 2008 Info: mcafee processing files from the server manifest
Fri Sep 19 11:07:52 2008 Info: mcafee started downloading files
Fri Sep 19 11:07:52 2008 Info: mcafee downloading remote file
"http://stage-updates.ironport.com/mcafee/dat/5388"
Fri Sep 19 11:07:52 2008 Info: Scheduled next update to occur at Fri Sep 19 11:12:52
2008
Fri Sep 19 11:08:12 2008 Info: mcafee started decrypting files
Fri Sep 19 11:08:12 2008 Info: mcafee decrypting file
"mcafee/dat/5388" with method "des3_cbc"
Fri Sep 19 11:08:17 2008 Info: mcafee started decompressing files
Fri Sep 19 11:08:17 2008 Info: mcafee started applying files
Fri Sep 19 11:08:17 2008 Info: mcafee applying file "mcafee/dat/5388"
Fri Sep 19 11:08:18 2008 Info: mcafee verifying applied files
Fri Sep 19 11:08:18 2008 Info: mcafee updating the client manifest
Fri Sep 19 11:08:18 2008 Info: mcafee update completed
Fri Sep 19 11:08:18 2008 Info: mcafee waiting for new updates
Fri Sep 19 11:12:52 2008 Info: Starting scheduled update
Fri Sep 19 11:12:52 2008 Info: Scheduled next update to occur at Fri Sep 19 11:17:52
2008

```

```
Fri Sep 19 11:17:52 2008 Info: Starting scheduled update
Fri Sep 19 11:17:52 2008 Info: Scheduled next update to occur at Fri Sep 19 11:22:52
2008
```

## Updater Log Example

In this example, the logs show the automatic updates being disabled and backup being applied to the Sophos Anti-Virus definitions.

```
Fri Mar 10 15:05:55 2017 Debug: Skipping update request for "postx"
Fri Mar 10 15:05:55 2017 Debug: postx updates disabled
Fri Mar 10 15:05:55 2017 Debug: Skipping update request for "postx"
Fri Mar 10 15:05:55 2017 Trace: command session starting
Fri Mar 10 15:05:55 2017 Info: Automatic updates disabled for engine Sophos engine
Fri Mar 10 15:05:55 2017 Info: Sophos: Backup update applied successfully
Fri Mar 10 15:05:55 2017 Info: Internal SMTP system attempting to send a message to
abshastr@ironport.com
with subject 'Automatic updates are now disabled for sophos' attempt #0).
Fri Mar 10 15:05:55 2017 Debug: amp feature key disabled
Fri Mar 10 15:05:55 2017 Debug: Skipping update request for "amp"
Fri Mar 10 15:05:55 2017 Debug: amp feature key disabled
```

## Understanding Tracking Logs

Tracking logs record information about the email operations of AsyncOS. The log messages are a subset of the messages recorded in the mail logs.

The tracking logs are used by the email gateway's message tracking component to build the message tracking database. Because the log files are consumed in the process of building the database, the tracking logs are transient. The information in tracking logs is not designed to be read or analyzed by humans.

You can also view tracking information from multiple email gateways using the Cisco Secure Manager Email and Web Gateway.

## Using Authentication Logs

The authentication log records successful user logins and unsuccessful login attempts.

**Table 149: Authentication Log Statistics**

Statistic	Description
Timestamp	Time that the bytes were transmitted.
Message	The message consists of the username and the user privilege role details (for example, 'admin,' 'operator,' and so on) of a user who attempted to log in to the email gateway and whether the user was authenticated successfully.

## Authentication Log Example

In this example, the log shows the log in attempts by users “admin,” “joe,” and “dan.”

```
Wed Sep 17 15:16:25 2008 Info: Begin Logfile
Wed Sep 17 15:16:25 2008 Info: Version: 6.5.0-262 SN: XXXXXXX-XXXXX
Wed Sep 17 15:16:25 2008 Info: Time offset from UTC: 0 seconds
Wed Sep 17 15:18:21 2008 Info: User admin was authenticated successfully.
Wed Sep 17 16:26:17 2008 Info: User joe failed authentication.
Wed Sep 17 16:28:28 2008 Info: User joe was authenticated successfully.
Wed Sep 17 20:59:30 2008 Info: User admin was authenticated successfully.
Wed Sep 17 21:37:09 2008 Info: User dan failed authentication.
```

## Example of Two-Factor Authentication Login Failure due to incorrect passcode

In this example, the log shows the two-factor authentication login failure due to incorrect passcode entered.

```
Thu Mar 16 05:47:47 2017 Info: Trying RADIUS server example.cisco.com
Thu Mar 16 05:48:18 2017 Info: Two-Factor RADIUS Authentication failed.
Thu Mar 16 05:48:48 2017 Info: An authentication attempt by the user **** from
21.101.210.150 failed
```

## Example of Two-Factor Authentication Login Failure due to time-out

In this example, the log shows the two-factor authentication login failure due to a time-out.

```
Thu Mar 16 05:46:04 2017 Info: Trying RADIUS server example.cisco.com
Thu Mar 16 05:46:59 2017 Info: RADIUS server example.cisco.com communication error. No
valid responses from server (timeout).
Thu Mar 16 05:46:59 2017 Info: Two-Factor Authentication RADIUS servers timed out.
Authentication could fail due to this.
```

## Example of Two-Factor Authentication Login Success

In this example, the log shows the two-factor authentication login was successful.

```
Thu Mar 16 05:49:05 2017 Info: Trying RADIUS server example.cisco.com
Thu Mar 16 05:49:05 2017 Info: Two-Factor RADIUS Authentication was successful.
Thu Mar 16 05:49:05 2017 Info: The user admin successfully logged on from 21.101.210.150
with privilege admin using an HTTPS connection.
```

## Using Configuration History Logs

A configuration history log consists of a configuration file with an additional section listing the name of the user, a description of where in the configuration the user made changes, and the comment the user entered when committing the change. Each time a user commits a change, a new log is created containing the configuration file after the change.

## Configuration History Log Example

In this example, the configuration history log shows that the user (admin) added a guest user to the table that defines which local users are allowed to log in to the system.

```
<?xml version="1.0" encoding="ISO-8859-1"?>
<!DOCTYPE config SYSTEM "config.dtd">
<!--
XML generated by configuration change.
Change comment: added guest user
User: admin
Configuration are described as:
This table defines which local users are allowed to log into the system.
Product: Cisco IronPort M160 Messaging Gateway(tm) Appliance
Model Number: M160
Version: 6.7.0-231
Serial Number: 000000000ABC-D000000
Number of CPUs: 1
Memory (GB): 4
Current Time: Thu Mar 26 05:34:36 2009
Feature "Cisco IronPort Centralized Configuration Manager": Quantity = 10, Time Remaining = "25 days"
Feature "Centralized Reporting": Quantity = 10, Time Remaining = "9 days"
Feature "Centralized Tracking": Quantity = 10, Time Remaining = "30 days"
Feature "Centralized Spam Quarantine": Quantity = 10, Time Remaining = "30 days"
Feature "Receiving": Quantity = 1, Time Remaining = "Perpetual"
-->
<config>
```

## Using External Threat Feeds Engine Logs

The ETF Logs contain information about the ETF engine, status, configuration, and so on. Most information is at the Info or Debug level.

### Example of External Threat Feeds Engine Logs

```
Thu Jun 7 04:54:15 2018 Info: THREAT_FEEDS: Job failed with exception: Invalid URL or Port
Thu Jun 7 05:04:13 2018 Info: THREAT_FEEDS: A delta poll is scheduled for the source: S1
Thu Jun 7 05:04:13 2018 Info: THREAT_FEEDS: A delta poll has started for the source: S1,
```

## ETF Source Configuration Failure - Invalid Collection Name

```

domain: s1.co, collection: sss
Thu Jun 7 05:04:13 2018 Info: THREAT_FEEDS: Observables are being fetched from the source:
  S1 between 2018-06-07 04:34:13+00:00 and 2018-06-07 05:04:13.185909+00:00
Thu Jun 7 05:04:13 2018 Info: THREAT_FEEDS: 21 observables were fetched from the source:
  S1
Thu Jun 7 05:19:14 2018 Info: THREAT_FEEDS: A delta poll is scheduled for the source: S1
Thu Jun 7 05:19:14 2018 Info: THREAT_FEEDS: A delta poll has started for the source: S1,
domain: s1.co, collection: sss

```

### ETF Source Configuration Failure - Invalid Collection Name

In this example, the log shows that your email gateway was not able to fetch threat feeds from an external threat feed source because of an invalid collection name.

```

Info: THREAT_FEEDS: [TaxiiClient] Failed to poll threat feeds from following source:
  hailataxii.com, cause of failure: Invalid Collection name

```

#### Solution

Go to *Mail Policies > External Threat Feeds Manager* page in the web interface or use the `threatfeedsconfig > sourceconfig` subcommand in the CLI and enter the correct collection name for the configured external threat feed source.

### ETF Source Configuration Failure - HTTP Error

In this example, the log shows that your email gateway was not able to fetch threat feeds from an external threat feed source because of an HTTP error.

```

Info: THREAT_FEEDS: [TaxiiClient] Failed to poll threat feeds from following source:
  hailataxii.com , cause of failure: HTTP Error

```

#### Solution

Go to *Mail Policies > External Threat Feeds Manager* page in the web interface or use the `threatfeedsconfig > sourceconfig` subcommand in the CLI and enter the correct polling path or user authentication credentials for the configured external threat feed source.

### ETF Source Configuration Failure - Invalid URL

In this example, the log shows that your email gateway was not able to fetch threat feeds from an external threat feed source because of an invalid URL.

```

Info: THREAT_FEEDS: [TaxiiClient] Failed to poll threat feeds from following source:
  hailataxii.com , cause of failure: HTTP Error

```

#### Solution

Go to *Mail Policies > External Threat Feeds Manager* page in the web interface or use the `threatfeedsconfig > sourceconfig` subcommand in the CLI and enter the correct hostname or port number for the configured external threat feed source.

## Using Consolidated Event Logs

When configuring a log subscription with the log type as Consolidated Event Logs, use the 'Log Fields' option if you want to include specific message attributes in a single log line output.

The following log fields are selected by default when you configure a log subscription with the log type as Consolidated Event Log:



- ICID
- DCID
- Serial Number
- MID



**Note** You cannot remove any of the default log fields from the Selected Log Fields list.

### Example of Consolidated Event Logs

In this example, the log shows all the available fields selected when you configure a log subscription with the log type as Consolidated Event Logs.

```
Thu Mar 18 08:04:50 2021: CEF:0|Cisco|C100V Email Security Virtual Appliance|14.0.0-657
|ESA_CONSOLIDATED_LOG_EVENT|Consolidated Log
Event|5|deviceExternalId=42127C7DDEE76852677B-F80CE8074CD3
ESAMID=1053 ESAICID=134 ESAAMPVerdict=UNKNOWN ESAASVerdict=NEGATIVE ESAAVVerdict=NEGATIVE
ESACFVerdict=MATCH endTime=Thu Mar 18 08:04:46 2021 ESADLPVerdict=NOT_EVALUATED
dvc=10.10.193.13 ESAAttachmentDetails={'test.txt': {'AMP': {'Verdict': 'FILE UNKNOWN',
'fileHash': '7f843d263304fb0516d6210e9de4fa7f01f2f623074aab6e3ee7051f7b785cfa'},
'BodyScanner':
{'fsize': 10059}}} ESAFriendlyFrom=test@esa.com ESAGMVerdict=NEGATIVE startTime=Thu Mar 18
08:04:29 2021
deviceInboundInterface=Incomingmail deviceDirection=0 ESAMailFlowPolicy=ACCEPT
suser=test@esa.com
cs1Label=MailPolicy cs1=DEFAULT ESAMFVerdict=NOT_EVALUATED act=QUARANTINED
ESAFinalActionDetails=To POLICY
cs4Label=ExternalMsgID cs4='<20210318070601.40490.18684@mail1.example.com>' ESAMsgSize=11873
ESAOFVerdict=POSITIVE
duser=9076@testing.com ESAHeloIP=10.11.1.2 cfp1Label=SBRSScore cfp1=None ESASDRDomainAge=27
years 2 months 15 days
cs3Label=SDRThreatCategory cs3=N/A cs6Label=SDRRepScore cs6=Weak ESASPFVerdict={'mailfrom':
{'result': 'None',
'sender': 'test@esa.com'}, 'helo': {'result': 'None', 'sender': 'postmaster'}, 'pra':
{'result': 'None', 'sender':
'test@esa.com'}} sourceHostName=unknown ESASenderGroup=UNKNOWNLIST sourceAddress=10.11.1.2
msg='Testing'
```

Log Field	CEF Field Name	CEF Field Value
<b>Prefix Fields</b>		

Log Field	CEF Field Name	CEF Field Value
	CEF format version	Example: 0
	Appliance vendor	Example: Cisco
	Appliance product	Example: C100V Email Security Virtual Appliance
	Appliance version	Example: 13.0.0-234
	Event Class ID	Example: ESA_CONSOLIDATED_LOG_EVENT
	Event Name	Example: Consolidated Log Event
	Severity	Example: 5
<b>GUI Fields</b>		
Serial Number	deviceExternalId	Example: 42156AC79142E979C5CD-02DE66639E9C
ICID Timestamp	startTime	Example: Mon Jul 29 11:22:22 2019
ICID	ESAICID	Example: 199
Listener Name	deviceInboundInterface(for incoming mails) deviceOutboundInterface(for outgoing mails)	Example: Inbound Example: Outbound
Sender IP	sourceAddress	Example: 10.10.2.75
Sender Domain	sourceHostName	Example: demo.cisco.com
Mail Direction	deviceDirection	Example: 0 0 -> incoming 1 -> outgoing
Mail Language	cs5	Example: cs5Label=ESAMsgLanguage cs5=English
SBRSScore	cfp1	Example: cfp1Label=SBRSScore, cfp1=1.1
Data IP	dvc	Example: 10.10.2.75
Mail Sender Geo Location	cs2	Example: cs2Label=GeoLocation cs2=India

Log Field	CEF Field Name	CEF Field Value
Message Too Big from Sender	ESAMsgTooBigFromSender	Example: true Possible Values: true/false
Rate Limited IP	ESARateLimitedIP	Example: 10.10.2.75
Mail Policy Name	cs1	Example: cs1Label=MailPolicy cs1=default
Mail Flow Policy Name	ESAMailFlowPolicy	Example: ACCEPT
Sender Group Name	ESASenderGroup	Example: UNKNOWNLIST
DHA IP	ESADHASource	Example: 10.10.2.75
Recipients	duser	Example: demo@test.com
Remote IP/Helo Domain IP	ESAHeloIP	Example: 10.10.2.75
Remote Host/ Helo Domain	ESAHeloDomain	Example: test.com
TLS Outgoing Connection Status	ESATLSOutConnStatus	Example: Success Possible Values: Success/Failure
TLS Outgoing Protocol	ESATLSOutProtocol	Example: TLSv1.2
TLS Outgoing Cipher	ESATLSOutCipher	Example: ECDHE-RSA-AES128-GCM-SHA256
TLS Incoming Connection Status	ESATLSInConnStatus	Example: Success Possible Values: Success/Failure
TLS Incoming Protocol	ESATLSInProtocol	Example: TLSv1.2
TLS Incoming Cipher	ESATLSInCipher	Example: ECDHE-RSA-AES128-GCM-SHA256
DMARC Verdict	ESADMARCVerdict	Example: Success Possible Values: PermFailure/TempFailure/ Reject/Success

Log Field	CEF Field Name	CEF Field Value
DKIM Verdict	ESADKIMVerdict	Example: Pass Possible Values: Pass/Neutral/TempError/ PermError/HardFail/None
SPF Verdict	ESASPFVerdict	Example: ESASPFVerdict={'mailfrom': {'sender': 'test@cisco.com', 'result': 'SoftFail'}, 'helo': {'sender': 'postmaster', 'result': 'None'}} Possible Values: Pass/Neutral/SoftFail/Fail/ TempError/PermError
Friendly From	ESAFriendlyFrom	Example: demo@test.com
Mail From	suser	Example: demo@test.com
Reply-To	ESAREplyTo	Example: demo@test.com
Subject	msg	Example: This is a sample subject
MID	ESAMID	Example: 101
Message ID	cs4	Example: cs1Label=ExternalMsgID cs1=20190729112221.42958.40626 @vm21esa0075.cs21
Message Size	ESAMsgSize	Example: ESAMsgSize=32199
SDR Reputation Score	cs6	Example: cs6Label= SDRRepScore cs6=Tainted
SDR Consolidated Domain Age	ESASDRDomainAge	Example: 1 year 21 days
SDR Consolidated Threat Category	cs3	Example: cs3Label= SDRThreatCategory cs3=mal
Message Filters Verdict	Message Filters Verdict	Example: MATCH Possible Values: NOT EVALUATED/MATCH/NO MATCH

Log Field	CEF Field Name	CEF Field Value
AS Verdict	ESAASVerdict	Example: POSITIVE Possible Values: Not EVALUATED/NEGATIVE/SUSPECT/ BULK_MAIL/SOCIAL_MAIL/MARKE TING_MAIL/POSITIVE
AV Verdict	ESAAVVerdict	Example: POSITIVE Possible Values: NOT EVALUATED/NEGATIVE/REPAIRED /ENCRYPTED/UNSCANNABLE/POSI TIVE
AMP Verdict	ESAAMPVerdict	Example: UNKNOWN Possible Values: NOT EVALUATED/CLEAN/FA_PENDING/ UNKNOWN/SKIPPED/ UNSCANNABLE /LOW_RISK/MALICIOUS
Graymail Verdict	ESAGMVerdict	Example: POSITIVE Possible Values: NOT EVALUATED/POSITIVE/NEGATIVE
Content Filters Verdict	ESACFVerdict	Example: MATCH Possible Values: NOT EVALUATED/MATCH/NO MATCH
Outbreak Filters Verdict	ESAOFVerdict	Example: NEGATIVE Possible Values: NOT EVALUATED/POSITIVE/NEGATIVE

Log Field	CEF Field Name	CEF Field Value
DLP Verdict	ESADLPVerdict	Example: VIOLATION Possible Values: NOT EVALUATED/NO TRIGGER/VIOLATION/NO VIOLATION
URL Details	ESAURLDetails	Example: {url1:{expanded_url:<>, category:<>, wbrs_score:<>, in_attachment:<>, Attachment_with_url:<>},url2:{...}} <b>Note</b> A URL is truncated if it contains more than 255 characters
File Details	ESAAttachmentDetails	Example: {name1:{source: {<>hash:<>, verdicts:<>}}} <b>Note</b> A filename is truncated if it contains more than 255 characters.
Mailbox Auto-Remediation Details	ESAMARAction	Example: {action:<>;succesful_rcpts=<>;failed _recipients=<>;filename=<>}
DCID	ESADCID	Example: 199
DCID Timestamp	EndTime	Example: Mon Jul 29 09:55:07 2019
DANE Status	ESADaneStatus	Example: success Possible Values: success/failure
DANE Host	ESADaneHost	Example: testdomain.com

Log Field	CEF Field Name	CEF Field Value
Message Final Action	act	Example: act=DELIVERED Possible Values: DROPPED/BOUNCED/DELIVERED - if the message is not quarantined. QUARANTINED - if the message is quarantined. DQ - if the message is sent to Delayed Quarantine. This is an exception and not a quarantine type.
Message Final Action Details	ESAFinalActionDetails	Example: act=DROPPED ESAFinalActionDetails= By AMP act=QUARANTINED ESAFinalActionDetails=To SPAM



**Note** If there is no value for a selected log field (for example, 'DKIMVerdict' because DKIM is not enabled on your email gateway), the log field is not included in the log message.

## Using CSN Logs

The CSN logs contain details about the CSN data uploads. The CSN data ( email gateway and feature usage details can be seen at the trace level.

### Examples of CSN Data Log Entries:

- In this example, the log shows that the email gateway was not able to send the CSN data to Cisco because the email gateway smart license was not registered with Cisco Smart Software Manager (CSSM).

```
Tue Apr 7 12:52:47 2020 Warning: Device is not
registered with CSSM. Skipping upload of CSN data
```

**Solution:** Make sure that you register your email gateway smart license with Cisco Smart Software Manager (CSSM).

- In this example, the log shows that the email gateway was not able to send the CSN data to Cisco because of a Cisco Security Services Exchange (SSE) connectivity error.

```
Thu Apr 9 13:32:46 2020 Warning: The appliance
failed to upload CSN data. reason for failure:
SSE error: HTTP Error 503: Service Unavailable
```

**Solution:** Make sure that you disable CSN and enable it again on your email gateway.

## Using Advanced Phishing Protection Logs

The Advanced Phishing Protection logs contain information related to Cisco Advanced Phishing Protection Cloud Service. Most information is at the Info or Critical level.

### Examples of Advanced Phishing Protection Data Log Entries:

- In this example, the log shows that the email gateway was not able to forward the message headers to Cisco Advanced Phishing Protection Cloud Service because the service expired.

```
Wed May 6 18:21:40 2020 Info: eaas : You cannot
forward the MID [877] Message Headers to Cisco Advanced
Phishing Protection Cloud Service as the service has
expired
```

- In this example, the log shows that the Cisco Advanced Phishing Protection Cloud Service has expired and is disabled in your email gateway.

```
Wed May 6 18:21:40 2020 Info: eaas : Cisco
Advanced Phishing Protection Cloud Service has expired
and is disabled. Contact your Cisco Account manager to
renew the service and then enable it.
```

**Solution:** Contact your Cisco Account manager to renew the service and then enable it.

- In this example, the log shows that the Cisco Advanced Phishing Protection Cloud Service will expire on a particular date.

```
Fri May 8 04:50:26 2020 Info: eaas : Cisco
Advanced Phishing Protection Cloud Service expires on
2020-05-10 07:00:00. You need to contact your Cisco Account
manager to renew the service.
```

**Solution:** Contact your Cisco Account manager to renew the service.

## Using Audit Logs

The Audit logs record AAA (Authentication, Authorization, and Accounting) events. Most information is at the debug or trace level.

### Example of Audit Log Entries:

- In this example, the log shows when a user (for example, admin):

- Logged in to the web interface of the email gateway.
- Logged out of the web interface of the email gateway.

```
Tue Aug 25 12:33:17 2020 Info: Appliance: mail1.example.com,
Interaction Mode: GUI, User: admin, Source IP: 192.168.1.1, Destination IP: 192.168.2.2,

Event: Successful login
Tue Aug 25 12:33:17 2020 Info: Appliance: mail1.example.com,
Interaction Mode: GUI, User: admin, Source IP: 192.168.1.1, Event: Session established
successfully
Tue Aug 25 12:33:58 2020 Info: Appliance: mail1.example.com,
Interaction Mode: GUI, User: admin, Source IP: 192.168.1.1, Event: User logged out
Tue Aug 25 12:33:58 2020 Info: Appliance: mail1.example.com,
Interaction Mode: GUI, User: admin, Source IP: 192.168.1.1, Event: Session terminated
```

- In this example, the log shows that a user (for example, admin) entered the `logconfig` CLI command.



```
Thu Oct 8 13:33:38 2020 Info: Appliance: mail1.example.com, Interaction Mode: CLI,
User: admin,
Source IP: 192.168.1.1, Event: User input was 'logconfig'
Thu Oct 8 13:33:46 2020 Info: Appliance: mail1.example.com, Interaction Mode: CLI,
User: admin,
Source IP: 192.168.1.1, Event: User input was 'Enter'
```

- In this example, the log shows that a user (for example, admin) viewed the GUI pages on the legacy web interface of the email gateway.

```
Thu Oct 8 13:35:07 2020 Info: Appliance: mail1.example.com, Interaction Mode: GUI,
User: admin,
Source IP: 192.168.1.1, Location: /network/dns, Event: User visited the web page.
Thu Oct 8 13:35:13 2020 Info: Appliance: mail1.example.com, Interaction Mode: GUI,
User: admin,
Source IP: 192.168.1.1, Location: /system_administration/sslconfig, Event: User visited
the web page.
Thu Oct 8 13:35:24 2020 Info: Appliance: mail1.example.com, Interaction Mode: GUI,
User: admin,
Source IP: 192.168.1.1, Location: /monitor/mail_reports/threatfeeds_report, Event: User
visited the web page.
```

- In this example, the log shows that a new user (for example, admin) is added to the email gateway using the web interface, but the changes are not committed.

```
Thu Oct 8 13:36:30 2020 Info: Appliance: mail1.example.com, Interaction Mode: GUI,
User: admin,
Source IP: 192.168.1.1, Location: /system_administration/access/users, Event: Added
user "admin" and changes
will reflect after commit.
Thu Oct 8 13:37:22 2020 Info: Appliance: mail1.example.com, Interaction Mode: GUI,
User: admin,
Source IP: 192.168.1.1, Location: /system_administration/access/users, Event: Deleted
user "admin" and changes
will reflect after commit.
```

- In this example, the log shows that a user (for example, admin) discarded all the changes that were not committed on the web interface of the email gateway.

```
Thu Oct 8 13:39:44 2020 Info: Appliance: mail1.example.com, Interaction Mode: GUI,
User: admin,
Source IP: 192.168.1.1, Location: /commit, Event: User discarded all uncommitted changes.
```

- In this example, the log shows that a user (for example, admin) discarded all the changes that were not committed through the CLI.

```
Thu Oct 8 13:41:38 2020 Info: Appliance: mail1.example.com, Interaction Mode: CLI,
User: admin,
Source IP: 192.168.1.1, Event: User discarded all uncommitted changes.
```

- In this example, the log shows that a user (for example, admin) made configuration changes to the Web UI session timeout.



---

**Note** You can view more details of the configuration changes made in your email gateway by viewing the Configuration History Logs or by enabling the debug mode for the audit logs.

---

```
Thu Oct 8 13:45:46 2020 Info: Appliance: mail1.example.com, User: admin,
Event: The following configuration changes were committed with comment - 'N/A'
Thu Oct 8 13:45:46 2020 Info: * [standalone] Number of seconds before the Web UI session
times out.
```

- In this example, the log shows that the AsyncOS APIs could not fetch the log subscriptions because the authentication failed.

```
Thu Oct 8 13:52:28 2020 Debug: 08/Oct/2020 13:52:28 +0000 Error - Code: 401,
Details: Unauthorized (No permission -- see authorization schemes)
Thu Oct 8 13:52:28 2020 Info: Appliance: mail1.example.com, Interaction Mode: API,
User: admin, Role: Role Not Available, Source IP: 192.168.1.1, Destination IP:
192.168.2.2,
Location: GET /esa/api/v2.0/config/logs/subscriptions/ HTTP/1.0, Event: User is not
valid.
```

- In this example, the log shows that the AsyncOS APIs could fetch the log subscriptions because the authentication was successful.

```
Thu Oct 8 13:52:37 2020 Info: Appliance: mail1.example.com, Interaction Mode: API,
User: admin, Role: Administrator, Source IP: 192.168.1.1, Destination IP: 192.168.2.2,

Location: GET /esa/api/v2.0/config/logs/subscriptions/ HTTP/1.0, Event: API Access
Success.
```

- In this example, the log shows that:

- A new user (for example, admin) is added to the email gateway using the CLI, but the changes were not committed.
- The existing user account details are updated in the email gateway using the CLI, but the changes were not committed.

```
Thu Oct 8 13:42:48 2020 Info: Appliance: mail1.example.com, Interaction Mode: CLI,
User: admin, Source IP: 192.168.1.1, Event: Added user "hops" and changes will reflect
after commit
Thu Oct 8 13:43:26 2020 Info: Appliance: mail1.example.com, Interaction Mode: CLI,
User: admin,
Source IP: 192.168.1.1, Event: Updated user "hops" and changes will reflect after commit
```

- In this example, the log shows that a user (for example, admin) performed a message tracking search on the new web interface of the email gateway.

```
Mon Oct 12 04:04:47 2020 Info: Appliance: mail1.example.com, Interaction Mode: API,
User: admin,
Role: Administrator, Source IP: 192.168.1.1, Destination IP: 192.168.2.2,
Location: GET /esa/api/v2.0/message-tracking/messages?startDate=2020-10-12T00:00:00.000Z
&endDate=2020-10-12T04:13:00.000Z&ciscoHost=All_Hosts&searchOption=messages&offset=0&limit=100
HTTP/1.0,
Event: API Access Success.
```



---

**Note** The actions that you perform on the new web interface of the email gateway (for example, tracking, reporting, or quarantine search) are recorded as logs based on the corresponding APIs used for these actions.

---

## Using CSA Logs

The Cisco Secure Awareness cloud service information is posted to the Mail Logs. Most information is at the Info or Debug level.

### Examples of Cisco Secure Awareness Log Entries:

- In this example, the log shows that the download of the Repeat Clickers list from the Cisco Secure Awareness cloud service failed because of an invalid token.

```
Tue Oct 13 10:12:59 2020 Warning: CSA:
The download of the Repeat Clickers list from
the Cisco Security Awareness cloud service failed because
of an invalid token.
```

**Solution:** Make sure you obtain a valid authentication token from the Cisco Secure Awareness cloud service.

- In this example, the log shows that the download of the Repeat Clickers list from the Cisco Secure Awareness cloud service failed because of a connection error.

```
Wed Oct 14 10:59:36 2020 Warning: CSA:
The download of the Repeat Clickers list from
the Cisco Security Awareness cloud service failed because
of a connection error.
```

**Solution:** Verify the firewall configuration settings used to connect your email gateway to the Cisco Secure Awareness cloud service.

- In this example, the log shows that the download of the Repeat Clickers list from the Cisco Secure Awareness cloud service failed because of an internal server error.

```
Wed Oct 14 10:59:36 2020 Warning: CSA:
The download of the Repeat Clickers list from
the Cisco Security Awareness cloud service failed because
of an internal server error.
```

**Solution:** Contact Cisco Support for technical assistance.

- In this example, the log shows that the download of the Repeat Clickers list from the Cisco Secure Awareness cloud service failed because the SSL certificate verification failed.

```
Wed Oct 14 11:02:46 2020 Warning: CSA:
The download of the Repeat Clickers list from
the Cisco Security Awareness cloud service failed because
the SSL certificate verification failed.
```

**Solution:** Add the required CA certificate of the proxy server in the custom certificate authority list of your email gateway.

- In this example, the log shows that the download of the Repeat Clickers list from the Cisco Secure Awareness cloud service failed because the proxy authentication failed.

```
Wed Oct 14 11:09:48 2020 Warning: CSA:
The download of the Repeat Clickers list from
the Cisco Security Awareness cloud service failed
because the proxy authentication failed.
```

**Solution:** Check whether the proxy server is configured with the correct authentication credentials in your email gateway.

- In this example, the log shows that a request to the Cisco Secure Awareness cloud service failed because the Report API was not enabled on the Cisco Secure Awareness cloud service.

```
Mon Aug 17 15:35:42 2020 Warning: CSA:
The download of the Repeat Clickers list failed.
A request to the CSA cloud service failed because
the Report API was not enabled on the CSA cloud service
```

**Solution:** Check the Enable Report API check box in Environment > Settings > Report API tab of the Cisco Secure Awareness cloud service.

- In this example, the log shows that the Cisco Secure Awareness feature expires on a particular date.

```
2020-10-15 08:00:11,968 INFO csa The Cisco Security
Awareness feature expires on 2029-12-28T23:59:59Z. You need to
contact your Cisco Account Manager to renew the license.
```

**Solution:** Contact your Cisco Account Manager to renew the license.

- In this example, the log shows that the Cisco Secure Awareness feature license has expired, and the feature is disabled on your email gateway.

```
2020-10-27 13:33:21,714 CRITICAL csa The Cisco Security
Awareness feature license has expired, and the feature is
disabled on your email gateway. Contact your Cisco Account Manager
to renew the license.
```

**Solution:** Contact your Cisco Account Manager to renew the license.

- In this example, the log shows that the downloaded Repeat Clickers list is empty.

```
Tue Oct 13 10:10:18 2020 Info: CSA: The downloaded
Repeat Clickers list is empty.
```

**Solution:** Create simulated phishing messages in the Cisco Secure Awareness cloud service and send them to the recipients in your organization.

- In this example, the log shows that the download of the Repeat Clickers list from the Cisco Secure Awareness cloud service failed because you have reached the maximum number of download attempts.

```
Fri Oct 16 05:22:08 2020 Warning: CSA: The download
of the Repeat Clickers list from the Cisco Security Awareness
cloud service failed because you have reached the maximum
number of attempts.
```

**Solution:** Contact Cisco Support to increase the number of attempts to download the Repeat Clickers list from the Cisco Secure Awareness cloud service.

## Log Subscriptions

- [Configuring Log Subscriptions, on page 1212](#)
- [Creating a Log Subscription in the GUI, on page 1214](#)
- [Configuring Global Settings for Logging, on page 1215](#)
- [Rolling Over Log Subscriptions, on page 1217](#)
- [Configuring Host Keys, on page 1221](#)

## Configuring Log Subscriptions

Use the Log Subscriptions page on the System Administration menu (or the `logconfig` command in the CLI) to configure a log subscription. Log subscriptions create log files that store information about AsyncOS

activity, including errors. A log subscription is either retrieved or delivered (pushed) to another computer. Generally, log subscriptions have the following attributes:

**Table 150: Log File Attributes**

Attribute	Description
Log type	Defines the type of information recorded and the format of the logs subscriptions. See <i>Table: Log Types</i> for more information.
Log Name	Nickname for the log subscription to be used for your future reference.
Log Fields	Select the required log fields to include in the consolidated event log line for a given message.  <b>Note</b> The Serial Number and MID log fields are selected by default, and you cannot deselect these fields.  <b>Note</b> This field is only applicable when you are configuring a log subscription with the log type as Consolidated Event Logs.
File Name	Used for the physical name of the file when written to disk. If multiple email gateways are being used, the log filename should be unique to identify the system that generated the log file.
Rollover by File Size	The maximum size the file can reach before rolling over.
Rollover by Time	Sets the time interval for file rollovers.
Rate Limit	Sets the maximum number of logged events in the log file, within the specified time range (in seconds).  The default time range value is 10 seconds.
Log level	Sets the level of detail for each log subscription.
Retrieval method	Defines how the log subscription will be obtained from the email gateway.

## Log Levels

Log levels determine the amount of information delivered in a log. Logs can have one of five levels of detail. A more detailed setting creates larger log files and puts more drain on system performance. More detailed settings include all the messages contained in less detailed settings, plus additional messages. As the level of detail increases, system performance decreases.



**Note** Log levels may be selected for all mail log types.

Table 151: Log Levels

Log Level	Description
Critical	The least detailed setting. Only errors are logged. Using this setting will not allow you to monitor performance and other important activities; however, the log files will not reach their maximum size as quickly. This log level is equivalent to the syslog level “Alert.”
Warning	All errors and warnings created by the system. Using this setting will not allow you to monitor performance and other important activities. This log level is equivalent to the syslog level “Warning.”
Information	The information setting captures the second-by-second operations of the system. For example, connections opened or delivery attempts. The Information level is the recommended setting for logs. This log level is equivalent to the syslog level “Info.”
Debug	Use the Debug log level when you are trying to discover the cause of an error. Use this setting temporarily, and then return to the default level. This log level is equivalent to the syslog level “Debug.”
Trace	The Trace log level is recommended only for developers. Using this level causes a serious degradation of system performance and is not recommended. This log level is equivalent to the syslog level “Debug.”

## Creating a Log Subscription in the GUI

### Procedure

- 
- Step 1** Choose **System Administration > Log Subscriptions**.
  - Step 2** Click **Add Log Subscription**.
  - Step 3** Select a log type and enter the log name (for the log directory) as well as the name for the log file itself.
  - Step 4** [Only for Consolidated Event Logs] Select the required log fields to include in the log line for a given message.
  - Step 5** Specify the maximum file size before AsyncOS rolls over the log file as well as a time interval between rollovers. See [Rolling Over Log Subscriptions, on page 1217](#) for more information on rolling over log files.
  - Step 6** Select the log level. The available options are Critical, Warning, Information, Debug, or Trace.
  - Step 7** Configure the log retrieval method.
  - Step 8** Submit and commit your changes.
- 

## Editing Log Subscriptions

### Procedure

- 
- Step 1** Choose **System Administration > Log Subscriptions**.

- Step 2** Click the name of the log in the Log Settings column.
  - Step 3** Make changes to the log subscription.
  - Step 4** Submit and commit your changes.
- 

## Configuring Global Settings for Logging

The system periodically records system measurements within the Text Mail Logs and the Status Logs. Use the **Edit Settings** button in the Global Settings section of the **System Administration > Log Subscriptions** page (or the `logconfig -> setup` command in the CLI) to configure:

- System metrics frequency. This is the amount of time, in seconds, that the system waits between recording measurements.
- Whether to record the Message-ID headers.
- Whether to record the remote response status code.
- Whether to record the subject header of the original message.
- A list of headers that should be logged for each message.

All logs optionally include the following three pieces of data:

### 1. Message-ID

When this option is configured, every message will have its Message ID header logged, if it is available. Note that this Message-ID may have come from the received message or may have been generated by AsyncOS itself. For example:

```
Tue Apr 6 14:38:34 2004 Info: MID 1 Message-ID Message-ID-Content
```

### 2. Remote Response

When this option is configured, every message will have its remote response status code logged, if it is available. For example:

```
Tue Apr 6 14:38:34 2004 Info: MID 1 RID [0] Response 'queued as 9C8B425DA7'
```

The remote response string is the human-readable text received after the response to the DATA command during the delivery SMTP conversation. In this example, the remote response after the connection host issued the data command is “queued as 9C8B425DA7.”

```
[...]
```

```
250 ok hostname
```

```
250 Ok: queued as 9C8B425DA7
```

Whitespace, punctuation, (and in the case of the 250 response, the OK characters) are stripped from the beginning of the string. Only whitespace is stripped from the end of the string. For example, email gateways, by default, respond to the DATA command with this string: 250 Ok: Message MID accepted. So, the string “Message MID accepted” would be logged if the remote host were another email gateway.

### 3. Original Subject Header

When this option is enabled, the original subject header of each message is included in the log.

```
Tue May 31 09:20:27 2005 Info: Start MID 2 ICID 2
Tue May 31 09:20:27 2005 Info: MID 2 ICID 2 From: <mary@example.com>
Tue May 31 09:20:27 2005 Info: MID 2 ICID 2 RID 0 To: <joe@example.com>
Tue May 31 09:20:27 2005 Info: MID 2 Message-ID '<44e4n$2@example.com>'
Tue May 31 09:20:27 2005 Info: MID 2 Subject 'Monthly Reports Due'
```

## Logging Message Headers

In some cases, it is necessary to record the presence and contents of a message's headers as they pass through the system. You specify the headers to record in the Log Subscriptions Global Settings page (or via the `logconfig -> logheaders` subcommand in the CLI). The email gateway records the specified message headers in the Text Mail Logs, the Delivery Logs, and the Bounce Logs. If the header is present, the system records the name of the header and the value. If a header is not present, nothing is recorded in the logs.



**Note** The system evaluates all headers that are present on a message, at any time during the processing of the message for recording, regardless of the headers specified for logging.

The RFC for the SMTP protocol is located at <http://www.faqs.org/rfcs/rfc2821.html> and defines user-defined headers.

If you have configured headers to log via the `logheaders` command, the header information appears after the delivery information:

**Table 152: Log Headers**

Header name	Name of the header
Value	Contents of the logged header

For example, specifying “date, x-subject” as headers to be logged will cause the following line to appear in the mail log:

```
Tue May 31 10:14:12 2005 Info: Message done DCID 0 MID 3 to RID [0]
[('date', 'Tue, 31 May 2005 10:13:18 -0700'), ('x-subject', 'Logging this header')]
```

## Configuring Global Settings for Logging Using the GUI

### Procedure

- Step 1** Choose **System Administration > Log Subscriptions**.
- Step 2** Scroll down to the **Global Settings** section.
- Step 3** Click **Edit Settings**.



- Step 4** Specify information including the system measurement frequency, whether to include Message-ID headers in mail logs, whether to include the remote response, and whether to include the original subject header of each message.
- Step 5** Enter any other headers you want to include in the logs.
- Step 6** Submit and commit your changes.
- 

## Rolling Over Log Subscriptions

To prevent log files on the email gateway from becoming too large, AsyncOS performs a “rollover” and archives a log file when it reaches a user-specified maximum file size or time interval and creates a new file for incoming log data. Based on the retrieval method defined for the log subscription, the older log file is stored on the email gateway for retrieval or delivered to an external computer. See [Log Retrieval Methods, on page 1153](#) for more information on how to retrieve log files from the email gateway.

When AsyncOS rolls over a log file, it performs the following actions:

- Renames the current log file with the timestamp of the rollover and a letter “s” extension signifying saved.
- Creates a new log file and designates the file as current with the “**current**” extension.
- Transfers the newly saved log file to a remote host (if using the push-based retrieval method).
- Transfers any previously unsuccessful log files from the same subscription (if using the push-based retrieval method).
- Deletes the oldest file in the log subscription if the total number of files to keep on hand has been exceeded (if using the poll-based retrieval method).

You define a log subscription’s rollover settings when creating or editing the subscription using the **System Administration > Log Subscriptions** page in the GUI or the logconfig command in the CLI. The two settings available for triggering a log file rollover are:

- A maximum file size.
- A time interval.

### Rollover By File Size

AsyncOS rolls over log files when they reach a maximum file size to prevent them from using too much disk space. When defining a maximum file size for rollovers, use the suffix m for megabytes and k for kilobytes. For example, enter 10m if you want AsyncOS to roll over the log file when it reaches 10 megabytes.

### Rollover By Time

If you want to schedule rollovers to occur on a regular basis, you can select one of the following time intervals:

- **None.** AsyncOS only performs a rollover when the log file reaches the maximum file size.
- **Custom Time Interval.** AsyncOS performs a rollover after a specified amount of time has passed since the previous rollover. To create a custom time interval for scheduled rollovers, enter the number of days, hours, and minutes between rollovers using d , h , and m as suffixes.
- **Daily Rollover.** AsyncOS performs a rollover every day at a specified time. If you choose a daily rollover, enter the time of day you want AsyncOS to perform the rollover using the 24-hour format (HH:MM).

Only the GUI offers the Daily Rollover option. If you want to configure a daily rollover using the `logconfig` command in the CLI, choose the Weekly Rollover option and use an asterisk (\*) to specify that AsyncOS should perform the rollover on every day of the week.

- **Weekly Rollover.** AsyncOS performs a rollover on one or more days of the week at a specified time. For example, you can set up AsyncOS to rollover the log file every Wednesday and Friday at midnight. To configure a weekly rollover, choose the days of the week to perform the rollover and the time of day in the 24-hour format (HH:MM).

If you are using the CLI, you can use a dash ( - ) to specify a range of days, an asterisk ( \* ) to specify every day of the week, or a comma ( , ) to separate multiple days and times.

The following table shows how to use the CLI to roll over the files for a log subscription on Wednesday and Friday at midnight ( 00:00 ).

**Table 153: Weekly Log Rollover Settings in the CLI**

Do you want to configure time-based log files rollover? [N]> y
Configure log rollover settings:
1. Custom time interval.
2. Weekly rollover.
[1]> 2
1. Monday
2. Tuesday
3. Wednesday
4. Thursday
5. Friday
6. Saturday
7. Sunday
Choose the day of week to roll over the log files. Separate multiple days with comma, or use "*" to specify every day of a week. Also you can use dash to specify a range like "1-5":
[ ]> 3, 5

Enter the time of day to rollover log files in 24-hour format (HH:MM). You can specify hour as "\*" to match every hour, the same for minutes. Separate multiple times of day with comma:

```
[ ]> 00:00
```

## Rolling Over Log Subscriptions on Demand

To roll over log subscriptions immediately using the GUI:

### Procedure

- 
- Step 1** On the System Administration > Log Subscriptions page, mark the checkbox to the right of the logs you wish to roll over.
  - Step 2** Optionally, you can select all logs for rollover by marking the All checkbox.
  - Step 3** Once one or more logs have been selected for rollover, the **Rollover Now** button is enabled. Click the **Rollover Now** button to roll over the selected logs.
- 

## Viewing Recent Log Entries in the GUI

### Before You Begin

You must have the HTTP or HTTPS service enabled on the Management interface in order to view logs via the GUI.

### Procedure

- 
- Step 1** Select **System Administration > Log Subscriptions**.
  - Step 2** Select the log subscription in the **Log Files** column of the table.
  - Step 3** Sign in.
  - Step 4** Select a log file to view it in your browser or to save it to disk.
- 

## Viewing Recent Log Entries in the CLI (tail Command)

AsyncOS supports a tail command, which shows the latest entries of configured logs on the email gateway. Issue the tail command and select the number of a currently configured log to view it. Use Ctrl-C to exit from the tail command.

## Example

In the following example, the tail command is used to view the system log. (This log tracks user comments from the commit command, among other things.) The tail command also accepts the name of a log to view as a parameter: tail mail\_logs .

```
mail3.example.com> tail
```

```
Currently configured logs:
```

1. "antispam" Type: "Anti-Spam Logs" Retrieval: Manual Download
2. "antivirus" Type: "Anti-Virus Logs" Retrieval: Manual Download
3. "asarchive" Type: "Anti-Spam Archive" Retrieval: Manual Download
4. "authentication" Type: "Authentication Logs" Retrieval: Manual Download
5. "avarchive" Type: "Anti-Virus Archive" Retrieval: Manual Download
6. "bounces" Type: "Bounce Logs" Retrieval: Manual Download
7. "cli\_logs" Type: "CLI Audit Logs" Retrieval: Manual Download
8. "encryption" Type: "Encryption Logs" Retrieval: Manual Download
9. "error\_logs" Type: "IronPort Text Mail Logs" Retrieval: Manual Download
10. "euq\_logs" Type: "IronPort Spam Quarantine Logs" Retrieval: Manual Download
11. "euqgui\_logs" Type: "IronPort Spam Quarantine GUI Logs" Retrieval: Manual Download
12. "ftpd\_logs" Type: "FTP Server Logs" Retrieval: Manual Download
13. "gui\_logs" Type: "HTTP Logs" Retrieval: Manual Download
14. "mail\_logs" Type: "IronPort Text Mail Logs" Retrieval: Manual Download
15. "reportd\_logs" Type: "Reporting Logs" Retrieval: Manual Download
16. "reportqueryd\_logs" Type: "Reporting Query Logs" Retrieval: Manual Download
17. "scanning" Type: "Scanning Logs" Retrieval: Manual Download
18. "slbld\_logs" Type: "Safe/Block Lists Logs" Retrieval: Manual Download
19. "sntpd\_logs" Type: "NTP logs" Retrieval: Manual Download
20. "status" Type: "Status Logs" Retrieval: Manual Download
21. "system\_logs" Type: "System Logs" Retrieval: Manual Download
22. "trackerd\_logs" Type: "Tracking Logs" Retrieval: Manual Download
23. "updater\_logs" Type: "Updater Logs" Retrieval: Manual Download

```
Enter the number of the log you wish to tail.
```

```
[ ]> 19
```

```
Press Ctrl-C to stop.
```

```

Mon Feb 21 12:25:10 2011 Info: PID 274: User system commit changes: Automated Update for
Quarantine Delivery Host

Mon Feb 21 23:18:10 2011 Info: PID 19626: User admin commit changes:

Mon Feb 21 23:18:10 2011 Info: PID 274: User system commit changes: Updated filter logs
config

Mon Feb 21 23:46:06 2011 Info: PID 25696: User admin commit changes: Receiving
suspended.

^Cmail3.example.com>

```

## Configuring Host Keys

Use the `logconfig -> hostkeyconfig` subcommand to manage host keys for use with SSH when pushing logs to other servers from the email gateway. SSH servers must have a pair of host keys, one private and one public. The private host key resides on the SSH server and cannot be read by remote machines. The public host key is distributed to any client machine that needs to interact with the SSH server.



**Note** To manage user keys, see [Managing Secure Shell \(SSH\) Keys, on page 997](#).

The `hostkeyconfig` subcommand performs the following functions:

**Table 154: Managing Host Keys - List of Subcommands**

Command	Description
New	Add a new key.
Edit	Modify an existing key.
Delete	Delete an existing key.
Scan	Automatically download a host key.
Print	Display a key.
Host	Display system host keys. This is the value to place in the remote system's 'known_hosts' file.
Fingerprint	Display system host key fingerprints.
User	Display the public key of the system account that pushes the logs to the remote machine. This is the same key that is displayed when setting up an SCP push subscription. This is the value to place in the remote system's 'authorized_keys' file.

In the following example, AsyncOS scans for host keys and add them for the host:

```

mail3.example.com> logconfig

Currently configured logs:

[ list of logs ]

```

Choose the operation you want to perform:

- NEW - Create a new log.
- EDIT - Modify a log subscription.
- DELETE - Remove a log subscription.
- SETUP - General settings.
- LOGHEADERS - Configure headers to log.
- HOSTKEYCONFIG - Configure SSH host keys.

[>] hostkeyconfig

Currently installed host keys:

1. mail3.example.com ssh-dss [ key displayed ]

Choose the operation you want to perform:

- NEW - Add a new key.
- EDIT - Modify a key.
- DELETE - Remove a key.
- SCAN - Automatically download a host key.
- PRINT - Display a key.
- HOST - Display system host keys.
- FINGERPRINT - Display system host key fingerprints.
- USER - Display system user keys.

[>] scan

Please enter the host or IP address to lookup.

[>] mail3.example.com

Choose the ssh protocol type:

1. SSH1:rsa
2. SSH2:rsa
3. SSH2:dsa
4. All

[4]>

SSH2:dsa

mail3.example.com ssh-dss

[ key displayed ]

SSH2:rsa

```
mail3.example.com ssh-rsa
[ key displayed ]
SSH1:rsa
mail3.example.com 1024 35
[ key displayed ]

Add the preceding host key(s) for mail3.example.com? [Y]>
Currently installed host keys:
1. mail3.example.com ssh-dss [ key displayed ]
2. mail3.example.com ssh-rsa [ key displayed ]
3. mail3.example.com 1024 35 [ key displayed ]

Choose the operation you want to perform:
- NEW - Add a new key.
- EDIT - Modify a key.
- DELETE - Remove a key.
- SCAN - Automatically download a host key.
- PRINT - Display a key.
- HOST - Display system host keys.
- FINGERPRINT - Display system host key fingerprints.
- USER - Display system user keys.

[ ]>

Currently configured logs:
[ list of configured logs ]

Choose the operation you want to perform:
- NEW - Create a new log.
- EDIT - Modify a log subscription.
- DELETE - Remove a log subscription.
- SETUP - General settings.
- LOGHEADERS - Configure headers to log.
- HOSTKEYCONFIG - Configure SSH host keys.

[ ]>
```







## CHAPTER 45

# Centralized Management Using Clusters

This chapter contains the following sections:

- [Overview of Centralized Management Using Clusters](#) , on page 1225
- [Cluster Requirements](#), on page 1226
- [Cluster Organization](#), on page 1226
- [Creating and Joining a Cluster](#), on page 1228
- [Managing Clusters](#), on page 1235
- [Administering a Cluster from the GUI](#), on page 1240
- [Cluster Communication](#), on page 1242
- [Loading a Configuration in Clustered Email Gateway](#), on page 1247
- [Best Practices and Frequently Asked Questions](#), on page 1248

## Overview of Centralized Management Using Clusters

The Cisco centralized management feature allows you to manage and configure multiple email gateways at the same time, reducing administration time and ensuring a consistent configuration across your network. You do not need to purchase additional hardware for managing multiple email gateways. The centralized management feature provides increased reliability, flexibility, and scalability within your network, allowing you to manage globally while complying with local policies.

A *cluster* is defined as a set of machines that share configuration information. Within the cluster, machines (email gateways) are divided into *groups* ; every cluster will contain at least one group. A given machine is a member of one and only one group. An administrator user can configure different elements of the system on a cluster-wide, group-wide, or per-machine basis, enabling the segmentation of email gateways based on network, geography, business unit, or other logical relationships.

Clusters are implemented as a *peer-to-peer* architecture; there is no primary/secondary relationship within a cluster. You may log into any machine to control and administer the cluster. (Some configuration commands, however, are limited. See [Restricted Commands](#), on page 1239.)

The user database is shared across all machines in the cluster. That is, there will be only one set of users and one administrator user (with the associated passphrases) for an entire cluster. All machines that join a cluster will share a single administrator passphrase which is referred to as the *admin passphrase* of the cluster.



---

**Note** Having more than 20 email gateways in a cluster can cause errors in cluster communication.

---

# Cluster Requirements

- Machines in a cluster must have resolvable hostnames in DNS. Alternatively, you can use IP addresses instead, but you may not mix the two.

See [DNS and Hostname Resolution, on page 1243](#). Cluster communication is normally initiated using the DNS hostnames of the machines.

- A cluster must consist entirely of machines running the same version of AsyncOS.

See [Upgrading Machines in a Cluster, on page 1237](#) for how to upgrade members of a cluster.

- Machines can either join the cluster via SSH (typically on port 22) *or* via the Cluster Communication Service (CCS).

See [Cluster Communication, on page 1242](#).

- Once machines have joined the cluster, they can communicate via SSH or via Cluster Communication Service. The port used is configurable. SSH is typically enabled on port 22, and by default CCS is on port 2222, but you can configure either of these services on a different port.

In addition to the normal firewall ports that must be opened for the email gateway, clustered machines communicating via CCS must be able to connect with each other via the CCS port. See [Cluster Communication, on page 1242](#).

- You must use the Command Line Interface (CLI) command `clusterconfig` to create, join, or configure clusters of machines.

Once you have created a cluster, you can manage non-cluster configuration settings from either the GUI or the CLI.

See [Creating and Joining a Cluster, on page 1228](#) and [Administering a Cluster from the GUI, on page 1240](#).

- If you have enabled two-factor authentication on your email gateway, you can join it to a cluster machine using pre-shared keys. Use the `clusterconfig > prepjoin` command in the CLI to configure this setting.

Or

Disable two-factor authentication on your email gateway, before you create or join a cluster. For more information, see [Disabling Two-Factor Authentication, on page 993](#).

# Cluster Organization

Within a cluster, configuration information is divided into 3 groupings or *levels*. The top level describes cluster settings; the middle level describes group settings; and the lowest level describes machine-specific settings.

Figure 79: Cluster Level Hierarchy

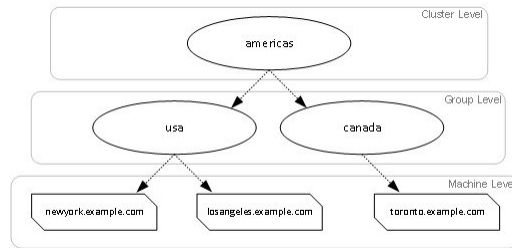

Within each level there will be one or more specific members for which settings may be configured; these are referred to as modes. A mode refers to a named member at a specified level. For example, the group “usa” represents one of two group modes in the diagram. While levels are a general term, modes are specific; modes are always referred to by name. The cluster depicted in the above figure has six modes.

Although settings are configured at a given level, they are always configured for a specific mode. It is not necessary to configure settings for all modes within a level. The cluster mode is a special case. Because there can only be one cluster, all settings configured for the cluster mode can be said to be configured at the cluster level.

You should normally configure most settings at the cluster level. However, settings that have been specifically configured at lower levels will override settings configured at higher levels. Thus, you can override cluster-mode settings with group-mode or machine-mode settings.

For example, you might start by configuring the Good Neighbor Table in cluster mode; all machines in the cluster would use that configuration. Then, you might also configure this table in machine mode for machine newyork . In this case, all other machines in the cluster will still use the good neighbor table defined at the cluster level, but the machine newyork will override the cluster settings with its individual machine mode settings.

The ability to override cluster settings for specific groups or machines gives you a lot of flexibility. However, if you find yourself configuring many settings individually in machine mode, you will lose much of the ease of administration that clusters were intended to provide.

## Initial Configuration Settings

For most features, when you begin to configure settings for a new mode, those settings will initially be empty by default. There is a distinction between empty settings and having no settings in a mode. As an example, consider a very simple cluster composed of one group and one machine. Imagine that you have an LDAP query configured at the cluster level. There are no settings configured at the group or machine levels:

Cluster	(ldap queries: a, b, c)
Group	
Machine	

Now, imagine that you create new LDAP query settings for the group. The result will be something like this:

Cluster	(ldap queries: a, b, c)
Group	(ldap queries: None)
Machine	

The group-level settings now override the cluster-level setting; however, the new group settings are initially empty. The group mode does not actually have any LDAP queries of its own configured. Note that a machine within this group will inherit this “empty” set of LDAP queries from the group.

Next, you can add an LDAP query to the group, for example:

Cluster	(ldap queries: a, b, c)
Group	(ldap queries: d)
Machine	

Now the cluster level has one set of queries configured while the group has another set of queries. The machine will inherit its queries from the group.

## Creating and Joining a Cluster

You cannot create or join a cluster from the Graphical User Interface (GUI). You must use the Command Line Interface (CLI) to create, join, or configure clusters of machines. Once you have created a cluster, you can change configuration settings from either the GUI or the CLI.



**Caution** If you have enabled two-factor authentication on your email gateway, you can join it to a cluster machine using pre-shared keys. Use the `clusterconfig > prepjoin` command in the CLI to configure this setting.

Or

Disable two-factor authentication on your email gateway, before you create or join a cluster. For more information, see [Disabling Two-Factor Authentication, on page 993](#).

## The clusterconfig Command

A machine can create or join a cluster only via the `clusterconfig` command.

- When a new cluster is *created*, all of that cluster’s initial settings will be inherited from the machine that creates the cluster. If a machine was previously configured in “standalone” mode, its standalone settings are used when creating the cluster.
- When a machine *joins* a cluster, all of that machine’s clusterable settings will be inherited from the cluster level. In other words, everything except certain machine-specific settings (IP addresses, etc) will be lost and will be replaced with the settings from the cluster and/or the group selected for that machine to join. If a machine was previously configured in “standalone” mode, its standalone settings are used when creating the cluster, and no settings at the machine level are maintained.

If the current machine is not already part of a cluster, issuing the `clusterconfig` command presents the option to join an existing cluster or create a new one.

At this point you can add machines to the new cluster. Those machines can communicate via SSH or CCS.

```
newyork.example.com> clusterconfig
```

```
Do you want to join or create a cluster?
```

```
1. No, configure as standalone.
2. Create a new cluster.
3. Join an existing cluster over SSH.
4. Join an existing cluster over CCS.

[1]> 2

Enter the name of the new cluster.

[ ]> americas

New cluster committed: Wed Jun 22 10:02:04 2005 PDT

Creating a cluster takes effect immediately, there is no need to commit.

Cluster americas

Choose the operation you want to perform:

- ADDGROUP - Add a cluster group.
- SETGROUP - Set the group that machines are a member of.
- RENAMEGROUP - Rename a cluster group.
- DELETEGROUP - Remove a cluster group.
- REMOVEMACHINE - Remove a machine from the cluster.
- SETNAME - Set the cluster name.
- LIST - List the machines in the cluster.
- LISTDETAIL - List the machines in the cluster with detail.
- DISCONNECT - Temporarily detach machines from the cluster.
- RECONNECT - Restore connections with machines that were previously detached.
- PREPJOIN - Prepare the addition of a new machine over CCS.

[ ]>
```

## Joining an Existing Cluster

From the host you want to add to the cluster, issue the `clusterconfig` command to join the existing cluster. You can choose to join the cluster over SSH or over CCS (cluster communication service).

In order to join a host to an existing cluster, you must:

- be able to validate the SSH host key of a machine in the cluster
- know the IP address of a machine in the cluster and be able to connect to this machine in the cluster (for example, via SSH or CCS)
- know the administrator passphrase for the admin user on a machine belonging to the cluster

## Joining an Existing Cluster over SSH

The following table demonstrates adding the machine losangeles.example.com to the cluster using the SSH option.

```
losangeles.example.com> clusterconfig
```

```
Do you want to join or create a cluster?
```

1. No, configure as standalone.
2. Create a new cluster.
3. Join an existing cluster over SSH.
4. Join an existing cluster over CCS.

```
[1]> 3
```

While joining a cluster, you will need to validate the SSH host key of the remote machine to which you are joining. To get the public host key

```
fingerprint of the remote host, connect to the cluster and run: logconfig ->
hostkeyconfig -> fingerprint.
```

WARNING: All non-network settings will be lost. System will inherit the values set at the group or cluster mode for the non-network settings. Ensure that the cluster settings are compatible with your network settings (e.g. dnsconfig settings)

```
Do you want to enable the Cluster Communication Service on
losangeles.example.com? [N]> n
```

```
Enter the IP address of a machine in the cluster.
```

```
[ ]> IP address is entered
```

```
Enter the remote port to connect to. The must be the normal admin ssh
port, not the CCS port.
```

```
[22]> 22
```

```
Enter the admin passphrase for the cluster.
```

```
The administrator passphrase for the clustered machine is entered
```

```
Please verify the SSH host key for IP address:
```

```
Public host key fingerprint: xx:xx:xx:xx:xx:xx:xx:xx:xx:xx:xx:xx:xx:xx:xx
```

```
Is this a valid key for this host? [Y]> y
```

```
Joining cluster group Main_Group.
```

```
Joining a cluster takes effect immediately, there is no need to commit.
```

```
Cluster americas
```

```
Choose the operation you want to perform:
```

- ADDGROUP - Add a cluster group.
- SETGROUP - Set the group that machines are a member of.

```
- RENAMEGROUP - Rename a cluster group.
- DELETEGROUP - Remove a cluster group.
- REMOVEMACHINE - Remove a machine from the cluster.
- SETNAME - Set the cluster name.
- LIST - List the machines in the cluster.
- LISTDETAIL - List the machines in the cluster with detail.
- DISCONNECT - Temporarily detach machines from the cluster.
- RECONNECT - Restore connections with machines that were previously detached.
- PREPJOIN - Prepare the addition of a new machine over CCS.

[]>

(Cluster americas)>
```

## Joining an Existing Cluster over CCS

Use CCS instead of SSH if you cannot use SSH. The only advantage of CCS is that only cluster communication happens over that port (no user logins, SCP, etc). To add another machine to an existing cluster via CCS, use the `prepjoin` subcommand of `clusterconfig` to prepare the machine to be added to the cluster. In this example, the `prepjoin` command is issued on the machine `newyork` to prepare the machine `losangeles` to be added to the cluster.

The `prepjoin` command involves obtaining the user key of the host you want to add to the cluster by typing `clusterconfig prepjoin print` in the CLI of that host, and then copying the key into the command line of the host that is currently in the cluster.

Once a machine is already part of a cluster, the `clusterconfig` command allows you to configure various settings for the cluster.

Choose the operation you want to perform:

```
- ADDGROUP - Add a cluster group.
- SETGROUP - Set the group that machines are a member of.
- RENAMEGROUP - Rename a cluster group.
- DELETEGROUP - Remove a cluster group.
- REMOVEMACHINE - Remove a machine from the cluster.
- SETNAME - Set the cluster name.
- LIST - List the machines in the cluster.
- LISTDETAIL - List the machines in the cluster with detail.
- DISCONNECT - Temporarily detach machines from the cluster.
- RECONNECT - Restore connections with machines that were previously detached.
```

- PREPJOIN - Prepare the addition of a new machine over CCS.

```
[ ]> prepjoin
```

Prepare Cluster Join Over CCS

No host entries waiting to be added to the cluster.

Choose the operation you want to perform:

- NEW - Add a new host that will join the cluster.

```
[ ]> new
```

Enter the hostname of the system you want to add.

```
[ ]> losangeles.example.com
```

Enter the serial number of the host mail3.example.com.

```
[ ]> unique serial number is added
```

Enter the user key of the host losangeles.example.com. This can be obtained by typing "clusterconfig prepjoin print" in the CLI on mail3.example.com. Press enter on a blank line to finish.

unique user key from output of prepjoin print is pasted

Host losangeles.example.com added.

Prepare Cluster Join Over CCS

1. losangeles.example.com (serial-number)

Choose the operation you want to perform:

- NEW - Add a new host that will join the cluster.

- DELETE - Remove a host from the pending join list.

```
[ ]>
```

```
(Cluster Americas)> clusterconfig
```

Cluster americas

Choose the operation you want to perform:

- ADDGROUP - Add a cluster group.

- SETGROUP - Set the group that machines are a member of.

- RENAMEGROUP - Rename a cluster group.

- DELETEDGROUP - Remove a cluster group.

- REMOVEMACHINE - Remove a machine from the cluster.

- SETNAME - Set the cluster name.

- LIST - List the machines in the cluster.

- LISTDETAIL - List the machines in the cluster with detail.



- DISCONNECT - Temporarily detach machines from the cluster.
  - RECONNECT - Restore connections with machines that were previously detached.
  - PREPJOIN - Prepare the addition of a new machine over CCS.
- [ ]>

## Joining an Existing Cluster over SSH with Pre-Shared Keys

The following table demonstrates how to join the machine (testmachine.example.com) to the cluster (test\_cluster) over SSH using pre-shared keys.

```
testmachine.example.com> clusterconfig
```

Do you want to join or create a cluster?

1. No, configure as standalone.
2. Create a new cluster.
3. Join an existing cluster over SSH.
4. Join an existing cluster over CCS.

[1]> 3

While joining a cluster, you will need to validate the SSH host key of the remote machine to which you are joining. To get the public host key

fingerprint of the remote host, connect to the cluster and run: logconfig -> hostkeyconfig -> fingerprint.

WARNING: All non-network settings will be lost. System will inherit the values set at the group or cluster mode for the non-network settings. Ensure that the cluster settings are compatible with your network settings (e.g. dnsconfig settings)

Do you want to enable the Cluster Communication Service on testmachine.example.com? [N]>

Enter the IP address of a machine in the cluster.

[ ]> **IP address entered**

Enter the remote port to connect to. The must be the normal admin ssh port, not the CCS port.

[22]>

Would you like to join this appliance to a cluster using pre-shared keys? Use this option if you have enabled two-factor authentication on the appliance.) [Y]> **yes**

To join this appliance to a cluster using pre-shared keys, log in to the cluster machine, run the clusterconfig > prepjoin > command, enter the following details, and commit your changes.

```
Host: pod1226-esa07.ibesa
Serial Number: 42291A18D741EDB4C601-BC14E5579F34
User Key:
```

```
ssh-dss
AAAAB3NzaC1kc3MAAACBAJ6Xm+ja4aa9n4D0cJs/gGwEDEUWgERYchhgWApKt6IW+s58I7knGM81rQgQbNdnCO58D
EqaVGmP0Vyb0Ttpgvh6f0mr80OuTgWh9bqg4uiOJvbKv1TvDt0o7//mTkml159zr2KT/qFH+9L5i+8iIMX62R5y+a
6E8JV0BrJCNAAAFAQCmK+Wou9HSribsC0f/5dVoAddxEwAAAIA5p7NR74rlSrs0JWWYItNatE1SamAN+gqCOdUWGPpHT
qdrtBilPQ9tfFoThZElqY4Tx81ku9laasoRLruQ2Z36R3bQGzIn4jzQqujvbxTvLK9eLoSr8yFbEE3ZvuUo0+vhDn
LIDX2N65AQSQsTaOrKX+yQZ8yAVt48CsctpsDrgAAAIAVROGlWoSl8g3FFm2eRTa+/oZ+cMjv+pSZiZoiUCoaIlouc
ulZDpN413Qbnf6p/3D8wVD8m5uo8O4N/HXasAMektZvGoP4Sf+shItPuISrv31rMTEYsD0sqVcMc7vIXUeD2jpk7MB
ooVktZB/rdTbNMfXrhDkNJ2IAPQqiUKVnw==
```

Before you proceed to the next step, make sure you add the 'Host', Serial Number' and 'User Key' details to the cluster machine.

Would you like to continue? [Y]> **yes**

Joining cluster group Main\_Group.

Joining a cluster takes effect immediately, there is no need to commit.

Cluster **test\_cluster**

Choose the operation you want to perform:

- ADDGROUP - Add a cluster group.
- SETGROUP - Set the group that machines are a member of.
- RENAMEGROUP - Rename a cluster group.
- DELETEDGROUP - Remove a cluster group.
- REMOVEMACHINE - Remove a machine from the cluster.
- SETNAME - Set the cluster name.
- LIST - List the machines in the cluster.
- LISTDETAIL - List the machines in the cluster with detail.
- DISCONNECT - Temporarily detach machines from the cluster.
- RECONNECT - Restore connections with machines that were previously detached.
- PREPJOIN - Prepare the addition of a new machine over CCS.

[ ]>

(Cluster test\_cluster)>

## Adding Groups

All clusters must contain at least one group. When you create a new cluster, a default group called **Main\_Group** is created automatically. However, you may decide to create additional groups within your cluster. This example shows how to create additional groups within an existing cluster and assign machines to the new group(s).

### Procedure

- 
- Step 1** Issue the `clusterconfig` command.
  - Step 2** Choose the `addgroup` subcommand and enter the name of the new group.
  - Step 3** Use the `setgroup` subcommand to choose machines for the new group.
- 

## Managing Clusters

### Administering a Cluster from the CLI

For machines that are part of a cluster, the CLI can be switched into different modes. Recall that a mode refers to a specific, named, member of a level.

The CLI mode determines precisely where a configuration setting will be modified. The default is “machine” mode for the machine the user logged into, the “login host.”

Use the `clustermode` command to switch between different modes.

**Table 155: Administering Clusters**

Command Example	Description
<code>clustermode</code>	Prompt to switch cluster mode
<code>clustermode group northamerica</code>	Switch to group mode for the group “northamerica”
<code>clustermode machine losangeles.example.com</code>	Switch to machine mode for the machine “losangeles”

The prompt in the CLI changes to indicate your current mode.

```
(Cluster Americas)>
```

or

```
(Machine losangeles.example.com)>
```

In machine mode, the prompt will include the fully qualified domain name of the machine.

### Copying and Moving Settings

All non-restricted (see [Restricted Commands, on page 1239](#)) commands have new operations: **CLUSTERSHOW** and **CLUSTERSET**. **CLUSTERSHOW** is used to show in which modes a command is configured (see [New Operation Added, on page 1238](#)). The **CLUSTERSET** operation allows you to move or copy the current settings

(configurable with the current command) from one mode to another or between levels (e.g. from a machine to a group).

A *copy* retains the settings for the current mode. A *move* resets (clears) the configuration of the current mode; i.e., following a move, no settings will be configured for the current mode.

For example, if you have configured Good Neighbor Table settings (the **destconfig** command) for group **northamerica**, and you decide that you want the entire cluster to have these settings, you can use the **clusterset** operation from within the **destconfig** command to copy (or move) the current settings to the cluster mode. (See [Experimenting with New Configurations, on page 1236.](#))



---

**Caution** Exercise caution when moving or copying configuration settings to avoid inconsistent dependencies. For example, if you move or copy listeners with disclaimer stamping configured to another machine, and that new machine does not have the same disclaimers configured, disclaimer stamping will not be enabled on the new machine.

---

## Experimenting with New Configurations

One of the most advantageous ways to use clusters is to experiment with new configuration settings. First you make changes at the machine mode, in an isolated environment. Then, when you are satisfied with your configuration, you move those configuration changes up to the cluster mode to make them available on all machines.

The following example shows the steps to change a listener setting on one machine and then publish the setting to the rest of the cluster when ready. Because listeners are normally configured at the cluster level, the example starts by pulling the configuration down to machine mode on one machine before making and testing the changes. You should test experimental changes of this type on one machine before making the change to the other machines in the cluster.

### Procedure

---

- Step 1** Use the **clustermode cluster** command to change to the cluster mode.  
Remember: the **clustermode** command is the CLI command you use to change modes to the cluster, group, and machine levels.
- Step 2** Type **listenerconfig** to see the listener settings configured for the cluster.
- Step 3** Choose the machine you want to experiment with, then use the **clusterset** command to copy settings from the cluster “down” to machine mode.
- Step 4** Use the **clustermode** command to navigate to machine mode for the experimental machine, e.g.:  
**clustermode machine newyork.example.com**
- Step 5** In machine mode, on the experimental machine, issue the **listenerconfig** command to make changes specifically for the experimental machine.
- Step 6** Commit the changes.
- Step 7** Continue to experiment with the configuration changes on the experimental machine, remembering to commit the changes.

- Step 8** When you are ready to apply your new settings to all the other machines, use the `clusterset` command to move the settings up to the cluster mode.
- Step 9** Commit the changes.
- 

## Leaving a Cluster Permanently (Removal)

You use the `REMOVEMACHINE` operation of `clusterconfig` to remove a machine permanently from a cluster. When a machine is permanently removed from a cluster, its configuration is “flattened” such that it will work the same as it did when it was part of the cluster. For example, if there is only a cluster-mode Global Unsubscribe table, the Global Unsubscribe table data will be copied to the machine’s local configuration when the machine is removed from the cluster.

## Upgrading Machines in a Cluster

A cluster does not allow the connected machines to have different versions of AsyncOS.

Before you install an AsyncOS upgrade, you need to disconnect each machine in the cluster via the `clusterconfig` command. After you upgrade all the machines, the cluster can be reconnected via the `clusterconfig` command. You can have two separate clusters running while you upgrade machines to the same version. You can also upgrade clustered machines on the GUI Upgrades page.

You can download the upgrade in the background so that you do not need to disconnect the cluster machines until you are ready to install the upgrade.



**Note** If you use the upgrade command before disconnecting the individual machine from the cluster, AsyncOS disconnects all the machines in the cluster. Cisco Systems recommends that you disconnect each machine from the cluster before upgrading it. Then, other machines can continue working as a cluster until each is disconnected and upgraded.

---

### Procedure

---

- Step 1** On a machine in the cluster, use the `disconnect` operation of `clusterconfig`. For example, to disconnect the machine `losangeles.example.com`, type `clusterconfig disconnect losangeles .example.com`. No commit is necessary.
- Step 2** Optionally, use the `suspendlistener` command to halt acceptance of new connections and messages during the upgrade process.
- Step 3** Issue the upgrade command to upgrade AsyncOS to a newer version.
- Note** Disregard any warnings or confirmation prompts about disconnecting all of the machines in the cluster. Because you have disconnected the machine, AsyncOS does not disconnect the other machines in the cluster at this point.
- Step 4** Select the version of AsyncOS for the machine. The machine will reboot after the upgrade is complete.
- Step 5** Use the `resume` command on the upgraded machine to begin accepting new messages.
- Step 6** Repeat steps 1 - 5 for each machine in the cluster.

**Note** After you disconnect a machine from the cluster, you cannot use it to change the configurations of other machines. Although you can still modify the cluster configuration, do not change it while machines are disconnected because settings can become unsynchronized.

**Step 7** After you have upgraded all the machines, use the reconnect operation of clusterconfig for each upgraded machine to reconnect it. For example, to reconnect the machine losangeles.example.com , type clusterconfig reconnect losangeles .example.com. Note that you can only connect a machine to a cluster that is running the same version of AsyncOS.

---

## CLI Command Support

### All Commands Are Cluster-aware

All CLI commands in AsyncOS are now cluster-aware. The behavior of some commands will change slightly when issued in a cluster mode. For example, the behavior of the following commands changes when issued on a machine that is part of a cluster:

#### The commit and clearchanges Commands

##### commit

The commit command commits all changes for all three levels of the cluster, regardless of which mode you are currently in.

##### commitdetail

The commitdetail command provides details about configuration changes as they are propagated to all machines within a cluster.

##### clearchanges

The clearchanges ( clear ) command clears all changes for all three levels of the cluster, regardless of which mode you are currently in.

### New Operation Added

#### CLUSTERSHOW

Within each command, there is now a CLUSTERSHOW operation that allows you to see in which modes a command is configured.

When you enter a CLI command to perform an action that will be overridden by existing settings at a lower level, you will be presented with a notification. For example, if you are in cluster mode and enter a command, you may see a notification like this:

Note: Changes to these settings will not affect the following groups and machines because they are overriding the cluster-wide settings:

```
East_Coast, West_Coast
```

```
facilities_A, facilities_B, receiving_A
```

A similar message would be printed if you are editing settings for a group mode.

## Restricted Commands

Most CLI commands and their corresponding GUI pages can be run in any mode (cluster, group, or machine). However, some commands and pages are restricted to one mode only.

The system interface (either the GUI and the CLI) will always will make it clear that a command is restricted and how it is restricted. It is easy to switch to the appropriate mode for configuring the command.

- In the GUI, use the “Change Mode” menu or the “Settings for this features are currently defined at:” links to switch modes.
- In the CLI, use the `clustermode` command to switch modes.

**Table 156: Commands Restricted to Cluster Mode**

<code>clusterconfig</code>	<code>sshconfig</code>
<code>clustercheck</code>	<code>userconfig</code>
<code>passwd</code>	

If a you try to run one of these commands in group or machine mode, you will be given a warning message and the opportunity to switch to the appropriate mode.



**Note** The `passwd` command is a special case because it needs to be usable by guest users. If a guest user issues the `passwd` command on a machine in a cluster, it will not print the warning message but will instead just silently operate on the cluster level data without changing the user’s mode. All other users will get the above written behavior (consistent with the other restricted configuration commands).

The following commands are restricted to *machine mode* :

<code>antispamstatus</code>	<code>etherconfig</code>	<code>resume</code>	<code>suspenddel</code>
<code>antispamupdate</code>	<code>featurekey</code>	<code>resumedel</code>	<code>suspendlistener</code>
<code>antivirusstatus</code>	<code>hostrate</code>	<code>resumelister</code>	<code>techsupport</code>
<code>antivirusupdate</code>	<code>hoststatus</code>	<code>rollovernow</code>	<code>tophosts</code>
<code>bouncerecipients</code>	<code>interfaceconfig</code>	<code>routeconfig</code>	<code>topin</code>
<code>deleterecipients</code>	<code>ldapflush</code>	<code>sbstatus</code>	<code>trace</code>
<code>delivernow</code>	<code>ldaptest</code>	<code>setgateway</code>	<code>version</code>
<code>diagnostic</code>	<code>nslookup</code>	<code>sethostname</code>	<code>vofflush</code>

dnsflush	quarantineconfig	settime	vofstatus
dnslistflush	rate	shutdown	workqueue
dnslisttest	reboot	status	
dnsstatus	resetcounters	suspend	

If a you try to run one of the commands above in cluster or group mode, you will be given a warning message and the opportunity to switch to an appropriate mode.

The following commands are further restricted to the *login host* (i.e., the specific machine you are logged into). These commands require access to the local file system.

**Table 157: Commands Restricted to Login Host Mode**

last	resetconfig	tail	upgrade
ping	supportrequest	telnet	who

## Administering a Cluster from the GUI

Although you cannot create or join clusters or administer cluster specific settings from the GUI (the equivalent of the **clusterconfig** command), you can browse machines in the cluster, create, delete, copy, and move settings among the cluster, groups, and machines (that is, perform the equivalent of the **clustermode** and **clusterset** commands) from within the GUI.

The Incoming Mail Overview page is an example of a command that is restricted to the login host, because the Mail Flow Monitoring data you are viewing is stored on the local machine. To view the Incoming Mail Overview reports for another machine, you must log into the GUI for that machine.

Note the URL in the browser's address field when clustering has been enabled on an email gateway. The URL will contain the word **machine**, **group**, or **cluster** as appropriate. For example, when you first log in, the URL of the Incoming Mail Overview page will appear as:

**https:// hostnamemachine/serial\_number /monitor/incoming\_mail\_overview**





---

**Note** The Incoming Mail Overview and Incoming Mail Details pages on the Monitor menu are restricted to the login machine.

---

The Mail Policies, Security Services, Network, and System Administration tabs contain pages that are not restricted to the local machine. If you click the Mail Policies tab, the centralized management information in the GUI changes.

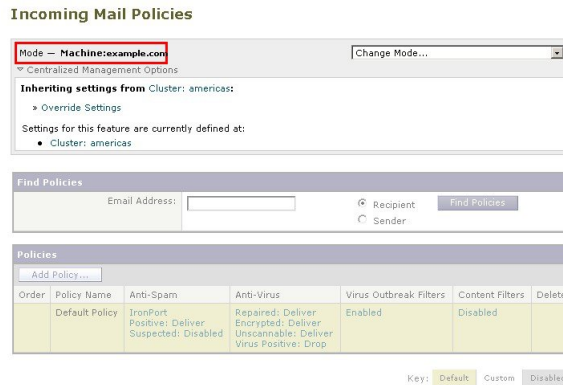

**Figure 80: Centralized Management Feature in the GUI: No Settings Defined**

In the above figure, the machine is inheriting all of its configuration settings for the current feature from the cluster mode. The settings being inherited in a light grey (preview). You can retain these settings or change them, overriding the cluster level settings for this machine.



**Note** The inherited settings (preview display) will always show the settings inherited from the cluster. Use caution when enabling or disabling dependent services among group and cluster levels. For more information, see [Copying and Moving Settings, on page 1235](#).

If you click the Override Settings link, you are taken to a new page for that feature. This page allows you to create new configuration settings for machine mode. You may begin with the default settings, or, if you've already configured settings in another mode, you can copy those settings to this machine.

**Figure 81: Centralized Management Feature in the GUI: Create New Settings**

Alternatively, as shown in *Figure Centralized Management Feature in the GUI: No Settings Defined*, you can also navigate to modes where this configuration setting is already defined. The modes are listed in the lower half of the centralized management box, under “Settings for this feature are currently defined at:”. Only those modes where the settings are actually defined will be listed here. When you view a page for settings that are defined in (and inherited from) another mode, the page will display those settings for you.

If you click on one of the listed modes (for example, the Cluster: Americas link as shown in *Figure Centralized Management Feature in the GUI: No Settings Defined*), you will be taken to a new page that allows you to view and manage the settings for that mode.

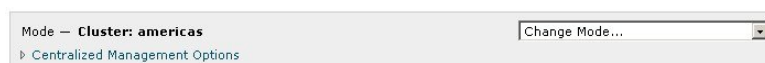
**Figure 82: Centralized Management Feature in GUI: Settings Defined**

When settings are defined for a given mode, the centralized management box is displayed on every page in a minimized state. Click the “Centralized Management Options” link to expand the box to show a list of options available for the current mode with respect to the current page. Clicking the “Manage Settings” button allows you to copy or move the current settings to a different mode or to delete those settings completely.

For example, in the following figure, the Centralized Management Options link has been clicked to present the available options.

**Figure 83: Centralized Management Feature in GUI: Manage Settings**

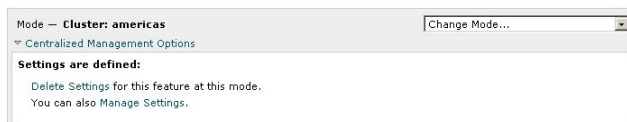

On the right side of the box is the “Change Mode” menu. This menu displays your current mode and provides the ability to navigate to any other mode (cluster, group, or machine) at any time.

**Figure 84: The Change Mode Menu**

### Incoming Mail Policies

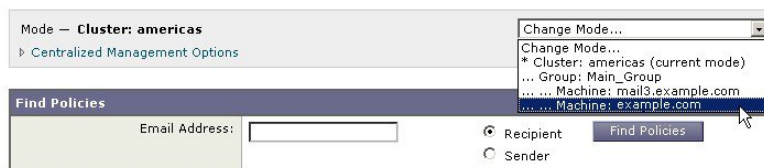

When you navigate to a page that represents a different mode, the “Mode —” text on the left side of the centralized management box will flash yellow, briefly, to alert you that your mode has changed.

Some pages within certain tabs are restricted to machine mode. However, unlike the Incoming Mail Overview page (which is restricted to the current login host), these pages can be used for any machine in the cluster.

**Figure 85: Centralized Management Feature: Machine Restricted**



Choose which machine to administer from the Change Mode menu. You will see a brief flashing of the text to remind you that you have changed modes.

## Cluster Communication

Machines within a cluster communicate with each other using a mesh network. By default, all machines connect to all other machines. If one link goes down, other machines will not be prevented from receiving updates.

By default, all intra-cluster communication is secured with SSH. Each machine keeps an in-memory copy of the route table and makes in-memory changes as necessary if links go down or up. Each machine also performs a periodic “ping” (every 1 minute) of every other machine in the cluster. This ensures up-to-date link status and maintains the connections in case a router or NAT has a timeout.



**Note** If your email gateways are in a cluster mode, and you plan to access data (not related to configuration, for example, viewing messages present in the quarantine or refreshing reports at a fast rate) of another email gateway remotely; there will be cluster reconnection attempts that can generate alerts and errors. The email gateways automatically will reconnect and manual intervention is not required..

## DNS and Hostname Resolution

DNS is required to connect a machine to the cluster. Cluster communication is normally initiated using the DNS hostnames of the machines (not the hostname of an interface on the machine). A machine with an unresolvable hostname would be unable to actually communicate with any other machines in the cluster, even though it is technically part of the cluster.

Your DNS must be configured to have the hostname point to the correct IP interface on the email gateway that has SSH or CCS enabled. This is very important. If DNS points to another IP address that does not have SSH or CCS enabled it will not find the host. Note that centralized management uses the “main hostname,” as set with the `sethostname` command, not the per-interface hostname.

If you use an IP address to connect to another machine in the cluster, the machine you connect to must be able to make a reverse look up of the connecting IP address. If the reverse look up times out because the IP address isn't in the DNS, the machine cannot connect to the cluster.

## Clustering, Fully Qualified Domain Names, and Upgrading

DNS changes can cause a loss of connectivity after upgrading AsyncOS. Please note that if you need to change the fully qualified domain name of a machine in the cluster (not the hostname of an interface on a machine in the cluster), you must change the hostname settings via `sethostname` and update the DNS record for that machine *prior* to upgrading AsyncOS.

## Cluster Communication Security

Cluster Communication Security (CCS) is a secure shell service similar to a regular SSH service. Cisco implemented CCS in response to concerns regarding using regular SSH for cluster communication. SSH communication between two machines opens regular logins (admin, etc.) on the same port. Many administrators prefer not to open regular logins on their clustered machines.

Tip: never enable Cluster Communication Services, even though it is the default, unless you have firewalls blocking port 22 between some of your clustered machines. Clustering uses a full mesh of SSH tunnels (on port 22) between all machines. If you have already answered Yes to enabling CCS on any machine, remove all machines from the cluster and start again. Removing the last machine in the cluster removes the cluster.

CCS provides an enhancement where the administrator can open up cluster communication, but not CLI logins. By default, the service is disabled. You will be prompted to enable CCS from the `interfaceconfig` command when you are prompted to enable other services. For example:

```
Do you want to enable SSH on this interface? [Y]>
```

```
Which port do you want to use for SSH?
```

```
[22]>
```

```
Do you want to enable Cluster Communication Service on this interface?
```

```
[N]> y
```

```
Which port do you want to use for Cluster Communication Service?
```

```
[2222]>
```

The default port number for CCS is 2222. You may change this to another open, unused, port number if you prefer. After the join is complete and the joining machine has all the configuration data from the cluster, the following question is presented:

```
Do you want to enable Cluster Communication Service on this interface? [N]> y
```

```
Which port do you want to use for Cluster Communication Service?
```

```
[2222]>
```

## Cluster Consistency

The machines that are “cluster aware” will continually verify network connections to other machines within the cluster. This verification is done by periodic “pings” sent to other machines in the cluster.

If all attempts to communicate with a particular machine fail, then the machine that has been trying to communicate will log a message saying that the remote host has disconnected. The system will send an alert to the administrator that the remote host went down.

Even if a machine is down, the verification pings will continue to be sent. When a machine rejoins the cluster network, a synchronization command will be issued so that any previously offline machines can download any updates. The synchronization command will also determine if there have been any changes on one side but not the other. If so, then the previously down machine will silently download the updates.

## Disconnect/Reconnect

A machine may be disconnected from a cluster. Occasionally, you may intend to deliberately disconnect the machine, for example, because you are upgrading the machine. A disconnect could also occur by accident, for example, due to a power failure or other software or hardware error. A disconnect can also occur if one email gateway attempts to open more than the maximum number of SSH connections allowed in a session. A machine that is disconnected from a cluster can still be accessed directly and configured; however, any changes made will not be propagated to other machines within the cluster until the disconnected machine becomes reconnected.

When a machine reconnects to the cluster, it tries to reconnect to all machines at once.

In theory, two machines in a cluster that are disconnected could commit a similar change to their local databases at the same time. When the machines are reconnected to the cluster, an attempt will be made to synchronize these changes. If there is a conflict, the most recent change is recorded (supersedes any other changes).

During a commit, the email gateway checks every variable that is being changed. The commit data includes version information, sequence identification numbers, and other information that can be compared. If the data you are about to change is found to be in conflict with previous changes, you will be given the option to discard your changes. For example, you might see something like this:

```
(Machine mail3.example.com)> clustercheck
```

```
This command is restricted to "cluster" mode. Would you like to switch to "cluster"
```

```
mode? [Y]> y
Checking Listeners (including HAT, RAT, bounce profiles)...
Inconsistency found!
Listeners (including HAT, RAT, bounce profiles) at Cluster enterprise:
mail3.example.com was updated Mon Sep 12 10:59:17 2005 PDT by 'admin' on
mail3.example.com
test.example.com was updated Mon Sep 12 10:59:17 2005 PDT by 'admin' on
mail3.example.com
How do you want to resolve this inconsistency?
1. Force entire cluster to use test.example.com version.
2. Force entire cluster to use mail3.example.com version.
3. Ignore.
[1]>
```

If you choose not to discard your changes, they are still intact (but uncommitted). You can review your changes against the current settings and decide how to proceed.

You can also use the `clustercheck` command at any time to verify that the cluster is operating correctly.

```
losangeles> clustercheck
Do you want to check the config consistency across all machines in the cluster? [Y]> y
Checking losangeles...
Checking newyork...
No inconsistencies found.
```

## Interdependent Settings

It is recommended that you avoid configuring the following settings on the email gateway.

In a centrally managed environment, some interdependent settings are configured in different modes. The flexibility of the configuration model allows you to configure settings at multiple modes, and the laws of inheritance govern which settings will be used on a per-machine basis. However, some settings have dependencies on other settings, and the availability of the dependent settings' configuration is not limited to settings at the same mode. Thus, it is possible to configure a setting for one level that references a setting that is configured for a specific machine at a different level.

The most common example of an interdependent setting involves a select field on a page that pulls data from a different cluster section. For example, the following features can be configured in different modes:

- using LDAP queries
- using dictionaries or text resources
- using bounce or SMTP authentication profiles.

Within centralized management, there are restricted and non-restricted commands. (See [Restricted Commands, on page 1239](#).) Non-restricted commands are generally configuration commands that can be shared across the cluster.

The `listenerconfig` command is an example of a command that can be configured for all machines in a cluster. Non-restricted commands represent commands that can be mirrored on all machines in a cluster, and do not require machine-specific data to be modified.

Restricted commands, on the other hand, are commands that only apply to a specific mode. For example, users cannot be configured for specific machines — there must be only one user set across the whole cluster. (Otherwise, it would be impossible to login to remote machines with the same login.) Likewise, since the Mail Flow Monitor data, System Overview counters, and log files are only maintained on a per-machine basis, these commands and pages must be restricted to a machine.

You will notice that while Scheduled Reports may be configured identically across the whole cluster, the viewing of reports is machine-specific. Therefore, within a single Scheduled Reports page in the GUI, configuration must be performed at the cluster mode, but viewing of reports must be done at the machine mode.

The System Time pages encompass the `settz`, `ntpconfig`, and `settime` commands, and thus represents a mixture of restricted and non-restricted commands. In this case, `settime` must be restricted to machine-only modes (since time settings are specific for machine), while `settz` and `ntpconfig` may be configured at cluster or group modes.

**Figure 86: Example of Interdependent Settings**

In this representation, the listener “IncomingMail” is referencing a footer named “disclaimer” that has been configured at the machine level only. The drop-down list of available footer resources shows that the footer is not available on the machine “buttercup.run” which is also available in the cluster. There are two solutions to this dilemma:

- promote the footer “disclaimer” from the machine level to the cluster level
- demote the listener to the machine level to remove the interdependency

In order to fully maximize the features of a centrally managed system, the former solution is preferred. Be aware of interdependencies among settings as you tailor the configuration of your clustered machines.

# Loading a Configuration in Clustered Email Gateway

AsyncOS allows you to load a cluster configuration in clustered email gateways. You can load the cluster configuration in the following scenarios:

- If you are migrating from an on-premise environment to a hosted environment and you want to migrate the on-premise cluster configuration to the hosted environment.
- If an email gateway in a cluster is down or needs to be retired and you want to load the configuration from this email gateway to a new email gateway that you plan to add to the cluster.
- If you are adding more email gateways to your cluster and you want to load the configuration from one of the existing email gateways in the cluster to the newly added email gateways.
- If you want to load a backed-up configuration to a cluster.

Depending on your requirements, you can load a cluster configuration or email gateway configuration from a valid cluster configuration file.



---

**Note** You cannot load the configuration of a standalone email gateway on a clustered email gateway.

---

## Before You Begin

- Make sure that you have a valid and complete XML configuration. See [Loading a Configuration File, on page 1023](#).
- Create a backup of the current configuration of the email gateway to which you plan to load the configuration. See [Saving and Exporting the Current Configuration File, on page 1022](#).
- Create a cluster setup with all the email gateways that you plan to have in your setup. See [Creating and Joining a Cluster, on page 1228](#).



---

**Note** You can have all the email gateways under one group. Ensure that the interfaces for cluster communication in your setup have same names and SSH and CCS settings as in the XML configuration.

---

## Procedure

- 
- Step 1** Click **System Administration > Configuration File**.
- Step 2** Choose the cluster from the **Mode** drop-down menu.
- Step 3** Depending on whether you want to load cluster or email gateway configuration, do one of the following:
- **Load Cluster Configuration**
    - a. In the Load Configuration section, choose **Cluster** from the drop-down list.
    - b. Load the cluster configuration, and click **Load**. See [Loading a Configuration File, on page 1023](#).
    - c. Assign groups from the loaded configuration to the email gateways in the cluster, and copy email gateway configuration from the email gateways in the selected group to the respective email gateways. Use the **Group Configuration** and **Appliance Configuration** drop-down lists.
- If you do not want to copy an email gateway configuration, choose **Don't Copy** from the **Appliance Configuration** drop-down list.

1. Review the configuration. Click **Review**.
2. Click **Confirm**.
3. Click **Continue**.

- **Load Email Gateway Configuration**

- a. In the Load Configuration section, choose **Appliance in cluster** from the drop-down list.
- b. Load the configuration, and click **Load**. See [Loading a Configuration File, on page 1023](#). Note that you cannot load the configuration of a standalone email gateway on a clustered email gateway.
- c. Choose the email gateway configuration from the loaded configuration and the intended email gateway in the cluster to which you want to load the configuration. Use the drop-down lists.
- d. Click **OK**.
- e. Click **Continue**.
- f. To load the email gateway configuration to more email gateways, repeat Step a through Step e.

**Step 4** Review the network settings of the clustered email gateways, and commit your changes.

---

## Best Practices and Frequently Asked Questions

### Best Practices

When you create the cluster, the machine you happen to be logged into is automatically added to the cluster as the first machine, and also added to the Main\_Group. Its machine level settings effectively get moved to the cluster level as much as possible. There are no settings at the group level, and the only settings left at the machine level are those which do not make sense at the cluster level, and cannot be clustered. Examples are IP addresses, featurekeys, etc.

Leave as many settings at the cluster level as possible. If only one machine in the cluster needs a different setting, copy that cluster setting to the machine level for that machine. Do not move that setting. If you move a setting which has no factory default (e.g. HAT table, SMTPROUTES table, LDAP server profile, etc.), the systems inheriting the cluster settings will have blank tables and will probably not process email.

To have that machine re-inherit the cluster setting, manage the CM settings and delete the machine setting. You will only know if a machine is overriding the cluster setting when you see this display:

Settings are defined:

To inherit settings from a higher level: Delete Settings for this feature at this mode.

You can also Manage Settings.

Settings for this feature are also defined at:

**Cluster:** **xxx**

Or this display:

Delete settings from:

**Cluster:** **xxx**

**Machine:** **yyyy.domain.com**



## Copy vs Move

When to copy: when you want the cluster to have a setting, and a group or machine to also have no settings or to have different settings.

When to move: when you want the cluster to have no setting at all, and for the group or machine to have the settings.

## Good CM Design Practices

When you LIST your CM machines, you want to see something like this:

```
cluster = CompanyName
```

```
Group Main_Group:
```

```
Machine lab1.example.com (Serial #: XXXXXXXXXXXXXXX-XXXXXXX)
```

```
Machine lab2.example.com (Serial #: XXXXXXXXXXXXXXX-XXXXXXX)
```

```
Group Paris:
```

```
Machine lab3.example.com (Serial #: XXXXXXXXXXXXXXX-XXXXXXX)
```

```
Machine lab4.example.com (Serial #: XXXXXXXXXXXXXXX-XXXXXXX)
```

```
Group Rome:
```

```
Machine lab5.example.com (Serial #: XXXXXXXXXXXXXXX-XXXXXXX)
```

```
Machine lab6.example.com (Serial #: XXXXXXXXXXXXXXX-XXXXXXX)
```

Be careful not to lose track of the level at which you are making changes. For example, if you have changed the name of your Main\_Group (using RENAMEGROUP) to London, it will look like this:

```
cluster = CompanyName
```

```
Group London:
```

```
Machine lab1.cable.nu (Serial #: 000F1FF7B3F0-CF2SX51)
```

```
...
```

However, this configuration tends to confuse many administrators, because they begin making changes to the London systems at the group level, and they stop using the Cluster level as the normal configuration level for basic settings.

**Tip:** it is not a good practice to have a group with the same name as the cluster, e.g. cluster London, group London. If you are using site names for group names, it is not good practice to have a cluster name that refers to a location.

The correct method, as explained above, is to leave as many settings at the cluster level as possible. In most cases you should leave your primary site or main collection of machines in the Main\_Group, and use groups for your additional sites. This is true even if you consider that both sites are “equal.” Remember, CM has no primary/secondary servers — all clustered machines are peers.

**Tip:** if you will be using extra groups you can easily prepare the groups before those extra machines are joined to the cluster.

## Best Practices for Accessing Spam or Policy Quarantines in Cluster Setup

Accessing spam or policy quarantines of other appliances in a cluster from the logged-in email gateway may cause excessive CPU usage on the logged-in email gateway. To avoid this scenario, you can access the spam or policy quarantines by logging into the required email gateways.

### Procedures: Configuring an Example Cluster

To configure this example cluster, log out of all GUIs on all machines before running `clusterconfig`. Run `clusterconfig` on any one of the primary site machines. You will then join to this cluster only the other local and remote machines that need the maximum possible shared settings (allowing for the machine only-settings like IP address). The `clusterconfig` command cannot be used to join a remote machine to the cluster — you must use the CLI on the remote machine and run `clusterconfig` (“join an existing cluster”).

In our example above we log in to `lab1`, run `clusterconfig` and create a cluster called `CompanyName`. We have only one machine with identical requirements, so we log in to `lab2`, and `saveconfig` the existing configuration (it will be drastically altered when it inherits most of `lab1` settings.) On `lab2` we can then use `clusterconfig` to join an existing cluster. Repeat if you have additional machines at this site needing similar policies and settings.

Run `CONNSTATUS` to confirm that DNS resolves correctly. As machines are joined to the cluster, the new machines inherit almost all of their settings from `lab1` and their older settings are lost. If they are production machines you will need to anticipate if mail will still be processed using the new configuration instead of their previous configuration. If you remove them from the cluster, they will not revert to their old, private configs.

Next, we count the number of exceptional machines. If there is only one, it should receive a few extra machine level settings and you will not need to create an extra group for it. Join it to the cluster and begin copying settings down to the machine level. If this machine is an existing production machine you must back up the configuration and consider the changes to mail processing as above.

If there are two or more, as in our example, decide if those two will share any settings with each other that are not shared with the cluster. In that case, you will be creating one or more groups for them. Otherwise, you will make machine level settings for each, and do not need to have extra groups.

In our case we want to run `clusterconfig` from the CLI on any of the machines already in the cluster, and select `ADDGROUP`. We will do this twice, once for `Paris` and once for `Rome`.

Now you can begin using the GUI and CLI to build configuration settings for the cluster and for ALL the groups, even if the groups have no machines in them yet. You will only be able to create machine specific settings for machines *after* they have joined the cluster.

The best way to create your override or exceptional settings is to copy the settings from the higher (e.g. cluster) level down to a lower (e.g. group) level.

For example, after creating the cluster our `dnsconfig` settings initially looked like this:

Configured at mode:

Cluster: Yes

Group `Main_Group`: No

Group `Paris`: No

Group `Rome`: No

Machine `lab2.cable.nu`: No

If we "Copy to Group" the DNS settings, it will look like this:

Configured at mode:

Cluster: Yes

Group Main\_Group: No

Group Paris: Yes

Group Rome: No

Machine lab2.cable.nu: No

Now you can edit the Paris group-level DNS settings, and other machines in the Paris group will inherit them. Non-Paris machines will inherit the cluster settings, unless they have machine-specific settings. Besides DNS settings, it is common to create group level settings for SMTPROUTES.



**Tip** When using the CLI CLUSTERSET function in various menus, you can use a special option to copy settings to All Groups, which is not available through the GUI.

Complete listeners will be automatically inherited from the group or cluster, and you normally only create these on the first system in the cluster. This reduces administration considerably. However, for this to work *you must name the Interfaces identically throughout your group or cluster*.

Once the settings are defined correctly at the group level, you can join machines to the cluster and make them part of this group. This requires two steps:

First, to join our remaining 4 systems to the cluster, we run clusterconfig on each. The larger and more complex the cluster, the longer it takes to join, and this can take several minutes. You can monitor the joining progress with the LIST and CONNSTATUS sub-commands. After the joins are complete you can use SETGROUP to move the machines from the Main\_Group into Paris and Rome. There is no way to avoid the fact that initially, all machines added to the cluster inherit the Main\_Group settings, not the Paris and Rome settings. This could affect mail flow traffic if the new systems are already in production.



**Tip** Do not make your lab machines part of the same cluster as your production machines. Use a new cluster name for lab systems. This provides an added layer of protection against unexpected changes (someone changing a lab system and accidentally losing production mail, for example).

## Summary of GUI Options for Using CM Settings Other Than the Cluster Default

Override settings, and start with default settings. For example, the default settings for the SMTPROUTES configuration is a blank table, which you can then build from scratch.

Override settings, but start with a copy of the settings currently inherited from Cluster xxx, or group yyy. For example, you may want a new copy of the SMTPROUTES table at the group level which is initially identical to the cluster table. All email gateways that are contained in that same group (SETGROUP) will get this table. Machines not in the group will still use the cluster level settings. Changing the SMTPROUTES on this independent copy of the table will not affect other groups, machines inheriting the cluster settings, or machines where the setting is defined at the individual machine level. This is the most common selection.

Manage settings, a sub-menu of Centralized Management Options. From this menu you can copy as above, but you can also move or delete settings. If you move the SMTPROUTES to a group or machine level, then the routes table will be blank at the cluster level but will exist at the more specific level.

Manage settings. Continuing our SMTPROUTES example, using the delete option will also result in a blank SMTPROUTES table for the cluster. This is fine if you previously configured definitions for SMTPROUTES

at the group level or machine levels. It is not a best practice to delete the cluster level settings and rely only on group or machine settings. The cluster-wide settings are useful as defaults on newly added machines, and keeping them reduces the number of group or site settings you have to maintain by one.

## Setup and Configuration Questions

**Q.** I have a previously configured standalone machine and I join an existing cluster. What happens to my settings?

**A.** When a machine joins a cluster, all of that machine's clusterable settings will be inherited from the cluster level. Upon joining a cluster, all locally configured non-network settings will be lost, overwritten with the settings of the cluster and any associated groups. (This includes the user/passphrase table; passphrases and users are shared within a cluster).

**Q.** I have a clustered machine and I remove it (permanently) from the cluster. What happens to my settings?

**A.** When a machine is permanently removed from a cluster, its configuration hierarchy is “flattened” such that the machine will continue to work the same as it did when it was part of the cluster. All settings that the machine has been inheriting will be applied to the machine in the standalone setting.

For example, if there is only a cluster-mode Global Unsubscribe table, that Global Unsubscribe table data will be copied to the machine's local configuration when the machine is removed from the cluster.

## General Questions

**Q.** Are log files aggregated within centrally managed machines?

**A.** No. Log files are still retained for each individual machines. Cisco Secure Manager Email and Web Gateway can be used to aggregate mail logs from multiple machines for the purposes of tracking and reporting.

**Q.** How does User Access work?

**A.** The email gateway share one database for the entire cluster. In particular, there is only admin account (and passphrase) for the entire cluster.

**Q.** How should I cluster a data center?

**A.** Ideally, a data center would be a “group” within a cluster, not its own cluster. However, if the data centers do not share much between themselves, you may have better results with separate clusters for each data center.

**Q.** What happens if systems are offline and they reconnect?

**A.** Systems attempt to synchronize upon reconnecting to the cluster.

## Network Questions

**Q.** Is the centralized management feature a “peer-to-peer” architecture or a “primary/secondary” architecture?

**A.** Because every machine has all of the data for all of the machines (including all machine-specific settings that it will never use), the centralized management feature can be considered a peer-to-peer architecture.

**Q.** How do I set up a box so it is not a peer? I want a “secondary” system.

**A.** Creating a true “secondary” machine is not possible with this architecture. However, you can disable the HTTP (GUI) and SSH (CLI) access at the machine level. In this manner, a machine without GUI or CLI

access *only* be configured by clusterconfig commands (that is, it can never be a login host). This is similar to having a secondary machine, but the configuration can be defeated by turning on login access again.

**Q.** Can I create multiple, segmented clusters?

**A.** Isolated “islands” of clusters are possible; in fact, there may be situations where creating them may be beneficial, for example, for performance reasons.

**Q.** I would like to reconfigure the IP address and hostname on one of my clustered email gateways. If I do this, will I lose my GUI/CLI session before being able to run the reboot command?

**A.** Follow these steps:

1. Add the new IP address
2. Move the listener onto the new address
3. Leave the cluster
4. Change the hostname
5. Make sure that oldmachinename does not appear in the clusterconfig connections list when viewed from any machine
6. Make sure that all GUI sessions are logged out
7. Make sure that CCS is not enabled on any interface (check via interfaceconfig or Network > Listeners)
8. Add the machine back into the cluster

**Q.** Can the Destination Controls function be applied at the cluster level, or is it local machine level only?

**A.** It may be set at a cluster level; however, the limits are on a per-machine basis. So if you limit to 50 connections, that is the limit set for each machine in the cluster.

## Planning and Configuration

**Q.** What can I do to maximize efficiency and minimize problems when setting up a cluster?

**1.** Initial Planning

- Try to configure as many things as possible at the cluster level.
- Manage by machines only for the exceptions.
- If you have multiple data centers, for example, use groups to share traits that are neither cluster-wide nor necessarily machine-specific.
- Use the same name for Interfaces and Listeners on each of the email gateways.

**2.** Be aware of restricted commands.

**3.** Pay attention to interdependencies among settings.

For example, the listenerconfig command (even at the cluster level) depends on interfaces that only exist at a machine level. If the interface does not exist at the machine level on all machines in the cluster, that listener will be disabled.

Note that deleting an interface would also affect listenerconfig .

**4.** Pay attention to your settings!

Remember that previously-configured machines will lose their independent settings upon joining a cluster. If you want to re-apply some of these previously configured settings at the machine level, be sure to take note of all settings before joining the cluster.

Remember that a “disconnected” machine is still part of the cluster. When it is reconnected, any changes you made while it was offline will be synchronized with the rest of the cluster.

Remember that if you permanently remove a machine from a cluster, it will retain all of the settings it had as part of that cluster. However, if you change your mind and re-join the cluster, the machine will lose all standalone settings.

Use the `saveconfig` command to keep records of settings.



## CHAPTER 46

# Testing and Troubleshooting

---

This chapter contains the following sections:

- [Debugging Mail Flow Using Test Messages: Trace](#), on page 1255
- [Using the Listener to Test the Email Gateway](#), on page 1261
- [Troubleshooting the Network](#), on page 1265
- [Troubleshooting the Listener](#), on page 1270
- [Troubleshooting Email Delivery From the Appliance](#), on page 1271
- [Troubleshooting Performance](#), on page 1273
- [Web Interface Appearance and Rendering Issues](#) , on page 1274
- [Responding to Alerts](#) , on page 1274
- [Troubleshooting Hardware Issues](#) , on page 1274
- [Remotely Resetting Email Gateway Power](#) , on page 1275
- [Working with Technical Support](#), on page 1275

## Debugging Mail Flow Using Test Messages: Trace

You can use **System Administration > Trace** page (the equivalent of the trace command in the CLI) to debug the flow of messages through the system by emulating sending a test message. The Trace page (and **trace** CLI command) emulates a message as being accepted by a listener and prints a summary of features that would have been “triggered” or affected by the current configuration of the system (*including uncommitted changes* ). The test message is not actually sent. The Trace page (and **trace** CLI command) can be a powerful troubleshooting or debugging tool, especially if you have combined many of the advanced features available on the email gateway.



---

**Note** Trace is not effective for testing file reputation scanning.

---

The Trace page (and **trace** CLI command) prompts you for the input parameters listed in the following table.

Table 158: Input for the Trace page

Value	Description	Example
Source IP address	Type the IP address of the remote client to mimic the source of the remote domain. This can be an Internet Protocol version 4 (IPv4) or version 6 (IPv6) address.  Note: The trace command prompts for an IP address and a fully-qualified domain name. It does <i>not</i> attempt to reverse the IP address to see if it matches the fully-qualified domain name. The trace command does not allow the fully-qualified domain name field to be blank, so it is impossible to test a scenario where the DNS does not reverse match properly.	<b>203.45.98.109</b> <b>2001:0db8:85a3::8a2e:0370:7334</b>
Fully Qualified Domain Name of the Source IP	Type the fully-qualified remote domain name to mimic. If left null, a reverse DNS lookup will be performed on the source IP address.	<b>smtp.example.com</b>
Listener to Trace Behavior on	Choose from the list of listeners configured on the system to emulate sending the test message to.	<b>InboundMail</b>
Network Owner Organization ID	Type the unique identification number of the network owner, or allow the system to Lookup network owner ID associated with source IP address. You can view this information if you added network owners to sender groups via the GUI.	<b>34</b>
IP Reputation Score	Type the IP Reputation score you want to provide for the spoofed domain, or allow the system to look up the IP Reputation score associated with the source IP address. This can be helpful when testing policies that use IP Reputation scores. Note that manually entered IP Reputation scores are not passed to the Context Adaptive Scanning Engine (CASE). See <a href="#">Editing IP Reputation Filtering Score Thresholds for a Listener</a> , on page 84 for more information.	<b>-7.5</b>
Envelope Sender	Type the Envelope Sender of the test message.	<b>admin@example.net</b>
Envelope Recipients	Type a list of recipients for the test message. Separate multiple entries with commas.	<b>joe</b> <b>frank@example.com</b>



Value	Description	Example
Message Body	Type the message body for the test message, including headers. Type a period on a separate line to end entering the message body. Note that “headers” are considered part of a message body (separated by a blank line), and omitting headers, or including poorly formatted ones can cause unexpected trace results.	<b>To: 1@example.com</b> From: ralph Subject: Test <b>this is a test message</b> .

After you have entered the values, click **Start Trace**. A summary of all features configured on the system affecting the message is printed.

You can upload message bodies from your local file system. (In the CLI, you can test with message bodies you have uploaded to the `/configuration` directory. See [FTP, SSH, and SCP Access, on page 1303](#) for more information on placing files for import onto the email gateway.)

After the summary is printed, you are prompted to view the resulting message and re-run the test message again. If you enter another test message, the Trace page and the trace command uses any previous values from the above table you entered.



**Note** The sections of configuration tested by the trace command listed in the following table are performed *in order*. This can be extremely helpful in understanding how the configuration of one feature affects another. For example, a recipient address transformed by the domain map feature will affect the address as it is evaluated by the RAT. A recipient that is affected by the RAT will affect the address as it is evaluated by alias table, and so on.

**Table 159: Viewing Output When Performing a Trace**

trace Command Section	Output
Host Access Table (HAT) and Mail Flow Policy Processing	<p>The Host Access Table settings for the listener you specified are processed. The system reports which entry in the HAT matched from the remote IP address and remote domain name you entered. You can see the default mail flow policies and sender groups and which one matched the given entries.</p> <p>If the email gateway was configured to reject the connection (either through a REJECT or TCPREFUSE access rule), the trace command exits at the point in the processing.</p> <p>For more information on setting HAT parameters, see <a href="#">Understanding Predefined Sender Groups and Mail Flow Policies, on page 98</a>.</p>
<b>Envelope Sender Address Processing</b>	
<p>These sections summarize how the email gateway configuration affects the Envelope Sender you supply. (That is, how the MAIL FROM command would be interpreted by the configuration of the email gateway.) The <code>trace</code> command prints “<b>Processing MAIL FROM:</b>” before this section.</p>	

trace Command Section	Output
Default Domain	<p>If you specified that a listener to change the default sender domain of messages it receives, any change to the Envelope Sender is printed in this section.</p> <p>For more information, see <a href="#">Configuring the Gateway to Receive Email, on page 65</a>.</p>
Masquerading	<p>If you specified that the Envelope Sender of a message should be transformed, the change is noted here. You enable masquerading for the Envelope Sender on private listeners using the <b>listenerconfig -&gt; edit -&gt; masquerade -&gt; config subcommands</b>.</p> <p>For more information, see <a href="#">Configuring Routing and Delivery Features, on page 693</a>.</p>
<p><b>Envelope Recipient Processing</b></p> <p>These sections summarize how the email gateway affects the Envelope Recipients you supply. (That is, how the RCPT TO command would be interpreted by the configuration of the email gateway.) The trace command prints “ Processing Recipient List: ” before this section.</p>	
Default Domain	<p>If you specified that a listener to change the default sender domain of messages it receives, any changes to the Envelope Recipients are printed in this section.</p> <p>For more information, see <a href="#">Configuring the Gateway to Receive Email, on page 65</a>.</p>
Domain Map Translation	<p>The domain map feature transforms the recipient address to an alternate address. If you specified any domain map changes and a recipient address you specified matches, the transformation is printed in this section.</p> <p>For more information, see <a href="#">Configuring Routing and Delivery Features, on page 693</a>.</p>
Recipient Access Table (RAT)	<p>Each Envelope Recipient that matches an entry in the RAT is printed in this section, in addition to the policy and parameters. (For example, if a recipient was specified to bypass limits in the listener’s RAT.)</p> <p>For more information on specifying recipients you accept, see <a href="#">Configuring the Gateway to Receive Email, on page 65</a>.</p>
Alias Table	<p>Each Envelope Recipient that matches an entry in the alias tables configured on the email gateway (and the subsequent transformation to one or more recipient addresses) is printed in this section.</p> <p>For more information, see <a href="#">Configuring Routing and Delivery Features, on page 693</a>.</p>

trace Command Section	Output
<p><b>Pre-Queue Message Operations</b></p> <p>These sections summarize how the email gateway affects each message after the message contents have been received, but before the messages are enqueued on the work queue. This processing occurs before the final <b>250 ok</b> command is returned to the remote MTA.</p> <p>The <b>trace</b> command prints “Message Processing : ” before this section.</p>	
Virtual Gateways	<p>The <b>altsrchost</b> command assigns messages to a specific interface, based on a match of the Envelope Sender’s full address, domain, or name, or IP address. If an Envelope Sender matches entries from the <b>altsrchost</b> command, that information is printed in this section.</p> <p>Note that the virtual gateway address assigned at this point may be overridden by message filter processing below.</p> <p>For more information, see <a href="#">Configuring Routing and Delivery Features, on page 693</a>.</p>
Bounce Profiles	<p>Bounce profiles are applied at three different points in the processing. This is the first occurrence. If a listener has a bounce profile assigned to it, it is assigned at this point in the process. That information is printed in this section.</p> <p>For more information, see <a href="#">Configuring Routing and Delivery Features, on page 693</a>.</p>
<p><b>Work Queue Operations</b></p> <p>The following group of functions are performed on messages in the work queue. This occurs after the message has been accepted from the client, but before the message is enqueued for delivery on a destination queue. “Messages in Work Queue” is reported by the status and status detail commands.</p>	
Masquerading	<p>If you specified that the To:, From:, and CC: headers of messages should be masked (either from a static table entered from a listener or via an LDAP query), the change is noted here. You enable masquerading for the message headers on private listeners using the <b>listenerconfig -&gt; edit -&gt; masquerade -&gt; config subcommands</b>.</p> <p>For more information, see <a href="#">Configuring Routing and Delivery Features, on page 693</a>.</p>
LDAP Routing	<p>If LDAP queries have been enabled on a listener, the results of LDAP acceptance, re-routing, masquerading, and group queries are printed in this section.</p> <p>For more information, see <a href="#">LDAP Queries, on page 771</a>.</p>

trace Command Section	Output
Message Filters Processing	<p>All messages filters that are enabled on the system are evaluated by the test message at this point. For each filter, the rule is evaluated, and if the end result is “true,” each of the actions in that filter are then performed in sequence. A filter may contain other filters as an action, and the nesting of filters is unlimited. If a rule evaluates to “false” and a list of actions is associated with an else clause, those actions are evaluated instead. The results of the message filters, processed in order, are printed in this section.</p> <p>See <a href="#">Using Message Filters to Enforce Email Policies, on page 127</a>.</p>
<p><b>Mail Policy Processing</b></p> <p>The mail policy processing section displays the Anti-Spam, Anti-Virus, Outbreak Filters feature, and disclaimer stamping for all recipients you supplied. If multiple recipients match multiple policies in Email Security Manager, the following sections will be repeated for each matching policy. The string: “Message Going to” will define which recipients matched which policies.</p>	
Anti-Spam	<p>This section notes messages that are not flagged to be processed by anti-spam scanning. If messages are to be processed by anti-spam scanning for the listener, the message is processed and the verdict returned is printed. If the email gateway is configured to bounce or drop the messages based on the verdict, that information is printed and the <b>trace</b> command processing stops.</p> <p>Note: This step is skipped if anti-spam scanning is unavailable on the system. If anti-spam scanning is available but has not been enabled with a feature key, that information is also printed in this section.</p> <p>See <a href="#">Managing Spam and Graymail, on page 379</a>.</p>
Anti-Virus	<p>This section notes messages that are not flagged to be processed by anti-virus scanning. If messages are to be processed by anti-virus scanning for the listener, the message is processed and the verdict returned is printed. If the email gateway is configured to “clean” infected messages, that information is noted. If configured to bounce or drop the messages based on the verdict, that information is printed and the trace command processing stops.</p> <p>Note: This step is skipped if anti-virus scanning is unavailable on the system. If anti-virus scanning is available but has not been enabled with a feature key, that information is also printed in this section.</p> <p>See the <a href="#">Anti-Virus, on page 361</a>.</p>
Content Filters Processing	<p>All content filters that are enabled on the system are evaluated by the test message at this point. For each filter, the rule is evaluated, and if the end result is “true,” each of the actions in that filter are then performed in sequence. A filter may contain other filters as an action, and the nesting of filters is unlimited. The results of the content filters, processed in order, are printed in this section.</p> <p>See <a href="#">Content Filters, on page 269</a>.</p>

trace Command Section	Output
Outbreak Filters Processing	<p>This section notes that messages that contain attachments are to bypass the Outbreak Filters feature. If messages are to be processed by Outbreak Filters for the recipient, the message is processed and the evaluation. If the email gateway is configured to quarantine, bounce, or drop the messages based on the verdict, that information is printed and the processing stops.</p> <p>See <a href="#">Outbreak Filters, on page 421</a>.</p>
Footer Stamping	<p>This section notes whether a footer text resource was appended to the message. The name of the text resource is displayed. See <a href="#">Message Disclaimer Stamping, on page 640</a> in <a href="#">Text Resources, on page 639</a>.</p>
<p><b>Delivery Operations</b></p> <p>The following sections note operations that occur when a message is delivered. The trace command prints “Message Enqueued for Delivery ” before this section.</p>	
Global Unsubscribe per Domain and per User	<p>If any recipients you specified as input for the trace command match recipients, recipient domains, or IP addresses listed in the in the Global Unsubscribe feature, any unsubscribed recipient addresses are printed in this section.</p> <p>See <a href="#">Configuring Routing and Delivery Features, on page 693</a>.</p>
Sender Domain Reputation	<p>Displays the processing results of messages that are blocked by the reputation verdict of the sender domain.</p> <p>The following is a sample example of the processing results:</p> <ul style="list-style-type: none"> <li>• Reputation: Neutral</li> <li>• Domain Age: 33 years 9 months 6 days</li> <li>• Category: N/A</li> <li>• Action: Message Dropped</li> </ul>
<p><b>Final Result</b></p> <p>When all processing has been printed, you are prompted with the final result. In the CLI, Answer y to the question, “Would you like to see the resulting message?” to view the resulting message.</p>	

## Using the Listener to Test the Email Gateway

“Sinkhole” listeners allow you to test your message generation systems and to also get a rough measure of receiving performance. Two types of sinkhole listeners are *queueing* and *non-queueing*.

- The queueing listener saves the message to the queue, but then immediately deletes it. Use a queueing listener when you are interested in measuring the performance of the entire injection portion of your message generation system.

## Example

- The non-queueing listener accepts a message, and then immediately deletes it without saving it. Use the non-queueing listener when you want to troubleshoot the connection from your message generation system to the email gateway.

For example, in the following figure, you could create a sinkhole listener “C” to mirror the private listener labeled “B.” A non-queueing version tests the performance path of the system from the groupware client to the groupware server to the email gateway. A queueing version tests that same path *and* the email gateway's ability to enqueue messages and prepare them for delivery via SMTP.

**Figure 87: Sinkhole Listener for an Enterprise Gateway**

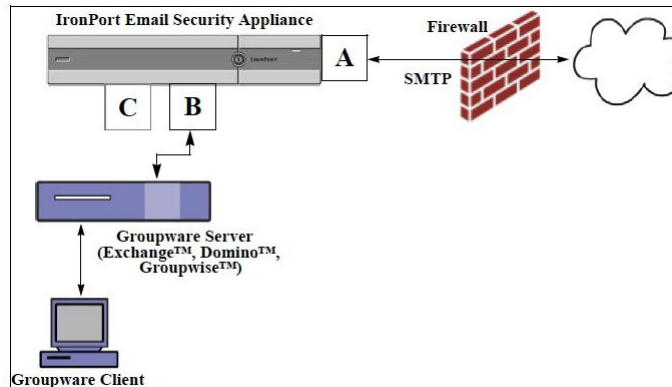

In the following example, the `listenerconfig` command is used to create a sinkhole queueing listener named `Sinkhole_1` on the Management interface. This Host Access Table (HAT) for the listener is then edited to accept connections from the following hosts:

- `yoursystem.example.com`
- `10.1.2.29`
- `badmail.tst`
- `.tst`



**Note** The final entry, `.tst`, configures the listener so that any host in the `.tst` domain can send email to the listener named `Sinkhole_1`.

## Example

```
mail3.example.com> listenerconfig

Currently configured listeners:

1. InboundMail (on PublicNet, 192.168.2.1) SMTP Port 25 Public
2. OutboundMail (on PrivateNet, 192.168.1.1) SMTP Port 25 Private

Choose the operation you want to perform:

- NEW - Create a new listener.
- EDIT - Modify a listener.
- DELETE - Remove a listener.
```

```
- SETUP - Change global settings.

[ ]> new

Please select the type of listener you want to create.

1. Private
2. Public
3. Sinkhole

[2]> 3

Do you want messages to be queued onto disk? [N]> y

Please create a name for this listener (Ex: "OutboundMail"):

[ ]> Sinkhole_1

Please choose an IP interface for this Listener.

1. Management (192.168.42.42/24: mail3.example.com)
2. PrivateNet (192.168.1.1/24: mail3.example.com)
3. PublicNet (192.168.2.1/24: mail3.example.com)

[1]> 1

Choose a protocol.

1. SMTP
2. QMQP

[1]> 1

Please enter the IP port for this listener.

[25]> 25

Please specify the systems allowed to relay email through the IronPort C60.
Hostnames such as "example.com" are allowed.
Partial hostnames such as ".example.com" are allowed.
IP addresses, IP address ranges, and partial IP addressed are allowed.
Separate multiple entries with commas.

[ ]> yoursystem.example.com, 10.1.2.29, badmail.tst, .tst

Do you want to enable rate limiting per host? (Rate limiting defines
the maximum number of recipients per hour you are willing to receive from a remote
domain.) [N]> n

Default Policy Parameters

=====
```

## Example

```

Maximum Message Size: 100M

Maximum Number Of Connections From A Single IP: 600

Maximum Number Of Messages Per Connection: 10,000

Maximum Number Of Recipients Per Message: 100,000

Maximum Number Of Recipients Per Hour: Disabled

Use SenderBase for Flow Control: No

Spam Detection Enabled: No

Virus Detection Enabled: Yes

Allow TLS Connections: No

Allow SMTP Authentication: No

Require TLS To Offer SMTP authentication: No

Would you like to change the default host access policy? [N]> n

Listener Sinkhole_1 created.

Defaults have been set for a Sinkhole Queuing listener.

Use the listenerconfig->EDIT command to customize the listener.

Currently configured listeners:

1. Sinkhole_1 (on Management, 192.168.42.42) SMTP Port 25 Sinkhole Queuing
2. InboundMail (on PublicNet, 192.1681.1) SMTP Port 25 Public
3. OutboundMail (on PrivateNet, 192.168.1.1) SMTP Port 25 Private

Choose the operation you want to perform:

- NEW - Create a new listener.
- EDIT - Modify a listener.
- DELETE - Remove a listener.
- SETUP - Change global settings.

[ ]>

```



---

**Note** Remember to issue the commit command for these changes to take effect.

---

After you have configured a sinkhole queuing listener and modified the HAT to accept connections from your injection system, use your injection system to begin sending email to the email gateway. Use the `status`, `status detail`, and `rate` commands to monitor system performance. You can also monitor the system via the Graphical User Interface (GUI). For more information, see:

- [Monitoring Using the CLI, on page 1101](#)
- [Other Tasks in the GUI, on page 1129](#)



# Troubleshooting the Network

If you suspect that the email gateway has network connectivity issues, first confirm that the email gateway is working properly.

## Testing the Network Connectivity of the Email Gateway

### Procedure

---

- Step 1** Connect to the system and log in as the administrator. After successfully logging in, the following messages are displayed:

```
Last login: day month date hh:mm:ss from IP address
```

```
Copyright (c) 2001-2003, IronPort Systems, Inc.
```

```
AsyncOS x.x for Cisco
```

```
Welcome to the Cisco Messaging Gateway Appliance(tm)
```

- Step 2** Use the `status` or `status detail` commands.

```
mail3.example.com> status
```

or

```
mail3.example.com> status detail
```

The `status` command returns a subset of the monitored information about email operations. The statistics returned are grouped into two categories: counters and gauges. For complete monitoring information about email operations including rates, use the `status detail` command. Counters provide a running total of various events in the system. For each counter, you can view the total number of events that have occurred since the counter was reset, since the last system reboot, and over the system's lifetime. (For more information, see [Monitoring Using the CLI, on page 1101](#).)

- Step 3** Use the `mailconfig` command to send mail to a known working address.

The `mailconfig` command generates a human-readable file including all configuration settings available to the email gateway. Attempt to send the file from the email gateway to a known working email address to confirm that the email gateway is able to send email over the network.

```
mail3.example.com> mailconfig
```

```
Please enter the email address to which you want to send the configuration file.
```

```
Separate multiple addresses with commas.
```

```
[ ]> user@example.com
```

```
Do you want to include passphrases? Please be aware that a configuration without
passphrases will fail when reloaded with loadconfig. [N]> y
```

```
The configuration file has been sent to user@example.com.
```

```
mail3.example.com>
```

## Troubleshooting

After you have confirmed that the email gateway is active on the network, use the following commands to pinpoint any network problems.

- You can use the `netstat` command to display network connections (both incoming and outgoing), routing tables, and a number of network interface statistics, including the following information:
  - List of active sockets
  - State of network interfaces
  - Contents of routing tables
  - Size of the listen queues
  - Packet traffic information
- You can use the `diagnostic -> network -> flush` command to flush all network related caches.
- You can use the `diagnostic -> network -> arpshow` command to show the system ARP cache.
- You can use the `packetcapture` command to intercept and display TCP/IP and other packets being transmitted or received over a network to which the computer is attached.

To use `packetcapture`, set the network interface and the filter. The filter uses the same format the UNIX `tcpdump` command. Use `start` to begin the packet capture and `stop` to end it. After stopping the capture, you need to use SCP or FTP to download the files from the `/pub/captures` directory. For more information, see [Running a Packet Capture, on page 1279](#).

- Use the `ping` command to a known working host to confirm that the email gateway has an active connection on the network and is able to reach specific segments of your network.

The `ping` command allows you to test connectivity to a network host from the email gateway.

```
mail3.example.com> ping
```

```
Which interface do you want to send the pings from?
```

1. Auto
2. Management (192.168.42.42/24: mail3.example.com)
3. PrivateNet (192.168.1.1/24: mail3.example.com)
4. PublicNet (192.168.2.1/24: mail3.example.com)

```
[1]> 1
Please enter the host you wish to ping.
[ ]> anotherhost.example.com
Press Ctrl-C to stop.
PING anotherhost.example.com (x.x.x.x): 56 data bytes
64 bytes from 10.19.0.31: icmp_seq=9 ttl=64 time=0.133 ms
64 bytes from 10.19.0.31: icmp_seq=10 ttl=64 time=0.115 ms
^C
--- anotherhost.example.com ping statistics ---
11 packets transmitted, 11 packets received, 0% packet loss
round-trip min/avg/max/stddev = 0.115/0.242/1.421/0.373 ms
```



---

**Note** You must use Control-C to end the ping command.

---

- Use the `traceroute` command to test connectivity to a network host from the email gateway and debug routing issues with network hops.

```
mail3.example.com> traceroute
Which interface do you want to trace from?
1. Auto
2. Management (192.168.42.42/24: mail3.example.com)
3. PrivateNet (192.168.1.1/24: mail3.example.com)
4. PublicNet (192.168.2.1/24: mail3.example.com)
[1]> 1
Please enter the host to which you want to trace the route.
[ ]> 10.1.1.1
Press Ctrl-C to stop.
traceroute to 10.1.1.1 (10.1.1.1), 64 hops max, 44 byte packets
 1 gateway (192.168.0.1) 0.202 ms 0.173 ms 0.161 ms
 2 hostname (10.1.1.1) 0.298 ms 0.302 ms 0.291 ms
mail3.example.com>
```

- Use the `diagnostic -> network -> smtping` command to test a remote SMTP server.
- Use the `nslookup` command to check the DNS functionality.

The `nslookup` command can confirm that the email gateway is able to reach and resolve hostnames and IP addresses from a working DNS (domain name service) server.

```
mail3.example.com> nslookup

Please enter the host or IP to resolve.

[]> example.com

Choose the query type:

1. A
2. CNAME
3. MX
4. NS
5. PTR
6. SOA
7. TXT

[1]>

A=192.0.34.166 TTL=2d
```

**Table 160: Checking DNS Functionality: Query Types**

A	the host's Internet address
CNAME	the canonical name for an alias
MX	the mail exchanger
NS	the name server for the named zone
PTR	the hostname if the query is an Internet address, otherwise the pointer to other information
SOA	the domain's "start-of-authority" information
TXT	the text information

- Use the `tophosts` command via the CLI or the GUI, and sort by Active Recipients.

The `tophosts` command returns a list of the top 20 recipient hosts in queue. This command can help you determine if network connectivity problems are isolated to a single host or group of hosts to which you are attempting to send email. (For more information, see "Determining the Make-up of the Mail Queue".)

```
mail3.example.com> tophosts

Sort results by:

1. Active Recipients
2. Connections Out
```

```

3. Delivered Recipients
4. Soft Bounced Events
5. Hard Bounced Recipients

[1]> 1

Status as of: Mon Nov 18 22:22:23 2003

ActiveConn.Deliv.SoftHard

# Recipient HostRecipOutRecip.BouncedBounced
1 aol.com36510255218
2 hotmail.com29071982813
3 yahoo.com13461231119
4 excite.com9838494
5 msn.com8427633 29

^C

```

- “Drill-down” to use the `hoststatus` command on the top domains listed from the `tophosts` command results.

The `hoststatus` command returns monitoring information about email operations relating to a specific recipient host. DNS information stored in the AsyncOS cache and the last error returned from the recipient host are also given. Data returned is cumulative since the last `resetcounters` command. (For more information, see [Monitoring the Status of a Mail Host, on page 1104.](#))

Using the `hoststatus` command on the top domains can isolate the performance issues with DNS resolution to the either the email gateway or the internet. For example, if the `hoststatus` command for the top active recipient host shows many pending outbound connections, then try to determine if that particular host is down or unreachable, or if the email gateway cannot connect to all or the majority of hosts.

- Check firewall permissions.

The email gateway may need all of the following ports to be opened in order to function properly: ports 20, 21, 22, 23, 25, 53, 80, 123, 443, and 628. (See [Firewall Information, on page 1331.](#))

- Send email from the email gateway on your network to `dnscheck@ironport.com`

Send an email from within your network to `dnscheck@ironport.com` to perform basic DNS checks on your system. An auto-responder email will respond with the results and details of the following four tests:

**DNS PTR Record** - Does the IP address of the Envelope From match the PTR record for the domain?

**DNS A Record** - Does the PTR record for the domain match the IP address of the Envelope From?

**HELO match** - Does the domain listed in the `SMTP HELO` command match the DNS hostname in the Envelope From?

**Mail server accepting delayed bounce messages** - Does the domain listed in the `SMTP HELO` command have MX records that resolve IP addresses for that domain?

## Troubleshooting the Listener

If you suspect problems with injecting email, use the following strategies:

- Confirm the IP address that you are injecting from, and then use the `listenerconfig` command to check for allowed hosts.

Is the IP address allowed to connect to the listener you have created? Use the `listenerconfig` command to examine the Host Access Table (HAT) for the listener. Use these commands to print the HAT for a listener:

```
listenerconfig -> edit -> listener_number -> hostaccess -> print
```

The HAT can be configured to refuse connections by IP address, block of IP addresses, hostname, or domains. For more information, see “Specifying Hosts that are Allowed to Connect”.

You can also use the `limits` subcommand to check the maximum number of connections allowed for a listener:

```
listenerconfig -> edit -> listener_number -> limits
```

- On the machine that you are injecting from, use Telnet or FTP to manually connect to the email gateway. For example:

```
injection_machine% telnet appliance_name
```

You can also use the `telnet` command within the email gateway itself to connect from the listener to the actual email gateway:

```
mail3.example.com> telnet
```

```
Please select which interface you want to telnet from.
```

1. Auto
2. Management (192.168.42.42/24: mail3.example.com)
3. PrivateNet (192.168.1.1/24: mail3.example.com)
4. PublicNet (192.168.2.1/24: mail3.example.com)

```
[1]> 3
```

```
Enter the remote hostname or IP.
```

```
[ ]> 193.168.1.1
```

```
Enter the remote port.
```

```
[25]> 25
```

```
Trying 193.168.1.1...
```

```
Connected to 193.168.1.1.
```

```
Escape character is '^']'.
```

If you cannot connect from one interface to another, you may have issues with the way in which the email gateway's Management and Data1 and Data2 interfaces are connected to your network. See [FTP, SSH, and SCP Access, on page 1303](#) for more information. You can telnet to port 25 of the listener and enter SMTP commands manually (if you are familiar with the protocol).

- Examine the IronPort text mail logs and injection debug logs to check for receiving errors.

Injection debug logs record the SMTP conversation between the email gateway and a specified host connecting to the system. Injection debug logs are useful for troubleshooting communication problems between the email gateway and a client initiating a connection from the Internet. The log records all bytes transmitted between the two systems and classifies them as “Sent to” the connecting host or “Received from” the connecting host.

For more information, see [Using Text Mail Logs, on page 1158](#) and [Using Injection Debug Logs, on page 1179](#).

## Troubleshooting Email Delivery From the Appliance

If you suspect problems with delivering email from the email gateway, try the following strategies:

- Determine if the problem is domain-specific.

Use the `tophosts` command to get immediate information about the email queue and determine if a particular recipient domain has delivery problems.

Are there problem domains returned when you sort by “Active Recipients?”

When you sort by Connections Out, does any one domain reach the maximum connections specified for a listener? The default maximum number of connections for a listener is 600. The default maximum system-wide number of connections is 10,000 (set by the `deliveryconfig` command). You can examine the maximum number of connections for a listener using the command:

```
listenerconfig -> edit -> listener_number -> limits
```

Are the connections for a listener further limited by the `destconfig` command (either by system maximum or by Virtual Gateway addresses)? Use this command to examine the `destconfig` connection limits:

```
destconfig -> list
```

- Use the `hoststatus` command.

“Drill-down” using the `hoststatus` command on the top domains listed from the results listed by the `tophosts` command.

Is the host available and accepting connections?

Are there problems with one specific MX record mail server for the given host?

The `hoststatus` command reports the last “5XX” status code and description returned by the host if there is a 5XX error (Permanent Negative Completion reply) for the specified host. If the last outgoing TLS connection to the host failed, the `hoststatus` command displays the reason why it failed.

- Configure and/or examine the domain debug, bounce, and text mail logs to check if the recipient host is available.

**Domain debug logs** record the client and server communication during an SMTP conversation between the email gateway and a specified recipient host. This log file type can be used to debug issues with specific recipient hosts.

For more information, see [Using Domain Debug Logs, on page 1178](#).

Bounce logs record all information pertaining to each bounced recipient.

For more information, see [Using Bounce Logs, on page 1174](#).

**Text mail** logs contain details of email receiving, email delivery and bounces. These logs are a useful source of information to understand delivery of specific messages and to analyze system performance.

For more information, see [Using Text Mail Logs, on page 1158](#).

- Use the `telnet` command to connect from the email gateway to the problem domain:

```
mail3.example.com> telnet

Please select which interface you want to telnet from.

1. Auto
2. Management (192.168.42.42/24: mail3.example.com)
3. PrivateNet (192.168.1.1/24: mail3.example.com)
4. PublicNet (192.168.2.1/24: mail3.example.com)

[1]> 1

Enter the remote hostname or IP.

[]> problemdomain.net

Enter the remote port.

[25]> 25
```

- You can use the `tlsverify` command to establish an outbound TLS connection on demand and debug any TLS connection issues concerning a destination domain. To create the connection, specify the domain to verify against and the destination host. AsyncOS checks the TLS connection based on the Required (Verify) TLS setting.

```
mail3.example.com> tlsverify

Enter the TLS domain to verify against:

[]> example.com

Enter the destination host to connect to. Append the port (example.com:26) if you are
not connecting on port 25:

[example.com]> mx.example.com:25

Connecting to 1.1.1.1 on port 25.

Connected to 1.1.1.1 from interface 10.10.10.10.
```



```
Checking TLS connection.
TLS connection established: protocol TLSv1, cipher RC4-SHA.
Verifying peer certificate.
Verifying certificate common name mx.example.com.
TLS certificate match mx.example.com
TLS certificate verified.
TLS connection to 1.1.1.1 succeeded.
TLS successfully connected to mx.example.com.
TLS verification completed.
```

## Troubleshooting Performance

If you suspect that there are performance problems with the email gateway, utilize the following strategies:

- Use the `rate` and `hostrate` commands to check the current system activity.

The `rate` command returns real-time monitoring information about email operations. For more information, see [Displaying Real-time Activity, on page 1107](#).

The `hostrate` command returns real-time monitoring information for a specific host.

- Use the `status` command to cross-check the historical rates to check for degradation.
- Use the `status detail` command to check the RAM utilization.

You can use the `status detail` command to quickly see the system's RAM, CPU, and Disk I/O utilization.



---

**Note** RAM utilization should always be less than 45%. If RAM utilization exceeds 45%, then, the email gateway will enter “resource conservation mode;” it initiates a “back-off” algorithm to prevent over-subscription of resources and sends out the following email alert:

---

```
This system (hostname: hostname) has entered a 'resource conservation' mode in order
to
prevent the rapid depletion of critical system resources.
```

```
RAM utilization for this system has exceeded the resource conservation threshold of
45%.
The allowed injection rate for this system will be gradually decreased as RAM
utilization approaches 60%.
```

This situation occurs only with an aggressive injection with poor deliverability facilities. If you encounter RAM utilization exceeding 45%, check the number of messages in the queue and see if a particular domain is down or unavailable for delivery (via the `hoststatus` or `hostrate` commands). Also check

the status of the system and ensure that delivery is not suspended. If after stopping the injection you continue to experience a high RAM utilization, contact Cisco Customer Support.

- Is the problem specific to one domain?

Use the `tophosts` command to get immediate information about the email queue and determine if a particular recipient domain has delivery problems.

Check the size of the queue. You can delete, bounce, suspend, or redirect messages in the email queue to manage its size, or to deal with recipients to a specific, problematic domain. For more information, see [Managing the Email Queue, on page 1111](#). Use these commands:

- `deleterecipients`
- `bouncerecipients`
- `redirectrecipients`
- `suspenddel / resumedel`
- `suspendlistener / resumelister`

Use the `tophosts` command to check the number of soft and hard bounces. Sort by “Soft Bounced Events” (option 4) or “Hard Bounced Recipients” (option 5). If the performance for a particular domain is problematic, use the commands above to manage the delivery to that domain.

## Web Interface Appearance and Rendering Issues

See [Overriding Internet Explorer Compatibility Mode, on page 1090](#).

## Responding to Alerts

- [Troubleshooting Alerts That Miscellaneous Disk Usage is Approaching the Quota , on page 1274](#)

## Troubleshooting Alerts That Miscellaneous Disk Usage is Approaching the Quota

### Problem

You receive an alert that Miscellaneous disk usage is approaching its quota.

### Solution

You can either increase the quota or delete files. See [Managing Disk Space for the Miscellaneous Quota , on page 1027](#).

## Troubleshooting Hardware Issues

Lights on the front and/or rear panels of your hardware email gateway indicate health and status of your email gateway. For descriptions of these indicators, see the hardware guides , such as the *Cisco x90s Series Content Security Appliances Installation and Maintenance Guide*, available from <http://www.cisco.com/c/en/us/support/security/email-security-appliance/products-installation-guides-list.html>.

Specifications for your email gateway, such as temperature ranges, are also available in these documents.

## Remotely Resetting Email Gateway Power

If the email gateway requires a hard reset, you can reboot the email gateway chassis remotely using a third-party Intelligent Platform Management Interface (IPMI) tool.

### Restrictions

- Remote power cycling is available only on certain hardware.  
For specifics, see [Enabling Remote Power Cycling , on page 1042](#).
- If you want be able to use this feature, you must enable it in advance, before you need to use it.  
For details, see [Enabling Remote Power Cycling , on page 1042](#).
- Only the following IPMI commands are supported:
  - `status`, `on`, `off`, `cycle`, `reset`, `diag`, `soft`
  - Issuing unsupported commands will produce an “insufficient privileges” error.

### Before You Begin

- Obtain and set up a utility that can manage devices using IPMI version 2.0.
- Understand how to use the supported IPMI commands. See the documentation for your IPMI tool.

### Procedure

---

**Step 1** Use IPMI to issue a supported power-cycling command to the IP address assigned to the Remote Power Cycle port, which you configured earlier, along with the required credentials.

For example, from a UNIX-type machine with IPMI support, you might issue the command:

```
ipmitool -I lan -H 192.0.2.1 -U remoteresetuser -P password chassis power reset
```

where `192.0.2.1` is the IP address assigned to the Remote Power Cycle port and `remoteresetuser` and `password` are the credentials that you entered while enabling this feature.

**Step 2** Wait at least eleven minutes for the email gateway to reboot.

---

## Working with Technical Support

- [Technical Support for Virtual Email Gateway, on page 1276](#)
- [Opening or Updating a Support Case From the Email Gateway , on page 1276](#)
- [Enabling Remote Access for Cisco Technical Support Personnel , on page 1277](#)
- [Running a Packet Capture, on page 1279](#)

## Technical Support for Virtual Email Gateway

Requirements for getting technical support for your virtual email gateway are described in the Cisco Content Security Virtual Appliance Installation Guide available from <http://www.cisco.com/c/en/us/support/security/email-security-appliance/products-installation-guides-list.html>.

## Opening or Updating a Support Case From the Email Gateway

### Before You Begin

- If your issue is urgent, do not use this method. Instead, contact support using one of the other methods listed in [Cisco Customer Support, on page 6](#).  
Use the following procedure only for issues such as a request for information or a problem for which you have a workaround, but would like an alternate solution.
- Consider other options for getting help:
  - [Knowledge Base, on page 5](#)
  - [Cisco Support Community, on page 6](#)
- To access Cisco technical support directly from the email gateway, your Cisco.com user ID must be associated with your service agreement contract for this email gateway. To view a list of service contracts that are currently associated with your Cisco.com profile, visit the Cisco.com Profile Manager at [https://rpfa.cloudapps.cisco.com/rpfa/profile/profile\\_management.do](https://rpfa.cloudapps.cisco.com/rpfa/profile/profile_management.do). If you do not have a Cisco.com user ID, register to get one. See [Registering for a Cisco Account , on page 7](#).  
Be sure to save your Cisco.com user ID and support contract ID in a safe location.
- When you open a support case using this procedure, the email gateway configuration file is sent to Cisco Customer Support. If you do not want to send the email gateway configuration, you can contact Customer Support using a different method.
- In cluster configurations, support requests and their saved values are machine-specific.
- The email gateway must be connected to the internet and able to send email.
- If you are sending information about an existing case, make sure you have the case number.

### Procedure

---

- Step 1** Sign in to the email gateway.
- Step 2** Choose **Help and Support > Contact Technical Support**.
- Step 3** Complete the form.
- Step 4** Click **Send**.

**Note** CCO User IDs and the last-entered Contract ID are saved on the email gateway for future use.

---

## Enabling Remote Access for Cisco Technical Support Personnel

Only Cisco Customer Assistance can access your email gateway using these methods.

- [Enabling Remote Access to Email Gateways With an Internet Connection](#) , on page 1277
- [Enabling Remote Access to Email Gateways Without a Direct Internet Connection](#) , on page 1277
- [Disabling Remote Access](#) , on page 1278
- [Disabling a Tech Support Tunnel](#) , on page 1278
- [Checking the Status of the Support Connection](#) , on page 1279

### Enabling Remote Access to Email Gateways With an Internet Connection

Support accesses the email gateway through an SSH tunnel that this procedure creates between the email gateway and the `upgrades.ironport.com` or server.

#### Before You Begin

Identify a port that can be reached from the internet. The default is port 25, which will work in most environments because the system also requires general access over that port in order to send email messages. Connections over this port are allowed in most firewall configurations.

#### Procedure

- 
- Step 1** Log in to the email gateway.
- Step 2** From the top right side of the GUI window, choose **Help and Support > Remote Access**.
- Step 3** Click **Enable**.
- Step 4** Enter the following information:

Option	Description
Seed String	The seed string is used to generate a secure shared secret to be used by Cisco Customer Support to access this email gateway.
Secure Tunnel	Select the check box to use a secure tunnel for the remote access connection. Enter a port for the connection. The default is port 25 , which will work in most environments.

- Step 5** Click **Submit**.
- 

#### What to do next

When remote access for support personnel is no longer required, see [Disabling a Tech Support Tunnel](#) , on page 1278.

### Enabling Remote Access to Email Gateways Without a Direct Internet Connection

For appliances without a direct internet connection, access is made through a second email gateway that is connected to the internet.

**Before You Begin**

- The email gateway must be able to connect on port 22 to a second email gateway that is connected to the internet.
- On the email gateway with the internet connection, follow the procedure in [Enabling Remote Access to Email Gateways With an Internet Connection](#), on page 1277 to create a support tunnel to that email gateway.

**Procedure**

- 
- Step 1** From the command-line interface of the email gateway requiring support, enter the **techsupport** command.
- Step 2** Enter **sshaccess**.
- Step 3** Follow the prompts.
- 

**What to do next**

When remote access for support personnel is no longer required, see the following:

- [Disabling Remote Access](#), on page 1278
- [Disabling a Tech Support Tunnel](#), on page 1278

**Disabling a Tech Support Tunnel**

An enabled techsupport tunnel remains connected to upgrades.ironport.com for 7 days. After that time, established connections will not be disconnected but will be unable to re-attach to the tunnel once disconnected.

To disable the tunnel manually:

**Procedure**

- 
- Step 1** Log in to the email gateway.
- Step 2** From the top right side of the GUI window, choose **Help and Support > Remote Access**.
- Step 3** Click **Disable**.
- 

**Disabling Remote Access**

A remote access account that you create using the techsupport command remains active until you deactivate it.

**Procedure**

- 
- Step 1** From the command-line interface, enter the techsupport command.
- Step 2** Enter sshaccess .
- Step 3** Enter disable .
-

## Checking the Status of the Support Connection

### Procedure

---

- Step 1** From the command-line interface, enter the techsupport command.
- Step 2** Enter status .
- 

## Running a Packet Capture

Packet Capture allows support personnel to see the TCP/IP data and other packets going into and out of the email gateway. This allows Support to debug the network setup and to discover what network traffic is reaching the email gateway or leaving the email gateway.

### Procedure

---

- Step 1** Choose **Help and Support > Packet Capture**.
- Step 2** Specify packet capture settings:
- In the **Packet Capture Settings** section, click **Edit Settings**.
  - (Optional) Enter duration, limits, and filters for the packet capture.  
Your Support representative may give you guidance on these settings.  
If you enter a capture duration without specifying a unit of time, AsyncOS uses seconds by default.  
In the **Filters** section:
    - Custom filters can use any syntax supported by the UNIX tcpdump command, such as host 10.10.10.10 && port 80 .
    - The client IP is the IP address of the machine connecting to the email gateway, such as a mail client sending messages through the email gateway.
    - The server IP is the IP address of the machine to which the email gateway is connecting, such as an Exchange server to which the email gateway is delivering messages.
    - You can use the client and server IP addresses to track traffic between a specific client and a specific server, with the email gateway in the middle.
  - Click **Submit**.
- Step 3** Click **Start Capture**.
- Only one capture may be running at a time.
  - When a packet capture is running, the Packet Capture page shows the status of the capture in progress by showing the current statistics, such as file size and time elapsed.
  - The GUI only displays packet captures started in the GUI, not from the CLI. Similarly, the CLI only displays the status of a current packet capture run started in the CLI.

- The packet capture file is split into ten parts. If the file reaches the maximum size limit before the packet capture ends, the oldest part of the file is deleted (the data is discarded) and a new part starts with the current packet capture data. Only 1/10 of the packet capture file is discarded at a time.
- A running capture started in the GUI is preserved between sessions. (A running capture started in the CLI stops when the session ends.)

**Step 4** Allow the capture to run for the specified duration, or, if you have let the capture run indefinitely, manually stop the capture by clicking **Stop Capture**.

**Step 5** Access the packet capture file:

- Click the file in the **Manage Packet Capture Files** list and click **Download File**.
- Use FTP or SCP to access the file in the captures subdirectory on the email gateway.

---

### What to do next

Make the file available to Support:

- If you allow remote access to your email gateway, technicians can access the packet capture files using FTP or SCP. See [Enabling Remote Access for Cisco Technical Support Personnel](#), on page 1277.
- Email the file to Support.





## CHAPTER 47

# Optimizing the Email Gateway for Outbound Mail Delivery Using D-Mode

---

This chapter contains the following sections:

- [Feature Summary: D-Mode for Optimized Outbound Delivery](#) , on page 1281
- [Setting Up the Email Gateway for Optimized Outbound Mail Delivery](#) , on page 1283
- [Sending Bulk Mail Using IronPort Mail Merge \(IPMM\)](#), on page 1284

## Feature Summary: D-Mode for Optimized Outbound Delivery

D-Mode is a feature key-enabled feature that optimizes certain email gateways for outbound email delivery. Features specific to inbound mail handling are disabled in D-Mode.

- [Features Unique to D-Mode-Enabled Email Gateways](#) , on page 1281
- [Standard Features Disabled in D-Mode-Enabled Email Gateways](#) , on page 1282
- [Standard Features Applicable to D-Mode-Enabled Email Gateways](#) , on page 1282

## Features Unique to D-Mode-Enabled Email Gateways

- 256 Virtual Gateway Addresses - The Cisco Virtual Gateway technology allows you to configure enterprise mail gateways for all domains you host — with distinct IP addresses, hostname and domains — and create separate corporate email policy enforcement and anti-spam strategies for those domains, while hosted within the same physical email gateway. See information about “Customizing Listeners” in [Configuring the Gateway to Receive Email](#), on page 65
- IronPort Mail Merge (IPMM) - IronPort Mail Merge (IPMM) removes the burden of generating individual personalized messages from customer systems. By removing the need to generate thousands of individual messages and transmit them between message generating systems and the email gateway, users benefit from the decreased load on their systems and increased throughput of email delivery. For more information, see [Sending Bulk Mail Using IronPort Mail Merge \(IPMM\)](#), on page 1284.
- Resource-conserving bounce setting - You can configure D-Mode-enabled email gateways to detect potential blocked destinations and bounce all messages bound for that destination. For more information, see [Configuring Resource-Conserving Bounce Settings](#), on page 1283.
- Enhanced performance for outbound delivery

## Standard Features Disabled in D-Mode-Enabled Email Gateways

- IronPort anti-spam scanning and on or off box spam quarantining — Because anti-spam scanning pertains mostly to incoming mail, the IronPort Anti-Spam scanning engine is disabled. The Anti-Spam chapter is, therefore, not applicable.
- Outbreak Filters — Because the Outbreak Filters feature is used to quarantine incoming mail, this feature is disabled on D-Mode-enabled email gateways. Information in the Outbreak Filters chapter is, therefore, not applicable.
- Service Logs - The Service Logs feature is disabled on D-mode enabled email gateways.
- Reporting — Reporting is limited. Some reports are not available, and the reporting that does occur is set to run at a very limited level for performance reasons.



**Note** The totals shown in the Email Security Monitor Overview report for D-Mode-enabled email gateways may erroneously include spam and suspect spam counts, even though these features are disabled on D-Mode-enabled email gateways.

- Data Loss Prevention — DLP scanning for outgoing messages is disabled on D-Mode-enabled email gateways.

## Standard Features Applicable to D-Mode-Enabled Email Gateways

*Table 161: AsyncOS Features Included in D-Mode Enabled Email Gateways*

Feature	More Information
Anti-virus scanning	See <a href="#">Anti-Virus</a> , on page 361
Domain Key signing	DKIM/Domain Keys is a method for verifying authenticity of email based on a signing key used by the sender. See <a href="#">Email Authentication</a> , on page 597
Centralized management	See <a href="#">Centralized Management Using Clusters</a> , on page 1225
Delivery throttling	For each domain, you can assign a maximum number of connections and recipients that will never be exceeded by the system in a given time period. This “good neighbor” table is defined through the destconfig command.  For more information, see <a href="#">Controlling Email Delivery Using Destination Controls</a> , on page 730.
Bounce Verification	Verify the authenticity of bounce messages. See <a href="#">Bounce Verification</a> , on page 731.
Delegated administration	See <a href="#">Distributing Administrative Tasks</a> , on page 973
Trace (debug)	See <a href="#">Debugging Mail Flow Using Test Messages: Trace</a> , on page 1255.
VLAN, NIC-pairing	See <a href="#">Advanced Network Configuration</a> , on page 1131
Optional Anti-virus engine	You can add optional anti-virus scanning to ensure the integrity of your outbound messages. See <a href="#">Anti-Virus Scanning Overview</a> , on page 361.

# Setting Up the Email Gateway for Optimized Outbound Mail Delivery

## Procedure

---

- Step 1** Apply the provided feature key. You will need to apply the key to your email gateway *prior to running the system setup wizard* (prior to configuring the email gateway). Apply the key via the System Administration > Feature Key page or by issuing the featurekey command in the CLI.
- Note** The preceding feature keys include a sample 30 day Sophos or McAfee Anti-Virus license you can use to test anti-virus scanning on outbound mail.
- Step 2** Reboot the email gateway.
- Step 3** Run the system setup wizard (GUI or CLI) and configure your email gateway.
- Keep in mind that email gateways that are optimized for outbound delivery do not include anti-spam scanning or the Outbreak Filters feature. (Please ignore these chapters.)
- Note** In a clustered environment, you cannot combine email gateways that are configured with the D-Mode feature key with AsyncOS email gateways that are not configured with the delivery performance package.
- 

## Configuring Resource-Conserving Bounce Settings

Once the email gateway is configured for optimized outbound mail delivery, you can configure the system to detect potential delivery problems and bounce all messages for a destination.



- Note** Using this setting will bounce all messages in the queue for a destination domain that is deemed undeliverable. You will need to re-send the message once the delivery issues have been resolved.
- 

## Example of Enabling Resource-Conserving Bounce Settings

```
mail3.example.com> bounceconfig

Choose the operation you want to perform:

- NEW - Create a new profile.

- EDIT - Modify a profile.

- DELETE - Remove a profile.

- SETUP - Configure global bounce settings.

[ ]> setup
```

```
Do you want to bounce all enqueued messages bound for a domain if the host is down? [N]>
y
```

When using this feature, a host is considered “down” after at least 10 consecutive connection attempts fail. AsyncOS scans for down hosts every 15 minutes, so it is possible that more than 10 attempts will be made before the queue is cleared.

## Sending Bulk Mail Using IronPort Mail Merge (IPMM)



---

**Note** IronPort Mail Merge is available only on email gateways that are D-Mode-enabled.

---

### Overview of IronPort Mail Merge

IronPort Mail Merge removes the burden of generating individual personalized messages from customer systems. It removes the need to generate thousands of individual messages and transmit them between message generating systems and the email gateway, resulting in decreased load on your systems and increased throughput of email delivery.

With IPMM, a single message body is created with variables representing locations in the message to be replaced for personalization. For each individual message recipient, only the recipient email address and the variable substitutions need to be transmitted to the email gateway. In addition, IPMM can be used to send certain recipients specific “parts” of the message body, while excluding certain parts from others recipients. (For example, suppose you needed to include a different copyright statements at the end of your messages to recipients in two different countries.)

### Benefits of the Mail Merge Function

- Ease of use for the mail administrator. The complexities of creating personalized messages for each recipient are removed, as IPMM provides variable substitution and an abstracted interface in many common languages.
- Reduced load on message generation systems. By requiring one copy of the message body and a table of required substitutions, most of the message generation “work” is off-loaded from message generation systems and moved to the email gateway that is configured for optimized outbound mail delivery.
- Increased delivery throughput. By reducing the resources necessary to accept and queue thousands of incoming messages, the email gateway can significantly increase out-bound delivery performance.
- Queue storage efficiency. By storing less information for each message recipient, users can achieve orders-of- magnitude, better use of queue storage on the D-Mode enabled email gateway.

## Using Mail Merge

### SMTP Injection

IPMM extends SMTP as the transport protocol. There is no special configuration that needs to be made to the email gateway. (By default, IPMM can be enabled for private listeners and disabled for public listeners on the D-Mode-enabled email gateway.) However, if you are not currently using SMTP as your injection protocol, you must create a new private listener that utilizes SMTP through the D-Mode enabled email gateway interface.

Use the `setipmm` subcommand of `listenerconfig` to enable IPMM on the listener. For more information, see [Configuring the Gateway to Receive Email, on page 65](#)

IPMM modifies SMTP by altering two commands — MAIL FROM and DATA — and adding another: XDFN . The MAIL FROM command is replaced with XMRG FROM and, the DATA command is replaced with XPRT .

To generate a Mail Merge message, the commands used to generate the message need to be issued in a particular sequence.

1. The initial EHLO statement, identifying the sending host.
2. Each message starts with an XMRG FROM: statement, indicating the sender address.
3. Each recipient is then defined:
4. One or more XDFN variable allocation statements are made, including defining the parts (XDFN \*PART=1,2,3...), and any other recipient specific variables.
5. The recipient email address is defined with the RCPT TO: statement. Any variable allocations prior to the RCPT TO:, but after the prior XMRG FROM, or RCPT TO command, will be mapped to this recipient email address.
6. Each part is defined using the XPRT n command, with each part terminated by a period (.) character similar to the DATA command. The last part is defined by the XPRT n LAST command.

### Variable Substitution

Any part of the message body, including message headers, can contain variables for substitution. Variables can appear in HTML messages, as well. Variables are user-defined and must begin with the ampersand (&) character and end with the semi-colon character (;). Variable names beginning with an asterisk (\*) are reserved and cannot be used.

### Reserved Variables

IPMM contains five special “reserved” variables that are predefined.

**Table 162: IPMM: Reserved Variables**

*FROM	The reserved variable *FROM is derived from the “Envelope From” parameter. The “Envelope From” parameter is set by the “XMRG FROM:” command.
*TO	The reserved variable *TO is derived from the envelope recipient value, as set by the “RCPT TO:” command.
*PARTS	The reserved variable *PARTS holds a comma separated list of parts. It is set prior to defining a recipient with the “RCPT TO:” and determines which of the “XPRT n” message body blocks a given user will receive.

*DATE	The reserved variable *DATE is replaced with the current date stamp.
*DK	The reserved variable *DK is used to specify a DomainKeys Signing profile (this profile must already exist in AsyncOS). For more information about creating DomainKeys Signing profiles, see <a href="#">Email Authentication, on page 597</a>

## Example Message 1

The following example message body (including headers) contains four distinct variables and five substitution locations that will be replaced in the final message. Note that the same variable may be used more than once in the message body. Also, the reserved variable `&*TO;` is used, which will be replaced with the recipient email address. This reserved variable does not need to be passed in as a separate variable. The variables in the example appear in bold.

```
From: Mr. Spacely <spacely@example.com>

To: &first_name; &last_name; &*TO;

Subject: Thanks for Being an Example.Com Customer

Dear &first_name;,
Thank you for purchasing a &color; sprocket.
```

This message needs only be injected once into the email gateway. For each recipient, the following additional information is required:

- A recipient email address
- Name-value pairs for the variable substitution

## Part Assembly

Where SMTP uses a single DATA command for each message body, IPMM uses one or many XPRT commands to comprise a message. Parts are assembled based upon the order specified per-recipient. Each recipient can receive any or all of the message parts. Parts can be assembled in any order.

The special variable `*PARTS` holds a comma separated list of parts.

For example, the following example message contains two parts.

The first part contains the message headers and some of the message body. The second part contains an offer that can be variably included for specific customers.

## Example Message 2, Part 1

```
From: Mr. Spacely <spacely@example.com>

To: &first_name; &last_name; &*TO;

Subject: Thanks for Being an Example.Com Customer

Dear &first_name;,

Thank you for purchasing a &color; sprocket.
```

## Example Message 2, Part 2

Please accept our offer for 10% off your next sprocket purchase.

The message parts need only be injected once into the email gateway. In this case, each recipient requires the following additional information:

- The ordered list of parts to be included in the final message
- A recipient email address
- Name value pairs for the variable substitution

## IPMM and DomainKeys Signing

IPMM does support DomainKeys Signing. Use the \*DK reserved variable to specify a DomainKeys profile. For example:

```
XDFN first_name="Jane" last_name="User" color="red" *PARTS=1,2 *DK=mass_mailing_1
```

In this example, “mail\_mailing\_1” is the name of a previously configured DomainKeys profile.

## Command Descriptions

When a client injects IPMM messages to the listener, it uses extended SMTP with the following key commands.

### XMRG FROM

Syntax:

```
XMRG FROM: <sender email address>
```

This command replaces the SMTP MAIL FROM: command and indicates that what follows is an IPMM message. An IPMM job is initiated with the XMRG FROM: command.

### XDFN

Syntax:

```
XDFN <KEY=VALUE> [KEY=VALUE]
```

The XDFN command sets the per-recipient metadata. Note that key-value pairs can optionally be enclosed in angle brackets or square brackets.

\*PARTS is a special reserved variable that indicates the index number as defined by the XPRT command (described below). The \*PARTS variable is split as a comma-delimited list of integers. The integers match the body parts to be sent as defined by the XPRT commands. The other reserved variables are: \*FROM, \*TO, and \*DATE.

### XPRT

Syntax:

```
XPRT index_number LAST
```

Message

.

The `XPRT` command replaces the `SMTP DATA` command. The command accepts the transfer of the message part after the command is issued. The command is completed with a single period on a line followed by a return (which is the same way an `SMTP DATA` command is completed).

The special keyword `LAST` indicates the end of the mail merge job and must be used to specify the final part that will be injected.

After the `LAST` keyword is used, the message is queued, and delivery begins.

## Notes on Defining Variables

- When you define variables with the `XDFN` command, note that the actual command line cannot exceed the physical limit of the system. In the case of the D-Mode-enabled email gateway, this limit is 4 kilobytes per line. Other host systems may have lower thresholds. Use caution when defining multiple variables on very large lines.
- You can escape special characters using the forward slash “/” character when defining variables key-value pairs. This is useful if your message body contains HTML character entities that might be mistakenly replaced with variable definitions. (For example, the character entity `&trade;` defines the HTML character entity for a trademark character. If you created the command `XDFN trade=foo` and then created a IPMM message containing the HTML character entity “ `&trade;` ” the assembled message would contain the variable substitution (“ foo ”) instead of the trademark character. The same concept is true for the ampersand character “&” which is sometimes used in URLs containing GET commands.

## Example IPMM Conversation

The following is an example IPMM conversation of Example Message #2 (shown above). The message will be sent to two recipients in this example: “Jane User” and “Joe User.”

In this example, the type in `bold` represents what you would type in a manual SMTP conversation with the D-Mode-enabled email gateway, type in `monospaced type` represents the responses from the SMTP server, and *italic type* represents comments or variables.

A connection is established:

```
220 ESMTP
```

```
EHLO foo
```

```
250 - ehlo responses from the listener enabled for IPMM
```

The conversation is started:

```
XMRG FROM:<user@domain.com> [Note: This replaces the MAIL FROM: SMTP command.]
```

```
250 OK
```

Variables and parts are set for each recipient:

```
XDFN first_name="Jane" last_name="User" color="red" *PARTS=1,2
```

*[Note: This line defines three variables (first\_name, last\_name, and color) and then uses the \*PARTS reserved variable to define that the next recipient defined will receive message parts numbers 1 and 2.]*



250 OK

RCPT TO:<jane@company.com>

250 recipient <jane@company.com> ok

XDFN first\_name="Joe" last\_name="User" color="black" \*PARTS=1

*[Note: This line defines three variables (first\_name, last\_name, and color) and then uses the \*PARTS reserved variable to define that the next recipient defined will receive message parts numbers 1 only.]*

RCPT TO:<joe@company1.com>

250 recipient <joe@company1.com> ok

Next, part 1 is transmitted:

XPRT 1 *[Note: This replaces the DATA SMTP command.]*

354 OK, send part

From: Mr. Spacely <spacely@example.com>

To: &first\_name; &last\_name; &\*TO;

Subject: Thanks for Being an Example.Com Customer

&\*DATE;

Dear &first\_name; ,

Thank you for purchasing a &color; sprocket.

.

And then part 2 is transmitted. Note that the LAST keyword is used to identify Part 2 as the final part to assemble:

XPRT 2 LAST

Please accept our offer for 10% off your next sprocket purchase.

.

250 Ok, mailmerge message enqueued

The “250 Ok, mailmerge message queued” notes that the message has been accepted.

Based on this example, recipient Jane User will receive this message:

From: Mr. Spacely <spacely@example.com>

To: Jane User <jane@company.com>

Subject: Thanks for Being an Example.Com Customer

*message date*

Dear Jane,

Thank you for purchasing a red sprocket.

Please accept our offer for 10% off your next sprocket purchase.

Recipient Joe User will receive this message:

From: Mr. Spacely <spacely@example.com>

To: Joe User <joe@company1.com>

Subject: Thanks for Being an Example.Com Customer

*message date*

Dear Joe,

Thank you for purchasing a black sprocket.

## Example Code

Cisco has created libraries in common programming languages to abstract the task of injecting IPMM messages into the email gateway listener enabled for IPMM. Contact Cisco Customer Support for examples of how to use the IPMM library. The code is commented extensively to explain its syntax.



## CHAPTER 48

# Centralizing Services on a Cisco Secure Email and Web Manager (M-Series)

---

This chapter contains the following sections:

- [Overview of Cisco Secure Email and Web Manager Services](#) , on page 1291
- [Network Planning](#), on page 1292
- [Working with an External Spam Quarantine](#) , on page 1292
- [About Centralizing Policy, Virus, and Outbreak Quarantines](#) , on page 1295
- [Configuring Centralized Reporting](#), on page 1300
- [Configuring Centralized Message Tracking](#), on page 1301
- [Using Centralized Services](#) , on page 1301

## Overview of Cisco Secure Email and Web Manager Services

The Cisco Secure Email and Web Manager (M-Series appliance) is an external or “off box” location that provides a single interface to certain services on multiple email gateways.

The Cisco Secure Email and Web Manager includes the following features:

- External spam quarantine. Holds spam and suspected spam messages for end users, and allow end users and administrators to review messages that are flagged as spam before making a final determination.
- Centralized policy, virus, and outbreak quarantines. Provide a single location behind the firewall to store and manage messages quarantined by anti-virus scanning, outbreak filters, and policies.
- Centralized reporting. Run reports on aggregated data from multiple email gateways.
- Centralized tracking. Track email messages that traverse multiple email gateways.

For complete information about configuring and using your Cisco Secure Email and Web Manager, see the Cisco Secure Email and Web Manager User Guide.



**Caution** If you have enabled two-factor authentication on your email gateway, you can add it to a Cisco Secure Email and Web Manager using pre-shared keys. Use the `smaconfig > add` command in the CLI to configure this setting.

OR

Disable two-factor authentication on your email gateway, before you add it to Cisco Secure Email and Web Manager. For more information, see [Disabling Two-Factor Authentication, on page 993](#).

## Network Planning

The Cisco Secure Email and Web Manager lets you separate the end-user interfaces (such as mail applications) from the more secure gateway systems residing in your various DMZs. Using a two-layer firewall can provide you with flexibility in network planning so that end users do not connect directly to the outer DMZ.

The following figure shows a typical network configuration incorporating Cisco Secure Email and Web Manager and multiple DMZs.

**Figure 88: Typical Network Configuration with Cisco Secure Email and Web Manager**

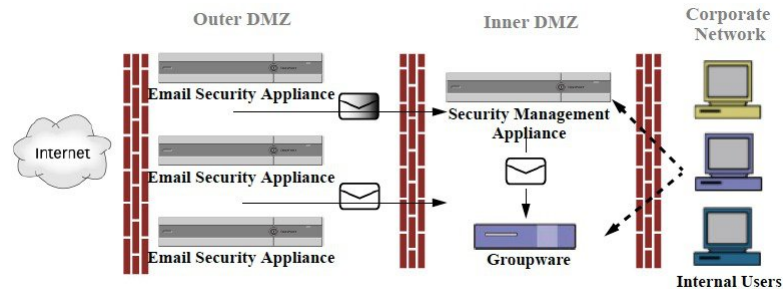

Large corporate data centers can share one Cisco Secure Email and Web Manager which acts as an external spam quarantine for one or more email gateways. Meanwhile, remote offices can maintain local spam quarantines on email gateways for local use.

## Working with an External Spam Quarantine

- [Mail Flow and External Spam Quarantine](#) , on page 1292
- [Migrating from a Local Spam Quarantine to an External Quarantine](#), on page 1293
- [Enabling an External Spam Quarantine and External Safelist/Blocklist](#) , on page 1294
- [Disabling the Local Spam Quarantine to Activate the External Quarantine](#) , on page 1295
- [Troubleshooting an External Spam Quarantine](#) , on page 1295

## Mail Flow and External Spam Quarantine

If your network is configured as described in [Network Planning, on page 1292](#), incoming mail from the Internet is received by appliances in the outer DMZ. Clean mail is sent along to the mail transfer agent (MTA) (groupware) in the inner DMZ and eventually to the end users within the corporate network.

Spam and suspected spam (depending on your mail flow policy settings) is sent to the spam quarantine on Cisco Secure Email and Web Manager. End users may then access the quarantine and elect to delete spam and release messages that they would like to have delivered to themselves. Messages remaining in the spam quarantine are automatically deleted after a configurable amount of time.

Messages that are released from the external quarantine on the Cisco Secure Email and Web Manager are returned to the originating email gateway for delivery. These messages do not normally pass through the following processes before delivery: HAT and other policy or scanning settings, RAT, domain exceptions, aliasing, incoming filters, masquerading, bounce verification, and the work queue.

An email gateway that is configured to send mail to a Cisco Secure Email and Web Manager will automatically expect to receive mail released from the Cisco Secure Email and Web Manager and will not reprocess those messages when they are received back. For this to work, the IP address of the Cisco Secure Email and Web Manager must not change. If the IP address of the Cisco Secure Email and Web Manager changes, the receiving email gateway will process the message as it would any other incoming message. You should always use the same IP address for receiving and delivery on the Cisco Secure Email and Web Manager.

The Cisco Secure Email and Web Manager accepts mail for quarantining from the IP addresses specified in the spam quarantine settings. To configure the spam quarantine on the Security Management appliance, see the Cisco Secure Email and Web Manager User Guide.

Mail released by the Cisco Secure Email and Web Manager is delivered to the primary and secondary hosts (content security appliance or other groupware host) as defined in the spam quarantine settings (see the Cisco Secure Email and Web Manager User Guide). Therefore, regardless of the number of email gateways delivering mail to the Cisco Secure Email and Web Manager, all released mail, notifications, and alerts are sent to a single host (groupware or content security appliance). Take care not to overburden the primary host for delivery from the Cisco Secure Email and Web Manager.

## Migrating from a Local Spam Quarantine to an External Quarantine

If you are currently using the local spam quarantine on an email gateway but would like to migrate to an external spam quarantine hosted on a Cisco Secure Email and Web Manager — while retaining access to the messages in the local quarantine — you should prevent new messages from entering the local quarantine during the transition.

Consider the following possible strategies:

- Configuring anti-spam settings — Configure the anti-spam settings on your mail policy specifying Cisco Secure Email and Web Manager as the alternate host. This action sends new spam to the external quarantine while still allowing access to the local quarantine.
- Setting a shorter expiration time — Configure the Schedule Delete After setting on the local quarantine to a shorter duration.
- Deleting all of the remaining messages — To delete all remaining messages in the local quarantine, disable the quarantine and click the “Delete All” link on the local quarantines page (see [Deleting Messages from the Spam Quarantine, on page 970](#)). This link only becomes available when a local spam quarantine with messages still contained in it has been disabled.

You should now be ready to enable the external quarantine and disable the local quarantine.



---

**Note** If both the local quarantine and the external quarantine are enabled, the local quarantine is used.

---

# Enabling an External Spam Quarantine and External Safelist/Blocklist

You can enable only one external spam quarantine on an email gateway.

## Before You Begin

- Review the information in [Mail Flow and External Spam Quarantine](#) , on page 1292 .
- Review and take action on the information in [Migrating from a Local Spam Quarantine to an External Quarantine](#), on page 1293.
- Configure Cisco Secure Email and Web Manager to support the centralized spam quarantine and safelist/blocklist features. See the documentation for your Cisco Secure Email and Web Manager.
- If a different external spam quarantine was previously configured for the Email Security appliance, first disable the external spam quarantine setting.

Complete the following procedure on each email gateway.

## Procedure

---

- Step 1** Select **Security Services > Centralized Services > Spam Quarantine**.
- Step 2** Click **Configure**.
- Step 3** Select **Enable External Spam Quarantine**.
- Step 4** In the Name field, enter the name of Cisco Secure Email and Web Manager
- The name is not significant, and is used for reference only. For example, enter the hostname of Cisco Secure Email and Web Manager.
- Step 5** Enter an IP address and port number.
- These must match the IP address and port number that are specified on Cisco Secure Email and Web Manager in the Spam Quarantines Settings page (**Management Appliance > Centralized Services > Spam Quarantine**.)
- Step 6** (Optional) Select the check box to enable the **External Safelist/Blocklist** feature, and specify the appropriate blocklist action.
- Step 7** Submit and commit your changes.
- Step 8** Repeat this procedure for each email gateway.
- 

## What to do next

If you have been using a local quarantine, see [Disabling the Local Spam Quarantine to Activate the External Quarantine](#) , on page 1295.

## Related Topics

- [Local Versus External Spam Quarantine](#) , on page 943
- [Spam Quarantine](#), on page 943
- [Managing Spam and Graymail](#), on page 379
- [How to Configure the Email Gateway to Scan Messages for Spam](#), on page 380

## Disabling the Local Spam Quarantine to Activate the External Quarantine

If you were using a local spam quarantine before enabling an external spam quarantine, you must disable the local quarantine in order to send messages to the external quarantine.

### Before You Begin

Follow all directions, including information in the Before You Begin section, in [Enabling an External Spam Quarantine and External Safelist/Blocklist](#), on page 1294.

### Procedure

---

**Step 1** Select **Monitor > Spam Quarantine**.

**Step 2** In the Spam Quarantine section, click the **Spam Quarantine** link.

**Step 3** Deselect **Enable Spam Quarantine**.

Ignore any warnings to adjust mail policies as a result of this change. Mail policies automatically send messages to the external spam quarantine if you have configured the external quarantine settings.

**Step 4** Submit and commit your changes.

---

## Troubleshooting an External Spam Quarantine

**Problem:** Messages released from Cisco Secure Email and Web Manager are unnecessarily reprocessed by the email gateway.

**Solution:** This can occur if the IP address of Cisco Secure Email and Web Manager has changed. See [Mail Flow and External Spam Quarantine](#), on page 1292.

## About Centralizing Policy, Virus, and Outbreak Quarantines

- [Centralized Policy, Virus, and Outbreak Quarantines](#), on page 1295
- [About Migration of Policy, Virus, and Outbreak Quarantines](#), on page 1296
- [Centralizing Policy, Virus, and Outbreak Quarantines](#), on page 1297
- [About Disabling Centralized Policy, Virus, and Outbreak Quarantines](#), on page 1298
- [Troubleshooting Centralized Policy, Virus, and Outbreak Quarantines](#), on page 1299

## Centralized Policy, Virus, and Outbreak Quarantines

You can centralize policy, virus, and outbreak quarantines on a Cisco Secure Email and Web Manager. Messages are processed by email gateways but are stored in quarantines on Cisco Secure Email and Web Manager.

Centralizing policy, virus, and outbreak quarantines offers the following benefits:

- Administrators can manage quarantined messages from multiple email gateways in one location.
- Quarantined messages are stored behind the firewall instead of in the DMZ, reducing security risk.

- Centralized quarantines can be backed up using the standard backup functionality on Cisco Secure Email and Web Manager.

For complete information, see the user guide or online help for your Cisco Secure Email and Web Manager.

## Restrictions and Limitations of Centralized Policy, Virus, and Outbreak Quarantines

- On each email gateway, either all policy, virus, and outbreak quarantines must be centralized or all must be stored locally.
- Because scanning engines are not available on Cisco Secure Email and Web Manager, you cannot manually test messages in policy, virus, or outbreak quarantines for viruses.

## Requirements for Centralized Policy, Virus, and Outbreak Quarantines in Cluster Configurations

You can enable centralized policy, virus, and outbreak quarantines at any level for clustered appliances.

Requirements:

- Before you enable centralized policy, virus, and outbreak quarantines on an email gateway at a particular level (machine, group, or cluster), all appliances that belong to the same level must first be added to Cisco Secure Email and Web Manager.
- Content and message filters and DLP message actions must be configured at the same level and not overridden at any level below that level.
- Centralized policy, virus, and outbreak quarantines settings must be configured at the same level and not be overridden at any level below the configured level.
- Ensure that the interface to be used for communications with Cisco Secure Email and Web Manager has the same name on all appliances in the group or cluster.

For example:

If you want to enable centralized policy, virus, and outbreak quarantines at the cluster or group level, but an email gateway which is connected to the cluster has these settings defined at the machine level, you must remove the centralized quarantines settings configured at the machine level before you can enable the feature at the cluster or group level.

## About Migration of Policy, Virus, and Outbreak Quarantines

When you centralize policy, virus, and outbreak quarantines, existing policy, virus, and outbreak quarantines on your email gateway migrate to Cisco Secure Email and Web Manager.

You will configure migration on Cisco Secure Email and Web Manager, but migration occurs when you commit the change enabling centralized policy, virus, and outbreak quarantines on the email gateway.

As soon as you commit this change, the following occur:

- Local policy, virus, and outbreak quarantines on the email gateway are disabled. All new messages entering these quarantines will be quarantined on Cisco Secure Email and Web Manager.
- Migration of existing non-spam quarantines to Cisco Secure Email and Web Manager begins.
- All local policy, virus, and outbreak quarantines are deleted. If you configured a custom migration, any local policy quarantines that you chose not to migrate are also deleted. For effects of deleting policy quarantines, see [About Deleting Policy Quarantines](#), on page 930.
- A message that was in multiple quarantines before migration will be in the corresponding centralized quarantines after migration.



- Migration happens in the background. The amount of time it takes depends on the size of your quarantines and on your network. When you enable centralized quarantines on the email gateway, you can enter one or more email addresses that will receive notification when migration is complete.
- The settings in the centralized quarantine, not those of the originating local quarantine, apply to the messages. However, the original expiration time still applies to each message.



---

**Note** All centralized quarantines that are automatically created during migration have the default quarantine settings.

---

## Centralizing Policy, Virus, and Outbreak Quarantines

### Before you begin



---

**Note** Perform this procedure during a maintenance window or off-peak hours.

---

- You must first configure your Cisco Secure Email and Web Manager for centralized policy, virus, and outbreak quarantines. See the table in the “Centralizing Policy Virus, and Outbreak Quarantines” section in the “Centralized Policy, Virus, and Outbreak Quarantines” chapter in the online help or user guide for Cisco Secure Email and Web Manager.
- If the space allocated to centralized quarantines on Cisco Secure Email and Web Manager will be smaller than the amount of space that your existing local quarantines collectively occupy, messages will be expired early based on the quarantine settings on Cisco Secure Email and Web Manager. Before migration, consider taking manual action to reduce quarantine sizes. For more information about early expiration, see [Default Actions for Automatically Processed Quarantined Messages](#), on page 927.
- If you have chosen automatic migration, or configured custom migration to create centralized quarantines during migration, consider noting the current quarantine settings on your email gateways in order to use them as guidelines for configuring the centralized quarantines.
- If your email gateways are deployed in a cluster configuration, see [Requirements for Centralized Policy, Virus, and Outbreak Quarantines in Cluster Configurations](#), on page 1296.
- Be aware of the changes that will occur as soon as you commit the changes in this procedure. See [About Migration of Policy, Virus, and Outbreak Quarantines](#), on page 1296.

### Procedure

---

- Step 1** Choose **Security Services > Centralized Services > Policy, Virus, and Outbreak Quarantines**.
- Step 2** Click **Enable**.
- Step 3** Enter the interface and port to use for communication with Cisco Secure Email and Web Manager. Make sure the interface and port are reachable from Cisco Secure Email and Web Manager. If your email gateways are clustered, the interface you select must be available on all machines in the cluster.
- Step 4** To receive notification when migration is complete, enter one or more email addresses.
- Step 5** Verify the information about quarantines to be migrated to be sure that this is what you want.

- Step 6** If you are completing a Custom migration, note any quarantines that will be deleted when you commit the changes in this procedure.
- Step 7** Verify that the information about content and message filters and DLP message actions to be updated is as you expect it to be.
- Note** For cluster configurations, filters and message actions can be automatically updated on a particular level only if filters and message actions are defined at that level and not overridden at any level below that level. After migration, you may need to manually reconfigure filters and message actions with centralized quarantine names.
- Step 8** If you need to reconfigure migration mapping:
- Return to Cisco Secure Email and Web Manager.
  - Reconfigure the migration mapping.
 

On Cisco Secure Email and Web Manager, select a quarantines to remap, then click **Remove from Centralized Quarantine**. Then you can remap the quarantine.
  - Commit the new migration configuration on Cisco Secure Email and Web Manager.
  - Start this procedure from the beginning.
- Important!** Be sure to reload the **Security Services > Centralized Services > Policy, Virus, and Outbreak Quarantines** page.
- Step 9** Click **Submit**.
- Step 10** If you need to reconfigure migration mapping, follow the procedure in Step 8.
- Step 11** Commit your changes.
- Note** While migration is in progress, avoid making configuration changes on email gateway or Cisco Secure Email and Web Manager.
- Step 12** Look at the top of the page to monitor migration status, or, if you entered an email address when configuring migration, await the email notifying you that migration is complete.

---

### What to do next

Perform the remaining tasks described in the table in the “Centralizing Policy, Virus, and Outbreak Quarantines” topic in the online help or user guide for Cisco Secure Email and Web Manager.

### Related Topics

- [Which User Groups Can Access Policy, Virus, and Outbreak Quarantines](#) , on page 932

## About Disabling Centralized Policy, Virus, and Outbreak Quarantines

When you disable centralized policy, virus, and outbreak quarantines on the email gateway:

- Local quarantines are automatically enabled on the email gateway.
- System-created quarantines and quarantines that are referenced by message filters, content filters, and DLP message actions are automatically created on the email gateway. The Virus, Outbreak, and Unclassified quarantines are created with the same settings that they had before quarantines were centralized, including assigned user roles. All other quarantines are created with default settings.
- Newly quarantined messages go immediately to local quarantines.

- Messages in the centralized quarantine at the time it is disabled remain there until one of the following occurs:
  - Messages are manually deleted or automatically deleted when they expire.
  - Messages are manually or automatically released, if one of the following is also true:

\* An alternate release appliance is configured on Cisco Secure Email and Web Manager. See the online help or documentation for Cisco Secure Email and Web Manager.

\* Centralized quarantines are again enabled on the email gateway.

## Disabling Centralized Policy, Virus, and Outbreak Quarantines

### Before you begin

- Understand the impacts of disabling centralized policy, virus, and outbreak quarantines.
- Do one of the following:
  - Process all messages that are currently in centralized policy, virus, and outbreak quarantines.
  - Ensure that you have designated an alternate release appliance to process messages that are released from the centralized quarantine after you disable it. For information, see the online help or user guide for your Cisco Secure Email and Web Manager.

### Procedure

- 
- |               |  |
|---------------|--|
| <b>Step 1</b> | On the email gateway, choose <b>Security Services &gt; Centralized Services &gt; Policy, Virus, and Outbreak Quarantines</b> . |
| <b>Step 2</b> | Disable centralized policy, virus, and outbreak quarantines.   |
| <b>Step 3</b> | Submit and commit the change.  |
| <b>Step 4</b> | Customize the settings of the newly created local quarantines.   |
- 

## Troubleshooting Centralized Policy, Virus, and Outbreak Quarantines

### If a Cisco Secure Email and Web Manager Goes Out of Service

If Policy, Virus, and Outbreak Quarantines are centralized on a Cisco Secure Email and Web Manager that goes out of service, you should disable these centralized quarantines on the email gateway.

If you deploy a replacement Cisco Secure Email and Web Manager, you must reconfigure quarantine migration on Cisco Secure Email and Web Manager and on each email gateway. See the table in the “Centralizing Policy, Virus, and Outbreak Quarantines” section in the “Centralized Policy, Virus, and Outbreak Quarantines” chapter in the online help or user guide for Cisco Secure Email and Web Manager.

# Configuring Centralized Reporting

## Before you begin

- Enable and configure centralized reporting on a Cisco Secure Email and Web Manager. See prerequisites and instructions in Cisco Secure Email and Web Manager User Guide.
- Ensure that sufficient disk space is allocated to the reporting service on Cisco Secure Email and Web Manager.

## Procedure

---

- Step 1** Click **Security Services > Reporting**.
- Step 2** In the Reporting Service section, select the Centralized Reporting option.
- Step 3** Submit and commit your changes.
- 

## Requirements for Advanced Malware Protection Reporting

For required configurations for full reporting on Advanced Malware Protection (file reputation and file analysis) features on Cisco Secure Email and Web Manager, see the information about Advanced Malware Protection reports in the email reporting chapter of the online help or user guide for your version of Cisco Secure Email and Web Manager software.

## Availability of Reporting Information after Changing to Centralized Reporting

When centralized reporting is enabled on an email gateway:

- Existing data on the email gateway for the monthly report is not transferred to Cisco Secure Email and Web Manager.
- Archived reports on the email gateway are not available.
- The email gateway stores only a week's worth of data.
- New data for the monthly and yearly reports is stored on Cisco Secure Email and Web Manager.
- Scheduled reports on the email gateway are suspended.
- You can no longer access the scheduled report configuration page on the email gateway.

## About Disabling Centralized Reporting

If you disable centralized reporting on the email gateway, the email gateway begins storing new monthly report data, scheduled reports resume, and you can access its archived reports. After disabling centralized reporting, the appliance only displays data for the past hour and day, but not the past week or month. This is temporary. The appliance will display the reports for the past week and month after it accumulates enough data. If the email gateway Email Security appliance is placed back into centralized reporting mode, it will display data for the past week in the interactive reports.

# Configuring Centralized Message Tracking

## Before you begin



---

**Note** You cannot enable both centralized and local tracking on an email gateway.

---

## Procedure

---

- Step 1** Click **Security Services > Message Tracking**.
- Step 2** In the Message Tracking Service section, click **Edit Settings**.
- Step 3** Select the **Enable Message Tracking Service** check box.
- Step 4** Select the Centralized Tracking option.
- Step 5** (Optional) Select the check box to save information for rejected connections.

**Note** Saving tracking information for rejected connections can adversely affect the performance of Cisco Secure Email and Web Manager.

- Step 6** Submit and commit your changes.

### What To Do Next

To use centralized tracking, you must enable the feature on the email gateways *and* Cisco Secure Email and Web Manager. To enable centralized tracking on S Cisco Secure Email and Web Manager, see Cisco Secure Email and Web Manager User Guide.

---

## Using Centralized Services

For instructions on using centralized services, see the Cisco Secure Email and Web Manager User Guide.





# APPENDIX **A**

## FTP, SSH, and SCP Access

This appendix contains the following sections:

- [IP Interfaces, on page 1303](#)
- [Configuring FTP Access to the Email Gateway, on page 1304](#)
- [Secure Copy \(scp\) Access , on page 1306](#)
- [Accessing the Email Gateway via a Serial Connection, on page 1307](#)

## IP Interfaces

An IP interface contains the network configuration data needed for an individual connection to the network. You can configure multiple IP interfaces to a physical Ethernet interface. You can assign an Internet Protocol version 4 (IPv4) or version 6 (IPv6) to an IP interface or both.

**Table 163: Services Enabled by Default on Interfaces**

		Enabled by default?	
Service	Default port	Management interface <sup>2</sup>	New interfaces you create
FTP	21	No	No
SSH	22	Yes	No
HTTP	80	Yes	No
HTTPS	443	Yes	No

<sup>2</sup> The “Management Interface” settings shown here are also the default settings for the Data 1 Interface on Cisco C170 email gateway.

- If you need to access the email gateway via the graphical user interface (GUI), you must enable HTTP and/or HTTPS on an interface.
- If you need to access the email gateway for the purposes of uploading or downloading configuration files, you must enable FTP on an interface.
- You can also upload or download files using secure copy ( scp ).

You can configure HTTP or HTTPS access to the spam quarantine via an IP interface.

For email delivery and Virtual Gateways, each IP interface acts as one Virtual Gateway address with a specific IP address and hostname. You can also “join” interfaces into distinct groups (via the CLI), and the system will cycle through these groups when delivering email.

Joining or grouping Virtual Gateways is useful for load-balancing large email campaigns across several interfaces. You can also create VLANs, and configure them just as you would any other interface (via the CLI). For more information, see [Advanced Network Configuration, on page 1131](#)

#### Related Topics

- [How AsyncOS Selects Default IP Interface, on page 1304](#)

## How AsyncOS Selects Default IP Interface

AsyncOS selects the default IP interface based on the lowest IP address in which the IP interfaces appear under **Network > IP Interfaces** page or in the `ifconfig` CLI command. The first IP interface in the list that resides on the subnet in question is used.

If there are multiple IP addresses configured within the same subnet as the default gateway, the IP address with the lowest number is used. For example, if the following IP addresses are configured within the same subnet,

- 10.10.10.2/24
- 10.10.10.30/24
- 10.10.10.100/24
- 10.10.10.105/24

AsyncOS chooses 10.10.10.2/24 as the default IP interface.

## Configuring FTP Access to the Email Gateway

### Procedure

**Step 1** Use the **Network > IP Interfaces** page or the `interfaceconfig` command to enable FTP access for the interface.

**Danger** By disabling services via the `interfaceconfig` command, you have the potential to disconnect yourself from the CLI, depending on how you are connected to the email gateway. Do not disable services with this command if you are not able to reconnect to the email gateway using another protocol, the Serial interface, or the default settings on the Management port.

**Step 2** Submit and commit your changes.

**Step 3** Access the interface via FTP. Ensure you are using the correct IP address for the interface. For example:

```
§ ftp 192.168.42.42
```

**Note** Many browsers also allow you to access interfaces via FTP.



**Step 4** Browse to the directory for the specific task you are trying to accomplish. After you have accessed an interface via FTP, you can browse the following directories to copy and add (“GET” and “PUT”) files. See the following table.

Directory Name	Description
/configuration	<p>The directory where data from the following commands is exported to and/or imported (saved) from:</p> <ul style="list-style-type: none"> <li>• Virtual Gateway mappings ( <code>altsrchost</code> )</li> <li>• configuration data in XML format ( <code>saveconfig</code>, <code>loadconfig</code> )</li> <li>• Host Access Table (HAT) ( <code>hostaccess</code> )</li> <li>• Recipient Access Table (RAT) ( <code>rcptaccess</code> )</li> <li>• SMTP routes entries ( <code>smtproutes</code> )</li> <li>• alias tables ( <code>aliasconfig</code> )</li> <li>• masquerading tables ( <code>masquerade</code> )</li> <li>• message <b>filters</b> ( <code>filters</code> )</li> <li>• global unsubscribe data ( <code>unsubscribe</code> )</li> <li>• test messages for the <code>trace</code> command</li> <li>• Safelist/Blocklist backup file, saved in the following format: <i>sbl&lt;timestamp&gt;&lt;serial number&gt;.csv</i></li> </ul>
/antivirus	<p>The directory where the Anti-Virus engine log files are kept. You can inspect the log files this directory to manually check for the last successful download of the virus definition file ( <code>scan.dat</code> ).</p>

Directory Name	Description
/configuration	Created automatically for <b>logging</b> via the <code>logconfig</code> and <code>rollovernow</code> commands. See <a href="#">Logging, on page 1145</a> for a detailed description of each log.
/system_logs	
/cli_logs	See “Log File Type Comparison” for the differences between each log file type.
/status	
/reportd_logs	
reportqueryd_logs	
/ftpd_logs	
/mail_logs	
/asarchive	
/bounces	
/error_logs	
/avarchive	
/gui_logs	
/sntpd_logs	
/RAID.output	
/euq_logs	
/scanning	
/antispam	
/antivirus	
/euqgui_logs	
/ipmitool.output	

**Step 5** Use your FTP program to upload and download files to and from the appropriate directory.

## Secure Copy (scp) Access

If your client operating system supports a secure copy ( `scp` ) command, you can copy files to and from the directories listed in the previous table. For example, in the following example, the file `/tmp/test.txt` is copied from the client machine to the configuration directory of the email gateway with the hostname of `mail3.example.com`.

Note that the command prompts for the passphrase for the user ( `admin` ). This example is shown for reference only; your particular operating system’s implementation of secure copy may vary.

```
% scp /tmp/test.txt admin@mail3.example.com:configuration
```

```
The authenticity of host 'mail3.example.com (192.168.42.42)' can't be established.
```

```

DSA key fingerprint is 69:02:01:1d:9b:eb:eb:80:0c:a1:f5:a6:61:da:c8:db.
Are you sure you want to continue connecting (yes/no)? yes

Warning: Permanently added 'mail3.example.com ' (DSA) to the list of known hosts.
admin@mail3.example.com's passphrase: (type the passphrase)
test.txt 100% |*****| 1007 00:00
%

```

In this example, the same file is copied from the email gateway to the client machine:

```

% scp admin@mail3.example.com:configuration/text.txt .
admin@mail3.example.com's passphrase: (type the passphrase)
test.txt 100% |*****| 1007 00:00
%

```

You can use secure copy ( `scp` ) as an alternative to FTP to transfer files to and from the email gateway.



**Note** Only users in the operators and administrators group can use secure copy ( `scp` ) to access the email gateway. For more information, see [Adding Users](#) , on page 976.

## Accessing the Email Gateway via a Serial Connection

If you are connecting to the email gateway via a serial connection, use the following information for the console port.

Complete information about this port is in the hardware installation guide for your appliance.

### Pinout Details for the Serial Port in 80- and 90- Series Hardware

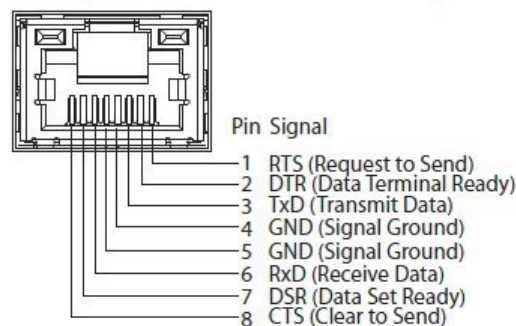

## Pinout Details for the Serial Port in 70-Series Hardware

The following figure illustrates the pin numbers for the serial port connector, and the following table defines the pin assignments and interface signals for the serial port connector.

**Figure 89: Pin Numbers for the Serial Port**

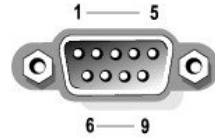

**Table 164: Serial Port Pin Assignments**

Pin	Signal	I/O	Definition
1	DCD		Data carrier detect
2	SIN		Serial input
3	SOUT		Serial output
4	DTR		Data terminal ready
5	GND	n/a	Signal ground
6	DSR		Data set ready
7	RTS		Request to send
8	CTS		Clear to send
9	RI		Ring indicator
Shell	n/a	n/a	Chassis ground



## APPENDIX **B**

# Assigning Network and IP Addresses

---

This appendix contains the following sections:

- [Ethernet Interfaces, on page 1309](#)
- [Selecting IP Addresses and Netmasks, on page 1309](#)
- [Strategies for Connecting Your Email Gateway, on page 1311](#)

## Ethernet Interfaces

Email Gateways have up to four Ethernet interfaces located on the rear panel of the system, depending on the configuration (whether or not you have the optional optical network interface). They are labeled:

- Management
- Data1
- Data2
- Data3
- Data4

## Selecting IP Addresses and Netmasks

When you configure the network, the email gateway must be able to select a unique interface to send an outgoing packet. This requirement drives some of the decisions regarding IP address and netmask selection for the Ethernet interfaces. The rule is that only one interface can be on a single network (as determined through the applications of netmasks to the IP addresses of the interfaces).

An IP address identifies a physical interface on any given network. A physical Ethernet interface can have more than one IP address for which it accepts packets. An Ethernet interface that has more than one IP address can send packets over that interface with any one of the IP addresses as the source address in the packet. This property is used in implementing Virtual Gateway technology.

The purpose of a netmask is to divide an IP address into a network address and a host address. The network address can be thought of as the network part (the bits matching the netmask) of the IP address. The host address is the remaining bits of the IP address. The number of bits in a four octet address that are significant are sometimes expressed in Classless Inter-Domain Routing (CIDR) style. This is a slash followed by the number of bits (1-32).

A netmask can be expressed in this way by simply counting the ones in binary, so 255.255.255.0 becomes “/24” and 255.255.240.0 becomes “/20.”

## Sample Interface Configurations

This section shows sample interface configurations based on some typical networks. The example uses two interfaces called Int1 and Int2. In the case of the email gateway, these interface names can represent any two interfaces out of the three interfaces (Management, Data1, Data2).

### Network 1:

Separate interfaces must appear to be on separate networks.

Interface	IP Address	Netmask	Net Address
Int1	192.168.1.10	255.255.255.0	192.168.1.0/24
Int2	192.168.0.10	255.255.255.0	192.168.0.0/24

Data addressed to 192.168.1.X (where X is any number from 1 through 255, except for your own address, 10 in this case) go out on Int1. Anything addressed to 192.168.0.X goes out on Int2. Any packet headed for some other address not in these formats, most likely out on a WAN or the Internet, is sent to the default gateway, which must be on one of these networks. The default gateway then forwards the packet on.

### Network 2:

The network addresses (network parts of the IP addresses) of two different interfaces cannot be the same.

Ethernet Interface	IP Address	Netmask	Net Address
Int1	192.168.1.10	255.255.0.0	192.168.0.0/16
Int2	192.168.0.10	255.255.0.0	192.168.0.0/16

This situation presents a conflict in that two different Ethernet interfaces have the same network address. If a packet from the content security appliance is sent to 192.168.1.11, there is no way to decide which Ethernet interface should be used to deliver the packet. If the two Ethernet interfaces are connected to two separate physical networks, the packet may be delivered to the incorrect network and never find its destination. The email gateway does not allow you to configure your network with conflicts.

You can connect two Ethernet interfaces to the same physical network, but you must construct IP addresses and netmasks to allow the email gateway to select a unique delivery interface.

## IP Addresses, Interfaces, and Routing

When you select an interface on which to perform a command or function in the GUI or CLI that allows you to select an interface (for example, upgrading AsyncOS or configuring DNS), routing (your default gateway) takes precedence over your selection.

For example, suppose that you have a email gateway with the three network interfaces configured, each on a different network segment (assume all /24):

Ethernet	IP
Management	192.19.0.100
Data1	192.19.1.100

Ethernet	IP
Data2	192.19.2.100

And your default gateway is 192.19.0.1.

Now, if you perform an AsyncOS upgrade (or other command or function that allows you to select an interface) and you select the IP that is on Data1 (192.19.1.100), you would expect all the TCP traffic to occur over the Data1 Ethernet interface. However, instead the traffic goes out of the interface that is set as your default gateway, in this case Management, but is stamped with the source address of the IP on Data1.

## Summary

The content security appliance must always be able to identify a unique interface over which a packet can be delivered. To make this decision, the email gateway uses a combination of the packet's destination IP address, and the network and IP address settings of its Ethernet interfaces. The following table summarizes the preceding examples:

	Same Network	Different Network
Same Physical Interface	Allowed	Allowed
Different Physical Interface	Not allowed	Allowed

## Strategies for Connecting Your Email Gateway

Keep the following in mind when connecting your email gateway:

- Administrative traffic (CLI, web interface, log delivery) is usually little compared to email traffic.
- If two Ethernet interfaces are connected to the same network switch, but end up talking to a single interface on another host downstream, or are connected to a network hub where all data are echoed to all ports, no advantage is gained by using two interfaces.
- SMTP conversations over an interface operating at 1000Base-T are slightly faster than conversations over the same interfaces operating at 100Base-T, but only under ideal conditions.
- There is no point in optimizing connections to your network if there is a bottleneck in some other part of your delivery network. Bottlenecks most often occur in the connection to the Internet and further upstream at your connectivity provider.

The number of interfaces that you choose to connect and how you address them should be dictated by the complexity of your underlying network. It is not necessary to connect multiple interfaces if your network topology or data volumes do not call for it. It is also possible to keep the connection simple at first as you familiarize yourself with the gateway and then increase the connectivity as volume and network topology require it.







## APPENDIX **C**

# Example of Mail Policies and Content Filters

This appendix contains the following sections:

- [Overview of Incoming Mail Policies](#) , on page 1313

## Overview of Incoming Mail Policies

The following example demonstrates the features of mail policies by illustrating the following tasks:

1. Editing the anti-spam, anti-virus, Outbreak Filter, and Content Filters for the default Incoming Mail Policy.
2. Adding two new policies for different sets of users — the sales organization and the engineering organization — and then configuring different email security settings for each.
3. Creating three new content filters to be used in the Incoming Mail Overview policy table.
4. Editing the policies again to enable the content filters for some groups, but not for others.

This example is meant to show the power and flexibility with which you can manage different recipient-based settings for anti-spam, anti-virus, Outbreak Filter, and Content Filters for mail policies. This example assigns these a custom user role called “Policy Administrator” that has mail policy and content filters access privileges. For more detailed information about how anti-spam, anti-virus, Outbreak filters, and delegated administration work, refer to the chapters following this one:

- [Managing Spam and Graymail](#), on page 379
- [Anti-Virus](#), on page 361
- [Outbreak Filters](#), on page 421
- [Distributing Administrative Tasks](#), on page 973

## Accessing Mail Policies

You can access incoming and outgoing mail policies by using the Mail Policies menu.

On brand new systems, if you completed all steps in the system setup wizard and you chose to enable Anti-Spam, Sophos or McAfee Anti-Virus, and Outbreak Filters, the Incoming Mail Policies Page will resemble in the following figure.

By default, these settings are enabled for the default Incoming Mail Policy:

- Anti-Spam (if the Spam Quarantine is enabled): Enabled
  - Positively-identified spam: quarantine, prepend the message subject
  - Suspected spam: quarantine, prepend the message subject

- Marketing email: scanning not enabled
- Anti-Spam (if the Spam Quarantine is not enabled): Enabled
  - Positively-identified spam: deliver, prepend the message subject
  - Suspected spam: deliver, prepend the message subject
  - Marketing email: scanning not enabled
- Anti-Virus: Enabled, Scan and Repair viruses, include an X-header with anti-virus scanning results
  - Repaired messages: deliver, prepend the message subject
  - Encrypted messages: deliver, prepend the message subject
  - Unscannable messages: deliver, prepend the message subject
  - Virus infected messages: drop
- Outbreak Filters: Enabled
  - No file extensions are excepted
  - Retention time for messages with suspect viral attachments is 1 day
  - Message modification is not enabled
- Content Filters: Disable

**Figure 90: Incoming Mail Policies Page: Defaults for a Brand New Email Gateway**

**Incoming Mail Policies**

**Find Policies**

Email Address:  
 Recipient  
 Sender
  Find Policies

**Policies**

Add Policy...

Order	Policy Name	Anti-Spam	Anti-Virus	Content Filters	Outbreak Filters	Delete
	Default Policy	IronPort Anti-Spam Positive: Quarantine Suspected: Quarantine Marketing Messages: Disabled	Sophos Encrypted: Deliver Unscannable: Deliver Virus Positive: Drop	Disabled	Retention Time: Virus: 1 day	

Key: Default Custom Readonly



**Note** In this example, the Incoming Mail Policy will use the default anti-spam settings for when the Spam Quarantine is enabled.

## Enabled, Disabled, and “Not Available”

The columns in a mail policy table (either incoming or outgoing) display links for the state of the security service for each policy name. If a service is enabled, the word “Enabled” or a summary of the configuration is displayed. Similarly, the word “Disabled” is displayed if a service is disabled.

“Not Available” is displayed as a link if the license agreement for a service has not been accepted yet or a service has expired. In these cases, clicking the “Not Available” link will display the global page within the Security Services tab, rather than the page where you can configure per-policy settings for a service. An alert is displayed to let you know that your page has changed to a different tab. See the following figure.

Figure 91: Security Services Not Available

**Incoming Mail Policies**

Find Policies

Email Address:   Recipient  Sender

**Policies**

Order	Policy Name	Anti-Spam	Anti-Virus	Content Filters	Outbreak Filters	Delete
	Default Policy	Not Available	Not Available	Disabled	Not Available	

Key:

## Configuring the Default Anti-Spam Policies for Incoming Messages

Each row in the mail policy table represents a different policy. Each column represents a different security service.

- To edit the default policy, click any of the links for a security service in the bottom row of the incoming or outgoing mail policy table.

In this example, you will change the anti-spam settings for the default policy for incoming mail to be more aggressive. The default value is to quarantine positively identified and suspected spam messages, with marketing email scanning disabled. This example shows how to change the setting so that positively identified spam is dropped. Suspected spam continues to be quarantined. Marketing email scanning is enabled, with marketing messages being delivered to the intended recipients. The subjects of marketing messages will be prepended with the text [MARKETING].

### Procedure

- 
- Step 1** Click the link for the anti-spam security service.
- Note** For default security service settings, the first setting on the page defines whether the service is enabled for the policy. You can click “Disable” to disable the service altogether.
- Step 2** In the “Positively Identified Spam Settings” section, change the “Action to apply to this message” to Drop.
- Step 3** In the “Marketing Email Settings” section, click **Yes** to enable marketing email scanning.
- If enabled, the default action is to deliver legitimate marketing messages while prepending the subject with the text [MARKETING].
- The “Add text to message” field only accepts US-ASCII characters.
- Step 4** Click **Submit**. Note that the summary link for the anti-spam security service in the Incoming Mail Policies table has changed to reflect the new values.
- Similar to the steps above, you can change the default anti-virus and virus outbreak filter settings for the default policy.

Figure 92: Anti-Spam Settings Page

**Mail Policies: Anti-Spam**

Anti-Spam Settings	
<b>Policy:</b>	Default
Enable Anti-Spam Scanning for This Policy:	<input checked="" type="radio"/> Use IronPort Anti-Spam service <input type="radio"/> Disabled
<b>Positively-Identified Spam Settings</b>	
Apply This Action to Message:	Drop
Add Text to Subject:	Prepend [SPAM]
Advanced Optional settings for custom header and message delivery.	
<b>Suspected Spam Settings</b>	
Enable Suspected Spam Scanning:	<input type="radio"/> No <input checked="" type="radio"/> Yes
Apply This Action to Message:	Spam Quarantine
<i>Note: If local and external quarantines are defined, mail will be sent to local quarantine.</i>	
Add Text to Subject:	Prepend [SUSPECTED SPAM]
Advanced Optional settings for custom header and message delivery.	
<b>Marketing Email Settings</b>	
Enable Marketing Email Scanning:	<input type="radio"/> No <input checked="" type="radio"/> Yes
Apply This Action to Message:	Deliver
Send to Alternate Host (optional):	
Add Text to Subject:	Prepend [MARKETING]
Advanced Optional settings for custom header and message delivery.	
<b>Spam Thresholds</b>	
<i>Spam is scored on a 1-100 scale. The higher the score, the more likely a message is a spam.</i>	
IronPort Anti-Spam:	<input checked="" type="radio"/> Use the Default Thresholds <input type="radio"/> Use Custom Settings:
Positively Identified Spam:	Score > 90 (50 - 100)
Suspected Spam:	Score > 50 (minimum 25, cannot exceed positive spam score)

Cancel Submit

## Creating a Mail Policy for a Group of Sender and Recipients

In this part of the example, you will create two new policies: one for the sales organization (whose members will be defined by an LDAP acceptance query), and another for the engineering organization. Both policies will be assigned to the Policy Administrator custom user role to make delegated administrators belonging to this role responsible for managing these policies. You will then configure different email security settings for each.

### Procedure

- Step 1** Click the **Add Policy** button to begin creating a new policy.
- Step 2** Define a unique name for and adjust the order of the policy (if necessary).  
The name of the policy must be unique to the Mail Policies table (either incoming or outgoing) in which it is defined.  
Remember that each recipient is evaluated for each policy in the appropriate table (incoming or outgoing) in a top-down fashion.
- Step 3** Click the Editable by (Roles) link and select the custom user roles for the delegated administrators who will be responsible for managing the mail policy.

When you click the link, AsyncOS displays the custom roles for delegated administrators that have edit privileges for mail policies. Delegated administrators can edit a policy's Anti-Spam, Anti-Virus, and Outbreak Filters settings and enable or disable content filters for the policy. Only operators and administrators can modify a mail policy's name or its senders, recipients, or groups. Custom user roles that have full access to mail policies are automatically assigned to mail policies.

See the [Distributing Administrative Tasks, on page 973](#) for more information on delegated administration.

#### Step 4 Define users for the policy.

You define whether the user is a sender or a recipient. (See [Examples of Policy Matching, on page 258](#) for more detail.) The form shown in the following figure defaults to recipients for incoming mail policies and to senders for outgoing mail policies.

Users for a given policy can be defined in the following ways:

- Full email address: user@example.com
- Partial email address: user@
- All users in a domain: @example.com
- All users in a partial domain: @.example.com
- By matching an LDAP Query

**Note** Entries for users are case-insensitive in both the GUI and CLI in AsyncOS. For example, if you enter the recipient Joe@ for a user, a message sent to joe@example.com will match.

If you store user information within LDAP directories in your network infrastructure — for example, in Microsoft Active Directory, SunONE Directory Server (formerly known as “iPlanet Directory Server”), or Open LDAP directories — you can configure the email gateway to query your LDAP servers for the purposes of accepting recipient addresses, rerouting messages to alternate addresses and/or mail hosts, masquerading headers, and determining if messages have recipients or senders from specific groups.

If you have configured the email gateway to do so, you can use the configured queries to define users for a mail policy.

See [LDAP Queries, on page 771](#) for more information.

**Figure 93: Defining Users for a Policy**

**Add Incoming Mail Policy**

**Add Policy**

Policy Name:  (e.g. my IT policy)

Editable by (Roles): No roles selected

Insert Before Policy: 1 (Default Policy)

**Add Users**

Sender

Recipient

(e.g. user@example.com, user@, @example.com, @.example.com)

LDAP Group Query

Query: Sales\_West.group

Group:

**Current Users**

Recipient: Sales\_West.group: West

#### Step 5 Click the **Add** button to add users into the Current Users list.

Policies can contain mixtures of senders, recipients, and LDAP queries.

Use the **Remove** button to remove a defined user from the list of current users.

**Step 6** When you are finished adding users, click **Submit**.

Note that all security services settings are set to use the default values when you first add a policy.

**Figure 94: Newly Added Policy — Sales Group**

Policies						
Add Policy...						
Order	Policy Name	Anti-Spam	Anti-Virus	Content Filters	Outbreak Filters	Delete
1	Sales_Team	(use default)	(use default)	(use default)	(use default)	
	Default Policy	IronPort Anti-Spam Positive: Quarantine Suspected: Quarantine Marketing Messages: Disabled	Sophos Encrypted: Deliver Unscannable: Deliver Virus Positive: Drop	Disabled	Retention Time: Virus: 1 day	

**Step 7** Click the **Add Policy** button again to add another new policy.

In this policy, individual email addresses for members of the engineering team are defined:

**Figure 95: Creating a Policy for the Engineering Team**

**Add Incoming Mail Policy**

**Add Policy**

Policy Name:  (e.g. my IT policy)

Editable by (Roles): Policy Administrator

Insert Before Policy: 2 (Default Policy) ▼

---

**Add Users**

Sender

Recipient ?

Email Address(es)

(e.g. user@example.com, user@, @example.com, @.example.com)

LDAP Group Query

Query: Sales\_West.group ▼

Group:

**Current Users**

Recipient: bob@example.com  
Recipient: mary@example.com  
Recipient: fred@example.com

**Step 8** When you are finished adding users for the engineering policy, click **Submit**.

**Step 9** Commit your changes.

**Figure 96: Newly Added Policy — Engineering Team**

Policies						
Add Policy...						
Order	Policy Name	Anti-Spam	Anti-Virus	Content Filters	Outbreak Filters	Delete
1	Sales_Team	(use default)	(use default)	(use default)	(use default)	
2	Engineering	(use default)	(use default)	(use default)	(use default)	
	Default Policy	IronPort Anti-Spam Positive: Quarantine Suspected: Quarantine Marketing Messages: Disabled	Sophos Encrypted: Deliver Unscannable: Deliver Virus Positive: Drop	Disabled	Retention Time: Virus: 1 day	

**Note** At this point, both newly created policies have the same settings applied to them as those in the default policy. Messages to users of either policy will match; however, the mail processing settings are not any different from the default policy. Therefore, messages that match users in the “Sales\_Group” or “Engineering” policies will not be processed any differently than the default policy.

## Default, Custom, and Disabled

The key at the bottom of the table shows how the color coding of cells for specific policies relates to the policy defined for the default row:

- Yellow shading shows that the policy is using the same settings as the default policy.
- No shading (white) shows that the policy is using different settings than the default policy.
- Grey shading shows that the security service has been disabled for the policy.

## Creating Mail Policies for Different Groups of Senders and Recipients

In this part of the example, you will edit the two policies just created in the previous section.

- For the sales group, you will change the anti-spam settings to be even more aggressive than the default policy. (See [Configuring the Default Anti-Spam Policies for Incoming Messages, on page 1315](#).) The default policy of dropping positively identified spam messages will be kept. However, in this example, you will change the setting for marketing messages so that they will be sent to the Spam quarantine.

This aggressive policy has the effect of minimizing unwanted messages being sent to sales team inboxes.

See [Managing Spam and Graymail, on page 379](#) for more information on anti-spam settings.

- For the engineering team, customize the Outbreak Filters feature setting so that it will modify the URLs in suspicious messages, except for links to example.com. Attachment files with the extension “dwg” will be bypassed by the Outbreak Filter scanning.

See [Outbreak Filters, on page 421](#) for more information on configuring Outbreak Filters.

To edit the anti-spam settings for the sales team policy:

### Procedure

- 
- Step 1** Click the link for the Anti-Spam security service (the Anti-Spam) column in the sales policy row. Because the policy was just added, the link is named: (use default) .
- Step 2** On the anti-spam security service page, change the value for “Enable Anti-Spam Scanning for this Policy” from “Use Default Settings” to “Use Anti-Spam service.”
- Choosing “Use Anti-Spam service” here allows you to override the settings defined in the default policy.
- Step 3** In the “Positively-Identified Spam Settings” section, change the “Apply This Action to Message” to “Drop.”
- Step 4** In the “Suspected Spam Settings” section, click **Yes** to enable suspected spam scanning.
- Step 5** In the “Suspected Spam Settings” section, change the “Apply This Action to Message” to “Spam Quarantine.”

**Note** Selecting the Spam quarantine forwards mail according to the settings defined in the Spam Quarantine chapter.

**Step 6** In the “Add text to subject” field, click **None**.

Messages delivered to the Spam quarantine will have no additional subject tagging.

**Step 7** In the “Marketing Email Settings” section, click **Yes** to enable scanning for marketing mail from legitimate sources.

**Step 8** In the “Apply This Action to Message” section, select “Spam Quarantine.”

**Step 9** Submit and commit your changes.

Not that the shading shows that the policy is using different settings than the default policy.

At this point, any message that is suspected spam and whose recipient matches the LDAP query defined for the sales team policy will be delivered to the Spam Quarantine.

## Creating Mail Policies for Different Groups of Senders and Recipients

To edit the Outbreak Filter settings for the engineering team policy:

### Procedure

**Step 1** Click the link for the Outbreak Filters feature security service (the Outbreak Filters column) in the engineering policy row.

Because the policy was just added, the link is named: (use default) .

**Step 2** On the Outbreak Filters feature security service page, change the scanning setting for the policy to “Enable Outbreak Filtering (Customize settings).”

Choosing “(Customize settings)” here allows you to override the settings defined in the default policy.

Doing so will also enable the contents of the rest of the page to allow you to select different settings.

**Step 3** In the “Bypass Attachment Scanning” section of the page, type **dwg** in the file extension field.

The file extension “ dwg ” is not in the list of known file type that the email gateway can recognize by its fingerprint when attachment scanning.

**Note** You do not need to type the period ( . ) before the three letter filename extension.

**Step 4** Click **Add Extension** to add .dwg files to the list of file extensions that will bypass Outbreak Filters feature scanning.

**Step 5** Click **Enable Message Modification**.

Enabling message modification allows the email gateway to scan for targeted threats, such as phishing and scams, and URLs to suspicious or malicious websites. The appliance can rewrite links in messages to redirect the user through the Cisco Security proxy if they attempt to access the website.

**Note** Anti-spamming scanning must be enabled on the mail policy in order for Outbreak Filters to scan for targeted, non-viral threats.





## Finding Senders or Recipients in Mail Policies

Use the “Find Policies” button to search for users already defined in policies defined in the Incoming or Outgoing Mail Policies pages.

For example, typing joe@example.com and clicking the Find Policies button will display results showing which policies contain defined users that will match the policy.

Click the name of the policy to jump to the Edit Policy page to edit the users for that policy.

Note that the default policy will always be shown when you search for any user, because, by definition, if a sender or recipient does not match any other configured policies, it will *always* match the default policy.

## Managed Exceptions

Using the steps shown in the two examples above, you can begin to create and configure policies on a *managed exception* basis. In other words, after evaluating your organization’s needs you can configure policies so that the majority of messages will be handled by the default policy. You can then create additional “exception” policies for specific users or user groups, managing the differing policies as needed. In this manner, message splintering will be minimized and you are less likely to impact system performance from the processing of each splinter message in the work queue.

You can define policies based on your organizations’ or users’ tolerance for spam, viruses, and policy enforcement. The following table outlines several example policies. “Aggressive” policies are designed to minimize the amount of spam and viruses that reach end-users mailboxes. “Conservative” policies are tailored to avoid false positives and prevent users from missing messages, regardless of policies.

**Table 165: Aggressive and Conservative Mail Policy Settings**

	<b>Aggressive Settings</b>	<b>Conservative Settings</b>
Anti-Spam	Positively identified spam: Drop Suspected spam: Quarantine Marketing mail: Deliver and prepend “[Marketing]” to the subject messages	Positively identified spam: Quarantine Suspected spam: Deliver and prepend “[Suspected Spam]” to the subject of messages Marketing mail: Disabled
Anti-Virus	Repaired messages: Deliver Encrypted messages: Drop Unscannable messages: Drop Infectious messages: Drop	Repaired messages: Deliver Encrypted messages: Quarantine Unscannable messages: Quarantine Infectious messages: Drop
Virus Filters	Enabled, no specific filename extensions or domains allowed to bypass Enable message modification for all messages	Enabled with specific filename extensions or domains allowed to bypass Enable message modification for unsigned messages

## Filtering Messages Based on Content

In this part of the example, you will create three new content filters to be used in the Incoming Mail Policy table. All of these content filters will be editable by delegated administrators belonging to the Policy Administration custom user role. You will create the following:

1. “scan\_for\_confidential”

This filter will scan messages for the string “confidential.” If the string is found, a copy of the message will be sent to email alias hr@example.com , and the message will be sent to the Policy quarantine area.

2. “no\_mp3s”

This filter will strip MP3 attachments and notify the recipients that an MP3 file was stripped.

3. “ex\_employee”

This content filter will scan for messages sent to a specific envelope recipient address (an ex-employee). If the message matches, a specific notification message will be sent to the sender of the message and then the message will be bounced.

After creating the content filters, you will then configure each of the policies (including the default policy) to enable the specific content filters in differing combinations.

## Quarantining Message with “Confidential” in the Subject

The first example content filter contains one condition and two actions.

### Procedure

---

- Step 1** Click the Mail Policies tab.
- Step 2** Click Incoming Content Filters.
- Step 3** Click the **Add Filter** button.
- Step 4** In the Name field, type scan\_for\_confidential as the name of the new filter.
- Filter names can contain ASCII characters, numbers, underscores or dashes. The first character of a content filter name must be a letter or an underscore.
- Step 5** Click the **Editable By (Roles)** link, select the Policy Administrator and click **OK**.
- Delegated administrators who belong to the Policy Administrator user role will be able to edit this content filter and use it in their mail policies.
- Step 6** In the Description field, type the description. For example: scan all incoming mail for the string ‘confidential’.
- Step 7** Click Add Condition.
- Step 8** Select Message Body.
- Step 9** Type confidential in the Contains text: field and click **OK**.
- The Add Content Filter page shows the condition added.
- Step 10** Click Add Action.
- Step 11** Select Send Copy To (Bcc:).

- Step 12** In the Email Addresses field, type `hr@example.com` .
- Step 13** In the Subject field, type `[message matched confidential filter]` .
- Step 14** Click **OK**.

The Add Content Filter page shows the action added.

- Step 15** Click Add Action.
- Step 16** Select Quarantine.
- Step 17** In the drop-down menu, select the Policy quarantine area.
- Step 18** Click **OK**.

The Add Content Filter page shows the second action added.

- Step 19** Submit and commit your changes.

At this point, the content filter is not enabled for any incoming Mail Policy; in this example, you have only added a new content filter to the primary list. Because it has not been applied to any policy, no email processing by the email gateway will be affected by this filter.

---

## Stripping MP3 Attachments from Messages

The second example content filter contains no conditions and one action.

### Procedure

- Step 1** Click the **Add Filter** button.
- Step 2** In the Name field, type `no_mp3s` as the name of the new filter.
- Step 3** Click the **Editable By (Roles)** link, select the Policy Administrator and click **OK**.
- Step 4** In the Description field, type the description. For example: `strip all MP3 attachments` .
- Step 5** Click Add Action.
- Step 6** Select Strip Attachment by File Info.
- Step 7** Select File type is .
- Step 8** In the drop-down field, select `-- mp3` .
- Step 9** Enter a replacement message if desired.
- Step 10** Click **OK**.
- Step 11** Submit and commit your changes.

**Note** It is not necessary to specify a condition when creating a content filter. When no condition is defined, any actions defined will always apply in the rule. (Specifying no condition is equivalent to using the `true()` message filter rule — all messages will be matched if the content filter is applied to a policy.)

---

## Bouncing Messages Sent to a Former Employee

The third content filter example uses one condition and two actions.

## Procedure

---

- Step 1** Click the **Add Filter** button.
- Step 2** In the Name: field, type **ex\_employee** as the name of the new filter.
- Step 3** Click the **Editable By (Roles)** link, select the Policy Administrator and click **OK**.
- Step 4** In the Description: field, type the description. For example: **bounce messages intended for Doug** .
- Step 5** Click **Add Condition**.
- Step 6** Select **Envelope Recipient**.
- Step 7** For the envelope recipient, select **Begins with** , and type **doug@** .
- Step 8** Click **OK**.
- The Content Filters page refreshes to show the condition added. Note that you could create an LDAP directory containing the email addresses of former employees. As ex-employees are added to that directory, this content filter would be dynamically updated.
- Step 9** Click Add Action.
- Step 10** Select Notify.
- Step 11** Select the checkbox for Sender and, in the **Subject** field, type message bounced for ex-employee of **example.com** .
- Step 12** In the Use template section, select a notification template.
- Note** Some sections of the content filter rule builder will not appear in the user interface if the resource has not been preconfigured. For example, content dictionaries, notification templates, and message disclaimers will not appear as options if they have not been configured previously via the **Mail Policies > Dictionaries** page (or the **dictionaryconfig** command in the CLI). For more information about creating dictionaries, see [Content Dictionaries, on page 639](#).
- Step 13** Click **OK**.
- The Add Content Filters page shows the action added.
- Step 14** Click Add Action.
- Step 15** Select Bounce (Final Action) and click **OK**.
- You can only specify one final action for a content filter. If you try to attempt to add more than one final action, the GUI displays an error.
- Adding this action may will cause senders of messages to this ex-employee to potentially receive two messages: one for the notification template, and one for the bounce notification template.
- Step 16** Submit and commit your changes.
- 

## Applying Individual Content Filters to Different Groups of Recipients

In the examples above, you created three content filters using the Incoming Content Filters pages. The Incoming Content Filters and Outgoing Content filters pages hold the “primary lists” of all possible content filters that can be applied to a policy.

Figure 98: Incoming Content Filters: Three Filters Created

## Incoming Content Filters

Filters				
Add Filter...				
Order	Filter Name	Description   Rules   Policies	Duplicate	Delete
1	scan_for_confidential	scan all incoming mail for the string 'confidential'		
2	no_mp3s	strip all MP3 attachments		
3	ex_employee	bounce messages intended for Doug		

In this part of the example, you will apply the three new content filters to be used in the Incoming Mail Policy table.

- The default policy will receive all three content filters.
- The engineering group will *not* receive the no\_mp3s filter.
- The sales group will receive the content filters as the default incoming mail policy.

## Enabling Content Filters for All Recipients by Default

Click the links to enable and select content filters for individual policies.

### Procedure

- 
- Step 1** Click Incoming Mail Policies to return to the Incoming Mail Policy table.
- The page is refreshed to show the default policy and the two policies added in [Creating a Mail Policy for a Group of Sender and Recipients, on page 1316](#). Note that content filtering is disabled by default for all policies.
- Step 2** Click the link for the Content Filters security service (the Content Filters column) in the default policy row.
- Step 3** On the Content Filtering security service page, change the value Content Filtering for Default Policy from “Disable Content Filters” to “Enable Content Filters (Customize settings).”
- The content filters defined in the primary list (which were created in [Overview of Content Filters, on page 269](#) using the Incoming Content Filters pages) are displayed on this page. When you change the value to “Enable Content Filters (Customize settings),” the checkboxes for each filter change from disabled (greyed out) to become enabled.
- Step 4** Check the **Enable** checkbox for each content filter.
- Step 5** Click **Submit**.
- The table on the Incoming Mail Policies page shows the names of the filters that have been enabled for the default policy.
- 

## Allowing MP3 Attachments for Recipients in Engineering

To disable the “no\_mp3s” content filters for the “engineering” policy:

## Procedure

- 
- Step 1** Click the link for the Content Filters security service (the Content Filters column) in the engineering team policy row.
- Step 2** On the Content Filtering security service page, change the value for Content Filtering for Policy: Engineering from “Enable Content Filtering (Inherit default policy settings)” to “Enable Content Filtering (Customize settings).”
- Because this policy was using the default values, when you change the value from “Use Default Settings” to “Yes,” the checkboxes for each filter change from disabled (greyed out) to become enabled.
- Step 3** Deselect the checkbox for the “no\_mp3s” filter.
- Step 4** Click **Submit**.
- The table on the Incoming Mail Policies page shows the names of the filters that have been enabled for the engineering policy.
- Step 5** Commit your changes.
- 

## What to do next

At this point, incoming messages that match the user list for the engineering policy will not have MP3 attachments stripped; however, all other incoming messages will have MP3 attachments stripped.

## Notes on Configuring Content Filters in the GUI

- It is not necessary to specify a condition when creating a content filter. When no action is defined, any actions defined will always apply in the rule. (Specifying no action is equivalent to using the true() message filter rule — all messages will be matched if the content filter is applied to a policy.)
  - If you do not assign a custom user role to a content filter, the content filter is public and can be used by any delegated administrator for their mail policies. See [Distributing Administrative Tasks, on page 973](#) for more information on delegated administrators and content filters.
  - Administrators and operators can view and edit all content filters on an email gateway, even when the content filters are assigned to custom user roles.
  - When entering text for filter rules and actions, the following meta characters have special meaning in regular expression matching: . ^ \$ \* + ? { [ ] \ | ( )
- If you do not wish to use regular expression you should use a '\' (backslash) to escape any of these characters. For example: "\"\*Warning\"\*"
- When you define more than one Condition for a content filter, you can define whether *all* of the defined actions (that is, a logical AND) or any of the defined actions (logical OR) need to apply in order for the content filter to be considered a match.
  - You can test message splintering and content filters by creating “benign” content filters. For example, it is possible to create a content filter whose only action is “deliver.” This content filter will not affect mail processing; however, you can use this filter to test how the mail policy processing affects other elements in the system (for example, the mail logs).
  - Conversely, using the “primary list” concept of the Incoming or Outgoing Content Filters, it is possible to create very powerful, wide-sweeping content filters that will immediately affect message processing for all mail handled by the email gateway. The process for this is to:

- Use the Incoming or Outgoing Content Filters page to create a new content filter whose order is 1.
  - Use the Incoming or Outgoing Mail Policies page to enable the new content filter for the default policy.
  - Enable the content filter for all remaining policies.
- The Bcc: and Quarantine actions available in Content Filters can help you determine the retention settings of quarantines you create. (See [Policy, Virus, and Outbreak Quarantines, on page 923](#)) You can create filters that would simulate mail flow into and out of your policy quarantines so that messages are not released too quickly from the system (that is, the quarantine areas do not fill their allotted disk space too quickly).
  - Because it uses the same settings as the Scan Behavior page or the scanconfig command, the “Entire Message” condition does not scan a message’s headers; choosing the “Entire Message” will scan only the message body and attachments. Use the “Subject” or “Header” conditions to search for specific header information.
  - Configuring users by LDAP query will only appear in the GUI if you have LDAP servers configured on the email gateway (that is, you have configured the email gateway to query specific LDAP servers with specific strings using the ldapconfig command).
  - Some sections of the content filter rule builder will not appear in the GUI if the resource has not been preconfigured. For example, notification templates and message disclaimers will not appear as options if they have not been configured previously using the Text Resources page or the textconfig command in the CLI.
  - Content filters features will recognize, can contain, and/or scan for text in the following character encodings:
    - Unicode (UTF-8)
    - Unicode (UTF-16)
    - Western European/Latin-1 (ISO 8859-1)
    - Western European/Latin-1 (Windows CP1252)
    - Traditional Chinese (Big 5)
    - Simplified Chinese (GB 2312)
    - Simplified Chinese (HZ GB 2312)
    - Korean (ISO 2022-KR)
    - Korean (KS-C-5601/EUC-KR)
    - Japanese (Shift-JIS (X0123))
    - Japanese (ISO-2022-JP)
    - Japanese (EUC)

You can mix and match multiple character sets within a single content filter. Refer to your web browser’s documentation for help displaying and entering text in multiple character encodings. Most browsers can render multiple character sets simultaneously.

**Figure 99: Multiple Character Sets in a Content Filter**





- On the Incoming or Outgoing Content Filters summary pages, use the links for “Description,” “Rules,” and “Policies” to change the view presented for the content filters:
  - The **Description** view shows the text you entered in the description field for each content filter. (This is the default view.)
  - The **Rules** view shows the rules and regular expressions build by the rule builder page.
  - The **Policies** shows the policies for which each content filter is enabled.





## APPENDIX **D**

# Firewall Information

This chapter contains the following sections:

- [Firewall Information, on page 1331](#)
- [Protecting Email Gateway from Network Attacks, on page 1335](#)

## Firewall Information

The following table lists the possible ports that may need to be opened for proper operation of Cisco Secure Email Gateway (these are the default values).

**Table 166: Firewall Ports**

Default Port	Protocol	In/Out	Hostname	Purpose
20/21	TCP	In or out	AsyncOS IPs, FTP server	FTP for aggregation of log files. Data ports TCP 1024 and higher must also all be open. For more information, search for FTP port information in the Knowledge Base. See <a href="#">Knowledge Base, on page 5</a> .
22	TCP	In	AsyncOS IPs	SSH access to the CLI, aggregation of log files.
22	TCP	Out	SSH Server	SSH aggregation of log files.
22	TCP	Out	SCP server	SCP push to log server.
25	TCP	Out	Any	SMTP to send email.
25	TCP	In	AsyncOS IPs	SMTP to receive bounced email or if injecting email from outside firewall.

53	UDP/TCP	Out	DNS servers	DNS if configured to use Internet root servers or other DNS servers outside the firewall. Also for SenderBase queries.
80	HTTP	In	AsyncOS IPs	HTTP access to the GUI for system monitoring.
80	HTTP	Out	downloads.ironport.com	and McAfee definitions.
80	HTTP	Out	updates.ironport.com	AsyncOS upgrades and McAfee definitions.
80	HTTP	Out	TAXII servers	Used to allow your email gateway to consume external threat feeds.
82	HTTP	In	AsyncOS IPs	Used for viewing the spam quarantine.
83	HTTPS	In	AsyncOS IPs	Used for viewing the spam quarantine.
110	TCP	Out	POP server	POP authentication for end users for spam quarantine.
123	UDP	In & Out	NTP server	NTP if time servers are outside firewall.
143	TCP	Out	IMAP server	IMAP authentication for end users for spam quarantine.
161	UDP	In	AsyncOS IPs	SNMP Queries.
162	UDP	Out	Management station	SNMP Traps.
389 or 3268	LDAP	Out	LDAP servers	LDAP if LDAP directory servers are outside firewall. LDAP authentication for Cisco Spam Quarantine.
636 or 3269	LDAPS	Out	LDAPS	LDAPS — ActiveDirectory's global catalog server (uses SSL).
443	TCP	In	AsyncOS IPs	Secure HTTP ( https ) access to the GUI for system monitoring.
443	TCP	Out	res.cisco.com	Verify the latest files for the update server.
443	TCP	Out	update-manifests.ironport.com	Obtain the list of the latest files from the update server (for physical hardware email gateways.)

443	TCP	Out	update-manifests.sco.cisco.com	Obtain the list of the latest files from the update server (for virtual email gateways.)
443	TCP	Out	serviceconfig.talos.cisco.com grpc.talos.cisco.com email-sender-ip-rep-grpc.talos.cisco.com For IP -based firewall: 146.112.62.0/24 146.112.63.0/24 146.112.255.0/24 146.112.59.0/24 2a04:e4c7:ffff::/48 2a04:e4c7:fffe::/48	Cisco Talos Intelligence Services - to obtain IP reputation, URL reputation and category, and to send Service Logs details.
443	TCP	Out	kinesis.us-west-2.amazonaws.com sensor-provisioner.ep.prod .agari.com houston.sensor.prod.agari.com	Register and send header details to Cisco Advanced Phishing Protection cloud service.
443	TCP	Out	As configured in Security Services > File Reputation and Analysis, Advanced Settings for File Reputation section, Cloud Server Pool parameter.	If configured, the port for access to cloud services for obtaining file reputation. The default port is 32137. For file analysis services, see port 443.
443	TCP	Out	As configured in Security Services > File Reputation and Analysis, Advanced Settings for File Analysis section.	Access to cloud services for file analysis. For file reputation services, see port 443 or 32137.
443	TCP	In & Out	As configured in Security Services > File Reputation and Analysis, Advanced Settings for File Reputation section, AMP for Endpoints Console Integration parameter. api.amp.sourcefire.com api.eu.amp.sourcefire.com api.apjc.amp.sourcefire.com api.amp.cisco.com api.eu.amp.cisco.com api.apjc.amp.cisco.com	Access to AMP for Endpoints console servers.

443	TCP	In & Out	outlook.office365.com login.microsoftonline.com.	Access to Office 365 services for mailbox auto remediation.
443	TCP	In & Out	Hostname of the Microsoft On-premise exchange server	Access to Microsoft On-premise exchange servers for remedating messages from the mailbox.
443	TCP	Out	aggregator.cisco.com	Access to the Cisco Aggregator server.
443	HTTPS	Out	logapi.ces.cisco.com	To upload the debug logs that are collected by Cisco TAC.
443	HTTPS	Out	TAXII servers	Used to allow your email gateway to consume external threat feeds.
443	HTTPS	In and Out	api-sse.cisco.com	Used to register your email gateway with Cisco SecureX or Cisco Threat Response.
443	HTTPS	In and Out	api.eu.sse.itd.cisco.com	Used to register your email gateway with Cisco SecureX or Cisco Threat Response.
443	HTTPS	In and Out	api.apj.sse.itd.cisco.com	Used to register your email gateway with Cisco SecureX or Cisco Threat Response.
443	HTTPS	In and Out	est.sco.cisco.com	Used to download a certificate to verify whether your email gateway is accessing a verified site when registering to Cisco SecureX or Cisco Threat Response.
443	HTTPS	In and Out	AsyncOS IPs	HTTPS access to the GUI using <code>trailblazerconfig</code> CLI command.
514	UDP/TCP	Out	Syslog server	Syslog logging.
628	TCP	In & In	AsyncOS IPs	QMQP if injecting email from outside firewall.
990	TCP/FTP	Out	support-ftp.cisco.com	To upload the debug logs that are collected by Cisco TAC.
1024 and higher	—	—	—	See information above for Port 21 (FTP.)
2222	CCS	In & In	AsyncOS IPs	Cluster Communication Service (for Centralized Management).

	TCP	Out	AsyncOS IPs	Cisco Spam Quarantine.
7025	TCP	In and out	AsyncOS IPs	Pass policy, virus, and outbreak quarantine data between Cisco Secure Email Gateways and Cisco Secure Manager Email and Web Gateways when this feature is centralized.
6080	HTTP	In or Out	AsyncOS IPs	Access to API ports for HTTP Server
6443	HTTPS	In or Out	AsyncOS IPs	Access to API ports for HTTPS Server

## Protecting Email Gateway from Network Attacks

Make sure that you perform the following prerequisites to protect your email gateway from network attacks:

- Do not expose port 22 (SSH) to your email gateway external IP address.
- Enable only specific IP addresses to manage your email gateway using the web interface and CLI configuration settings.
- [If required] Enable Host Header protection using the `adminaccessconfig` CLI command.
- Enable Cross Scripting protection using the `adminaccessconfig` CLI command.
- Do not configure a Relay rule on a public listener.



---

**Note** If you require a relay rule on an external listener, configure 'SMTP AUTH' on a normal public listener.

---







## APPENDIX **E**

# End User License Agreement

---

This appendix contains the following sections:

- [Cisco Systems End User License Agreement](#) , on page 1337
- [Supplemental End User License Agreement for Cisco Systems Content Security Software](#) , on page 1343

## Cisco Systems End User License Agreement

**IMPORTANT: PLEASE READ THIS END USER LICENSE AGREEMENT CAREFULLY. IT IS VERY IMPORTANT THAT YOU CHECK THAT YOU ARE PURCHASING CISCO SOFTWARE OR EQUIPMENT FROM AN APPROVED SOURCE AND THAT YOU, OR THE ENTITY YOU REPRESENT (COLLECTIVELY, THE "CUSTOMER") HAVE BEEN REGISTERED AS THE END USER FOR THE PURPOSES OF THIS CISCO END USER LICENSE AGREEMENT. IF YOU ARE NOT REGISTERED AS THE END USER YOU HAVE NO LICENSE TO USE THE SOFTWARE AND THE LIMITED WARRANTY IN THIS END USER LICENSE AGREEMENT DOES NOT APPLY. ASSUMING YOU HAVE PURCHASED FROM AN APPROVED SOURCE, DOWNLOADING, INSTALLING OR USING CISCO OR CISCO-SUPPLIED SOFTWARE CONSTITUTES ACCEPTANCE OF THIS AGREEMENT.**

CISCO SYSTEMS, INC. OR ITS SUBSIDIARY LICENSING THE SOFTWARE INSTEAD OF CISCO SYSTEMS, INC. ("CISCO") IS WILLING TO LICENSE THIS SOFTWARE TO YOU ONLY UPON THE CONDITION THAT YOU PURCHASED THE SOFTWARE FROM AN APPROVED SOURCE AND THAT YOU ACCEPT ALL OF THE TERMS CONTAINED IN THIS END USER LICENSE AGREEMENT PLUS ANY ADDITIONAL LIMITATIONS ON THE LICENSE SET FORTH IN A SUPPLEMENTAL LICENSE AGREEMENT ACCOMPANYING THE PRODUCT OR AVAILABLE AT THE TIME OF YOUR ORDER (COLLECTIVELY THE "AGREEMENT"). TO THE EXTENT OF ANY CONFLICT BETWEEN THE TERMS OF THIS END USER LICENSE AGREEMENT AND ANY SUPPLEMENTAL LICENSE AGREEMENT, THE SUPPLEMENTAL LICENSE AGREEMENT SHALL APPLY. BY DOWNLOADING, INSTALLING, OR USING THE SOFTWARE, YOU ARE REPRESENTING THAT YOU PURCHASED THE SOFTWARE FROM AN APPROVED SOURCE AND BINDING YOURSELF TO THE AGREEMENT. IF YOU DO NOT AGREE TO ALL OF THE TERMS OF THE AGREEMENT, THEN CISCO IS UNWILLING TO LICENSE THE SOFTWARE TO YOU AND (A) YOU MAY NOT DOWNLOAD, INSTALL OR USE THE SOFTWARE, AND (B) YOU MAY RETURN THE SOFTWARE (INCLUDING ANY UNOPENED CD PACKAGE AND ANY WRITTEN MATERIALS) FOR A FULL REFUND, OR, IF THE SOFTWARE AND WRITTEN MATERIALS ARE SUPPLIED AS PART OF ANOTHER PRODUCT, YOU MAY RETURN THE ENTIRE PRODUCT FOR A FULL REFUND. YOUR RIGHT TO RETURN AND REFUND EXPIRES 30 DAYS AFTER PURCHASE FROM AN APPROVED SOURCE, AND APPLIES ONLY IF YOU ARE THE ORIGINAL AND REGISTERED END USER

PURCHASER. FOR THE PURPOSES OF THIS END USER LICENSE AGREEMENT, AN "APPROVED SOURCE" MEANS (A) CISCO; OR (B) A DISTRIBUTOR OR SYSTEMS INTEGRATOR AUTHORIZED BY CISCO TO DISTRIBUTE / SELL CISCO EQUIPMENT, SOFTWARE AND SERVICES WITHIN YOUR TERRITORY TO END USERS; OR (C) A RESELLER AUTHORIZED BY ANY SUCH DISTRIBUTOR OR SYSTEMS INTEGRATOR IN ACCORDANCE WITH THE TERMS OF THE DISTRIBUTOR'S AGREEMENT WITH CISCO TO DISTRIBUTE / SELL THE CISCO EQUIPMENT, SOFTWARE AND SERVICES WITHIN YOUR TERRITORY TO END USERS.

*THE FOLLOWING TERMS OF THE AGREEMENT GOVERN CUSTOMER'S USE OF THE SOFTWARE (DEFINED BELOW), EXCEPT TO THE EXTENT: (A) THERE IS A SEPARATE SIGNED CONTRACT BETWEEN CUSTOMER AND CISCO GOVERNING CUSTOMER'S USE OF THE SOFTWARE, OR (B) THE SOFTWARE INCLUDES A SEPARATE "CLICK-ACCEPT" LICENSE AGREEMENT OR THIRD PARTY LICENSE AGREEMENT AS PART OF THE INSTALLATION OR DOWNLOAD PROCESS GOVERNING CUSTOMER'S USE OF THE SOFTWARE. TO THE EXTENT OF A CONFLICT BETWEEN THE PROVISIONS OF THE FOREGOING DOCUMENTS, THE ORDER OF PRECEDENCE SHALL BE (1) THE SIGNED CONTRACT, (2) THE CLICK-ACCEPT AGREEMENT OR THIRD PARTY LICENSE AGREEMENT, AND (3) THE AGREEMENT. FOR PURPOSES OF THE AGREEMENT, "SOFTWARE" SHALL MEAN COMPUTER PROGRAMS, INCLUDING FIRMWARE AND COMPUTER PROGRAMS EMBEDDED IN CISCO EQUIPMENT, AS PROVIDED TO CUSTOMER BY AN APPROVED SOURCE, AND ANY UPGRADES, UPDATES, BUG FIXES OR MODIFIED VERSIONS THERETO (COLLECTIVELY, "UPGRADES"), ANY OF THE SAME WHICH HAS BEEN RELICENSED UNDER THE CISCO SOFTWARE TRANSFER AND RE-LICENSING POLICY (AS MAY BE AMENDED BY CISCO FROM TIME TO TIME) OR BACKUP COPIES OF ANY OF THE FOREGOING.*

**License.** Conditioned upon compliance with the terms and conditions of the Agreement, Cisco grants to Customer a nonexclusive and nontransferable license to use for Customer's internal business purposes the Software and the Documentation for which Customer has paid the required license fees to an Approved Source. "Documentation" means written information (whether contained in user or technical manuals, training materials, specifications or otherwise) pertaining to the Software and made available by an Approved Source with the Software in any manner (including on CD-Rom, or on-line). In order to use the Software, Customer may be required to input a registration number or product authorization key and register Customer's copy of the Software online at Cisco's website to obtain the necessary license key or license file.

Customer's license to use the Software shall be limited to, and Customer shall not use the Software in excess of, a single hardware chassis or card or such other limitations as are set forth in the applicable Supplemental License Agreement or in the applicable purchase order which has been accepted by an Approved Source and for which Customer has paid to an Approved Source the required license fee (the "Purchase Order").

Unless otherwise expressly provided in the Documentation or any applicable Supplemental License Agreement, Customer shall use the Software solely as embedded in, for execution on, or (where the applicable Documentation permits installation on non-Cisco equipment) for communication with Cisco equipment owned or leased by Customer and used for Customer's internal business purposes. No other licenses are granted by implication, estoppel or otherwise.

For evaluation or beta copies for which Cisco does not charge a license fee, the above requirement to pay license fees does not apply.

*General Limitations.* This is a license, not a transfer of title, to the Software and Documentation, and Cisco retains ownership of all copies of the Software and Documentation. Customer acknowledges that the Software and Documentation contain trade secrets of Cisco or its suppliers or licensors, including but not limited to the specific internal design and structure of individual programs and associated interface information. Except as otherwise expressly provided under the Agreement, Customer shall only use the Software in connection with the use of Cisco equipment purchased by the Customer from an Approved Source and Customer shall have no right, and Customer specifically agrees not to:

- (i) transfer, assign or sublicense its license rights to any other person or entity (other than in compliance with any Cisco relicensing/transfer policy then in force), or use the Software on Cisco equipment not purchased by the Customer from an Approved Source or on secondhand Cisco equipment, and Customer acknowledges that any attempted transfer, assignment, sublicense or use shall be void;
- (ii) make error corrections to or otherwise modify or adapt the Software or create derivative works based upon the Software, or permit third parties to do the same;
- (iii) reverse engineer or decompile, decrypt, disassemble or otherwise reduce the Software to human-readable form, except to the extent otherwise expressly permitted under applicable law notwithstanding this restriction or except to the extent that Cisco is legally required to permit such specific activity pursuant to any applicable open source license;
- (iv) publish any results of benchmark tests run on the Software;
- (v) use or permit the Software to be used to perform services for third parties, whether on a service bureau or time sharing basis or otherwise, without the express written authorization of Cisco; or
- (vi) disclose, provide, or otherwise make available trade secrets contained within the Software and Documentation in any form to any third party without the prior written consent of Cisco. Customer shall implement reasonable security measures to protect such trade secrets.

To the extent required by applicable law, and at Customer's written request, Cisco shall provide Customer with the interface information needed to achieve interoperability between the Software and another independently created program, on payment of Cisco's applicable fee, if any. Customer shall observe strict obligations of confidentiality with respect to such information and shall use such information in compliance with any applicable terms and conditions upon which Cisco makes such information available.

**Software, Upgrades and Additional Copies.** NOTWITHSTANDING ANY OTHER PROVISION OF THE AGREEMENT: (1) CUSTOMER HAS NO LICENSE OR RIGHT TO MAKE OR USE ANY ADDITIONAL COPIES OR UPGRADES UNLESS CUSTOMER, AT THE TIME OF MAKING OR ACQUIRING SUCH COPY OR UPGRADE, ALREADY HOLDS A VALID LICENSE TO THE ORIGINAL SOFTWARE AND HAS PAID THE APPLICABLE FEE TO AN APPROVED SOURCE FOR THE UPGRADE OR ADDITIONAL COPIES; (2) USE OF UPGRADES IS LIMITED TO CISCO EQUIPMENT SUPPLIED BY AN APPROVED SOURCE FOR WHICH CUSTOMER IS THE ORIGINAL END USER PURCHASER OR LESSEE OR OTHERWISE HOLDS A VALID LICENSE TO USE THE SOFTWARE WHICH IS BEING UPGRADED; AND (3) THE MAKING AND USE OF ADDITIONAL COPIES IS LIMITED TO NECESSARY BACKUP PURPOSES ONLY.

*Proprietary Notices.* Customer agrees to maintain and reproduce all copyright, proprietary, and other notices on all copies, in any form, of the Software in the same form and manner that such copyright and other proprietary notices are included on the Software. Except as expressly authorized in the Agreement, Customer shall not make any copies or duplicates of any Software without the prior written permission of Cisco.

*Term and Termination.* The Agreement and the license granted herein shall remain effective until terminated. Customer may terminate the Agreement and the license at any time by destroying all copies of Software and any Documentation. Customer's rights under the Agreement will terminate immediately without notice from Cisco if Customer fails to comply with any provision of the Agreement. Upon termination, Customer shall destroy all copies of Software and Documentation in its possession or control. All confidentiality obligations of Customer, all restrictions and limitations imposed on the Customer under the section titled "General Limitations" and all limitations of liability and disclaimers and restrictions of warranty shall survive termination of this Agreement. In addition, the provisions of the sections titled "U.S. Government End User Purchasers" and "General Terms Applicable to the Limited Warranty Statement and End User License Agreement" shall survive termination of the Agreement.

*Customer Records.* Customer grants to Cisco and its independent accountants the right to examine Customer's books, records and accounts during Customer's normal business hours to verify compliance with this Agreement. In the event such audit discloses non-compliance with this Agreement, Customer shall promptly pay to Cisco the appropriate license fees, plus the reasonable cost of conducting the audit.

*Export, Re-Export, Transfer and Use Controls.* The Software, Documentation and technology or direct products thereof (hereafter referred to as Software and Technology), supplied by Cisco under the Agreement are subject to export controls under the laws and regulations of the United States (U.S.) and any other applicable countries' laws and regulations. Customer shall comply with such laws and regulations governing export, re-export, transfer and use of Cisco Software and Technology and will obtain all required U.S. and local authorizations, permits, or licenses. Cisco and Customer each agree to provide the other information, support documents, and assistance as may reasonably be required by the other in connection with securing authorizations or licenses. Information regarding compliance with export, re-export, transfer and use may be located at the following URL:

[https://www.cisco.com/web/about/doing\\_business/legal/global\\_export\\_trade/general\\_export/contract\\_compliance.html](https://www.cisco.com/web/about/doing_business/legal/global_export_trade/general_export/contract_compliance.html)

*U.S. Government End User Purchasers.* The Software and Documentation qualify as "commercial items," as that term is defined at Federal Acquisition Regulation ("FAR") (48 C.F.R.) 2.101, consisting of "commercial computer software" and "commercial computer software documentation" as such terms are used in FAR 12.212. Consistent with FAR 12.212 and DoD FAR Supp. 227.7202-1 through 227.7202-4, and notwithstanding any other FAR or other contractual clause to the contrary in any agreement into which the Agreement may be incorporated, Customer may provide to Government end user or, if the Agreement is direct, Government end user will acquire, the Software and Documentation with only those rights set forth in the Agreement. Use of either the Software or Documentation or both constitutes agreement by the Government that the Software and Documentation are "commercial computer software" and "commercial computer software documentation," and constitutes acceptance of the rights and restrictions herein.

*Identified Components; Additional Terms.* The Software may contain or be delivered with one or more components, which may include third-party components, identified by Cisco in the Documentation, readme.txt file, third-party click-accept or elsewhere (e.g. on <https://www.cisco.com/>) (the "Identified Component(s)") as being subject to different license agreement terms, disclaimers of warranties, limited warranties or other terms and conditions (collectively, "Additional Terms") than those set forth herein. You agree to the applicable Additional Terms for any such Identified Component(s)."

### **Limited Warranty**

Subject to the limitations and conditions set forth herein, Cisco warrants that commencing from the date of shipment to Customer (but in case of resale by an Approved Source other than Cisco, commencing not more than ninety (90) days after original shipment by Cisco), and continuing for a period of the longer of (a) ninety (90) days or (b) the warranty period (if any) expressly set forth as applicable specifically to software in the warranty card accompanying the product of which the Software is a part (the "Product") (if any): (a) the media on which the Software is furnished will be free of defects in materials and workmanship under normal use; and (b) the Software substantially conforms to the Documentation. The date of shipment of a Product by Cisco is set forth on the packaging material in which the Product is shipped. Except for the foregoing, the Software is provided "AS IS". This limited warranty extends only to the Software purchased from an Approved Source by a Customer who is the first registered end user. Customer's sole and exclusive remedy and the entire liability of Cisco and its suppliers under this limited warranty will be (i) replacement of defective media and/or (ii) at Cisco's option, repair, replacement, or refund of the purchase price of the Software, in both cases subject to the condition that any error or defect constituting a breach of this limited warranty is reported to the Approved Source supplying the Software to Customer, within the warranty period. Cisco or the Approved Source supplying the Software to Customer may, at its option, require return of the Software and/or Documentation as a condition to the remedy. In no event does Cisco warrant that the Software is error free or that Customer

will be able to operate the Software without problems or interruptions. In addition, due to the continual development of new techniques for intruding upon and attacking networks, Cisco does not warrant that the Software or any equipment, system or network on which the Software is used will be free of vulnerability to intrusion or attack.

*Restrictions.* This warranty does not apply if the Software, Product or any other equipment upon which the Software is authorized to be used (a) has been altered, except by Cisco or its authorized representative, (b) has not been installed, operated, repaired, or maintained in accordance with instructions supplied by Cisco, (c) has been subjected to abnormal physical or electrical stress, abnormal environmental conditions, misuse, negligence, or accident; or (d) is licensed for beta, evaluation, testing or demonstration purposes. The Software warranty also does not apply to (e) any temporary Software modules; (f) any Software not posted on Cisco's Software Center; (g) any Software that Cisco expressly provides on an "AS IS" basis on Cisco's Software Center; (h) any Software for which an Approved Source does not receive a license fee; and (i) Software supplied by any third party which is not an Approved Source.

### **DISCLAIMER OF WARRANTY**

**EXCEPT AS SPECIFIED IN THIS WARRANTY SECTION, ALL EXPRESS OR IMPLIED CONDITIONS, REPRESENTATIONS, AND WARRANTIES INCLUDING, WITHOUT LIMITATION, ANY IMPLIED WARRANTY OR CONDITION OF MERCHANTABILITY, FITNESS FOR A PARTICULAR PURPOSE, NON-INFRINGEMENT, SATISFACTORY QUALITY, NON-INTERFERENCE, ACCURACY OF INFORMATIONAL CONTENT, OR ARISING FROM A COURSE OF DEALING, LAW, USAGE, OR TRADE PRACTICE, ARE HEREBY EXCLUDED TO THE EXTENT ALLOWED BY APPLICABLE LAW AND ARE EXPRESSLY DISCLAIMED BY CISCO, ITS SUPPLIERS AND LICENSORS. TO THE EXTENT THAT ANY OF THE SAME CANNOT BE EXCLUDED, SUCH IMPLIED CONDITION, REPRESENTATION AND/OR WARRANTY IS LIMITED IN DURATION TO THE EXPRESS WARRANTY PERIOD REFERRED TO IN THE "LIMITED WARRANTY" SECTION ABOVE. BECAUSE SOME STATES OR JURISDICTIONS DO NOT ALLOW LIMITATIONS ON HOW LONG AN IMPLIED WARRANTY LASTS, THE ABOVE LIMITATION MAY NOT APPLY IN SUCH STATES. THIS WARRANTY GIVES CUSTOMER SPECIFIC LEGAL RIGHTS, AND CUSTOMER MAY ALSO HAVE OTHER RIGHTS WHICH VARY FROM JURISDICTION TO JURISDICTION.** This disclaimer and exclusion shall apply even if the express warranty set forth above fails of its essential purpose.

*Disclaimer of Liabilities - Limitation of Liability.* IF YOU ACQUIRED THE SOFTWARE IN THE UNITED STATES, LATIN AMERICA, CANADA, JAPAN OR THE CARIBBEAN, NOTWITHSTANDING ANYTHING ELSE IN THE AGREEMENT TO THE CONTRARY, ALL LIABILITY OF CISCO, ITS AFFILIATES, OFFICERS, DIRECTORS, EMPLOYEES, AGENTS, SUPPLIERS AND LICENSORS COLLECTIVELY, TO CUSTOMER, WHETHER IN CONTRACT, TORT (INCLUDING NEGLIGENCE), BREACH OF WARRANTY OR OTHERWISE, SHALL NOT EXCEED THE PRICE PAID BY CUSTOMER TO ANY APPROVED SOURCE FOR THE SOFTWARE THAT GAVE RISE TO THE CLAIM OR IF THE SOFTWARE IS PART OF ANOTHER PRODUCT, THE PRICE PAID FOR SUCH OTHER PRODUCT. THIS LIMITATION OF LIABILITY FOR SOFTWARE IS CUMULATIVE AND NOT PER INCIDENT (I.E. THE EXISTENCE OF TWO OR MORE CLAIMS WILL NOT ENLARGE THIS LIMIT).

IF YOU ACQUIRED THE SOFTWARE IN EUROPE, THE MIDDLE EAST, AFRICA, ASIA OR OCEANIA, NOTWITHSTANDING ANYTHING ELSE IN THE AGREEMENT TO THE CONTRARY, ALL LIABILITY OF CISCO, ITS AFFILIATES, OFFICERS, DIRECTORS, EMPLOYEES, AGENTS, SUPPLIERS AND LICENSORS COLLECTIVELY, TO CUSTOMER, WHETHER IN CONTRACT, TORT (INCLUDING NEGLIGENCE), BREACH OF WARRANTY OR OTHERWISE, SHALL NOT EXCEED THE PRICE PAID BY CUSTOMER TO CISCO FOR THE SOFTWARE THAT GAVE RISE TO THE CLAIM OR IF THE SOFTWARE IS PART OF ANOTHER PRODUCT, THE PRICE PAID FOR SUCH OTHER PRODUCT. THIS LIMITATION OF LIABILITY FOR SOFTWARE IS CUMULATIVE AND NOT PER INCIDENT

(I.E. THE EXISTENCE OF TWO OR MORE CLAIMS WILL NOT ENLARGE THIS LIMIT). NOTHING IN THE AGREEMENT SHALL LIMIT (I) THE LIABILITY OF CISCO, ITS AFFILIATES, OFFICERS, DIRECTORS, EMPLOYEES, AGENTS, SUPPLIERS AND LICENSORS TO CUSTOMER FOR PERSONAL INJURY OR DEATH CAUSED BY THEIR NEGLIGENCE, (II) CISCO'S LIABILITY FOR FRAUDULENT MISREPRESENTATION, OR (III) ANY LIABILITY OF CISCO WHICH CANNOT BE EXCLUDED UNDER APPLICABLE LAW.

*Disclaimer of Liabilities - Waiver of Consequential Damages and Other Losses.* IF YOU ACQUIRED THE SOFTWARE IN THE UNITED STATES, LATIN AMERICA, THE CARIBBEAN OR CANADA, REGARDLESS OF WHETHER ANY REMEDY SET FORTH HEREIN FAILS OF ITS ESSENTIAL PURPOSE OR OTHERWISE, IN NO EVENT WILL CISCO OR ITS SUPPLIERS BE LIABLE FOR ANY LOST REVENUE, PROFIT, OR LOST OR DAMAGED DATA, BUSINESS INTERRUPTION, LOSS OF CAPITAL, OR FOR SPECIAL, INDIRECT, CONSEQUENTIAL, INCIDENTAL, OR PUNITIVE DAMAGES HOWEVER CAUSED AND REGARDLESS OF THE THEORY OF LIABILITY OR WHETHER ARISING OUT OF THE USE OF OR INABILITY TO USE SOFTWARE OR OTHERWISE AND EVEN IF CISCO OR ITS SUPPLIERS OR LICENSORS HAVE BEEN ADVISED OF THE POSSIBILITY OF SUCH DAMAGES. BECAUSE SOME STATES OR JURISDICTIONS DO NOT ALLOW LIMITATION OR EXCLUSION OF CONSEQUENTIAL OR INCIDENTAL DAMAGES, THE ABOVE LIMITATION MAY NOT APPLY TO YOU.

IF YOU ACQUIRED THE SOFTWARE IN JAPAN, EXCEPT FOR LIABILITY ARISING OUT OF OR IN CONNECTION WITH DEATH OR PERSONAL INJURY, FRAUDULENT MISREPRESENTATION, AND REGARDLESS OF WHETHER ANY REMEDY SET FORTH HEREIN FAILS OF ITS ESSENTIAL PURPOSE OR OTHERWISE, IN NO EVENT WILL CISCO, ITS AFFILIATES, OFFICERS, DIRECTORS, EMPLOYEES, AGENTS, SUPPLIERS AND LICENSORS BE LIABLE FOR ANY LOST REVENUE, PROFIT, OR LOST OR DAMAGED DATA, BUSINESS INTERRUPTION, LOSS OF CAPITAL, OR FOR SPECIAL, INDIRECT, CONSEQUENTIAL, INCIDENTAL, OR PUNITIVE DAMAGES HOWEVER CAUSED AND REGARDLESS OF THE THEORY OF LIABILITY OR WHETHER ARISING OUT OF THE USE OF OR INABILITY TO USE SOFTWARE OR OTHERWISE AND EVEN IF CISCO OR ANY APPROVED SOURCE OR THEIR SUPPLIERS OR LICENSORS HAVE BEEN ADVISED OF THE POSSIBILITY OF SUCH DAMAGES.

IF YOU ACQUIRED THE SOFTWARE IN EUROPE, THE MIDDLE EAST, AFRICA, ASIA OR OCEANIA, IN NO EVENT WILL CISCO, ITS AFFILIATES, OFFICERS, DIRECTORS, EMPLOYEES, AGENTS, SUPPLIERS AND LICENSORS, BE LIABLE FOR ANY LOST REVENUE, LOST PROFIT, OR LOST OR DAMAGED DATA, BUSINESS INTERRUPTION, LOSS OF CAPITAL, OR FOR SPECIAL, INDIRECT, CONSEQUENTIAL, INCIDENTAL, OR PUNITIVE DAMAGES, HOWSOEVER ARISING, INCLUDING, WITHOUT LIMITATION, IN CONTRACT, TORT (INCLUDING NEGLIGENCE) OR WHETHER ARISING OUT OF THE USE OF OR INABILITY TO USE THE SOFTWARE, EVEN IF, IN EACH CASE, CISCO, ITS AFFILIATES, OFFICERS, DIRECTORS, EMPLOYEES, AGENTS, SUPPLIERS AND LICENSORS, HAVE BEEN ADVISED OF THE POSSIBILITY OF SUCH DAMAGES. BECAUSE SOME STATES OR JURISDICTIONS DO NOT ALLOW LIMITATION OR EXCLUSION OF CONSEQUENTIAL OR INCIDENTAL DAMAGES, THE ABOVE LIMITATION MAY NOT FULLY APPLY TO YOU. THE FOREGOING EXCLUSION SHALL NOT APPLY TO ANY LIABILITY ARISING OUT OF OR IN CONNECTION WITH: (I) DEATH OR PERSONAL INJURY, (II) FRAUDULENT MISREPRESENTATION, OR (III) CISCO'S LIABILITY IN CONNECTION WITH ANY TERMS THAT CANNOT BE EXCLUDED UNDER APPLICABLE LAW.

Customer acknowledges and agrees that Cisco has set its prices and entered into the Agreement in reliance upon the disclaimers of warranty and the limitations of liability set forth herein, that the same reflect an allocation of risk between the parties (including the risk that a contract remedy may fail of its essential purpose and cause consequential loss), and that the same form an essential basis of the bargain between the parties.

*Controlling Law, Jurisdiction.* If you acquired, by reference to the address on the purchase order accepted by the Approved Source, the Software in the United States, Latin America, or the Caribbean, the Agreement and warranties ("Warranties") are controlled by and construed under the laws of the State of California, United States of America, notwithstanding any conflicts of law provisions; and the state and federal courts of California shall have exclusive jurisdiction over any claim arising under the Agreement or Warranties. If you acquired the Software in Canada, unless expressly prohibited by local law, the Agreement and Warranties are controlled by and construed under the laws of the Province of Ontario, Canada, notwithstanding any conflicts of law provisions; and the courts of the Province of Ontario shall have exclusive jurisdiction over any claim arising under the Agreement or Warranties. If you acquired the Software in Europe, the Middle East, Africa, Asia or Oceania (excluding Australia), unless expressly prohibited by local law, the Agreement and Warranties are controlled by and construed under the laws of England, notwithstanding any conflicts of law provisions; and the English courts shall have exclusive jurisdiction over any claim arising under the Agreement or Warranties. In addition, if the Agreement is controlled by the laws of England, no person who is not a party to the Agreement shall be entitled to enforce or take the benefit of any of its terms under the Contracts (Rights of Third Parties) Act 1999. If you acquired the Software in Japan, unless expressly prohibited by local law, the Agreement and Warranties are controlled by and construed under the laws of Japan, notwithstanding any conflicts of law provisions; and the Tokyo District Court of Japan shall have exclusive jurisdiction over any claim arising under the Agreement or Warranties. If you acquired the Software in Australia, unless expressly prohibited by local law, the Agreement and Warranties are controlled by and construed under the laws of the State of New South Wales, Australia, notwithstanding any conflicts of law provisions; and the State and federal courts of New South Wales shall have exclusive jurisdiction over any claim arising under the Agreement or Warranties. If you acquired the Software in any other country, unless expressly prohibited by local law, the Agreement and Warranties are controlled by and construed under the laws of the State of California, United States of America, notwithstanding any conflicts of law provisions; and the state and federal courts of California shall have exclusive jurisdiction over any claim arising under the Agreement or Warranties.

For all countries referred to above, the parties specifically disclaim the application of the UN Convention on Contracts for the International Sale of Goods. Notwithstanding the foregoing, either party may seek interim injunctive relief in any court of appropriate jurisdiction with respect to any alleged breach of such party's intellectual property or proprietary rights. If any portion hereof is found to be void or unenforceable, the remaining provisions of the Agreement and Warranties shall remain in full force and effect. Except as expressly provided herein, the Agreement constitutes the entire agreement between the parties with respect to the license of the Software and Documentation and supersedes any conflicting or additional terms contained in any Purchase Order or elsewhere, all of which terms are excluded. The Agreement has been written in the English language, and the parties agree that the English version will govern.

Product warranty terms and other information applicable to Cisco products are available at the following URL:

<http://www.cisco.com/go/warranty>

## Supplemental End User License Agreement for Cisco Systems Content Security Software

### IMPORTANT: READ CAREFULLY

This Supplemental End User License Agreement ("SEULA") contains additional terms and conditions for the Software product licensed under the End User License Agreement ("EULA") between You ("You" as used herein means You and the business entity you represent or "Company") and Cisco (collectively, the "Agreement"). Capitalized terms used in this SEULA but not defined will have the meanings assigned to them

in the EULA. To the extent that there is a conflict between the terms and conditions of the EULA and this SEULA, the terms and conditions of this SEULA will take precedence.

In addition to the limitations set forth in the EULA on your access and use of the Software, you agree to comply at all times with the terms and conditions provided in this SEULA.

DOWNLOADING, INSTALLING, OR USING THE SOFTWARE CONSTITUTES ACCEPTANCE OF THE AGREEMENT, AND YOU ARE BINDING YOURSELF AND THE BUSINESS ENTITY THAT YOU REPRESENT TO THE AGREEMENT. IF YOU DO NOT AGREE TO ALL OF THE TERMS OF THE AGREEMENT, THEN CISCO IS UNWILLING TO LICENSE THE SOFTWARE TO YOU AND (A) YOU MAY NOT DOWNLOAD, INSTALL OR USE THE SOFTWARE, AND (B) YOU MAY RETURN THE SOFTWARE (INCLUDING ANY UNOPENED CD PACKAGE AND ANY WRITTEN MATERIALS) FOR A FULL REFUND, OR, IF THE SOFTWARE AND WRITTEN MATERIALS ARE SUPPLIED AS PART OF ANOTHER PRODUCT, YOU MAY RETURN THE ENTIRE PRODUCT FOR A FULL REFUND. YOUR RIGHT TO RETURN AND REFUND EXPIRES 30 DAYS AFTER PURCHASE FROM CISCO OR AN AUTHORIZED CISCO RESELLER, AND APPLIES ONLY IF YOU ARE THE ORIGINAL END USER PURCHASER.

For purposes of this SEULA, the Product name and the Product description You have ordered is any of the following Cisco Systems Email Security Appliance ("ESA"), Cisco Systems Web Security Appliance and Cisco Systems Security Management Application ("SMA") (collectively, "Content Security") and their Virtual Appliance equivalent ("Software"):

Cisco AsyncOS for Email

Cisco AsyncOS for Web

Cisco AsyncOS for Management

Cisco Email Anti-Spam, Sophos Anti-Virus

Cisco Email Outbreak Filters

Cisco Image Analyzer

McAfee Anti-Virus

Cisco Intelligent Multi-Scan

Cisco Data Loss Prevention

Cisco Email Encryption

Cisco Email Delivery Mode

Cisco Web Usage Controls

Cisco Web Reputation

Sophos Anti-Malware

Webroot Anti-Malware

McAfee Anti-Malware

Cisco Email Reporting

Cisco Email Message Tracking

Cisco Email Centralized Quarantine

Cisco Web Reporting



Cisco Web Policy and Configuration Management  
Cisco Advanced Web Security Management with Splunk  
Email Encryption for Encryption Appliances  
Email Encryption for System Generated Bulk Email  
Email Encryption and Public Key Encryption for Encryption Appliances  
Large Attachment Handling for Encryption Appliances  
Secure Mailbox License for Encryption Appliances

## Definitions

For purposes of this SEULA, the following definitions apply:

"Company Service" means the Company's email, Internet, security management services provided to End Users for the purposes of conducting Company's internal business.

"End User" means: (1) for the Web Security Appliance and SMA, the employee, contractor or other agent authorized by Company to access the Internet and the SMA via the Company Service; and (2) for the ESA, the email boxes of the employees, contractors, or other agent authorized by Company to access or use the email services via the Company Service.

"Ordering Document" means the purchase agreement, evaluation agreement, beta, pre-release agreement or similar agreement between the Company and Cisco or the Company and a Cisco reseller, or the valid terms of any purchase order accepted by Cisco in connection therewith, containing the purchase terms for the Software license granted by this Agreement.

"Personally Identifiable Information" means any information that can be used to identify an individual, including, but not limited to, an individual's name, user name, email address and any other personally identifiable information.

"Server" means a single physical computer or devices on a network that manages or provides network resources for multiple users.

"Services" means Cisco Software Subscription Services.

"Service Description" means the description of the Software Subscription Support Services at <https://www.cisco.com/c/en/us/about/legal/service-descriptions.html>

"Telemetry Data" means samples of Company's email and web traffic, including data on email message and web request attributes and information on how different types of email messages and web requests were handled by Company's Cisco hardware products. Email message metadata and web requests included in Telemetry Data are anonymized and obfuscated to remove any Personally Identifiable Information.

"Term" means the length of the Software subscription You purchased, as indicated in your Ordering Document.

"Virtual Appliance" means the virtual version of Cisco's email security appliances, Web Security Appliance, and security management appliances.

"Virtual Machine" means a software container that can run its own operating system and execute applications like a Server.

## Additional License Terms and Conditions

LICENSE GRANTS AND CONSENT TO TERMS OF DATA COLLECTION

**License of Software.**

By using the Software and the Documentation, Company agrees to be bound by the terms of this Agreement, and so long as Company is in compliance with this Agreement, Cisco hereby grants to Company a nonexclusive, non-sublicensable, non-transferable, worldwide license during the Term to use the Software only on Cisco's hardware products, or in the case of the Virtual Appliances, on a Virtual Machine, solely in connection with the provision of the Company Service to End Users. The number of End Users licensed for the use of the Software is limited to the number of End Users specified in the Ordering Documents. In the event that the number of End Users in connection with the provision of the Company Service exceeds the number of End Users specified in the Ordering Documents, Company shall contact an Approved Source to purchase additional licenses for the Software. The duration and scope of this license(s) is further defined in the Ordering Document. The Ordering Document supersedes the EULA with respect to the term of the Software license. Except for the license rights granted herein, no right, title or interest in any Software is granted to the Company by Cisco, Cisco's resellers or their respective licensors. Your entitlement to Upgrades to the Software is subject to the Service Description. This Agreement and the Services are co-terminus.

#### **Consent and License to Use Data.**

Subject to the Cisco Privacy Statement at <https://www.cisco.com/c/en/us/about/legal/privacy.html>, Company hereby consents and grants to Cisco a license to collect and use Telemetry Data from the Company. Cisco does not collect or use Personally Identifiable Information in the Telemetry Data. Cisco may share aggregated and anonymous Telemetry Data with third parties to assist us in improving your user experience and the Software and other Cisco security products and services. Company may terminate Cisco's right to collect Telemetry Data at any time by disabling Service Logs in the Software. Instructions to enable or disable Service Logs are available in the Software configuration guide.

#### **Description of Other Rights and Obligations**

Please refer to the Cisco Systems, Inc. End User License Agreement, Privacy Statement and Service Description of Software Subscription Support Services.



## INDEX

< [66](#), [1102](#), [1105](#), [1107](#), [1109–1112](#), [1114–1116](#), [1118](#)

\$EnvelopeSender variable [115](#)

\$TRUSTED mail flow policy [372](#)

### A

accepting email [90](#)

access privileges for custom user roles [980](#)

Active Directory Wizard [36](#)

Adaptive Scanning [433](#)

address rewriting [698](#)

address tagging key [742](#)

  purging [742](#)

Advanced Malware Protection [477](#)

alert messages [30](#), [50](#)

alert settings [30](#), [50](#)

alertlisting [1050](#)

alerts [433](#), [1047](#)

  enabling for Outbreak Filters [433](#)

  severities [1047](#)

ALL entry [90–91](#), [122](#)

  in HAT [90–91](#)

  in RAT [122](#)

ALLOWED\_LIST sender group [372](#)

alternate address [361](#)

always rule [428](#)

AMP Archive [1145](#)

AMP Engine Logs [1145](#)

AMP. See Advanced Malware Protection. [477](#)

anti-spam [77](#), [362](#), [382](#), [400–402](#), [418](#)

  HAT parameter [77](#)

  IronPort Anti-Spam [382](#)

  reporting false positives and negatives [402](#)

  scanning appliance-generated messages [401](#)

  selecting a default scanning engine [400](#)

  testing [418](#)

  using multiple scanning engines [362](#)

Anti-Spam Archive Logs [1145](#)

Anti-spam logs [1145](#)

anti-virus [368–372](#), [657](#)

  actions [369](#)

  add custom header [371](#)

  advanced options [369](#)

  archive original message [370](#)

  dropping attachments [368](#)

anti-virus (*continued*)

  Encrypted [368–369](#)

  modify message recipient [371](#)

  modify message subject [370](#)

  scan and repair [368](#)

  scan only [368](#)

  send custom alert notification [372](#)

  send to alternate destination host [371](#)

  sending default notification [371](#)

  Unscannable [369](#)

  Virus Infected [369](#)

Anti-Virus Archive Logs [1145](#)

Anti-Virus Logs [1145](#)

anti-virus quarantine. See quarantine, virus [924](#)

archivemessage command [1118](#)

AsyncOS reversion [1043](#)

AsyncOS upgrades [1038](#)

AutoSupport feature [31](#), [50](#), [1047](#)

### B

Base DN [782](#)

blackhole listener [66](#), [1261](#)

body scanning [160](#)

Bounce Logs [1145](#)

bouncerecipients command [1112](#)

bouncing recipients [1113](#)

  all [1113](#)

  by Envelope From [1113](#)

  by hostname [1113](#)

bypassing [125](#), [208](#)

  anti-spam [208](#)

  throttling [125](#)

### C

call-ahead SMTP server [663](#), [669](#)

  routing [669](#)

CASE (Context Adaptive Scanning Engine [TM]) [415](#)

case-sensitivity [149](#), [782](#), [786](#)

  in LDAP queries [782](#), [786](#)

  in message filters [149](#)

categories [462](#)

  adult [462](#)

  advertisements [462](#)

categories (*continued*)

- alcohol [462](#)
- arts [462](#)
- astrology [462](#)
- auctions [462](#)
- business and industry [462](#)
- chat and instant messaging [462](#)
- cheating and plagiarism [462](#)
- child abuse content [462](#)
- computer security [462](#)
- computers and internet [462](#)
- dating [462](#)
- digital postcards [462](#)
- dining and drinking [462](#)
- dynamic and residential [462](#)
- education [462](#)
- entertainment [462](#)
- extreme [462](#)
- fashion [462](#)
- file transfer services [462](#)
- filter avoidance [462](#)
- finance [462](#)
- freeware and shareware [462](#)
- gambling [462](#)
- games [462](#)
- government and law [462](#)
- hacking [462](#)
- hate speech [462](#)
- health and nutrition [462](#)
- humor [462](#)
- illegal activities [462](#)
- illegal downloads [462](#)
- illegal drugs [462](#)
- infrastructure and content delivery networks [462](#)
- internet telephony [462](#)
- job search [462](#)
- lingerie and swimsuits [462](#)
- lotteries [462](#)
- mobile phones [462](#)
- nature [462](#)
- news [462](#)
- non-governmental organizations [462](#)
- non-sexual nudity [462](#)
- online communities [462](#)
- online storage and backup [462](#)
- online trading [462](#)
- organizational email [462](#)
- parked domains [462](#)
- peer file transfer [462](#)
- personal sites [462](#)
- photo searches and images [462](#)
- politics [462](#)
- pornography [462](#)
- professional networking [462](#)
- real estate [462](#)
- reference [462](#)

categories (*continued*)

- religion [462](#)
- SaaS and B2B [462](#)
- safe for kids [462](#)
- science and technology [462](#)
- search engines and portals [462](#)
- sex education [462](#)
- shopping [462](#)
- social networking [462](#)
- social science [462](#)
- society and culture [462](#)
- software updates [462](#)
- sports and recreation [462](#)
- streaming audio [462](#)
- streaming video [462](#)
- tobacco [462](#)
- transportation [462](#)
- travel [462](#)
- unclassified [462](#)
- weapons [462](#)
- web hosting [462](#)
- web page translation [462](#)
- web-based email [462](#)
- centralized management [1028](#)
- Centralized Management [933](#), [1252](#)
  - and Destination Controls [1252](#)
  - and quarantines [933](#)
- certificate [675](#)
  - certificate authority [675](#)
- Certificate Signing Request [675](#)
- certificates [41](#), [555](#), [671](#), [674–675](#)
  - demo [41](#)
  - generating a request [555](#)
  - generating and signing your own [675](#)
  - importing [671](#)
  - intermediate certificates [674](#)
- chain query [797](#)
  - creating [797](#)
- charset [948](#)
- CIDR address block [91](#)
- Cisco Security Intelligence Operations [423](#)
- Cisco Web Security Services [446](#)
- clean messageemail [836](#)
  - clean message [836](#)
- CLI [9](#)
  - see Command Line Interface [9](#)
- CLI Audit Logs [1145](#)
- cluster [448](#)
- Code-in-Body> [66](#), [1102](#), [1105](#), [1107](#), [1109–1112](#), [1114–1116](#), [1118](#)
- community string [1120](#)
- conformance level [620](#)
  - SPF/SIDF verification [620](#)
- connectivity issues, troubleshooting [1265](#)
- content filters [270](#), [278](#), [285](#), [289](#), [924](#), [1323–1324](#), [1327](#)
  - actions [278](#)
  - conditions [270](#)

- content filters (*continued*)
  - example [1323–1324](#)
  - non-ascii character sets [289, 1327](#)
  - variables [285](#)
- content matching classifier [513](#)
- Content Scanner [214](#)
- counters [1096](#)
- CPU usage [1098](#)
- CRAM-MD5 [804](#)
- CSV data [861](#)
- custom header [411](#)
- custom SMTP response [115](#)
  - variable [115](#)

## D

- D-Mode [507](#)
- data loss prevention [924](#)
- default [26, 30–31, 39–40, 121](#)
  - domain [121](#)
  - gateway [31, 40](#)
  - hostname [30, 39](#)
  - IP address [26](#)
  - router [31, 40](#)
- default DNS server [1071](#)
- default router [31](#)
- delete all messages in the spam quarantine [970](#)
- deleterecipients command [1111](#)
- delivering mail [743](#)
  - message time out [743](#)
  - possible delivery [743](#)
- delivernow command [1116](#)
- Delivery Connection ID (DCID) [1096](#)
- Delivery Logs [1145](#)
- delivery queue [1111](#)
- delivery queue, monitoring [1106](#)
- demo certificate [41](#)
- Destination Controls [1252](#)
  - and Centralized Management [1252](#)
- detection rule [516, 520](#)
- Direct Server Return (DSR) [1139](#)
- Directory Harvest Attack (DHA) [798](#)
- disclaimer stamping [652, 654](#)
  - multiple encodings [654](#)
- disclaimers [650–652](#)
  - adding to messages [652](#)
  - HTML text resources [650](#)
  - using text resources [651](#)
- DKIM verification [617](#)
  - Authentication-Results header [617](#)
- DLP [506, 513–514, 516, 520, 524, 531–532, 534](#)
  - false positives, minimizing [506, 513–514, 516, 520](#)
  - including sensitive content in Message Tracking [531](#)
  - risk factor score [520](#)
  - severity scale [524](#)
  - troubleshooting [534](#)

- DLP (*continued*)
  - updating the engine and classifiers [532](#)
- DLP policies [513, 516, 520, 523](#)
  - content matching classifier [513](#)
  - detection rule [516, 520](#)
  - filtering attachments [523](#)
  - filtering senders and recipients [523](#)
- DNS [31, 41, 839, 1070–1071](#)
  - authoritative server [1070](#)
  - disabling reverse DNS lookup timeoutReverse DNS Lookup [1071](#)
    - disabling [1071](#)
  - double lookup [839](#)
  - priority [1070](#)
  - servers [31, 41](#)
  - setting [31, 41](#)
  - splitting [1070](#)
  - timeout [1070](#)
  - timeout for reverse DNS lookups [1071](#)
- DNS cache [1109](#)
- DNS list [163](#)
- DNS lookup [1109](#)
- DNS servers [1070](#)
- DNSBL [163](#)
- dnsstatus command [1109](#)
- Domain Debug Logs [1145](#)
- Domain Keys [597–598, 600, 608](#)
  - importing signing keys [608](#)
  - signing key size [600](#)
  - verification [597](#)
  - verifying signatures [598](#)
- Domain Name Service (DNS) [31, 41](#)
  - settings [31, 41](#)
- domain profile [611](#)
  - deleting all existing profiles [611](#)
- double-DNS verified [840, 888](#)
- drop-attachments-where-dictionary-match [223](#)
- DSR [1139](#)
  - load balancing [1139](#)
  - loopback interface [1139](#)
  - Virtual IP (VIP) [1139](#)
- DTD (document type definition) [1023](#)
- dual DKIM and DomainKey signing [603](#)
- dummy accounts [85](#)
- duplex settings, editing [1131](#)

## E

- Early Expiration [926](#)
  - for quarantine [926](#)
- email [698](#)
  - rewriting addresses [698](#)
- email injector [41](#)
  - see listener [41](#)
- Email Security Monitor [829, 835, 839–840, 861, 871, 888](#)
  - automated reporting [861](#)
  - external domains received listing [839](#)

Email Security Monitor (*continued*)

- Items Displayed menu [840, 888](#)
- summary table [835, 871](#)
- Time Range menu [835, 871](#)
- encoding [654](#)
  - in disclaimers [654](#)
- encryption [76, 542, 561, 671](#)
  - use with filter action [542, 561](#)
- encryption headers [545](#)
- End User Quarantine [962](#)
  - see spam quarantine, end user access [962](#)
- enterprise gateway [51](#)
- Enterprise Gateway configuration [78](#)
- Envelope Recipient [155](#)
- Envelope Recipient, rewriting [698](#)
- Envelope Sender [155](#)
- envelope sender DNS verification [114](#)
- evaluation key [49](#)
  - McAfee [49](#)
  - Sophos [49](#)
- evaluation key for IronPort Anti-Spam [48](#)
- evaluation key for Outbreak Filters [36, 49](#)
- explained [114](#)
- exporting [649–650](#)
  - HTML text resources [650](#)
  - text resources [649](#)
- external authentication [808, 988–989](#)
  - enabling LDAP [988](#)
  - enabling RADIUS [989](#)

**F**

- factory configuration [26](#)
- feedback about this documentation, sending [6](#)
- filtering unparsable messages [154](#)
- filters [127, 129, 136, 148, 154, 160, 165](#)
  - comment character [129](#)
  - matching dictionary terms [136, 165](#)
  - matching empty headers [154](#)
  - regular express and Python [148](#)
  - scannable archive file types [160](#)
  - unparsable messages [154](#)
- final entry, in HAT [90](#)
- findevent [1119](#)
- finding senders [103](#)
- forcing updates [377](#)
- forward DNS lookup [1108](#)
- FTP [1303](#)
- FTP Access [1304](#)
- FTP Server Logs [1145](#)
- fully-qualified domain name [91](#)

**G**

- gauges [1098](#)

- global counters [1110](#)
- good neighbor table [680](#)
- graphical user interface [9](#)
  - see GUI [9](#)
- graphs [1130](#)
- grouping, of appliances for File Analysis result details in the cloud [489](#)
- GUI [9–10, 41, 1129](#)
  - accessing [10](#)
  - browser requirements [9](#)
  - enabling [41, 1129](#)
- GUI logs. See HTTP logs [1145](#)
- GUI session timeout [996](#)

**H**

- hard power reset [1042, 1275](#)
- HAT [98, 103, 109](#)
  - exporting [109](#)
  - testing HAT variables [98](#)
- HAT order [102](#)
  - editing via GUI [102](#)
- headers [698](#)
- headers, inserting [545](#)
- headers, logging [416](#)
- headers, stripping with message filters [205](#)
- Host Access Table (HAT) [102](#)
  - reordering in GUI [102](#)
- hostname [30, 39](#)
  - specifying the hostname during setup [30](#)
- hostrate command [1107](#)
- hoststatus command [1105](#)
- HTTP [41, 1129, 1303](#)
  - enabling [41](#)
  - GUI [1129](#)
- HTTP authentication [862](#)
- HTTP Logs [1145](#)
- HTTPS [41, 690, 1129, 1303](#)
  - certificate for [690](#)
  - enabling [41](#)
  - GUI [1129](#)
- HTTPS login [10](#)

**I**

- image analysis [217, 270, 278](#)
- image scanning [217](#)
- image verdicts [217](#)
- IMAP authentication [962](#)
- implementsv [116](#)
- importing [649–650](#)
  - HTML text resources [650](#)
  - text resources [649](#)
- importing signing keys [608](#)
- incoming relay [411–412](#)
  - custom header [411](#)

- incoming relay (*continued*)
    - received header [412](#)
  - incoming relays [618](#)
  - Incoming Relays [416](#)
    - example log entry [416](#)
  - Injection Connection ID (ICID) [1096](#)
  - injection control counter reset [112](#)
  - injection control periodicity [112](#)
  - Injection Debug Logs [1145](#)
  - injector [41](#)
    - see listener [41](#)
  - insecure relay [122](#)
  - inserting headers [545](#)
  - installation [1043](#)
    - reverting [1043](#)
  - invalid recipient [836](#)
  - IP interfaces [31, 41](#)
    - assigning [31](#)
    - defining listeners on [41](#)
  - IronPort Anti-Spam [35, 48, 380, 418](#)
    - evaluation key [35, 48](#)
    - filters [380](#)
    - testing [418](#)
  - IronPort Email Encryption [535, 538, 542, 561](#)
    - configuring [535](#)
    - envelope settings [538](#)
    - key server settings [538](#)
    - message settings [538](#)
    - notification settings [538](#)
    - use with filter action [542, 561](#)
  - IronPort Spam Quarantine [60](#)
    - released messages and email pipeline [60](#)
  - IronPort Spam Quarantine. See Spam quarantine [924](#)
  - IronPort Text Mail Logs [1145](#)
- ## K
- key size [600](#)
- ## L
- LDAP [155–156, 776, 779, 781–783, 786, 788–789, 802, 808, 812, 814, 960, 962, 988](#)
    - alias consolidation query [812](#)
    - alias expansion [789](#)
    - anonymous queries [783](#)
    - base DN [782](#)
    - connection pooling [802](#)
    - connections [786](#)
    - external authentication [808, 988](#)
    - failover [814](#)
    - group queries [155–156](#)
    - LDAPS certificate [783](#)
    - load-balancing [814](#)
    - Microsoft Exchange 5.5 support [779](#)
    - LDAP (*continued*)
      - multiple servers [814](#)
      - OpenLDAP queries [788](#)
      - query tokens [782](#)
      - recursive queries [783](#)
      - SSL [783](#)
      - SunONE queries [788](#)
      - test servers [776](#)
      - testing queries [781, 786](#)
      - testing servers [776](#)
    - LDAP Debug Logs [1145](#)
    - LDAP errors [787](#)
    - LDAP routing query [669](#)
      - with SMTP call-ahead recipient validation [669](#)
    - LDAPS certificate [783](#)
    - limits [695](#)
      - SMTP Routes [695](#)
    - link aggregation [1132](#)
    - listener [75–76, 652](#)
      - adding disclaimers [652](#)
      - encryption on [76](#)
      - malformed MAIL FROM and default domain [75](#)
    - listenerconfig command [66](#)
    - load [1098](#)
    - log file type [1145](#)
    - log subscription [370, 1145](#)
      - Sophos [370](#)
    - log subscriptions [1156](#)
    - logging.headers [416](#)
    - logical IP interface [31](#)
    - logs [1145, 1150, 1156, 1198, 1213, 1215, 1217, 1270](#)
      - Anti-Spam Archive [1145](#)
      - Anti-Virus [1145](#)
      - Anti-Virus Archive [1145](#)
      - Bounce Logs [1145](#)
      - CLI Audit Logs [1145](#)
      - comparison [1150](#)
      - Configuration History Logs [1198](#)
      - definition [1145](#)
      - Delivery Logs [1145](#)
      - extensions in filenames [1217](#)
      - format [1145](#)
      - FTP Server Logs [1145](#)
      - global attributes [1215](#)
      - HTTP Logs [1145](#)
      - Injection Debug Logs [1145](#)
      - IronPort Text Mail Logs [1145](#)
      - LDAP Debug Logs [1145](#)
      - levels [1213](#)
      - log subscription defined [1145](#)
      - NTP Logs [1145](#)
      - qmail Format Delivery Logs [1145](#)
      - Scanning [1145](#)
      - Status Logs [1145](#)
      - subscriptions [1156](#)
      - troubleshooting with [1270](#)

loopback interface [1139](#)

## M

M-Series [1291](#)  
 MAIL FROM [136, 270](#)  
 mail loops, detecting [246](#)  
 mail policies [258](#)  
     First Match Wins [258](#)  
 mail policies, outgoing [525](#)  
     DLP [525](#)  
 mail protocol [66](#)  
     defining in < [66](#)  
 mail transfer agent. See MTA. [1292](#)  
 mailtable feature [693](#)  
 mailing lists [967](#)  
     notifications [967](#)  
 malware [362](#)  
     defined [362](#)  
 marketing messages [836](#)  
 matching empty headers [154](#)  
 maximum [77, 85](#)  
     message size in HAT [77](#)  
     messages per connection in HAT [77](#)  
     recipients per hour in HAT [85](#)  
     recipients per message in HAT [77](#)  
 maximum recipients per hour [77](#)  
 mbox format [204](#)  
 mbox-format log file [370](#)  
 McAfee [49](#)  
     evaluation key [49](#)  
 McAfee anti-virus engine [365](#)  
 memory [1098](#)  
 message body scanning [161](#)  
 message encoding [233](#)  
     modifying [233](#)  
 message filter [183](#)  
     filter actions [183](#)  
 message filter action variables [652](#)  
     using in disclaimers [652](#)  
 message filter for SBRS [86](#)  
 message filters [127–129, 131, 136, 158–161, 164–165, 192, 227, 231, 924](#)  
     adding [227](#)  
     attachment-protected [136](#)  
     attachment-unprotected [136](#)  
     body-dictionary-match [165](#)  
     combining [129, 136](#)  
     deleting [227](#)  
     encryption [161](#)  
     exporting [231](#)  
     making (in)active [227](#)  
     MIME types [160](#)  
     moving [227](#)  
     ordering [131](#)  
     overview [127](#)

message filters (*continued*)  
     random numbers in [159](#)  
     rules [128](#)  
     SenderBase Reputation Score [164](#)  
     status [227](#)  
     syntax [129](#)  
     time and date [158](#)  
     variables [192](#)  
 message headers [159](#)  
 message headers, inserting with message filters [205](#)  
 Message ID (MID) [1096](#)  
 message modification level threshold [437](#)  
 message replication [183, 200](#)  
 message splintering [260](#)  
     defined [260](#)  
 message tracking [415](#)  
     Incoming Relays [415](#)  
 Message Tracking [531](#)  
     and sensitive content [531](#)  
 message variables [964](#)  
     spam quarantine notifications [964](#)  
 MIB file [1121](#)  
 monitoring [1101](#)  
 monitoring Virtual Gateway addresses [753](#)  
 MTA [51, 78, 671](#)  
 multilayer anti-virus scanning [362](#)  
 multiple appliances [26](#)  
 multiple recipients [260](#)  
 MX [13](#)

## N

negative scores [94](#)  
 netmask [31](#)  
 network access list [993](#)  
 network time protocol (NTP) [30, 50](#)  
     settings [30, 50](#)  
 NIC pairing [1132–1133](#)  
     alerts [1133](#)  
     named on upgrade [1133](#)  
 NIC teaming [1132](#)  
 Normal Expiration [926](#)  
     for quarantine [926](#)  
 not.double.verified [114](#)  
 NTP Logs [1145](#)  
 NTP server [1088](#)  
     removing [1088](#)  
 NXDOMAIN [114, 120](#)

## O

oldmessage command [1118](#)  
 open relay, definition [122](#)  
 opening links in a separate window [835](#)



Outbreak Filters [36, 49, 278, 421, 423–430, 433–437, 441](#)  
   Adaptive rules defined [426](#)  
   Adaptive Scanning [433](#)  
   alerts [441](#)  
   always rule [428](#)  
   anti-virus updates [429](#)  
   bypassed file extensions [436](#)  
   Context Adaptive Scanning EngineOutbreak Filters [424](#)  
     CASE [424](#)  
   delaying messages [424](#)  
   enabling alerts [433](#)  
   evaluation key [36, 49](#)  
   modifying messagesOutbreak Filters [426](#)  
     message modification [426](#)  
   multiple scores [429](#)  
   non-viral threats [423](#)  
   Outbreak rules defined [426](#)  
   overview [421](#)  
   re-evaluating messages [429–430](#)  
   redirecting links [425](#)  
   rule [427](#)  
   setting a message modification level threshold [437](#)  
   setting a quarantine level threshold [435](#)  
   skipping [278](#)  
   SNMP Traps [441](#)  
   threat categoriesOutbreak Filters [423](#)  
     virus outbreaks [423](#)  
   updating rules [434](#)  
   using without anti-virus scanning [429](#)  
 overflow [429](#)

## P

partial address [91, 124](#)  
   in HAT [91](#)  
   in RAT [124](#)  
 passphrase [987](#)  
   settings [987](#)  
 pausing the work queue [1117](#)  
 PEM format, for certificates [555](#)  
 performance [1273](#)  
 phased approach to reputation filters [83](#)  
 pinout for serial connection [21](#)  
 POP authentication [962](#)  
 POP/IMAP servers [78](#)  
 positive scores [94](#)  
 possible delivery [743](#)  
 pre-policy filters [230](#)  
   importing [230](#)  
 private injector [44](#)  
 private key [671](#)  
 private listeners [90](#)  
   default entries [90](#)  
 protocol [66](#)  
   see mail protocol [66](#)

proxy server for IronPort Anti-Spam Rules [1033](#)  
 public blocked list [163](#)  
 public listeners [90](#)  
   default entries [90](#)  
 purging address tagging keys [742](#)  
 PVO. See quarantines, policy, virus, and outbreak [924](#)

## Q

qmail Format Delivery Logs [1145](#)  
 quarantine [495, 924, 926–927, 930, 934–935, 937, 939, 941](#)  
   applying actions to messages in [935](#)  
   default action [927, 930](#)  
   displaying non-ascii characters in subject [495](#)  
   early expiration [926](#)  
   In other quarantines [937](#)  
   international character sets [934](#)  
   normal expiration [926](#)  
   outbreak [924](#)  
   outbreak, reporting messages to Cisco [941](#)  
   retention time [926](#)  
   spam. See Spam quarantine [924](#)  
   stripping attachments [495](#)  
   subject tagging [495](#)  
   testing messages for viruses [939](#)  
   unclassified [930](#)  
   virus [924](#)  
 quarantine level threshold [435](#)  
 quarantine overflow [429](#)  
 Quarantine Threat Level Threshold [427](#)  
   recommended default [427](#)  
   setting [427](#)  
 quarantines [924–925, 933](#)  
   centralized policy, virus, and outbreak quarantines [933](#)  
   policy [924](#)  
   policy, virus, and outbreak [933](#)  
     centralized [933](#)  
   policy, virus, and outbreak, managing [925](#)  
   types [924](#)  
 queries [788–790, 792, 801, 808, 812](#)  
   acceptance [788](#)  
   external authentication [808](#)  
   group [792](#)  
   masquerading [790](#)  
   routing [789](#)  
   SMTP authentication [801](#)  
   spam quarantine alias consolidation [812](#)  
 queue [66](#)

## R

RADIUS external authentication [989](#)  
 RAM [1273](#)  
 RAM Utilization [1098](#)

- RAT **125**
    - bypassing recipients **125**
    - bypassing recipients (CLI) **125**
    - bypassing recipients (GUI) **125**
  - rate command **1107**
  - rates **1100**
  - RBL **136**
  - RCPT TO **136, 270**
  - RCPT TO command **123**
  - real-time monitoring **1107**
  - received header **412**
  - receiving control, bypass **125**
  - receiving errors **1270**
  - Recipient Access Table (RAT) **121–122**
    - default entry **122**
    - definition **121**
    - editing via CLI **122**
  - recipient validation **663**
  - recipients, counting in message filters **160**
  - reconfigure **26**
  - recursive DNS queries **1071**
  - recursive queries, LDAP **783**
  - redirecting email **32**
  - redirecting URLs in messages **452**
  - redirectrecipients **1113**
  - relaying email **90**
  - relaying messages **41**
  - remote **1030**
  - removemessage command **1118**
  - reporting **415**
    - Incoming Relays **415**
  - required TLS **679**
  - resetcounters command **1110**
  - Resource Conservation mode **1098, 1273**
  - resume command **1116**
  - resumedel command **1115**
  - resumelister command **1116**
  - resuming email delivery **1115**
  - resuming receiving **1116**
  - Retention Time **926**
    - for quarantines **926**
  - retrospective verdict **502**
  - retry message delivery **845**
  - reverse DNS lookup **96, 746, 1108**
  - revert **1043**
    - installation **1043**
  - rewriting email addresses **698**
  - rewriting URLs in messages **452**
  - RFC **7, 257, 495, 671, 1120**
    - 1065 **1120**
    - 1066 **1120**
    - 1067 **1120**
    - 1213 **1120**
    - 1907 **1120**
    - 2047 **495**
    - 2487 **671**
  - RFC (*continued*)
    - 2821 **7**
    - 821 **257**
    - 822 **257**
  - risk factor score **506, 520**
    - DLP **520**
  - rolling over log files **1217**
  - root servers (DNS) **31, 41**
  - routing **669**
    - SMTP call-ahead server **669**
- ## S
- safelist/blocklist **949–951, 958–959**
    - and external spam quarantine **951**
    - backing up and restoring **958**
    - enabling **950**
    - importing and exporting **958**
    - managing **951**
    - troubleshooting **959**
    - workqueue **949**
  - SBRS **85, 94, 164**
    - none **94, 164**
    - testing **85**
  - SBRS see Senderbase Reputation Service Score **94**
  - scannable archive file types **160**
  - scanning images **217**
  - Scanning Logs **1145**
  - scheduled log rollover **1217**
  - scp command **1306**
  - SDS. See Cisco Web Security Services **446**
  - secure copy **1306**
  - secure HTTP (https) **671**
  - Secure LDAP **783**
  - Secure Socket Layer (SSL) **671**
  - selecting a notification **657**
  - SenderBase **77, 94**
    - SBO in sender groups **94**
  - SenderBase Affiliate network **81**
  - SenderBase Network Owner Identification Number **91**
  - SenderBase Reputation score **415**
  - SenderBase Reputation Score **82, 94**
  - SenderBase Reputation Scores, syntax in CLI **94**
  - SenderBase Reputation Service **81, 829**
  - SenderBase Reputation Service Score **94**
  - SenderBase, querying **94**
  - separate window icon **835**
  - serial connection pinouts **1307**
  - SERVFAIL **114, 120**
  - severity scale **524**
    - DLP **524**
  - showmessage command **1118**
  - showrecipients **1114**
  - SIDF records **619**
    - testing **619**
    - valid **619**

- SIDF verification [136, 618, 620, 624, 627](#)
  - configuring [618](#)
  - conformance level [620](#)
  - enabling [620](#)
  - results [624](#)
  - testing [627](#)
- signing key [600](#)
  - size [600](#)
- signing keys [608](#)
  - deleting all existing keys [608](#)
  - removing specific keys [608](#)
- SMI file [1121](#)
- SMTP [78, 123, 418](#)
  - messages [78](#)
  - response [123](#)
  - testing IronPort Anti-Spam [418](#)
- SMTP Auth [801, 804](#)
  - DIGEST-MD5 [804](#)
  - MD5 [801](#)
  - SHA [801](#)
  - supported authentication mechanisms [801](#)
  - TLS [804](#)
- SMTP authenticated user match filter rule [169](#)
- SMTP Authentication profile [804](#)
- SMTP call-ahead recipient validation [663, 668–670](#)
  - bypassing [670](#)
  - conversation workflow [663](#)
  - SMTP server responses [668](#)
  - with LDAP routing query [669](#)
- SMTP Call-Ahead Server Profile [665, 668](#)
  - creating [665](#)
  - enabling on a listener [668](#)
- SMTP conversation [663](#)
  - SMTP call-ahead server [663](#)
- SMTP daemon [41](#)
  - see injector [41](#)
  - see listener [41](#)
- SMTP Routes [693, 695–696](#)
  - limits [695](#)
  - mail delivery and splintering [696](#)
- SNMP [1120–1122](#)
  - community string [1120](#)
  - MIB file [1121](#)
  - overview [1120](#)
  - SMI file [1121](#)
  - specifying multiple trap targets [1122](#)
  - traps [1122](#)
- SNMP (Simple Network Management Protocol) [1120](#)
- snmpconfig command [1122](#)
- SNMPv1 [1120](#)
- SNMPv2 [1120](#)
- Sophos [35, 49, 377](#)
  - evaluation key [35, 49](#)
  - updates [377](#)
- Sophos virus scanning [371](#)
  - filters [371](#)
- spam [418](#)
  - testing [418](#)
- spam message [836](#)
- spam quarantine [943, 945, 960–962, 964, 967, 969–971, 1294](#)
  - alias consolidation [967](#)
  - behavior when full [945](#)
  - deleting all messages [970–971](#)
  - disabling [971](#)
  - end user access [962](#)
  - end-user access [960](#)
  - external [943, 1294](#)
  - IMAP/POP authentication [961](#)
  - LDAP authentication [961](#)
  - local [943](#)
  - message details [969](#)
  - message variables [964](#)
  - notification [964](#)
  - receiving multiple notifications [967](#)
  - released messages and email pipeline [970](#)
  - testing notifications [967](#)
- specifying an offset [1088](#)
- SPF records [619](#)
  - testing [619](#)
  - valid [619](#)
- SPF verification [618, 620, 623–624, 627](#)
  - configuring [618](#)
  - conformance level [620](#)
  - enabling [620](#)
  - received SPF header [623](#)
  - results [624](#)
  - testing [627](#)
- spf-passed filter rule [136, 627](#)
- spf-status filter rule [136, 625](#)
- SPFverification [136](#)
- SSH [12](#)
- SSL [783](#)
- STARTTLS [671](#)
  - definition [671](#)
- stateless logs [1172](#)
- status command [1102](#)
- status detail command [1102](#)
- Status Logs [1145](#)
- stopped by content filter [836](#)
- stopped by reputation filtering [836](#)
- streaming upgrades [1030](#)
- strip headers [205](#)
- strip-header filter action [205](#)
- subnet [31](#)
- suspenddel command [1114](#)
- suspending email delivery [1114](#)
- suspending receiving [1115](#)
- suspendlistener command [1115](#)
- synchronizing time [30, 50](#)
- System Capacity [856–858, 875–877](#)
  - All page [858, 877](#)
  - Incoming Mail page [857, 875](#)

System Capacity (*continued*)

- memory page swapping [858, 876](#)
- Outgoing Mail page [857, 875](#)
- System Load page [857, 876](#)
- WorkQueue page [856, 875](#)
- system clock [30, 50](#)
- System Logs [1145](#)
- system quarantine. See quarantines, policy, virus, and outbreak [924](#)
- system setup wizard [26](#)
- system time [30, 50](#)
  - setting [30, 50](#)

## T

- testing [375, 418](#)
  - IronPort Anti-Spam [418](#)
  - Sophos virus engine [375](#)
- testing HAT variables [98](#)
- text resources [648–651](#)
  - code view [650](#)
  - disclaimers [651](#)
  - exporting [649](#)
  - exporting and importing into HTML resources [650](#)
  - HTML-based [650](#)
  - importing [649](#)
  - managing [648](#)
  - using in policies and settings [651](#)
- third-party relay [122](#)
- Threat Level [426](#)
  - defined [426](#)
- Threat Operations Center (TOC) [426](#)
- thresholds, in SenderBase Reputation Scores [94](#)
- throttling [81](#)
- time servers [30, 50](#)
- time zone [1088](#)
- time zone, setting [30, 50](#)
- time, system [30, 50](#)
- TLS [671, 680](#)
  - certificates [671](#)
  - default [680](#)
  - preferred [680](#)
  - required [680](#)
- tophosts command [1107](#)
- topin command [1109](#)
- trace [415](#)
- trace command [85](#)
- troubleshooting [534](#)
  - DLP [534](#)
- trustworthiness [94](#)
- TTL [1104](#)

## U

- unary form, in message filters [159](#)
- unclassified quarantine. See quarantine, unclassified [924](#)

- unparsable messages [154](#)
- unsolicited commercial email [81](#)
- updates [532](#)
  - DLP engine and classifiers [532](#)
- upgrades [1030–1031, 1041](#)
  - available [1041](#)
  - local [1030](#)
  - obtaining via GUI [1031](#)
  - streaming [1030](#)
- URL reputation [443](#)
- user accounts [973, 987](#)
  - limits [973](#)
  - locking and unlocking [987](#)
- user groups [973–974](#)
- user types [974](#)
- uuencoded attachments [131](#)

## V

- verdict [270, 278](#)
  - image analysis [270, 278](#)
- verification [618](#)
  - SIDF [618](#)
  - SPF [618](#)
- version [859](#)
- virtual appliance [1145](#)
  - license [1145](#)
- virtual Email Security appliance [20](#)
  - loading the license [20](#)
- Virtual Gateway addresses [204](#)
- Virtual Gateway queue [746](#)
- Virtual IP (VIP) [1139](#)
- virus message [836](#)
- virus quarantine. See quarantine [924](#)
  - virus. [924](#)
- VLAN [1135](#)
  - defined [1135](#)
  - labels [1135](#)

## W

- WBRS [443](#)
  - See URL reputation [443](#)
- web interface [41](#)
  - enabling [41](#)
- web reputation [175, 211](#)
  - message filters [175, 211](#)
- Web UI session timeout [996](#)
- weekly status updates [50](#)
- white space [146](#)
- whitespace [370](#)
- wizard [26, 36](#)
  - Active Directory [36](#)
  - system setup [26](#)
- work queue [1098, 1117](#)

work queue, pausing [1117](#)

## X

X-headers, adding [495](#)

X-IronPort-AV header [368](#)

XML [1023](#), [1130](#), [1145](#)

XML Status feature [1130](#)

