



Segment Routing Configuration Guide, Cisco IOS XE Fuji 16.7.x

Americas Headquarters

Cisco Systems, Inc.
170 West Tasman Drive
San Jose, CA 95134-1706
USA
<http://www.cisco.com>
Tel: 408 526-4000
800 553-NETS (6387)
Fax: 408 527-0883



CONTENTS

CHAPTER 1

Read Me First 1

CHAPTER 2

Introduction to Segment Routing 3

- Overview of Segment Routing 3
- How Segment Routing Works 4
- Examples for Segment Routing 4
- Benefits of Segment Routing 6
- Segment Routing Global Block 8
 - Segment Routing Global Block 9
 - Adjacency Segment Identifiers 9
 - Prefix Segment Identifiers 9
- Additional References for Segment Routing 10
- Feature Information for Introduction to Segment Routing 10

CHAPTER 3

Segment Routing With IS-IS v4 Node SID 11

- Restrictions for Segment Routing With IS-IS v4 Node SID 11
- Information About Segment Routing IS-IS v4 Node SID 11
 - Segment Routing IS-IS v4 Node SID 11
 - Prefix-SID Received in Label Switched Path from Remote Routers 12
 - Segment Routing Adjacency SID Advertisement 12
 - Multiple Adjacency-SIDs 13
 - Segment Routing Mapping Server (SRMS) 13
 - Connected Prefix SIDs 13
 - SRGB Range Changes 13
 - SRGB Deletion 14
- MPLS Forwarding on an Interface 14

Segment Routing and LDP Preference	14
Segment Routing -Traffic Engineering Announcements	14
How to Configure Segment Routing —IS-IS v4 Node SID	14
Configuring Segment Routing	14
Configuring Segment Routing on IS-IS Network	16
Configuring Prefix-SID for IS-IS	17
Configuring Prefix Attribute N-flag-clear	18
Configuring Explicit Null Attribute	19
Configuring Segment Routing Label Distribution Protocol Preference	20
Configuring IS-IS SRMS	21
Configuring IS-IS SRMS Client	21
Configuring IS-IS SID Binding TLV Domain Flooding	22
Configuration Examples for Segment Routing —IS-IS v4 Node SID	22
Example: Configuring Segment Routing on IS-IS Network	22
Example: Configuring Explicit Null Attribute	22
Additional References for Segment Routing With IS-IS v4 Node SID	23
Feature Information for Segment Routing—IS-IS v4 Node SID	23

CHAPTER 4**IS-IS Link-protection Topology Independent Loop Free Alternate Fast Reroute 25**

Prerequisites for IS-IS Link-protection Topology Independent Loop Free Alternate Fast Reroute	25
Information About IS-IS Link-protection Topology Independent Loop Free Alternate Fast Reroute	27
Topology-Independent Loop Free Alternate	27
Topology Independent Loop Free Alternate Tie-break	27
Interface Fast Reroute Tiebreakers	28
How to Configure IS-IS Link-protection Topology Independent Loop Free Alternate Fast Reroute	29
Configuring Topology Independent Loop Free Alternate Fast Reroute	29
Configuring Topology Independent Loop Free Alternate With Mapping Server	29
Examples: Configuring IS-IS Link-protection Topology Independent Loop Free Alternate Fast Reroute	33
Verifying the Tiebreaker	34
Verifying the Primary and Repair Paths	34
Verifying the IS-IS Segment Routing Configuration	36
Verifying the IS-IS Topology Independent Loop Free Alternate Tunnels	36

Verifying the Segment Routing Traffic Engineering With Topology Independent Loop Free Alternate Configuration 37

Additional References for IS-IS Link-protection Topology Independent Loop Free Alternate Fast Reroute 39

Feature Information for IS-IS Link-protection Topology Independent Loop Free Alternate Fast Reroute 39

CHAPTER 5

Segment Routing Traffic Engineering With IS-IS 41

Restrictions for Segment Routing-Traffic Engineering With IS-IS 41

Information About Segment Routing Traffic Engineering With IS-IS 41

SR-TE LSP Instantiation 42

SR-TE LSP Explicit Null 42

SR-TE LSP Path Verification 42

SR-TE Traffic Load Balancing 44

SR-TE Tunnel Re-optimization 45

SR-TE With Lockdown Option 46

SR-TE Tunnel Protection 46

Unnumbered Support 47

How to Configure Segment Routing Traffic Engineering With IS-IS 47

Configuring Path Option for a TE Tunnel 47

Configuring SR Explicit Path Hops 48

Configuring Affinity on an Interface 48

Enabling Verbatim Path Support 49

Use Case: Segment Routing Traffic Engineering Basic Configuration 49

Explicit Path SR-TE Tunnel 1 51

Explicit Path SR-TE Tunnel 2 51

Explicit Path SR-TE Tunnel 3 51

Dynamic Path SR-TE Tunnel 4 52

Dynamic Path SR-TE Tunnel 5 52

Verifying Configuration of the SR-TE Tunnels 53

Verifying Tunnel 1 53

Verifying Tunnel 2 53

Verifying Tunnel 3 54

Verifying Tunnel 4 54

Verifying Tunnel 5	55
Verifying Verbatim Path Support	55
Additional References for Segment Routing Traffic Engineering With IS-IS	56
Feature Information for Segment Routing -Traffic Engineering With IS-IS	57

CHAPTER 6**Segment Routing With OSPFv2 Node SID 59**

Information About Segment Routing With OSPFv2 Node SID	59
Prefix-SID Received in Label Switched Path From Remote Routers	60
Segment Routing Adjacency SID Advertisement	60
Multiple Adjacency-SIDs	60
Segment Routing Mapping Server	60
Connected Prefix SIDs	61
SRGB Range Changes	61
MPLS Forwarding on an Interface	61
Conflict Handling of SID Entries	61
How to Configure Segment Routing With OSPFv2 Node SID	62
Configuring Segment Routing With OSPF	62
Configuring Segment Routing on OSPF Network	63
Configuring Prefix-SID for OSPF	64
Configuring Prefix Attribute N-flag-clear	66
Configuring Explicit Null Attribute With OSPF	66
Configuring Segment Routing Label Distribution Protocol Preference With OSPF	68
Configuring OSPF SRMS	69
Configuring OSPF SRMS Client	69
Additional References for Segment Routing With OSPFv2 Node SID	69
Feature Information for Segment Routing With OSPFv2 Node SID	70

CHAPTER 7**OSPFv2 Link-protection Topology Independent Loop Free Alternate Fast Reroute 71**

Restrictions for Topology Independent Loop Free Alternate Fast Reroute	71
Information About OSPFv2 Link-Protection Topology Independent Loop Free Alternate Fast Reroute	72
IP Fast Reroute and Remote Loop Free Alternate	72
Topology Independent Fast Reroute	72
Topology-Independent Loop Free Alternate	73

Topology Independent Loop Free Alternate Tie-break	73
P-Space	74
Q-Space	74
Post-Convergence Path	74
Per-Destination Link Protection	75
Per Interface Loop Free Alternate Enablement	76
Prefix Processing	76
Anycast Prefix Processing	76
Per-Prefix Loop Free Alternate Tie-Break	76
Node Protection	78
Shared Risk Link Groups Protection	78
Node-Shared Risk Link Groups Protection	79
How to Configure Topology Independent Loop Free Alternate Fast Reroute	79
Enabling Topology Independent Loop Free Alternate Fast Reroute	79
Configuring Topology Independent Loop Free Alternate Fast Reroute	80
Configuring Topology Independent Fast Reroute Tie-breaker	81
Verifying Topology Independent Fast Reroute Tunnels	82
Debugging Topology Independent Loop Free Alternate Fast Reroute	84
Examples: OSPFv2 Link-Protection Topology Independent Loop Free Alternate Fast Reroute	84
Example: Configuring Topology Independent Loop Free Alternate Fast Reroute	84
Additional References for OSPFv2 Link-protection Topology Independent Loop Free Alternate Fast Reroute	85
Feature Information for OSPFv2 Link-protection Topology Independent Loop Free Alternate Fast Reroute	85

CHAPTER 8
Segment Routing Traffic Engineering With OSPF 87

Restrictions for Segment Routing Traffic Engineering With OSPF	87
Information About Segment Routing Traffic Engineering With OSPF	87
Benefits of Using Segment Routing Traffic Engineering With OSPF	88
OSPFv2 Segment Routing Traffic Engineering Functionalities	88
Protected Adjacency SID	88
Traffic Engineering Interfaces	88
Unnumbered Support	89
Segment Routing Traffic Engineering Support for Forwarding Adjacency	89

Segment Routing Traffic Engineering Support for Auto-route Announce	89
Auto-route Announce IP2MPLS	89
SR-TE LSP Instantiation	90
Tunnel Path Affinity Validation	90
SR-TE Traffic Load Balancing	90
Load Balancing on Port Channel TE Links	90
Load Balancing on Single Tunnel	90
Load Balancing on Multiple Tunnels	90
SR-TE Tunnel Re-optimization	91
SR-TE With Lockdown Option	92
SR-TE Tunnel Protection	92
IP-FRR Local Repair Protection	92
Tunnel Path Protection	93
SR-TE LSP Path Verification	93
Topology Path Validation	93
SR SID Validation	94
LSP Egress Interface	94
IP Reachability Validation	94
Tunnel Path Resource Avoidance Validation	95
SR-TE LSP Explicit Null	95
Verbatim Path Support	95
How to Configure Segment Routing Traffic Engineering With OSPF	95
Enabling Segment Routing Traffic Engineering With OSPF	95
Configuring Path Option for a TE Tunnel	96
Configuring SR Explicit Path Hops	96
Configuring Tunnel Path Affinity Validation	97
Configuring Affinity on an Interface	97
Configuring Segment Routing Traffic Engineering With OSPF	98
Configuring Intra Area Tunnel	98
Configuring Inter Area Tunnel	101
Verifying Configuration of the SR-TE Tunnels	103
Verifying Tunnel 1	103
Verifying Tunnel 2	104
Verifying Tunnel 3	104

Verifying Tunnel 4 105

Verifying Tunnel 5 105

Additional References for Segment Routing Traffic Engineering With OSPF 106

Feature Information for Segment Routing Traffic Engineering With OSPF 106

CHAPTER 9

BGP Dynamic Segment Routing Traffic Engineering 109

Restrictions for Segment Routing –Traffic-Engineering Dynamic BGP 109

Information About Segment Routing –Traffic-Engineering Dynamic BGP 109

 TE Label Switched Path Attribute-Set 110

How to Configure TE Label Switched Path Attribute-Set 111

 Configuring TE Label Switched Path Attribute-Set 111

Additional References for BGP Dynamic Segment Routing Traffic Engineering 112

Feature Information for BGP Dynamic Segment Routing Traffic Engineering 112

CHAPTER 10

Segment Routing On Demand Next Hop for L3/L3VPN 113

Restrictions for Segment Routing On Demand Next Hop for L3/L3VPN 113

Information About Segment Routing On Demand Next Hop for L3/L3VPN 114

How to Configure Segment Routing On Demand Next Hop for L3/L3VPN 114

 Configuring Segment Routing On Demand Next Hop for L3/L3VPN 114

Verifying Segment Routing On Demand Next Hop for L3/L3VPN 118

Additional References for Segment Routing On Demand Next Hop for L3/L3VPN 122

Feature Information for Segment Routing On Demand Next Hop for L3/L3VPN 122

CHAPTER 11

Segment Routing On Demand for L2VPN/VPWS 125

Restrictions for Segment Routing On Demand Next Hop for L2VPN/VPWS 125

Information About Segment Routing On Demand Next Hop for L2VPN/VPWS 126

 AToM Manager 126

 Inter-Area L2VPN ODN 126

How to Configure Segment Routing On Demand Next Hop for L2VPN/VPWS 126

 Configuring Segment Routing On Demand Next Hop for L2VPN/VPWS Using Pseudowire Interface
 Commands 127

 Configuring Segment Routing On Demand Next Hop for L2VPN/VPWS Using Template Commands
 128

Configuring Segment Routing On Demand Next Hop for L2VPN/VPWS With Prepend Option 128

Configuring Preferred Path for Segment Routing On Demand Next Hop for L2VPN/VPWS	129
Configuring Autoroute Destination for Segment Routing On Demand Next Hop for L2VPN/VPWS	129
Verifying Segment Routing On Demand Next Hop for L2VPN/VPWS	130
Additional References for Segment Routing On Demand Next Hop for L2VPN/VPWS	133
Feature Information for Segment Routing On Demand Next Hop for L2VPN/VPWS	133

CHAPTER 12**Fast Convergence Default Optimize 135**

Information About Fast Convergence Default Optimize	135
Default Optimize Values for IS-IS	136
Default Optimize Values for OSPF	136
Additional References for Fast Convergence Default Optimize	138
Feature Information for Fast Convergence Default Optimize	138

CHAPTER 13**Routing Information Base Support 141**

Routing Information Base Support for Route Redistribution	141
OSPF Node SID Redistribution Support	141
Information About OSPF Node SID Redistribution Support	142
NSSA ASBR	142
non-NSSA ASBR	142
Redistributing Prefix	142
Verifying OSPF Node SID Redistribution	143
Routing Information Base Support for On-Demand Next Hop	144
Additional References for Routing Information Base Support	144
Feature Information for Routing Information Base Support	145

CHAPTER 14**SR-TE On Demand LSP 147**

Restrictions for SR-TE On Demand LSP	147
Information About SR-TE On Demand LSP	147
SR-TE: Setup LSP as Static Route	148
Static SRTE over Unnumbered Interfaces	148
How to Configure SR-TE On Demand LSP	148
Configuring LSP as Static Route	149
Enabling Segment Routing Auto Tunnel Static Route	149

Verifying Segment Routing Auto-Tunnel Static Route	149
Additional References for SR-TE On Demand LSP	152
Feature Information for SR-TE On Demand LSP	152

CHAPTER 15**Segment Routing MPLS OAM Support 153**

Restrictions for Segment Routing OAM MPLS Support	153
Information About Segment Routing MPLS OAM Support	154
Segment Routing OAM Support	154
Benefits of Segment Routing OAM Support	154
Segment Routing MPLS Ping	154
Segment Routing MPLS Traceroute	155
LSP Ping Operation for Nil FEC target	155
How to Diagnose Segment Routing with LSP Ping and Trace Route Nil FEC Target	155
Using LSP Ping for Nil FEC Target	155
Using LSP Traceroute for Nil FEC Target	156
Example for LSP Ping Nil FEC Target Support	156
Path Validation in Segment Routing Network	158
MPLS Ping and Traceroute for IGP Prefix-SID FEC Type	158
MPLS Ping and Traceroute for IGP-Adjacency Segment ID	159
Configuring Segment Routing MPLS Traffic Engineering for MPLS Ping and Traceroute	160
Configuring Segment Routing MPLS IGP for MPLS Ping and Traceroute	160
Verifying Segment Routing OAM Using Cisco IOS CLI	161
Verifying Segment Routing Traffic Engineering OAM Operations	161
Verifying Segment Routing OAM OSPF Using CLI	163
Verifying Segment Routing OAM IS-IS Using CLI	165
Verifying MPLS Ping and Traceroute for IGP Segment ID	165
Additional References for Segment Routing OAM Support	166
Feature Information for Segment Routing OAM Support	166

CHAPTER 16**Using Seamless BFD with Segment Routing 169**

Restrictions For Using Seamless BFD with Segment Routing	169
Information About Seamless BFD with Segment Routing	169
Bidirectional Forwarding Detection and Seamless-Bidirectional Forwarding Detection (S-BFD)	169

- Initiators and Reflectors 170
- How to Configure Seamless BFD with Segment Routing 171
 - Configuring Seamless-Bidirectional Forwarding Detection (S-BFD) for Segment Routing 171
 - Enabling Seamless Bidirectional Forwarding Detection (S-BFD) on the Reflector Node 171
 - Enabling Seamless Bidirectional Forwarding Detection (S-BFD) on the Initiator Node 171
 - Enabling Segment Routing Traffic Engineering Tunnel with Seamless-Bidirectional Forwarding (S-BFD) 171
 - Verifying S-BFD Configuration 171
- Additional References for Seamless BFD with Segment Routing 173
- Feature Information for Seamless BFD with Segment Routing 173

CHAPTER 17

Using SSPF with Segment Routing 175

- Information About SSPF with Segment Routing 175
 - Strict Shortest Path First 175
 - Approaches for Configure Strict Shortest Path First 175
- How to Configure SSPF with Segment Routing 176
 - Configuring Strict Shortest Path First (SPF) 176
 - Enabling Strict Shortest Path First Using the connect-prefix-sid-map command 176
 - Enabling Strict Shortest Path First Using Segment Routing Mapping Server 176
- Additional References for SSPF with Segment Routing 178
- Feature Information for SSPF with Segment Routing 178

CHAPTER 18

Dynamic PCC 179

- Information About Dynamic PCC 179
 - Path Computation Element Protocol Functions 179
 - Redundant Path Computation Elements 179
- How to Configure Dynamic PCC 180
 - Configuring Dynamic PCC Globally 180
 - Configuring Dynamic PCC on an Interface 180
 - Configuring Dynamic PCC With Verbatim Path Option 180
- Verifying Dynamic PCC 181
- Verifying Verbatim Path Option With Dynamic PCC 184
- Additional References for Dynamic PCC 185
- Feature Information for Dynamic PCC 185

CHAPTER 19	SR: PCE Initiated LSPs	187
	Prerequisites for SR: PCE Initiated LSPs	187
	Restrictions for SR: PCE Initiated LSPs	187
	Information About SR: PCE Initiated LSPs	187
	Overview of Path Computation Element Protocol	187
	SR: PCE Initiated LSPs	188
	Single and Redundant PCE Operations	188
	How to Configure SR: PCE Initiated LSPs	189
	Establishing a PCEP session with PCC	189
	Advertising an LSP in a Network	189
	Specifying Precedence of a PCE for PCC	189
	Verifying LSP Configurations	190
	Additional References for SR: PCE Initiated LSPs	195
	Feature Information for SR: PCE Initiated LSPs	195
<hr/>		
CHAPTER 20	ISIS - SR: uLoop Avoidance	197
	Prerequisites for ISIS - SR: uLoop Avoidance	197
	Restrictions for ISIS - SR: uLoop Avoidance	197
	Information About ISIS - SR: uLoop Avoidance	197
	Microloops	197
	Segment Routing and Microloops	200
	How Segment Routing Prevents Microloops?	200
	How to Enable ISIS - SR: uLoop Avoidance	201
	Enabling Microloop Avoidance	201
	Verifying Microloop Avoidance	201
	Additional References for ISIS - SR: uLoop Avoidance	202
	Feature Information for ISIS - SR: uLoop Avoidance	203
<hr/>		
CHAPTER 21	BGP - SR: BGP Prefix SID Redistribution	205
	Prerequisites for BGP - SR: BGP Prefix SID Redistribution	205
	Information About BGP - SR: BGP Prefix SID Redistribution	205
	Segment Routing and BGP	205
	Segment Routing for Locally Sourced Routes	206

Segment Routing for Received Prefixes 206

Segment Routing for Redistributed Routes 206

BGP--MFI Interaction 206

How to Enable BGP - SR: BGP Prefix SID Redistribution 206

 Enabling BGP-Prefix-SID 206

 Enabling BGP for Segment Routing 207

 Verifying BGP - SR: BGP Prefix SID Redistribution 207

Additional References for BGP - SR: BGP Prefix SID Redistribution 208

Feature Information for BGP - SR: BGP Prefix SID Redistribution 208

CHAPTER 22

Advertise Maximum SID Depth by IS-IS and OSPF to BGP-LS 209

 Restrictions for Advertise Maximum SID Depth by IS-IS and OSPF to BGP-LS 209

 Information About Advertise Maximum SID Depth by IS-IS and OSPF to BGP-LS 209

 Maximum SID Depth 209

 Node Maximum SID Depth Advertisement 210

 Getting the Node MSD from Hardware 211

 Advertising the MSD to BGP-LS 211

 Verifying Advertise Maximum SID Depth by IS-IS and OSPF to BGP-LS 211

 Additional References for Advertise Maximum SID Depth by IS-IS and OSPF to BGP-LS 212

 Feature Information for Advertise Maximum SID Depth by IS-IS and OSPF to BGP-LS 212



CHAPTER 1

Read Me First

Important Information about Cisco IOS XE 16

Effective Cisco IOS XE Release 3.7.0E (for Catalyst Switching) and Cisco IOS XE Release 3.17S (for Access and Edge Routing) the two releases evolve (merge) into a single version of converged release—the Cisco IOS XE 16—providing one release covering the extensive range of access and edge products in the Switching and Routing portfolio.

Feature Information

Use [Cisco Feature Navigator](#) to find information about feature support, platform support, and Cisco software image support. An account on Cisco.com is not required.

Related References

- [Cisco IOS Command References, All Releases](#)

Obtaining Documentation and Submitting a Service Request

- To receive timely, relevant information from Cisco, sign up at [Cisco Profile Manager](#).
- To get the business impact you're looking for with the technologies that matter, visit [Cisco Services](#).
- To submit a service request, visit [Cisco Support](#).
- To discover and browse secure, validated enterprise-class apps, products, solutions and services, visit [Cisco Marketplace](#).
- To obtain general networking, training, and certification titles, visit [Cisco Press](#).
- To find warranty information for a specific product or product family, access [Cisco Warranty Finder](#).



CHAPTER 2

Introduction to Segment Routing

This chapter introduces the concept of Segment Routing (SR).

- [Overview of Segment Routing, on page 3](#)
- [How Segment Routing Works, on page 4](#)
- [Examples for Segment Routing, on page 4](#)
- [Benefits of Segment Routing, on page 6](#)
- [Segment Routing Global Block, on page 8](#)
- [Additional References for Segment Routing, on page 10](#)
- [Feature Information for Introduction to Segment Routing, on page 10](#)

Overview of Segment Routing

Segment Routing (SR) is a flexible, scalable way of doing source routing. The source chooses a path and encodes it in the packet header as an ordered list of segments. Segments are identifier for any type of instruction. Each segment is identified by the segment ID (SID) consisting of a flat unsigned 32-bit integer. Segment instruction can be:

- Go to node N using the shortest path
- Go to node N over the shortest path to node M and then follow links Layer 1, Layer 2, and Layer 3
- Apply service S

With segment routing, the network no longer needs to maintain a per-application and per-flow state. Instead, it obeys the forwarding instructions provided in the packet.

Segment Routing relies on a small number of extensions to Cisco Intermediate System-to-Intermediate System (IS-IS) and Open Shortest Path First (OSPF) protocols. It can operate with an MPLS (Multiprotocol Label Switching) or an IPv6 data plane, and it integrates with the rich multi service capabilities of MPLS, including Layer 3 VPN (L3VPN), Virtual Private Wire Service (VPWS), Virtual Private LAN Service (VPLS), and Ethernet VPN (EVPN).

Segment routing can be directly applied to the Multiprotocol Label Switching (MPLS) architecture with no change in the forwarding plane. Segment routing utilizes the network bandwidth more effectively than traditional MPLS networks and offers lower latency. A segment is encoded as an MPLS label. An ordered list of segments is encoded as a stack of labels. The segment to process is on the top of the stack. The related label is popped from the stack, after the completion of a segment.

Segment routing can be applied to the IPv6 architecture with a new type of routing extension header. A segment is encoded as an IPv6 address. An ordered list of segments is encoded as an ordered list of IPv6 addresses in the routing extension header. The segment to process is indicated by a pointer in the routing extension header. The pointer is incremented, after the completion of a segment.

Segment Routing provides automatic traffic protection without any topological restrictions. The network protects traffic against link and node failures without requiring additional signaling in the network. Existing IP fast re-route (FRR) technology, in combination with the explicit routing capabilities in Segment Routing guarantees full protection coverage with optimum backup paths. Traffic protection does not impose any additional signaling requirements.

How Segment Routing Works

A router in a Segment Routing network is capable of selecting any path to forward traffic, whether it is explicit or Interior Gateway Protocol (IGP) shortest path. Segments represent subpaths that a router can combine to form a complete route to a network destination. Each segment has an identifier (Segment Identifier) that is distributed throughout the network using new IGP extensions. The extensions are equally applicable to IPv4 and IPv6 control planes. Unlike the case for traditional MPLS networks, routers in a Segment Router network do not require Label Distribution Protocol (LDP) and Resource Reservation Protocol - Traffic Engineering (RSVP-TE) to allocate or signal their segment identifiers and program their forwarding information.

Each router (node) and each link (adjacency) has an associated segment identifier (SID). Node segment identifiers are globally unique and represent the shortest path to a router as determined by the IGP. The network administrator allocates a node ID to each router from a reserved block. On the other hand, an adjacency segment ID is locally significant and represents a specific adjacency, such as egress interface, to a neighboring router. Routers automatically generate adjacency identifiers outside of the reserved block of node IDs. In an MPLS network, a segment identifier is encoded as an MPLS label stack entry. Segment IDs direct the data along a specified path. There are two kinds of segment IDs:

- **Prefix SID**— A segment ID that contains an IP address prefix calculated by an IGP in the service provider core network. Prefix SIDs are globally unique. A prefix segment represents the shortest path (as computed by IGP) to reach a specific prefix; a node segment is a special prefix segment that is bound to the loopback address of a node. It is advertised as an index into the node specific SR Global Block or SRGB.
- **Adjacency SID**— A segment ID that contains an advertising router's adjacency to a neighbor. An adjacency SID is a link between two routers. Since the adjacency SID is relative to a specific router, it is locally unique.

A node segment can be a multi-hop path while an adjacency segment is a one-hop path.

Examples for Segment Routing

The following figure illustrates an MPLS network with five routers using Segment Routing, IS-IS, a label range of 100 to 199 for node IDs, and 200 and higher for adjacency IDs. IS-IS would distribute IP prefix reachability alongside segment ID (the MPLS label) across the network.

Figure 1: An MPLS Network with Five Routers Using Segment Routing

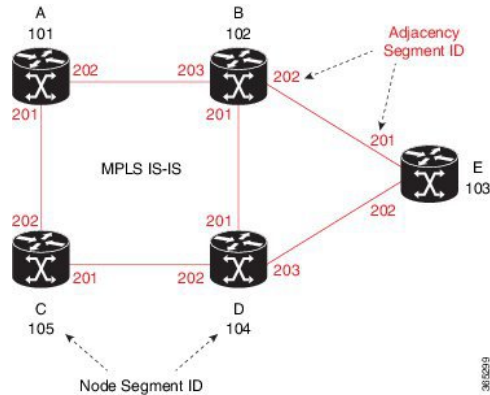

In the previous example, any router sending traffic to router E would push label 103 (router E node segment identifier) to forward traffic using the IS-IS shortest path. The MPLS label-swapping operation at each hop preserves label 103 until the packet arrives at E (Figure 2). On the other hand, adjacency segments behave differently. For example, if a packet arrives at Router D with a top-of-stack MPLS label of 203 (D-to-E adjacency segment identifier), Router D would pop the label and forward the traffic to Router E.

Figure 2: MPLS Label-Swapping Operation

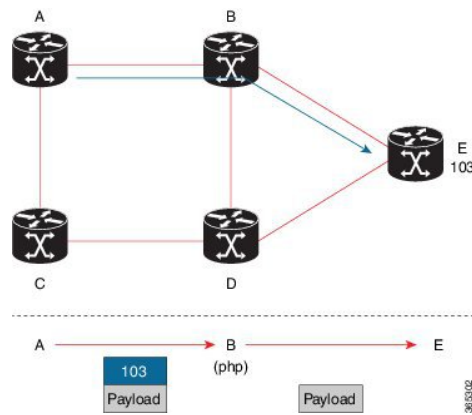

Segment identifiers can be combined as an ordered list to perform traffic engineering. A segment list can contain several adjacency segments, several node segments, or a combination of both depending on the forwarding requirements. In the previous example, Router A could alternatively push label stack (104, 203) to reach Router E using the shortest path and all applicable ECMPs to Router D and then through an explicit interface onto the destination (Figure 3). Router A does not need to signal the new path, and the state information remains constant in the network. Router A ultimately enforces a forwarding policy that determines which flows destined to router E are switched through a particular path.

Figure 3: Router E Destination Path

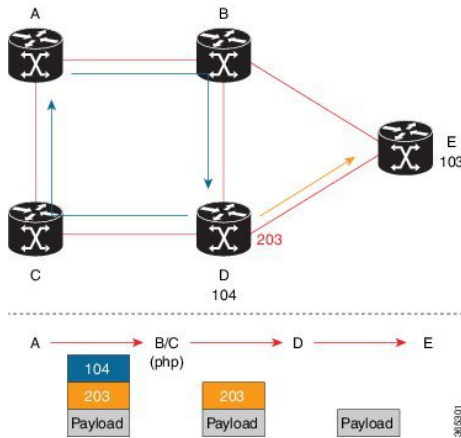

Benefits of Segment Routing

- Ready for SDN**— Segment Routing is a compelling architecture conceived to embrace Software-Defined Network (SDN) and is the foundation for Application Engineered Routing (AER). It strikes a balance between network-based distributed intelligence, such as automatic link and node protection, and controller-based centralized intelligence, such as traffic optimization. It can provide strict network performance guarantees, efficient use of network resources, and very high scalability for application-based transactions. The network uses minimal state information to meet these requirements. Segment routing can be easily integrated with a controller-based SDN architecture. Below figure illustrates a sample SDN scenario where the controller performs centralized optimization, including bandwidth admission control. In this scenario, the controller has a complete picture of the network topology and flows. A router can request a path to a destination with certain characteristics, for example, delay, bandwidth, diversity. The controller computes an optimal path and returns the corresponding segment list, such as an MPLS label stack, to the requesting router. At that point, the router can inject traffic with the segment list without any additional signaling in the network.

Figure 4: SDN Controller

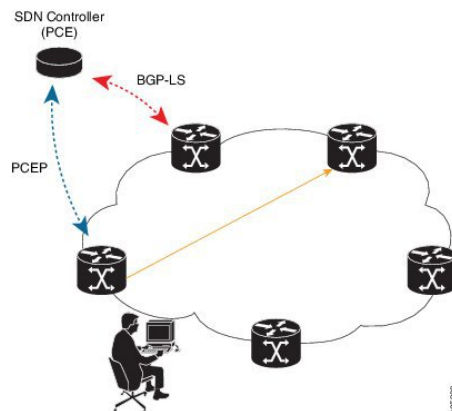

- In addition, segment lists allow complete network virtualization without adding any application state to the network. The state is encoded in the packet as a list of segments. Because the network only maintains

segment state, it can support a large number - and a higher frequency - of transaction-based application requests without creating any burden on the network.

- **Simplified**—

- When applied to the MPLS data plane, Segment Routing offers the ability to tunnel MPLS services (VPN, VPLS, and VPWS) from an ingress provider edge to an egress provider edge without any other protocol than an IGP (ISIS or OSPF).
- Simpler operation without separate protocols for label distribution (for example, no LDP or RSVP).
- No complex LDP or IGP synchronization to troubleshoot.
- Better utilization of installed infrastructure, for lower capital expenditures (CapEx), with ECMP-aware shortest path forwarding (using node segment IDs).

- **Supports Fast Reroute (FRR)**— Deliver automated FRR for any topology. In case of link or node failures in a network, MPLS uses the FRR mechanism for convergence. With segment routing, the convergence time is sub-50-msec.

- **Large-scale Data Center-**

- Segment Routing simplifies MPLS-enabled data center designs using Border Gateway Protocol (BGP) RFC 3107 - IPv4 labeled unicast among Top-of-the-Rack/Leaf/Spine switches.
- BGP distributes the node segment ID, equivalent to IGP node SID.
- Any node within the topology allocates the same BGP segment for the same switch.
- The same benefits are provided as for IGP node SID: ECMP and automated FRR (BGP PIC(Prefix Independent Convergence)).
- This is a building block for traffic engineering - SR TE data center fabric optimization.

- **Scalable**—

- Avoid thousands of labels in LDP database.
- Avoid thousands of MPLS Traffic Engineering LSP's in the network.
- Avoid thousands of tunnels to configure.

- **Dual-plane Networks**—

- Segment Routing provides a simple solution for disjointness enforcement within a so-called “dual-plane” network, where the route to an edge destination from a given plane stays within the plane unless the plane is partitioned.
- An additional SID “anycast” segment ID allows the expression of macro policies such as: "Flow 1 injected in node A toward node Z must go via plane 1" and "Flow 2 injected in node A towards node Z must go via plane 2."

- **Centralized Traffic Engineering**—

- Controllers and orchestration platforms can interact with Segment Routing traffic engineering for centralized optimization, such as WAN optimization.

- Network changes such as congestion can trigger an application to optimize (recompute) the placement of segment routing traffic engineering tunnels.
 - Segment Routing tunnels are dynamically programmed onto the network from an orchestrator using southbound protocols like PCE.
 - Agile network programming is possible since Segment Routing tunnels do not require signaling and per-flow state at midpoints and tail end routers.
- **Egress Peering Traffic Engineering (EPE)**—
 - Segment Routing allows centralized EPE.
 - A controller instructs an ingress provider edge and content source to use a specific egress provider edge and specific external interface to reach a destination.
 - BGP “peering” segment IDs are used to express source-routed inter-domain paths.
 - Controllers learn BGP peering SIDs and the external topology of the egress border router through BGP Link Status (BGP-LS) EPE routes.
 - Controllers program ingress points with a desired path.
 - **Plug-and-Play deployment**— Segment routing tunnels are interoperable with existing MPLS control and data planes and can be implemented in an existing deployment.

Segment Routing Global Block

Segment Routing Global Block (SRGB) is the range of labels reserved for segment routing. SRGB is local property of an segment routing node. In MPLS, architecture, SRGB is the set of local labels reserved for global segments. In segment routing, each node can be configured with a different SRGB value and hence the absolute SID value associated to an IGP Prefix Segment can change from node to node.

The SRGB default value is 16000 to 23999. The SRGB can be configured as follows:

```
Device(config)# router isis 1
Device(config-isis)#segment-routing global-block 45000 55000
```

The SRGB label value is calculated as follows:

- If the platform supports 1000000 labels or more, the SRGB value is from 900000 to $900000 + 2^{16}$.
- If the platform supports less than 1000000 labels, the SRGB value is the last 2^{16} labels.

Restrictions:

- The SRGB size cannot be more than 2^{16} .
- The SRGB upper bound cannot exceed the platform capability.
- The SRGB cannot be configured to be the same value as the default SRGB. So SRGB cannot be configured for 16000 to 23999.

Segment Routing Global Block

This chapter explains the concept of creating a block of labels reserved for a router using segment routing. This block of reserved labels is known as the Segment Routing Global Block (SRGB).

Adjacency Segment Identifiers

The Adjacency Segment Identifier (adj-SID) is a local label that points to a specific interface and a next hop out of that interface. No specific configuration is required to enable adj-SIDs. Once segment routing is enabled over IS-IS for an address-family, for any interface that IS-IS runs over, the address-family automatically allocates an adj-SID towards every neighbor out of that interface.



Note Only IPv4 address-family supports allocating adj-SIDs.

Prefix Segment Identifiers

A prefix segment identifier (SID) identifies a segment routing tunnel leading to the destination represented by a prefix. The maximum prefix SID value is $2^{16} - 1$.

A prefix SID is allocated from the Segment Routing Global Block (SRGB). The prefix SID value translates to a local MPLS label, whose value is calculated as below:

- If the platform supports 1000000 labels or more, then the MPLS label corresponding to the prefix SID value is $900000 + sid\text{-value}$.
- If the platform supports less than 1000000 labels, then the MPLS label corresponding to the prefix SID value is $maximum\text{-supported-label-value} - 2^{16} + sid\text{-value}$.

When a prefix SID value x is configured, the prefix SID translates to a label value equivalent to $x +$ lower boundary of SRGB. For example, in the platform supporting 1000000 MPLS labels or more if the default SRGB is used, configuring a prefix-SID of 10 for interface Loopback 0 with IPv4 address 1.0.0.1/32 results in assigning the label 9000010 16010 to the prefix 1.0.0.1/32.

BGP Prefix Segment Identifiers

Segments associated with a BGP prefix are known as BGP Prefix-SIDs.

- BGP Prefix-SIDs are always global within a Segment Routing or BGP domain
- BGP Prefix-SIDs identifies an instruction to forward the packet over ECMP-aware best path computed by BGP for a given prefix

Segment Routing requires BGP speaker to be configured with a Segment Routing Global block (SRGB). Generally, SRGB is configured as a range of labels, $SRGB = [SR_S, SR_E]$.

- SR_S = Start of the range
- SR_E = End of the range

Each prefix is assigned with its own unique label index.

In the following example, a BGP route policy, set label index, is defined using the route-policy **name** command.

Configure the Segment Routing Global Block (SRGB) in BGP. If the route label path has a label-index attribute and SRGB is configured, then local label route is allocated from SRGB. If label-index is added to redistributed routes using route-policy, then BGP presents label-index as an attribute with the route.

```
router bgp 100
  bgp log-neighbor-changes
  neighbor 192.0.2.1 remote-as 100
  neighbor 192.0.2.1 update-source Loopback0
  neighbor 192.0.23.3 remote-as 300
  !
  address-family ipv4
    segment-routing mpls
    neighbor 192.0.2.1 activate
    neighbor 192.0.2.1 send-label
    neighbor 192.0.23.3 activate
  exit-address-family
```

Additional References for Segment Routing

Related Documents

Related Topic	Document Title
Videos	<ul style="list-style-type: none"> • Introduction to Cisco Segment Routing (YouTube) • Introduction to Cisco Segment Routing (CCO)

Feature Information for Introduction to Segment Routing

The following table provides release information about the feature or features described in this module. This table lists only the software release that introduced support for a given feature in a given software release train. Unless noted otherwise, subsequent releases of that software release train also support that feature.

Use Cisco Feature Navigator to find information about platform support and Cisco software image support. To access Cisco Feature Navigator, go to www.cisco.com/go/cfn. An account on Cisco.com is not required.

Table 1: Feature Information for Introduction to Segment Routing

Feature Name	Releases	Feature Information
Introduction to Segment Routing	Cisco IOS XE Release 3.16S Cisco IOS XE Fuji 16.7.1	Segment Routing (SR) is a flexible, scalable way of doing source routing. In Cisco IOS XE Fuji 16.7.1, this feature is supported on Cisco 4000 Series Integrated Service Routers.



CHAPTER 3

Segment Routing With IS-IS v4 Node SID

This chapter describes how Segment Routing (SR) works with IS-IS.

- [Restrictions for Segment Routing With IS-IS v4 Node SID, on page 11](#)
- [Information About Segment Routing IS-IS v4 Node SID, on page 11](#)
- [How to Configure Segment Routing —IS-IS v4 Node SID, on page 14](#)
- [Configuration Examples for Segment Routing —IS-IS v4 Node SID, on page 22](#)
- [Additional References for Segment Routing With IS-IS v4 Node SID, on page 23](#)
- [Feature Information for Segment Routing—IS-IS v4 Node SID, on page 23](#)

Restrictions for Segment Routing With IS-IS v4 Node SID

- Segment routing must be configured at the top level before any routing protocol configuration is allowed under its router configuration sub mode.
- IS-IS protocol SR command is based on per topology (IPv4 address family).
- Effective Cisco IOS-XE Release 3.16, ISIS supports segment routing for IPv4 only.

Information About Segment Routing IS-IS v4 Node SID

Segment Routing IS-IS v4 Node SID

Segment Routing relies on a small number of extensions to Cisco Intermediate System-to-Intermediate System (IS-IS) and Open Shortest Path First (OSPF) protocols. There are two levels of configuration required to enable segment routing for a routing protocol instance. The top level segment routing configuration which is managed by segment routing infrastructure component enables segment routing, whereas, segment routing configuration at the router level enables segment routing for a specific address-family of a routing protocol instance. There are three segment routing states:

- SR_NOT_CONFIGURED
- SR_DISABLED
- SR_ENABLED

Segment routing configuration under the IGPs is allowed only if the SR state is either SR_DISABLED or SR_ENABLED. The SR_ENABLED state indicates that there is at least a valid SRGB range reserved through

the MFI successfully. You can enable segment routing for IGP's under the router configuration sub mode, through commands. However, IGP segment routing are enabled only after the global SR is configured.



Note IS-IS protocol SR command is based on per topology (IPv4 address family).

The SR_ENABLED is a necessary state for any protocol to enable SR, however, it is not a sufficient for enabling SR for a protocol instance. The reason being that the IS-IS still does not have any information about segment routing global block (SRGB) information. When the request to receive information about the SRGB is processed successfully, the IS-IS SR operational state is enabled.

Segment Routing requires each router to advertise its segment routing data-plane capability and the range of MPLS label values that are used for segment routing in the case where global SIDs are allocated. Data-plane capabilities and label ranges are advertised using the SR-capabilities sub-TLV inserted into the IS-IS Router Capability TLV-242 that is defined in RFC4971.

ISIS SR-capabilities sub TLV includes all reserved SRGB ranges. However, the Cisco implementation supports only one SRGB range. The supported IPv4 prefix-SID sub TLV are TLV-135 and TLV-235.

Prefix-SID Received in Label Switched Path from Remote Routers

Prefix SIDs received in a label switched path (LSP) with a reachability TLV (TLV 135 and 235) are downloaded to the routing information base (RIB) in the same way as BGP downloads per prefix VPN labels, only if the following conditions are met:

- Segment routing is enabled for the topology and address-family.
- Prefix-SID is valid.
- The local label binding to MFI is successful.



- Note**
- For SIDs that do not fit in the specified SID range, labels are not used when updating the RIB. For the cases, where SID fits in the SID range, but does not fit the next-hop neighbor SID range, remote label associated with that path is not installed.
 - Node SIDs received in an LSP with reachability TLVs (TLV 135 and 235) are downloaded to RIB only if segment routing is enabled under the corresponding address-family.
 - In case of multiple best next hops, if all the next hops do not support segment routing, ISIS treats the instance similar to mismatched labels assigned to the same prefix. That means, IS-IS ignores the labels and installs unlabeled paths for all ECMP paths into the global RIB.

Segment Routing Adjacency SID Advertisement

Effective with Cisco IOS-XE Release 3.17, IS-IS supports the advertisement of segment routing adjacency SID. An Adjacency Segment Identifier (Adj-SID) represents a router adjacency in Segment Routing.

A segment routing-capable router may allocate an Adj-SID for each of its adjacencies and an Adj-SID sub-TLV is defined to carry this SID in the Adjacency TLVs. IS-IS adjacencies are advertised using one of the IS-Neighbor TLVs below:

- TLV-22 [RFC5305]
- TLV-23 [RFC5311]

IS-IS allocates the adjacency SID for each IS-IS neighbor only if the IS-IS adjacency state is up and IS-IS segment routing internal operational state is enabled. If an adjacency SID allocation failure is due to out-of-label resource, IS-IS retries to allocate the Adj-SID periodically in a default interval (30 seconds).

Multiple Adjacency-SIDs

Effective with Cisco IOS-XE Release 3.18, multiple adjacency-SIDs are supported. For each protected P2P/LAN adjacency, IS-IS allocates two Adj-SIDs. The backup Adj-SID is only allocated and advertised when FRR (local LFA) is enabled on the interface. If FRR is disabled, then the backup adjacency-SID is released. The persistence of protected adj-SID in forwarding plane is supported. When the primary link is down, IS-IS delays the release of its backup Adj-SID until the delay timer expires. This allows the forwarding plane to continue to forward the traffic through the backup path until the router is converged.

Cisco IOS-XE Release 3.18, IS-IS Adj-SID is changed to be per level based since the forwarding plane is unaware of protocol-specific levels. The allocated and advertised backup Adj-SIDs can be displayed in the output of **show isis neighbor detail** and **show isis data verbose** commands.

Segment Routing Mapping Server (SRMS)

Segment Routing Mapping Server (SRMS) allows configuration and maintenance of the Prefix-SID mapping policy entries. Effective with Cisco IOS-XE Release 3.17, the IGP uses the active policy of the SRMS to determine the SID values when programming the forwarding plane.

The SRMS provides prefixes to SID/Label mapping policy for the network. IGPs, on the other hand, are responsible for advertising prefixes to SID/Label mapping policy through the Prefix-SID/Label Binding TLV. Active policy information and changes are notified to the IGPs, which use active policy information to update forwarding information.

Connected Prefix SIDs

Sometimes, a router may install a prefix with a SID that is different than what it advertises to the LSP. For example, if more than one protocol or more than one IGP instance is announcing the same prefix with different SIDs to the SRMS, the SRMS resolves the conflict and announces the winning prefix and SID that may not be the same as the local instance. In that case, the IGP always advertises what it learns from its source LSP although it still tries to install the SID which may be different than what it learns in its LSP. This is done to prevent the IGP from redistributing the SIDs from another protocol or another protocol instance.

SRGB Range Changes

When IS-IS segment routing is configured, IS-IS must request an interaction with the SRGB before IS-IS SR operational state can be enabled. If no SRGB range is created, IS-IS will not be enabled.

When an SRGB change event occurs, IS-IS makes the corresponding changes in its sub-block entries. IS-IS also advertises the newly created or extended SRGB range in SR-capabilities sub-TLV and updates the prefix-sid sub TLV advertisement.



Note In Cisco IOS-XE Release 3.16 only one SRGB range and SRGB extension for the modification are supported.

SRGB Deletion

When IS-IS receives an SRGB deletion event, it looks for an SRGB entry in the IS-IS SRGB queue list. If an SRGB entry does not exist, IS-IS makes sure that there is no pending SRGB created event. If a pending SRGB creation event is found, then IS-IS removes the SRGB creation event, and completes the SRGB delete processing.

If an SRGB entry is found in the IS-IS SRGB queue, IS-IS locks the SRGB, redistributes the RIBs and un-advertises all prefixed-SIDs that have SID value within the pending delete SRGB range, and un-advertises the SRGB range from SR-capabilities sub TLV. Once IS-IS has completed the SRGB deletion processing, it unlocks the SRGB and deletes the SRGB from its SR sub-block entry.

If there is no valid SRGB after the deletion of the SRGB, IS-IS SR operational state becomes disabled.

MPLS Forwarding on an Interface

MPLS forwarding must be enabled before segment routing can use an interface. IS-IS is responsible for enabling MPLS forwarding on an interface.

When segment routing is enabled for a IS-IS topology, or IS-IS segment routing operational state is enabled, IS-IS enables MPLS for any interface on which the IS-IS topology is active. Similarly, when segment routing is disabled for a IS-IS topology, IS-IS disables the MPLS forwarding on all interfaces for that topology.

Segment Routing and LDP Preference

The command **sr-label-preferred** allows the forwarding interface to prefer the segment routing labels over LDP labels for all prefixes in a topology.

Segment Routing -Traffic Engineering Announcements

IS-IS announces the SR information to TE when it detects that both, IS-IS SR and TE are enabled for at least one level. IS-IS announce only the information that is obtained from the level for which TE is configured.

Similarly, IS-IS instructs TE to delete all announcements when it detects that SR is not enabled or TE is no longer configured on any level.

How to Configure Segment Routing —IS-IS v4 Node SID

Configuring Segment Routing

Before you begin

Before configuring IS-IS to support segment routing you must first configure the segment routing feature in global configuration mode.

SUMMARY STEPS

1. **enable**
2. **configure terminal**

3. segment-routing mpls
4. connected-prefix-sid-map
5. address-family ipv4
6. 1.1.1.1/32 index 100 range 1
7. exit-address-family

DETAILED STEPS

	Command or Action	Purpose
Step 1	enable Example: Device# enable	Enables privileged EXEC mode. <ul style="list-style-type: none"> • Enter your password if prompted.
Step 2	configure terminal Example: Device# configure terminal	Enters global configuration mode.
Step 3	segment-routing mpls Example: Device(config-sr)# segment-routing mpls	Enables the segment feature using the mpls data plane.
Step 4	connected-prefix-sid-map Example: Device(config-srmppls)# connected-prefix-sid-map	Enters a sub-mode where you can configure address-family specific mappings for local prefixes and SIDs.
Step 5	address-family ipv4 Example: Device(config-srmppls-conn)# address-family ipv4	Specifies IPv4 address prefixes.
Step 6	1.1.1.1/32 index 100 range 1 Example: Device(config-srmppls-conn-af)# 1.1.1.1/32 100 range 1	Associates SID 100 with the address 1.1.1.1/32.
Step 7	exit-address-family Example: Device(config-srmppls-conn-af)# exit-address-family	Exits the address family.

Configuring Segment Routing on IS-IS Network

Before you begin

Before you configure segment routing on IS-IS network, IS-IS must be enabled on your network.

SUMMARY STEPS

1. router isis
2. net network-entity-title
3. metric-style wide
4. **segment-routing** mpls
5. exit
6. show isis segment-routing

DETAILED STEPS

	Command or Action	Purpose
Step 1	router isis Example: Device(config-router)# router isis	Enables the IS-IS routing protocol and enters router configuration mode.
Step 2	net network-entity-title Example: Device(config-router)# net 49.0000.0000.0003.00	Configures network entity titles (NETs) for the routing instance.
Step 3	metric-style wide Example: Device(config-router)# metric-style wide	Configures the device to generate and accept only wide link metrics.
Step 4	segment-routing mpls Example: Device(config-router)# segment-routing mpls	Configures segment routing operation state.
Step 5	exit Example: Device(config-router)# exit	Exits segment routing mode and returns to the configuration terminal mode.
Step 6	show isis segment-routing Example: Device# show is-is segment-routing	Displays the current state of the IS-IS segment routing.

Example

The following example displays output from the `show isis segment-routing state` command for the segment routing under IS-IS:

```
Device# show isis segment-routing

ISIS protocol is registered with MFI
ISIS MFI Client ID:0x63
Tag 1 - Segment-Routing:
  SR State:SR_ENABLED
  Number of SRGB:1
  SRGB Start:16000, Range:8000, srgb_handle:0x4500AED0, srgb_state: created
  Address-family IPv4 unicast SR is configured
  Operational state:Enabled
```

Configuring Prefix-SID for IS-IS

This task explains how to configure prefix segment identifier (SID) index under each interface.

Before you begin

Segment routing must be enabled on the corresponding address family.

SUMMARY STEPS

1. enable
2. configure terminal
3. segment-routing mpls
4. connected-prefix-sid-map
5. address-family ipv4
6. 1.1.1.1/32 index 100 range 1
7. exit

DETAILED STEPS

	Command or Action	Purpose
Step 1	enable Example: Device# enable	Enables privileged EXEC mode.
Step 2	configure terminal Example: Device# configure terminal	Enters global configuration mode.
Step 3	segment-routing mpls Example:	Configures segment routing mpls mode.

	Command or Action	Purpose
	Device(config)# segment-routing mpls	
Step 4	connected-prefix-sid-map Example: Device(config-srmppls)# connected-prefix-sid-map	Enters a sub-mode where you can configure address-family specific mappings for local prefixes and SIDs.
Step 5	address-family ipv4 Example: Device(config-srmppls-conn)# address-family ipv4	Specifies the IPv4 address family and enters router address family configuration mode.
Step 6	1.1.1.1/32 index 100 range 1 Example: Device(config-srmppls-conn-af)# 1.1.1.1/32 100 range 1	Associates SID 100 with the address 1.1.1.1/32.
Step 7	exit Example: Device(config-router)# exit	Exits segment routing mode and returns to the configuration terminal mode.

Configuring Prefix Attribute N-flag-clear

By default, a flag called N-flag is set by IS-IS when advertising a SID which is associated with a loopback address. If you wish to clear this flag add explicit configuration.

SUMMARY STEPS

1. enable
2. configure terminal
3. interface loopback3
4. isis prefix n-flag-clear

DETAILED STEPS

	Command or Action	Purpose
Step 1	enable Example: Device# enable	Enables privileged EXEC mode. <ul style="list-style-type: none"> • Enter your password if prompted.
Step 2	configure terminal Example:	Enters global configuration mode.

	Command or Action	Purpose
	Device# configure terminal	
Step 3	interface loopback3 Example: Device(config)# interface loopback3	Specifies the interface loopback.
Step 4	isis prefix n-flag-clear Example: Device(config-if)# isis prefix n-flag-clear	Clears the prefix N-flag.

Configuring Explicit Null Attribute

To disable penultimate-hop-popping (PHP) and add explicit-Null label, explicit-null option needs to be specified. Once the option is given, IS-IS sets the E flag in the prefix-SID sub TLV.

By default, a flag called E-flag (Explicit-Null flag) is set to 0 by ISIS when advertising a Prefix SID which is associated with a loopback address. If you wish to set this flag add explicit configuration.

SUMMARY STEPS

1. enable
2. configure terminal
3. segment-routing mpls
4. set-attributes
5. address-family ipv4
6. explicit-null
7. exit-address-family

DETAILED STEPS

	Command or Action	Purpose
Step 1	enable Example: Device# enable	Enables privileged EXEC mode. <ul style="list-style-type: none"> • Enter your password if prompted.
Step 2	configure terminal Example: Device# configure terminal	Enters global configuration mode.
Step 3	segment-routing mpls Example:	Configures segment routing mpls mode.

	Command or Action	Purpose
	Device(config)# segment-routing mpls	
Step 4	set-attributes Example: Device(config-srmppls)# set-attributes	Sets the attribute.
Step 5	address-family ipv4 Example: Device(config-srmppls-attr)# address-family ipv4	Specifies the IPv4 address family and enters router address family configuration mode.
Step 6	explicit-null Example: Device(config-srmppls-attr-af)# explicit-null	Specifies the explicit-null.
Step 7	exit-address-family Example: Device(config-srmppls-attr-af)# exit-address-family	Exits the address family.

Configuring Segment Routing Label Distribution Protocol Preference

SUMMARY STEPS

1. enable
2. configure terminal
3. segment-routing mpls
4. set-attributes
5. address-family ipv4
6. sr-label-preferred
7. exit-address-family

DETAILED STEPS

	Command or Action	Purpose
Step 1	enable Example: Device# enable	Enables privileged EXEC mode. <ul style="list-style-type: none"> • Enter your password if prompted.
Step 2	configure terminal Example:	Enters global configuration mode.

	Command or Action	Purpose
	Device# configure terminal	
Step 3	segment-routing mpls Example: Device(config)# segment-routing mpls	Configures segment routing mpls mode.
Step 4	set-attributes Example: Device(config-srmppls)# set-attributes	Sets the attribute.
Step 5	address-family ipv4 Example: Device(config-srmppls-attr)# address-family ipv4	Specifies the IPv4 address family and enters router address family configuration mode.
Step 6	sr-label-preferred Example: Device(config-srmppls-attr-af)# sr-label-preferred	Specifies SR label to be preferred over the LDP.
Step 7	exit-address-family Example: Device(config-srmppls-attr-af)# exit-address-family	Exits the address family.

Configuring IS-IS SRMS

The following command enables the IS-IS SRMS and allows IS-IS to advertise local mapping entries. IS-IS does not send remote entries to the SRMS library. However, IS-IS uses the SRMS active policy, which is computed based only on the locally configured mapping entries.

```
[no] segment-routing prefix-sid-map advertise-local
```

Configuring IS-IS SRMS Client

By default, the IS-IS SRMS client mode is enabled. IS-IS always sends remote prefix-sid-mapping entries received through LSP to SRMS. The SRMS active policy is calculated based on local and remote mapping entries.

The following command disables the prefix-sid-mapping client functionality and it is configured on the receiver side.

```
segment-routing prefix-sid-map receive [disable]
```

Configuring IS-IS SID Binding TLV Domain Flooding

By default, the IS-IS SRMS server does not flood SID binding entries within the routing domain. From Cisco IOS-XE Release 3.18, the optional keyword **domain-wide** is added in the IS-IS SRMS server mode command to enable the SID and Label binding TLV flooding functionality.

```
segment-routing prefix-sid-map advertise-local [domain-wide]
```

The **domain-wide** keyword enables the IS-IS SRMS server to advertise SID binding TLV across the entire routing domain.



Note The option is valid only if IS-IS SRMS performs in the SRMS server mode.

Configuration Examples for Segment Routing —IS-IS v4 Node SID

Example: Configuring Segment Routing on IS-IS Network

The following example shows how to configure prefix segment identifier (SID) index under each interface:

```
Device(config)#segment-routing mpls
Device(config-srmppls)#connected-prefix-sid-map
Device(config-srmppls-conn)#address-family ipv4
Device(config-srmppls-conn-af)#10.1.2.2/32 index 2 range 1
Device(config-srmppls-conn-af)#exit-address-family
Device(config-srmppls-conn-af)#end
```

Example: Configuring Explicit Null Attribute

The following is an example for configuring explicit null attribute:

```
Device(config)# segment-routing mpls
Device(config-srmppls)# set-attributes
Device(config-srmppls-attr)# address-family ipv4
Device(config-srmppls-attr-af)# explicit-null
Device (config-srmppls-attr-af)# exit-address-family
```

Additional References for Segment Routing With IS-IS v4 Node SID

Related Documents

Related Topic	Document Title
Cisco IOS commands	Cisco IOS Master Command List, All Releases http://www.cisco.com/c/en/us/td/docs/ios-xml/ios/mcl/allreleasemcl/all-book.html
IP Routing ISIS commands	Cisco IOS IP Routing ISIS commands http://www.cisco.com/c/en/us/td/docs/ios-xml/ios/mcl/allreleasemcl/all-book.html

RFCs

RFC	Title
RFC4971	Intermediate System to Intermediate System (IS-IS) Extensions for Advertising Router Information
RFC5305	IS-IS Extensions for Traffic Engineering. Defines the advertisement of router IDs for IPv4.
RFC6119	IPv6 Traffic Engineering in IS-IS. Defines the advertisement of router IDs for IPv6.

Feature Information for Segment Routing—IS-IS v4 Node SID

The following table provides release information about the feature or features described in this module. This table lists only the software release that introduced support for a given feature in a given software release train. Unless noted otherwise, subsequent releases of that software release train also support that feature.

Use Cisco Feature Navigator to find information about platform support and Cisco software image support. To access Cisco Feature Navigator, go to www.cisco.com/go/cfn. An account on Cisco.com is not required.

Table 2: Feature Information for Segment Routing—IS-IS v4 Node SID

Feature Name	Releases	Feature Information
Segment Routing—IS-IS v4 Node SID	Cisco IOS XE Release 3.16S Cisco IOS XE Fuji 16.7.1	The Segment Routing—ISIS v4 node SID feature provides support for segment routing on IS-IS networks. The following commands were introduced or modified: connected-prefix-sid-map , show isis segment-routing , isis prefix n-flag-clear , explicit-null In Cisco IOS XE Fuji 16.7.1, this feature is supported on Cisco 4000 Series Integrated Service Routers.



CHAPTER 4

IS-IS Link-protection Topology Independent Loop Free Alternate Fast Reroute

This document describes the functionalities and IS-IS implementation of IP Fast Re-Route feature (IPFRR) using Segment Routing (SR) Topology Independent Loop Free Alternative (TI-LFA) link protection.

- [Prerequisites for IS-IS Link-protection Topology Independent Loop Free Alternate Fast Reroute, on page 25](#)
- [Information About IS-IS Link-protection Topology Independent Loop Free Alternate Fast Reroute, on page 27](#)
- [How to Configure IS-IS Link-protection Topology Independent Loop Free Alternate Fast Reroute, on page 29](#)
- [Additional References for IS-IS Link-protection Topology Independent Loop Free Alternate Fast Reroute, on page 39](#)
- [Feature Information for IS-IS Link-protection Topology Independent Loop Free Alternate Fast Reroute, on page 39](#)

Prerequisites for IS-IS Link-protection Topology Independent Loop Free Alternate Fast Reroute

- Enable TI-LFA on all the nodes, before configuring SR-TE for TI-LFA.

```
mpls traffic-eng tunnels
!
segment-routing mpls
  connected-prefix-sid-map
  address-family ipv4
    1.1.1.1/32 index 11 range 1
  exit-address-family
!
interface Loopback1
  ip address 1.1.1.1 255.255.255.255
  ip router isis 1
!
interface Tunnell
  ip unnumbered Loopback1
  tunnel mode mpls traffic-eng
  tunnel destination 6.6.6.6
  tunnel mpls traffic-eng autoroute announce
```

```

    tunnel mpls traffic-eng path-option 10 explicit name IP_PATH segment-routing
!
interface GigabitEthernet2
 ip address 192.168.1.1 255.255.255.0
 ip router isis 1
 negotiation auto
 mpls traffic-eng tunnels
 isis network point-to-point
!
interface GigabitEthernet3
 ip address 192.168.2.1 255.255.255.0
 ip router isis 1
 negotiation auto
 mpls traffic-eng tunnels
 isis network point-to-point
!
router isis 1
 net 49.0001.0010.0100.1001.00
 is-type level-1
 metric-style wide
 log-adjacency-changes
 segment-routing mpls
 fast-reroute per-prefix level-1 all
 fast-reroute ti-lfa level-1
 mpls traffic-eng router-id Loopback1
 mpls traffic-eng level-1
!
 ip explicit-path name IP_PATH enable
 next-address 4.4.4.4
 next-address 5.5.5.5
 next-address 6.6.6.6

```

- If a microloop gets created between routers in case of primary and secondary path switch over you need to bring down the convergence time. Use the **microloop avoidance rib-update-delay** command to bring down the convergence time:

```

router isis ipfrr
 net 49.0001.0120.1201.2012.00
 is-type level-2-only
 metric-style wide
 log-adjacency-changes
 segment-routing mpls
 segment-routing prefix-sid-map advertise-local
 fast-reroute per-prefix level-2 all
 fast-reroute ti-lfa level-2
 microloop avoidance rib-update-delay 10000

```

- Enable MPLS-TE nonstop routing (NSR) and IS-IS nonstop forwarding (NSF) to reduce or minimize traffic loss after a high availability (HA) switch over. Use the **mpls traffic-eng nsr** command in global exec mode.

```
mpls traffic-eng nsr
```

Use the **nsf** command under IS-IS.

```

router isis
 nsf cisco
 nsf interval 0

```

Information About IS-IS Link-protection Topology Independent Loop Free Alternate Fast Reroute

When the local LFA and remote LFA are enabled, there is a good coverage of the prefixes to be protected. However, for some rare topologies that do not have a PQ intersect node, both local and remote LFA will fail to find a release node to protect the failed link. Furthermore, there is no way to prefer a post-convergence path, as the two algorithms have no knowledge of the post-convergence characteristics of the LFA.

To overcome the above limitation, effective Cisco IOS-XE Release 3.18, topology-independent LFA (TI-LFA) is supported on an SR-enabled network.

Topology-Independent Loop Free Alternate

TI-LFA provides supports for the following:

- Link Protection—The LFA provides repair path for failure of the link.
- Local LFA—Whenever a local LFA on the post convergence path is available, it is preferred over TI-LFA because local LFA does not require additional SID for the repair path. That is, the label for the PQ node is not needed for the release node.
- Local LFA for extended P space—For nodes in the extended P space, local LFA is still the most economical method for the repair path. In this case, TI-LFA will not be chosen.
- Tunnel to PQ intersect node—This is similar to remote LFA except that the repair path is guaranteed on the post convergence path using TI-LFA.
- Tunnel to PQ disjoint node—This capability is unique to the TI-LFA in the case when local and remote LFA cannot find a repair path.
- Tunnel to traverse multiple intersect or disjoint PQ nodes, up to the platform's maximum supported labels—TI-LFA provides complete coverage of all prefixes.
- P2P interfaces for the protected link—TI-LFA protects P2P interfaces.
- Asymmetrical links—The ISIS metrics between the neighbors are not the same.
- Multi-homed (anycast) prefix protection—The same prefix may be originated by multiple nodes.
- Protected prefix filtering—The route-map includes or excludes a list of prefixes to be protected and the option to limit the maximum repair distance to the release node.
- Tiebreakers—A subset of existing tiebreakers, applicable to TI-LFA, is supported.

Topology Independent Loop Free Alternate Tie-break

Local and remote LFA use default or user-configured heuristics to break the tie when there is more than one path to protect the prefix. The attributes are used to trim down the number of repair paths at the end of the TI-LFA link protection computation before the load balancing. Local LFA and remote LFA support the following tiebreakers:

- Linecard-disjoint—Prefers the line card disjoint repair path
- Lowest-backup-path-metric—Prefers the repair path with lowest total metric
- Node-protecting—Prefers node protecting repair path
- SRLG-disjoint—Prefers SRLG disjoint repair path
- Load-sharing—Distributes repair paths equally among links and prefixes

When there are two repair paths for a particular prefix, the path that the output port on different line card than that of the primary port is chosen as the repair path. For TI-LFA link protection, the following tiebreakers are supported:

- **Linecard-disjoint**—Prefers the line card disjoint repair path.
- **LC disjoint index**—If both the repair paths are on the same line card as that of the primary path, then, both paths are considered as candidates. If one of the path is on a different line card, then that path is chosen as the repair path.
- **SRLG index**—If both the repair paths have the same SRLG ID as that of the primary path, then, both the paths are considered as candidates. If one of the path has a different srlg id, then path is chosen as the repair path.
- **Node-protecting**—For TI-LFA node protection, the protected node is removed when computing the post-convergence shortest path. The repair path must direct traffic around the protected node.

The SRLG ID can be configured for each interface. When there are two repair paths for a prefix, the configured SRLG ID for the repair path is compared with that of the primary path SRLG ID. If the SRLG IDs for the secondary path is different than that of the primary, that path is chosen as the repair path. This policy comes into effect only when the primary path is configured with an SRLG ID. It is possible to configure both node and SRLG protection modes for the same interface or the same protocol instance. In that case, an additional TI-LFA node-SRLG combination protection algorithm is run. The TI-LFA node-SRLG combination algorithm removes the protected node and all members of the interface with the same SRLG group when computing the post-convergence SPT.

Interface Fast Reroute Tiebreakers

Interface fast reroute (FRR) tiebreakers are also needed for TI-LFA node and SRLG protection. When interface and protocol instance FRR tiebreakers both are configured, the interface FRR tiebreakers take precedence over the protocol instance. When interface FRR tiebreakers are not configured, the interface inherits the protocol instance FRR tiebreakers.

The following interface FRR tiebreaker commands apply only to the particular interface.

```
isis fast-reroute tie-break
[level-1 | level-2] linecard-disjoint
priority
isis fast-reroute tie-break
[level-1 | level-2] lowest-backup-metric
priority
isis fast-reroute tie-break
[level-1 | level-2] node-protecting
priority
isis fast-reroute tie-break
[level-1 | level-2] srlg-disjoint
priority
isis fast-reroute tie-break
[level-1 | level-2] default
```

Tie-breaker default and explicit tie-breaker on the same interface are mutually exclusive.

The following tie-breakers are enabled by default on all LFAs:

- linecard-disjoint
- lowest-backup-metric
- srlg-disjoint

Effective with Cisco IOS-XE Release 3.18, node-protecting tie-breaker is disabled by default.

How to Configure IS-IS Link-protection Topology Independent Loop Free Alternate Fast Reroute

Perform the following steps to configure Link-protection Topology Independent Loop Free Alternate Fast Reroute.

Configuring Topology Independent Loop Free Alternate Fast Reroute

You can enable TI-LFA using any of the following two methods:

1. **Protocol enablement**—Enables TI-LFA in router isis mode for all IS-IS interfaces. Optionally, use the interface command to exclude the interfaces on which TI-LFA should be disabled.

For example, to enable TI-LFA for all IS-IS interfaces:

```
router isis 1
fast-reroute per-prefix {level-1 | level-2}
fast-reroute ti-lfa {level-1 | level-2} [maximum-metric value]
```



Note The `isis fast-reroute protection level-x` command enables local LFA and is required to enable TI-LFA.

2. **Interface enablement**—Enable TI-LFA selectively on each interface.

```
interface interface-name
isis fast-reroute protection {level-1 | level-2}
isis fast-reroute ti-lfa protection {level-1 | level-2} [maximum-metric value]
```

The **maximum-metric** option specifies the maximum repair distance which a node is still considered eligible as a release node.

When both interface and protocol are TI-LFA enabled, the interface configuration takes precedence over the protocol configuration. TI-LFA is disabled by default.

To disable TI-LFA on a particular interface, use the following command:

```
interface interface-name
isis fast-reroute ti-lfa protection level-1 disable
```

Configuring Topology Independent Loop Free Alternate With Mapping Server

Consider the following topology to understand the configuration:

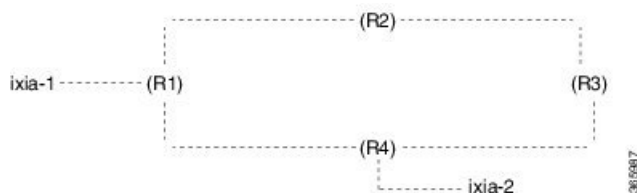

- IXIA-2 injects ISIS prefixes, and IXIA-1 sends one-way traffic to IXIA-2
- In R1 10,000 prefixes are configured in the segment-routing mapping-server.

The configuration on R1 is:

```

configure terminal
segment-routing mpls
global-block 16 20016
!
connected-prefix-sid-map
address-family ipv4
11.11.11.11/32 index 11 range 1
exit-address-family
!
!
mapping-server
!
prefix-sid-map
address-family ipv4
120.0.0.0/24 index 2 range 1 attach
200.0.0.0/24 index 1 range 1 attach
192.168.0.0/24 index 100 range 10000 attach
exit-address-family
!
!
!
!
interface Loopback0
ip address 11.11.11.11 255.255.255.255
ip router isis ipfrr
!
interface GigabitEthernet0/1/0
ip address 14.0.0.1 255.255.255.0
ip router isis ipfrr
negotiation auto
isis network point-to-point
!
interface GigabitEthernet0/1/2
ip address 11.0.0.1 255.255.255.0
ip router isis ipfrr
negotiation auto
isis network point-to-point
!
interface GigabitEthernet0/1/4
ip address 200.0.0.1 255.255.255.0
ip router isis ipfrr
negotiation auto
isis network point-to-point
!
router isis ipfrr
net 49.0001.0110.1101.1011.00
is-type level-2-only

```

```
metric-style wide
log-adjacency-changes
nsf cisco
segment-routing mpls
segment-routing prefix-sid-map advertise-local
fast-reroute per-prefix level-2 all
fast-reroute ti-lfa level-2
microloop avoidance rib-update-delay 10000
```

On R2 the configuration is

```
configure terminal
!
!
segment-routing mpls
!
connected-prefix-sid-map
address-family ipv4
12.12.12.12/32 index 12 range 1
exit-address-family
!
!
interface Loopback0
ip address 12.12.12.12 255.255.255.255
ip router isis ipfrr
!
interface GigabitEthernet0/1/0
ip address 12.0.0.1 255.255.255.0
ip router isis ipfrr
negotiation auto
isis network point-to-point
!
interface GigabitEthernet0/1/1
ip address 11.0.0.2 255.255.255.0
ip router isis ipfrr
negotiation auto
isis network point-to-point
!
router isis ipfrr
net 49.0001.0120.1201.2012.00
is-type level-2-only
metric-style wide
log-adjacency-changes
nsf cisco
segment-routing mpls
segment-routing prefix-sid-map advertise-local
fast-reroute per-prefix level-2 all
fast-reroute ti-lfa level-2
microloop avoidance rib-update-delay 10000
!
```

On R3 the configuration is

```
configure terminal
!
!
mpls traffic-eng tunnels
!
segment-routing mpls
!
connected-prefix-sid-map
address-family ipv4
13.13.13.13/32 index 13 range 1
exit-address-family
```

```

!
!
interface Loopback0
ip address 13.13.13.13 255.255.255.255
ip router isis ipfrr
!
interface GigabitEthernet0/0/4
ip address 13.0.0.1 255.255.255.0
ip router isis ipfrr
load-interval 30
speed 1000
no negotiation auto
isis network point-to-point
!
interface GigabitEthernet0/0/5
ip address 12.0.0.2 255.255.255.0
ip router isis ipfrr
negotiation auto
isis network point-to-point
!
router isis ipfrr
net 49.0001.0130.1301.3013.00
is-type level-2-only
metric-style wide
log-adjacency-changes
nsf cisco
segment-routing mpls
segment-routing prefix-sid-map advertise-local
fast-reroute per-prefix level-2 all
fast-reroute ti-lfa level-2
microloop avoidance rib-update-delay 10000
!

```

On R4 the configuration is:

```

configure terminal
!
mpls traffic-eng tunnels
!
segment-routing mpls
!
connected-prefix-sid-map
address-family ipv4
14.14.14.14/32 index 14 range 1
exit-address-family
!
!
interface Loopback0
ip address 14.14.14.14 255.255.255.255
ip router isis ipfrr
!
interface GigabitEthernet0/0/0
ip address 14.0.0.2 255.255.255.0
ip router isis ipfrr
negotiation auto
isis network point-to-point
!
interface GigabitEthernet0/0/3
ip address 13.0.0.2 255.255.255.0
ip router isis ipfrr
speed 1000
no negotiation auto
isis network point-to-point
!

```

```

interface GigabitEthernet0/0/5
ip address 120.0.0.1 255.255.255.0
ip router isis ipfrr
speed 1000
no negotiation auto
isis network point-to-point
!
router isis ipfrr
net 49.0001.0140.1401.4014.00
is-type level-2-only
metric-style wide
log-adjacency-changes
nsf cisco
segment-routing mpls
segment-routing prefix-sid-map advertise-local
fast-reroute per-prefix level-2 all
fast-reroute ti-lfa level-2
microloop avoidance rib-update-delay 10000
!
```

Examples: Configuring IS-IS Link-protection Topology Independent Loop Free Alternate Fast Reroute

Example 1: In the following example, local LFA is configured with linecard-disjoint and srlg-disjoint tiebreakers. Linecard-disjoint is given preference with a lower priority value (10) than the srlg-disjoint (11).

```

router isis access
net 49.0001.2037.0685.b002.00
metric-style wide
fast-flood 10
max-lsp-lifetime 65535
lsp-refresh-interval 65000
spf-interval 5 50 200
prc-interval 5 50 200
lsp-gen-interval 5 5 200
log-adjacency-changes
nsf ietf
segment-routing mpls
fast-reroute per-prefix level-1 all - configures the local LFA
fast-reroute per-prefix level-2 all
fast-reroute remote-lfa level-1 mpls-ldp - enables rLFA (optional)
fast-reroute remote-lfa level-2 mpls-ldp
fast-reroute ti-lfa level-1 - enables TI-LFA
microloop avoidance rib-update-delay 10000
bfd all-interfaces
```

Example 2—Enable TI-LFA node-protecting tie-breaker on all ISIS level-2 interfaces with priority 100. All other tiebreakers are disabled.

```

router isis
fast-reroute per-prefix level-2 all
fast-reroute ti-lfa level-2
fast-reroute tie-break level-2 node-protecting 100
```

Example 3—Enable TI-LFA node-protecting tie-breaker with priority 100 and TI-LFA SRLG protection with priority 200 on all IS-IS level-2 interfaces. All other tiebreakers are disabled because the node-protecting tie-breaker is configured.

```

router isis
```

```
fast-reroute per-prefix level-2 all
fast-reroute ti-lfa level-2
fast-reroute tie-break level-2 node-protecting 100
fast-reroute tie-break level-2 srlg-disjoint 200
```

Example 4—Enable TI-LFA node-protecting tie-breaker with priority 100 on all ISIS level-2 interfaces except on Ethernet0/0. For those IS-IS interfaces, all other tiebreakers are disabled. Ethernet0/0 overwrites the inheritance and uses the default set of tiebreakers with linecard-disjoint, lowest-backup-path-metric, srlg-disjoint enabled.

```
router isis
fast-reroute per-prefix level-2 all
fast-reroute ti-lfa level-2
fast-reroute tie-break level-2 node-protecting 100
!
interface ethernet0/0
ip router isis
isis fast-reroute tie-break level-2 default
```

Example 5—Enable TI-LFA using the default tiebreaker on all IS-IS interfaces except on Ethernet0/0. On Ethernet0/0 enable TI-LFA node-protecting with priority 100 and disable all other tiebreakers.

```
router isis
fast-reroute per-prefix level-2 all
fast-reroute ti-lfa level-2
!
interface ethernet0/0
ip router isis
isis fast-reroute tie-break level-2 node-protecting 100
```

Example 6—Enable TI-LFA node-protecting tie-breaker with priority 200 and linecard-disjoint tie-breaker with priority 100 on all ISIS level-2 interfaces. All other tiebreakers are disabled.

```
router isis
fast-reroute per-prefix level-2 all
fast-reroute ti-lfa level-2
fast-reroute tie-break level-2 linecard-disjoint 100
fast-reroute tie-break level-2 node-protecting 200
```

Verifying the Tiebreaker

To view tiebreakers enabled on the interface, use the following command:

```
show running all | section interface interface-name
```

To view tiebreakers enabled on the router mode, use the following command:

```
show running all | section router isis
```

Verifying the Primary and Repair Paths

In this example, 1.1.1.1 is the protecting neighbor and 4.4.4.4 is the neighbor on the protecting link.

```
Router#
show ip cef 1.1.1.1
1.1.1.1/32
  nexthop 1.1.1.1 GigabitEthernet0/2/0 label [explicit-null|explicit-null]() - slot 2 is
primary interface
```



```

    repair: attached-nexthop 24.0.0.2 TenGigabitEthernet0/3/0 - slot 3 is repair interface
  nexthop 24.0.0.2 TenGigabitEthernet0/3/0 label [explicit-null|explicit-null]()
  repair: attached-nexthop 1.1.1.1 GigabitEthernet0/2/0
Router#
show ip cef 4.4.4.4
4.4.4.4/32
  nexthop 4.4.4.4 GigabitEthernet0/2/3 label [explicit-null|16004]() - slot 2 is primary interface
    repair: attached-nexthop 5.5.5.5 MPLS-SR-Tunnel2
Router# show ip cef 4.4.4.4 int
4.4.4.4/32, epoch 3, RIB[I], refcnt 6, per-destination sharing
sources: RIB, Adj, LTE
feature space:
  IPRM: 0x00028000
  Broker: linked, distributed at 4th priority
  LFD: 4.4.4.4/32 2 local labels
  dflt local label info: global/877 [0x3]
  sr local label info: global/16004 [0x1B]
    contains path extension list
    dflt disposition chain 0x46654200
      label implicit-null
      FRR Primary
        <primary: IP adj out of GigabitEthernet0/2/3, addr 4.4.4.4>
    dflt label switch chain 0x46654268
      label implicit-null
      TAG adj out of GigabitEthernet0/2/3, addr 4.4.4.4
    sr disposition chain 0x46654880
      label explicit-null
      FRR Primary
        <primary: TAG adj out of GigabitEthernet0/2/3, addr 4.4.4.4>
    sr label switch chain 0x46654880
      label explicit-null
      FRR Primary
        <primary: TAG adj out of GigabitEthernet0/2/3, addr 4.4.4.4>
  subblocks:
    Adj source: IP adj out of GigabitEthernet0/2/3, addr 4.4.4.4 464C6620
      Dependent covered prefix type adjfib, cover 0.0.0.0/0
  ifnums:
    GigabitEthernet0/2/3(11): 4.4.4.4
    MPLS-SR-Tunnel2(1022)
  path list 3B1FC930, 15 locks, per-destination, flags 0x4D [shble, hvsh, rif, hwcn]
    path 3C04D5E0, share 1/1, type attached nexthop, for IPv4, flags [has-rpr]
      MPLS short path extensions: [rib | lblmrg | srlbl] MOI flags = 0x21 label explicit-null

    nexthop 4.4.4.4 GigabitEthernet0/2/3 label [explicit-null|16004](), IP adj out of
    GigabitEthernet0/2/3, addr 4.4.4.4 464C6620
      repair: attached-nexthop 5.5.5.5 MPLS-SR-Tunnel2 (3C04D6B0)
        path 3C04D6B0, share 1/1, type attached nexthop, for IPv4, flags [rpr, rpr-only]
          MPLS short path extensions: [rib | lblmrg | srlbl] MOI flags = 0x1 label 16004
        nexthop 5.5.5.5 MPLS-SR-Tunnel2 label 16004(), repair, IP midchain out of
    MPLS-SR-Tunnel2 46CE2440
  output chain:
    label [explicit-null|16004]()
    FRR Primary (0x3B209220)
      <primary: TAG adj out of GigabitEthernet0/2/3, addr 4.4.4.4 464C6480> - primary path
      <repair: TAG midchain out of MPLS-SR-Tunnel2 46CE22A0
        label 16()
        label 16003()
        TAG adj out of TenGigabitEthernet0/3/0, addr 24.0.0.2 46CE25E0> - repair path

```

Verifying the IS-IS Segment Routing Configuration

```
Router# show isis segment-routing
ISIS protocol is registered with MFI
ISIS MFI Client ID:0x63
Tag Null - Segment-Routing:
SR State:SR_ENABLED
Number of SRGB:1
SRGB Start:14000, Range:1001, srgb_handle:0xE0934788, srgb_state: created
Address-family IPv4 unicast SR is configured
Operational state: Enabled
```

The command with keyword **global-block** displays the SRGB and the range for LSPs.

```
Router# show isis segment-routing global-block
IS-IS Level-1 Segment-routing Global Blocks:
System ID          SRGB Base    SRGB Range
nevada             20000       4001
arizona            * 16000     1000
utah               40000       8000
```

The **show isis segment-routing prefix-sid-map** command with keyword **advertise** displays the prefix-sid maps that the router advertises.

```
Router# show isis segment-routing prefix-sid-map adv
IS-IS Level-1 advertise prefix-sid maps:
Prefix            SID Index    Range        Flags
16.16.16.16/32    101          1            Attached
16.16.16.17/32    102          1            Attached
```

The **show isis segment-routing prefix-sid-map** command with keyword **receive** displays the prefix-sid maps that the router receives.

```
Router #sh isis segment-routing prefix-sid-map receive
IS-IS Level-1 receive prefix-sid maps:
Host              Prefix                SID Index    Range        Flags
utah              16.16.16.16/32       101          1            Attached
                  16.16.16.17/32       102          1            Attached
```

To display the connected-SIDs found in the LSPs and passed to the mapping server component, use the **show isis segment-routing connected-sid** command.

```
Router# show isis segment-routing connected-sid
IS-IS Level-1 connected-sids
Host              Prefix                SID Index    Range        Flags
nevada            * 1.1.1.2/32          1002         1            Attached
                  2.2.2.2/32           20           1            Attached
                  100.1.1.10/32        10           1            Attached
colorado          1.1.1.3/32           33           1            Attached
                  1.1.1.6/32           6            1            Attached
IS-IS Level-2 connected-sids
Host              Prefix                SID Index    Range        Flags
```

Verifying the IS-IS Topology Independent Loop Free Alternate Tunnels

```
Router# show isis fast-reroute ti-lfa tunnel
Fast-Reroute TI-LFA Tunnels:
```

Tunnel	Interface	Next Hop	End Point	Label	End Point Host
MP1	Et1/0	30.1.1.4	1.1.1.2	41002	nevada
MP2	Et0/0	19.1.1.6	1.1.1.6	60006	colorado
			1.1.1.2	16	nevada
MP3	Et0/0	19.1.1.6	1.1.1.6	60006	colorado
			1.1.1.2	16	nevada
			1.1.1.5	70005	wyoming

Verifying the Segment Routing Traffic Engineering With Topology Independent Loop Free Alternate Configuration

```

Router# show mpls traffic-eng tunnels tunnel1
Name: PE1 (Tunnel1) Destination: 6.6.6.6
Status:
  Admin: up      Oper: up      Path: valid      Signalling: connected
  path option 10, (SEGMENT-ROUTING) type explicit IP_PATH (Basis for Setup)
Config Parameters:
  Bandwidth: 0      kbps (Global) Priority: 7 7 Affinity: 0x0/0xFFFF
  Metric Type: TE (default)
  Path Selection:
  Protection: any (default)
  Path-invalidation timeout: 45000 msec (default), Action: Tear
  AutoRoute: enabled LockDown: disabled Loadshare: 0 [0] bw-based
  auto-bw: disabled
  Fault-OAM: disabled, Wrap-Protection: disabled, Wrap-Capable: No
Active Path Option Parameters:
  State: explicit path option 10 is active
  BandwidthOverride: disabled LockDown: disabled Verbatim: disabled
History:
  Tunnel:
  Time since created: 4 hours, 25 minutes
  Time since path change: 4 hours, 21 minutes
  Number of LSP IDs (Tun_Instances) used: 37
  Current LSP: [ID: 37]
  Uptime: 4 hours, 21 minutes
  Tun_Instance: 37
  Segment-Routing Path Info (isis level-1)
  Segment0[Node]: 4.4.4.4, Label: 16014
  Segment1[Node]: 5.5.5.5, Label: 16015
  Segment2[Node]: 6.6.6.6, Label: 16016
Router# show isis fast-reroute ti-lfa tunnel

```

```

Tag 1:
Fast-Reroute TI-LFA Tunnels:
Tunnel Interface Next Hop      End Point      Label      End Point Host
MP1    Gi2    192.168.1.2    6.6.6.6        16016      SR_R6
MP2    Gi3    192.168.2.2    6.6.6.6        16016      SR_R6
Router# show frr-manager client client-name ISIS interfaces detail
TunnelI/F : MP1
  Type : SR
  Next-hop : 192.168.1.2
  End-point : 6.6.6.6
  OutI/F : Gi2
  Adjacency State : 1
  Prefix0 : 6.6.6.6(Label : 16016)
TunnelI/F : MP2
  Type : SR
  Next-hop : 192.168.2.2
  End-point : 6.6.6.6
  OutI/F : Gi3
  Adjacency State : 1

```

```

Prefix0 : 6.6.6.6(Label : 16016)
Router# show ip cef 6.6.6.6 internal

6.6.6.6/32, epoch 2, RIB[I], refcnt 6, per-destination sharing
sources: RIB, LTE
feature space:
  IPRM: 0x00028000
  Broker: linked, distributed at 1st priority
  LFD: 6.6.6.6/32 1 local label
  sr local label info: global/16016 [0x1A]
    contains path extension list
    sr disposition chain 0x7FC6B0BF2AF0
      label implicit-null
      IP midchain out of Tunnell
      label 16016
      FRR Primary
      <primary: label 16015
        TAG adj out of GigabitEthernet3, addr 192.168.2.2>
    sr label switch chain 0x7FC6B0BF2B88
      label implicit-null
      TAG midchain out of Tunnell
      label 16016
      FRR Primary
      <primary: label 16015
        TAG adj out of GigabitEthernet3, addr 192.168.2.2>
  ifnums:
    Tunnell(13)
    path list 7FC6B0BBDDE0, 3 locks, per-destination, flags 0x49 [shble, rif, hwn]
    path 7FC7144D4300, share 1/1, type attached nexthop, for IPv4
    MPLS short path extensions: [rib | prfmfi | lblmrg | srlbl] MOI flags = 0x3 label
  implicit-null
    nexthop 6.6.6.6 Tunnell, IP midchain out of Tunnell 7FC6B0BBB440
  output chain:
    IP midchain out of Tunnell 7FC6B0BBB440
    label [16016|16016]
    FRR Primary (0x7FC714515460)
      <primary: label 16015
        TAG adj out of GigabitEthernet3, addr 192.168.2.2 7FC6B0BBB630>
      <repair: label 16015
        label 16014
        TAG midchain out of MPLS-SR-Tunnell 7FC6B0BBAA90
        label 16016
        TAG adj out of GigabitEthernet2, addr 192.168.1.2 7FC6B0BBBA10>

```



Note To ensure a less than 50 msec traffic protection with TI-LFA, SR-TE with dynamic path option must use the backup adjacency SID.

To create an SR-TE with dynamic path option, use the following configuration on every router in the topology:

```

router isis 1
fast-reroute per-prefix level-1 all

```

At the tunnel head-end router:

```

interface Tunnell
ip unnumbered Loopback1
tunnel mode mpls traffic-eng
tunnel destination 6.6.6.6
tunnel mpls traffic-eng autoroute announce

```

```
tunnel mpls traffic-eng path-option 1 dynamic segment-routing
tunnel mpls traffic-eng path-selection segment-routing adjacency protected
```

Additional References for IS-IS Link-protection Topology Independent Loop Free Alternate Fast Reroute

Related Documents

Related Topic	Document Title
Cisco IOS Commands	Cisco IOS Master Command List, All Releases

Feature Information for IS-IS Link-protection Topology Independent Loop Free Alternate Fast Reroute

Table 3: Feature Information for IS-IS Link-protection Topology Independent Loop Free Alternate Fast Reroute

Feature Name	Releases	Feature Information
IS-IS Link-protection Topology Independent Loop Free Alternate Fast Reroute	Cisco IOS XE Everest 16.4.1 Cisco IOS XE Fuji 16.7.1	The following commands were introduced or modified: fast-reroute ti-lfa {level-1 level-2} [maximum-metric value] , isis fast-reroute ti-lfa protection level-1 disable , isis fast-reroute ti-lfa protection {level-1 level-2} [maximum-metric value] , show running all section interface interface-name , show running all section router isis . In Cisco IOS XE Fuji 16.7.1, this feature is supported on Cisco 4000 Series Integrated Service Routers.



CHAPTER 5

Segment Routing Traffic Engineering With IS-IS

This chapter describes how segment routing traffic engineering (SR-TE) can be implemented using IS-IS.

- [Restrictions for Segment Routing-Traffic Engineering With IS-IS, on page 41](#)
- [Information About Segment Routing Traffic Engineering With IS-IS, on page 41](#)
- [How to Configure Segment Routing Traffic Engineering With IS-IS, on page 47](#)
- [Additional References for Segment Routing Traffic Engineering With IS-IS, on page 56](#)
- [Feature Information for Segment Routing -Traffic Engineering With IS-IS, on page 57](#)

Restrictions for Segment Routing-Traffic Engineering With IS-IS

- SR-TE is not supported on broadcast interfaces; it is supported only point-to-point interfaces.
- The Cisco ASR routers support only a specific number of labels imposed on an outgoing packet. If the number of labels are greater than the specified number, the SR-TE tunnel creation fails. The Cisco ASR1000 routers support a maximum of 16 labels.
- Only one instance of protocol should be enabled for TE at a given point of time.
- You can use the verbatim keyword only on a label-switched path (LSP) that is configured with the explicit path option.
- Re-optimization is unsupported on the verbatim LSP.

Information About Segment Routing Traffic Engineering With IS-IS

A Traffic Engineered (TE) tunnel is a container of TE LSPs instantiated between the tunnel ingress and the tunnel destination. A TE tunnel can instantiate one or more SR-TE LSPs that are associated with the same tunnel. The SR-TE LSP path may not necessarily follow the same IGP path to a destination node. In this case, the SR-TE path can be specified through either a set of prefix-SIDs, or adjacency-SIDs of nodes, or both, and links to be traversed by the SR-TE LSP.

The head-end imposes the corresponding MPLS label stack on outgoing packets to be carried over the tunnel. Each transit node along the SR-TE LSP path uses the incoming top label to select the next-hop, pop or swap the label, and forward the packet to the next node with the remainder of the label stack, until the packet reaches

the ultimate destination. The set of hops or segments that define an SR-TE LSP path are provisioned by the operator.

SR-TE LSP Instantiation

A Traffic Engineered (TE) tunnel is a container of one or more instantiated TE LSPs. An SR-TE LSP is instantiated by configuring ‘segment-routing’ on the path-option of the TE tunnel. The traffic mapped to the tunnel is forwarded over the primary SR-TE instantiated LSP.

Multiple path-options can also be configured under the same tunnel. Each path-option is assigned a preference index or a path-option index that is used to determine the more favorable path-option for instantiating the primary LSP—the lower the path-option preference index, the more favorable the path-option. The other less favorable path-options under the same TE tunnel are considered secondary path-options and may be used once the currently used path-option is invalidated (for example, due to a failure on the path).



Note A forwarding state is maintained for the primary LSP only.

SR-TE LSP Explicit Null

MPLS-TE tunnel head-end does not impose explicit-null at the bottom of the stack. When penultimate hop popping (PHP) is enabled for SR prefix SIDs or when an adjacency SID is the last hop of the SR-TE LSP, the packet may arrive at the tail-end without a transport label. However, in some cases, it is desirable that the packet arrive at the tail-end with explicit-null label, and in such case, the head-end will impose an explicit-null label at the top of the label stack.

SR-TE LSP Path Verification

SR-TE tunnel functionality requires that the head-end perform initial verification of the tunnel path as well as the subsequent tracking of the reachability of the tunnel tail-end and traversed segments.

Path verification for SR-TE LSP paths is triggered whenever MPLS-TE is notified of any topology changes or SR SID updates.

The SR-TE LSP validation steps consist of the following checks:

Topology Path Validation

The head-end validates the path of an SR-TE LSP for connectivity against the TE topology. MPLS-TE head-end checks if links corresponding to the adjacency SIDs are connected in the TE topology.

For newly-instantiated SR-TE LSPs, if the head-end detects a discontinuity on any link of the SR-TE path, that path is considered invalid and is not used. If the tunnel has other path-options with valid paths, those paths are used to instantiate the tunnel LSP.

For TE tunnels with existing instantiated SR-TE LSP, if the head-end detects a discontinuity on any link, the head-end assumes a fault has occurred on that link. In this case, the local repair protection, such as the IP FRR, come in to effect. The IGP's continue to sustain the protected adjacency label and associated forwarding after the adjacency is lost for some time. This allows the head-ends enough time to reroute the tunnels onto different paths that are not affected by the same failure. The head-end starts a tunnel invalidation timer once it detects the link failure to attempt to reroute the tunnel onto other available path-options with valid paths.

If the TE tunnel is configured with other path-options that are not affected by the failure and are validated, the head-end uses one of those path-options to reroute (and re-optimize) the tunnel by instantiating a new primary LSP for the tunnel using the unaffected path.

If no other valid path-options exist under the same tunnel, or if the TE tunnel is configured with only one path-option that is affected by the failure, the head-end starts an invalidation timer after which it brings the tunnel state to 'down'. This action avoids black-holing the traffic flowing over the affected SR-TE LSP, and allows services riding over the tunnel to reroute over different available paths at the head-end. There is an invalidation drop configuration that keeps the tunnel 'up', but drops the traffic when the invalidation timer expires.

For intra-area SR-TE LSPs, the head-end has full visibility over the LSP path, and validates the path to the ultimate LSP destination. However, for inter-area LSPs, the head-end has partial visibility over the LSP path—only up to the first ABR. In this case, the head-end can only validate the path from the ingress to the first ABR. Any failure along the LSP beyond the first ABR node is invisible to the head-end, and other mechanisms to detect such failures, such as BFD over LSP are assumed.

SR SID Validation

SID hops of an SR-TE LSP are used to determine the outgoing MPLS label stack to be imposed on the outgoing packets carried over the SR-TE LSP of a TE tunnel. A database of global and local adjacency-SIDs is populated from the information received from IGP and maintained in MPLS-TE. Using a SID that is not available in the MPLS TE database invalidates the path-option using the explicit-path. The path-option, in this case, is not used to instantiate the SR TE LSP. Also, withdrawing, adding, or modifying a SID in the MPLS-TE SID-database, results in the MPLS-TE head-end verifying all tunnels with SR path-options (in-use or secondary) and invokes proper handling.

LSP Egress Interface

When the SR-TE LSP uses an adjacency-SID for the first path hop, TE monitors the interface state and IGP adjacency state associated with the adjacency-SID and the node that the SR-TE LSP egresses on. If the interface or adjacency goes down, TE can assume a fault occurred on the SR-TE LSP path and take the same reactive actions described in the previous sections.



Note When the SR-TE LSP uses a prefix-SID for the first hop, TE cannot directly infer on which interface the tunnel egresses. TE relies on the IP reachability information of the prefix to determine if connectivity to the first hop is maintained.

IP Reachability Validation

MPLS-TE validates that the nodes corresponding to the prefix-SIDs are IP reachable before declaring the SR path valid. MPLS-TE detects path changes for the IP prefixes corresponding to the adjacency or prefix SIDs of the SR-TE LSP path. If the node announcing a specific SID loses IP reachability, due to a link or node failure, MPLS-TE is notified of the path change (no path). MPLS-TE reacts by invalidating the current SR-TE LSP path, and may use other path-options with a valid path, if any to instantiate a new SR-TE LSP.



Note Since IP-FRR does not offer protection against failure of a node that is being traversed by an SR-TE LSP (such as, a prefix-SID failure along the SR-TE LSP path), the head-end immediately reacts to IP route reachability loss for prefix-SID node by setting the tunnel state to 'down' and removes the tunnel forwarding entry if there are no other path-options with valid path for the affected tunnel.

Tunnel Path Affinity Validation

The affinity of a tunnel path can be specified using the command **tunnel mpls traffic-eng affinity** under the tunnel interface.

The head-end validates that the specified SR path is compliant with the configured affinity. This necessitates that the paths of each segment of the SR path be validated against the specified constraint. The path is declared invalid against the configured affinity constraints if at least a single segment of the path does not satisfy the configured affinity.

Tunnel Path Resource Avoidance Validation

You can specify a set of addresses to be validated as excluded from being traversed by SR-TE tunnel packets. To achieve this, the head-end runs the per-segment verification checks and validates that the specified node, prefix or link addresses are indeed excluded from the tunnel in the SR path. The tunnel resource avoidance checks can be enabled per path using the commands below. The list of addresses to be excluded are defined and the name of the list is referenced in the path-option.

```
interface tunnel100
 tunnel mpls traffic-eng path-option 1 explicit name EXCLUDE segment-routing
 ip explicit-path name EXCLUDE enable
 exclude-address 192.168.0.2
 exclude-address 192.168.0.4
 exclude-address 192.168.0.3
 !
```

Verbatim Path Support

MPLS TE LSPs usually require that all the nodes in the network are TE aware which means that they have IGP extensions to TE in place. However, some network administrators want the ability to build TE LSPs to traverse nodes that do not support IGP extensions to TE, but that do support RSVP extensions to TE. Verbatim LSPs are helpful when all or some of the intermediate nodes in a network do not support IGP extensions for TE.

When this feature is enabled, the IP explicit path is not checked against the TE topology database. Since the TE topology database is not verified, a Path message with IP explicit path information is routed using the shortest path first (SPF) algorithm for IP routing.

SR-TE Traffic Load Balancing

SR-TE tunnels support the following load-balancing options:

Load Balancing on Port Channel TE Links

Port Channel interfaces carry the SR-TE LSP traffic. This traffic load balances over port channel member links as well as over bundle interfaces on the head or mid of an SR-TE LSP.

Load Balancing on Single Tunnel

While using the equal cost multi path protocol (ECMP), the path to a specific prefix-SID may point to multiple next-hops. And if the SR-TE LSP path traverses one or more prefix-SIDs that have ECMP, the SR-TE LSP traffic load-balances on the ECMP paths of each traversed prefix-SID from the head-end or any midpoint traversed node along the SR-TE LSP path.

Load Balancing on Multiple Tunnels

Multiple TE tunnels can be used as next-hop paths for routes to specific IP prefixes either by configuring static route on multiple tunnels, or auto-route announcing multiple parallel tunnels to the same destination. In such cases, the tunnels share the traffic load equally or load balance traffic on multiple parallel tunnels. It is also possible to allow Unequal Load Balance (UELB) with an explicit per tunnel configuration at the tunnel head-end. In this case, the tunnel load-share is passed from MPLS-TE to forwarding plane.

The tunnel load-share feature continues to work for TE tunnels that instantiate the SR-TE LSPs.

SR-TE Tunnel Re-optimization

TE tunnel re-optimization occurs when the head-end determines that there is a more optimal path available than the one currently used. For example, in case of a failure along the SR-TE LSP path, the head-end could detect and revert to a more optimal path by triggering re-optimization.

Tunnels that instantiate SR-TE LSP can re-optimize without affecting the traffic carried over the tunnel.

Re-optimization can occur because:

- the explicit path hops used by the primary SR-TE LSP explicit path are modified,
- the head-end determines the currently used path-option are invalid due to either a topology path disconnect, or a missing SID in the SID database that is specified in the explicit-path
- a more favorable path-option (lower index) becomes available

When the head-end detects a failure on a protected SR adjacency-SID that is traversed by an SR-TE LSP, it starts the invalidation timer. If the timer expires and the head-end is still using the failed path because it is unable to reroute on a different path, the tunnel state is brought 'down' to avoid black-holing the traffic. Once the tunnel is down, services on the tunnel converge to take a different path.

The following is a sample output of a manual re-optimization example. In this example, the path-option is changed from '10' to '20'.

```
Router# mpls traffic-eng reoptimize tunnel 1 path-option 20
The targeted path-option is not in lock down mode. Continue? [no]: yes
Router# show mpls traffic-eng tunnels tunnel1
Name: R1_t1 (Tunnel1) Destination: 6.6.6.6
Status:
  Admin: up Oper: up Path: valid Signalling: connected
  path option 20, (SEGMENT-ROUTING) type explicit IP_PATH (Basis for Setup)
  path option 10, (SEGMENT-ROUTING) type dynamic
Config Parameters:
  Bandwidth: 0 kbps (Global) Priority: 6 6 Affinity: 0x0/0xFFFF
  Metric Type: IGP (interface)
  Path Selection:
  Protection: any (default)
  Path-invalidation timeout: 45000 msec (default), Action: Tear
  AutoRoute: enabled LockDown: disabled Loadshare: 10 [200000000]
  auto-bw: disabled
  Fault-OAM: disabled, Wrap-Protection: disabled, Wrap-Capable: No
Active Path Option Parameters:
  State: explicit path option 20 is active
  BandwidthOverride: disabled LockDown: disabled Verbatim: disabled
History:
  Tunnel:
  Time since created: 6 days, 19 hours, 9 minutes
  Time since path change: 14 seconds
  Number of LSP IDs (Tun_Instances) used: 1819
  Current LSP: [ID: 1819]
  Uptime: 17 seconds
```

```

    Selection: reoptimization
  Prior LSP: [ID: 1818]
    ID: path option unknown
  Removal Trigger: reoptimization completed
Tun_Instance: 1819
Segment-Routing Path Info (isis level-1)
  Segment0[Node]: 4.4.4.4, Label: 114
  Segment1[Node]: 5.5.5.5, Label: 115
  Segment2[Node]: 6.6.6.6, Label: 116

```

SR-TE With Lockdown Option

The **lockdown** option prevents SR-TE from re-optimizing to a better path. However, it does not prevent signaling the existence of a new path.

```

interface Tunnell
 ip unnumbered Loopback1
 tunnel mode mpls traffic-eng
 tunnel destination 6.6.6.6
 tunnel mpls traffic-eng autoroute announce
 tunnel mpls traffic-eng priority 6 6
 tunnel mpls traffic-eng path-option 10 segment-routing lockdown
 tunnel mpls traffic-eng path-selection metric igp
 tunnel mpls traffic-eng load-share 10
Router# show mpls traffic-eng tunnels tunnell
Name: csr551_t1 (Tunnell) Destination: 6.6.6.6
Status:
  Admin: up Oper: up Path: valid Signalling: connected
  path option 10, (LOCKDOWN) type segment-routing (Basis for Setup)
Config Parameters:
  Bandwidth: 0 kbps (Global) Priority: 6 6 Affinity: 0x0/0xFFFF
  Metric Type: IGP (interface)
  Path Selection:
    Protection: any (default)
    Path-invalidation timeout: 45000 msec (default), Action: Tear
  AutoRoute: enabled LockDown: enabled Loadshare: 10 [200000000]
  auto-bw: disabled
  Fault-OAM: disabled, Wrap-Protection: disabled, Wrap-Capable: No
Active Path Option Parameters:
  State: segment-routing path option 10 is active
  BandwidthOverride: disabled LockDown: enabled Verbatim: disabled
History:
  Tunnel:
    Time since created: 6 days, 19 hours, 22 minutes
    Time since path change: 1 minutes, 26 seconds
    Number of LSP IDs (Tun_Instances) used: 1822
  Current LSP: [ID: 1822]
    Uptime: 1 minutes, 26 seconds
    Selection: reoptimization
  Prior LSP: [ID: 1821]
    ID: path option unknown
    Removal Trigger: configuration changed
Tun_Instance: 1822
Segment-Routing Path Info (isis level-1)
  Segment0[Node]: 6.6.6.6, Label: 116

```

SR-TE Tunnel Protection

Protection for SR TE tunnels can take any of the following alternatives:

IP-FRR Local Repair Protection

On an SR-TE LSP head-end or mid-point node, IP-FRR is used to compute and program the backup protection path for the prefix-SID or adjacency-SID label.

With IP-FRR, backup repair paths are pre-computed and pre-programmed by IGPs *before* a link or node failure. The failure of a link triggers its immediate withdrawal from the TE topology (link advertisement withdrawal). This allows the head-end to detect the failure of an SR-TE LSP traversing the failed adjacency-SID.

When a protected adjacency-SID fails, the failed adjacency-SID label and associated forwarding are kept functional for a specified period of time (5 to 15 minutes) to allow all SR TE tunnel head-ends to detect and react to the failure. Traffic using the adjacency-SID label continues to be FRR protected even if there are subsequent topology updates that change the backup repair path. In this case, the IGPs update the backup repair path while FRR is active to reroute traffic on the newly-computed backup path.

When the primary path of a protected prefix-SID fails, the PLR reroutes to the backup path. The head-end remains transparent to the failure and continues to use the SR-TE LSP as a valid path.

IP-FRR provides protection for adjacency and prefix-SIDs against link failures only.

Tunnel Path Protection

Path protection is the instantiation of one or more standby LSPs to protect against the failure of the primary LSP of a single TE tunnel.

Path protection protects against failures by pre-computing and pre-provisioning secondary paths that are failure diverse with the primary path-option under the same tunnel. This protection is achieved by computing a path that excludes prefix-SIDs and adjacency-SIDs traversed by the primary LSP or by computing a path that excludes SRLGs of the primary SR-TE LSP path.

In the event of a failure of the primary SR-TE LSP, at least one standby SR-TE LSP is used for the tunnel. Multiple secondary path-options can be configured to be used as standby SR-TE LSPs paths.

Unnumbered Support

IS-IS description of an unnumbered link does not contain remote interface ID information. The remote interface ID of an unnumbered link is required to include the unnumbered link as part of the SR-TE tunnel.

How to Configure Segment Routing Traffic Engineering With IS-IS

Perform the following steps to configure Segment Routing Traffic Engineering (SR-TE) with IS-IS.

Configuring Path Option for a TE Tunnel

The `segment-routing` keyword indicates that the specified path is programmed as an SR path:

```
Device(config)# interface tunnel 100
Device(config-if)# tunnel mpls traffic-eng path-option 1 explicit name foo segment-routing
Device(config-if)# tunnel mpls traffic-eng path-option 2 dynamic segment-routing
Device(config-if)# tunnel mpls traffic-eng path-option 3 segment-routing
```



Note With IP unnumbered interfaces dynamic path is not supported.

When the path-option type for an operational SR tunnel is changed from SR to non-SR (for example, **dynamic**), the existing forwarding entry of the tunnel is deleted.

Segment Routing can be enabled or disabled on an existing secondary or an in-use path-option. If the tunnel uses a signaled RSVP-TE explicit path-option and segment routing is enabled on that tunnel, the RSVP-TE LSP is torn, and the SR-TE LSP is instantiated using the same path-option. Conversely, if segment routing is disabled on a path-option that is in use by the primary LSP, the tunnel goes down intermittently and a new RSVP-TE LSP will be signaled using the same explicit path.

If the segment-routing path-option is enabled on a secondary path-option (that is, not in-use by the tunnel's primary LSP), the tunnel is checked to evaluate if the newly specified SR-TE LSP path-option is valid and more favorable to use for the tunnel primary LSP.

Configuring SR Explicit Path Hops

The following SR-TE explicit path hops are supported:

- IP addresses
- MPLS labels
- Mix of IP addresses and MPLS labels

For intra-area LSPs, the explicit path can be specified as a list of IP addresses.

```
Device(config)# ip explicit-path name foo
Device(config-ip-expl-path)# index 10 next-address 1.1.1.1 node address
Device(config-ip-expl-path)# index 20 next-address 12.12.12.2 link address
```



Note When using IP unnumbered interfaces, you cannot specify next hop address as an explicit path index. It should be node address or label.

The explicit path can also be specified as segment-routing SIDs:

```
Device(config)# ip explicit-path name foo
Device(config-ip-expl-path)# index 10 next-label 20
```



Note IP addresses cannot be used after using the label in MIXED_PATH.

Configuring Affinity on an Interface

Perform the following steps to configure affinity on an interface:

```
interface GigabitEthernet2
 ip address 192.168.2.1 255.255.255.0
 ip router isis 1
```

```

negotiation auto
mpls traffic-eng tunnels
mpls traffic-eng attribute-flags 0x1
isis network point-to-point
ip rsvp bandwidth

```

Enabling Verbatim Path Support

To enable verbatim with SR-TE you can use the following example. In the example, tunnel destination 11.11.11.11 is in different area and an explicit path with name multihop is defined with SR-TE path option.

```

R6#
interface Tunnel4
ip unnumbered Loopback66
tunnel mode mpls traffic-eng
tunnel destination 11.11.11.11
tunnel mpls traffic-eng path-option 1 explicit name multihop segment-routing verbatim
!
ip explicit-path name multihop enable
index 1 next-label 16003
index 2 next-label 16002
index 3 next-label 16001
!
End

```

Use Case: Segment Routing Traffic Engineering Basic Configuration

Consider the following topology to understand the SR-TE configuration:

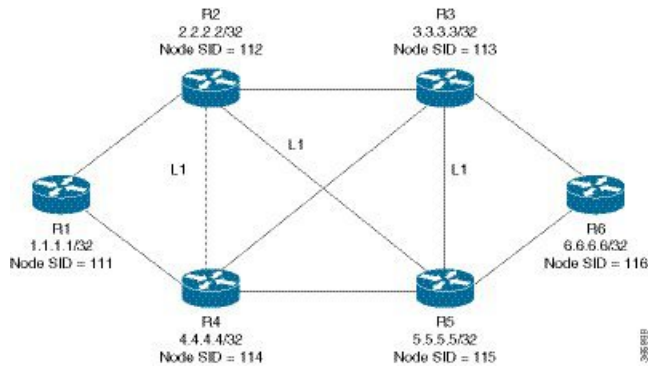

To configure at the head-end router, R1:

```

!
mpls traffic-eng tunnels
!
segment-routing mpls
connected-prefix-sid-map
  address-family ipv4
    1.1.1.1/32 index 111 range 1
  exit-address-family
!
set-attributes
  address-family ipv4
    sr-label-preferred
  exit-address-family

```

```

!
interface Loopback1
ip address 1.1.1.1 255.255.255.255
ip router isis 1
!
int gig0/0
ip address 11.11.11.1 255.255.255.0
ip router isis 1
mpls traffic-eng tunnels
isis network point-to-point
!
router isis 1
net 49.0001.0010.0100.1001.00
is-type level-1
metric-style wide
segment-routing mpls
segment-routing prefix-sid-map advertise-local
mpls traffic-eng router-id Loopback1
mpls traffic-eng level-1
!
end

```

To enable SR-TE Explicit path (Node SID based), enable the following CLI on R1:

```

Head end SR-TE configuration R1#
!
interface tunnell
ip unnumbered Loopback1
tunnel mode mpls traffic-eng
tunnel destination 6.6.6.6
tunnel mpls traffic-eng autoroute announce
tunnel mpls traffic-eng priority 6 6
tunnel mpls traffic-eng path-option 10 explicit name Node_PATH segment-routing
!
ip explicit-path name Node_PATH
 next-label 16114
next-label 16115
next-label 16116

```

To verify proper operation of SR-TE tunnel 1 on R1 enable the following CLI:

```

Tunnel verification on (R1)# show mpls traffic-eng tun tun 1 detail
Name: R1_tl (Tunnell) Destination: 6.6.6.6
Status:
  Admin: up      Oper: up      Path: valid      Signalling: connected
  path option 10, (SEGMENT-ROUTING) type explicit Node_PATH (Basis for Setup)
Config Parameters:
  Bandwidth: 0      kbps (Global) Priority: 6 6 Affinity: 0x0/0xFFFF
  Metric Type: IGP (interface)
Verbatim: disabled
Number of LSP IDs (Tun_Instances) used: 1815
  Current LSP: [ID: 1815]
  Uptime: 2 seconds
Removal Trigger: configuration changed
  Segment-Routing Path Info (isis level-1)
  Segment0[Node]: 4.4.4.4, Label: 16114
  Segment1[Node]: 5.5.5.5, Label: 16115
  Segment2[Node]: 6.6.6.6, Label: 16116

```

To configure at the tail-end router, R6:

```

interface GigabitEthernet2

```



```

ip address 100.101.1.1 255.255.255.0
ip router isis 1
negotiation auto
mpls traffic-eng tunnels
router isis 1
 net 49.0001.0060.0600.6006.00
 ispf level-1
 metric-style wide
 log-adjacency-changes
 segment-routing mpls

segment-routing prefix-sid-map advertise-local
mpls traffic-eng router-id Loopback1
mpls traffic-eng level-1

```

Explicit Path SR-TE Tunnel 1

Consider tunnel 1 based only on IP addresses:

```

ip explicit-path name IP_PATH1
 next-address 2.2.2.2
 next-address 3.3.3.3
 next-address 6.6.6.6
!
interface Tunnel1
 ip unnumbered Loopback1
 tunnel mode mpls traffic-eng
 tunnel destination 6.6.6.6
 tunnel mpls traffic-eng autoroute announce
 tunnel mpls traffic-eng priority 6 6
 tunnel mpls traffic-eng path-option 10 explicit name IP_PATH1 segment-routing
 tunnel mpls traffic-eng path-selection metric igp
 tunnel mpls traffic-eng load-share 10
end

```

Explicit Path SR-TE Tunnel 2

Consider tunnel 2 based on node SIDs

```

ip explicit-path name IA_PATH
 next-label 114
 next-label 115
 next-label 116
!
interface Tunnel2
 ip unnumbered Loopback1
 tunnel mode mpls traffic-eng
 tunnel destination 6.6.6.6
 tunnel mpls traffic-eng autoroute announce
 tunnel mpls traffic-eng priority 6 6
 tunnel mpls traffic-eng bandwidth 10000 class-type 1
 tunnel mpls traffic-eng path-option 10 explicit name NODE_PATH segment-routing
 tunnel mpls traffic-eng path-selection metric igp
 tunnel mpls traffic-eng load-share 10
end

```

Explicit Path SR-TE Tunnel 3

Consider that tunnel 3 is based on a mix of IP addresses and label

```

ip explicit-path name MIXED_PATH enable
next-address 2.2.2.2
next-address 3.3.3.3
next-label 115
next-label 116
!
interface Tunnel3
ip unnumbered Loopback1
tunnel mode mpls traffic-eng
tunnel destination 6.6.6.6
tunnel mpls traffic-eng autoroute announce
tunnel mpls traffic-eng priority 6 6
tunnel mpls traffic-eng path-option 10 explicit name MIXED_PATH segment-routing
tunnel mpls traffic-eng path-selection metric igp
tunnel mpls traffic-eng load-share 10

```



Note In the case of mixed path, IP next-hop cannot be used after using Node SIDs in the path. The following path will not be valid:

```

ip explicit-path name MIXED_PATH enable
next-label 115
next-label 116
next-address 2.2.2.2

```

Dynamic Path SR-TE Tunnel 4

Consider that tunnel 4 is based on adjacency SIDs

```

interface Tunnel4
ip unnumbered Loopback1
tunnel mode mpls traffic-eng
tunnel destination 6.6.6.6
tunnel mpls traffic-eng autoroute announce
tunnel mpls traffic-eng priority 6 6
tunnel mpls traffic-eng bandwidth 10000 class-type 1
tunnel mpls traffic-eng path-option 10 dynamic segment-routing
tunnel mpls traffic-eng path-selection metric igp
tunnel mpls traffic-eng load-share 10
end

```

Dynamic Path SR-TE Tunnel 5

Consider that tunnel 5 is based on Node SIDs

```

interface Tunnel5
ip unnumbered Loopback1
tunnel mode mpls traffic-eng
tunnel destination 6.6.6.6
tunnel mpls traffic-eng autoroute announce
tunnel mpls traffic-eng priority 6 6
tunnel mpls traffic-eng path-option 10 segment-routing
tunnel mpls traffic-eng path-selection metric igp
tunnel mpls traffic-eng load-share 10

```

Verifying Configuration of the SR-TE Tunnels

Use the `show mpls traffic-eng tunnels tunnel-number` command to verify the configuration of the SR-TE tunnels.

Verifying Tunnel 1

```
Name: R1_t1 (Tunnell) Destination: 6.6.6.6
Status:
  Admin: up Oper: up Path: valid Signalling: connected
  path option 10, (SEGMENT-ROUTING) type explicit IP_PATH (Basis for Setup)
Config Parameters:
  Bandwidth: 0 kbps (Global) Priority: 6 6 Affinity: 0x0/0xFFFF
  Metric Type: IGP (interface)
  Path Selection:
    Protection: any (default)
    Path-invalidation timeout: 45000 msec (default), Action: Tear
    AutoRoute: enabled LockDown: disabled Loadshare: 10 [200000000]
    auto-bw: disabled
    Fault-OAM: disabled, Wrap-Protection: disabled, Wrap-Capable: No
Active Path Option Parameters:
  State: explicit path option 10 is active
  BandwidthOverride: disabled LockDown: disabled Verbatim: disabled
History:
  Tunnel:
    Time since created: 6 days, 19 hours
    Time since path change: 2 seconds
    Number of LSP IDs (Tun_Instances) used: 1814
    Current LSP: [ID: 1814]
    Uptime: 2 seconds
    Selection: reoptimization
    Prior LSP: [ID: 1813]
    ID: path option unknown
    Removal Trigger: configuration changed
  Tun_Instance: 1814
Segment-Routing Path Info (isis level-1)
  Segment0[Node]: 4.4.4.4, Label: 114
  Segment1[Node]: 5.5.5.5, Label: 115
  Segment2[Node]: 6.6.6.6, Label: 116
```

Verifying Tunnel 2

```
Name: R1_t2 (Tunnell) Destination: 6.6.6.6
Status:
  Admin: up Oper: up Path: valid Signalling: connected
  path option 10, (SEGMENT-ROUTING) type explicit IA_PATH (Basis for Setup)
Config Parameters:
  Bandwidth: 0 kbps (Global) Priority: 6 6 Affinity: 0x0/0xFFFF
  Metric Type: IGP (interface)
  Path Selection:
    Protection: any (default)
    Path-invalidation timeout: 45000 msec (default), Action: Tear
    AutoRoute: enabled LockDown: disabled Loadshare: 10 [200000000]
    auto-bw: disabled
    Fault-OAM: disabled, Wrap-Protection: disabled, Wrap-Capable: No
Active Path Option Parameters:
  State: explicit path option 10 is active
  BandwidthOverride: disabled LockDown: disabled Verbatim: disabled
History:
  Tunnel:
```

```

    Time since created: 6 days, 19 hours, 1 minutes
    Time since path change: 1 seconds
    Number of LSP IDs (Tun_Instances) used: 1815
    Current LSP: [ID: 1815]
    Uptime: 1 seconds
    Prior LSP: [ID: 1814]
    ID: path option unknown
    Removal Trigger: configuration changed
    Tun_Instance: 1815
Segment-Routing Path Info (isis level-1)
    Segment0[ - ]: Label: 114
    Segment1[ - ]: Label: 115
    Segment2[ - ]: Label: 116

```

Verifying Tunnel 3

```

Name: R1_t3                               (Tunnel1) Destination: 6.6.6.6
Status:
  Admin: up          Oper: up          Path: valid          Signalling: connected
  path option 10, (SEGMENT-ROUTING) type explicit MIXED_PATH (Basis for Setup)
Config Parameters:
  Bandwidth: 0          kbps (Global) Priority: 6 6  Affinity: 0x0/0xFFFF
  Metric Type: IGP (interface)
  Path Selection:
    Protection: any (default)
  Path-invalidation timeout: 45000 msec (default), Action: Tear
  AutoRoute: enabled  LockDown: disabled Loadshare: 10 [200000000]
  auto-bw: disabled
  Fault-OAM: disabled, Wrap-Protection: disabled, Wrap-Capable: No
Active Path Option Parameters:
  State: explicit path option 10 is active
  BandwidthOverride: disabled LockDown: disabled Verbatim: disabled
History:
  Tunnel:
    Time since created: 6 days, 19 hours, 2 minutes
    Time since path change: 2 seconds
    Number of LSP IDs (Tun_Instances) used: 1816
    Current LSP: [ID: 1816]
    Uptime: 2 seconds
    Selection: reoptimization
    Prior LSP: [ID: 1815]
    ID: path option unknown
    Removal Trigger: configuration changed
    Tun_Instance: 1816
Segment-Routing Path Info (isis level-1)
    Segment0[Node]: 2.2.2.2, Label: 112
    Segment1[Node]: 3.3.3.3, Label: 113
    Segment2[ - ]: Label: 115
    Segment3[ - ]: Label: 116

```

Verifying Tunnel 4

```

Name: R1_t4                               (Tunnel1) Destination: 6.6.6.6
Status:
  Admin: up          Oper: up          Path: valid          Signalling: connected
  path option 10, (SEGMENT-ROUTING) type dynamic (Basis for Setup, path weight 30)
Config Parameters:
  Bandwidth: 0          kbps (Global) Priority: 6 6  Affinity: 0x0/0xFFFF
  Metric Type: IGP (interface)
  Path Selection:
    Protection: any (default)

```

```

Path-invalidation timeout: 45000 msec (default), Action: Tear
AutoRoute: enabled LockDown: disabled Loadshare: 10 [200000000]
auto-bw: disabled
Fault-OAM: disabled, Wrap-Protection: disabled, Wrap-Capable: No
Active Path Option Parameters:
State: dynamic path option 10 is active
BandwidthOverride: disabled LockDown: disabled Verbatim: disabled
History:
Tunnel:
Time since created: 6 days, 19 hours
Time since path change: 2 seconds
Number of LSP IDs (Tun_Instances) used: 1813
Current LSP: [ID: 1813]
Uptime: 2 seconds
Prior LSP: [ID: 1806]
ID: path option unknown
Removal Trigger: configuration changed
Tun_Instance: 1813
Segment-Routing Path Info (isis level-1)
Segment0[Link]: 192.168.2.1 - 192.168.2.2, Label: 17
Segment1[Link]: 192.168.4.2 - 192.168.4.1, Label: 25
Segment2[Link]: 192.168.8.1 - 192.168.8.2, Label: 300

```

Verifying Tunnel 5

```

Name: R1_t5 (Tunnell) Destination: 6.6.6.6
Status:
Admin: up Oper: up Path: valid Signalling: connected
path option 10, type segment-routing (Basis for Setup)
Config Parameters:
Bandwidth: 0 kbps (Global) Priority: 6 6 Affinity: 0x0/0xFFFF
Metric Type: IGP (interface)
Path Selection:
Protection: any (default)
Path-invalidation timeout: 45000 msec (default), Action: Tear
AutoRoute: enabled LockDown: disabled Loadshare: 10 [200000000]
auto-bw: disabled
Fault-OAM: disabled, Wrap-Protection: disabled, Wrap-Capable: No
Active Path Option Parameters:
State: segment-routing path option 10 is active
BandwidthOverride: disabled LockDown: disabled Verbatim: disabled
History:
Tunnel:
Time since created: 6 days, 19 hours, 4 minutes
Time since path change: 14 seconds
Number of LSP IDs (Tun_Instances) used: 1817
Current LSP: [ID: 1817]
Uptime: 14 seconds
Selection: reoptimization
Prior LSP: [ID: 1816]
ID: path option unknown
Removal Trigger: configuration changed
Tun_Instance: 1817
Segment-Routing Path Info (isis level-1)
Segment0[Node]: 6.6.6.6, Label: 116

```

Verifying Verbatim Path Support

To verify proper operation and SR-TE tunnel state use following CLI:

```

R6#sh mpls traffic-eng tunnels tunnel 4

Name: R6_t4 (Tunnel4) Destination: 11.11.11.11
Status:
  Admin: up Oper: up Path: valid Signalling: connected
  path option 1, (SEGMENT-ROUTING) type explicit (verbatim) multihop (Basis for Setup)

Config Parameters:
  Bandwidth: 0 kbps (Global) Priority: 7 7 Affinity: 0x0/0xFFFF
  Metric Type: TE (default)
  Path Selection:
    Protection: any (default)
  Path-selection Tiebreaker:
    Global: not set Tunnel Specific: not set Effective: min-fill (default)
  Hop Limit: disabled [ignore: Verbatim Path Option]
  Cost Limit: disabled
  Path-invalidation timeout: 10000 msec (default), Action: Tear
  AutoRoute: disabled LockDown: disabled Loadshare: 0 [0] bw-based
  auto-bw: disabled
  Fault-OAM: disabled, Wrap-Protection: disabled, Wrap-Capable: No
Active Path Option Parameters:
  State: explicit path option 1 is active
  BandwidthOverride: disabled LockDown: disabled Verbatim: enabled

History:
  Tunnel:
    Time since created: 16 minutes, 40 seconds
    Time since path change: 13 minutes, 6 seconds
    Number of LSP IDs (Tun_Instances) used: 13
  Current LSP: [ID: 13]
    Uptime: 13 minutes, 6 seconds
    Selection: reoptimization
  Prior LSP: [ID: 12]
    ID: path option unknown
    Removal Trigger: configuration changed (severe)
  Tun_Instance: 13
  Segment-Routing Path Info (IGP information is not used)
    Segment0[First Hop]: 0.0.0.0, Label: 16003
    Segment1[ - ]: Label: 16002
    Segment2[ - ]: Label: 16001

```

Additional References for Segment Routing Traffic Engineering With IS-IS

Related Documents

Related Topic	Document Title
Cisco IOS Commands	Cisco IOS Master Command List, All Releases

Feature Information for Segment Routing -Traffic Engineering With IS-IS

The following table provides release information about the feature or features described in this module. This table lists only the software release that introduced support for a given feature in a given software release train. Unless noted otherwise, subsequent releases of that software release train also support that feature.

Use Cisco Feature Navigator to find information about platform support and Cisco software image support. To access Cisco Feature Navigator, go to www.cisco.com/go/cfn. An account on Cisco.com is not required.

Table 4: Feature Information for Segment Routing -Traffic Engineering With IS-IS

Feature Name	Releases	Feature Information
Segment Routing-Traffic Engineering With IS-IS	Cisco IOS XE Everest 16.4.1 Cisco IOS XE Fuji 16.7.1	The following commands were introduced or modified: mpls traffic-eng nsr, show mpls traffic-eng tunnels tunnel1, show isis fast-reroute ti-lfa tunnel, show frr-manager client client-name ISIS interfaces detail, show ip cef 6.6.6.6 internal In Cisco IOS XE Fuji 16.7.1, this feature is supported on Cisco 4000 Series Integrated Service Routers.



CHAPTER 6

Segment Routing With OSPFv2 Node SID

This chapter describes how Segment Routing works with OSPFv2 node SID.

- [Information About Segment Routing With OSPFv2 Node SID, on page 59](#)
- [How to Configure Segment Routing With OSPFv2 Node SID, on page 62](#)
- [Additional References for Segment Routing With OSPFv2 Node SID, on page 69](#)
- [Feature Information for Segment Routing With OSPFv2 Node SID, on page 70](#)

Information About Segment Routing With OSPFv2 Node SID

Segment Routing relies on a small number of extensions to Open Shortest Path First (OSPF) protocols. There are two levels of configuration required to enable segment routing for a routing protocol instance. The top level segment routing configuration which is managed by segment routing infrastructure component enables segment routing, whereas, segment routing configuration at the router ospf level enables segment routing for the ospf instance. There are three segment routing states:

- SR_NOT_CONFIGURED
- SR_DISABLED
- SR_ENABLED

Segment routing configuration under the IGPs is allowed only if the SR state is either SR_DISABLED or SR_ENABLED. The SR_ENABLED state indicates that there is at least a valid SRGB range reserved. You can enable segment routing for IGPs under the router configuration sub mode, through commands. However, IGP segment routing are enabled only after the global SR is configured.

The SR_ENABLED is a necessary state for any protocol to enable SR, however, it is not a sufficient for enabling SR for a protocol instance. The reason being that the OSPF still does not have any information about segment routing global block (SRGB) information. When the request to receive information about the SRGB is processed successfully, the OSPF SR operational state is enabled.

Segment Routing requires each router to advertise its segment routing data-plane capability and the range of MPLS label values that are used for segment routing in the case where global SIDs are allocated. Data-plane capabilities and label ranges are advertised using the SR-capabilities sub-TLV inserted into the OSPF Router Information Opaque LSA.

OSPF SR-capabilities sub TLV includes all reserved SRGB ranges. However, the Cisco implementation supports only one SRGB range.

Prefix-SID Received in Label Switched Path From Remote Routers

OSPF sends the prefix SIDs associated with the connected prefix using the Extended Prefix Sub TLV in its opaque Extended prefix LSA. Prefix SIDs received in a LSA which have got reachability are downloaded to the routing information base (RIB) in the same way as BGP downloads per prefix VPN labels, only if the following conditions are met:

- Segment routing is enabled for the topology and address-family.
- Prefix-SID is valid.
- The local label binding to MFI is successful.



Note For SIDs that do not fit in the specified SID range, labels are not used when updating the RIB. For the cases, where SID fits in the SID range, but does not fit the next-hop neighbor SID range, remote label associated with that path is not installed.

Segment Routing Adjacency SID Advertisement

Effective with Cisco IOS-XE Release 3.17, OSPF supports the advertisement of segment routing adjacency SID. An Adjacency Segment Identifier (Adj-SID) represents a router adjacency in Segment Routing.

A segment routing-capable router may allocate an Adj-SID for each of its adjacencies and an Adj-SID sub-TLV is defined to carry this SID in the Extended Opaque Link LSA.

OSPF allocates the adjacency SID for each OSPF neighbor if the OSPF adjacency which are in two way or in FULL state. OSPF allocates the adjacency SID only if the Segment Routing is enabled. The label for adjacency SID is dynamically allocated by the system. This eliminates the chances of misconfiguration, as this has got only the local significance.

Multiple Adjacency-SIDs

Effective with Cisco IOS-XE Release 16.3, multiple adjacency-SIDs are supported. For each OSPF adjacency, OSPF allots to Adj SIDs, unprotected and protected Adj-SIDs which are carried in the extended link LSAs. The protected adjacency SID (or back up Adj-SID) is allocated and advertised only when FRR is enabled on the router and also on the interface where SR is enabled on the system. When FRR or SR is disabled, the protected Adj-SID is released.

The persistence of protected adj-SID in forwarding plane is supported. When the primary link is down, OSPF delays the release of its backup Adj-SID until the delay timer (30 sec) expires. This allows the forwarding plane to continue to forward the traffic through the backup path until the router is converged.

The allocated and advertised backup Adj-SIDs can be displayed in the output of **show ip ospf neighbor detail** and **show ip ospf segment-routing protected-adjacencies command**.

Segment Routing Mapping Server

Segment Routing Mapping Server (SRMS) allows configuration and maintenance of the Prefix-SID mapping policy entries. Effective with Cisco IOS-XE Release 3.17, the IGP's use the active policy of the SRMS to determine the SID values when programming the forwarding plane.

The SRMS provides prefixes to SID/Label mapping policy for the network. IGPs, on the other hand, are responsible for advertising prefixes to SID/Label mapping policy through the Prefix-SID/Label Binding TLV.

Active policy information and changes are notified to the IGPs, which use active policy information to update forwarding information.

Connected Prefix SIDs

When a router installs a prefix with a SID that is different than what it advertises to the LSP, for example, if more than one protocol or more than one IGP instance is announcing the same prefix with different SIDs to the SRMS, the SRMS resolves the conflict and announces the winning prefix and SID that may not be the same as the local instance. In that case, the IGP always advertises what it learns from its source LSP although it still tries to install the SID which may be different than what it learns in its LSP. This is done to prevent the IGP from redistributing the SIDs from another protocol or another protocol instance.

SRGB Range Changes

When OSPF segment routing is configured, OSPF must request an interaction with the SRGB before OSPF SR operational state can be enabled. If no SRGB range is created, OSPF will not be enabled.

When an SRGB change event occurs, OSPF makes the corresponding changes in its sub-block entries. OSPF also advertises the newly created or extended SRGB range in SR-capabilities sub-TLV and updates the prefix-sid sub TLV advertisement.

MPLS Forwarding on an Interface

MPLS forwarding must be enabled before segment routing can use an interface. OSPF is responsible for enabling MPLS forwarding on an interface.

When segment routing is enabled for a OSPF topology, or OSPF segment routing operational state is enabled, it enables MPLS for any interface on which the OSPF topology is active. Similarly, when segment routing is disabled for a OSPF topology, it disables the MPLS forwarding on all interfaces for that topology.

Conflict Handling of SID Entries

When there is a conflict between the SID entries and the associated prefix entries use any of the following methods to resolve the conflict:

- When the system receives two SID entries for the same prefix, then the prefix received by higher router ID is treated as the SID corresponding to the prefix. The prefix is installed with the SID entry which was advertised by the higher router ID.
- When the system receives two SID entries one by OSPF protocol and the other by IS-IS protocol, then the SID entry received by OSPF protocol is treated as valid SID. The prefix is installed with the SID entry which was received by OSPF protocol.
- When two prefixes are advertised with the same SID entry, then the prefix which is advertised by the higher router ID is installed with the SID entry and the other prefix is installed without any SID entry.

In an ideal situation, each prefix should have unique SID entries assigned.

How to Configure Segment Routing With OSPFv2 Node SID

Perform the following steps to configure segment routing with OSPFv2 node SID.

Configuring Segment Routing With OSPF

Before you begin

Before configuring OSPF to support segment routing you must first configure the segment routing feature in global configuration mode.

SUMMARY STEPS

1. **enable**
2. **configure terminal**
3. `segment-routing mpls`
4. `connected-prefix-sid-map`
5. `address-family ipv4`
6. `1.1.1.1/32 index 100 range 1`
7. `exit-address-family`

DETAILED STEPS

	Command or Action	Purpose
Step 1	enable Example: Device# enable	Enables privileged EXEC mode. <ul style="list-style-type: none"> • Enter your password if prompted.
Step 2	configure terminal Example: Device# configure terminal	Enters global configuration mode.
Step 3	<code>segment-routing mpls</code> Example: Device(config-sr)# segment-routing mpls	Enables the segment feature using the mpls data plane.
Step 4	<code>connected-prefix-sid-map</code> Example: Device(config-srmppls)# connected-prefix-sid-map	Enters a sub-mode where you can configure address-family specific mappings for local prefixes and SIDs.
Step 5	<code>address-family ipv4</code> Example:	Specifies IPv4 address prefixes.

	Command or Action	Purpose
	Device(config-srmppls-conn)# address-family ipv4	
Step 6	1.1.1.1/32 index 100 range 1 Example: Device(config-srmppls-conn-af)# 1.1.1.1/32 100 range 1	Associates SID 100 with the address 1.1.1.1/32.
Step 7	exit-address-family Example: Device(config-srmppls-conn-af)# exit-address-family	Exits the address family.

Configuring Segment Routing on OSPF Network

Before you begin

Before you configure segment routing on OSPF network, OSPF must be enabled on your network.

SUMMARY STEPS

1. **router ospf 10**
2. **router-id<id>**
3. **segment-routing mpls**
4. **segment-routing area <area id> mpls**
5. **show ip ospf 10 segment-routing**

DETAILED STEPS

	Command or Action	Purpose
Step 1	router ospf 10 Example: Device(config)# router ospf 10	Enables the OSPF mode.
Step 2	router-id<id> Example: Device(config-router)# router-id 1.0.0.0	Configures OSPF routes.
Step 3	segment-routing mpls Example: Device(config-router)# segment-routing mpls	Configures segment routing mpls mode.

	Command or Action	Purpose
Step 4	segment-routing area <area id> mpls Example: Device(config-router) # segment-routing area 0 mpls	Configures segment routing mpls mode in a specific area.
Step 5	show ip ospf 10 segment-routing Example: Device# show ip ospf 10 segment-routing	Shows the output for configuring SR under OSPF. The following example displays output from the show ip ospf segment-routing state command for the segment routing under OSPF: <pre> Device#show ip ospf 10 segment-routing OSPF Router with ID (0.0.0.1) (Process ID 10) Global segment-routing state: Enabled Segment Routing enabled: Area Topology name Forwarding 0 Base MPLS 1 Base MPLS SR Attributes Prefer non-SR (LDP) Labels Do not advertise Explicit Null Local MPLS label block (SRGB): Range: 16000 - 23999 State: Created Registered with SR App, client handle: 3 Connected map notifications active (handle 0x4), bitmask 0x1 Active policy map notifications active (handle 0x5), bitmask 0xC Registered with MPLS, client-id: 100 Bind Retry timer not running Adj Label Bind Retry timer not running </pre>

Configuring Prefix-SID for OSPF

This task explains how to configure prefix segment identifier (SID) index under each interface.

Before you begin

Segment routing must be enabled on the corresponding address family.

SUMMARY STEPS

1. enable
2. configure terminal
3. segment-routing mpls

4. connected-prefix-sid-map
5. address-family ipv4
6. 1.1.1.1/32 index 100 range 1
7. exit

DETAILED STEPS

	Command or Action	Purpose
Step 1	enable Example: Device# enable	Enables privileged EXEC mode.
Step 2	configure terminal Example: Device# configure terminal	Enters global configuration mode.
Step 3	segment-routing mpls Example: Device(config)# segment-routing mpls	Configures segment routing mpls mode.
Step 4	connected-prefix-sid-map Example: Device(config-srmppls)# connected-prefix-sid-map	Enters a sub-mode where you can configure address-family specific mappings for local prefixes and SIDs.
Step 5	address-family ipv4 Example: Device(config-srmppls-conn)# address-family ipv4	Specifies the IPv4 address family and enters router address family configuration mode.
Step 6	1.1.1.1/32 index 100 range 1 Example: Device(config-srmppls-conn-af)# 1.1.1.1/32 100 range 1	Associates SID 100 with the address 1.1.1.1/32.
Step 7	exit Example: Device(config-router)# exit	Exits segment routing mode and returns to the configuration terminal mode.

Configuring Prefix Attribute N-flag-clear

OSPF advertises prefix SIDs via Extended Prefix TLV in its opaque LSAs. It carries flags for the prefix and one of them is N flag (Node) indicating that any traffic sent along to the prefix is destined to the router originating the LSA. This flag typically marks host routes of router's loopback.

SUMMARY STEPS

1. enable
2. configure terminal
3. interface loopback3
4. ip ospf prefix-attributes n-flag-clear

DETAILED STEPS

	Command or Action	Purpose
Step 1	enable Example: Device# enable	Enables privileged EXEC mode. <ul style="list-style-type: none"> • Enter your password if prompted.
Step 2	configure terminal Example: Device# configure terminal	Enters global configuration mode.
Step 3	interface loopback3 Example: Device(config)# interface loopback3	Specifies the interface loopback.
Step 4	ip ospf prefix-attributes n-flag-clear Example: Device(config-if)# ip ospf prefix-attributes n-flag-clear	Clears the prefix N-flag.

Configuring Explicit Null Attribute With OSPF

To disable penultimate-hop-popping (PHP) and add explicit-Null label, explicit-null option needs to be specified. Once the option is given, OSPF sets the E flag in the Extended prefix-SID TLV in its LSAs.

By default, a flag called E-flag (Explicit-Null flag) is set to 0 by OSPF when advertising a Prefix SID which is associated with a loopback address. If you wish to set this flag add explicit configuration.

SUMMARY STEPS

1. enable
2. configure terminal

3. segment-routing mpls
4. set-attributes
5. address-family ipv4
6. explicit-null
7. exit-address-family

DETAILED STEPS

	Command or Action	Purpose
Step 1	enable Example: Device# enable	Enables privileged EXEC mode. <ul style="list-style-type: none"> • Enter your password if prompted.
Step 2	configure terminal Example: Device# configure terminal	Enters global configuration mode.
Step 3	segment-routing mpls Example: Device(config)# segment-routing mpls	Configures segment routing mpls mode.
Step 4	set-attributes Example: Device(config-srmppls)# set-attributes	Sets the attribute.
Step 5	address-family ipv4 Example: Device(config-srmppls-attr)# address-family ipv4	Specifies the IPv4 address family and enters router address family configuration mode.
Step 6	explicit-null Example: Device(config-srmppls-attr-af)# explicit-null	Specifies the explicit-null.
Step 7	exit-address-family Example: Device(config-srmppls-attr-af)# exit-address-family	Exits the address family.

Configuring Segment Routing Label Distribution Protocol Preference With OSPF

SUMMARY STEPS

1. enable
2. configure terminal
3. segment-routing mpls
4. set-attributes
5. address-family ipv4
6. sr-label-preferred
7. exit-address-family

DETAILED STEPS

	Command or Action	Purpose
Step 1	enable Example: Device# enable	Enables privileged EXEC mode. <ul style="list-style-type: none"> • Enter your password if prompted.
Step 2	configure terminal Example: Device# configure terminal	Enters global configuration mode.
Step 3	segment-routing mpls Example: Device(config)# segment-routing mpls	Configures segment routing mpls mode.
Step 4	set-attributes Example: Device(config-srmppls)# set-attributes	Sets the attribute.
Step 5	address-family ipv4 Example: Device(config-srmppls-attr)# address-family ipv4	Specifies the IPv4 address family and enters router address family configuration mode.
Step 6	sr-label-preferred Example: Device(config-srmppls-attr-af)# sr-label-preferred	Specifies SR label to be preferred over the LDP.

	Command or Action	Purpose
Step 7	exit-address-family Example: Device (config-srmp1s-attr-af) # exit-address-family	Exits the address family.

Configuring OSPF SRMS

The following command enables the OSPF SRMS and allows OSPF to advertise local mapping entries. OSPF does not send remote entries to the SRMS library. However, OSPF uses the SRMS active policy, which is computed based only on the locally configured mapping entries.

```
[no] segment-routing prefix-sid-map advertise-local
```

Configuring OSPF SRMS Client

By default, the OSPF SRMS client mode is enabled. OSPF always sends remote prefix-sid-mapping entries received through LSAs, to SRMS. The SRMS active policy is calculated based on both, local and remote mapping entries.

The following command disables the prefix-sid-mapping client functionality and it is configured on the receiver side.

```
segment-routing prefix-sid-map receive [disable]
```

Additional References for Segment Routing With OSPFv2 Node SID

Related Documents

Related Topic	Document Title
Cisco IOS commands	Cisco IOS Master Command List, All Releases http://www.cisco.com/c/en/us/td/docs/ios-xml/ios/mcl/allreleasemcl/all-book.html
IP Routing ISIS commands	Cisco IOS IP Routing ISIS commands http://www.cisco.com/c/en/us/td/docs/ios-xml/ios/mcl/allreleasemcl/all-book.html

Feature Information for Segment Routing With OSPFv2 Node SID

Table 5: Feature Information for Segment Routing With OSPFv2 Node SID

Feature Name	Releases	Feature Information
Segment Routing With OSPF	<p>Cisco IOS XE Release 3.16S</p> <p>Cisco IOS XE Fuji 16.7.1</p>	<p>The Segment Routing OSPFv2 node SID feature provides support for segment routing on OSPF networks.</p> <p>The following commands were introduced or modified: connected-prefix-sid-map, show ip ospf 10 segment-routing, sr-label-preferred, ip ospf prefix-attributes n-flag-clear .</p> <p>In Cisco IOS XE Fuji 16.7.1, this feature is supported on Cisco 4000 Series Integrated Service Routers.</p>



CHAPTER

7

OSPFv2 Link-protection Topology Independent Loop Free Alternate Fast Reroute

This document describes OSPFv2 implementation of IP Fast Re-Route Feature (IP FRR) using TI -LFA (Topology Independent Loop Free Alternative).

- [Restrictions for Topology Independent Loop Free Alternate Fast Reroute, on page 71](#)
- [Information About OSPFv2 Link-Protection Topology Independent Loop Free Alternate Fast Reroute, on page 72](#)
- [How to Configure Topology Independent Loop Free Alternate Fast Reroute, on page 79](#)
- [Debugging Topology Independent Loop Free Alternate Fast Reroute, on page 84](#)
- [Examples: OSPFv2 Link-Protection Topology Independent Loop Free Alternate Fast Reroute, on page 84](#)
- [Additional References for OSPFv2 Link-protection Topology Independent Loop Free Alternate Fast Reroute, on page 85](#)
- [Feature Information for OSPFv2 Link-protection Topology Independent Loop Free Alternate Fast Reroute, on page 85](#)

Restrictions for Topology Independent Loop Free Alternate Fast Reroute

- TI-LFA is supported only on OSPFv2.
- TI-LFA tunnels are created only if the router supports SR and it is configured with prefix SID. The prefix (or) node SID can be configured as connected SID (or) advertised using the SRMS (Segment Routing Mapping Server).
- TI-LFA is not supported on OSPF point to multi point interfaces.
- TI-LFA does not support Multi Topology Routing (MTR).
- TI-LFA does not create the repair path using virtual link, sham link (or) TE tunnels.
- TI-LFA tunnel is constructed and programmed by explicitly specifying the node (or) set of repair nodes through which the tunnel needs to traverse.

Information About OSPFv2 Link-Protection Topology Independent Loop Free Alternate Fast Reroute

Topology-Independent Loop-Free Alternate (TI-LFA) uses segment routing to provide link, node, and Shared Risk Link Groups (SRLG) protection in topologies where other fast reroute techniques, such as RLFA (Remote Loop Free Alternative) cannot provide protection. The goal of TI-LFA is to reduce the packet loss that results while routers converge after a topology change due to a link failure. Rapid failure repair (< 50 msec) is achieved through the use of pre-calculated backup paths that are loop-free and safe to use until the distributed network convergence process is completed.

The following are the major benefits of using TI-LFA:

- Provides 100% coverage for all the prefixes and within 50-msec link and node protection.
- Prevents transient congestion and sub-optimal routing by leveraging on the post-convergence path.
- Protects Label Distribution Protocol (LDP) and IP traffic as well.

IP Fast Reroute and Remote Loop Free Alternate

IP Fast Reroute (FRR) is a set of techniques that allow rerouting the IP traffic around a failed link or failed node in the network within a very short time (<50ms). One of the techniques that is used is Loop Free Alternates (LFA), which is implemented using OSPF protocol. OSPF currently supports per-prefix directly connected LFA and remote LFA (RLFA). The problem with these LFA algorithms is the topology dependency; the LFA algorithms cannot find a loop-free alternate path through the network for all the topologies.

The per-prefix directly connected LFA (also known as DLFA) provides loop-free alternate path for most triangular topologies, but does not provide good coverage for rectangular or circular topologies. The Remote LFA implementation (RLFA) which uses MPLS forwarding with LDP signaling for tunneling the rerouted traffic to an intermediate node, extends the IPFRR coverage in ring or rectangular topologies. For each link, RLFA defines P-Space (set of nodes reachable from calculating node without crossing the protected link) and Q-Space (set of nodes that can reach the neighbor on the protected link without crossing the protected link itself). The nodes that belong to both P and Q-Spaces are called PQ nodes and can be used as the intermediate node for the protected traffic. RLFA forms targeted LDP session to the PQ node and form the RLFA tunnel. But for the topologies where P and Q-Spaces are disjoint, R-LFA does not provide protection for those prefixes.

Topology Independent Fast Reroute

Topology Independent Fast Reroute (TI-FRR) is a technique which uses segment routing to provide link protection in any topology assuming the metric on the links in the topology is symmetrical. TI-LFA does not guarantee a backup in the cases where bandwidth on a single link is asymmetrical. TI-LFA only considers loop-free repair paths that are on the post-convergence path. It helps to do better capacity planning of the network.

TI-LFA algorithm allows to create a full explicit path through the network. Using fully specified path may lead to issues in larger topologies due to the number of segments along the path. Specifying the whole path is however not necessary, only a subset of the path is needed to carry the traffic to an intermediate node (release node) which does not loop the traffic back to the protecting node. The TI-LFA algorithm constructs a SR tunnel as the repair path. TI-LFA tunnel is constructed and programmed by explicitly specifying the node (or)

set of repair nodes through which the tunnel needs to traverse. The traffic is carried on the tunnel (when the primary path fails) which is also on the post convergence path.

Topology-Independent Loop Free Alternate

When the local LFA and remote LFA are enabled, there is a good coverage of the prefixes to be protected. However, for some rare topologies that do not have a PQ intersect node, both local and remote LFA will fail to find a release node to protect the failed link. Furthermore, there is no way to prefer a post-convergence path, as the two algorithms have no knowledge of the post-convergence characteristics of the LFA.

To overcome the above limitation, topology-independent LFA (TI-LFA) is supported on an SR-enabled network and provides the following support:

- **Link Protection**—The LFA provides repair path for failure of the link.
- **Local LFA**—Whenever a local LFA on the post convergence path is available, it is preferred over TI-LFA because local LFA does not require additional SID for the repair path. That is, the label for the PQ node is not needed for the release node.
- **Local LFA for extended P space**—For nodes in the extended P space, local LFA is still the most economical method for the repair path. In this case, TI-LFA is not chosen.
- **Tunnel to PQ intersect node**—This is similar to remote LFA except that the repair path is guaranteed on the post convergence path using TI-LFA.
- **Tunnel to PQ disjoint node**—This capability is unique to the TI-LFA in the case when local and remote LFA cannot find a repair path.
- **Tunnel to traverse multiple intersect or disjoint PQ nodes**—TI-LFA provides complete coverage of all prefixes, up to the platform's maximum supported labels.
- **P2P and Broadcast interfaces for the protected link**—TI-LFA protects P2P and broadcast interfaces.
- **Asymmetrical links**—The OSPF metrics between the neighbors are not the same.
- **Multi-homed (anycast) prefix protection**—The same prefix may be originated by multiple nodes and TI-LFA protects the anycast prefixes also by providing post convergence repair path.
- **Protected prefix filtering**—The route-map includes or excludes a list of prefixes to be protected and the option to limit the maximum repair distance to the release node.
- **Tiebreakers**—A subset of existing tiebreakers applicable to TI-LFA is supported.

Topology Independent Loop Free Alternate Tie-break

Local and remote LFA use default or user-configured heuristics to break the tie when there is more than one path to protect the prefix. The attributes are used to trim down the number of repair paths at the end of the TI-LFA link protection computation before the load balancing.

Local LFA and remote LFA support the following tiebreakers:

- **Linecard-disjoint**—Prefers the line card disjoint repair path.
- **Node-protecting**—Prefers node protecting repair path.
- **SRLG-disjoint**—Prefers SRLG disjoint repair path.
- **Load-sharing**—Distributes repair paths equally among links and prefixes.

When there are two repair paths for a particular prefix, the path that the output port on different line card than that of the primary port is chosen as the repair path.

- **LC-disjoint-index**—If both the repair paths are on the same line card as that of the primary path, then both paths are considered as candidates. If one of the path is on a different line card, then that path is chosen as the repair path.

- **SRLG-disjoint**—Prefers the SRLG disjoint repair path.

The SRLG ID can be configured for each interface. When there are two repair paths for a prefix, the configured SRLG ID for the repair path is compared with that of the primary path SRLG ID. If the SRLG IDs for the secondary path is different than that of the primary, that path is chosen as the repair path.

Effective with Cisco IOS-XE Release 3.18, node-protecting tie-breaker is disabled by default. Tie-breaker default and explicit tie-breaker on the same interface are mutually exclusive. The following tie-breakers are enabled by default on all LFAs:

- linecard-disjoint
- lowest-backup-metric
- SRLG-disjoint

P-Space

The set of routers that can be reached from S on the shortest path tree without traversing S-E is termed the P-space of S with respect to the link S-E.

Figure 5: A Simple Ring Topology

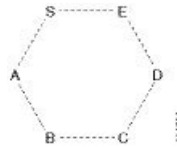

Q-Space

The set of routers from which the node E can be reached, by normal forwarding without traversing the link S-E, is termed the Q-space of E with respect to the link S-E.

Post-Convergence Path

Post convergence path is the path that OSPF uses after the link failure. TI-LFA always calculates the repair path which is the post convergence path. You can plan and dimension the post-convergence path to carry the traffic in the case of failure. TI-LFA enforces the post-convergence path by encoding it as a list of segments. The following figure shows an example of TI-LFA using post convergence path:

Figure 6: TI-LFA Using Post Convergence Path

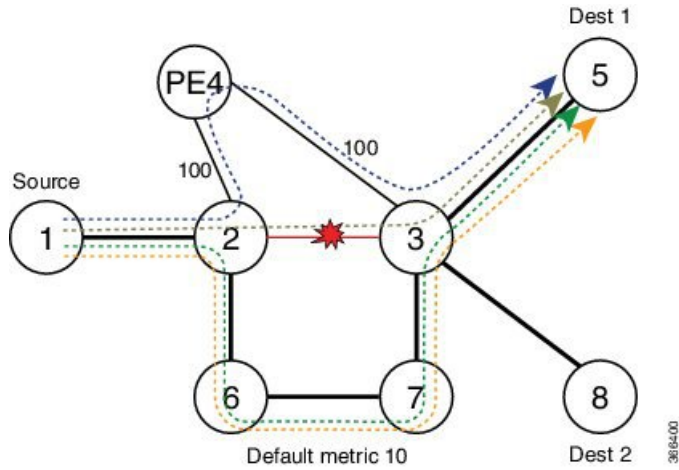

- It protects destination Node 5 on Node 2 against failure of link 2-3.
- Node 2 switches all the traffic destined to Node 5 via core links.

Per-Destination Link Protection

TI-LFA implementation provides per-destination link protection with the number of segments (labels) supported by the underlying hardware. The following figures show the implementation of TI-LFA:

Figure 7: TI-LFA: { Prefix-SID(PQ) }

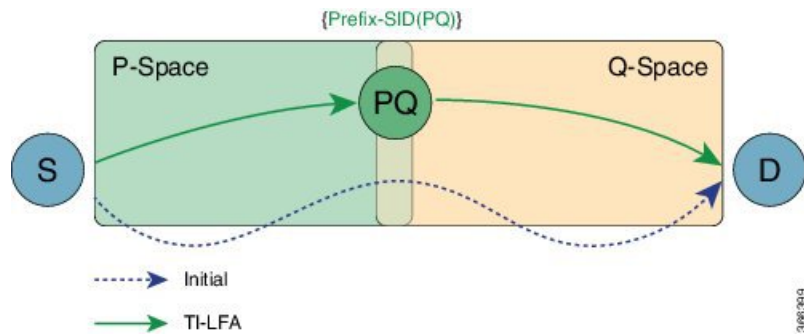

If PQ is a direct neighbor of S, then no additional segment must be pushed.

Figure 8: TI-LFA: { Prefix-SID(P) , Adj-SID (P -> Q) }

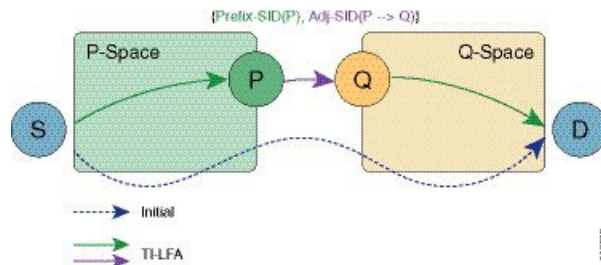

Per Interface Loop Free Alternate Enablement

- TI-LFA can be enabled on an area basis.
- TI-LFA backup path is calculated only if TI-LFA protection is enabled on the primary interface which is to be protected. By default all the interfaces are enabled for protection.
- TI-LFA repair path is restricted by the number of labels supported by the hardware. If hardware supports only 2 labels then TI-LFA repair path can protect only those prefixes which can be protected by 2 or lesser segments. For those prefixes which need more than 2 segment remain unprotected.

Prefix Processing

Once TI-LFA path is calculated for the all the links, prefix processing starts. By default only intra and inter area prefixes are protected. For external prefixes to be protected, you need to enable segment routing globally under the OSPF level.

The primary and repair path should be of the same route type for the prefixes that are protected, that means, if the intra area needs to be protected then the TI-LFA repair path also calculates for the same intra area prefix whether the prefix is unique (or) anycast prefix.

Anycast Prefix Processing

OSPF TI-LFA also calculates the repair path for the anycast prefixes. Anycast prefixes (or) dual homed prefixes are the prefixes advertised by more than one routers. They could be intra, inter (or), external prefixes. The calculation of TI-LFA repair path for anycast prefixes is as below:

- Assume the prefix P1 is advertised by the routers R1 and R2. The prefix advertised by both the routers should be of the same route type, that is, both R1 and R2 should advertise the prefix as intra area prefix (or inter or external).
- Take the primary path is calculated towards R1 due to the lesser cost.
- When TI-LFA calculates the back up path, it calculates the post convergence path. So, post convergence path need not be towards R1. If the cost to reach R2 (in the post convergence) is shorter, then TI-LFA algorithm chooses the post convergence path towards R2. TI-LFA tunnel is formed towards R2.
- When R2 un-advertises the prefix, then the TI-LFA algorithm is re-calculated towards R1 for the repair path.

Per-Prefix Loop Free Alternate Tie-Break

IP FRR has the following tie break rules in the order given below. If you have more than one repair path available to choose the best path from, the following tie-break rules are applied. If more than one path matches all the tie break rules, then all the paths are used as repair paths.

- **Post Convergence:** Prefers backup path which is the post convergence path. This is enabled by default and user can not modify this.
- **Primary-path:** Prefers backup path from ECMP set.
- **Interface-disjoint:** Point-to-point interfaces have no alternate next hop for rerouting if the primary gateway fails. You can set the interface-disjoint attribute to prevent selection of such repair paths, thus protecting the interface.

- **Lowest-backup-metric:** Prefers backup path with lowest total metric. This is not applicable for TI-LFA since TI-LFA always chooses the back up path which is lowest cost.
- **LC-disjoint:** Prefers the back up path which is in different line card than that of the primary path.
- **Broadcast-interface-disjoint :** LFA repair paths protect links when a repair path and a protected primary path use different next-hop interfaces. However, on broadcast interfaces if the LFA repair path is computed via the same interface as the primary path and their next-hop gateways are different, in that case the node gets protected, but the link might not be. You can set the broadcast-interface-disjoint attribute to specify that the repair path never crosses the broadcast network the primary path points to, that means, it cannot use the interface and the broadcast network connected to it.
- **Load Sharing:** When more than one repair path matches the above rules, load share the backup paths. This rule also can be modified by the user.



Note The user can alter and define the tiebreak rules according to the requirement. In this way, the user can re-prioritize the sequence and/or remove some of the tie break indexes which are not needed.



Note The Lowest-backup-metric policy is not applicable for TI-LFA since TI-LFA always chooses the lowest back up path only.

You can see the above rules by using the following command:

```
R2#show ip ospf fast-reroute

          OSPF Router with ID (2.2.2.200) (Process ID 10)

Microloop avoidance is enabled for protected prefixes, delay 5000 msec

Loop-free Fast Reroute protected prefixes:

          Area          Topology name  Priority  Remote LFA Enabled  TI-LFA Enabled
          0              Base           Low       No                   Yes
AS external            Base           Low       No                   Yes

Repair path selection policy tiebreaks (built-in default policy):
  0  post-convergence
 10  primary-path
 20  interface-disjoint
 30  lowest-metric
 40  linecard-disjoint
 50  broadcast-interface-disjoint
256  load-sharing

OSPF/RIB notifications:
Topology Base: Notification Enabled, Callback Registered

Last SPF calculation started 17:25:51 ago and was running for 3 ms.
```

With the introduction of TI-LFA, the following two tie-break rules are enhanced.

- node-protection
- srlg-protection

The above two tie-break rules are not enabled by default. The user needs to configure the above mentioned tie-break policies.

Node Protection

TI-LFA node protection provides protection from node failures. Node protecting TI-LFA attempts to calculate the post conversion repair path that protects against the failure of a particular next-hop, not just the link to that particular next-hop.

Node protection is used as a tiebreaker in the implementation of the local LFA also. But when it is combined with TI-LFA, the back up path calculated post convergences with node protecting path. Per-Prefix TI-LFA node protection is disabled by default. The IPFRR TI-LFA node protection features is enabled when the corresponding tiebreak is enabled along with TI-LFA feature, that is,

```
router ospf 10
  [no] fast-reroute per-prefix ti-lfa [area <area> [disable]]
  [no] fast-reroute per-prefix tie-break node-protecting index <index>
  [no] fast-reroute per-prefix tie-break node-protecting required index <index>
```

When you enable node protection, all the other tie break rules also need to manually configured. The node protection is built over the link protection.

The difference between **node-protecting** and **node-protecting required** is in selecting the backup path. When you configure **node-protecting required**, then back up which is chosen has to be the path which does not go through the node (which is part of the link which we are protecting). If no such path is available, then no path is chosen as the backup path.

Shared Risk Link Groups Protection

A shared risk link group (SRLG) is a group of next-hop interfaces of repair and protected primary paths that have a high likelihood of failing simultaneously. The OSPFv2 Loop-Free Alternate Fast Reroute feature supports only SRLGs that are locally configured on the computing router. With the introduction of TI LFA, the post convergence path which does not share the SRLG group id with the primary path interface will be chosen. In that way, the user will be sure of the SRLG protection whenever the primary link fails.

The IPFRR TI-LFA SRLG protection features is enabled when the corresponding tiebreak is enabled along with Ti-LFA feature, that is,

```
router ospf 10
  [no] fast-reroute per-prefix ti-lfa [area <area> [disable]]
  [no] fast-reroute per-prefix tie-break srlg index <index>
  [no] fast-reroute per-prefix tie-break srlg required index <index>
```

When you enable SRLG protection, you need to manually configure all the other tie break rules. The difference between **srlg-protecting** and **srlg-protecting required** is in selecting the backup path. When you configure **srlg-protecting required**, then back up which is chosen has to be the path which does not share SRLG ID with the primary link which is protected. If no such path is available, then no path is chosen as the backup path.

Whereas, if you configure **srlg-protecting** alone then if the SRLG protection path is not available, the link protection path is chosen as the backup path. And when the SRLG protection path is available, the switchover happens to the SRLG protection path.

Node-Shared Risk Link Groups Protection

You can configure both node and SRLG protection tie breaks together. This means that the back up path needs to fulfil both the criteria of node protection as well as SRLG protection. In that case, an additional TI-LFA node-SRLG combination protection algorithm is run. The TI-LFA node-SRLG combination algorithm removes the protected node and all members of the interface with the same SRLG group when computing the post-convergence shortest path tree (SPT).

To enable node and SRLG protection tie breaks together, use the following command:

```
router ospf 10
  [no] fast-reroute per-prefix ti-lfa [area <area> [disable]]
  [no] fast-reroute per-prefix tie-break node-protecting index <index>
  [no] fast-reroute per-prefix tie-break srlg index <index>
```

The following show command is used to display the tie break policy:

```
R3#show ip ospf fast-reroute

          OSPF Router with ID (3.3.3.33) (Process ID 10)

Loop-free Fast Reroute protected prefixes:

          Area          Topology name  Priority  Remote LFA Enabled  TI-LFA Enabled
          0              Base          Low      No                   No
          1              Base          Low      No                   No
          1000           Base          Low      No                   No
          AS external    Base          Low      No                   No

Repair path selection policy tiebreaks:
  0  post-convergence
 60  node-protecting
 70  srlg
256  load-sharing

OSPF/RIB notifications:
Topology Base: Notification Disabled, Callback Not Registered

Last SPF calculation started 00:00:06 ago and was running for 2 ms.
```

How to Configure Topology Independent Loop Free Alternate Fast Reroute

Enabling Topology Independent Loop Free Alternate Fast Reroute

By default, TI-LFA is disabled. You can use protocol enablement to enable TI-LFA.

Protocol enablement: Enables TI-LFA in router OSPF mode for all the OSPF areas. Perform the following steps to enable TI-LFA FRR.

```
[no] fast-reroute per-prefix ti-lfa [ area <area> disable]

router ospf <process>
fast-reroute per-prefix enable area <area> prefix-priority {low | high}
fast-reroute per-prefix ti-lfa [ area <area> disable]
```

You can also use interface command to enable or disable IP FRR on specific interfaces.

```
interface <interface>
ip ospf fast-reroute per-prefix protection disable
ip ospf fast-reroute per-prefix candidate disable
ip ospf fast-reroute per-prefix protection ti-lfa [disable]
```

Note

- When TI-LFA is configured on the OSPF router and area wide, area specific configuration takes precedence.
- To protect external prefixes, TI-LFA should be enabled globally.

Configuring Topology Independent Loop Free Alternate Fast Reroute

This task describes how to enable per-prefix Topology Independent Loop-Free Alternate (TI-LFA) computation to converge traffic flows around link, node, and SRLG failures. TI-LFA can be configured on instance or area level inherited by lower levels. You can enable or disable per prefix FRR per interface level which is applicable for TI-LFA also.

Before you begin to configure, ensure that the following topology requirements are met:

- Router interfaces are configured as per the topology.
 - Routers are configured with OSPF.
 - Segment routing is enabled globally as well as under OSPF level.
1. Enables OSPF routing for the specified routing process and enters in router configuration mode.

```
Device(config)# router ospf 10
```
 2. Enables FRR.

```
Device(config-router)# fast-reroute per-prefix enable prefix-priority low
```
 3. Enables TI-LFA.

```
Device(config-router)# fast-reroute per-prefix ti-lfa
```
 4. Enables TI-LFA on the specific area.

```
Device(config-router)# fast-reroute per-prefix ti-lfa area 0
```
 5. Exits the TI-LFA mode.

```
Device(config-router)# exit
```
 6. Enters the interface mode.

```
Device(config)#interface ethernet 0/0
```
 7. If you do not wish to enable FRR on a specific interface, use the protection disable command.



```
Device(config-if)#ip ospf fast-reroute per-prefix protection disable
```
 8. If you do not wish a specific interface to be enabled as a repair path, use the candidate disable command.

```
Device(config-if)#ip ospf fast-reroute per-prefix candidate disable
```

Configuring Topology Independent Fast Reroute Tie-breaker

You need to enable segment routing on all the routers with prefix SIDs configured for all the nodes. Use the following topology as a reference to understand the configuration.

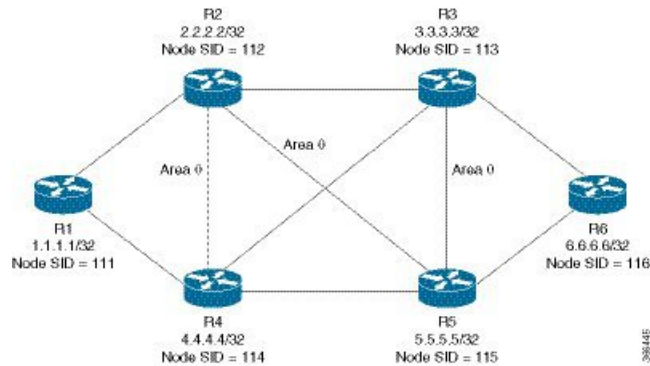
Figure 9: Configuration Example



Let us take the device R2 which is protecting the link between R2 and R3. The configuration at R2:

```
router ospf 10
fast-reroute per-prefix enable prefix-priority low
fast-reroute per-prefix ti-lfa
segment-routing mpls
segment-routing area 0 mpls
fast-reroute per-prefix enable prefix-priority low
fast-reroute per-prefix ti-lfa
fast-reroute per-prefix ti-lfa area 0
fast-reroute per-prefix tie-break node-protecting index 60
fast-reroute per-prefix tie-break srlg index 70
mpls traffic-eng router-id Loopback1
mpls traffic-eng area 0

interface GigabitEthernet4 //interface connecting to the router 4
ip address 100.101.4.4 255.255.255.0
ip ospf 10 area 0
ip ospf network point-to-point
srlg gid 10
negotiation auto

interface GigabitEthernet3 //interface connecting to the router 3
ip address 100.101.3.3 255.255.255.0
ip ospf 10 area 0
ip ospf network point-to-point
srlg gid 10
negotiation auto

interface GigabitEthernet5 //interface connecting to the router 2
ip address 100.101.5.5 255.255.255.0
ip ospf 10 area 0
ip ospf network point-to-point
srlg gid 20
negotiation auto

interface loopback2
```

```
ip address 2.2.2.2/32
ip ospf 10 area 0
```



Note In all the other devices, configuration of segment routing and assignment of connected prefix SIDs need to be done.

How Node Protection Works: Using the same topology as an example, let us take the case where you are protecting the link between R2 and R3 and also the prefix which is learnt from R6. In that case, let us assume that the primary path for the prefix is via R2-R3. So, our primary path is R2---R3---R6 and we are protecting the link R2---R3.

In this scenario, only link-protection is configured and enabled. When you enable TI-LFA under OSPF process, then you get the following paths provided the cost for all the paths are equal:

R2---R4---R5---R6

R2---R5---R3---R6

R2---R5---R6

If you have only link protection configured, then all the three paths will be chosen and they will share the load amongst them.

If you wish to configure node protection, then the backup would be calculated in such a way that the back up path does not contain the node that you are protecting. In this example, the node R3 in the back up is not required. As a result, only the following two paths would be chosen as the back up paths:

R2---R4---R5---R6

R2---R5---R6

It is possible that R2---R5---R3---R6 have the lesser cost than the above two paths. But since the node protection is configured, only the paths amongst the above two will be considered.

How SRLG Protection Works: SRLG protection further eliminates the back up paths in a such a way that the primary path and the backup does not share the same SRLG ID. Suppose the following back up paths are available:

R2---R4---R5---R6

R2---R5---R6

Then, the SRLG ID of (R2---R4) and (R2---R5) are compared against the primary interface (R2---R3) which is 10. It is noticed that only the interface R2---R5 has different SRLG ID which is 20. So, only the backup path R2---R5---R6 will be chosen.

Verifying Topology Independent Fast Reroute Tunnels

You can use the following command, to check the TI LFA tunnels:

```
Device#show ip ospf fast-reroute ti-lfa tunnels
```

```
OSPF Router with ID (2.2.2.200) (Process ID 10)
Area with ID (0)
```

Base Topology (MTID 0)

Tunnel	Interface	Next Hop	Mid/End Point	Label
MPLS-SR-Tunnel2	Et1/1	2.7.0.7	1.1.1.1	16020
MPLS-SR-Tunnel6	Et0/3	2.8.0.0	3.3.3.3	16003
MPLS-SR-Tunnel7	Et1/1	2.7.0.7	1.1.1.1	16020
			5.5.5.5	16005
			3.3.3.3	16003
MPLS-SR-Tunnel5	Et0/3	2.8.0.0	5.5.5.5	16005
MPLS-SR-Tunnel11	Et1/1	2.7.0.7	1.1.1.1	16020
			5.5.5.5	16005
MPLS-SR-Tunnel3	Et1/1	2.7.0.7	6.6.6.6	16006

You can use the following command, to check the route in OSPF routing table with primary and repair path:

```
Device#show ip ospf rib 6.6.6.6
```

```
OSPF Router with ID (2.2.2.200) (Process ID 10)
```

```
Base Topology (MTID 0)
```

```
OSPF local RIB
```

```
Codes: * - Best, > - Installed in global RIB
```

```
LSA: type/LSID/originator
```

```
*> 6.6.6.6/32, Intra, cost 31, area 0
    SPF Instance 19, age 02:12:11
    contributing LSA: 10/7.0.0.0/6.6.6.6 (area 0)
    SID: 6
    CSTR Local label: 0
    Properties: Sid, LblRegd, SidIndex, N-Flag, TeAnn
    Flags: RIB, HiPrio
    via 2.7.0.7, Ethernet1/1 label 16006
    Flags: RIB
    LSA: 1/6.6.6.6/6.6.6.6
    PostConvrq repair path via 3.3.3.3, MPLS-SR-Tunnel6 label 16006, cost 81, Lbl cnt 1
    Flags: RIB, Repair, PostConvrq, IntfDj, LC Dj
    LSA: 1/6.6.6.6/6.6.6.6
```

You can use the following command, to display the route in the IP routing table:

```
Device#show ip route 6.6.6.6
Routing entry for 6.6.6.6/32
  Known via "ospf 10", distance 110, metric 31, type intra area
  Last update from 2.7.0.7 on Ethernet1/1, 00:25:14 ago
  SR Incoming Label: 16006
  Routing Descriptor Blocks:
  * 2.7.0.7, from 6.6.6.6, 00:25:14 ago, via Ethernet1/1, merge-labels
    Route metric is 31, traffic share count is 1
    MPLS label: 16006
    MPLS Flags: NSF
    Repair Path: 3.3.3.3, via MPLS-SR-Tunnel6
```

Debugging Topology Independent Loop Free Alternate Fast Reroute

You can use the following commands to debug TI-LFA FRR:

```
debug ip ospf fast-reroute spf
debug ip ospf fast-reroute spf detail
debug ip ospf fast-reroute rib
debug ip ospf fast-reroute rib [<access-list>]
```

Examples: OSPFv2 Link-Protection Topology Independent Loop Free Alternate Fast Reroute

The following are the examples for the OSPFv2 Link-Protection TI-LFA FRR.

Example: Configuring Topology Independent Loop Free Alternate Fast Reroute

This example shows how to configure TI-LFA for segment routing TE tunnels using single or disjoint PQ nodes. The following are the two topologies used:

- Topology 1: A single PQ Node and therefore has two SIDs from the source router, R1 through the PQ Node to the destination router, R5.

Figure 10: Topology 1: Single PQ Node

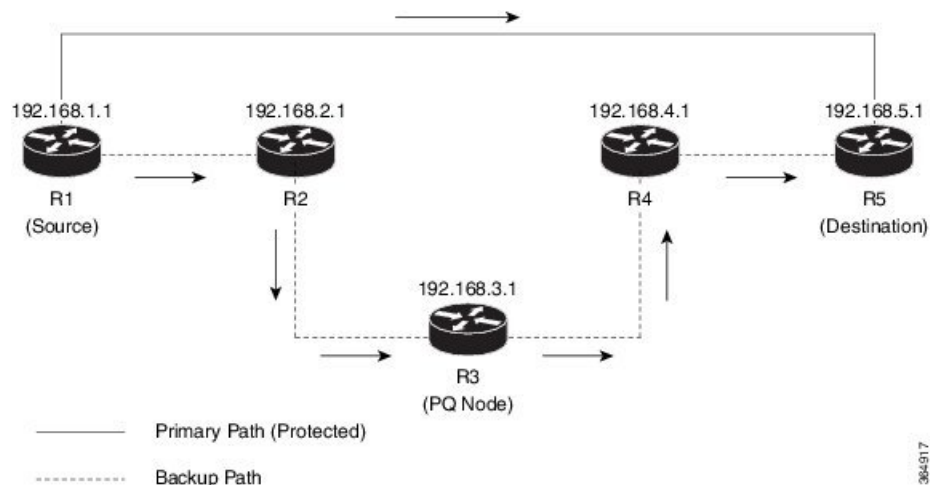

- Topology 2: Disjoint PQ Nodes and therefore consists of three SIDs from the source router R1, through the P Node and the Q Node to the destination router, R5.

Figure 11: Topology 2: Disjoint PQ Nodes

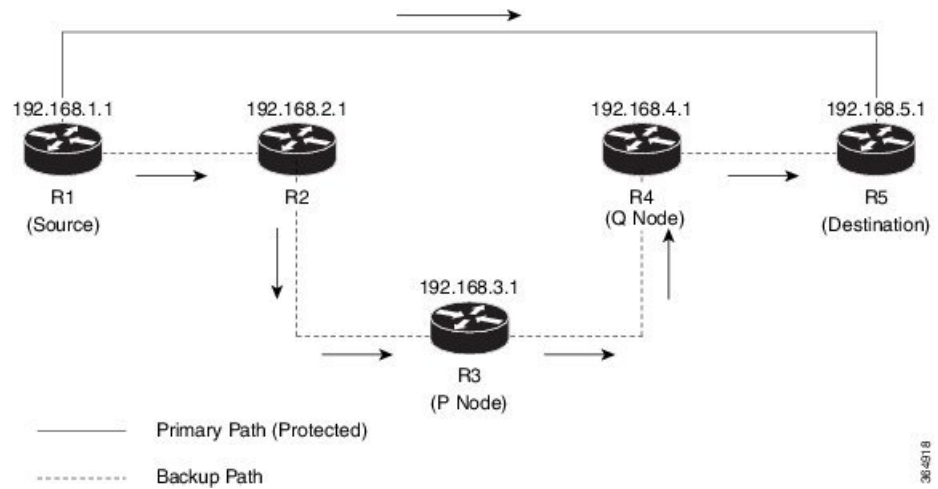

Configure TI-LFA for OSPF on the source router (R1) interface connecting to the destination router (R5).

```
Device(config)# router ospf 10
Device(config-router)# fast-reroute per-prefix enable prefix-priority low
Device(config-router)# fast-reroute per-prefix ti-lfa
Device(config-router)# fast-reroute per-prefix ti-lfa area 0
Device(config-router)# exit
```

Additional References for OSPFv2 Link-protection Topology Independent Loop Free Alternate Fast Reroute

Related Documents

Related Topic	Document Title
Cisco IOS Commands	Cisco IOS Master Command List, All Releases

Feature Information for OSPFv2 Link-protection Topology Independent Loop Free Alternate Fast Reroute

The following table provides release information about the feature or features described in this module. This table lists only the software release that introduced support for a given feature in a given software release train. Unless noted otherwise, subsequent releases of that software release train also support that feature.

Use Cisco Feature Navigator to find information about platform support and Cisco software image support. To access Cisco Feature Navigator, go to www.cisco.com/go/cfn. An account on Cisco.com is not required.

Table 6: Feature Information for OSPFv2 Link-protection Topology Independent Loop Free Alternate Fast Reroute

Feature Name	Releases	Feature Information
OSPFv2 Link-protection Topology Independent Loop Free Alternate Fast Reroute	Cisco IOS XE Everest 16.4.1 Cisco IOS XE Fuji 16.7.1	<p>Topology-Independent Loop-Free Alternate (TI-LFA) uses segment routing to provide link, node, and Shared Risk Link Groups (SRLG) protection in topologies where other fast reroute techniques cannot provide protection. The goal of TI-LFA is to reduce the packet loss that results while routers converge after a topology change due to a link failure.</p> <p>The following commands were introduced or modified:</p> <p>fast-reroute per-prefix ti-lfa [area <area> [disable]], fast-reroute per-prefix tie-break node-protecting index <index>, fast-reroute per-prefix tie-break node-protecting required index <index>, fast-reroute per-prefix tie-break srlg index <index>, fast-reroute per-prefix tie-break srlg required index <index>, ip ospf fast-reroute per-prefix protection disable, ip ospf fast-reroute per-prefix candidate disable, show ip ospf fast-reroute ti-lfa tunnels.</p> <p>In Cisco IOS XE Fuji 16.7.1, this feature is supported on Cisco 4000 Series Integrated Service Routers.</p>



CHAPTER 8

Segment Routing Traffic Engineering With OSPF

This chapter describes how Segment Routing traffic engineering can be implemented using OSPF.

- [Restrictions for Segment Routing Traffic Engineering With OSPF, on page 87](#)
- [Information About Segment Routing Traffic Engineering With OSPF, on page 87](#)
- [How to Configure Segment Routing Traffic Engineering With OSPF, on page 95](#)
- [Verifying Configuration of the SR-TE Tunnels, on page 103](#)
- [Additional References for Segment Routing Traffic Engineering With OSPF, on page 106](#)
- [Feature Information for Segment Routing Traffic Engineering With OSPF, on page 106](#)

Restrictions for Segment Routing Traffic Engineering With OSPF

- Segment Routing Traffic Engineering is supported only on OSPFv2.
- SR-TE is not supported on broadcast interfaces; it is supported only point-to-point interfaces.
- The Cisco ASR routers support only a specific number of labels imposed on an outgoing packet. If the number of labels are greater than the specified number, the SR-TE tunnel creation fails. The Cisco ASR1000 routers support a maximum of 16 labels.
- Only one instance of protocol should be enabled for TE at a given point of time.

Information About Segment Routing Traffic Engineering With OSPF

A Traffic Engineered (TE) tunnel is a container of TE LSP(s) instantiated between the tunnel ingress and the tunnel destination. A TE tunnel may instantiate one or more SR-TE LSP(s) that are associated with the same tunnel. The SR-TE LSP path may not necessarily follow the same IGP path to a destination node. In this case, the SR-TE path can be specified a set of prefix-SID(s) and/or adjacency-SID(s) of nodes and/or links to be traversed by the SR-TE LSP.

The head-end imposes the corresponding MPLS label stack on to outgoing packets to be carried over the tunnel. Each transit node along the SR-TE LSP path uses the incoming top label to select the next-hop, pop or swap the label, and forward the packet to the next node with the remainder of the label stack, until the packet reaches the ultimate destination. OSPF provides TE with the topology and SR related information. SR related information include SRGB/prefix/Adjacency SIDs of all nodes/links with SR enabled in the network.

Benefits of Using Segment Routing Traffic Engineering With OSPF

Segment routing traffic engineering offers a comprehensive support for all useful optimizations and constraints, for example:

- Latency
- Bandwidth
- Disjointness
- Resource avoidance

OSPFv2 provides the following functionalities for SR-TE:

- OSPFv2 provides SR information along with TE topology information to TE module.
- TE uses this information to construct SR TE path/tunnel comprising of one or more segments - with the combination of prefix and/or adjacency segments.
- For the prefixes TE is interested in, OSPF provides first hop resolution to setup the forwarding plane.
- SR TE tunnels are also advertised back into OSPF (like RSVP TE tunnels) for diverting traffic over the SR-TE tunnels.

OSPFv2 Segment Routing Traffic Engineering Functionalities

OSPFv2 perform the following functionalities for SR-TE:

- OSPFv2 provides SR information along with TE topology information to TE module.
- TE uses this information to construct SR TE path/tunnel comprising of one or more segments - with the combination of prefix and/or adjacency segments.
- For the prefixes TE is interested in, OSPF provides first hop resolution to setup the forwarding plane.
- SR TE tunnels are also advertised back into OSPF (like RSVP TE tunnels) for diverting traffic over the SR-TE tunnels.

Protected Adjacency SID

Segment routing creates protected adjacency SID for point to point to point interfaces and broadcast interfaces. It advertises them to the extended link-state advertisement (LSA) along with the unprotected adjacency SID. Protected adjacency SID can have a repair path, but it is not guaranteed to have a repair path.

Traffic Engineering Interfaces

In order to support SR-TE functionality, TE interfaces with various components, and with IGP (OSPF and ISIS) to distribute and receive information on TE topology. For SR-TE support, OSPF needs to additionally provide SR information to TE that it had received through various LSAs, for example,

- Router Information LSA
- Extended Prefix LSA

- Extended Link LSA

TE interfaces distribute information, such as bandwidth resources, constraints, capabilities, and other attributes, associated with the links that are configured for TE. The link information is distributed to other routers using opaque LSAs and is used by TE to create a local topology database. The topology database is a key element in allowing TE to compute a suitable constraint-based path for establishing an LSP. TE also interfaces with the IGP to notify when a TE headend interface can be considered for routing packets.

Unnumbered Support

IS-IS description of an unnumbered link does not contain remote interface ID information. The remote interface ID of an unnumbered link is required to include the unnumbered link as part of the SR-TE tunnel.

Segment Routing Traffic Engineering Support for Forwarding Adjacency

MPLS TE forwarding adjacency feature is supported by OSPF. In this, TE tunnel is considered as a link in the IGP network. TE tunnel interfaces are advertised in the IGP network like any other links. Routers can then use these links to compute the shortest path tree (SPT).



Note This feature is not supported with the SR-TE tunnels.

Segment Routing Traffic Engineering Support for Auto-route Announce

MPLS TE auto-route announce feature is supported by OSPF, that uses TE Tunnel as the first-hop, if the node is reachable via that tunnel. It allows the traffic to the nodes that are downstream to the tail-end of the TE tunnel flows through the tunnel. OSPF supports auto-route over the SR-TE tunnels similar to the MPLS TE tunnels setup using RSVP.

The TE tunnel that instantiates an SR-TE LSP can be Auto-route Announced (AA) into IGP (OSPF and ISIS) as an IGP shortcut. The IGP uses the TE tunnel as next hop and installs routes in RIB for all IP prefixes whose shortest path falls behind the TE tunnel destination. Auto-route announce for of TE tunnels is supported to carry IPV4 prefixes.

Auto-route Announce IP2MPLS

The auto-routeIP2MPLS feature is introduced for SR tunnels to avoid potential packet from looping indefinitely between the SR-TE tunnel headend/ingress and a node that is pointing/routing the packet back to the headend/ingress.

The solution consists in the headend programming in forwarding two sets of path(s) for the prefixes that are mapped over the SR-TE tunnel. The first is the pure IP route for the prefix(es) mapped on the and having the outgoing interface as the tunnel interface. This allows mapping IP traffic directly over the tunnel. The second is the MPLS path for the prefixes mapped on the tunnel. For this the prefix-SID label is programmed with the IGP shortest path outgoing interface(s), that is, non tunnel output interfaces.

SR-TE LSP Instantiation

A Traffic Engineered (TE) tunnel is a container of one or more instantiated TE LSPs. An SR-TE LSP is instantiated by configuring ‘segment-routing’ on the path-option of the TE tunnel. The traffic mapped to the tunnel is forwarded over the primary SR-TE instantiated LSP.

Multiple path-options can also be configured under the same tunnel. Each path-option is assigned a preference index or a path-option index that is used to determine the more favorable path-option for instantiating the primary LSP—the lower the path-option preference index, the more favorable the path-option. The other less favorable path-options under the same TE tunnel are considered secondary path-options and may be used once the currently used path-option is invalidated (for example, due to a failure on the path).



Note A forwarding state is maintained for the primary LSP only.

Tunnel Path Affinity Validation

The affinity of a tunnel path can be specified using the command **tunnel mpls traffic-eng affinity** under the tunnel interface.

The head-end validates that the specified SR path is compliant with the configured affinity. This necessitates that the paths of each segment of the SR path be validated against the specified constraint. The path is declared invalid against the configured affinity constraints if at least a single segment of the path does not satisfy the configured affinity.

SR-TE Traffic Load Balancing

SR-TE tunnels support the following load-balancing options:

Load Balancing on Port Channel TE Links

Port Channel interfaces carry the SR-TE LSP traffic. This traffic load balances over port channel member links as well as over bundle interfaces on the head or mid of an SR-TE LSP.

Load Balancing on Single Tunnel

While using the equal cost multi path protocol (ECMP), the path to a specific prefix-SID may point to multiple next-hops. And if the SR-TE LSP path traverses one or more prefix-SIDs that have ECMP, the SR-TE LSP traffic load-balances on the ECMP paths of each traversed prefix-SID from the head-end or any midpoint traversed node along the SR-TE LSP path.

Load Balancing on Multiple Tunnels

Multiple TE tunnels can be used as next-hop paths for routes to specific IP prefixes either by configuring static route on multiple tunnels, or auto-route announcing multiple parallel tunnels to the same destination. In such cases, the tunnels share the traffic load equally or load balance traffic on multiple parallel tunnels. It is also possible to allow Unequal Load Balance (UELB) with an explicit per tunnel configuration at the tunnel head-end. In this case, the tunnel load-share is passed from MPLS-TE to forwarding plane.

The tunnel load-share feature continues to work for TE tunnels that instantiate the SR-TE LSPs.

SR-TE Tunnel Re-optimization

TE tunnel re-optimization occurs when the head-end determines that there is a more optimal path available than the one currently used. For example, in case of a failure along the SR-TE LSP path, the head-end could detect and revert to a more optimal path by triggering re-optimization.

Tunnels that instantiate SR-TE LSP can re-optimize without affecting the traffic carried over the tunnel.

Re-optimization can occur because:

- the explicit path hops used by the primary SR-TE LSP explicit path are modified,
- the head-end determines the currently used path-option are invalid due to either a topology path disconnect, or a missing SID in the SID database that is specified in the explicit-path
- a more favorable path-option (lower index) becomes available

When the head-end detects a failure on a protected SR adjacency-SID that is traversed by an SR-TE LSP, it starts the invalidation timer. If the timer expires and the head-end is still using the failed path because it is unable to reroute on a different path, the tunnel state is brought 'down' to avoid black-holing the traffic. Once the tunnel is down, services on the tunnel converge to take a different path.

The following is a sample output of a manual re-optimization example. In this example, the path-option is changed from '10' to '20'.

```
Router# mpls traffic-eng reoptimize tunnel 1 path-option 20
The targeted path-option is not in lock down mode. Continue? [no]: yes
Router# show mpls traffic-eng tunnels tunnell
Name: R1_t1 (Tunnell) Destination: 6.6.6.6
Status:
  Admin: up Oper: up Path: valid Signalling: connected
  path option 20, (SEGMENT-ROUTING) type explicit IP_PATH (Basis for Setup)
  path option 10, (SEGMENT-ROUTING) type dynamic
Config Parameters:
  Bandwidth: 0 kbps (Global) Priority: 6 6 Affinity: 0x0/0xFFFF
  Metric Type: IGP (interface)
  Path Selection:
  Protection: any (default)
  Path-invalidation timeout: 45000 msec (default), Action: Tear
  AutoRoute: enabled LockDown: disabled Loadshare: 10 [200000000]
  auto-bw: disabled
  Fault-OAM: disabled, Wrap-Protection: disabled, Wrap-Capable: No
Active Path Option Parameters:
  State: explicit path option 20 is active
  BandwidthOverride: disabled LockDown: disabled Verbatim: disabled
History:
  Tunnel:
  Time since created: 6 days, 19 hours, 9 minutes
  Time since path change: 14 seconds
  Number of LSP IDs (Tun_Instances) used: 1819
  Current LSP: [ID: 1819]
  Uptime: 17 seconds
  Selection: reoptimization
  Prior LSP: [ID: 1818]
  ID: path option unknown
  Removal Trigger: reoptimization completed
Tun_Instance: 1819
Segment-Routing Path Info (isis level-1)
  Segment0[Node]: 4.4.4.4, Label: 114
  Segment1[Node]: 5.5.5.5, Label: 115
  Segment2[Node]: 6.6.6.6, Label: 116
```

SR-TE With Lockdown Option

The **lockdown** option prevents SR-TE from re-optimizing to a better path. However, it does not prevent signaling the existence of a new path.

```
interface Tunnell
 ip unnumbered Loopback1
 tunnel mode mpls traffic-eng
 tunnel destination 6.6.6.6
 tunnel mpls traffic-eng autoroute announce
 tunnel mpls traffic-eng priority 6 6
 tunnel mpls traffic-eng path-option 10 segment-routing lockdown
 tunnel mpls traffic-eng path-selection metric igp
 tunnel mpls traffic-eng load-share 10
Router# show mpls traffic-eng tunnels tunnell
Name: csr551_t1 (Tunnell) Destination: 6.6.6.6
Status:
  Admin: up      Oper: up      Path: valid      Signalling: connected
  path option 10, (LOCKDOWN) type segment-routing (Basis for Setup)
Config Parameters:
  Bandwidth: 0      kbps (Global)  Priority: 6 6  Affinity: 0x0/0xFFFF
  Metric Type: IGP (interface)
  Path Selection:
    Protection: any (default)
  Path-invalidation timeout: 45000 msec (default), Action: Tear
  AutoRoute: enabled LockDown: enabled Loadshare: 10 [200000000]
  auto-bw: disabled
  Fault-OAM: disabled, Wrap-Protection: disabled, Wrap-Capable: No
Active Path Option Parameters:
  State: segment-routing path option 10 is active
  BandwidthOverride: disabled LockDown: enabled Verbatim: disabled
History:
  Tunnel:
    Time since created: 6 days, 19 hours, 22 minutes
    Time since path change: 1 minutes, 26 seconds
    Number of LSP IDs (Tun_Instances) used: 1822
  Current LSP: [ID: 1822]
    Uptime: 1 minutes, 26 seconds
    Selection: reoptimization
  Prior LSP: [ID: 1821]
    ID: path option unknown
    Removal Trigger: configuration changed
  Tun_Instance: 1822
  Segment-Routing Path Info (isis level-1)
    Segment0[Node]: 6.6.6.6, Label: 116
```

SR-TE Tunnel Protection

Protection for SR TE tunnels can take any of the following alternatives:

IP-FRR Local Repair Protection

On an SR-TE LSP head-end or mid-point node, IP-FRR is used to compute and program the backup protection path for the prefix-SID or adjacency-SID label.

With IP-FRR, backup repair paths are pre-computed and pre-programmed by IGPs *before* a link or node failure. The failure of a link triggers its immediate withdrawal from the TE topology (link advertisement withdrawal). This allows the head-end to detect the failure of an SR-TE LSP traversing the failed adjacency-SID.

When a protected adjacency-SID fails, the failed adjacency-SID label and associated forwarding are kept functional for a specified period of time (5 to 15 minutes) to allow all SR TE tunnel head-ends to detect and react to the failure. Traffic using the adjacency-SID label continues to be FRR protected even if there are subsequent topology updates that change the backup repair path. In this case, the IGP updates the backup repair path while FRR is active to reroute traffic on the newly-computed backup path.

When the primary path of a protected prefix-SID fails, the PLR reroutes to the backup path. The head-end remains transparent to the failure and continues to use the SR-TE LSP as a valid path.

IP-FRR provides protection for adjacency and prefix-SIDs against link failures only.

Tunnel Path Protection

Path protection is the instantiation of one or more standby LSPs to protect against the failure of the primary LSP of a single TE tunnel.

Path protection protects against failures by pre-computing and pre-provisioning secondary paths that are failure diverse with the primary path-option under the same tunnel. This protection is achieved by computing a path that excludes prefix-SIDs and adjacency-SIDs traversed by the primary LSP or by computing a path that excludes SRLGs of the primary SR-TE LSP path.

In the event of a failure of the primary SR-TE LSP, at least one standby SR-TE LSP is used for the tunnel. Multiple secondary path-options can be configured to be used as standby SR-TE LSPs paths.

SR-TE LSP Path Verification

SR-TE tunnel functionality requires that the head-end perform initial verification of the tunnel path as well as the subsequent tracking of the reachability of the tunnel tail-end and traversed segments.

Path verification for SR-TE LSP paths is triggered whenever MPLS-TE is notified of any topology changes or SR SID updates.

The SR-TE LSP validation steps consist of the following checks:

Topology Path Validation

The head-end validates the path of an SR-TE LSP for connectivity against the TE topology. MPLS-TE head-end checks if links corresponding to the adjacency SIDs are connected in the TE topology.

For newly-instantiated SR-TE LSPs, if the head-end detects a discontinuity on any link of the SR-TE path, that path is considered invalid and is not used. If the tunnel has other path-options with valid paths, those paths are used to instantiate the tunnel LSP.

For TE tunnels with existing instantiated SR-TE LSP, if the head-end detects a discontinuity on any link, the head-end assumes a fault has occurred on that link. In this case, the local repair protection, such as the IP FRR, come in to effect. The IGPs continue to sustain the protected adjacency label and associated forwarding after the adjacency is lost for some time. This allows the head-ends enough time to reroute the tunnels onto different paths that are not affected by the same failure. The head-end starts a tunnel invalidation timer once it detects the link failure to attempt to reroute the tunnel onto other available path-options with valid paths.

If the TE tunnel is configured with other path-options that are not affected by the failure and are validated, the head-end uses one of those path-options to reroute (and re-optimize) the tunnel by instantiating a new primary LSP for the tunnel using the unaffected path.

If no other valid path-options exist under the same tunnel, or if the TE tunnel is configured with only one path-option that is affected by the failure, the head-end starts an invalidation timer after which it brings the

tunnel state to 'down'. This action avoids black-holing the traffic flowing over the affected SR-TE LSP, and allows services riding over the tunnel to reroute over different available paths at the head-end. There is an invalidation drop configuration that keeps the tunnel 'up', but drops the traffic when the invalidation timer expires.

For intra-area SR-TE LSPs, the head-end has full visibility over the LSP path, and validates the path to the ultimate LSP destination. However, for inter-area LSPs, the head-end has partial visibility over the LSP path—only up to the first ABR. In this case, the head-end can only validate the path from the ingress to the first ABR. Any failure along the LSP beyond the first ABR node is invisible to the head-end, and other mechanisms to detect such failures, such as BFD over LSP are assumed.

SR SID Validation

SID hops of an SR-TE LSP are used to determine the outgoing MPLS label stack to be imposed on the outgoing packets carried over the SR-TE LSP of a TE tunnel. A database of global and local adjacency-SIDs is populated from the information received from IGPs and maintained in MPLS-TE. Using a SID that is not available in the MPLS TE database invalidates the path-option using the explicit-path. The path-option, in this case, is not used to instantiate the SR TE LSP. Also, withdrawing, adding, or modifying a SID in the MPLS-TE SID-database, results in the MPLS-TE head-end verifying all tunnels with SR path-options (in-use or secondary) and invokes proper handling.

LSP Egress Interface

When the SR-TE LSP uses an adjacency-SID for the first path hop, TE monitors the interface state and IGP adjacency state associated with the adjacency-SID and the node that the SR-TE LSP egresses on. If the interface or adjacency goes down, TE can assume a fault occurred on the SR-TE LSP path and take the same reactive actions described in the previous sections.



Note When the SR-TE LSP uses a prefix-SID for the first hop, TE cannot directly infer on which interface the tunnel egresses. TE relies on the IP reachability information of the prefix to determine if connectivity to the first hop is maintained.

IP Reachability Validation

MPLS-TE validates that the nodes corresponding to the prefix-SIDs are IP reachable before declaring the SR path valid. MPLS-TE detects path changes for the IP prefixes corresponding to the adjacency or prefix SIDs of the SR-TE LSP path. If the node announcing a specific SID loses IP reachability, due to a link or node failure, MPLS-TE is notified of the path change (no path). MPLS-TE reacts by invalidating the current SR-TE LSP path, and may use other path-options with a valid path, if any to instantiate a new SR-TE LSP.



Note Since IP-FRR does not offer protection against failure of a node that is being traversed by an SR-TE LSP (such as, a prefix-SID failure along the SR-TE LSP path), the head-end immediately reacts to IP route reachability loss for prefix-SID node by setting the tunnel state to 'down' and removes the tunnel forwarding entry if there are no other path-options with valid path for the affected tunnel.

Tunnel Path Resource Avoidance Validation

You can specify a set of addresses to be validated as excluded from being traversed by SR-TE tunnel packets. To achieve this, the head-end runs the per-segment verification checks and validates that the specified node, prefix or link addresses are indeed excluded from the tunnel in the SR path. The tunnel resource avoidance checks can be enabled per path using the commands below. The list of addresses to be excluded are defined and the name of the list is referenced in the path-option.

```
interface tunnel100
 tunnel mpls traffic-eng path-option 1 explicit name EXCLUDE segment-routing
 ip explicit-path name EXCLUDE enable
  exclude-address 192.168.0.2
  exclude-address 192.168.0.4
  exclude-address 192.168.0.3
!
```

SR-TE LSP Explicit Null

MPLS-TE tunnel head-end does not impose explicit-null at the bottom of the stack. When penultimate hop popping (PHP) is enabled for SR prefix SIDs or when an adjacency SID is the last hop of the SR-TE LSP, the packet may arrive at the tail-end without a transport label. However, in some cases, it is desirable that the packet arrive at the tail-end with explicit-null label, and in such case, the head-end will impose an explicit-null label at the top of the label stack.

Verbatim Path Support

MPLS TE LSPs usually require that all the nodes in the network are TE aware which means that they have IGP extensions to TE in place. However, some network administrators want the ability to build TE LSPs to traverse nodes that do not support IGP extensions to TE, but that do support RSVP extensions to TE. Verbatim LSPs are helpful when all or some of the intermediate nodes in a network do not support IGP extensions for TE.

When this feature is enabled, the IP explicit path is not checked against the TE topology database. Since the TE topology database is not verified, a Path message with IP explicit path information is routed using the shortest path first (SPF) algorithm for IP routing.

How to Configure Segment Routing Traffic Engineering With OSPF

Perform the following steps to configure Segment Routing Traffic Engineering With OSPF.

Enabling Segment Routing Traffic Engineering With OSPF

OSPF Segment Routing traffic engineering is enabled when the segment-routing is enabled along with mpls traffic engineering. SR-TE support is turned on in an area when you enable SR & MPLS TE in that area.

```
router ospf 10
 router-id 10.10.10.2
 segment-routing mpls
 mpls traffic-eng area 0
```

Configuring Path Option for a TE Tunnel

The **segment-routing** keyword indicates that the specified path is programmed as an SR path:

```
Device(config)# interface tunnel 100
Device(config-if)# tunnel mpls traffic-eng path-option 1 explicit name foo segment-routing
Device(config-if)# tunnel mpls traffic-eng path-option 2 dynamic segment-routing
Device(config-if)# tunnel mpls traffic-eng path-option 3 segment-routing
```



Note With IP unnumbered interfaces dynamic path is not supported.

When the path-option type for an operational SR tunnel is changed from SR to non-SR (for example, **dynamic**), the existing forwarding entry of the tunnel is deleted.

Segment Routing can be enabled or disabled on an existing secondary or an in-use path-option. If the tunnel uses a signaled RSVP-TE explicit path-option and segment routing is enabled on that tunnel, the RSVP-TE LSP is torn, and the SR-TE LSP is instantiated using the same path-option. Conversely, if segment routing is disabled on a path-option that is in use by the primary LSP, the tunnel goes down intermittently and a new RSVP-TE LSP will be signaled using the same explicit path.

If the segment-routing path-option is enabled on a secondary path-option (that is, not in-use by the tunnel's primary LSP), the tunnel is checked to evaluate if the newly specified SR-TE LSP path-option is valid and more favorable to use for the tunnel primary LSP.

Configuring SR Explicit Path Hops

The following SR-TE explicit path hops are supported:

- IP addresses
- MPLS labels
- Mix of IP addresses and MPLS labels

For intra-area LSPs, the explicit path can be specified as a list of IP addresses.

```
Device(config)# ip explicit-path name foo
Device(config-ip-expl-path)# index 10 next-address 1.1.1.1 node address
Device(config-ip-expl-path)# index 20 next-address 12.12.12.2 link address
```



Note When using IP unnumbered interfaces, you cannot specify next hop address as an explicit path index. It should be node address or label.

The explicit path can also be specified as segment-routing SIDs:

```
Device(config)# ip explicit-path name foo
Device(config-ip-expl-path)# index 10 next-label 20
```



Note IP addresses cannot be used after using the label in MIXED_PATH.

Configuring Tunnel Path Affinity Validation

The affinity of a tunnel path can be specified using the command **tunnel mpls traffic-eng affinity** under the tunnel interface.

The head-end validates that the specified SR path is compliant with the configured affinity. This necessitates that the paths of each segment of the SR path be validated against the specified constraint. The path is declared invalid against the configured affinity constraints if at least a single segment of the path does not satisfy the configured affinity.

```
interface Tunnell
no ip address
tunnel mode mpls traffic-eng
tunnel destination 5.5.5.5
tunnel mpls traffic-eng priority 5 5
tunnel mpls traffic-eng bandwidth 100
tunnel mpls traffic-eng affinity 0x1 mask 0xFFFF
tunnel mpls traffic-eng path-option 10 dynamic segment-routing
Router# show tunnel ??
Name: R1_t1 (Tunnell) Destination: 5.5.5.5
Status:
Admin: up Oper: up Path: valid Signalling: connected
path option 10, (SEGMENT-ROUTING) type dynamic (Basis for Setup, path weight 20)
Config Parameters:
Bandwidth: 100 kbps (Global) Priority: 5 5 Affinity: 0x1/0xFFFF
Metric Type: TE (default)
Path Selection:
Protection: any (default)
Path-selection Tiebreaker:
Global: not set Tunnel Specific: not set Effective: min-fill (default)
Hop Limit: disabled
Cost Limit: disabled
Path-invalidation timeout: 10000 msec (default), Action: Tear
AutoRoute: disabled LockDown: disabled Loadshare: 100 [0] bw-based
auto-bw: disabled
Fault-OAM: disabled, Wrap-Protection: disabled, Wrap-Capable: No
Active Path Option Parameters:
State: dynamic path option 10 is active
BandwidthOverride: disabled LockDown: disabled Verbatim: disabled
Node Hop Count: 2
History:
Tunnel:
Time since created: 10 minutes, 54 seconds
Time since path change: 34 seconds
Number of LSP IDs (Tun_Instances) used: 55
Current LSP: [ID: 55]
Uptime: 34 seconds
Prior LSP: [ID: 49]
ID: path option unknown
Removal Trigger: tunnel shutdown
Tun_Instance: 55
Segment-Routing Path Info (isis level-1)
Segment0[Link]: 192.168.2.1 - 192.168.2.2, Label: 46
Segment1[Link]: 192.168.4.2 - 192.168.4.1, Label: 49
```

Configuring Affinity on an Interface

Perform the following steps to configure affinity on an interface:

```

interface GigabitEthernet2
ip address 192.168.2.1 255.255.255.0
ip router isis 1
negotiation auto
mpls traffic-eng tunnels
mpls traffic-eng attribute-flags 0x1
isis network point-to-point
ip rsvp bandwidth

```

Configuring Segment Routing Traffic Engineering With OSPF

Consider the following inter area and intra area use cases for configuring SR-TE with OSPF:

Configuring Intra Area Tunnel

Consider the following topology to configure intra area tunnel:

Figure 12: Intra Area Tunnel

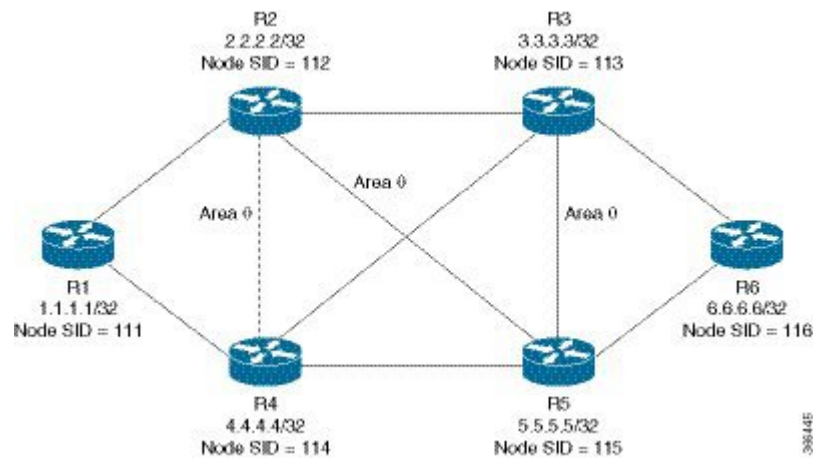

All the routers are configured in the same area, Area 0.

Configuration at the head end router R1:

```

router ospf 10
fast-reroute per-prefix enable prefix-priority low
fast-reroute per-prefix ti-lfa
segment-routing mpls
mpls traffic-eng router-id Loopback1
mpls traffic-eng area 0

interface GigabitEthernet2 //interface connecting to the router 2
ip address 100.101.1.1 255.255.255.0
ip ospf 10 area 0
ip ospf network point-to-point
negotiation auto
mpls traffic-eng tunnels

interface GigabitEthernet4 //interface connecting to the router 4
ip address 100.101.1.1 255.255.255.0
ip ospf 10 area 0
ip ospf network point-to-point
negotiation auto
mpls traffic-eng tunnels

```



```
interface loopback1
ip address 1.1.1.1/32
ip ospf 10 area 0
```

Configuration at the tail-end router R6:

```
router ospf 10
fast-reroute per-prefix enable prefix-priority low
fast-reroute per-prefix ti-lfa
segment-routing mpls
mpls traffic-eng area 0
mpls traffic-eng router-id Loopback1
interface GigabitEthernet2 //interface connecting to the router 3
ip address 100.101.2.1 255.255.255.0
ip ospf 10 area 0
ip ospf network point-to-point
negotiation auto
mpls traffic-eng tunnels

interface GigabitEthernet4 //interface connecting to the router 5
ip address 100.101.2.1 255.255.255.0
ip ospf 10 area 0
ip ospf network point-to-point
negotiation auto
mpls traffic-eng tunnels

interface loopback1
ip address 6.6.6.6/32
ip ospf 10 area 0
```

Explicit Path SR-TE Tunnel 1

Consider tunnel 1 based only on IP addresses:

```
ip explicit-path name IP_PATH1
next-address 2.2.2.2
next-address 3.3.3.3
next-address 6.6.6.6
!
interface Tunnel1
ip unnumbered Loopback1
tunnel mode mpls traffic-eng
tunnel destination 6.6.6.6
tunnel mpls traffic-eng autoroute announce
tunnel mpls traffic-eng priority 6 6
tunnel mpls traffic-eng path-option 10 explicit name IP_PATH1 segment-routing
tunnel mpls traffic-eng path-selection metric igp
tunnel mpls traffic-eng load-share 10
end
```

Explicit Path SR-TE Tunnel 2

Consider tunnel 2 based on node SIDs

```
ip explicit-path name IA_PATH
next-label 114
next-label 115
next-label 116
!
interface Tunnel2
ip unnumbered Loopback1
tunnel mode mpls traffic-eng
```

Explicit Path SR-TE Tunnel 3

```

tunnel destination 6.6.6.6
tunnel mpls traffic-eng autoroute announce
tunnel mpls traffic-eng priority 6 6
tunnel mpls traffic-eng bandwidth 10000 class-type 1
tunnel mpls traffic-eng path-option 10 explicit name NODE_PATH segment-routing
tunnel mpls traffic-eng path-selection metric igp
tunnel mpls traffic-eng load-share 10
end

```

Explicit Path SR-TE Tunnel 3

Consider that tunnel 3 is based on a mix of IP addresses and label

```

ip explicit-path name MIXED_PATH enable
next-address 2.2.2.2
next-address 3.3.3.3
next-label 115
next-label 116
!
interface Tunnel3
ip unnumbered Loopback1
tunnel mode mpls traffic-eng
tunnel destination 6.6.6.6
tunnel mpls traffic-eng autoroute announce
tunnel mpls traffic-eng priority 6 6
tunnel mpls traffic-eng path-option 10 explicit name MIXED_PATH segment-routing
tunnel mpls traffic-eng path-selection metric igp
tunnel mpls traffic-eng load-share 10

```



Note In the case of mixed path, IP next-hop cannot be used after using Node SIDs in the path. The following path will not be valid:

```

ip explicit-path name MIXED_PATH enable
next-label 115
next-label 116
next-address 2.2.2.2

```

Dynamic Path SR-TE Tunnel 4

Consider that tunnel 4 is based on adjacency SIDs

```

interface Tunnel4
ip unnumbered Loopback1
tunnel mode mpls traffic-eng
tunnel destination 6.6.6.6
tunnel mpls traffic-eng autoroute announce
tunnel mpls traffic-eng priority 6 6
tunnel mpls traffic-eng bandwidth 10000 class-type 1
tunnel mpls traffic-eng path-option 10 dynamic segment-routing
tunnel mpls traffic-eng path-selection metric igp
tunnel mpls traffic-eng load-share 10
end

```

Dynamic Path SR-TE Tunnel 5

Consider that tunnel 5 is based on Node SIDs

```

interface Tunnel5

```

```

ip unnumbered Loopback1
tunnel mode mpls traffic-eng
tunnel destination 6.6.6.6
tunnel mpls traffic-eng autoroute announce
tunnel mpls traffic-eng priority 6 6
tunnel mpls traffic-eng path-option 10 segment-routing
tunnel mpls traffic-eng path-selection metric igp
tunnel mpls traffic-eng load-share 10

```

Configuring Inter Area Tunnel

Consider the following topology to configure inter area tunnel:

Figure 13: Inter Area Tunnel

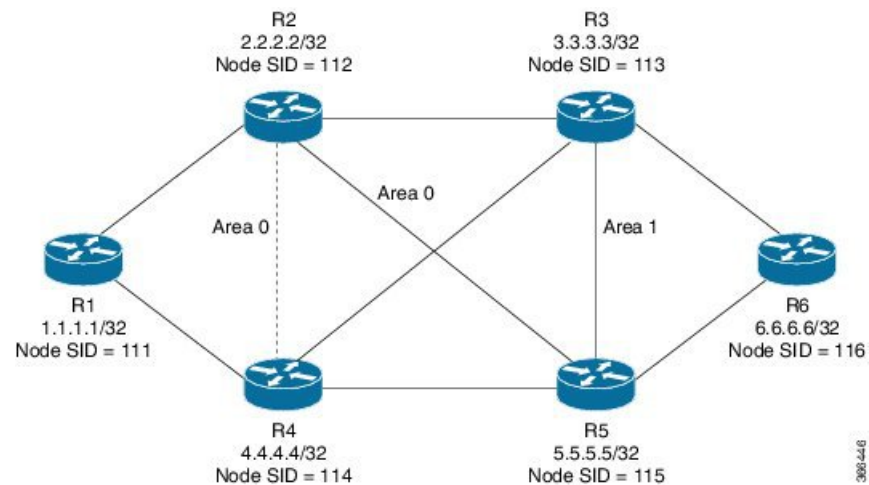

All the routers are configured in the same area, area 0 except R6 which is configured in area 1.

Configuration at the head end router R1:

```

router ospf 10
fast-reroute per-prefix enable prefix-priority low
fast-reroute per-prefix ti-lfa
segment-routing mpls
mpls traffic-eng router-id Loopback1
mpls traffic-eng area 0

interface GigabitEthernet2 //interface connecting to the router 2
ip address 100.101.1.1 255.255.255.0
ip ospf 10 area 0
ip ospf network point-to-point
negotiation auto
mpls traffic-eng tunnels

interface GigabitEthernet4 //interface connecting to the router 4
ip address 100.101.1.1 255.255.255.0
ip ospf 10 area 0
ip ospf network point-to-point
negotiation auto
mpls traffic-eng tunnels

interface loopback1
ip address 1.1.1.1/32
ip ospf 10 area 0

```

Configuration at the tail-end router R6:

```

router ospf 10
fast-reroute per-prefix enable prefix-priority low
fast-reroute per-prefix ti-lfa
segment-routing mpls
mpls traffic-eng area 1
mpls traffic-eng router-id Loopback1
interface GigabitEthernet2 //interface connecting to the router 3
ip address 100.101.2.1 255.255.255.0
ip ospf 10 area 1
ip ospf network point-to-point
negotiation auto
mpls traffic-eng tunnels

interface GigabitEthernet4 //interface connecting to the router 5
ip address 100.101.2.1 255.255.255.0
ip ospf 10 area 1
ip ospf network point-to-point
negotiation auto
mpls traffic-eng tunnels

interface loopback1
ip address 6.6.6.6/32
ip ospf 10 area 1

```

Restrictions for Configuring Inter Area Tunnel

The following are the restrictions for configuring inter area tunnel:

- The dynamic option with node and adjacency SID are not supported.
- You can configure inter are tunnel using the explicit path containing only labels and/or IP address and labels.



Note The IP address can be used only be till the Area Border Router (ABR) and after that you need to specify only the labels.

Explicit Path SR-TE Tunnel 1

Consider tunnel 2 is based on node SIDs.

```

ip explicit-path name IA_PATH
next-label 114
next-label 115
next-label 116
!
interface Tunnel2
ip unnumbered Loopback1
tunnel mode mpls traffic-eng
tunnel destination 6.6.6.6
tunnel mpls traffic-eng autoroute announce
tunnel mpls traffic-eng priority 6 6
tunnel mpls traffic-eng bandwidth 10000 class-type 1
tunnel mpls traffic-eng path-option 10 explicit name NODE_PATH segment-routing
tunnel mpls traffic-eng path-selection metric igp
tunnel mpls traffic-eng load-share 10
end

```

Explicit Path SR-TE Tunnel 2

Consider that tunnel 3 is based on a mix of IP Addresses and label.

```
ip explicit-path name MIXED_PATH enable
next-address 2.2.2.2
next-address 3.3.3.3
next-label 115
next-label 116
!

interface Tunnel3
ip unnumbered Loopback1
tunnel mode mpls traffic-eng
tunnel destination 6.6.6.6
tunnel mpls traffic-eng autoroute announce
tunnel mpls traffic-eng priority 6 6
tunnel mpls traffic-eng path-option 10 explicit name MIXED_PATH segment-routing
tunnel mpls traffic-eng path-selection metric igp
tunnel mpls traffic-eng load-share 10
```

Verifying Configuration of the SR-TE Tunnels

Use the `show mpls traffic-eng tunnels tunnel-number` command to verify the configuration of the SR-TE tunnels.

Verifying Tunnel 1

```
Name: R1_t1 (Tunnel1) Destination: 6.6.6.6
Status:
  Admin: up      Oper: up      Path: valid      Signalling: connected
  path option 10, (SEGMENT-ROUTING) type explicit IP_PATH (Basis for Setup)
Config Parameters:
  Bandwidth: 0 kbps (Global) Priority: 6 6 Affinity: 0x0/0xFFFF
  Metric Type: IGP (interface)
  Path Selection:
  Protection: any (default)
  Path-invalidation timeout: 45000 msec (default), Action: Tear
  AutoRoute: enabled LockDown: disabled Loadshare: 10 [200000000]
  auto-bw: disabled
  Fault-OAM: disabled, Wrap-Protection: disabled, Wrap-Capable: No
Active Path Option Parameters:
  State: explicit path option 10 is active
  BandwidthOverride: disabled LockDown: disabled Verbatim: disabled
History:
  Tunnel:
  Time since created: 6 days, 19 hours
  Time since path change: 2 seconds
  Number of LSP IDs (Tun_Instances) used: 1814
  Current LSP: [ID: 1814]
  Uptime: 2 seconds
  Selection: reoptimization
  Prior LSP: [ID: 1813]
  ID: path option unknown
  Removal Trigger: configuration changed
Tun_Instance: 1814
Segment-Routing Path Info (ospf 10 area 0)
  Segment0[Node]: 4.4.4.4, Label: 114
```

```
Segment1[Node]: 5.5.5.5, Label: 115
Segment2[Node]: 6.6.6.6, Label: 116
```

Verifying Tunnel 2

```
Name: R1_t2 (Tunnell) Destination: 6.6.6.6
Status:
  Admin: up      Oper: up      Path: valid      Signalling: connected
  path option 10, (SEGMENT-ROUTING) type explicit IA_PATH (Basis for Setup)
Config Parameters:
  Bandwidth: 0      kbps (Global) Priority: 6 6 Affinity: 0x0/0xFFFF
  Metric Type: IGP (interface)
  Path Selection:
    Protection: any (default)
    Path-invalidation timeout: 45000 msec (default), Action: Tear
    AutoRoute: enabled LockDown: disabled Loadshare: 10 [200000000]
    auto-bw: disabled
    Fault-OAM: disabled, Wrap-Protection: disabled, Wrap-Capable: No
Active Path Option Parameters:
  State: explicit path option 10 is active
  BandwidthOverride: disabled LockDown: disabled Verbatim: disabled
History:
  Tunnel:
    Time since created: 6 days, 19 hours, 1 minutes
    Time since path change: 1 seconds
    Number of LSP IDs (Tun_Instances) used: 1815
    Current LSP: [ID: 1815]
    Uptime: 1 seconds
    Prior LSP: [ID: 1814]
    ID: path option unknown
    Removal Trigger: configuration changed
  Tun_Instance: 1815
Segment-Routing Path Info (ospf 10 area 0)
  Segment0[ - ]: Label: 114
  Segment1[ - ]: Label: 115
  Segment2[ - ]: Label: 116
```

Verifying Tunnel 3

```
Name: R1_t3 (Tunnell) Destination: 6.6.6.6
Status:
  Admin: up      Oper: up      Path: valid      Signalling: connected
  path option 10, (SEGMENT-ROUTING) type explicit MIXED_PATH (Basis for Setup)
Config Parameters:
  Bandwidth: 0      kbps (Global) Priority: 6 6 Affinity: 0x0/0xFFFF
  Metric Type: IGP (interface)
  Path Selection:
    Protection: any (default)
    Path-invalidation timeout: 45000 msec (default), Action: Tear
    AutoRoute: enabled LockDown: disabled Loadshare: 10 [200000000]
    auto-bw: disabled
    Fault-OAM: disabled, Wrap-Protection: disabled, Wrap-Capable: No
Active Path Option Parameters:
  State: explicit path option 10 is active
  BandwidthOverride: disabled LockDown: disabled Verbatim: disabled
History:
  Tunnel:
```

```

Time since created: 6 days, 19 hours, 2 minutes
Time since path change: 2 seconds
Number of LSP IDs (Tun_Instances) used: 1816
Current LSP: [ID: 1816]
Uptime: 2 seconds
Selection: reoptimization
Prior LSP: [ID: 1815]
ID: path option unknown
Removal Trigger: configuration changed
Tun_Instance: 1816
Segment-Routing Path Info (ospf 10 area 0)
Segment0[Node]: 2.2.2.2, Label: 112
Segment1[Node]: 3.3.3.3, Label: 113
Segment2[ - ]: Label: 115
Segment3[ - ]: Label: 116

```

Verifying Tunnel 4

```

Name: R1_t4 (Tunnell) Destination: 6.6.6.6
Status:
Admin: up Oper: up Path: valid Signalling: connected
path option 10, (SEGMENT-ROUTING) type dynamic (Basis for Setup, path weight 30)
Config Parameters:
Bandwidth: 0 kbps (Global) Priority: 6 6 Affinity: 0x0/0xFFFF
Metric Type: IGP (interface)
Path Selection:
Protection: any (default)
Path-invalidation timeout: 45000 msec (default), Action: Tear
AutoRoute: enabled LockDown: disabled Loadshare: 10 [200000000]
auto-bw: disabled
Fault-OAM: disabled, Wrap-Protection: disabled, Wrap-Capable: No
Active Path Option Parameters:
State: dynamic path option 10 is active
BandwidthOverride: disabled LockDown: disabled Verbatim: disabled
History:
Tunnel:
Time since created: 6 days, 19 hours
Time since path change: 2 seconds
Number of LSP IDs (Tun_Instances) used: 1813
Current LSP: [ID: 1813]
Uptime: 2 seconds
Prior LSP: [ID: 1806]
ID: path option unknown
Removal Trigger: configuration changed
Tun_Instance: 1813
Segment-Routing Path Info (ospf 10 area 0)
Segment0[Link]: 192.168.2.1 - 192.168.2.2, Label: 17
Segment1[Link]: 192.168.4.2 - 192.168.4.1, Label: 25
Segment2[Link]: 192.168.8.1 - 192.168.8.2, Label: 300

```

Verifying Tunnel 5

```

Name: R1_t5 (Tunnell) Destination: 6.6.6.6
Status:
Admin: up Oper: up Path: valid Signalling: connected
path option 10, type segment-routing (Basis for Setup)
Config Parameters:
Bandwidth: 0 kbps (Global) Priority: 6 6 Affinity: 0x0/0xFFFF
Metric Type: IGP (interface)

```

```

Path Selection:
  Protection: any (default)
  Path-invalidation timeout: 45000 msec (default), Action: Tear
  AutoRoute: enabled LockDown: disabled Loadshare: 10 [200000000]
  auto-bw: disabled
  Fault-OAM: disabled, Wrap-Protection: disabled, Wrap-Capable: No
Active Path Option Parameters:
  State: segment-routing path option 10 is active
  BandwidthOverride: disabled LockDown: disabled Verbatim: disabled
History:
  Tunnel:
    Time since created: 6 days, 19 hours, 4 minutes
    Time since path change: 14 seconds
    Number of LSP IDs (Tun_Instances) used: 1817
  Current LSP: [ID: 1817]
    Uptime: 14 seconds
    Selection: reoptimization
  Prior LSP: [ID: 1816]
    ID: path option unknown
    Removal Trigger: configuration changed
Tun_Instance: 1817
Segment-Routing Path Info (ospf 10 area 0)
  Segment0[Node]: 6.6.6.6, Label: 116

```

Additional References for Segment Routing Traffic Engineering With OSPF

Related Documents

Related Topic	Document Title
Cisco IOS commands	Cisco IOS Master Commands List, All Releases

Feature Information for Segment Routing Traffic Engineering With OSPF

The following table provides release information about the feature or features described in this module. This table lists only the software release that introduced support for a given feature in a given software release train. Unless noted otherwise, subsequent releases of that software release train also support that feature.

Use Cisco Feature Navigator to find information about platform support and Cisco software image support. To access Cisco Feature Navigator, go to www.cisco.com/go/cfn. An account on Cisco.com is not required.

Table 7: Feature Information for Segment Routing Traffic Engineering With OSPF

Feature Name	Releases	Feature Information
Segment Routing Traffic Engineering With OSPF	Cisco IOS XE Release 3.17S Cisco IOS XE Fuji 16.7.1	<p>A Traffic Engineered (TE) tunnel is a container of TE LSP(s) instantiated between the tunnel ingress and the tunnel destination. A TE tunnel may instantiate one or more SR-TE LSP(s) that are associated with the same tunnel.</p> <p>The following commands were added or modified:</p> <p>show mpls traffic-eng tunnels, tunnel mpls traffic-eng path-option 10 dynamic segment-routing, tunnel mpls traffic-eng path-option 10 segment-routing, tunnel mpls traffic-eng path-option 10 explicit name MIXED_PATH segment-routing, tunnel mpls traffic-eng path-option 10 explicit name IP_PATH1 segment-routing, tunnel mpls traffic-eng path-option 10 explicit name NODE_PATH segment-routing.</p> <p>In Cisco IOS XE Fuji 16.7.1, this feature is supported on Cisco 4000 Series Integrated Service Routers.</p>



CHAPTER 9

BGP Dynamic Segment Routing Traffic Engineering

Border Gateway Protocol (BGP) has become a popular choice as a routing protocol in Data Center (DC) network. The ability to setup Segment Routing-Traffic Engineering (SR-TE) path initiated by BGP simplifies DC network operation.

- [Restrictions for Segment Routing –Traffic-Engineering Dynamic BGP, on page 109](#)
- [Information About Segment Routing –Traffic-Engineering Dynamic BGP, on page 109](#)
- [How to Configure TE Label Switched Path Attribute-Set, on page 111](#)
- [Additional References for BGP Dynamic Segment Routing Traffic Engineering, on page 112](#)
- [Feature Information for BGP Dynamic Segment Routing Traffic Engineering, on page 112](#)

Restrictions for Segment Routing –Traffic-Engineering Dynamic BGP

- For Anycast SID support to work BGP-TE should be configured with the prepend feature.
- In the case of BGP Dynamic SR-TE if SR-TE fails, forwarding gets broken.

Information About Segment Routing –Traffic-Engineering Dynamic BGP

In BGP dynamic SR-TE, the label Switched Path (LSP) is enabled on demand when defined criteria and policies are met and that is the key difference between manually enabled SR-TE and BGP dynamic SR-TE. Policies, for example, low latency path, minimum cost path, and so on are carried via BGP and matches on a given customer prefix. SR-TE tunnel used for L3VPN or Virtual Private LAN Services (VPLS) using BGP for auto-discovery and signaling is referred to as BGP-TE Dynamic.

BGP SR-TE dynamic assumes the on-demand auto-tunnel resides in single IGP domain. In this case path computation is done via IGP. SR-TE auto-tunnel created based on the request from BGP is a dynamic SR-TE tunnel. In other words, tunnel path information, or label stack, is computed based on the BGP next-hop and TE attribute configuration. BGP dynamic SR-TE functions to trigger an On-demand LSP (auto-tunnel). The functions include:

- Tag customer prefixes (IPv4 or L3VPN VRF) using communities (community list) via route map configuration.
- Associate each community with a TE attribute-set or profile.

SR-TE profile is locally configured in attribute-set to define certain SR-TE parameters, for example, latency, disjoint path and so on. Once the BGP customer prefixes are mapped to an SR-TE-profile, a tunnel is dynamically created (auto-tunnel or On demand Label Switched Path (LSP)) using the parameters defined in the attribute-set, for each specified BGP next-hop and attribute-set pair associated with the prefixes. A binding SID is associated with each SR-TE auto-tunnel and passed to BGP. The binding SID or binding label is installed into Routing Information Base (RIB) and Forwarding Information Base (FIB). FIB resolves BGP path via the binding SID or binding label, which forwards over the On demand SR-TE auto-tunnel. The binding-SID is also used to steer the customer traffic over the SR-TE LSP.

It must be noted that BGP only carries the SR-TE policy in this case, while path computation is done via IGP in a single IGP domain. In a single IGP domain the headend node has full visibility of the end to end path and the topology engineering database (Traffic Engineering Database or TED). Also it is assumed with BGP Dynamic SR-TE that all the nodes reside within single AS and single IGP domain.

Figure 14: BGP-TE Dynamic Workflow

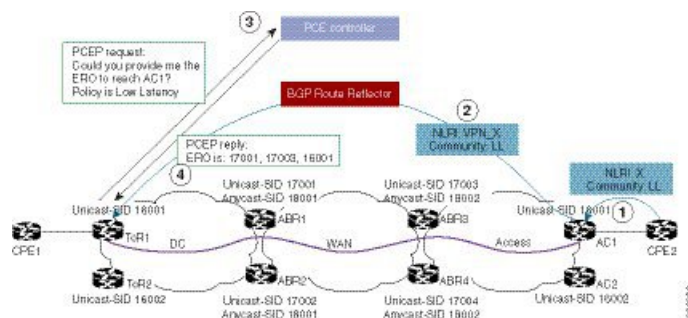

The above figure depicts the workflow for BGP-TE dynamic using multiple routing domains use case:

1. Customer premise equipment 2 (CPE) sends BGP update for Prefix-X and adds LL community, for example, 100:333.
2. AC1 announces a VPN route for prefix X with LL community.
3. After receiving BGP update of the VPN route matching community LL, ToR1 sends a request to PCE controller for LSP path towards AC1 with low latency TE policy.
4. Path calculation element (PCE) controller replies with a label stack, for example, 17003, 1600.
5. ToR1 creates SR-TE auto-tunnel and installs the route for Prefix-X in VRF of this VPN.

TE Label Switched Path Attribute-Set

TE-LSP attribute-set is used to configure the properties of a LSP. It describes TE profile or policy such as bandwidth, affinities inclusion and exclusion, links/nodes/SRLG inclusion and exclusion, metrics, path disjoint degree and group, and so on that are used to create an auto-tunnel.

How to Configure TE Label Switched Path Attribute-Set

Configuring TE Label Switched Path Attribute-Set

You can use the command **mpls traffic-eng lsp attribute** *<name>* to configure TE-LSP attribute. The following options are available:

```
Mpls traffic-eng lsp attribute name
  affinity          Specify attribute flags for links comprising LSP
  lockdown         Lockdown the LSP--disable reoptimization
  priority         Specify LSP priority
```

TE-LSP attribute command can be extended to support configuration for the two options **pce** and **path-selection**. It can be configured as following:

```
mpls traffic-eng lsp attribute name <test>
  path-selection
    metric <te/igp>
    invalidation <time-out> <drop/tear>
    segment-routing adjacency <protected/unprotected>
```

- If **pce** option is set in the TE attribute the dynamic path is calculated by PCE. Otherwise, the path is calculated locally by TE PCALC (path-calculation) entity. In the later case, IGP has to be configured and the BGP next-hop has to be both advertised by IGP and reachable from the local node over an IGP route.
- The option **path-selection metric** indicates whether the path calculation is based on TE metrics or IGP metrics. If this option is not configured the global value configured under **mpls traffic-eng path-selection metric** is used.
- The option **path-selection invalidation** configures the behavior of how an LSP reacts to soft failure from network. When an LSP path has a protected path from IGP against a link or node failure, the failure to the link or node is considered as soft failure.
- The option **path-selection segment-routing adjacency** indicates whether to choose an adjacency-SID with or without IGP protection when calculating LSP label stack.
- The option **pce disjoint-path** indicates the tunnel LSP is a member of disjoint-path group. Any LSPs within the same disjoint-path group do not traverse the same resources, such as links, nodes, or SRLG, in its path. This is used to create two or more tunnel LSPs with disjoint paths.

For BGP-TE Dynamic, a TE attribute name is associated with a BGP route-map set extension as following:

```
route-map <name>
  match community <name>
  set attribute-set <name>
```

BGP uses the **attribute-set** *<name>* string together with its BGP next-hop to request a SR-TE auto-tunnel.

Additional References for BGP Dynamic Segment Routing Traffic Engineering

Related Documents

Related Topic	Document Title
Cisco IOS Commands	Cisco IOS Master Command List, All Releases

Feature Information for BGP Dynamic Segment Routing Traffic Engineering

The following table provides release information about the feature or features described in this module. This table lists only the software release that introduced support for a given feature in a given software release train. Unless noted otherwise, subsequent releases of that software release train also support that feature.

Use Cisco Feature Navigator to find information about platform support and Cisco software image support. To access Cisco Feature Navigator, go to www.cisco.com/go/cfn. An account on Cisco.com is not required.

Table 8: Feature Information for BGP Dynamic Segment Routing Traffic Engineering

Feature Name	Releases	Feature Information
BGP Dynamic Segment Routing Traffic Engineering	Cisco IOS XE Everest 16.5.1b	In BGP dynamic SR-TE, the label Switched Path (LSP) is enabled on demand when defined criteria and policies are met. The following commands were introduced or modified: mpls traffic-eng lsp attribute <i>name</i>



CHAPTER 10

Segment Routing On Demand Next Hop for L3/L3VPN

When redistributing routing information across domains, provisioning of multi-domain services (L2VPN & L3VPN) has its own complexity and scalability issues. On Demand Next Hop (ODN) triggers delegation of computation of an end-to-end LSP to a PCE controller including constraints and policies without doing any redistribution. It then installs the replied multi-domain LSP for the duration of the service into the local forwarding information base (FIB).

- [Restrictions for Segment Routing On Demand Next Hop for L3/L3VPN, on page 113](#)
- [Information About Segment Routing On Demand Next Hop for L3/L3VPN, on page 114](#)
- [How to Configure Segment Routing On Demand Next Hop for L3/L3VPN, on page 114](#)
- [Verifying Segment Routing On Demand Next Hop for L3/L3VPN, on page 118](#)
- [Additional References for Segment Routing On Demand Next Hop for L3/L3VPN, on page 122](#)
- [Feature Information for Segment Routing On Demand Next Hop for L3/L3VPN, on page 122](#)

Restrictions for Segment Routing On Demand Next Hop for L3/L3VPN

- On Demand Next Hop (ODN) anycast SID is not supported.
- ODN for IPv6 is not supported.
- SR ODN tunnel is not supported with BGP Nonstop Routing (NSR). It is only supported with BGP Nonstop Forwarding (NSF).

To enable BGP NSF, use the following command:

```
bgp grace-full restart
neighbor 10.0.0.2 ha-mode graceful-restart
```

Information About Segment Routing On Demand Next Hop for L3/L3VPN

On Demand Next hop leverages upon BGP Dynamic SR-TE capabilities and adds the path computation (PCE) ability to find and download the end to end path based on the requirements. ODN triggers an SR-TE auto-tunnel based on the defined BGP policy. As shown in the below figure, an end to end path between ToR1 and AC1 can be established from both ends based on low latency or other criteria for VRF (L3VPN) or IPv4 services. The work-flow for ODN is summarized as follows:

Figure 15: ODN Operation

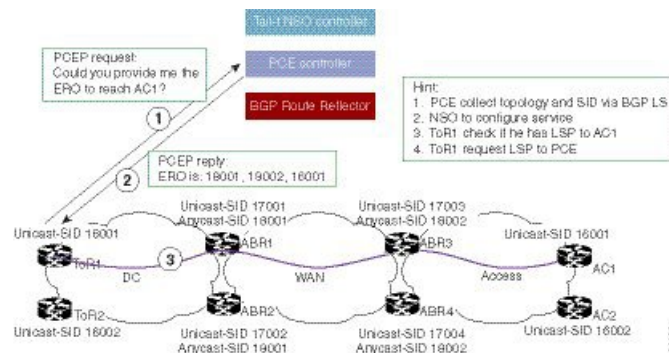

1. PCE controller collects topology and SIDs information via BGP Link State (BGP-LS). For more information on BGP-LS, refer [BGP Link-State](#).
2. If NSO controller is enable, it configures L3VPN VRF or IPv4 prefixes and requests are sent to ToR1 and AC1.
3. ToR1 and AC1 checks if a LSP towards each other exists. If not, a request is sent to the PCE controller to compute that SR-TE path that matches SR-TE policy that is carried via BGP.
4. PCE controller computes the path and replies with a label stack (18001, 18002, 16001, example in ToR1).
5. ToR1 and AC1 create a SR-TE auto-tunnel and reply back to the NSO controller indicating that the LSP for VRF or IPv4 is up and operational.

How to Configure Segment Routing On Demand Next Hop for L3/L3VPN

Configuring Segment Routing On Demand Next Hop for L3/L3VPN

Perform the following steps to configure on-demand next hop for SR-TE. The below figure is used as a reference to explain the configuration steps.

Figure 16: ODN Auto-Tunnel Setup

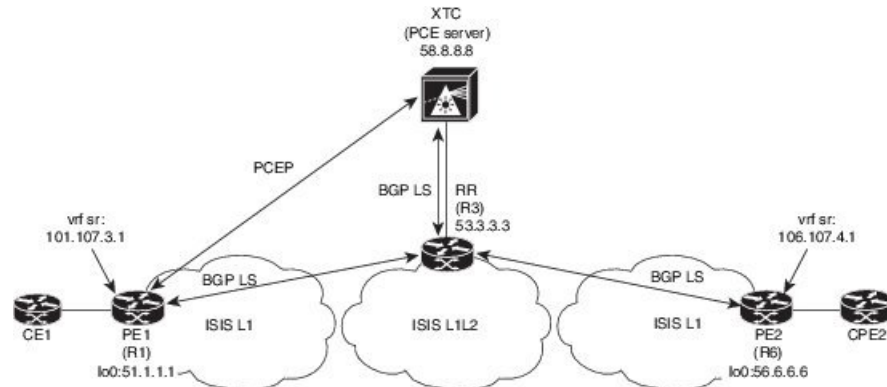

1. Configure the router (R6 tail end) with VRF interface.

```
interface GigabitEthernet0/2/2
vrf forwarding sr
ip address 10.0.0.1 255.0.0.0
negotiation auto

interface Loopback0
ip address 192.168.0.1 255.255.0.0
ip router isis 1
```

2. Tags VRF prefix with BGP community on R6 (tail end).

```
route-map BGP_TE_MAP permit 9
match ip address traffic
set community 3276850

ip access-list extended traffic
permit ip 10.0.0.1 255.255.0.0 any
```

3. Enable BGP on R6 (tail end) and R1 (head end) to advertise and receive VRF SR prefix and match on community set on R6 (tail end).

```
router bgp 100
bgp router-id 172.16.0.1
bgp log-neighbor-changes
bgp graceful-restart
no bgp default ipv4-unicast
neighbor 10.0.0.2 remote-as 100
neighbor 10.0.0.2 update-source Loopback0

address-family ipv4
neighbor 10.0.0.2 activate
neighbor 10.0.0.2 send-community both
neighbor 10.0.0.2 next-hop-self
exit-address-family

address-family vpv4
neighbor 10.0.0.2 activate
neighbor 10.0.0.2 send-community both
neighbor 10.0.0.2 route-map BGP_TE_MAP out
exit-address-family
```

```

address-family link-state link-state
  neighbor 10.0.0.2 activate
exit-address-family

address-family ipv4 vrf sr
  redistribute connected
exit-address-family

route-map BGP_TE_MAP permit 9
  match ip address traffic
  set community 3276850

ip access-list extended traffic
  permit ip 10.0.0.1 255.255.0.0 any

router bgp 100
  bgp router-id 192.168.0.2
  bgp log-neighbor-changes
  bgp graceful-restart
  no bgp default ipv4-unicast
  neighbor 10.0.0.2 remote-as 100
  neighbor 10.0.0.2 update-source Loopback0

address-family ipv4
  neighbor 10.0.0.2 activate
  neighbor 10.0.0.2 send-community both
  neighbor 10.0.0.2 next-hop-self
exit-address-family

address-family vpnv4
  neighbor 10.0.0.2 activate
  neighbor 10.0.0.2 send-community both
  neighbor 10.0.0.2 route-map BGP_TE_MAP in
exit-address-family

address-family link-state link-state
  neighbor 10.0.0.2 activate
exit-address-family

address-family ipv4 vrf sr
  redistribute connected
exit-address-family

route-map BGP_TE_MAP permit 9
  match community 1
  set attribute-set BGP_TE5555

ip community-list 1 permit 3276850

mpls traffic-eng lsp attributes BGP_TE5555
  path-selection metric igp
  pce

```

4. Enable route-map/attribute set on headend (R1).

```

route-map BGP_TE_MAP permit 9
  match community 1
  set attribute-set BGP_TE5555

ip community-list 1 permit 3276850

mpls traffic-eng lsp attributes BGP_TE5555

```

```

path-selection metric igp
pce

end

```

5. Enable PCE and auto-tunnel configurations on R1.

```

mpls traffic-eng tunnels
mpls traffic-eng pcc peer 10.0.0.3 source 10.0.0.4 precedence 255
mpls traffic-eng auto-tunnel p2p tunnel-num min 2000 max 5000

```

6. Enable all core links with SR-TE configurations and ensure that they are enabled as point to point interfaces.

```

mpls traffic-eng tunnels

interface GigabitEthernet0/2/0
ip address 101.102.6.1 255.255.255.0
ip router isis 1
mpls traffic-eng tunnels
isis network point-to-point

interface GigabitEthernet0/3/1
vrf forwarding sr
ip address 101.107.3.1 255.255.255.0
negotiation auto

end

```

7. Enable R3 (RR) to advertise TED to the PCE server via BGP-LS.

```

router isis 1
net 49.0002.0000.0000.0003.00
ispf level-1-2
metric-style wide
nsf cisco
nsf interval 0
distribute link-state
segment-routing mpls
segment-routing prefix-sid-map advertise-local
redistribute static ip level-1-2
mpls traffic-eng router-id Loopback0
mpls traffic-eng level-1
mpls traffic-eng level-2

router bgp 100
bgp router-id 10.0.0.2
bgp log-neighbor-changes
bgp graceful-restart
no bgp default ipv4-unicast
neighbor 10.0.0.3 remote-as 100
neighbor 10.0.0.3 update-source Loopback0

address-family ipv4
neighbor 10.0.0.3 activate
exit-address-family

```

8. Enable PCE server configuration and verify BGP-LS session is properly established with RR.

```

Device# sh bgp li li summary
BGP router identifier 10.0.0.3, local AS number 100
BGP generic scan interval 60 secs
Non-stop routing is enabled
BGP table state: Active
Table ID: 0x0 RD version: 1436

```

```

BGP main routing table version 1436
BGP NSR Initial initsync version 1 (Reached)
BGP NSR/ISSU Sync-Group versions 0/0
BGP scan interval 60 secs
BGP is operating in STANDALONE mode.
Process          RcvTblVer    bRIB/RIB    LabelVer    ImportVer    SendTblVer    StandbyVer
Speaker          1436        1436        1436        1436        1436        1436
0

Neighbor         Spk         AS MsgRcvd   MsgSent     TblVer     InQ   OutQ   Up/Down   St/PfxRcd
10.0.0.2         0           100  19923      17437      1436     0     0
1w2d            103

Device# sh pce ipv4 topo | b Node 3
Node 3
  TE router ID: 10.0.0.2
  Host name: R3
  ISIS system ID: 0000.0000.0003 level-1

  ISIS system ID: 0000.0000.0003 level-2
  Prefix SID:
    Prefix 10.0.0.2, label 20011 (regular)

```

Verifying Segment Routing On Demand Next Hop for L3/L3VPN

The ODN verifications are based on L3VPN VRF prefixes.

1. Verify that PCEP session between R1 (headend and PCE server) is established.

```

Device# sh pce client peer
PCC's peer database:
-----
Peer address: 10.0.0.3 (best PCE)
  State up
  Capabilities: Stateful, Update, Segment-Routing

```

2. Verify that PCEP session is established between all the peers (PCCs).

```

Device# sh pce ipv4 peer
PCE's peer database:
-----
Peer address: 10.0.0.4
  State: Up
  Capabilities: Stateful, Segment-Routing, Update
Peer address: 172.16.0.5
  State: Up
  Capabilities: Stateful, Segment-Routing, Update

```

3. Verify that R1 (headend) has no visibility to R6 loopback address.

```

Device# sh ip route 192.168.0.1
% Network not in table

```

4. Verify that VRF prefix is injected via MP-BGP in R1 VRF SR routing table.

```

Device# sh ip route vrf sr
Routing Table: sr
Codes: L - local, C - connected, S - static, R - RIP, M - mobile, B - BGP
       D - EIGRP, EX - EIGRP external, O - OSPF, IA - OSPF inter area
       N1 - OSPF NSSA external type 1, N2 - OSPF NSSA external type 2
       E1 - OSPF external type 1, E2 - OSPF external type 2
       i - IS-IS, su - IS-IS summary, L1 - IS-IS level-1, L2 - IS-IS level-2
       ia - IS-IS inter area, * - candidate default, U - per-user static route

```

```

o - ODR, P - periodic downloaded static route, H - NHRP, l - LISP
a - application route
+ - replicated route, % - next hop override, p - overrides from PFR
Gateway of last resort is not set
  10.0.0.6/8 is variably subnetted, 2 subnets, 2 masks
C    10.0.0.7/24 is directly connected, GigabitEthernet0/3/1
L    10.0.0.7/32 is directly connected, GigabitEthernet0/3/1
    10.0.0.8/24 is subnetted, 1 subnets
B    10.0.0.9 [200/0] via binding label: 865, 4d21h

```

5. Verify that BGP is associating properly the policy and binding SID with the VRF prefix.

```

Device# sh ip bgp vpv4 vrf sr 106.107.4.0
BGP routing table entry for 100:100:106.107.4.0/24, version 3011
Paths: (1 available, best #1, table sr)
  Not advertised to any peer
  Refresh Epoch 4
  Local
    192.168.0.1 (metric 10) (via default) from 10.0.0.2 (10.0.0.2)
      Origin incomplete, metric 0, localpref 100, valid, internal, best
      Community: 3276850
      Extended Community: RT:100:100
      Originator: 192.168.0.1, Cluster list: 10.0.0.2
      mpls labels in/out nlabel/1085
      binding SID: 865 (BGP_TE5555)
      rx pathid: 0, tx pathid: 0x0

```

6. Verify binding label association with VRF prefix.

```

Device# sh ip route vrf sr 106.107.4.0
Routing Table: sr
Routing entry for 106.107.4.0/24
  Known via "bgp 100", distance 200, metric 0, type internal
  Routing Descriptor Blocks:
    * Binding Label: 865, from 10.0.0.2, 4d22h ago
      Route metric is 0, traffic share count is 1
      AS Hops 0
      MPLS label: 1085
      MPLS Flags: NSF

```

7. Verify that VRF prefix is forwarded via ODN auto-tunnel.

```

Device# sh ip cef label-table
Label          Next Hop          Interface
0              no route
865           attached          Tunnel2000

Device# sh ip cef vrf sr 106.107.4.0 detail
10.0.0.8/24, epoch 15, flags [rib defined all labels]
  recursive via 865 label 1085
  attached to Tunnel2000

```

8. Verify ODN auto-tunnel status.

```

Device# sh mpls traffic-eng tunnels
P2P TUNNELS/LSPs:
Name: R1_t2000 (Tunnel2000) Destination: 192.168.0.1 Ifhandle: 0x6F5
(auto-tunnel for BGP TE)
Status:
  Admin: up      Oper: up      Path: valid      Signalling: connected---□
auto-tunnel 2000
  path option 1, (SEGMENT-ROUTING) (PCE) type dynamic (Basis for Setup, path weight 10)
Config Parameters:
  Bandwidth: 0 kbps (Global) Priority: 7 7 Affinity: 0x0/0xFFFF
  Metric Type: IGP (interface)

```

```

Path Selection:
  Protection: any (default)
Path-selection Tiebreaker:
  Global: not set   Tunnel Specific: not set   Effective: min-fill (default)
Hop Limit: disabled
Cost Limit: disabled
Path-invalidation timeout: 10000 msec (default), Action: Tear
AutoRoute: disabled LockDown: disabled Loadshare: 0 [0] bw-based
auto-bw: disabled
Attribute-set: BGP_TE5555--- attribute-set
Fault-OAM: disabled, Wrap-Protection: disabled, Wrap-Capable: No
Active Path Option Parameters:
  State: dynamic path option 1 is active
  BandwidthOverride: disabled LockDown: disabled Verbatim: disabled
PCEP Info:
  Delegation state: Working: yes   Protect: no
Working Path Info:
  Request status: processed
  Created via PCRep message from PCE server: 10.0.0.3-- via PCE server
  PCE metric: 30, type: IGP
Reported paths:
  Tunnel Name: Tunnel2000_w
  LSPs:
  LSP[0]:
    source 10.0.0.4, destination 192.168.0.1, tunnel ID 2000, LSP ID 1
    State: Admin up, Operation active
    Binding SID: 865
    Setup type: SR
    Bandwidth: requested 0, used 0
    LSP object:
      PLSP-ID 0x807D0, flags: D:0 S:0 R:0 A:1 O:2
    Metric type: IGP, Accumulated Metric 0
    ERO:
      SID[0]: Adj, Label 2377, NAI: local 101.102.6.1 remote 10.0.0.10
      SID[1]: Unspecified, Label 17, NAI: n/a
      SID[2]: Unspecified, Label 20, NAI: n/a
History:
  Tunnel:
    Time since created: 4 days, 22 hours, 21 minutes
    Time since path change: 4 days, 22 hours, 21 minutes
    Number of LSP IDs (Tun_Instances) used: 1
    Current LSP: [ID: 1]
    Uptime: 4 days, 22 hours, 21 minutes
  Tun_Instance: 1
  Segment-Routing Path Info (isis level-1)
    Segment0[Link]: 101.102.6.1 - 10.0.0.10, Label: 2377
    Segment1[ - ]: Label: 17
    Segment2[ - ]: Label: 20

```

9. Verify ODN auto-tunnel LSP status on R1 (headend).

```

Device# sh pce client lsp brief
PCC's tunnel database:
-----
Tunnel Name: Tunnel2000_w
  LSP ID 1
Tunnel Name: Tunnel2000_p

R1# sh pce client lsp detail
PCC's tunnel database:
-----
Tunnel Name: Tunnel2000_w
LSPs:
LSP[0]:
  source 10.0.0.4, destination 192.168.0.1, tunnel ID 2000, LSP ID 1

```

```

State: Admin up, Operation active
Binding SID: 865
Setup type: SR
Bandwidth: requested 0, used 0
LSP object:
  PLSP-ID 0x807D0, flags: D:0 S:0 R:0 A:1 O:2
Metric type: IGP, Accumulated Metric 0
ERO:
SID[0]: Adj, Label 2377, NAI: local 101.102.6.1 remote 10.0.0.10
SID[1]: Unspecified, Label 17, NAI: n/a
SID[2]: Unspecified, Label 20, NAI: n/a

```

10. Verify ODN LSP status on the PCE server.

```

Device# sh pce lsp summ

PCE's LSP database summary:
-----
All peers:
Number of LSPs:          1
Operational: Up:         1 Down:          0
Admin state: Up:         1 Down:          0
Setup type: RSVP:        0 Segment routing: 1

Peer 10.0.0.4:
Number of LSPs:          1
Operational: Up:         1 Down:          0
Admin state: Up:         1 Down:          0
Setup type: RSVP:        0 Segment routing: 1

```

11. Verify detailed LSP information on the PCE server.

```

Device# sh pce lsp det
PCE's tunnel database:
-----
PCC 10.0.0.4:
Tunnel Name: Tunnel2000_w
LSPs:
LSP[0]:
source 10.0.0.4, destination 192.168.0.1, tunnel ID 2000, LSP ID 48
State: Admin up, Operation active
Binding SID: 872
PCEP information:
  plsp-id 526288, flags: D:1 S:0 R:0 A:1 O:2
Reported path:
Metric type: IGP, Accumulated Metric 0
  SID[0]: Adj, Label 885, Address: local 10.0.0.9 remote 10.0.0.10
  SID[1]: Unknown, Label 17,
  SID[2]: Unknown, Label 20,
Computed path:
Computed Time: Tue Dec 20 13:12:57 2016 (00:11:53 ago)
Metric type: IGP, Accumulated Metric 30
  SID[0]: Adj, Label 885, Address: local 10.0.0.9 remote 10.0.0.10
  SID[1]: Adj, Label 17, Address: local 10.0.0.12 remote 10.0.0.13
  SID[2]: Adj, Label 20, Address: local 10.0.0.14 remote 10.0.0.14
Recorded path:
None

```

12. Shutdown the interface that is connected to VRF SR so that the prefix is no longer advertised by MP-BGP.

```

Device# int gig0/2/2
Device(config-if)#shut

```

13. Verify that VRF prefix is no longer advertised to R1 (headend) via R6 (tailend).

```

Device# sh ip route vrf sr
Routing Table: sr
Codes: L - local, C - connected, S - static, R - RIP, M - mobile, B - BGP
       D - EIGRP, EX - EIGRP external, O - OSPF, IA - OSPF inter area
       N1 - OSPF NSSA external type 1, N2 - OSPF NSSA external type 2
       E1 - OSPF external type 1, E2 - OSPF external type 2
       i - IS-IS, su - IS-IS summary, L1 - IS-IS level-1, L2 - IS-IS level-2
       ia - IS-IS inter area, * - candidate default, U - per-user static route
       o - ODR, P - periodic downloaded static route, H - NHRP, l - LISP
       a - application route
       + - replicated route, % - next hop override, p - overrides from PfR
Gateway of last resort is not set
  10.0.0.6/8 is variably subnetted, 2 subnets, 2 masks
C       10.0.0.7/24 is directly connected, GigabitEthernet0/3/1
L       10.0.0.8/32 is directly connected, GigabitEthernet0/3/1

```

14. Verify that no ODN auto-tunnel exists.

```

Device# sh mpls traffic-eng tunnels
P2P TUNNELS/LSPs:
P2MP TUNNELS:
P2MP SUB-LSPS:

```

Additional References for Segment Routing On Demand Next Hop for L3/L3VPN

Related Documents

Related Topic	Document Title
Cisco IOS Commands	Cisco IOS Master Command List, All Releases

Feature Information for Segment Routing On Demand Next Hop for L3/L3VPN

The following table provides release information about the feature or features described in this module. This table lists only the software release that introduced support for a given feature in a given software release train. Unless noted otherwise, subsequent releases of that software release train also support that feature.

Use Cisco Feature Navigator to find information about platform support and Cisco software image support. To access Cisco Feature Navigator, go to www.cisco.com/go/cfn. An account on Cisco.com is not required.

Table 9: Feature Information for Segment Routing On Demand Next Hop for L3/L3VPN

Feature Name	Releases	Feature Information
Segment Routing On Demand Next Hop for L3/L3VPN	Cisco IOS XE Everest 16.5.1b	<p>On-Demand Next Hop (ODN) triggers delegation of computation of an end-to-end LSP to a PCE controller including constraints and policies without doing any redistribution.</p> <p>The following commands were introduced or modified:</p> <p>route-map BGP_TE_MAP permit, mpls traffic-eng tunnels, sh bgp li li summary, sh pce client peer, sh pce ipv4 peer, sh ip route vrf sr, sh ip bgp vpnv4 vrf sr, sh ip cef label-table, sh mpls traffic-eng tunnels, sh pce client lsp brief, sh pce lsp summ, sh pce lsp det, routing-default-optimize</p>



CHAPTER 11

Segment Routing On Demand for L2VPN/VPWS

On-Demand Next Hop (ODN) for Layer 2 Virtual Private Network (L2VPN) creates a segment routing (SR) traffic-engineering (TE) auto-tunnel and uses the auto-tunnel for pseudowire dataplane.

- [Restrictions for Segment Routing On Demand Next Hop for L2VPN/VPWS, on page 125](#)
- [Information About Segment Routing On Demand Next Hop for L2VPN/VPWS, on page 126](#)
- [How to Configure Segment Routing On Demand Next Hop for L2VPN/VPWS, on page 126](#)
- [Configuring Segment Routing On Demand Next Hop for L2VPN/VPWS With Prepend Option, on page 128](#)
- [Configuring Preferred Path for Segment Routing On Demand Next Hop for L2VPN/VPWS, on page 129](#)
- [Configuring Autoroute Destination for Segment Routing On Demand Next Hop for L2VPN/VPWS, on page 129](#)
- [Verifying Segment Routing On Demand Next Hop for L2VPN/VPWS, on page 130](#)
- [Additional References for Segment Routing On Demand Next Hop for L2VPN/VPWS, on page 133](#)
- [Feature Information for Segment Routing On Demand Next Hop for L2VPN/VPWS, on page 133](#)

Restrictions for Segment Routing On Demand Next Hop for L2VPN/VPWS

- Layer-2 VPN/VPWS (Virtual Private Wire Service) On Demand Next Hop (ODN) is not supported with pseudowire (PW) class.
- The segment routing on demand for L2VPN or VPWS is not supported for BGP signaled/ADVPWS or Virtual Private LAN Service (VPLS).
- Only Segment-Routing TE tunnels are supported and created for L2VPN using attribute-set.
- L2VPN preferred path bandwidth related configuration does not take effect when TE attribute-set is configured.
- Only L2-VPN ODN VPWS with LDP signaling is supported.

Information About Segment Routing On Demand Next Hop for L2VPN/VPWS

On Demand Next Hop (ODN) for L2VPN creates an SR TE auto-tunnel and uses the auto-tunnel for pseudowire dataplane. The peer IP address is the destination of tunnel and TE LSP attribute determines path of the tunnel. Sometimes a pseudowire connection may need to span multiple interior gateway protocol (IGP) areas while LDP is used as signaling protocol. The pseudowire endpoint provider edge's (PE) loopback addresses are not distributed across IGP area boundaries. In this case, one PE may not have a default route (or an exact match route) in its RIB to reach the peer PE of the pseudowire connection. Thus the pseudowire connection can not be signaled by LDP. A new option **autoroute destination** is introduced under LSP attribute to address this problem. When a LSP attribute is configured using the **autoroute destination** command, auto-tunnel uses the LSP attribute to automatically create a static route for the tunnel destination with the auto-tunnel interface as the next hop. This static route enables LDP to establish a LDP a session and exchange label mapping messages between two pseudowire endpoints.



Note Use the autoroute destination command only to configure LSP attribute used by LDP signaled L2VPN. It is not needed for BGP signaled Layer-3 VPN ODN.

AToM Manager

Any Transport over MPLS (AToM) manager maintains a database of auto-tunnels on a pair of attribute set and peer ip addresses, the AToM manager can add or delete an SR TE auto-tunnel for a pseudowire interface (VC).

Any VC that is configured with the same attribute-set or peer uses the same auto-tunnel. An auto-tunnel can be removed from the database using TE service if an attribute set or peer pair is no longer used by any pseudowire interfaces.

Inter-Area L2VPN ODN

When LDP is used as a signaling protocol and pseudowire connection is spanned across multiple Interior Gateway Protocols (IGPs), the pseudowire endpoint PE's loopback addresses are not distributed across IGP area boundaries. In this case, one PE may not have a default route (or an exact match route) in its RIB to reach the peer PE of the pseudowire connection. Thus the pseudowire connection can not be signaled by LDP.

How to Configure Segment Routing On Demand Next Hop for L2VPN/VPWS

You can use either pseudowire interface command or template method to configure L2VPN/VPWS.

Configuring Segment Routing On Demand Next Hop for L2VPN/VPWS Using Pseudowire Interface Commands

1. Run the following command on headend node (R1):

```
R1#
!
mpls traffic-eng auto-tunnel p2p tunnel-num min 2000 max 2002
!
interface GigabitEthernet0/3/1
no ip address
negotiation auto
service instance 300 ethernet
encapsulation dot1q 300
!
interface pseudowire4243
encapsulation mpls
neighbor 56.6.6.6 300
preferred-path segment-routing traffic-eng attribute-set L2VPNODN
!
l2vpn xconnect context foobar
member GigabitEthernet0/3/1 service-instance 300
member pseudowire4243
!
mpls traffic-eng lsp attributes L2VPNODN
priority 7 7
path-selection metric te
!
end
```

2. Run the following command at tail end (R2):

```
R2#
!
mpls traffic-eng auto-tunnel p2p tunnel-num min 2000 max 2002

interface pseudowire4243
encapsulation mpls
neighbor 51.1.1.1 300
preferred-path segment-routing traffic-eng attribute-set L2VPNODN
!
interface GigabitEthernet0/2/2
no ip address
negotiation auto
service instance 300 ethernet
encapsulation dot1q 300
!
l2vpn xconnect context foobar
member GigabitEthernet0/3/1 service-instance 300
member pseudowire4243
!
mpls traffic-eng lsp attributes L2VPNODN
priority 7 7
path-selection metric te
!
end
```

Configuring Segment Routing On Demand Next Hop for L2VPN/VPWS Using Template Commands

1. Run the following command at headend node (R1):

```
R1#
template type pseudowire test
  encapsulation mpls
  preferred-path segment-routing traffic-eng attribute-set L2VPNODN
!
interface GigabitEthernet0/3/1
  no ip address
  negotiation auto
  service instance 400 ethernet
  encapsulation dot1q 400
!
l2vpn xconnect context foobar2
  member 56.6.6.6 400 template test
  member GigabitEthernet0/3/1 service-instance 400
```

2. Run the following command at tail end (R2):

```
R2#
!
template type pseudowire test
  encapsulation mpls
  preferred-path segment-routing traffic-eng attribute-set L2VPNODN
!
interface GigabitEthernet0/2/2
  no ip address
  negotiation auto
  service instance 400 ethernet
  encapsulation dot1q 400
!
l2vpn xconnect context foobar2
  member 51.1.1.1 400 template test
  member GigabitEthernet0/2/2 service-instance 400
!
end
```

Configuring Segment Routing On Demand Next Hop for L2VPN/VPWS With Prepend Option

To control the path of LSP it is possible to enable prepend option. The prepend option is only supported with intra-area and supports labeled paths only. To enable prepend option use the following CLI:

```
R1(config-lsp-attr)#path-selection segment-routing prepend
R1(config-lsp-attr-sr-prepend)#?
Segment-routing label prepend commands:
  exit      Exist from segment-routing prepend config mode
  index     Specify the next entry index to add, edit or delete
  list      List all prepend entries
  no        Delete a specific entry index
R1(config-lsp-attr-sr-prepend)#index ?
```

```
<1-10> Entry index number
last-hop Indicates the end of label list
next-label Specify the next MPLS label in the path
```



Note If last-hop option indicates tail end node. If this option is only used no control on LSP path can be done.

Configuring Preferred Path for Segment Routing On Demand Next Hop for L2VPN/VPWS

To bring down virtual circuit (VC) in case of LSP failure, which could be either because of path fail or removing a command, disable the fallback mode.

```
preferred-path segment-routing traffic-eng attribute-set L2VPNODN
disable-fallback disable fall back to alternative route
```

Configuring Autoroute Destination for Segment Routing On Demand Next Hop for L2VPN/VPWS

For inter-area destination, IP address may not be installed at headend. You need to have destination IP address installed to enable a targeted LDP session for L2-VPN VPWS. To enable a targeted LDP session for L2VPN VPWS, configure the auto-route destination under the attribute set:

```
Device#
mpls traffic-eng lsp attributes L2VPNODN
priority 7 7
path-selection metric te
pce
autoroute destination
!
end
```

The destination address gets installed via L2-VPN ODN LSP as a static route.

Run the following commands to verify autoroute destination configuration:

```
Device#sh ip route 56.6.6.6
Routing entry for 56.6.6.6/32
  Known via "static", distance 1, metric 0 (connected)
  Routing Descriptor Blocks:
  * directly connected, via Tunnel2000-----□ L2-VPN ODN LSP
    Route metric is 0, traffic share count is 1
```

```
Device#sh mpls for 56.6.6.6
Local      Outgoing      Prefix          Bytes Label    Outgoing  Next Hop
Label      Label          or Tunnel Id    Switched        interface
25         [T] Pop Label  56.6.6.6/32    0              Tu2000      point2point
```

Verifying Segment Routing On Demand Next Hop for L2VPN/VPWS

1. sh mpls l2 vc

```
Device#sh mpls l2 vc
Local intf      Local circuit      Dest address      VC ID      Status
-----
Gi0/3/1        Eth VLAN 300      56.6.6.6         300        UP
```

2. sh mpls l2 vc detail

```
Device# sh mpls l2 vc detail
Local interface: Gi0/3/1 up, line protocol up, Eth VLAN 300 up
  Interworking type is Ethernet
  Destination address: 56.6.6.6, VC ID: 300, VC status: up
  Output interface: Tu2000, imposed label stack {23 17 20}----□ 20 is the VC label
  assigned by R6
  Preferred path: Tunnel2000, active
  Default path: ready
  Next hop: point2point
  Create time: 00:15:48, last status change time: 00:15:38
  Last label FSM state change time: 00:15:38
  Signaling protocol: LDP, peer 56.6.6.6:0 up
  Targeted Hello: 51.1.1.1(LDP Id) -> 56.6.6.6, LDP is UP
  Graceful restart: not configured and not enabled
  Non stop routing: not configured and not enabled
  Status TLV support (local/remote) : enabled/supported
  LDP route watch : enabled
  Label/status state machine : established, LruRru
  Last local dataplane status rcvd: No fault
  Last BFD dataplane status rcvd: Not sent
  Last BFD peer monitor status rcvd: No fault
  Last local AC circuit status rcvd: No fault
  Last local AC circuit status sent: No fault
  Last local PW i/f circ status rcvd: No fault
  Last local LDP TLV status sent: No fault
  Last remote LDP TLV status rcvd: No fault
  Last remote LDP ADJ status rcvd: No fault
  MPLS VC labels: local 2032, remote 20
  Group ID: local 20, remote 25
  MTU: local 1500, remote 1500
  Remote interface description:
  Sequencing: receive disabled, send disabled
  Control Word: On (configured: autosense)
  SSO Descriptor: 56.6.6.6/300, local label: 2032
  Dataplane:
  SSM segment/switch IDs: 10198/6097 (used), PWID: 1001
  VC statistics:
  transit packet totals: receive 0, send 0
  transit byte totals: receive 0, send 0
  transit packet drops: receive 0, seq error 0, send 0
```

3. sh l2vpn atom preferred-path

```
Device# sh l2vpn atom preferred-path
Tunnel interface  Bandwidth Tot/Avail/Resv      Peer ID      VC ID
```



```

-----
-----
-----
Tunnel2000
 300
!
end
56.6.6.6

```

4. sh l2vpn atom vc

```

Device# sh l2vpn atom vc
Interface Peer ID      VC ID      Type      Name      Status
-----
pw4243    56.6.6.6    300       p2p      foobar    UP
!
end

```

5. sh mpl traffic-eng tun tun 2000

```

Device# sh mpl traffic-eng tun tun 2000
Name: R1_t2000          (Tunnel2000) Destination: 56.6.6.6 Ifhandle: 0x7EE
(auto-tunnel for atom)
Status:
  Admin: up             Oper: up             Path: valid         Signalling: connected
  path option 1, (SEGMENT-ROUTING) (PCE) type dynamic (Basis for Setup, path weight
30)
Config Parameters:
  Bandwidth: 0         kbps (Global) Priority: 7 7 Affinity: 0x0/0xFFFF
  Metric Type: TE (interface)
  Path Selection:
    Protection: any (default)
  Path-selection Tiebreaker:
    Global: not set Tunnel Specific: not set Effective: min-fill (default)
  Hop Limit: disabled
  Cost Limit: disabled
  Path-invalidation timeout: 10000 msec (default), Action: Tear
  AutoRoute: disabled LockDown: disabled Loadshare: 0 [0] bw-based
  auto-bw: disabled
  Attribute-set: L2VPNODN
  Fault-OAM: disabled, Wrap-Protection: disabled, Wrap-Capable: No
Active Path Option Parameters:
  State: dynamic path option 1 is active
  BandwidthOverride: disabled LockDown: disabled Verbatim: disabled
PCEP Info:
  Delegation state: Working: yes Protect: no
  Delegation peer: 58.8.8.8
Working Path Info:
  Request status: processed
  Created via PCRep message from PCE server: 58.8.8.8
  PCE metric: 30, type: TE
Reported paths:
  Tunnel Name: Tunnel2000_w
  LSPs:
  LSP[0]:
    source 51.1.1.1, destination 56.6.6.6, tunnel ID 2000, LSP ID 4
    State: Admin up, Operation active
    Binding SID: 20
    Setup type: SR
    Bandwidth: requested 0, used 0
  LSP object:
    PLSP-ID 0x807D0, flags: D:0 S:0 R:0 A:1 O:2
    Metric type: TE, Accumulated Metric 30
  ERO:
    SID[0]: Adj, Label 19, NAI: local 101.104.1.1 remote 101.104.1.2

```

```

        SID[1]: Adj, Label 23, NAI: local 103.104.12.2 remote 103.104.12.1
        SID[2]: Adj, Label 17, NAI: local 103.106.13.1 remote 103.106.13.2
    PLSP Event History (most recent first):
        Tue Jun 20 10:04:48.514: PCRpt create LSP-ID:4, SRP-ID:0, PST:1, METRIC_TYPE:2,
REQ_BW:0, USED_BW:0
        Tue Jun 20 10:04:48.511: PCRep RP-ID:9
        Tue Jun 20 10:04:48.505: PCReq RP-ID:9, LSP-ID:4, REQ_BW:0
    History:
        Tunnel:
            Time since created: 18 minutes, 26 seconds
            Time since path change: 17 minutes, 9 seconds
            Number of LSP IDs (Tun_Instances) used: 4
            Current LSP: [ID: 4]
            Uptime: 17 minutes, 9 seconds
        Tun_Instance: 4
        Segment-Routing Path Info (isis level-2)
        Segment0[Link]: 101.104.1.1 - 101.104.1.2, Label: 19----- will not be shown in
sh mpls l2 vc output
        Segment1[Link]: 103.104.12.2 - 103.104.12.1, Label: 23
        Segment2[Link]: 103.106.13.1 - 103.106.13.2, Label: 17
    !
end

```

6. sh mpls ldp discovery

```

Device# sh mpls ldp discovery
Local LDP Identifier:
    51.1.1.1:0
Discovery Sources:
Targeted Hellos:
    51.1.1.1 -> 56.6.6.6 (ldp): active/passive, xmit/recv
    LDP Id: 56.6.6.6:0

```

7. sh mpls ldp nei

```

Device# sh mpls ldp nei
Peer LDP Ident: 56.6.6.6:0; Local LDP Ident 51.1.1.1:0
TCP connection: 56.6.6.6.38574 - 51.1.1.1.646
State: Oper; Msgs sent/rcvd: 43/42; Downstream
Up time: 00:19:33
LDP discovery sources:
    Targeted Hello 51.1.1.1 -> 56.6.6.6, active, passive
Addresses bound to peer LDP Ident:
    105.106.2.2    103.106.13.2    56.6.6.6
    !

```

8. sh int pseudowire 4243

```

Device# sh int pseudowire 4243
pseudowire4243 is up
    MTU 1500 bytes, BW not configured
    Encapsulation mpls
    Peer IP 56.6.6.6, VC ID 300
    RX    0 packets 0 bytes 0 drops
    TX    0 packets 0 bytes 0 drops
    !

```

9. sh xconnect all

```

Device# sh xconnect all
Legend:    XC ST=Xconnect State  S1=Segment1 State  S2=Segment2 State

```



CHAPTER 12

Fast Convergence Default Optimize

The fast convergence default optimize feature modifies the default settings of all the protocols to recommended defaults for fast convergence.

- [Information About Fast Convergence Default Optimize, on page 135](#)
- [Default Optimize Values for IS-IS, on page 136](#)
- [Default Optimize Values for OSPF, on page 136](#)
- [Additional References for Fast Convergence Default Optimize, on page 138](#)
- [Feature Information for Fast Convergence Default Optimize, on page 138](#)

Information About Fast Convergence Default Optimize

The fast convergence default optimize feature modifies the default settings of all the protocols to recommended defaults for fast convergence. To revert the defaults to pre-fast-convergence settings for both IS-IS and OSPF, **no routing-default-optimize** command is used. This command sends signals to IS-IS and OSPF and modifies the default configuration for these protocols.

By default, the fast convergence settings is enabled which means when you upgrade the software, you can automatically see the new behavior. This makes easier integration of the devices in a multi-vendor deployment and reduces support cases for poor convergence.

When default optimize is disabled, existing protocol default configuration is used. When default optimize is enabled, new protocol defaults are used. The show running configurations does not display configuration lines for default settings even when default settings are being used.

A configuration of a protocol overrides the default, but a change to default optimize does not override any configuration.

The following is the sample output of **spf-interval** command in IS-IS:

```
Device(config-if)# router isis
Device(config-router)# spf-interval 10 5500 5500
```

If a non-default value is configured, it will be displayed in show running configuration output:

```
Device(config-router)# spf-interval 5 50 200
Device(config-router)# do show run | inc spf-interval
spf-interval 5 50 200
```

You can revert to the default values by configuring the default values or by removing the non-default configuration.

Default Optimize Values for IS-IS

The following table summarizes the configuration impacted by default optimize:

IS-IS command	Parameters	Default optimize disabled	Default optimize enabled
fast-flood			
	# of Isps flooded back-back	Disabled	10
spf-interval			
	Initial (milliseconds)	5500	50
	Secondary (milliseconds)	5500	200
	max (seconds)	10	5
prc-interval			
	Initial (milliseconds)	2000	50
	Secondary (milliseconds)	5000	200
	max (seconds)	5	5
lsp-gen-interval			
	Initial (milliseconds)	50	50
	Secondary (milliseconds)	5000	200
	max (seconds)	5	5
log-adjacency-changes		disabled	enabled

Default Optimize Values for OSPF

The following table summarizes the configuration impacted by default optimize for OSPFv2/v3:

OSPF command	Parameters	Default optimize disabled	Default optimize enabled
timers throttle spf			
	Initial (milliseconds)	5000	50
	Secondary (milliseconds)	10000	200

OSPF command	Parameters	Default optimize disabled	Default optimize enabled
	max (milliseconds)	10	5
timers throttle lsa all			
	Initial (milliseconds)	0	50
	Secondary (milliseconds)	5000	200
	max (milliseconds)	5	5
timers lsa arrival			
	milliseconds	1000	100

The following is the sample output of **show ip ospf** command for OSPFv2 with the default-optimize values.

```

Device# show ip ospf
Routing Process "ospf 10" with ID 1.1.1.1
Start time: 00:00:01.471, Time elapsed: 03:00:34.706
Supports only single TOS(TOS0) routes
Supports opaque LSA
Supports Link-local Signaling (LLS)
Supports area transit capability
Supports NSSA (compatible with RFC 3101)
Supports Database Exchange Summary List Optimization (RFC 5243)
Event-log enabled, Maximum number of events: 1000, Mode: cyclic
Router is not originating router-LSAs with maximum metric
Initial SPF schedule delay 50 msec
Minimum hold time between two consecutive SPF 200 msec
Maximum wait time between two consecutive SPF 5000 msec
Incremental-SPF disabled
Initial LSA throttle delay 50 msec
Minimum hold time for LSA throttle 200 msec
Maximum wait time for LSA throttle 5000 msec
Minimum LSA arrival 100 msec
LSA group pacing timer 240 secs
Interface flood pacing timer 33 msec
Retransmission pacing timer 66 msec
EXCHANGE/LOADING adjacency limit: initial 300, process maximum 300
Number of external LSA 18. Checksum Sum 0x075EB2
Number of opaque AS LSA 0. Checksum Sum 0x000000
Number of DCbitless external and opaque AS LSA 0
Number of DoNotAge external and opaque AS LSA 0
Number of areas in this router is 1. 1 normal 0 stub 0 nssa
Number of areas transit capable is 0
External flood list length 0
IETF NSF helper support enabled
Cisco NSF helper support enabled
Reference bandwidth unit is 100 mbps
  Area BACKBONE(0)
    Number of interfaces in this area is 4 (2 loopback)
    Area has RRR enabled
    Area has no authentication
    SPF algorithm last executed 02:27:23.736 ago
    SPF algorithm executed 20 times
    Area ranges are
    Number of LSA 94. Checksum Sum 0x321DCF
    Number of opaque link LSA 0. Checksum Sum 0x000000
    Number of DCbitless LSA 0

```

```

Number of indication LSA 0
Number of DoNotAge LSA 0
Flood list length 0

```

The following is the sample output of **show ospf** command for OSPFv3 with the default-optimize values.

```

Device# show ospfv3
  OSPFv3 10 address-family ipv6
    Router ID 11.11.11.11
    Supports NSSA (compatible with RFC 3101)
    Supports Database Exchange Summary List Optimization (RFC 5243)
    Event-log enabled, Maximum number of events: 1000, Mode: cyclic
    Router is not originating router-LSAs with maximum metric
    Initial SPF schedule delay 50 msec
    Minimum hold time between two consecutive SPF's 200 msec
    Maximum wait time between two consecutive SPF's 5000 msec
    Initial LSA throttle delay 50 msec
    Minimum hold time for LSA throttle 200 msec
    Maximum wait time for LSA throttle 5000 msec
    Minimum LSA arrival 100 msec
    LSA group pacing timer 240 secs
    Interface flood pacing timer 33 msec
    Retransmission pacing timer 66 msec
    Retransmission limit dc 24 non-dc 24
    EXCHANGE/LOADING adjacency limit: initial 300, process maximum 300
    Number of external LSA 0. Checksum Sum 0x000000
    Number of areas in this router is 1. 1 normal 0 stub 0 nssa
    Graceful restart helper support enabled
    Reference bandwidth unit is 100 mbps
    RFC1583 compatibility enabled
      Area BACKBONE(0)
        Number of interfaces in this area is 2
        SPF algorithm executed 7 times
        Number of LSA 3. Checksum Sum 0x012426
        Number of DCbitless LSA 0
        Number of indication LSA 0
        Number of DoNotAge LSA 0
        Flood list length 0

```

Additional References for Fast Convergence Default Optimize

Related Documents

Related Topic	Document Title
Cisco IOS Commands	Cisco IOS Master Command List, All Releases

Feature Information for Fast Convergence Default Optimize

The following table provides release information about the feature or features described in this module. This table lists only the software release that introduced support for a given feature in a given software release train. Unless noted otherwise, subsequent releases of that software release train also support that feature.

Use Cisco Feature Navigator to find information about platform support and Cisco software image support. To access Cisco Feature Navigator, go to www.cisco.com/go/cfn. An account on Cisco.com is not required.

Table 11: Feature Information for Fast Convergence Default Optimize

Feature Name	Releases	Feature Information
Fast Convergence Default Optimize	Cisco IOS XE Everest 16.5.1b	The fast convergence default optimize feature modifies the default settings of all the protocols to recommended defaults for fast convergence. No new commands were added or modified.



CHAPTER 13

Routing Information Base Support

The Routing Information Base (RIB) enhancement supports route redistribution and on-demand nexthop requirements.

- [Routing Information Base Support for Route Redistribution, on page 141](#)
- [OSPF Node SID Redistribution Support, on page 141](#)
- [Routing Information Base Support for On-Demand Next Hop, on page 144](#)
- [Additional References for Routing Information Base Support, on page 144](#)
- [Feature Information for Routing Information Base Support, on page 145](#)

Routing Information Base Support for Route Redistribution

Effective with Cisco IOS XE Everest 16.5.1, a requirement to redistribute labels associated with prefixes is introduced. To support redistribution requirements, the storage of local label per prefix is supported in RIB.

The local label is stored instead of the SID to ease use with different protocols which may use different SRGBs. The SID assigned by the destination protocol may not be the same as the SID associated with the source protocol.

The prefix reachability advertisement or an SRMS advertisement is the source of the SID. In SRMS advertisement, the destination protocols for redistribution do not advertise the SID in their prefix reachability advertisements, as this alters conflict resolution by indicating on other network nodes that the source of the advertisement was not from SRMS.

OSPF Node SID Redistribution Support

Effective Cisco IOS XE 16.7.1, when OSPF receives the redistributed prefixes from other IGPs and vice versa the prefix segment identifiers (SIDs) are also advertised which was not the case earlier. You needed to have the BGP LS (or) segment routing mapping server (SRMS) support to learn the SIDs across the IGP domains.

When the user enable redistribution under OSPF the prefix SID entries associated with the prefix entries are provided to OSPF. This gets advertised by OSPF to all its neighbor. The way OSPF advertises varies depending upon the role of OSPF in the network.

Information About OSPF Node SID Redistribution Support

NSSA ASBR

When you enable **redistribute ISIS instance ip** under OSPF which is Not-So-Stubby Area autonomous system boundary router (NSSA ASBR), it gets all the prefixes from IP routing information base (RIB) which are learnt by IS-IS along with the SID entries. OSPF generates Extended Prefix LSA (EPL) with the scope as area and the route type as RTYPE_NSSA1 or RTYPE_NSSA2 for the prefixes and advertises to all its neighbors. Similarly, when the redistribution is un-configured (or) when the prefixes become unavailable OSPF withdraws the EPL. When the redistributed route is a non-connected route then the OSPF sets the No-PHP flag but explicit NULL flag is not set. However, when the redistributed route is a connected route then OSPF sets the explicit NULL and No-PHP flag according to the configuration done in the SR policy.

When NSSA ABR receives the EPL, the ABR translates the LSA into opaque AS EPL and floods it to all its neighbors.

When a NSSA router which is neither ABR nor ASBR receives the EPL, it learns the prefix along with the SID entries and floods it to all its neighbors in the same area.

non-NSSA ASBR

When the user enabled **redistribute ISIS instance ip** under OSPF which is regular ASBR router, it gets all the prefixes from IP RIB which are learnt by IS-IS along with the SID entries. OSPF generates EPL with the scope as autonomous system (AS) and the route type as RTYPE_EXTERN1 or RTYPE_EXTERN2 for the prefixes and advertises to all its neighbors. Similarly when the redistribution is unconfigured (or) when the prefixes become unavailable, OSPF withdraws the EPL again with AS-Scope. When the redistributed route is a non-connected route then the OSPF sets the No-PHP flag but explicit NULL flag is not set. However, when the redistributed route is a connected route then OSPF sets the explicit NULL and No-PHP flag according to the configuration done in the SR policy. When a router receives the EPL with AS scope, it learns the prefix along with the SID entry and floods it to all its neighbors in all areas.

Redistributing Prefix

When IS-IS is enabled for redistribution of OSPF routes the prefixes are given along with the SID information so that the prefixes reach to other domain with the SID values. Refer to the below topology to understand the OSPF prefixes redistribution to the other domains:

Figure 17: OSPF Prefix Redistribution

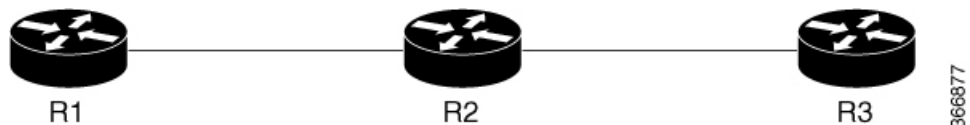

R1 and R2 are enabled for OSPF. R2 and R3 are enabled for IS-IS. Both IS-IS and OSPF are enabled for Segment Routing. In R2, both IS-IS and OSPF are configured. Prefixes configured are:

1. 1.1.1/32 in R1 (enabled for OSPF with SID 1)
2. 2.2.2/32 in R2 (enabled for OSPF with SID 2)
3. 3.3.3/32 in R3 (enabled for ISIS SID 3)

When you enable SID redistribution in R2, then the prefix 3.3.3.3/32 is redistributed to R1. So, R1 knows the SID to reach the prefix R3.

```

conf t
router isis 10
 net 49.0001.0000.0000.0001.00
 metric-style wide
distribute link-state
 segment-routing mpls
router ospf 10
router-id 2.2.2.2
segment-routing mpls
distribute link-state

```

To enable redistribution of ISIS into OSPF routes:

```

conf t
router ospf 10
redistribute isis 10 ip

```

Verifying OSPF Node SID Redistribution

Use the **show ip ospf rib redistribution detail** command to verify if OSPF is redistributing the prefixes from IS-IS.

```

Device# show ip ospf rib redistribution detail
OSPF Router with ID (2.2.2.2) (Process ID 10)

      Base Topology (MTID 0)

OSPF Redistribution
3.3.3.3/32, type 2, metric 20, tag 0, from IS-IS Router
  Attributes 0x1000000, event 1, PDB Index 4, PDB Mask 0x0
  Source route metric 20, tag 0
  SID 1003, SID Flags NP-bit, EPX Flags None
  via 7.9.0.9, Ethernet0/0

```

Use the **show ip ospf segment-routing local-prefix** command to verify if the SID entries are advertised to its neighbor.

```

Device# show ip ospf segment-routing local-prefix

      OSPF Router with ID (2.2.2.2) (Process ID 10)

Area 0:
Prefix:          Sid:   Index:          Type:          Source:
2.2.2.2/32      2     0.0.0.0        Intra          Loopback0
AS external:
Prefix:          Sid:   Index:          Type:          Source:
3.3.3.3/32      3     0.0.0.1        External       Redist

```

Use the **show ip ospf segment-routing sid-database** command to verify if the SIDs are received.

```

Device# show ip ospf segment-routing sid-database

      OSPF Router with ID (1.1.1.1) (Process ID 10)
OSPF Segment Routing SIDs

Codes: L - local, N - label not programmed,
      M - mapping-server

SID          Prefix          Adv-Rtr-Id      Area-Id  Type
-----

```

```

1          1.1.1.1/32          1.1.1.1          0          Intra
2          2.2.2.2/32          2.2.2.2          0          Intra
3          3.3.3.3/32          2.2.2.2          -          External

```

Use the **show ip route 3.3.3.3** command to verify if the IP routing entry is configured for the redistributed route.

```

Device# show ip route 3.3.3.3
Routing entry for 3.3.3.3/32
  Known via "ospf 10", distance 110, metric 20, type extern 2, forward metric 20
  Last update from 1.2.0.2 on Ethernet0/1, 00:00:01 ago
  SR Incoming Label: 16003
  Routing Descriptor Blocks:
  * 1.3.1.3, from 2.2.2.2, 00:00:01 ago, via Ethernet1/1, merge-labels
    Route metric is 20, traffic share count is 1
    MPLS label: 16003
    MPLS Flags: NSF

```

Routing Information Base Support for On-Demand Next Hop

For On-Demand Next Hop (ODN) requirements, RIB supports a next hop called binding label which is provided by the supporting routing protocol (BGP). The binding label is used by the FIB to dynamically resolve the next hop.

The route producer installs a local binding label which identifies the ODN tunnel path associated with the next hop. The labeled traffic is sent via the tunnel and the label is distinct from the existing outlabel.

The following is the sample output of **show ip route** command where each next hop is updated to show the binding label.

```

Device# show ip route 10.10.10.2

Routing entry for 10.10.10.2/32
  Known via "isis", distance 115, metric 10, type level-1
  Redistributing via isis
  Last update from 200.200.200.2 on Ethernet0/0, 00:00:14 ago
  Incoming Label: 16100
  Routing Descriptor Blocks:
  * 200.200.200.2, from 10.10.10.2, 00:00:14 ago, via Ethernet0/0
    Route metric is 10, traffic share count is 1
  * Binding Label 4020, from 2.2.2.2, 00:00:14 ago,
    Route metric is 10, traffic share count is 1

```



Note The incoming labels are seen only after the SID redistribution is enabled.

Additional References for Routing Information Base Support

Related Documents

Related Topic	Document Title
Cisco IOS Commands	Cisco IOS Master Command List, All Releases

Feature Information for Routing Information Base Support

The following table provides release information about the feature or features described in this module. This table lists only the software release that introduced support for a given feature in a given software release train. Unless noted otherwise, subsequent releases of that software release train also support that feature.

Use Cisco Feature Navigator to find information about platform support and Cisco software image support. To access Cisco Feature Navigator, go to www.cisco.com/go/cfn. An account on Cisco.com is not required.

Table 12: Feature Information for Routing Information Base Support

Feature Name	Releases	Feature Information
Routing Information Base Support	Cisco IOS XE Everest 16.5.1b	The Routing Information Base (RIB) enhancement supports route redistribution and On-Demand Nexthop requirements. No new commands were added or modified.
OSPF Node SID Redistribution Support	Cisco IOS XE Fuji 16.7.1	Effective the Cisco IOS XE Fuji 16.7.1 release, when OSPF receives the redistributed prefixes from other IGPs and vice versa the prefix segment identifiers (SIDs) are also advertised which was not the case earlier. You need to have the BGP LS (or) segment routing mapping server (SRMS) support to learn the SIDs across the IGP domains. The following commands were added or modified for this feature: show ip ospf rib redistribution detail, show ip ospf segment-routing local-prefix, show ip ospf segment-routing sid-database, show ip route 3.3.3.3.



CHAPTER 14

SR-TE On Demand LSP

The SR TE On demand LSP feature provides the ability to connect Metro access rings via a static route to the destination. The static route is mapped to an explicit path and that will trigger an on demand LSP to the destination. The SR TE On demand LSP feature will be used to transport the VPN services between the Metro access rings.

- [Restrictions for SR-TE On Demand LSP, on page 147](#)
- [Information About SR-TE On Demand LSP, on page 147](#)
- [How to Configure SR-TE On Demand LSP, on page 148](#)
- [Additional References for SR-TE On Demand LSP, on page 152](#)
- [Feature Information for SR-TE On Demand LSP, on page 152](#)

Restrictions for SR-TE On Demand LSP

- Segment-Routing auto tunnel static route does not support ECMP.
- Metrics for IP explicit path and administrative distance change for auto tunnel SRTE static route is not supported.
- MPLS Traffic Engineering (TE) Nonstop Routing (NSR) must be configured on the active route processor (RP) for Stateful Switchover (SSO). This is because, SR static auto tunnel will fail to come up after SSO, unless the static route auto tunnel configuration is removed and reconfigured.
- IP unnumbered interfaces do not support dynamic path.
- When using IP unnumbered interfaces, you cannot specify next hop address as an explicit path index. It should be a node address or a label.

Information About SR-TE On Demand LSP

The SR TE On demand LSP feature provides the ability to connect Metro access rings via a static route to the destination.

SR-TE: Setup LSP as Static Route

Agile Carrier Ethernet (ACE) solution leverages Segment Routing-based transport for consolidated VPN services. In metro rings architecture, the access rings do not share their routing topologies with each other.

The SR TE On demand LSP feature provides the ability to connect Metro access rings via a static route to the destination. The static route is mapped to an explicit path and that will trigger an on demand LSP to the destination. The SR TE On demand LSP feature will be used to transport the VPN services between the Metro access rings.

Figure 18: Inter-Metro LSP in ACE Solution

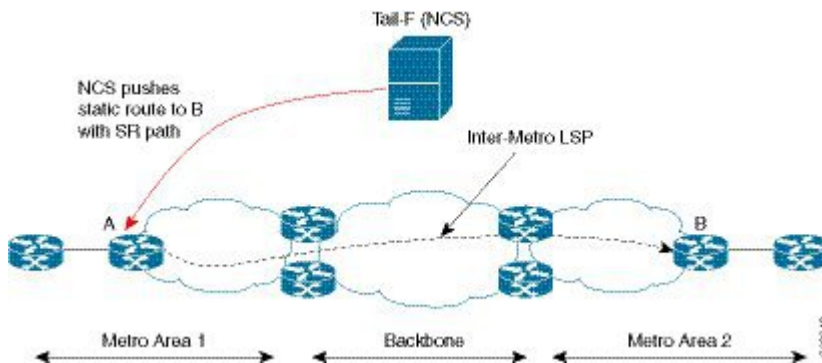

Inter-Metro LSPs have the following aspects:

- The source packet may not know the IP address of the destination device.
- Existing segment routing features are applicable for LSPs.

The binding SID helps in steering the traffic in the SR-TE tunnel. In other words, ingress MPLS packet with the binding SID will be forwarded through the specific SR-TE tunnel.

Static SRTE over Unnumbered Interfaces

As explained in the previous section, you can set up LSP as static route to create an auto tunnel by specifying an IP explicit path.

The explicit path is a combination of IP addresses (or) IP address and labels. You can also configure the static SRTE tunnel over unnumbered interfaces. There are few restrictions for unnumbered interfaces against numbered interfaces.

- You must specify the node IP address, not the next hop interface address in the ip-explicit path option.
- You must not specify adjacency SID in the explicit path option. In short, the explicit path option should contain only the node IP address (/32 mask) and prefix SID labels.

How to Configure SR-TE On Demand LSP

Perform the following steps to configure SR-TE On Demand LSP.

Configuring LSP as Static Route

To avoid packet drop after RP switchover with SR TE, it is recommended to use the following command:

```
mpls traffic-eng nsr
```

If ISIS is configured, use the following command:

```
router isis
 nsf cisco
 nsf interval 0
```

Enabling Segment Routing Auto Tunnel Static Route

Perform this task to configure auto tunnel static route as follows:

- Configure IP explicit path
- Associate the auto tunnel with an IP explicit path with a static route
- Enable peer-to-peer (P2P) auto tunnel service

```
ip explicit-path name path1
 index 1 next-label 16002
 index 2 next-label 16006
 exit
ip route 172.16.0.1 255.240.0.0 segment-routing mpls path name path1
mpls traffic-eng auto-tunnel p2p
mpls traffic-eng auto-tunnel p2p config unnumbered-interface loopback0
mpls traffic-eng auto-tunnel p2p tunnel-num min 10 max 100
```

Verifying Segment Routing Auto-Tunnel Static Route

The command **show mpls traffic-eng service summary** displays all registered TE service clients and statistics that use TE auto tunnel.

```
Device# show mpls traffic-eng service summary
```

```
Service Clients Summary:
Client: BGP TE
  Client ID           :0
  Total P2P tunnels   :1
  P2P add requests    :6
  P2P delete requests :5
  P2P add falis       :0
  P2P delete falis    :0
  P2P notify falis    :0
  P2P notify succs    :12
  P2P replays         :0
Client: ipv4static
  Client ID           :1
  Total P2P tunnels   :1
  P2P add requests    :6
  P2P delete requests :5
  P2P add falis       :0
  P2P delete falis    :0
  P2P notify falis    :0
  P2P notify succs    :85
  P2P replays         :0
```

The command **show mpls traffic-eng auto-tunnel p2p** displays the peer-to-peer (P2P) auto tunnel configuration and operation status.

```
Device# show mpls traffic-eng auto-tunnel p2p
```

```
State: Enabled
p2p auto-tunnels: 2 (up: 2, down: 0)
Default Tunnel ID Range: 62336 - 64335
Config:
  unnumbered-interface: Loopback0
  Tunnel ID range: 1000 - 2000
```

The command **show mpls traffic-eng tunnel summary** displays the status of P2P auto tunnel.

```
Device# show mpls traffic-eng tunnel summary
```

```
Signalling Summary:
  LSP Tunnels Process:          running
  Passive LSP Listener:        running
  RSVP Process:                running
  Forwarding:                  enabled
  auto-tunnel:
    p2p   Enabled (1), id-range:1000-2000
  Periodic reoptimization:      every 3600 seconds, next in 1265 seconds
  Periodic FRR Promotion:       Not Running
  Periodic auto-bw collection:  every 300 seconds, next in 66 seconds
  SR tunnel max label push:     13 labels
  P2P:
    Head: 11 interfaces, 5234 active signalling attempts, 1 established
          5440 activations, 206 deactivations
          1821 failed activations
          0 SSO recovery attempts, 0 SSO recovered
    Midpoints: 0, Tails: 0
  P2MP:
    Head: 0 interfaces, 0 active signalling attempts, 0 established
          0 sub-LSP activations, 0 sub-LSP deactivations
          0 LSP successful activations, 0 LSP deactivations
          0 SSO recovery attempts, LSP recovered: 0 full, 0 partial, 0 fail
    Midpoints: 0, Tails: 0
  Bidirectional Tunnel Summary:
    Tunnel Head: 0 total, 0 connected, 0 associated, 0 co-routed
    LSPs Head:  0 established, 0 proceeding, 0 associated, 0 standby
    LSPs Mid:   0 established, 0 proceeding, 0 associated, 0 standby
    LSPs Tail:  0 established, 0 proceeding, 0 associated, 0 standby

  AutoTunnel P2P Summary:
    ipv4static:
      Tunnels: 1 created, 1 up, 0 down
    Total:
      Tunnels: 1 created, 1 up, 0 down
```

The command **show mpls traffic-eng tunnel auto-tunnel** only displays TE service auto tunnel.

```
Device# show mpls traffic-eng tunnel auto-tunnel detail
```

```
P2P TUNNELS/LSPs:

Name: R1_t1000 (Tunnel1000) Destination: 0.0.0.0 Ifhandle: 0x17
(auto-tunnel for ipv4static)
Status:
  Admin: up      Oper: up      Path: valid      Signalling: connected
  path option 1, (SEGMENT-ROUTING) type explicit (verbatim) path202 (Basis for Setup)
```

```

Config Parameters:
  Bandwidth: 0          kbps (Global)  Priority: 7 7  Affinity: 0x0/0xFFFF
  Metric Type: TE (default)
  Path Selection:
    Protection: any (default)
  Path-selection Tiebreaker:
    Global: not set  Tunnel Specific: not set  Effective: min-fill (default)
  Hop Limit: disabled [ignore: Verbatim Path Option]
  Cost Limit: disabled
  Path-invalidation timeout: 10000 msec (default), Action: Tear
  AutoRoute: disabled LockDown: disabled Loadshare: 0 [0] bw-based
  auto-bw: disabled
  Fault-OAM: disabled, Wrap-Protection: disabled, Wrap-Capable: No
Active Path Option Parameters:
  State: explicit path option 1 is active
  BandwidthOverride: disabled LockDown: disabled Verbatim: enabled

History:
  Tunnel:
    Time since created: 33 days, 20 hours, 29 minutes
    Time since path change: 10 days, 19 hours, 45 minutes
    Number of LSP IDs (Tun_Instances) used: 1646
  Current LSP: [ID: 1646]
    Uptime: 10 days, 19 hours, 45 minutes
  Prior LSP: [ID: 1645]
    ID: path option unknown
    Removal Trigger: signalling shutdown
  Tun_Instance: 1646
  Segment-Routing Path Info (IGP information is not used)
    Segment0[First Hop]: 0.0.0.0, Label: 16002
    Segment1[ - ]: Label: 16006

```

The command **show mpls traffic-eng tunnel brief** displays auto tunnel information.

```
Device# show mpls traffic-eng tunnel brief
```

```

Signalling Summary:
  LSP Tunnels Process:          running
  Passive LSP Listener:        running
  RSVP Process:                 running
  Forwarding:                   enabled
  auto-tunnel:
    p2p      Enabled (2), id-range:1000-2000

  Periodic reoptimization:      every 3600 seconds, next in 406 seconds
  Periodic FRR Promotion:       Not Running
  Periodic auto-bw collection:  every 300 seconds, next in 107 seconds
  SR tunnel max label push:     13 labels

P2P TUNNELS/LSPs:
TUNNEL NAME          DESTINATION    UP IF    DOWN IF    STATE/PROT
R1_t1                66.66.66.66   -        -          up/down
R1_t2                66.66.66.66   -        -          up/up
R1_t3                66.66.66.66   -        -          up/up
R1_t10               66.66.66.66   -        -          up/up
SBFD tunnel          33.33.33.33   -        -          up/up
SBFD Session configured: 1    SBFD sessions UP: 1

```

Additional References for SR-TE On Demand LSP

Related Documents

Related Topic	Document Title
Cisco IOS Commands	Cisco IOS Master Command List, All Releases

Feature Information for SR-TE On Demand LSP

The following table provides release information about the feature or features described in this module. This table lists only the software release that introduced support for a given feature in a given software release train. Unless noted otherwise, subsequent releases of that software release train also support that feature.

Use Cisco Feature Navigator to find information about platform support and Cisco software image support. To access Cisco Feature Navigator, go to www.cisco.com/go/cfn. An account on Cisco.com is not required.

Table 13: Feature Information for SR-TE On Demand LSP

Feature Name	Releases	Feature Information
SR-TE On Demand LSP	Cisco IOS XE Everest 16.5.1b	<p>The SR TE On demand LSP feature provides the ability to connect Metro access rings via a static route to the destination. The static route is mapped to an explicit path and that will trigger an on demand LSP to the destination. The SR TE On demand LSP feature will be used to transport the VPN services between the Metro access rings.</p> <p>The following command was modified: mpls traffic-eng auto-tunnel.</p>



CHAPTER 15

Segment Routing MPLS OAM Support

Segment Routing Operations, Administration, and Maintenance (OAM) helps service providers to monitor label-switched paths (LSPs) and quickly isolate forwarding problems to assist with fault detection and troubleshooting in the network. The Segment Routing OAM feature provides support for Nil-FEC (forwarding equivalence classes) LSP Ping and Traceroute, IGP prefix SID FEC type, and partially IGP adjacency-SID FEC type for SR-TE functionality.

- [Restrictions for Segment Routing OAM MPLS Support, on page 153](#)
- [Information About Segment Routing MPLS OAM Support, on page 154](#)
- [How to Diagnose Segment Routing with LSP Ping and Trace Route Nil FEC Target, on page 155](#)
- [Example for LSP Ping Nil FEC Target Support, on page 156](#)
- [Path Validation in Segment Routing Network, on page 158](#)
- [Configuring Segment Routing MPLS Traffic Engineering for MPLS Ping and Traceroute, on page 160](#)
- [Configuring Segment Routing MPLS IGP for MPLS Ping and Traceroute, on page 160](#)
- [Verifying Segment Routing OAM Using Cisco IOS CLI, on page 161](#)
- [Additional References for Segment Routing OAM Support, on page 166](#)
- [Feature Information for Segment Routing OAM Support, on page 166](#)

Restrictions for Segment Routing OAM MPLS Support

- Ping and traceroute are unsupported with SR-TE static auto tunnel, BGP Dynamic TE, and on-demand next hop auto tunnels.
- Strict-SID option is not supported by the path installed by OSPF.
- MPLS traceroute does not support popping of two explicit null labels in one node.
- Rerouting the path to IP over MPLS segment without using Layer3 VPN is not supported due to IP routing destination not being a MPLS FEC.

Information About Segment Routing MPLS OAM Support

Segment Routing OAM Support

The Nil-FEC LSP ping and traceroute operations are extensions of regular MPLS ping and traceroute. Nil-FEC LSP Ping/Trace functionality support Segment Routing and MPLS Static. It also act as an additional diagnostic tool for all other LSP types. This feature allows operators to test any label stack to specify the following:

- label stack
- outgoing interface
- nexthop address

In the case of segment routing, each segment nodal label and adjacent label along the routing path is put into the label stack of an echo request message from initiator Label Switch Router (LSR); MPLS data plane forward this packet to the label stack target, and the label stack target reply the echo message back.

Benefits of Segment Routing OAM Support

- The feature enables the MPLS OAM functionality in the Segment Routing Network where the traffic is engineering via SR-TE tunnels or native SR forwarding.
- In traditional MPLS networks, source node chooses the path based on hop by hop signaling protocols such as LDP or RSVP-TE. In Segment Routing Networks, the path is specified by set of segments which are advertised by the IGP protocols (currently OSPF and ISIS).
- As the volume of services offered using SR increase, it is important that the operator essentially is able to do the connectivity verification and the fault isolation in the SR architecture.
- The segment assignment is not based on hop by hop protocols as in traditional MPLS network, any broken transit node could lead in traffic blackholing, which could lead to undesired behavior.
- Both SR and SR-TE supports load balancing, it is important to trace all the ECMP paths available between source and target routers. The features offers the multipath traceroute support for both TE and native SR paths.
- The following are the main benefits of Segment Routing-OAM Support:
 - **Operations:** Network monitoring and fault management.
 - **Administration:** Network discovery and planning.
 - **Maintenance:** Corrective and preventive activities, minimize occurrences and impact of failures.

Segment Routing MPLS Ping

MPLS ping and traceroute are extendable by design. You can add SR support by defining new FECs and/or additional verification procedures. MPLS ping verifies MPLS data path and performs the following:

- Encapsulates echo request packet in MPLS labels.

- Measures coarse round trip time.
- Measures coarse round trip delay.

Segment Routing MPLS Traceroute

MPLS ping and traceroute are extendable by design. You can add SR support by defining new forwarding equivalence classes (FECs) and/or additional verification procedures. MPLS traceroute verifies forwarding and control plane at each hop of the LSP to isolate faults. Traceroute sends MPLS echo requests with monotonically increasing time-to-live (TTL), starting with TTL of 1. Upon TTL expiry, transit node processes the request in software and verifies if it has an LSP to the target FEC and intended transit node. The transit node sends echo reply containing return code specifying the result of above verification and label stack to reach the next-hop, as well as ID of the next-hop towards destination, if verification is successful. Originator processes echo reply to build the next echo request containing TTL+1. Process is repeated until the destination replies that it is the egress for the FEC.

LSP Ping Operation for Nil FEC target

The LSP Ping/Traceroute is used in identifying LSP breakages. The nil-fec target type can be used to test the connectivity for a known label stack. Follow the existing LSP ping procedure (for more information, refer [MPLS LSP Ping/Traceroute](#)), with the following modifications:

- Build the echo request packet with the given label stack.
- Append explicit null label at the bottom of the label stack.
- Build echo request FTS TLV with target FEC Nil FEC and label value set to the bottom label of the label stack, which is explicit-null.

How to Diagnose Segment Routing with LSP Ping and Trace Route Nil FEC Target

Using LSP Ping for Nil FEC Target

The Nil FEC LSP ping and traceroute operation are simply extension of regular MPLS ping and trace route. **nil-fec labels <label, label...>** is added to the ping mpls command. This command sends an echo request message with MPLS label stack as specified and add another explicit null at bottom of the stack.

```
ping mpls nil-fec labels <comma separated labels> output interface <tx-interface> nexthop
<nexthop ip addr>
[repeat <count>]
[size <size> | sweep <min_size> <max_size> <increment>]
[timeout <seconds>]
[interval <milliseconds>]
[destination <addr_start> [<addr_end> [<addr_incr_mask> | <addr_incr>]]]
[source <addr>]
[exp <exp-value>]
[pad <pattern>]
[ttl <t1>]
```

```
[reply [mode [ipv4 | router-alert | no-reply]]
[dscp <dscp-bits>]
[pad-tlv]]
[verbose]
[force-disposition ra-label]
{dsmtp | ddmmap [l2ecmp]} [hashkey {none | {ipv4 | ipv4-label-set {bitmap <bitmap_size>}}}]
```

For more information, refer [ping mpls](#).

Using LSP Traceroute for Nil FEC Target

```
trace mpls nil-fec labels <comma separated labels> output interface <tx-interface> nexthop
<nexthop ip addr>
[timeout <seconds>]
[destination <addr_start> [<addr_end> [<addr_incr_mask> | <addr_incr>]]]
[source <addr> ]
[exp <exp-value>]
[ttl <ttl-max>]
[reply [mode [ipv4 | router-alert | no-reply]]
[dscp <dscp-bits>]
[pad-tlv]]
[flags {fec | ttl}]
[hashkey ipv4 | ipv4-label-set {bitmap <bitmap_size>}]
```

For more information, refer to the [traceroute mpls](#).

Example for LSP Ping Nil FEC Target Support

```
Node loopback IP address: 1.1.1.3          1.1.1.4          1.1.1.5
                        1.1.1.7
Node label:                16004          16005
                        16007
Nodes:                      Arizona ----- Utah ----- Wyoming
----- Texas
Interface:                   Eth1/0          Eth1/0
Interface IP address:        30.1.1.3          30.1.1.4

Device#sh mpls forwarding-table
Local   Outgoing Prefix          Bytes Label   Outgoing Next Hop
Label   Label   or Tunnel Id   Switched      interface
16      Pop Label 3333.3333.0000-Et1/0-30.1.1.3 \
        0
        Et1/0    30.1.1.3
17      Pop Label 5555.5555.5555-Et1/1-90.1.1.5 \
        0
        Et1/1    90.1.1.5
18      Pop Label 3333.3333.0253-Et0/2-102.102.102.2 \
        0
        Et0/2    102.102.102.2
19      Pop Label 9.9.9.4/32      0
        Et0/2    102.102.102.2
20      Pop Label 1.1.1.5/32      0
        Et1/1    90.1.1.5
21      Pop Label 1.1.1.3/32      0
        Et1/0    30.1.1.3
22      Pop Label 16.16.16.16/32 0
        Et1/0    30.1.1.3
23      Pop Label 16.16.16.17/32 0
        Et1/0    30.1.1.3
24      Pop Label 17.17.17.17/32 0
        Et1/0    30.1.1.3
25      20      9.9.9.3/32      0
        Et1/0    30.1.1.3
26      21      1.1.1.6/32      0
        Et1/0    30.1.1.3
27      24      1.1.1.2/32      0
        Et1/0    30.1.1.3
        28      1.1.1.2/32      0
        Et1/1    90.1.1.5
28      18      1.1.1.7/32      0
        Et1/1    90.1.1.5
29      27      9.9.9.7/32      0
        Et1/1    90.1.1.5
30      Pop Label 55.1.1.0/24    0
        Et1/1    90.1.1.5
```

Local Label	Outgoing Label	Prefix or Tunnel Id	Bytes Switched	Label	Outgoing interface	Next Hop
31	Pop Label	19.1.1.0/24	0		Et1/0	30.1.1.3
32	Pop Label	100.1.1.0/24	0		Et1/0	30.1.1.3
33	Pop Label	100.100.100.0/24	0		Et1/0	30.1.1.3
34	Pop Label	110.1.1.0/24	0		Et1/0	30.1.1.3
35	28	10.1.1.0/24	0		Et1/0	30.1.1.3
36	29	101.101.101.0/24	0		Et1/0	30.1.1.3
37	29	65.1.1.0/24	0		Et1/1	90.1.1.5
38	33	104.104.104.0/24	0		Et1/0	30.1.1.3
	39	104.104.104.0/24	0		Et1/1	90.1.1.5
39	30	103.103.103.0/24	0		Et1/1	90.1.1.5
16005	Pop Label	1.1.1.5/32	1782		Et1/1	90.1.1.5
16006	16006	1.1.1.6/32	0		Et1/0	30.1.1.3
16007	16007	1.1.1.7/32	0		Et1/1	90.1.1.5
16017	16017	17.17.17.17/32	0		Et1/0	30.1.1.3
16250	16250	9.9.9.3/32	0		Et1/0	30.1.1.3
16252	16252	9.9.9.7/32	0		Et1/1	90.1.1.5
16253	Pop Label	9.9.9.4/32	0		Et0/2	102.102.102.2
17000	17000	16.16.16.16/32	0		Et1/0	30.1.1.3
17002	17002	1.1.1.2/32	0		Et1/0	30.1.1.3
	17002	1.1.1.2/32	0		Et1/1	90.1.1.5

```
Device#ping mpls nil-fec labels 16005,16007 output interface ethernet 1/0 nexthop 30.1.1.4
repeat 1
Sending 1, 72-byte MPLS Echos with Nil FEC labels 16005,16007,
timeout is 2 seconds, send interval is 0 msec:
```

```
Codes: '!' - success, 'Q' - request not sent, '.' - timeout,
'L' - labeled output interface, 'B' - unlabeled output interface,
'D' - DS Map mismatch, 'F' - no FEC mapping, 'f' - FEC mismatch,
'M' - malformed request, 'm' - unsupported tlvs, 'N' - no label entry,
'P' - no rx intf label prot, 'p' - premature termination of LSP,
'R' - transit router, 'I' - unknown upstream index,
'l' - Label switched with FEC change, 'd' - see DDMAP for return code,
'X' - unknown return code, 'x' - return code 0
```

```
Type escape sequence to abort.
```

```
!
Success rate is 100 percent (1/1), round-trip min/avg/max = 1/1/1 ms
Total Time Elapsed 0 ms
```

```
Device#traceroute mpls nil-fec labels 16005,16007 output interface ethernet 1/0 nexthop
30.1.1.4
Tracing MPLS Label Switched Path with Nil FEC labels 16005,16007, timeout is 2 seconds
```

```
Codes: '!' - success, 'Q' - request not sent, '.' - timeout,
'L' - labeled output interface, 'B' - unlabeled output interface,
'D' - DS Map mismatch, 'F' - no FEC mapping, 'f' - FEC mismatch,
'M' - malformed request, 'm' - unsupported tlvs, 'N' - no label entry,
'P' - no rx intf label prot, 'p' - premature termination of LSP,
'R' - transit router, 'I' - unknown upstream index,
'l' - Label switched with FEC change, 'd' - see DDMAP for return code,
'X' - unknown return code, 'x' - return code 0
```

```
Type escape sequence to abort.
```

```
0 30.1.1.3 MRU 1500 [Labels: 16005/16007/explicit-null Exp: 0/0/0]
L 1 30.1.1.4 MRU 1500 [Labels: implicit-null/16007/explicit-null Exp: 0/0/0] 1 ms
L 2 90.1.1.5 MRU 1500 [Labels: implicit-null/explicit-null Exp: 0/0] 1 ms
! 3 55.1.1.7 1 ms
```

Path Validation in Segment Routing Network

The MPLS OAM mechanisms help with fault detection and isolation for a MPLS data-plane path by the use of various target FEC stack sub-TLVs that are carried in MPLS echo request packets and used by the responder for FEC validation. While it is obvious that new sub-TLVs need to be assigned for segment routing, the unique nature of the segment routing architecture raises the need for additional operational considerations for path validation.

The forwarding semantic of Adjacency Segment ID is to pop the Segment ID and send the packet to a specific neighbor over a specific link. A malfunctioning node may forward packets using Adjacency Segment ID to an incorrect neighbor or over an incorrect link. The exposed Segment ID (of an incorrectly forwarded Adjacency Segment ID) might still allow such packet to reach the intended destination, although the intended strict traversal has been broken. MPLS traceroute may help with detecting such a deviation.

The format of the following Segment ID sub-TLVs follows the philosophy of Target FEC Stack TLV carrying FECs corresponding to each label in the label stack. This allows LSP ping/traceroute operations to function when Target FEC Stack TLV contains more FECs than received label stack at responder nodes. Three new sub-TLVs are defined for Target FEC Stack TLVs (Type 1), Reverse-Path Target FEC Stack TLV (Type 16) and Reply Path TLV (Type 21).

sub-Type	Value Field
34	IPv4 IGP-Prefix Segment ID
35	IPv6 IGP-Prefix Segment ID
36	IGP-Adjacency Segment ID

MPLS Ping and Traceroute for IGP Prefix-SID FEC Type

MPLS ping and traceroute operations for prefix SID are supported for various IGP scenarios, for example:

- Within an IS-IS level or OSPF area
- Across IS-IS levels or OSPF areas
- Route redistribution from IS-IS to OSPF and from OSPF to IS-IS

The MPLS LSP Ping feature is used to check the connectivity between ingress Label Switch Routers (LSRs) and egress LSRs along an LSP. MPLS LSP ping uses MPLS echo request and reply messages, similar to Internet Control Message Protocol (ICMP) echo request and reply messages, to validate an LSP. The destination IP address of the MPLS echo request packet is different from the address used to select the label stack.

The MPLS LSP Traceroute feature is used to isolate the failure point of an LSP. It is used for hop-by-hop fault localization and path tracing. The MPLS LSP Traceroute feature relies on the expiration of the Time to Live (TTL) value of the packet that carries the echo request. When the MPLS echo request message hits a transit node, it checks the TTL value and if it is expired, the packet is passed to the control plane, else the message is forwarded. If the echo message is passed to the control plane, a reply message is generated based on the contents of the request message.

The MPLS LSP Tree Trace (traceroute multipath) operation is also supported for IGP Prefix SID. MPLS LSP Tree Trace provides the means to discover all possible equal-cost multipath (ECMP) routing paths of an LSP to reach a destination Prefix SID. It uses multipath data encoded in echo request packets to query for the load-balancing information that may allow the originator to exercise each ECMP. When the packet TTL expires at the responding node, the node returns the list of downstream paths, as well as the multipath

information that can lead the operator to exercise each path in the MPLS echo reply. This operation is performed repeatedly for each hop of each path with increasing TTL values until all ECMP are discovered and validated.

MPLS echo request packets carry Target FEC Stack sub-TLVs. The Target FEC sub-TLVs are used by the responder for FEC validation. The IGPIPv4 prefix sub-TLV has been added to the Target FEC Stack sub-TLV. The IGP IPv4 prefix sub-TLV contains the prefix SID, the prefix length, and the protocol (IS-IS or OSPF).

The network node which advertised the Node Segment ID is responsible for generating a FEC Stack Change sub-TLV with pop operation type for Node Segment ID, regardless of whether penultimate hop popping (PHP) is enabled or not.

The format is as below for IPv4 IGP-Prefix Segment ID:

```

0                               1                               2                               3
0 1 2 3 4 5 6 7 8 9 0 1 2 3 4 5 6 7 8 9 0 1 2 3 4 5 6 7 8 9 0 1
+-----+-----+-----+-----+-----+-----+-----+-----+
|                               IPv4 Prefix                               |
+-----+-----+-----+-----+-----+-----+-----+-----+
|Prefix Length |   Protocol   |           Reserved           |
+-----+-----+-----+-----+-----+-----+-----+

```

The format is as below for IPv6 IGP-Prefix Segment ID:

```

0                               1                               2                               3
0 1 2 3 4 5 6 7 8 9 0 1 2 3 4 5 6 7 8 9 0 1 2 3 4 5 6 7 8 9 0 1
+-----+-----+-----+-----+-----+-----+-----+-----+
|                               IPv6 Prefix                               |
+-----+-----+-----+-----+-----+-----+-----+-----+
|Prefix Length |   Protocol   |           Reserved           |
+-----+-----+-----+-----+-----+-----+-----+

```

MPLS Ping and Traceroute for IGP-Adjacency Segment ID

The network node that is immediate downstream of the node which advertised the Adjacency Segment ID is responsible for generating FEC Stack Change sub-TLV for "POP" operation for Adjacency Segment ID.

The format is as below for IGP-adjacency SID:

```

0                               1                               2                               3
0 1 2 3 4 5 6 7 8 9 0 1 2 3 4 5 6 7 8 9 0 1 2 3 4 5 6 7 8 9 0 1
+-----+-----+-----+-----+-----+-----+-----+-----+
|  Adj. Type  |   Protocol   |           Reserved           |
+-----+-----+-----+-----+-----+-----+-----+
|                               Local Interface ID (4 or 16 octets)       |
+-----+-----+-----+-----+-----+-----+-----+
|                               Remote Interface ID (4 or 16 octets)     |
+-----+-----+-----+-----+-----+-----+-----+
~
|                               Advertising Node Identifier (4 or 6 octets) |
+-----+-----+-----+-----+-----+-----+-----+
~
|                               Receiving Node Identifier (4 or 6 octets)  |
+-----+-----+-----+-----+-----+-----+-----+

```

Configuring Segment Routing MPLS Traffic Engineering for MPLS Ping and Traceroute

```

ping mpls traffic-eng tunnel <tun-id>
[repeat <count>]
[size <size> | sweep <min_size> <max_size> <increment>]
[timeout <seconds>]
[interval <milliseconds>]
[destination <addr_start> [<addr_end> [<addr_incr_mask> | <addr_incr>]]]
[source <addr>]
[exp <exp-value>]
[pad <pattern>]
[ttl <ttl>]
[reply [mode [ipv4 | router-alert | no-reply]]]
[dscp <dscp-bits>]
[pad-tlv]]
[verbose]
[output {interface <tx-interface>} [nexthop <nexthop ip addr>]]
[{dsmap | ddmap [l2ecmp]} [hashkey {none | {ipv4 | ipv4-label-set {bitmap <bitmap_size>}}}]

traceroute mpls [multipath] traffic-eng <tunnel-interface>
[timeout <seconds>]
[destination <addr_start> [<addr_end> [<addr_incr_mask> | <addr_incr>]]]
[source <addr> ]
[exp <exp-value>]
[ttl <ttl-max>]
[reply [mode [ipv4 | router-alert | no-reply]]]
[pad-tlv]]
[output {interface <tx-interface>} [nexthop <nexthop ip addr>]]
[flags {fec | ttl}]
[hashkey ipv4 | ipv4-label-set {bitmap <bitmap_size>}]

```

Configuring Segment Routing MPLS IGP for MPLS Ping and Traceroute

```

ping mpls ipv4 <prefix/prefix_length> [fec-type [ldp | bgp | generic | isis | ospf]]
[sr-path-type [ip | sid | strict-sid]]
[destination <addr_start> [<addr_end> [<addr_incr_mask> | <addr_incr>]]]
[source <addr>]
[exp <exp-value>]
[pad <pattern>]
[ttl <ttl>]
[reply [mode [ipv4 | router-alert | no-reply]]]
[dscp <dscp-bits>]
[pad-tlv]]
[verbose]
[output {interface <tx-interface>} [nexthop <nexthop ip addr>]]
[{dsmap | ddmap [l2ecmp]} [hashkey {none | {ipv4 | ipv4-label-set {bitmap <bitmap_size>}}}]

traceroute mpls [multipath] ipv4 <prefix/prefix_length> [fec-type [ldp | bgp | generic |
isis | ospf]] [sr-path-type [ip | sid | strict-sid]]
[timeout <seconds>]
[destination <addr_start> [<addr_end> [<addr_incr_mask> | <addr_incr>]]]
[source <addr> ]

```

```
[exp <exp-value>]
[ttl <ttl-max>]
[reply [mode [ipv4 | router-alert | no-reply]]]
[pad-tlv]
[output {interface <tx-interface>} [nexthop <nexthop ip addr>]]
[flags {fec | ttl}]
[hashkey ipv4 | ipv4-label-set {bitmap <bitmap_size>}]
```

- fec-type: IPv4 Target FEC type, use head end auto detected FEC type by default.
- sr-path-type: Segment routing path type selection algorithm. Use IP imposition path, when option is specified.

Verifying Segment Routing OAM Using Cisco IOS CLI

This section provides a summary on the main Command Line Interfaces (CLIs) that are needed to verify segment routing OAM feature(s). Ping and traceroute commands illustrate the operation and output over IGP (OSPF SR), ISIS SR, and SR-TE. Change the actual tunnel numbers and IP addresses based on the actual values needed and enabled in the configurations.

Verifying Segment Routing Traffic Engineering OAM Operations

The following **traceroute** command displays SR-TE OAM operations:

```
SR_Device#traceroute mpls traffic-eng tunnel 1005 verbose
Tracing MPLS TE Label Switched Path on Tunnel1005 Active LSP, timeout is 2 seconds

Codes: '!' - success, 'Q' - request not sent, '.' - timeout,
       'L' - labeled output interface, 'B' - unlabeled output interface,
       'D' - DS Map mismatch, 'F' - no FEC mapping, 'f' - FEC mismatch,
       'M' - malformed request, 'm' - unsupported tlvs, 'N' - no label entry,
       'P' - no rx intf label prot, 'p' - premature termination of LSP,
       'R' - transit router, 'I' - unknown upstream index,
       'l' - Label switched with FEC change, 'd' - see DDMAP for return code,
       'X' - unknown return code, 'x' - return code 0

Type escape sequence to abort.
 0 100.103.1.1 100.103.1.2 MRU 1500 [Labels: implicit-null/22/22 Exp: 0/0/0], RSC 0
 1 1 100.103.1.2 103.104.1.2 MRU 1500 [Labels: implicit-null/22 Exp: 0/0] 3 ms, ret code 15,
   RSC 0
 1 2 103.104.1.2 104.105.1.2 MRU 1500 [Labels: implicit-null Exp: 0] 3 ms, ret code 15, RSC
   0
 ! 3 104.105.1.2 2 ms, ret code 3
```

```
SR_Device#traceroute mpls ipv4 55.5.5.5/32 output interface tunnell force-explicit-null
Tracing MPLS Label Switched Path to 55.5.5.5/32, timeout is 2 seconds
```

```
Codes: '!' - success, 'Q' - request not sent, '.' - timeout,
       'L' - labeled output interface, 'B' - unlabeled output interface,
       'D' - DS Map mismatch, 'F' - no FEC mapping, 'f' - FEC mismatch,
       'M' - malformed request, 'm' - unsupported tlvs, 'N' - no label entry,
       'P' - no rx intf label prot, 'p' - premature termination of LSP,
       'R' - transit router, 'I' - unknown upstream index,
       'l' - Label switched with FEC change, 'd' - see DDMAP for return code,
       'X' - unknown return code, 'x' - return code 0
```

```
Type escape sequence to abort.
 0 100.101.1.1 MRU 1500 [Labels: 26000/explicit-null Exp: 0/0]
L 1 100.101.1.2 MRU 1500 [Labels: 26000/explicit-null Exp: 0/0] 3 ms
L 2 101.104.1.2 MRU 1500 [Labels: implicit-null/explicit-null Exp: 0/0] 6 ms
! 3 104.105.1.2 3 ms
```

The following **tree traceroute** command displays SR-TE OAM operations in ECMP scenarios:

```
SR_Device#traceroute mpls multi traffic-eng tunnel 1 verbose
Starting LSP Multipath Traceroute for Tunnell
Codes: '!' - success, 'Q' - request not sent, '.' - timeout,
'L' - labeled output interface, 'B' - unlabeled output interface,
'D' - DS Map mismatch, 'F' - no FEC mapping, 'f' - FEC mismatch,
'M' - malformed request, 'm' - unsupported tlvs, 'N' - no label entry,
'P' - no rx intf label prot, 'p' - premature termination of LSP,
'R' - transit router, 'I' - unknown upstream index,
'l' - Label switched with FEC change, 'd' - see DDMAP for return code,
'X' - unknown return code, 'x' - return code 0
Type escape sequence to abort.
LL!
Path 0 found,
output interface Gi2 nexthop 100.101.1.2
source 50.0.0.0 destination 127.0.0.0
0 100.101.1.1 100.101.1.2 MRU 1500 [Labels: 26000 Exp: 0] multipaths 0
L 1 100.101.1.2 101.102.1.2 MRU 1500 [Labels: 26000 Exp: 0] ret code 8, RSC 0 multipaths 2
L 2 101.102.1.2 102.105.1.2 MRU 1500 [Labels: implicit-null Exp: 0] ret code 8, RSC 0
multipaths 1
! 3 102.105.1.2, ret code 3 multipaths 0
L!
Path 1 found,
output interface Gi2 nexthop 100.101.1.2
source 50.0.0.0 destination 127.0.0.1
0 100.101.1.1 100.101.1.2 MRU 1500 [Labels: 26000 Exp: 0] multipaths 0
L 1 100.101.1.2 101.104.1.2 MRU 1500 [Labels: 26000 Exp: 0] ret code 8, RSC 0 multipaths 2
L 2 101.104.1.2 104.105.1.2 MRU 1500 [Labels: implicit-null Exp: 0] ret code 8, RSC 0
multipaths 1
! 3 104.105.1.2, ret code 3 multipaths 0
LL!
Path 2 found,
output interface Gi3 nexthop 100.103.1.2
source 50.0.0.0 destination 127.0.0.0
0 100.103.1.1 100.103.1.2 MRU 1500 [Labels: 26000 Exp: 0] multipaths 0
L 1 100.103.1.2 102.103.1.1 MRU 1500 [Labels: 26000 Exp: 0] ret code 8, RSC 0 multipaths 2
L 2 102.103.1.1 102.105.1.2 MRU 1500 [Labels: implicit-null Exp: 0] ret code 8, RSC 0
multipaths 1
! 3 102.105.1.2, ret code 3 multipaths 0
L!
Path 3 found,
output interface Gi3 nexthop 100.103.1.2
source 50.0.0.0 destination 127.0.0.1
0 100.103.1.1 100.103.1.2 MRU 1500 [Labels: 26000 Exp: 0] multipaths 0
L 1 100.103.1.2 103.104.1.2 MRU 1500 [Labels: 26000 Exp: 0] ret code 8, RSC 0 multipaths 2
L 2 103.104.1.2 104.105.1.2 MRU 1500 [Labels: implicit-null Exp: 0] ret code 8, RSC 0
multipaths 1
! 3 104.105.1.2, ret code 3 multipaths 0
Paths (found/broken/unexplored) (4/0/0)
Echo Request (sent/fail) (10/0)
Echo Reply (received/timeout)
```

Verifying Segment Routing OAM OSPF Using CLI

You need to specify the fec type specifically when performing the ping or traceroute for the prefixes which span across IGP boundaries. For example, when a prefix is redistributed to OSPF from ISIS domain then specify the fec type ISIS. When the ping or traceroute is performed within the IGP domain then you do not need to mention fec type explicitly. Provide generic fec type generic when the user does not know the IGP protocol on the destination node. When SR path type is not mentioned, default SR path type IP is taken.

The following topology is an example of a SR path type:

Figure 19:

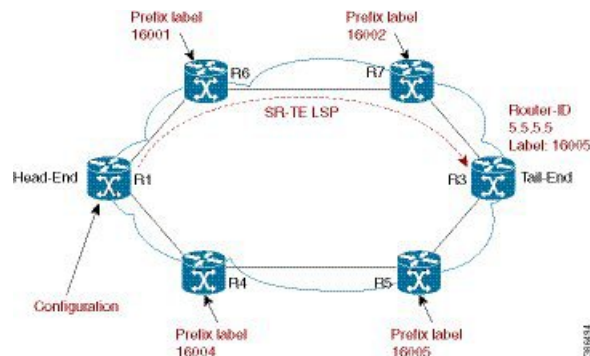

The following ping commands are used to illustrate SR OAM when the underlying network is OSPF.

As per the above topology example, at the head end R1, SR-TE tunnel is created with the destination as R3. The SR-TE tunnel is created with explicit path option to pass through R6 and R7. The SR-TE path is, R1---R6---R7---R3, when the IP traffic ingress at R1.

```
Device#ping mpls ipv4 4.4.4.4/32 fec-type ospf sr-path-type ip verbose
Sending 2, 72-byte MPLS Echos to IGP Prefix SID(OSPF) FEC 5.5.5.5/32,
  timeout is 2 seconds, send interval is 0 msec:
Select segment routing IP imposition path.
```

```
Codes: '!' - success, 'Q' - request not sent, '.' - timeout,
'L' - labeled output interface, 'B' - unlabeled output interface,
'D' - DS Map mismatch, 'F' - no FEC mapping, 'f' - FEC mismatch,
'M' - malformed request, 'm' - unsupported tlvs, 'N' - no label entry,
'P' - no rx intf label prot, 'p' - premature termination of LSP,
'R' - transit router, 'I' - unknown upstream index,
'l' - Label switched with FEC change, 'd' - see DDMAP for return code,
'X' - unknown return code, 'x' - return code 0
```

Type escape sequence to abort.

```
! size 72, reply addr 2.4.0.4, return code 3
! size 72, reply addr 2.4.0.4, return code 3
```

```
Success rate is 100 percent (2/2), round-trip min/avg/max = 1/1/1 ms
Total Time Elapsed 4 ms
```

In the same topology, when the incoming traffic is labeled traffic, then the following two ECMP paths are chosen for the forwarding:

- R1---R6---R7---R3
- R1---R4---R5---R3



Note Using the multipath option, both the paths can be traced for the destination.

```
Device# ping mpls ipv4 4.4.4.4/32 fec-type ospf sr-path-type sid verbose
Sending 1, 72-byte MPLS Echos to IGP Prefix SID(OSPF) FEC 5.5.5.5/32,
    timeout is 2 seconds, send interval is 0 msec:
Select segment routing prefix SID path.
```

```
Codes: '!' - success, 'Q' - request not sent, '.' - timeout,
'L' - labeled output interface, 'B' - unlabeled output interface,
'D' - DS Map mismatch, 'F' - no FEC mapping, 'f' - FEC mismatch,
'M' - malformed request, 'm' - unsupported tlvs, 'N' - no label entry,
'P' - no rx intf label prot, 'p' - premature termination of LSP,
'R' - transit router, 'I' - unknown upstream index,
'l' - Label switched with FEC change, 'd' - see DDMAP for return code,
'X' - unknown return code, 'x' - return code 0
```

```
Type escape sequence to abort.
!      size 72, reply addr 2.4.0.4, return code 3
```

```
Success rate is 100 percent (1/1), round-trip min/avg/max = 1/1/1 ms
Total Time Elapsed 3 ms
```

The following **traceroute** commands display SR OAM when the underlying network is OSPF.

To trace the IP route path when the incoming traffic to R1 is the native IP, the below command is used at the end of R1.

```
Device#traceroute mpls ipv4 4.4.4.4/32 fec-type ospf sr-path-type ip verbose
Tracing MPLS Label Switched Path to IGP Prefix SID(OSPF) FEC 4.4.4.4/32, timeout is 2 seconds
Select segment routing IP imposition path.
```

```
Codes: '!' - success, 'Q' - request not sent, '.' - timeout,
'L' - labeled output interface, 'B' - unlabeled output interface,
'D' - DS Map mismatch, 'F' - no FEC mapping, 'f' - FEC mismatch,
'M' - malformed request, 'm' - unsupported tlvs, 'N' - no label entry,
'P' - no rx intf label prot, 'p' - premature termination of LSP,
'R' - transit router, 'I' - unknown upstream index,
'l' - Label switched with FEC change, 'd' - see DDMAP for return code,
'X' - unknown return code, 'x' - return code 0
```

```
Type escape sequence to abort.
0 1.2.0.1 1.2.0.2 MRU 1500 [Labels: 16002/16005 Exp: 0/0], RSC 0
```

```
L 1 1.2.0.2 3.3.3.3 MRU 1500 [Labels: 16005 Exp: 0] 2 ms, ret code 8, RSC 0
L 2 3.3.3.3 3.4.0.4 MRU 1500 [Labels: implicit-null Exp: 0] 1 ms, ret code 8, RSC 0
! 3 3.4.0.4 1 ms, ret code 3
```

```
Device#traceroute mpls ipv4 4.4.4.4/32 fec-type ospf sr-path-type sid verbose
```

```
Device#traceroute mpls multipath ipv4 4.4.4.4/32 fec-type ospf sr-path-type ip verbose
Type escape sequence to abort.
LL!
Path 0 found,
output interface Et0/1 nexthop 1.2.0.2 //path R1-R6-R7-R3
source 1.1.1.1 destination 127.0.0.0
0 1.2.0.1 1.2.0.2 MRU 1500 [Labels: 16666 Exp: 0] multipaths 0
L 1 1.2.0.2 2.4.0.4 MRU 1500 [Labels: 16666 Exp: 0] ret code 8, RSC 0 multipaths 1
L 2 2.4.0.4 4.6.0.6 MRU 1500 [Labels: implicit-null Exp: 0] ret code 8, RSC 0 multipaths 1
```

```

! 3 4.6.0.6, ret code 3 multipaths 0
LL!
Path 1 found,
  output interface Et0/2 nexthop 1.3.0.3 //path R1-R4-R5-R3
  source 1.1.1.1 destination 127.0.0.0
    0 1.3.0.1 1.3.0.3 MRU 1500 [Labels: 16666 Exp: 0] multipaths 0
L 1 1.3.0.3 3.4.0.4 MRU 1500 [Labels: 16666 Exp: 0] ret code 8, RSC 0 multipaths 1
L 2 3.4.0.4 4.6.0.6 MRU 1500 [Labels: implicit-null Exp: 0] ret code 8, RSC 0 multipaths 1
! 3 4.6.0.6, ret code 3 multipaths 0

Paths (found/broken/unexplored) (2/0/0)
Echo Request (sent/fail) (6/0)
Echo Reply (received/timeout) (6/0)
Total Time Elapsed 23 ms

Device#traceroute mpls multipath ipv4 4.4.4.4/32 fec-type ospf sr-path-type sid verbose

```

Verifying Segment Routing OAM IS-IS Using CLI

The following **ping** commands are used to display SR OAM when the underlying network is IS-IS:

```

Device# ping mpls ipv4 4.4.4.4/32 fec-type isis sr-path-type ip verbose

Device# ping mpls ipv4 4.4.4.4/32 fec-type isis sr-path-type sid verbose

Device# ping mpls ipv4 4.4.4.4/32 fec-type isis sr-path-type strict-sid verbose

Device# ping mpls ipv4 4.4.4.4/32 sr-path-type ip verbose

Device# ping mpls ipv4 4.4.4.4/32 sr-path-type sid verbose

Device# ping mpls ipv4 4.4.4.4/32 sr-path-type strict-sid verbose

```

The following **traceroute** commands display SR OAM when the underlying network is IS-IS. When multipath option is enabled, all ECMP paths are returned.

```

Device# traceroute mpls ipv4 4.4.4.4/32 fec-type isis sr-path-type ip verbose

Device# traceroute mpls ipv4 4.4.4.4/32 fec-type isis sr-path-type sid verbose

Device# traceroute mpls ipv4 4.4.4.4/32 fec-type isis sr-path-type strict-sid verbose

Device# traceroute mpls multipath ipv4 4.4.4.4/32 fec-type isis sr-path-type ip verbose

Device# traceroute mpls multipath ipv4 4.4.4.4/32 fec-type isis sr-path-type sid verbose

Device# traceroute mpls multipath ipv4 4.4.4.4/32 fec-type isis sr-path-type strict-sid verbose

```

Verifying MPLS Ping and Traceroute for IGP Segment ID

Use the following command SR network with IGP validation:

```
ping|traceroute mpls [multipath] ipv4 <prefix> [fec-type bgp |generic|ldp|isis|ospf]
[sr-path-type ip|sid|strict-sid]
```

Use the following command to verify MPLS TE tunnel OAM when the tunnel LSP is a SR-TE LSP.

```
ping|traceroute mpls traffic-eng tunnel <tunnelid>
```

Additional References for Segment Routing OAM Support

Related Documents

Related Topic	Document Title
Cisco IOS commands	Cisco IOS Master Commands List, All Releases

Feature Information for Segment Routing OAM Support

The following table provides release information about the feature or features described in this module. This table lists only the software release that introduced support for a given feature in a given software release train. Unless noted otherwise, subsequent releases of that software release train also support that feature.

Use Cisco Feature Navigator to find information about platform support and Cisco software image support. To access Cisco Feature Navigator, go to www.cisco.com/go/cfn. An account on Cisco.com is not required.

Table 14: Feature Information for Segment Routing OAM Support

Feature Name	Releases	Feature Information
Segment Routing OAM Support	Cisco IOS XE Release 3.17 S	The Segment Routing OAM feature provides support for Nil-FEC (forwarding equivalence classes) LSP Ping and Traceroute functionality. The Nil-FEC LSP ping and traceroute operation are simply extension of regular MPLS ping and trace route.

Feature Name	Releases	Feature Information
Verifying Segment Routing OAM Using CLI	Cisco IOS XE Everest 16.6.1 Cisco IOS XE Fuji 16.7.1	<p>This feature provides the Command Line Interfaces (CLIs) that are needed to verify segment routing OAM feature(s). Ping and traceroute commands display the operation and output over IGP (OSPF SR, IS-IS SR), and SR-TE.</p> <p>The following commands were introduced or modified:</p> <p>ping mpls ipv4 4.4.4.4/32 fec-type isis sr-path-type ip verbose, ping mpls ipv4 4.4.4.4/32 fec-type isis sr-path-type sid verbose, ping mpls ipv4 4.4.4.4/32 fec-type isis sr-path-type strict-sid verbose, ping mpls ipv4 4.4.4.4/32 fec-type ospf sr-path-type ip verbose, ping mpls ipv4 4.4.4.4/32 fec-type ospf sr-path-type sid verbose, traceroute mpls traffic-eng tunnel 1005 verbose, traceroute mpls ipv4 55.5.5.5/32 output interface tunnel1 force-explicit-null, traceroute mpls ipv4 4.4.4.4/32 fec-type ospf sr-path-type ip verbose, traceroute mpls ipv4 4.4.4.4/32 fec-type ospf sr-path-type sid verbose, traceroute mpls multipath ipv4 4.4.4.4/32 fec-type ospf sr-path-type sid verbose.</p> <p>In Cisco IOS XE Fuji 16.7.1, this feature is supported on Cisco 4000 Series Integrated Service Routers.</p>



CHAPTER 16

Using Seamless BFD with Segment Routing

The Segment Routing TE feature provides information support for Seamless Bidirectional Forwarding Detection (S-BFD).

- [Restrictions For Using Seamless BFD with Segment Routing, on page 169](#)
- [Information About Seamless BFD with Segment Routing, on page 169](#)
- [How to Configure Seamless BFD with Segment Routing, on page 171](#)
- [Additional References for Seamless BFD with Segment Routing, on page 173](#)
- [Feature Information for Seamless BFD with Segment Routing, on page 173](#)

Restrictions For Using Seamless BFD with Segment Routing

Restrictions for Seamless-Bidirectional Forwarding (S-BFD)

- Seamless-Bidirectional Forwarding (S-BFD) supporting IPv4 only for segment routing traffic engineering (SR-TE). IPv6 is not supported.
- Single hop S-BFD session is only supported.
- RSVP-TE does not support S-BFD.

Information About Seamless BFD with Segment Routing

Bidirectional Forwarding Detection and Seamless-Bidirectional Forwarding Detection (S-BFD)

Bidirectional Forwarding Detection (BFD) is a detection protocol designed to provide fast forwarding path failure detection times for all media types, encapsulations, topologies, and routing protocols.

BFD provides a consistent failure detection method for network administrators, in addition to fast forwarding path failure detection. Because the network administrator can use BFD to detect forwarding path failures at a uniform rate, rather than the variable rates for different routing protocol hello mechanisms, network profiling and planning will be easier, and reconvergence time will be consistent and predictable.

Seamless Bidirectional Forwarding Detection (S-BFD), is a simplified mechanism for using BFD with a large proportion of negotiation aspects eliminated, thus providing benefits such as quick provisioning, as well as improved control and flexibility for network nodes initiating path monitoring.

If SBFD session fails, S-BFD brings down the SR-TE session. S-BFD also provides faster session bring up due to less control packets exchange. S-BFD is associated with SR-TE to bring a session up quickly. The BFD state is only maintained at head end thereby reducing overhead.

S-BFD implements support for RFC 7880, RFC 7881 on segment routing.

Initiators and Reflectors

SBFD runs in an asymmetric behavior, using initiators and reflectors. The following figure illustrates the roles of an SBFD initiator and reflector.

Figure 20: SBFD Initiator and Reflector

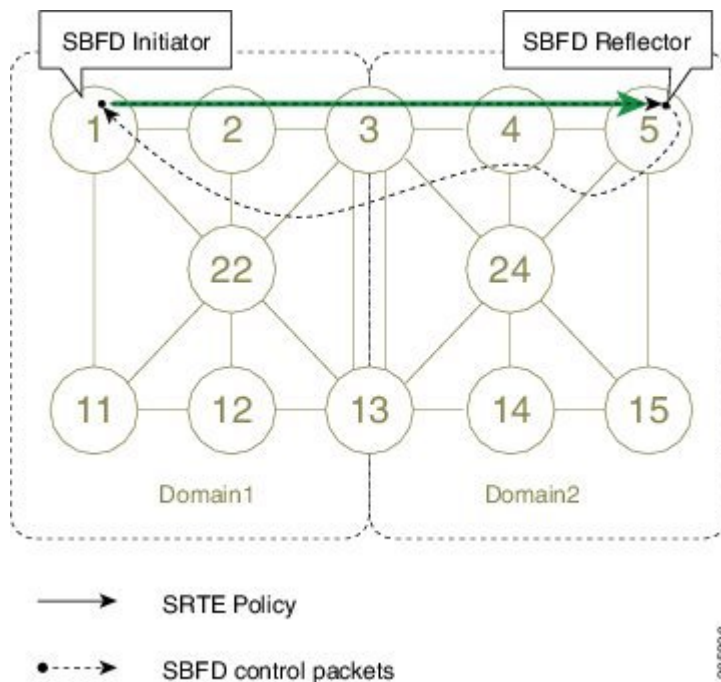

The initiator is an SBFD session on a network node that performs a continuity test to a remote entity by sending SBFD packets. The initiator injects the SBFD packets into the segment-routing traffic-engineering (SRTE) policy. The initiator triggers the SBFD session and maintains the BFD state and client context.

The reflector is an SBFD session on a network node that listens for incoming SBFD control packets to local entities and generates response SBFD control packets. The reflector is stateless and only reflects the SBFD packets back to the initiator.

A node can be both an initiator and a reflector, thereby allowing you to configure different SBFD sessions.

S-BFD can be enabled and supported for SR-TE IPv4, but IPv6 is not supported. For SR-TE, S-BFD control packets are label switched in forward and reverse direction. For S-BFD, the tail end is the reflector node. Other nodes cannot be a reflector. When using S-BFD with SR-TE, if the forward and return directions are label switched paths, S-BFD need not be configured on the reflector node.

How to Configure Seamless BFD with Segment Routing

Configuring Seamless-Bidirectional Forwarding Detection (S-BFD) for Segment Routing

S-BFD must be enabled on both initiator and reflector nodes.



Note When using S-BFD with SR-TE, if the forward and return directions are label switched paths, S-BFD need not be configured on the reflector node.

Enabling Seamless Bidirectional Forwarding Detection (S-BFD) on the Reflector Node

Perform this task to configure S-BFD on the reflector node.

```
sbfd local-discriminator 55.55.55.55
```

Enabling Seamless Bidirectional Forwarding Detection (S-BFD) on the Initiator Node

Perform this task to configure S-BFD on the initiator node.

```
bfd-template single-hop ABC  
interval min-tx 300 min-rx 300 multiplier 10
```

Enabling Segment Routing Traffic Engineering Tunnel with Seamless-Bidirectional Forwarding (S-BFD)

```
interface Tunnel56  
ip unnumbered Loopback11  
tunnel mode mpls traffic-eng  
tunnel destination 55.55.55.55 */IP address of Reflector node/*  
tunnel mpls traffic-eng path-option 1 dynamic segment-routing  
tunnel mpls traffic-eng bfd sbfd ABC  
!  
end
```

Verifying S-BFD Configuration

SUMMARY STEPS

1. `show mpls traffic-engineering tunnel tunnel-name`
2. `show bfd neighbors`

DETAILED STEPS

- Step 1** `show mpls traffic-engineering tunnel tunnel-name`
Verifies the SR TE state and the S-BFD session state.

Example:

```

Router# sh mpls traffic-eng tunnel tunnel 56

Name: R1_t56                               (Tunnel56) Destination: 55.55.55.55
Status:
  Admin: up          Oper: up          Path: valid          Signalling: connected
  path option 1, (SEGMENT-ROUTING) type dynamic (Basis for Setup, path weight 12)

Config Parameters:
  Bandwidth: 0      kbps (Global)  Priority: 7 7  Affinity: 0x0/0xFFFF
  Metric Type: TE (default)
  Path Selection:
    Protection: any (default)
  Path-selection Tiebreaker:
    Global: not set  Tunnel Specific: not set  Effective: min-fill (default)
  Hop Limit: disabled
  Cost Limit: disabled
  Path-invalidation timeout: 10000 msec (default), Action: Tear
  AutoRoute: disabled LockDown: disabled Loadshare: 0 [0] bw-based
  auto-bw: disabled
  Fault-OAM: disabled, Wrap-Protection: disabled, Wrap-Capable: No

SBFD configured with template: ABC
  Session type: CURRENT          State: UP          SBFD handle: 0x3
  LSP ID: 1
  Last uptime duration: 3 minutes, 35 seconds
  Last downtime duration: --
  Active Path Option Parameters:
  State: dynamic path option 1 is active
  BandwidthOverride: disabled LockDown: disabled Verbatim: disabled
Node Hop Count: 2
  History:
  Tunnel:
    Time since created: 4 minutes, 3 seconds
    Number of LSP IDs (Tun_Instances) used: 1
  Current LSP: [ID: 1]
    Uptime: 3 minutes, 36 seconds
  Tun_Instance: 1
  Segment-Routing Path Info (isis level-2)
    Segment0[Link]: 12.12.12.1 - 12.12.12.2, Label: 48
    Segment1[Link]: 25.25.25.2 - 25.25.25.5, Label: 35 !

```

Step 2 **show bfd neighbors**

Verifies that BFD neighbors are established properly.

Example:

```

Router# show bfd neighbors

MPLS-TE SR Sessions
Interface      LSP ID(Type)          LD/RD          RH/RS          State
Tunnel56      1 (SR)                4097/926365495 Up              Up

```

Additional References for Seamless BFD with Segment Routing

Related Documents

Related Topic	Document Title
Cisco IOS commands	Cisco IOS Master Command List, All Releases
Segment Routing Traffic Engineering configuration	<i>Segment Routing -Traffic Engineering</i>

Table 15: Standards and RFC

Standard/RFC	Title
draft-akiya-bfd-seamless-base-03	Seamless Bidirectional Forwarding Detection (S-BFD)
draft-ietf-isis-segment-routing-extensions-07	IS-IS Extensions for Segment Routing
draft-ietf-spring-segment-routing-09	Segment Routing Architecture
RFC 7880	Seamless Bidirectional Forwarding Detection (S-BFD)
RFC 7881	Seamless Bidirectional Forwarding Detection (S-BFD) for IPv4, IPv6, and MPLS

Feature Information for Seamless BFD with Segment Routing

The following table provides release information about the feature or features described in this module. This table lists only the software release that introduced support for a given feature in a given software release train. Unless noted otherwise, subsequent releases of that software release train also support that feature.

Use Cisco Feature Navigator to find information about platform support and Cisco software image support. To access Cisco Feature Navigator, go to www.cisco.com/go/cfn. An account on Cisco.com is not required.

Table 16: Feature Information for Segment Routing TE Feature

Feature Name	Releases	Feature Information
Segment Routing TE Feature	Cisco IOS XE Denali 16.4.1	<p>Seamless Bidirectional Forwarding Detection (S-BFD), is a simplified mechanism for using BFD with a large proportion of negotiation aspects eliminated, thus providing benefits such as quick provisioning, as well as improved control and flexibility for network nodes initiating path monitoring.</p> <p>The following commands were introduced or modified: address-family ipv4 strict-spf, bfd-template single-hop, index range, sbfd local-discriminator, show bfd neighbor, show isis segment-routing, show mpls forwarding-table, show mpls traffic tunnel, show mpls traffic-engineering.</p>



CHAPTER 17

Using SSPF with Segment Routing

The Segment Routing TE feature provides information support for the Strict Shortest Path First (SPF).

- [Information About SSPF with Segment Routing, on page 175](#)
- [How to Configure SSPF with Segment Routing, on page 176](#)
- [Additional References for SSPF with Segment Routing, on page 178](#)
- [Feature Information for SSPF with Segment Routing, on page 178](#)

Information About SSPF with Segment Routing

Strict Shortest Path First

Segment Routing supports the following two algorithms:

- Algorithm 0: This is a Shortest Path First (SPF) algorithm based on link metric. This shortest path algorithm is computed by the Interior gateway protocol (IGP).
- Algorithm 1: This is a Strict Shortest Path First (SSPF) algorithm based on link metric. The algorithm 1 is identical to algorithm 0 but requires that all nodes along the path honor the SPF routing decision. Local policy does not alter the forwarding decision. For example, a packet is not forwarded through locally engineered path.

Different SIDs are associated with the same prefix for each algorithm.

Strict Shortest Path First is supported by default - but strict SIDs must be configured for at least one node address on each node supporting Segment Routing.

Approaches for Configure Strict Shortest Path First

The two approaches to configure Strict SFP are as follows:

- Using the **connect-prefix-sid-map** command—Strict SFP is configured globally on all the nodes. For a network to be Strict SFP-aware (that is, for ISIS to populate Strict SPF), all nodes must be configured with a local Strict SFP SID.
- Using Segment-routing Mapping Server—One node in the network is configured as mapping server and the remaining nodes act as a client.

How to Configure SSPF with Segment Routing

Configuring Strict Shortest Path First (SPF)

Enabling Strict Shortest Path First Using the connect-prefix-sid-map command

Enabling Shortest Path First on a Provider-Edge Device

When enabling Strict Shortest Path First using the **connect-prefix-sid-map** command, the Strict Shortest Path First (SPF) must be configured on the provider-edge device first and then on the node devices. The following is a sample configuration code snippet to enable Strict Shortest Path First on a provider-edge device.

```
segment-routing mpls
connected-prefix-sid-map
  address-family ipv4
    10.10.10.10/32 index 100 range 1
  exit-address-family
  address-family ipv4 strict-spf
    10.10.10.10/32 index 1000 range 1 -----configure strict SPF locally
  exit-address-family
```

Enabling Shortest Path First on a Node Device

The following is a sample configuration code snippet to enable Strict Shortest Path First on a node in the network and must be enabled on all nodes in a network.

```
segment-routing mpls
connected-prefix-sid-map
  address-family ipv4
    20.20.20.20/32 index 110 range 1
  exit-address-family
  address-family ipv4 strict-spf
    20.20.20.20/32 index 1100 range 1
  exit-address-family
```

Enabling Strict Shortest Path First Using Segment Routing Mapping Server

Configuring a Node as Segment Routing Mapping Server

The following is a sample configuration code snippet to configure a node as Segment Routing Mapping Server.

```
segment-routing mpls
mapping-server
  prefix-sid-map
    address-family ipv4
      10.10.10.10/32 index 100 range 1
      20.20.20.20/32 index 110 range 1
      30.30.30.30/32 index 120 range 1
      40.40.40.40/32 index 130 range 1
      50.50.50.50/32 index 140 range 1
    exit-address-family
  address-family ipv4 strict-spf
    10.10.10.10/32 index 1000 range 1
    20.20.20.20/32 index 1100 range 1
    30.30.30.30/32 index 1200 range 1
```

```

40.40.40.40/32 index 1300 range 1
50.50.50.50/32 index 1400 range 1
100.100.100.100/32 index 2000 range 1
exit-address-family

```

Configuring the Segment Routing Mapping Server to Advertise and Receive Local Prefixes

The following is a sample configuration code snippet to configure a Segment Routing Mapping Server to advertise and receive local prefixes.

```

router isis SR
segment-routing mpls
segment-routing prefix-sid-map advertise-local
segment-routing prefix-sid-map receive

```

Verifying ISIS Advertises the SIDs

The following is a sample configuration code snippet to verify that ISIS advertises the SIDs.

```

Router# show isis segment-routing prefix-sid-map advertise strict-spf
Tag SR:
IS-IS Level-1 advertise prefix-sid maps:
Prefix          SID Index  Range  Flags
10.10.10.10/32  1000      1
20.20.20.20/32  1100      1
30.30.30.30/32  1200      1
40.40.40.40/32  1300      1
50.50.50.50/32  1400      1
100.100.100.100/32  2000     1
Tag SR:
IS-IS Level-2 advertise prefix-sid maps:
Prefix          SID Index  Range  Flags
10.10.10.10/32  1000      1
20.20.20.20/32  1100      1
30.30.30.30/32  1200      1
40.40.40.40/32  1300      1
50.50.50.50/32  1400      1
100.100.100.100/32  2000     1

```

The following is a sample configuration code snippet to verify that a provider-edge device receives Strict Shortest Path First SID from SRMS Server.

```

Router# show isis segment-routing prefix-sid-map receive strict-spf
Tag SR:
IS-IS Level-1 receive prefix-sid maps:
Host          Prefix          SID Index  Range  Flags
P1            10.10.10.10/32  1000      1
              20.20.20.20/32  1100      1
              30.30.30.30/32  1200      1
              40.40.40.40/32  1300      1
              50.50.50.50/32  1400      1
              100.100.100.100/32  2000     1
Tag SR:
IS-IS Level-2 receive prefix-sid maps:
Host          Prefix          SID Index  Range  Flags
P1            10.10.10.10/32  1000      1
              20.20.20.20/32  1100      1
              30.30.30.30/32  1200      1
              40.40.40.40/32  1300      1
              50.50.50.50/32  1400      1
              100.100.100.100/32  2000     1

```

Additional References for SSPF with Segment Routing

Related Documents

Related Topic	Document Title
Cisco IOS commands	Cisco IOS Master Command List, All Releases
Segment Routing Traffic Engineering configuration	<i>Segment Routing -Traffic Engineering</i>

Feature Information for SSPF with Segment Routing

The following table provides release information about the feature or features described in this module. This table lists only the software release that introduced support for a given feature in a given software release train. Unless noted otherwise, subsequent releases of that software release train also support that feature.

Use Cisco Feature Navigator to find information about platform support and Cisco software image support. To access Cisco Feature Navigator, go to www.cisco.com/go/cfn. An account on Cisco.com is not required.

Table 17: Feature Information for Segment Routing SSPF Feature

Feature Name	Releases	Feature Information
Segment Routing TE Feature	Cisco IOS XE Denali 16.4.1	<p>The Segment Routing TE feature provides information support for the Strict Shortest Path First (SPF)..</p> <p>The following commands were introduced or modified: address-family ipv4 strict-spf, bfd-template single-hop, index range, sbfd local-discriminator, show bfd neighbor, show isis segment-routing, show mpls forwarding-table, show mpls traffic tunnel, show mpls traffic-engineering.</p>



CHAPTER 18

Dynamic PCC

The Stateful Path Computation Element Protocol (PCEP) enables a router to report and optionally delegate Label Switched Paths (LSPs) which is established using either Resource Reservation Protocol (RSVP) protocol or Segment Routing Traffic Engineering (SR-TE) to a stateful Path Computation Element (PCE).

An LSP delegated to a PCE can be updated by the PCE and a stateful PCE can compute and provide the path of an LSP to the Path Computation Client (PCC).

SR-TE and RSVP-TE LSPs require link-state routing protocols such as OSPF or ISIS to distribute and learn traffic engineering topology. A stateful PCE can learn the traffic engineering topology through BGP Link-State protocol. You can use the verbatim path option in the case when all or some of the intermediate nodes in a network do not support IGP extensions for TE.

- [Information About Dynamic PCC, on page 179](#)
- [How to Configure Dynamic PCC, on page 180](#)
- [Verifying Dynamic PCC, on page 181](#)
- [Verifying Verbatim Path Option With Dynamic PCC, on page 184](#)
- [Additional References for Dynamic PCC, on page 185](#)
- [Feature Information for Dynamic PCC, on page 185](#)

Information About Dynamic PCC

Path Computation Element Protocol Functions

A Path Computation Element Protocol (PCEP) session is a TCP session between a PCC and a PCE with protocol messages. The PCEP functions are verified based on the PCC functions. The configuration and verification show that the request is accepted and path computation is provided based on PCReq message from the client. The passive reporting enables a router to report a tunnel instead of delegating it to a PCE. The PCE is aware of the tunnel even though it cannot modify the tunnel.

PCEP functions are useful when a network has both router-controlled and PCE delegated tunnels. The PCE is aware of both the tunnels and can make an accurate decision on path computation.

Redundant Path Computation Elements

For redundancy it may be required to deploy redundant PCE servers. A PCC uses precedence to select stateful PCEs for delegating LSPs. Precedence can take any value between 0 and 255. The default precedence value

is 255. When there are multiple stateful PCEs with active PCEP session, PCC chooses the PCE with the lowest precedence value. In case where primary PCE server session goes down, PCC router re-delegates all tunnels to next available PCE server. You can use the following CLIs in the case of redundant PCEs:

```
R2(config)#mpls traffic-eng pcc peer 77.77.77.77 source 22.22.22.22 precedence 255
R2(config)#mpls traffic-eng pcc peer 88.88.88.88 source 22.22.22.22 precedence 100
!
```

In the above example PCE server with IP address 88.88.88.88 is the primary PCE server since it has lower precedence value.

How to Configure Dynamic PCC

Configuring Dynamic PCC Globally

Perform the following task to configure dynamic PCC globally

```
enable
configure terminal
mpls traffic-eng tunnels
mpls traffic-eng pcc peer 10.0.0.1 ----(10.0.0.1 is the PCE server address)
mpls traffic-eng pcc report-all
end
```



Note `mpls traffic-eng pcc report-all` is not mandatory for PCE/PCC basic operational delegated tunnels. It is required to report locally calculated LSPs to the PCE server.

Configuring Dynamic PCC on an Interface

Perform the following task to configure dynamic PCC on an interface

```
interface Tunnel1
ip unnumbered Loopback0
tunnel mode mpls traffic-eng
tunnel destination 7.7.7.7
tunnel mpls traffic-eng autoroute announce
tunnel mpls traffic-eng priority 5 5
tunnel mpls traffic-eng bandwidth 200
tunnel mpls traffic-eng path-option 10 dynamic pce segment-routing
end
```

Configuring Dynamic PCC With Verbatim Path Option

To enable Dynamic PCC with verbatim path option, use the following CLI under the SR-TE tunnel interface:

```
R1#
interface Tunnel2
```

```

ip unnumbered Loopback11
tunnel mode mpls traffic-eng
tunnel destination 66.66.66.66
tunnel mpls traffic-eng autoroute destination
tunnel mpls traffic-eng path-option 1 dynamic segment-routing pce verbatim

```

Verifying Dynamic PCC

The following sample output is from the **show pce client peer detail** command.

```

Device# show pce client peer detail

PCC's peer database:
-----

Peer address: 1.1.1.1
State up
Capabilities: Stateful, Update, Segment-Routing
PCEP has been up for: 23:44:58
PCEP session ID: local 1, remote: 0
Sending KA every 30 seconds
Minimum acceptable KA interval: 20 seconds
Peer timeout after 120 seconds
Statistics:
  Keepalive messages: rx      2798 tx      2112
  Request messages:   rx         0 tx        32
  Reply messages:    rx        32 tx         0
  Error messages:    rx         0 tx         0
  Open messages:     rx         1 tx         1
  Report messages:   rx         0 tx        57
  Update messages:   rx        72 tx         0

```

The following sample output is from the **show mpls traffic-eng tunnels tunnel 1** command which shows the LSP details.

```

Device# show mpls traffic-eng tunnels tunnel 1

Name: dl_t1                               (Tunnel1) Destination: 7.7.7.7
Status:
  Admin: up           Oper: up           Path: valid           Signalling: connected
  path option 10, (SEGMENT-ROUTING) (PCE) type dynamic (Basis for Setup, path weight 0)

Config Parameters:
  Bandwidth: 200      kbps (Global) Priority: 5 5 Affinity: 0x0/0xFFFF
  Metric Type: TE (default)
  Path Selection:
  Protection: any (default)
  Path-selection Tiebreaker:
  Global: not set Tunnel Specific: not set Effective: min-fill (default)
  Hop Limit: disabled
  Cost Limit: disabled
  Path-invalidation timeout: 10000 msec (default), Action: Tear
  AutoRoute: enabled LockDown: disabled Loadshare: 200 [10000000] bw-based
  auto-bw: disabled
  Fault-OAM: disabled, Wrap-Protection: disabled, Wrap-Capable: No
Active Path Option Parameters:
  State: dynamic path option 10 is active
  BandwidthOverride: disabled LockDown: disabled Verbatim: disabled

```

```

PCEP Info:
  Delegation state: Working: yes   Protect: no
  Current Path Info:
    Request status: processed
    Created via PCRep message from PCE server: 1.1.1.1
  Reported paths:
    Tunnel Name: csr551_t2001
    LSPs:
      LSP[0]:
        source 2.2.2.2, destination 7.7.7.7, tunnel ID 1, LSP ID 5
        State: Admin up, Operation active
        Setup type: SR
        Bandwidth: signaled 0
        LSP object:
          PLSP-ID 0x807D1, flags: D:0 S:0 R:0 A:1 O:2
        Reported path:
          Metric type: TE, Accumulated Metric 0

History:
  Tunnel:
    Time since created: 34 minutes, 3 seconds
    Time since path change: 1 minutes, 44 seconds
    Number of LSP IDs (Tun_Instances) used: 5
    Current LSP: [ID: 5]
    Uptime: 1 minutes, 44 seconds
    Prior LSP: [ID: 3]
    ID: path option unknown
    Removal Trigger: path verification failed
  Tun_Instance: 5
  Segment-Routing Path Info (isis level-1)
    Segment0[Node]: 3.3.3.3, Label: 20270
    Segment1[Node]: 6.6.6.6, Label: 20120
    Segment2[Node]: 7.7.7.7, Label: 20210

```

The following sample output is from the **show pce client lsp detail** command.

```

Device# show pce client lsp detail

PCC's tunnel database:
-----
Tunnel Name: dl_t1
LSPs:
  LSP[0]:
    source 2.2.2.2, destination 7.7.7.7, tunnel ID 1, LSP ID 5
    State: Admin up, Operation active
    Setup type: SR
    Bandwidth: signaled 0
    LSP object:
      PLSP-ID 0x807D1, flags: D:0 S:0 R:0 A:1 O:2
    Reported path:
      Metric type: TE, Accumulated Metric 0

```

The following sample output is from the **show pce lsp detail** command which shows the tunnel is delegated.

```

Device# show pce lsp detail

Thu Jul  7 10:24:30.836 EDT

PCE's tunnel database:
-----
PCC 102.103.2.1:

```

```

Tunnel Name: dl_t1
LSPs:
LSP[0]:
  source 2.2.2.2, destination 7.7.7.7, tunnel ID 1, LSP ID 5
  State: Admin up, Operation active
  Binding SID: 0
  PCEP information:
    plsp-id 526289, flags: D:1 S:0 R:0 A:1 O:2
  Reported path:
    Metric type: TE, Accumulated Metric 0
    SID[0]: Node, Label 20270, Address 3.3.3.3
    SID[1]: Node, Label 20120, Address 6.6.6.6
    SID[2]: Node, Label 20210, Address 7.7.7.7
  Computed path:
    Metric type: TE, Accumulated Metric 30
    SID[0]: Node, Label 20270, Address 3.3.3.3
    SID[1]: Node, Label 20120, Address 6.6.6.6
    SID[2]: Node, Label 20210, Address 7.7.7.7
  Recorded path:
    None

```

The following sample output is from the **show pce client lsp detail** command for reported tunnel.

```

Device# show pce client lsp detail

PCC's tunnel database:
-----
Tunnel Name: dl_t2
LSPs:
LSP[0]:
  source 2.2.2.2, destination 7.7.7.7, tunnel ID 2, LSP ID 1
  State: Admin up, Operation active
  Setup type: SR
  Bandwidth: signaled 0
  LSP object:
    PLSP-ID 0x807D2, flags: D:0 S:0 R:0 A:1 O:2
  Reported path:
    Metric type: TE, Accumulated Metric 30

```

The following sample output is from the **show pce lsp detail** command which shows the tunnel is not delegated.

```

Device# show pce lsp detail

Thu Jul 7 10:29:48.754 EDT

PCE's tunnel database:
-----
PCC 10.0.0.1:

Tunnel Name: dl_t2
LSPs:
LSP[0]:
  source 2.2.2.2, destination 7.7.7.7, tunnel ID 2, LSP ID 1
  State: Admin up, Operation active
  Binding SID: 0
  PCEP information:
    plsp-id 526290, flags: D:0 S:0 R:0 A:1 O:2
  Reported path:
    Metric type: TE, Accumulated Metric 30
    SID[0]: Adj, Label 74, Address: local 172.16.0.1 remote 172.16.0.2

```

```

SID[1]: Adj, Label 63, Address: local 173.17.0.1 remote 173.17.0.2
SID[2]: Adj, Label 67, Address: local 174.18.0.1 remote 174.18.0.2
SID[3]: Node, Label unknownAddress 7.7.7.7
Computed path:
None
Recorded path:
None

```

Verifying Verbatim Path Option With Dynamic PCC

To verify proper operation with verbatim path option, use the following command:

```

R1#sh mpls tr tun 2
Name: R1_t2 (Tunnel2) Destination: 66.66.66.66
Status:
  Admin: up      Oper: up      Path: valid      Signalling: connected
  path option 1, (SEGMENT-ROUTING) (PCE) type dynamic (verbatim) (Basis for Setup)

Config Parameters:
  Bandwidth: 0      kbps (Global) Priority: 7 7 Affinity: 0x0/0xFFFF
  Metric Type: TE (interface)
  Path Selection:
    Protection: any (default)
  Path-selection Tiebreaker:
    Global: not set Tunnel Specific: not set Effective: min-fill (default)
  Hop Limit: disabled [ignore: Verbatim Path Option]
  Cost Limit: disabled
  Path-invalidation timeout: 10000 msec (default), Action: Tear
  AutoRoute: disabled LockDown: disabled Loadshare: 0 [0] bw-based
  AutoRoute destination: enabled
  auto-bw: disabled
  Fault-OAM: disabled, Wrap-Protection: disabled, Wrap-Capable: No
Active Path Option Parameters:
  State: dynamic path option 1 is active
  BandwidthOverride: disabled LockDown: disabled Verbatim: enabled

PCEP Info:
  Delegation state: Working: yes Protect: no
  Delegation peer: 77.77.77.77
  Working Path Info:
    Request status: processed
    Created via PCRep message from PCE server: 77.77.77.77
    PCE metric: 4, type: TE
  Reported paths:
    Tunnel Name: Tunnel2_w
    LSPs:
      LSP[0]:
        source 11.11.11.11, destination 66.66.66.66, tunnel ID 2, LSP ID 1
        State: Admin up, Operation active
        Binding SID: 17
        Setup type: SR
        Bandwidth: requested 0, used 0
        LSP object:
          PLSP-ID 0x80002, flags: D:0 S:0 R:0 A:1 O:2
      ERO:
        SID[0]: Adj, Label 24, NAI: local 12.12.12.1 remote 12.12.12.2
        SID[1]: Adj, Label 26, NAI: local 25.25.25.2 remote 25.25.25.5
        SID[2]: Adj, Label 22, NAI: local 56.56.56.5 remote 56.56.56.6

History:

```

```

Tunnel:
  Time since created: 39 days, 19 hours, 9 minutes
  Time since path change: 1 minutes, 3 seconds
  Number of LSP IDs (Tun_Instances) used: 1
  Current LSP: [ID: 1]
  Uptime: 1 minutes, 3 seconds
Tun_Instance: 1
Segment-Routing Path Info (IGP information is not used)
  Segment0[Link]: 12.12.12.1 - 12.12.12.2, Label: 24
  Segment1[Link]: 25.25.25.2 - 25.25.25.5, Label: 26
  Segment2[Link]: 56.56.56.5 - 56.56.56.6, Label: 22
!
end

```

Additional References for Dynamic PCC

Related Documents

Related Topic	Document Title
Cisco IOS commands	Cisco IOS Master Commands List, All Releases

Feature Information for Dynamic PCC

The following table provides release information about the feature or features described in this module. This table lists only the software release that introduced support for a given feature in a given software release train. Unless noted otherwise, subsequent releases of that software release train also support that feature.

Use Cisco Feature Navigator to find information about platform support and Cisco software image support. To access Cisco Feature Navigator, go to www.cisco.com/go/cfn. An account on Cisco.com is not required.

Table 18: Feature Information for Dynamic PCC

Feature Name	Releases	Feature Information
Dynamic PCC	Cisco IOS XE Everest 16.6.1	<p>The Dynamic Path Computation Client (PCC) feature supports an LSP delegated to a Path Computation Element (PCE). Dynamic PCC supports both RSVP-TE and SR-TE.</p> <p>The following commands were added or modified:</p> <p>show pce client peer detail, show mpls traffic-eng tunnels tunnel 1, show pce client lsp detail, show pce lsp detail.</p>



CHAPTER 19

SR: PCE Initiated LSPs

The SR: PCE Initiated LSPs feature provides support for PCE-initiated LSPs in stateful PCE model on segment routing networks.

- [Prerequisites for SR: PCE Initiated LSPs, on page 187](#)
- [Restrictions for SR: PCE Initiated LSPs, on page 187](#)
- [Information About SR: PCE Initiated LSPs, on page 187](#)
- [How to Configure SR: PCE Initiated LSPs, on page 189](#)
- [Additional References for SR: PCE Initiated LSPs, on page 195](#)
- [Feature Information for SR: PCE Initiated LSPs, on page 195](#)

Prerequisites for SR: PCE Initiated LSPs

- The Dynamic PCC feature must be configured.
- Auto tunnels must be enabled on the PCC.

Restrictions for SR: PCE Initiated LSPs

- The SR: PCE Initiated LSPs feature supports only basic LSP generation and does not support TE attributes.

Information About SR: PCE Initiated LSPs

Overview of Path Computation Element Protocol

draft-ietf-pce-stateful-pce-21 describes Stateful Path Computation Element Protocol (PCEP) enables a router to report and optionally delegate Label Switched Paths (LSPs) which is established using either Resource Reservation Protocol (RSVP) protocol or Segment Routing Traffic Engineering (SR-TE) to a stateful Path Computation Element (PCE). An LSP delegated to a PCE can be updated by the PCE and a stateful PCE can compute and provide the path of an LSP to the Path Computation Client (PCC).

The **PCEP Extensions for PCE-initiated LSP Setup in a Stateful PCE Model (draft-ietf-pce-pce-initiated-lsp-11)** specifies a set of extensions to PCEP to enable stateful control of TE

LSPs across PCEP sessions in compliance with RFC4657. The **PCEP Extensions for PCE-initiated LSP Setup in a Stateful PCE Model** provides information about the following:

- Configuring LSPs on a PCC
- Delegating control of LSP to a PCE

SR: PCE Initiated LSPs

The SR: PCE Initiated LSPs feature allows a client to create, setup, control, and delete an LSP from PCE server, which controls creating and deleting LSP on PCC through an PCE initiate message. PCE initiated LSP is automatically delegated to the PCE server that initiated the LSP. A PCE client processes an LSP initiate message. By using the LSP initiate message, PCE client can create or delete LSP.

When a failover occurs on a route processor (RP), the failover results in the RP being disconnected from the network. To reestablish the connection, the PCE server has to resend LSP initiate message to reclaim PCE Initiated LSPs on a client, else PCE initiated LSPs created by the client are automatically deleted.

You must use the **pce** command for establishing a PCEP session with PCC. The **force auto-route** command is used to advertise an LSP within an area via the autoroute announce message and across areas via the autoroute destination message. The decision to use autoroute announce or autoroute destination is performed by a device depending on the destination IP address. Enabling the **force auto-route** command for an initiated LSP allows automatic routing of traffic through a TE tunnel instead of routing traffic via manually configuring static routes. The autoroute announce message installs routes announced by the destination router and downstream routers into the routing table of a headend device that can be reached through a tunnel.

The PCC configuration includes IP addresses for each PCE (both primary and standby or more). The precedence for each PCE can be explicitly specified. If the precedence for two PCEs is same, PCE with smaller IP address has a higher precedence.

Single and Redundant PCE Operations

The SR: PCE Initiated LSPs feature supports single and redundant PCE operations. In a single PCE operation, when a PCE fails, PCC waits until the state timeout expiry (60 seconds) to remove the LSP.

In a redundant PCE operation, if a Representational state transfer (REST) call is initiated to a standby PCE before the expiry of the timer, the initiated LSP is retained else, the LSP is removed.



Note

The REST call must be initiated again to a standby PCE if the primary PCE fails, and the call must include the standby PCE IP address.

In a redundant PCE operation, PCC configurations include both primary and standby IP addresses for an LSP and the IP address with a lower precedence becomes the primary PCE. The IP addresses are compared in case of equal priority.

How to Configure SR: PCE Initiated LSPs

Establishing a PCEP session with PCC

Perform this task to configure a PCEP session PCE server XR based XTC server.

```
configure terminal
pce
 address ipv4 192.0.2.1
end
```

The IP address 192.0.2.1 is the IP address of the transport controller.

Advertising an LSP in a Network

```
configure terminal
mpls traffic-eng pcc peer 192.0.2.1 source 203.0.113.1 force-autoroute
end
```

In the above code snippet, 192.0.2.1 is PCE IP address and 203.0.113.1 is PCC source address for establishing a PCEP session.

Specifying Precedence of a PCE for PCC

```
configure terminal
mpls traffic-eng pcc peer 192.0.2.1 source 203.0.113.1 force autoroute precedence 255
mpls traffic-eng pcc peer 192.0.2.2 source 203.0.113.1 force-autoroute precedence 100
end
```

In the above code snippet, 100 is a lower precedence than 255, which is the default precedence. Therefore, the device with IP address 192.0.2.2 becomes the primary PCE and the device with 192.0.2.1 becomes the standby PCE.

Triggering PCE server precedence re-evaluation

A change in a PCE server's precedence is not considered a PCE server failure. So, the change in precedence does not trigger a redelegation timeout or a re-evaluation of LSP delegation to the PCE server at a PCC.

Re-evaluation of LSP delegation to PCE servers after CLI reconfiguration is controlled by the TE reoptimisation timer. By default, the TE reoptimisation timer is set to 3600 seconds.

You can accelerate the re-evaluation of LSP delegation from a PCC to PCE servers after you have changed the precedence of PCE servers or added new PCE servers. To do so, manually trigger TE reoptimisation using the following command in privileged EXEC mode:

```
mpls traffic-eng reoptimize
```

Verifying LSP Configurations

SUMMARY STEPS

1. `show pce ipv4 peer detail`
2. `show pce lsp detail`
3. `show pce client peer`
4. `show mpls traffic-eng tunnel tunnel number`

DETAILED STEPS

Step 1 `show pce ipv4 peer detail`

Use this command to verify PCEP session details on a PCE. In this example, the term `instantiation` indicates that PCE supports initiated LSP.

```
Device# show pce ipv4 peer detail
```

```
PCE's peer database:
```

```
-----
```

```
Peer address: 52.2.2.2----' PCC IP address
```

```
State: Up
```

```
Capabilities: Stateful, Segment-Routing, Update, Instantiation
```

Step 2 `show pce lsp detail`

Use this command to verify the initiated LSP on a PCE.

```
Device# show pce lsp detail
```

```
PCE's tunnel database:
```

```
-----
```

```
PCC 52.2.2.2 ----' PCC IP address
```

```
Tunnel Name: Test1-----' tunnel name set by REST Call
```

```
LSPs:
```

```
LSP[0]:

source 52.2.2.2, destination 57.7.7.7, tunnel ID 2000, LSP ID 1

State: Admin up, Operation active

Binding SID: 26

PCEP information:

  plsp-id 526288, flags: D:1 S:0 R:0 A:1 O:2 C:1

LSP Role: Single LSP

State-sync PCE: None

PCC: 52.2.2.2

LSP is subdelegated to: None

Reported path:

  Metric type: TE, Accumulated Metric 2

  SID[0]: Adj, Label 25, Address: local 102.105.3.1 remote 102.105.3.2

  SID[1]: Adj, Label 24, Address: local 104.105.8.2 remote 104.105.8.1

  SID[2]: Adj, Label 38, Address: local 104.107.10.1 remote 104.107.10.2

Computed path: (Local PCE)

  None

  Computed Time: Not computed yet

Recorded path:

  None

Disjoint Group Information:

  None
```

Step 3 show pce client peer

Use this command to verify a PCEP session output on a PCC and to verify if the **force-autoroute** command is enabled.

```
Device# show pce client peer
```

```
PCC's peer database:
```

```
-----
```

```
Peer address: 51.1.1.1, Precedence: 255
```

```
State up
```

```
Capabilities: Stateful, Update, Segment-Routing, Force-autoroute
```

Step 4 **show mpls traffic-eng tunnel tunnel *number***

Use this command to verify the output of the initiated LSP tunnel on a PCC.

```
Device# show mpls traffic-eng tunnel tunnel 2000
```

```
Name: Test1 (Tunnel2000) Destination: 57.7.7.7 Ifhandle: 0x11E
(auto-tunnel for pce client)
```

```
Status:
```

```
Admin: up Oper: up Path: valid Signalling: connected
```

```
path option 1, (SEGMENT-ROUTING) (PCE) type dynamic (Basis for Setup)
```

```
Config Parameters:
```

```
Bandwidth: 0 kbps (Global) Priority: 7 7 Affinity: 0x0/0xFFFF
```

```
Metric Type: TE (default)
```

```
Path Selection:
```

```
Protection: any (default)
```

```
Path-selection Tiebreaker:
```

```
Global: not set Tunnel Specific: not set Effective: min-fill (default)
```

```
Hop Limit: disabled
```

```
Cost Limit: disabled
```

```
Path-invalidation timeout: 10000 msec (default), Action: Tear

AutoRoute: enabled LockDown: disabled Loadshare: 0 [0] bw-based

auto-bw: disabled

Fault-OAM: disabled, Wrap-Protection: disabled, Wrap-Capable: No

Active Path Option Parameters:

State: dynamic path option 1 is active

BandwidthOverride: disabled LockDown: disabled Verbatim: disabled

PCEP Info:

Delegation state: Working: yes Protect: no

Delegation peer: 51.1.1.1

Working Path Info:

Request status: delegated

SRP-ID: 1

Created via PCInitiate message from PCE server: 51.1.1.1-----' IP address

PCE metric: 2, type: TE

Reported paths:

Tunnel Name: Test1

LSPs:

LSP[0]:

source 52.2.2.2, destination 57.7.7.7, tunnel ID 2000, LSP ID 1

State: Admin up, Operation active

Binding SID: 26

Setup type: SR

Bandwidth: requested 0, used 0
```

```
LSP object:

  PLSP-ID 0x807D0, flags: D:0 S:0 R:0 A:1 O:2

Metric type: TE, Accumulated Metric 2

ERO:

  SID[0]: Adj, Label 25, NAI: local 102.105.3.1 remote 102.105.3.2

  SID[1]: Adj, Label 24, NAI: local 104.105.8.2 remote 104.105.8.1

  SID[2]: Adj, Label 38, NAI: local 104.107.10.1 remote 104.107.10.2

  PLSP Event History (most recent first):

    Mon Jul 17 08:55:04.448: PCRpt update LSP-ID:1, SRP-ID:1, PST:1, METRIC_TYPE:2, REQ_BW:0,
    USED_BW:0

    Mon Jul 17 08:55:04.436: PCRpt create LSP-ID:1, SRP-ID:1, PST:1, METRIC_TYPE:2, REQ_BW:0,
    USED_BW:0

History:

  Tunnel:

    Time since created: 2 hours, 42 minutes

    Time since path change: 2 hours, 42 minutes

    Number of LSP IDs (Tun_Instances) used: 1

  Current LSP: [ID: 1]

    Uptime: 2 hours, 42 minutes

  Tun_Instance: 1

  Segment-Routing Path Info (isis level-2)

    Segment0[Link]: 102.105.3.1 - 102.105.3.2, Label: 25

    Segment1[Link]: 104.105.8.2 - 104.105.8.1, Label: 24

    Segment2[Link]: 104.107.10.1 - 104.107.10.2, Label: 38
```

Additional References for SR: PCE Initiated LSPs

Standards and RFCs

Standard/RFC	Title
draft-ietf-pce-pce-initiated-lsp-11	<i>PCEP Extensions for PCE-initiated LSP Setup in a Stateful PCE Model</i>
RFC 5440	<i>Path Computation Element (PCE) Communication Protocol (PCEP)</i>
RFC 8231	<i>Path Computation Element (PCE) Communication Protocol Generic Requirements</i>

Feature Information for SR: PCE Initiated LSPs

The following table provides release information about the feature or features described in this module. This table lists only the software release that introduced support for a given feature in a given software release train. Unless noted otherwise, subsequent releases of that software release train also support that feature.

Use Cisco Feature Navigator to find information about platform support and Cisco software image support. To access Cisco Feature Navigator, go to www.cisco.com/go/cfn. An account on Cisco.com is not required.

Table 19: Feature Information for SR: PCE Initiated LSPs

Feature Name	Releases	Feature Information
SR: PCE Initiated LSPs	Cisco IOS XE Fuji 16.7.1	The SR: PCE Initiated LSPs provides support for PCE-initiated LSPs in stateful PCE model on segment routing networks. The following commands were introduced or modified: mpls traffic-eng pcc , pce , show mpls traffic-eng tunnel , show pce client peer , show pce ipv4 peer , show pce lsp .



CHAPTER 20

ISIS - SR: uLoop Avoidance

The ISIS - SR: uLoop Avoidance feature extends the ISIS Local Microloop Protection feature thereby preventing the occurrences of microloops during network convergence after a link-down event or link-up event.

- [Prerequisites for ISIS - SR: uLoop Avoidance, on page 197](#)
- [Restrictions for ISIS - SR: uLoop Avoidance, on page 197](#)
- [Information About ISIS - SR: uLoop Avoidance, on page 197](#)
- [How to Enable ISIS - SR: uLoop Avoidance, on page 201](#)
- [Additional References for ISIS - SR: uLoop Avoidance, on page 202](#)
- [Feature Information for ISIS - SR: uLoop Avoidance, on page 203](#)

Prerequisites for ISIS - SR: uLoop Avoidance

- The ISIS - SR: uLoop Avoidance feature is disabled by default. When the Topology-Independent Loop-Free Alternate (TI-LFA) feature is configured, this feature is enabled automatically. See the “Topology-Independent LFA” section in the *Using Segment Routing with IS-IS* module for more information.

Restrictions for ISIS - SR: uLoop Avoidance

- The ISIS - SR: uLoop Avoidance feature supports 2-node on the same subnet on a LAN network.

Information About ISIS - SR: uLoop Avoidance

Microloops

When changes occur in a network topology because of the failure or restoration of a link or a network device, IP Fast Reroute enables rapid network convergence by moving traffic to precomputed backup paths until regular convergence mechanisms move traffic to a newly computed best path, also known as a post-convergence path. This network convergence may cause short microloops between two directly or indirectly connected devices in the topology. Microloops are caused when different nodes in the network calculate alternate paths

at different times and independently of each other. For instance, if a node converges and sends traffic to a neighbor node, which has not converged yet, traffic may loop between the two nodes.

Microloops may or may not result in traffic loss. If the duration of a microloop is short, that is the network converges quickly, packets may loop for a short duration before their time-to-live (TTL) expires. Eventually, the packets will get forwarded to the destination. If the duration of the microloop is long, that is one of the routers in the network is slow to converge, packets may expire their TTL or the packet rate may exceed the bandwidth, or the packets might be out of order, and packets may get dropped.

Microloops that are formed between a failed device and its neighbors are called local uloops, whereas microloops that are formed between devices that are multiple hops away are called remote uloops. Local uloops are usually seen in networks where local loop-free alternate (LFA) path is not available. In such networks, remote LFAs provide backup paths for the network.

The information discussed above can be illustrated with the help of an example topology as shown in the following figure.

Figure 21: Microloop Example Topology

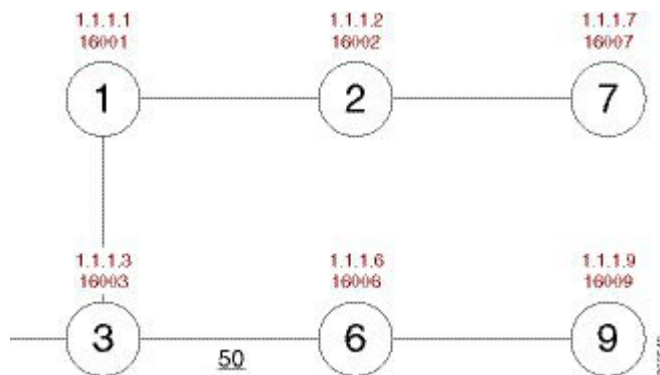

The assumptions in this example are as follows:

- The default metrics is 10 for each link except for the link between Node 3 and Node 6, which has a metric of 50. The order of convergence with SPF backoff delays on each node is as follows:
 - Node 3—50 milliseconds
 - Node 1—500 milliseconds
 - Node 2—1 second
 - Node 2—1.5 seconds

A packet sent from Node 3 to Node 9, the destination, traverses via Node 6.

If a link is established between Node 6 and Node 7, the shortest path for a packet from Node 3 to Node 9 would be Node 1, Node 2, Node 7, and Node 6 before the packet reaches the destination, Node 9.

Figure 22: Microloop Example Topology—Shortest Path

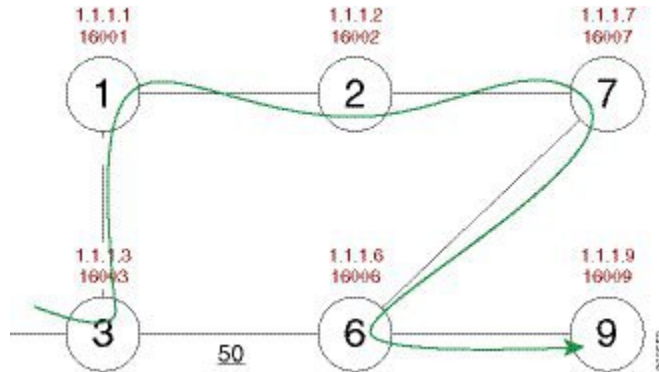

The following figure shows the Forwarding Information Base (FIB) table in each node before the link between Node 6 and Node 7 is established. The FIB entry contains the prefix of the destination node (Node 9) and the next hop.

Figure 23: Microloop Example Topology—FIB Entry

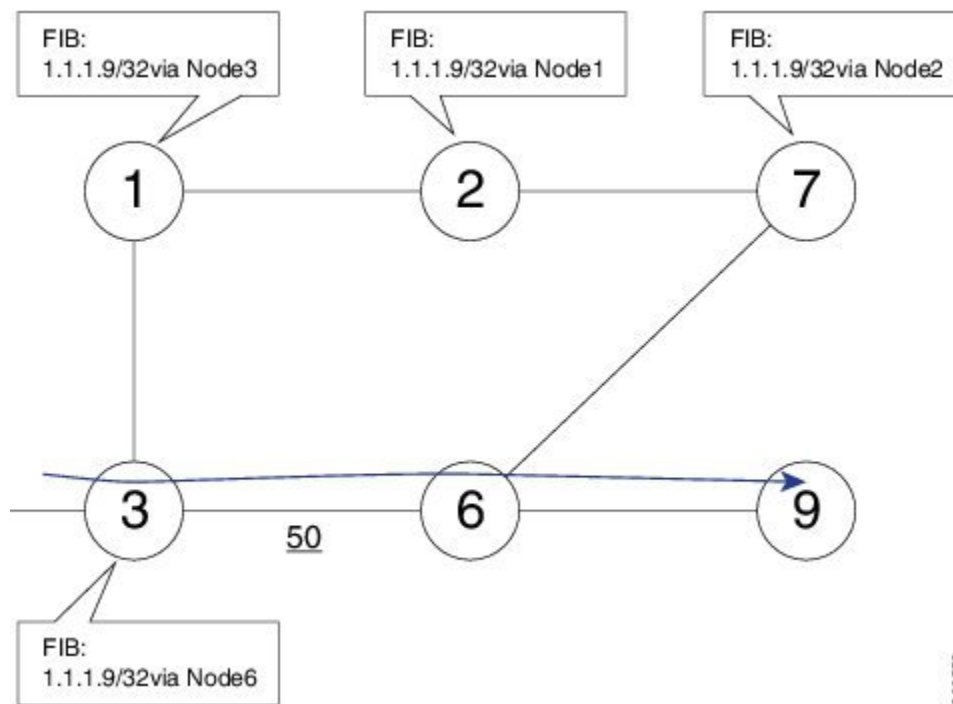

When the link between Node 6 and Node 7 comes up, microloops occur for the links based on the order of convergence of each node. In this example, Node 3 converges first with Node 1 resulting in a microloop between Node 3 and Node 1. Then, Node 1 converges next resulting in a microloop between Node 1 and Node 2. Next, Node 2 converges next resulting in a microloop between Node 2 and Node 7. Finally, Node 7 converges resolving the microloop and the packet reaches the destination Node 9, as shown in the following figure.

Figure 24: Microloop Example Topology—Microloops

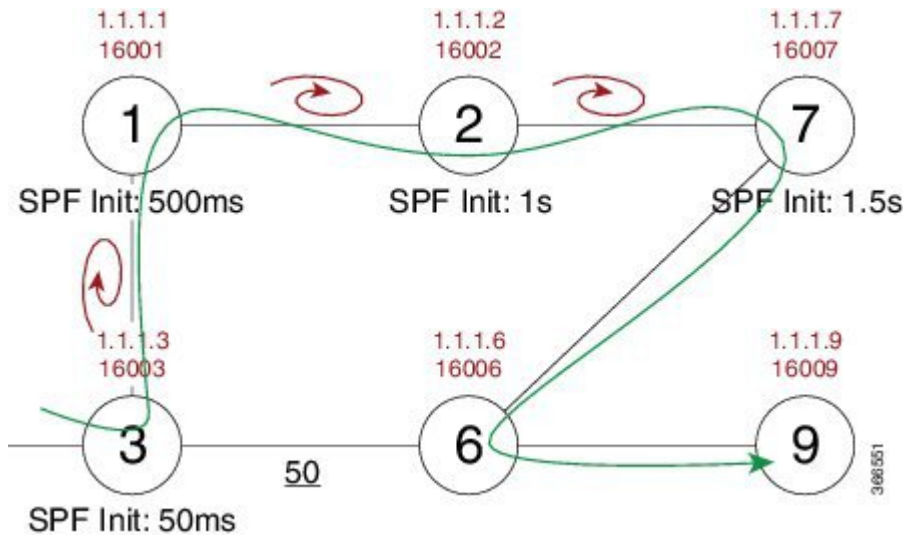

Adding the SPF convergence delay, microloop results in a loss of connectivity for 1.5 seconds, which is the convergence duration specified for node 7.

Segment Routing and Microloops

The ISIS - SR: uLoop Avoidance feature supports the following scenarios:

- Link-up or link-down for point-to-point links and a LAN segment with two nodes
- Link cost decrease or increase when a node is up or down due to the overload bit being set or unset

The **microloop avoidance segment-routing** command must be enabled on a node to prevent microloops.

How Segment Routing Prevents Microloops?

Using the example used to explain microloops, this section explains how to segment routing prevents microloops. Node 3 in the example is enabled with the **microloop avoidance segment-routing** command. After the link between Node 6 and Node 7 comes up, Node 3 computes a new microloop on the network.

Figure 25: Microloop Example Topology—Segment Routing

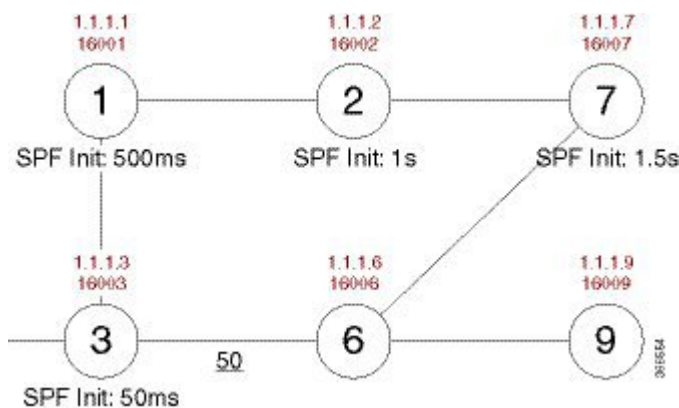

Instead of updating the FIB table, Node 3 builds a dynamic loop-free alternate (LFA) SR TE policy for the destination (Node 9) using a list of segments IDs, which include the prefix segment ID (SID) of Node 7, which is 16007, and the adjacency segment ID (SID) of Node 6, which is 24076.

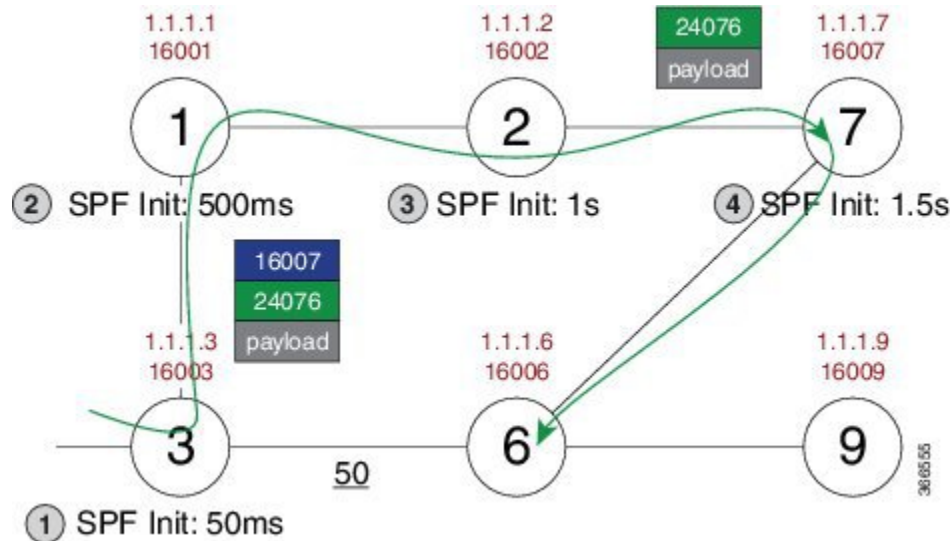

So, the SR TE policy enables a packet from Node 3 reaches its destination Node 9, without the risk of microloop until the network converges. Finally, Node 3 updates the FIB for the new path.

Use the protected keyword with the **microloop avoidance segment-routing** command, to enable microloop avoidance for protected prefixes only. The **microloop avoidance rib-update-delay milliseconds** command can be used to configure the delay in milliseconds for a node to wait before updating the node's forwarding table and stop using the microloop avoidance policy. The default value for the RIB delay is 5000 milliseconds.

How to Enable ISIS - SR: uLoop Avoidance

Enabling Microloop Avoidance

The following is a sample configuration code snippet to enable microloop avoidance.

```
router isis
 fast-reroute per-prefix level-2 all
 microloop avoidance segment-routing
 microloop avoidance rib-update-delay 3000
```

Verifying Microloop Avoidance

Use the **show isis rib** and **show ip route** commands to check if the repair path exists or not.

```
Router# show isis rib 20.20.20.0 255.255.255.0

IPv4 local RIB for IS-IS process sr

IPv4 unicast topology base (TID 0, TOPOID 0x0) =====
Repair path attributes:
 DS - Downstream, LC - Linecard-Disjoint, NP - Node-Protecting
 PP - Primary-Path, SR - SRLG-Disjoint
```

```

20.20.20.0/24 prefix attr X:0 R:0 N:0 prefix SID index 2 - Bound (ULOOP EP)
 [115/L2/130] via 77.77.77.77(MPLS-SR-Tunnel5), from 44.44.44.44, tag 0,
 LSP[2/5/29]
 prefix attr: X:0 R:0 N:0
 SRGB: 16000, range: 8000 prefix-SID index: None
 (ULOOP_EP) (installed)
 - - - - -
 [115/L2/130] via 16.16.16.6(Ethernet2/0), from 44.44.44.44, tag 0, LSP[2/5/29]
 prefix attr: X:0 R:0 N:0
 SRGB: 16000, range: 8000 prefix-SID index: None
 (ALT)

Router# show ip route 20.20.20.0

Routing entry for 20.20.20.0/24
  Known via "isis", distance 115, metric 130, type level-2
  Redistributing via isis sr
  Last update from 77.77.77.77 on MPLS-SR-Tunnel5, 00:00:43 ago
  SR Incoming Label: 16002 via SRMS
  Routing Descriptor Blocks:
  * 77.77.77.77, from 44.44.44.44, 00:00:43 ago, via MPLS-SR-Tunnel5,
  * prefer-non-rib-labels, merge-labels
  Route metric is 130, traffic share count is 1
  MPLS label: 16002
  MPLS Flags: NSF
    
```

Additional References for ISIS - SR: uLoop Avoidance

Related Documents

Related Topic	Document Title
Cisco IOS commands	Cisco IOS Master Command List, All Releases
Segment Routing and IS-IS	<i>Using Segment Routing with IS-IS</i>
Overview of IS-IS concepts	“IS-IS Overview and Basic Configuration” module in the <i>IP Routing: ISIS Configuration Guide</i>
ISIS Local Microloop Protection	“ISIS Local Microloop Protection” module in the <i>IP Routing: ISIS Configuration Guide</i>

Standards/RFCs

Standard/RFC	Title
draft-francois-rtgwg-segment-routing-uloop-00	<i>Loop avoidance using Segment Routing</i>

Feature Information for ISIS - SR: uLoop Avoidance

The following table provides release information about the feature or features described in this module. This table lists only the software release that introduced support for a given feature in a given software release train. Unless noted otherwise, subsequent releases of that software release train also support that feature.

Use Cisco Feature Navigator to find information about platform support and Cisco software image support. To access Cisco Feature Navigator, go to www.cisco.com/go/cfn. An account on Cisco.com is not required.

Table 20: Feature Information for ISIS - SR: uLoop Avoidance

Feature Name	Releases	Feature Information
ISIS - SR: uLoop Avoidance	Cisco IOS XE Everest 16.6.1	<p>The ISIS - SR: uLoop Avoidance feature extends the ISIS Local Microloop Protection feature thereby preventing the occurrences of microloops during network convergence after a link-down event or link-up event.</p> <p>The following commands were introduced or modified: microloop avoidance, microloop avoidance rib-update-delay, show mpls traffic tunnel.</p>



CHAPTER 21

BGP - SR: BGP Prefix SID Redistribution

The BGP - SR: BGP Prefix SID Redistribution feature provides support for BGP Prefix-SID in IPv4 prefixes in segment routing—BGP networks.

- [Prerequisites for BGP - SR: BGP Prefix SID Redistribution, on page 205](#)
- [Information About BGP - SR: BGP Prefix SID Redistribution, on page 205](#)
- [How to Enable BGP - SR: BGP Prefix SID Redistribution, on page 206](#)
- [Additional References for BGP - SR: BGP Prefix SID Redistribution, on page 208](#)
- [Feature Information for BGP - SR: BGP Prefix SID Redistribution, on page 208](#)

Prerequisites for BGP - SR: BGP Prefix SID Redistribution

- Multiprotocol Label Switching (MPLS) must be configured.

Information About BGP - SR: BGP Prefix SID Redistribution

Segment Routing and BGP

Segment Routing uses Multiprotocol Label Switching (MPLS) labels to create a path to guide a packet in a network. Using segment routing, an MPLS label range is reserved with MPLS Forwarding Infrastructure (MFI). This label range is called Segment Routing Global Block (SRGB). A prefix SID assigned to a prefix is an extension of SRGB.

To support segment routing, Border Gateway Protocol (BGP) requires the ability to advertise a segment identifier (SID) for a BGP prefix. A BGP-Prefix-SID is the segment identifier of the BGP prefix segment in an segment routing with BGP network. A BGP-Prefix-SID is also an instruction to forward the packet over an ECMP-aware best-path computed by BGP to a related prefix. When BGP nodes communicate with neighbor nodes in a network, the BGP Update, message sent to neighbor nodes, includes the Prefix-SID Label in Labeled Unicast NLRI and a prefix SID index in a new attribute called Prefix SID attribute.

To support forwarding paths for traffic engineering, the forwarding path may need to be different from the optimal path. Hence, each BGP node assigns a local label to the neighbors and advertises the local label as adjacency SID through BGP--link state updates.

The BGP - SR: BGP Prefix SID Redistribution feature can be enabled by using the **connected-prefix-sid-map** command in the segment routing MPLS configuration mode. Additionally, you also need to enable the **segment-routing mpls** command in the router configuration mode for each address family.



Note In Cisco IOS XE Everest 16.6.1, IPv4 prefixes only are supported.

Segment Routing for Locally Sourced Routes

Interface host routes configured on local nodes are known as locally sourced routes. If segment routing is enabled, a BGP node includes the explicit or implicit null as prefix SID label and prefix SID attribute and advertises the prefix to a neighbor node.

If explicit-null is not configured on a neighbor, the MPLS Implicit Null label (3) is advertised to a neighbor node. If explicit-null is configured on a neighbor, the MPLS Explicit Null label corresponding to the address family of the prefix is advertised (0 for IPv4) to a neighbor node.

Segment Routing for Received Prefixes

BGP nodes that receive prefix SID attribute from a neighbor node via communication, add the label in the outgoing label as the prefix when a route is added to the RIB. The local label and prefix SID index is included in the RIB.

Segment Routing for Redistributed Routes

A source protocol on a BGP node allocates local label depending on the received prefix SID index and SRGB available on a local node. A source protocol provides the prefix SID index and the derived local label to RIB. BGP uses the local label from RIB as a label in the Labeled Unicast update sent to neighbors nodes.

BGP--MFI Interaction

BGP registers with MFI as a client and binds the label derived from SID index and SRGB as local label (with which traffic is expected to arrive) for the prefix.

How to Enable BGP - SR: BGP Prefix SID Redistribution

Enabling BGP-Prefix-SID

```
segment-routing mpls
connected-prefix-sid-map */-----> Configures Prefix to SIDIndex Map that can be queried
by BGP/IGP /*
address-family ipv4
10.0.0.1/255.0.0.0 index 10 range 11.0.0.1
```

Enabling BGP for Segment Routing

```
router bgp 2
  address-family-ipv4
  segment-routing mpls
```

Verifying BGP - SR: BGP Prefix SID Redistribution

This section shows how to verify the BGP - SR: BGP Prefix SID Redistribution feature with the help of an example network, in which, a device configured with segment routing is connected to two devices configured with Border Gateway Protocol (BGP). In each device, the **show segment-routing mpls** command is used to view the configuration.

The following is configuration on the device configured with segment routing.

```
segment-routing mpls
global-block 10000 13000
!
connected-prefix-sid-map
  address-family ipv4
    12.1.1.1/32 index 3 range 1
  exit-address-family
!
segment-routing mpls

interface Loopback0
ip address 12.1.1.1 255.255.255.255

router bgp 1
neighbor 10.1.1.2 remote-as 2
!
address-family ipv4
  redistribute connected
  segment-routing mpls
  neighbor 10.1.1.2 activate
  neighbor 10.1.1.2 send-label
exit-address-family
```

The following is the configuration on the first device configured with BGP.

```
segment-routing mpls

router bgp 2
neighbor 10.1.1.1 remote-as 1
neighbor 11.1.1.2 remote-as 3
!
address-family ipv4
  redistribute connected
  neighbor 10.1.1.1 activate
  neighbor 10.1.1.1 send-label
  neighbor 11.1.1.2 activate
  neighbor 11.1.1.2 send-label
exit-address-family
```

The following is the configuration on the second device configured with BGP.

```
segment-routing mpls

router bgp 3
neighbor 11.1.1.1 remote-as 2
!
address-family ipv4
```

```

redistribute connected
neighbor 11.1.1.1 activate
neighbor 11.1.1.1 send-label
exit-address-family

```

Additional References for BGP - SR: BGP Prefix SID Redistribution

Related Documents

Related Topic	Document Title
Cisco IOS commands	Cisco IOS Master Command List, All Releases

Standards and RFCs

Standard/RFC	Title
RFC3107	<i>Carrying Label Information in BGP-4</i>

Feature Information for BGP - SR: BGP Prefix SID Redistribution

The following table provides release information about the feature or features described in this module. This table lists only the software release that introduced support for a given feature in a given software release train. Unless noted otherwise, subsequent releases of that software release train also support that feature.

Use Cisco Feature Navigator to find information about platform support and Cisco software image support. To access Cisco Feature Navigator, go to www.cisco.com/go/cfn. An account on Cisco.com is not required.

Table 21: Feature Information for BGP - SR: BGP Prefix SID Redistribution

Feature Name	Releases	Feature Information
BGP - SR: BGP Prefix SID Redistribution	Cisco IOS XE Everest 16.6.1	The BGP - SR: BGP Prefix SID Redistribution feature provides support for BGP Prefix-SID in IPv4 prefixes in segment routing—BGP networks. The following commands were introduced or modified: connected-prefix-sid-map , segment-routing .



CHAPTER 22

Advertise Maximum SID Depth by IS-IS and OSPF to BGP-LS

In a Segment Routing (SR) enabled network a centralized controller that programs SR tunnels needs to know the Maximum Segment Identifier (SID) Depth (MSD) supported by the head-end at node and/or link granularity to push the SID stack of an appropriate depth. MSD is relevant to the head-end of a SR tunnel or binding-SID anchor node where binding-SID expansions might result in creation of a new SID stack.

- [Restrictions for Advertise Maximum SID Depth by IS-IS and OSPF to BGP-LS, on page 209](#)
- [Information About Advertise Maximum SID Depth by IS-IS and OSPF to BGP-LS, on page 209](#)
- [Verifying Advertise Maximum SID Depth by IS-IS and OSPF to BGP-LS, on page 211](#)
- [Additional References for Advertise Maximum SID Depth by IS-IS and OSPF to BGP-LS, on page 212](#)
- [Feature Information for Advertise Maximum SID Depth by IS-IS and OSPF to BGP-LS, on page 212](#)

Restrictions for Advertise Maximum SID Depth by IS-IS and OSPF to BGP-LS

- In IOS-XE as there no line cards, link-MSD is not advertised.

Information About Advertise Maximum SID Depth by IS-IS and OSPF to BGP-LS



Note This feature is enabled by default and no specific configuration is required to enable this functionality.

Maximum SID Depth

You can use IGP to signal the MSD of a node or link to a centralized controller by:

- Advertising node-MSD to its peers.
- Providing the MSD information to BGP-LS.

Path Computation Element Protocol (PCEP) SR extensions signal MSD in SR PCE capability TLV and metric object. However, if PCEP is not supported/configured on the head-end of a SR tunnel or a binding-SID anchor node and controller does not participate in IGP routing, it has no way to learn the MSD of nodes. BGP-LS defines a way to expose topology and associated attributes and capabilities of the nodes in that topology to a centralized controller. Typically, BGP-LS is configured on a small number of nodes that do not necessarily act as head-ends. In order for BGP-LS to signal MSD for all the SR capable nodes in the network, MSD capabilities should be advertised by every IGP router in the network.

Readable Label Depth Capability (RLDC) is used by a head-end to insert Entropy Label (EL) at appropriate depth, so it could be read by transit nodes. MSD in contrary signals ability to push SID's stack of a particular depth.

MSD of type 1 (IANA registry) is used to signal the number of SIDs a node is capable of imposing to be used by a path computation element/controller. It is only relevant to the part of the stack created as the result of the computation. MSD advertises the total number of labels that a node is capable of imposing regardless of the number of service labels.

Node Maximum SID Depth Advertisement

A new Type/Length/Value (TLV) within the body called node MSD TLV is defined to carry the provisioned SID depth of the router originating the Router Information (RI) Link State Advertisement (LSA). Node MSD is the lowest MSD supported by the node.

Node Maximum SID Depth Advertisement for OSPF

```

0          1          2          3
  0 1 2 3 4 5 6 7 8 9 0 1 2 3 4 5 6 7 8 9 0 1 2 3 4 5 6 7 8 9 0 1

+---+---+---+---+---+---+---+---+---+---+---+---+---+---+---+---+---+---+---+---+---+---+
|   Type                               |           Length                               |
+---+---+---+---+---+---+---+---+---+---+---+---+---+---+---+---+---+---+---+---+---+---+
|           Sub-Type and Value ...     |
+---+---+---+---+---+---+---+---+---+---+---+---+---+---+---+---+---+---+---+---+---+---+

```

The Type (2 bytes) of this TLV is 12 (that is the suggested value to be assigned by IANA). Length is variable (minimum of 2, multiple of 2 octets) and represents the total length of value field. Value field consists of a 1 octet sub-type (IANA Registry) and 1 octet value.

Sub-Type 1, MSD and the value field contains maximum MSD of the device originating the RI LSA. Node maximum MSD falls in the range of 0-254. 0 represents lack of the ability to push MSD of any depth; any other value represents that of the node. This value should represent the lowest value supported by node.

Node Maximum SID Depth Advertisement for IS-IS

```

0          1          2          3
  0 1 2 3 4 5 6 7 8 9 0 1 2 3 4 5 6 7 8 9 0 1 2 3 4 5 6 7 8 9 0 1

+---+---+---+---+---+---+---+---+---+---+---+---+---+---+---+---+---+---+---+---+---+---+
|   Type           |   Length           |   Sub-Type and Value           |
+---+---+---+---+---+---+---+---+---+---+---+---+---+---+---+---+---+---+---+---+---+---+

```

Node MSD is a sub-TLV for TLV 242. The type of this sub-TLV is 23. Length is variable (minimum of 2, multiple of 2 octets).

Sub-Type 1, MSD and the value field contains maximum MSD of the device originating the RI LSA. Node maximum MSD falls in the range of 0-254. 0 represents lack of the ability to push MSD of any depth; any other value represents that of the node. This value should represent the lowest value supported by node.

Getting the Node MSD from Hardware

IS-IS and OSPF are updated about the maximum SID Depth for the node from the underlying hardware. Based on that IS-IS and OSPF update the value in its TLVs.

Advertising the MSD to BGP-LS

IGP sends the information to LSLIB to make the MSD information available to BGP-LS. It can be node MSD or link MSD information. You also need to configure **distribute linkstate** under IS-IS for MSD to work. Perform the following steps to configure distribute link-state:

```
Device# configure terminal
Device(config)# router isis
Device(config-router)# distribute link-state
```

Verifying Advertise Maximum SID Depth by IS-IS and OSPF to BGP-LS

Verifying Advertise Maximum SID Depth Using IS-IS

The following show command is used to verify the node MSD TLV:

```
Device# show isis database verbose
Router CAP: 10.10.10.1, D:0, S:0
  Segment Routing: I:1 V:0, SRGB Base: 16000 Range: 8000
    Segment Routing Algorithms: SPF, Strict-SPF
  Router CAP: 2.2.2.2, D:0, S:0
  Segment Routing: I:1 V:0, SRGB Base: 16000 Range: 8000
  Segment Routing Algorithms: SPF, Strict-SPF
Node-MSD
MSD: 16
```

Verifying Advertise Maximum SID Depth Using OSPF

The following show command is used to verify the node MSD TLV:

```
Device# show ip ospf database opaque-area type router-information
TLV Type: Segment Routing Node MSD
Length: 2
Sub-type: Node Max Sid Depth, Value: 16
```

Additional References for Advertise Maximum SID Depth by IS-IS and OSPF to BGP-LS

Related Documents

Related Topic	Document Title
Cisco IOS commands	Cisco IOS Master Commands List, All Releases

Feature Information for Advertise Maximum SID Depth by IS-IS and OSPF to BGP-LS

The following table provides release information about the feature or features described in this module. This table lists only the software release that introduced support for a given feature in a given software release train. Unless noted otherwise, subsequent releases of that software release train also support that feature.

Use Cisco Feature Navigator to find information about platform support and Cisco software image support. To access Cisco Feature Navigator, go to www.cisco.com/go/cfn. An account on Cisco.com is not required.

Table 22: Feature Information for Advertise Maximum SID Depth by IS-IS and OSPF to BGP-LS

Feature Name	Releases	Feature Information
Advertise Maximum SID Depth by IS-IS and OSPF to BGP-LS	Cisco IOS XE Fuji 16.7.1	<p>In a Segment Routing (SR) enabled network a centralized controller that programs SR tunnels needs to know the Maximum Segment Identifier (SID) Depth (MSD) supported by the head-end at node and/or link granularity to push the SID stack of an appropriate depth. MSD is relevant to the head-end of a SR tunnel or binding-SID anchor node where binding-SID expansions might result in creation of a new SID stack.</p> <p>The following commands were introduced or modified by this feature: distribute link-state, show isis database verbose, show ip ospf database opaque-area type router-information.</p>