

Configuring an IPsec Tunnel – Cisco VPN 3000 Concentrator to Checkpoint 4.1 Firewall

Document ID: 14104

Contents

Introduction

Prerequisites

- Requirements
- Components Used
- Network Diagram
- Conventions

Configure the VPN 3000 Concentrator

Configure the Checkpoint 4.1 Firewall

Verify

Troubleshoot

- Network Summarization
- VPN 3000 Concentrator Debug
- Checkpoint 4.1 Firewall Debug
- Sample Debug Output

Related Information

Introduction

This document demonstrates how to form an IPsec tunnel with pre-shared keys to join two private networks:

- A private network inside the Cisco VPN 3000 Concentrator (192.168.1.x).
- A private network inside the Checkpoint 4.1 Firewall (10.32.50.x).

It is assumed that traffic from inside the VPN Concentrator and inside the Checkpoint to the Internet (represented in this document by the 172.18.124.x networks) flows before this configuration begins.

Prerequisites

Requirements

There are no specific requirements for this document.

Components Used

The information in this document is based on these software and hardware versions:

- VPN 3000 Concentrator
- VPN 3000 Concentrator software release 2.5.2.F
- Checkpoint 4.1 Firewall

The information in this document was created from the devices in a specific lab environment. All of the devices used in this document started with a cleared (default) configuration. If your network is live, make sure that you understand the potential impact of any command.

Network Diagram

This document uses this network setup:

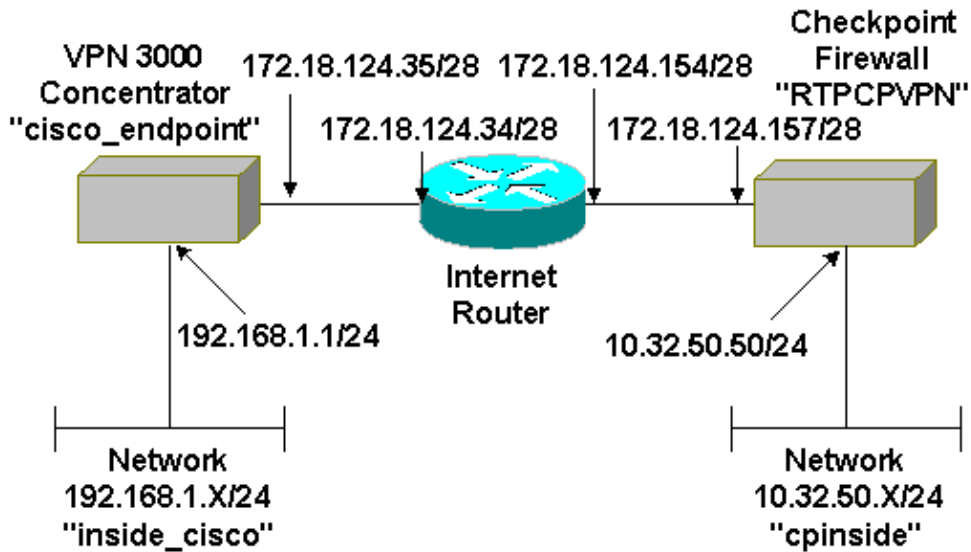

Conventions

Refer to Cisco Technical Tips Conventions for more information on document conventions.

Configure the VPN 3000 Concentrator

Complete these steps to configure the VPN 3000 Concentrator.

1. Select **Configuration > System > Tunneling Protocols > IPSec > IKE Proposals > Modify** to create an Internet Key Exchange (IKE) proposal named "des-sha" with Secure Hash Algorithm (SHA) hashing, Data Encryption Standard (DES), and Diffie-Hellman Group 1. Leave the Time Lifetime at the default 86400 seconds.

Note: The valid range for the VPN Concentrator IKE lifetime is 60–2147483647 seconds.

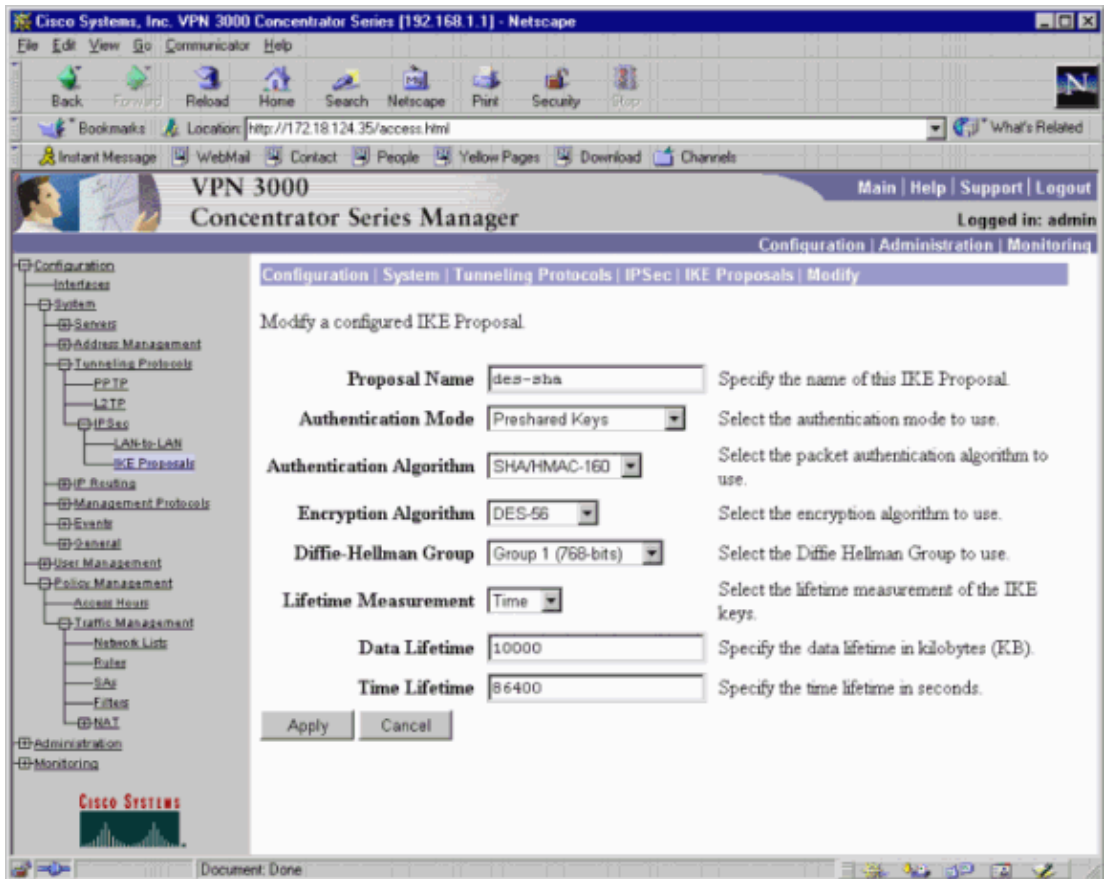

2. Select **Configuration > System > Tunneling Protocols > IPSec > IKE Proposals**. Select "des-sha" and click **Activate** to activate the IKE proposal.

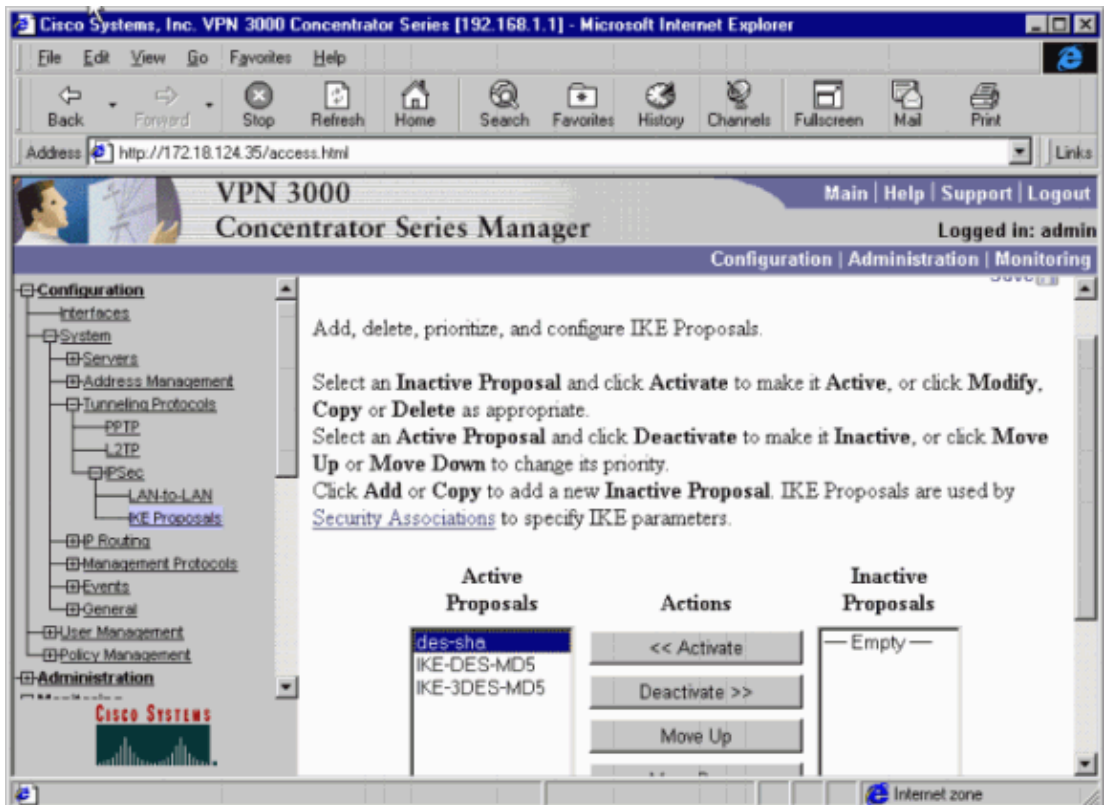

3. Select **Configuration > System > Tunneling Protocols > IPSec LAN-to-LAN > Add**.

Set up an IPsec tunnel called "to_checkpoint" with the Checkpoint address as the Peer. For Preshared

Key, enter the actual key. Under Authentication, select ESP/SHA/HMAC-160, and select DES-56 for Encryption. Enter the IKE proposal ("des-sha" in this example), and the Local and Remote networks.

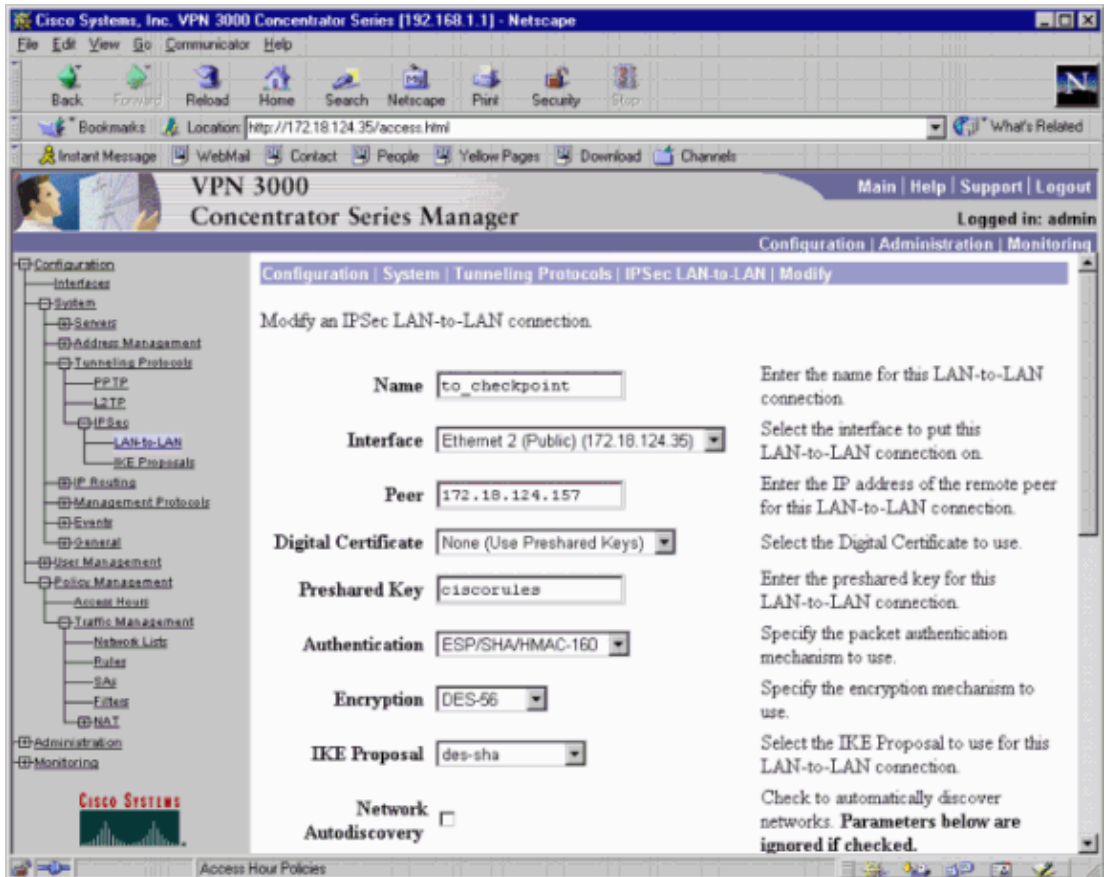

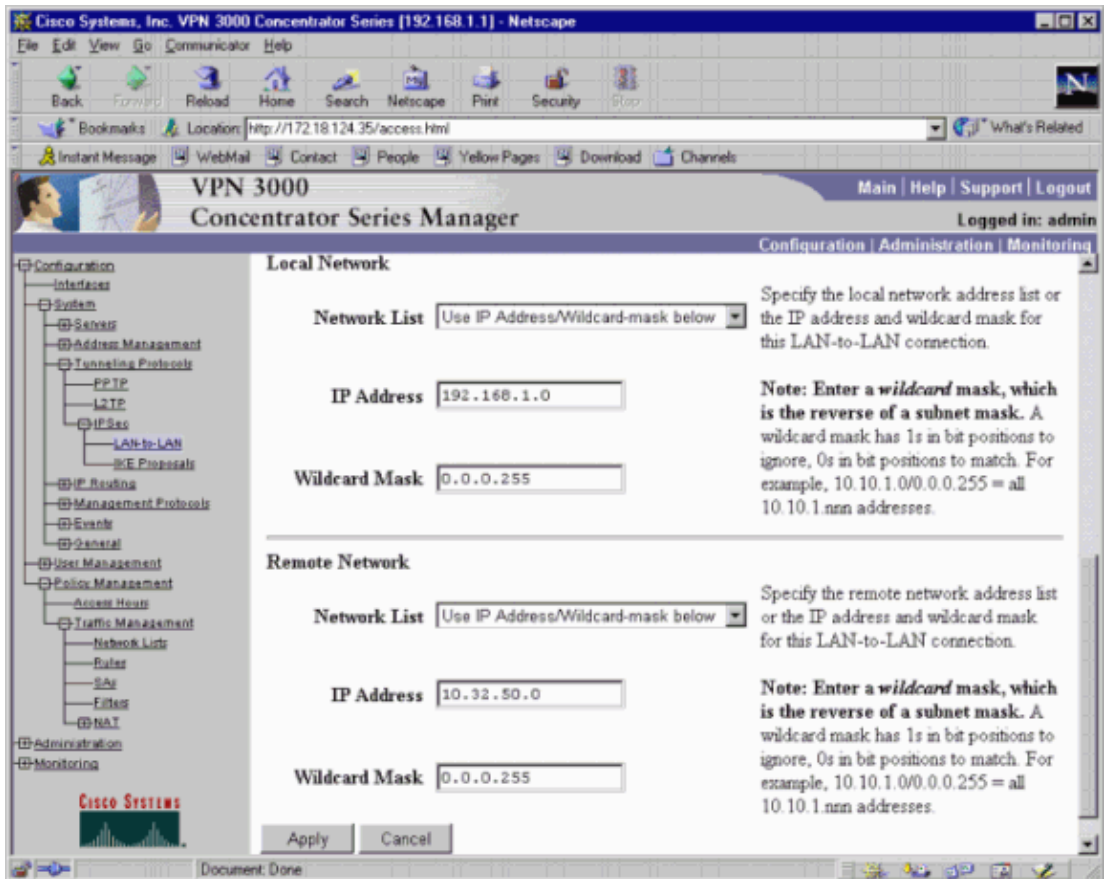

4. Select **Configuration > Policy Management > Traffic Management > Security Associations > Modify**. Verify that Perfect Forward Secrecy is **Disabled** and leave the IPsec Time Lifetime at the default **28800** seconds.

Note: The valid range for the VPN Concentrator IPsec lifetime is 60–2147483647 seconds.

Cisco Systems, Inc. VPN 3000 Concentrator Series [192.168.1.1] - Netscape

File Edit View Go Communicator Help

Back Forward Reload Home Search Netscape Print Security Stop

Bookmarks Location: http://172.18.124.35/access.html What's Related

Instant Message WebMail Contact People Yellow Pages Download Channels

VPN 3000 Concentrator Series Manager Main | Help | Support | Logout

Configuration | Administration | Monitoring

Configuration | Policy Management | Traffic Management | Security Associations | Modify

Modify a configured Security Association.

SA Name Specify the name of this Security Association (SA).

Inheritance Select the granularity of this SA.

IPSec Parameters

Authentication Algorithm Select the packet authentication algorithm to use.

Encryption Algorithm Select the ESP encryption algorithm to use.

Encapsulation Mode Select the Encapsulation Mode for this SA.

Perfect Forward Secrecy Select the use of Perfect Forward Secrecy.

Lifetime Measurement Select the lifetime measurement of the IPsec keys.

Data Lifetime Specify the data lifetime in kilobytes (KB).

Time Lifetime Specify the time lifetime in seconds.

CISCO SYSTEMS

Document Done

Cisco Systems, Inc. VPN 3000 Concentrator Series [192.168.1.1] - Netscape

File Edit View Go Communicator Help

Back Forward Reload Home Search Netscape Print Security Stop

Bookmarks Location: http://172.18.124.35/access.html What's Related

Instant Message WebMail Contact People Yellow Pages Download Channels

VPN 3000 Concentrator Series Manager Main | Help | Support | Logout

Configuration | Administration | Monitoring

Configuration | Administration | Monitoring

Encryption Algorithm Select the ESP encryption algorithm to use.

Encapsulation Mode Select the Encapsulation Mode for this SA.

Perfect Forward Secrecy Select the use of Perfect Forward Secrecy.

Lifetime Measurement Select the lifetime measurement of the IPsec keys.

Data Lifetime Specify the data lifetime in kilobytes (KB).

Time Lifetime Specify the time lifetime in seconds.

IKE Parameters

IKE Peer Specify the IKE Peer for a LAN-to-LAN IPsec connection.

Negotiation Mode Select the IKE Negotiation mode to use.

Digital Certificate Select the Digital Certificate to use.

IKE Proposal Select the IKE Proposal to use.

Apply Cancel

CISCO SYSTEMS

Document Done

5. Save the configuration.

Configure the Checkpoint 4.1 Firewall

Complete these steps to configure the Checkpoint 4.1 Firewall.

1. Since the IKE and IPsec default lifetimes differ between vendors, select **Properties > Encryption** to set the Checkpoint lifetimes to agree with the VPN Concentrator defaults.

The VPN Concentrator default IKE lifetime is 86400 seconds (=1440 minutes).

The VPN Concentrator default IPsec lifetime is 28800 seconds.

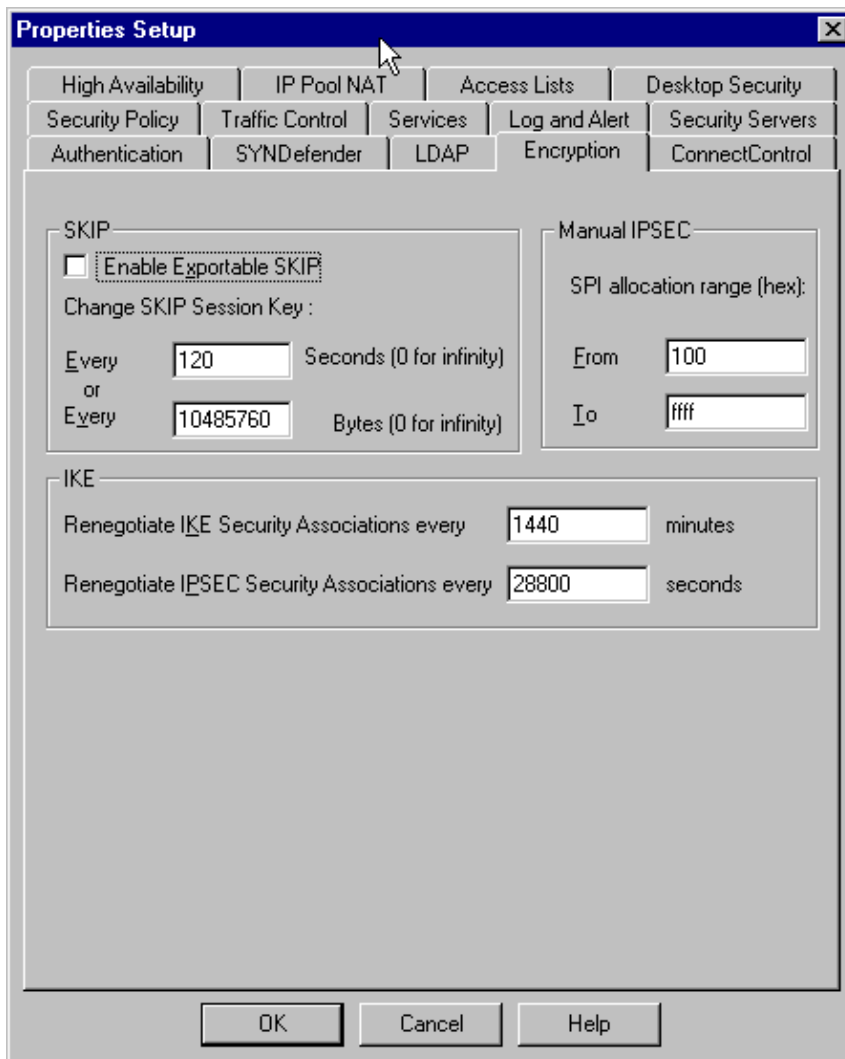

2. Select **Manage > Network objects > New (or Edit) > Network** to configure the object for the internal ("cpinside") network behind the Checkpoint. This should agree with the "Remote Network" in the VPN Concentrator.

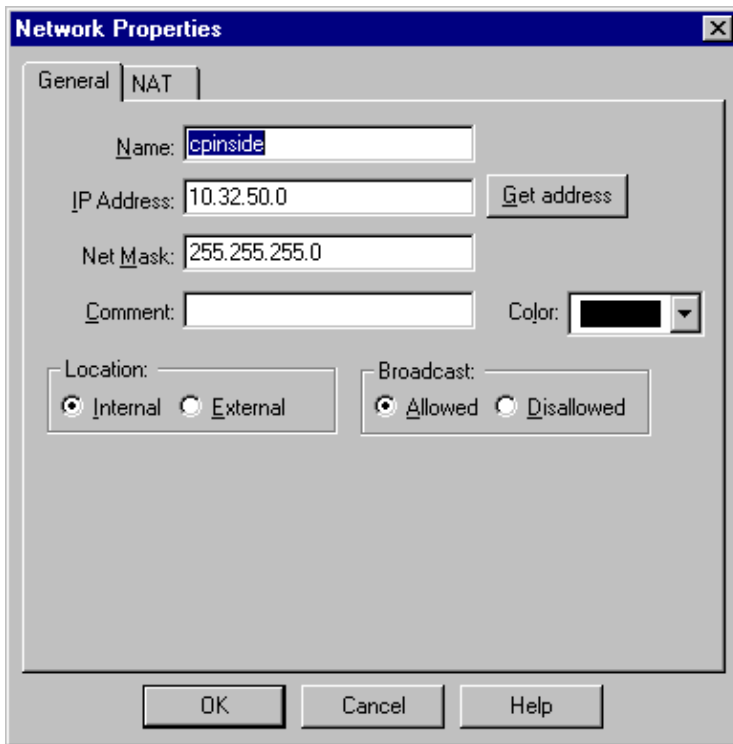

3. Select **Manage > Network objects > Edit** to edit the object for the gateway ("RTPCPVPN" Checkpoint) endpoint that the VPN Concentrator has in its Peer parameter.

Under Location, select **Internal**. For Type, select **Gateway**. Under Modules Installed, check **VPN-1 & FireWall-1** and check **Management Station**.

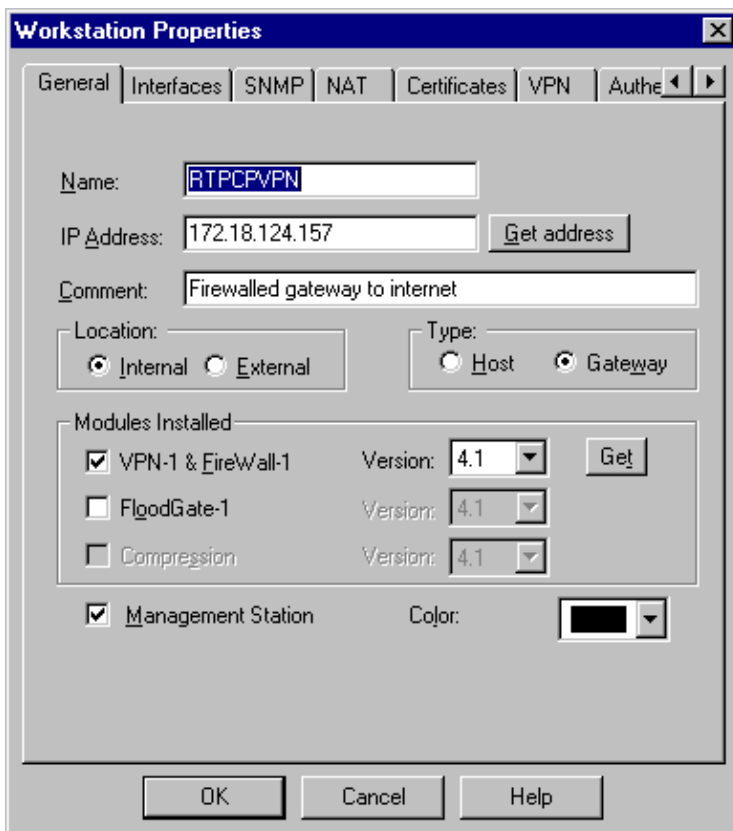

4. Select **Manage > Network objects > New (or Edit) > Network** to configure the object for the external ("inside_cisco") network behind the VPN Concentrator. This should agree with the "Local" network in the VPN Concentrator.

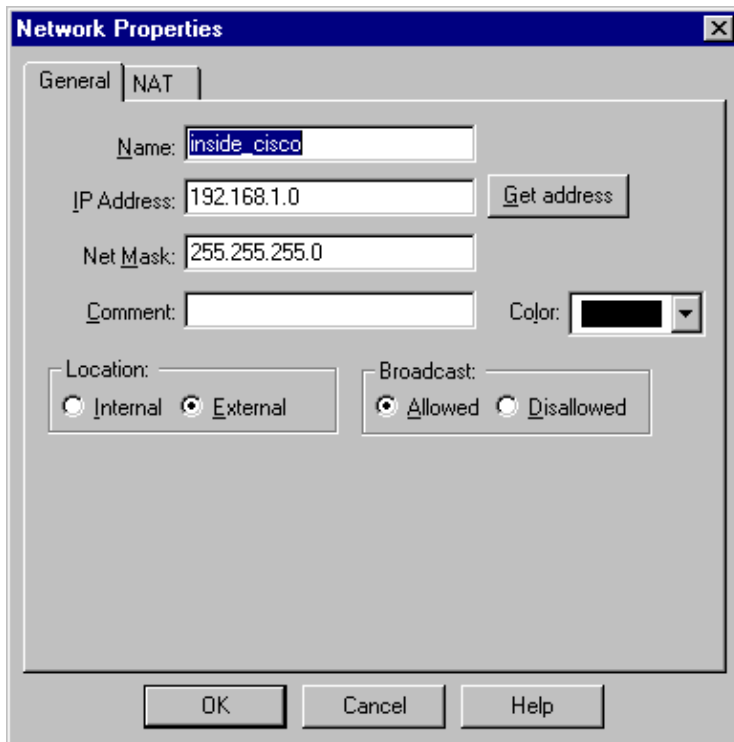

5. Select **Manage > Network objects > New > Workstation** to add an object for the external ("cisco_endpoint") VPN Concentrator gateway. This is the VPN Concentrator "Public" interface.

Under Location, select **External**. For Type, select **Gateway**.

Note: Do not select the VPN-1/FireWall-1 check box.

6. Select **Manage > Network objects > Edit** to edit the Checkpoint gateway endpoint (called "RTCPVPN") VPN tab. Under Domain, select Other and then select the inside of the Checkpoint network (called "cpinside") from the drop-down list. Under Encryption schemes defined, select **IKE**, and then click **Edit**.

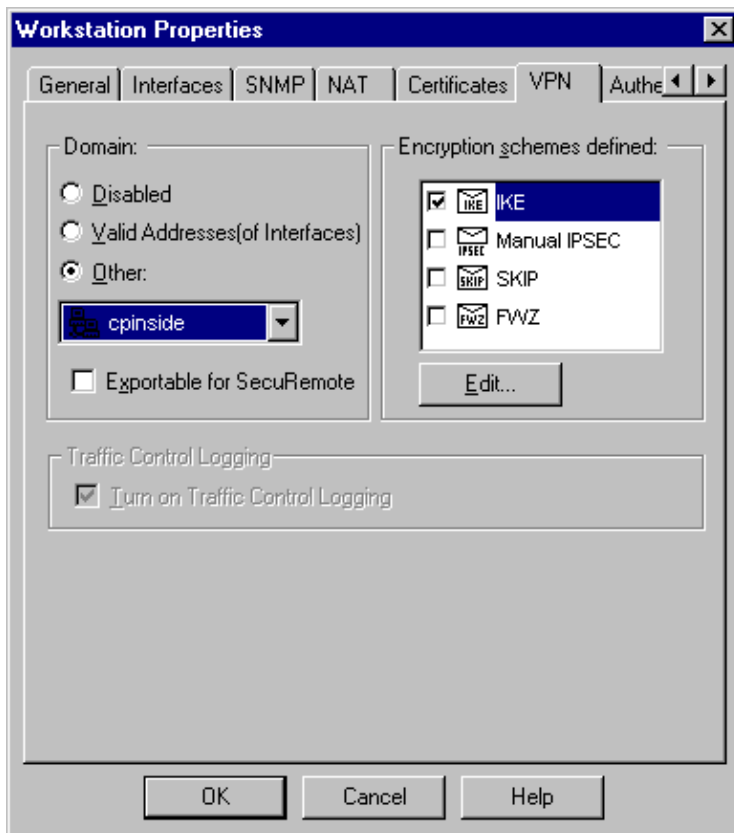

7. Change the IKE properties for DES encryption to agree with the **DES-56** and **Encryption Algorithm** on the VPN Concentrator.
8. Change the IKE properties to SHA1 hashing to agree with the **SHA/HMAC-160** algorithm in the VPN Concentrator.
 - a. De-select **Aggressive Mode**.
 - b. Check **Supports Subnets**.
 - c. Check **Pre-Shared Secret** under Authentication Method. This agrees with the VPN Concentrator Authentication Mode, Preshared Keys.

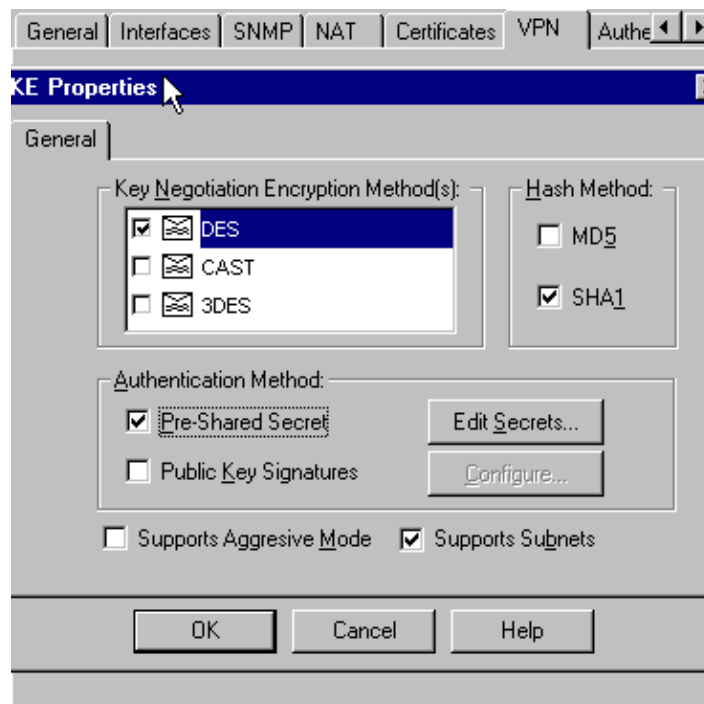

9. Click **Edit Secrets** to set the pre-shared key to agree with the actual VPN Concentrator **Preshared Key**.

isakmp key key address address netmask netmask

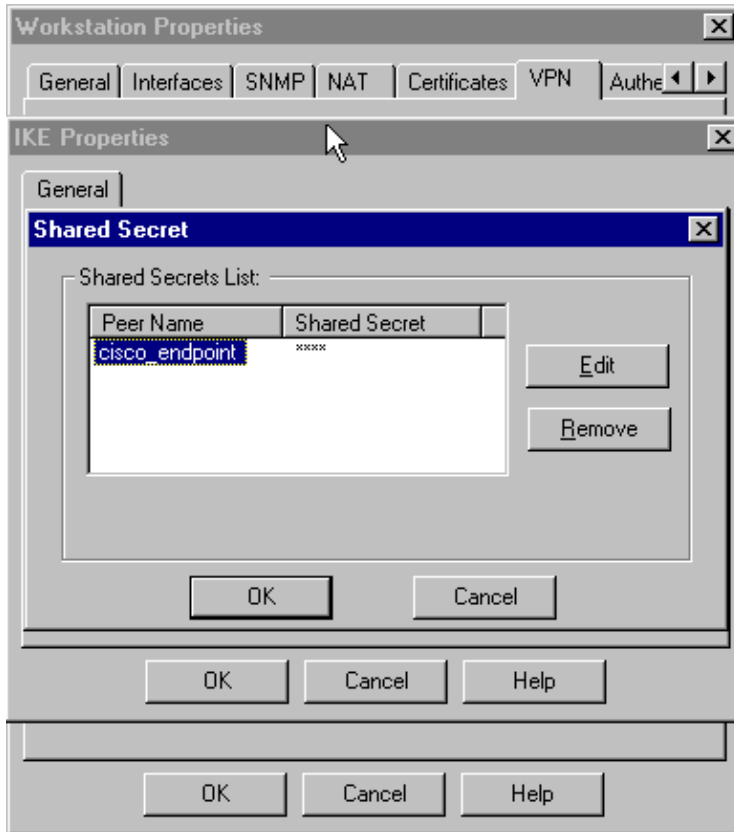

10. Select **Manage > Network objects > Edit** to edit the "cisco_endpoint" VPN tab. Under Domain, select **Other**, and then select the inside of the Cisco network (called "inside_cisco"). Under Encryption schemes defined, select **IKE**, and then click **Edit**.

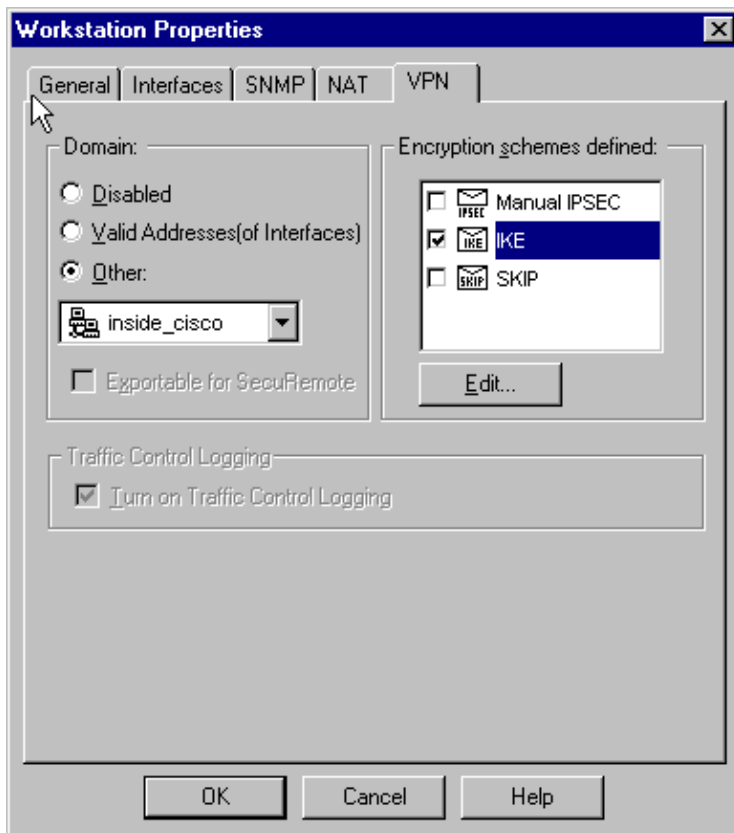

11. Change the IKE properties DES encryption to agree with the **DES-56, Encryption Algorithm** on the VPN Concentrator.
12. Change the IKE properties to SHA1 hashing to agree with the **SHA/HMAC-160** algorithm in the VPN Concentrator.

Change these settings:

- a. Deselect **Aggressive Mode**.
- b. Check **Supports Subnets**.
- c. Check **Pre-Shared Secret** under Authentication Method. This agrees with the VPN Concentrator Authentication Mode of Preshared Keys.

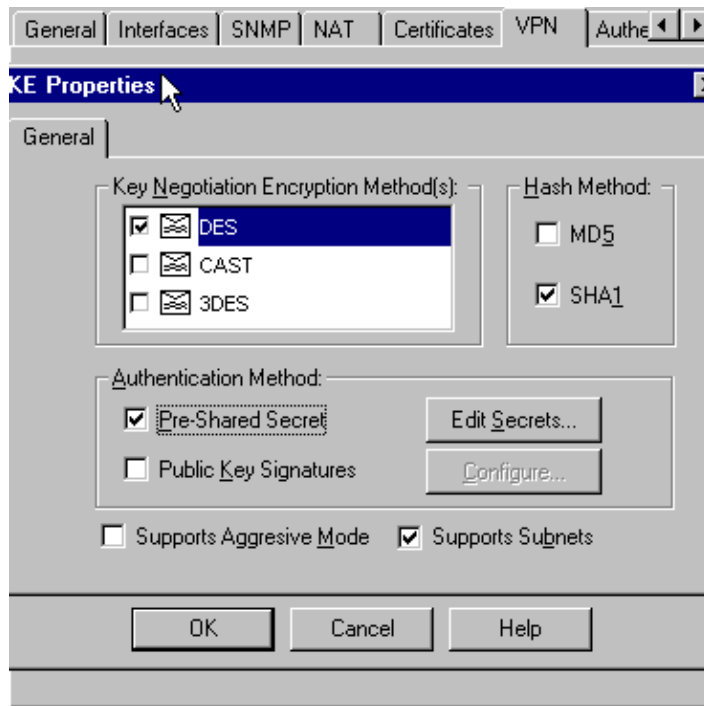

- Click **Edit Secrets** to set the pre-shared key to agree with the actual VPN Concentrator Preshared Key.

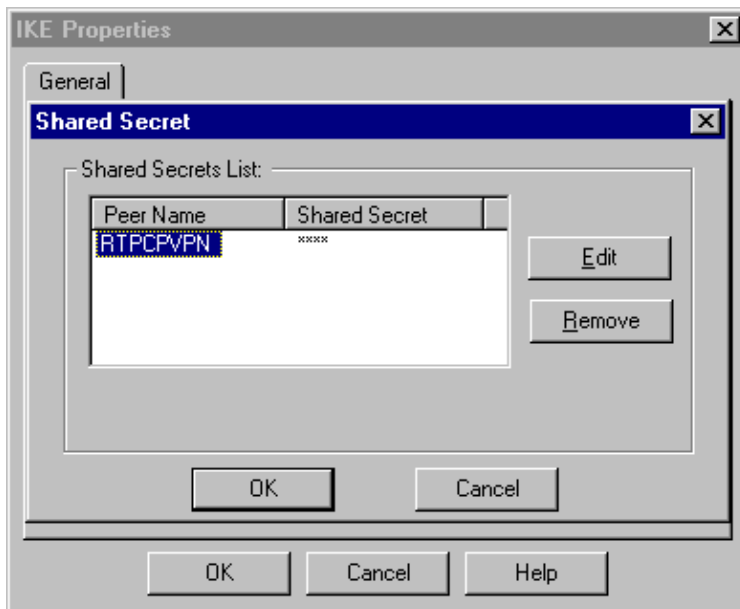

- In the Policy Editor window, insert a rule with both Source and Destination as "inside_cisco" and "cpinside" (bidirectional). Set Service=Any, Action=Encrypt, and Track=Long.

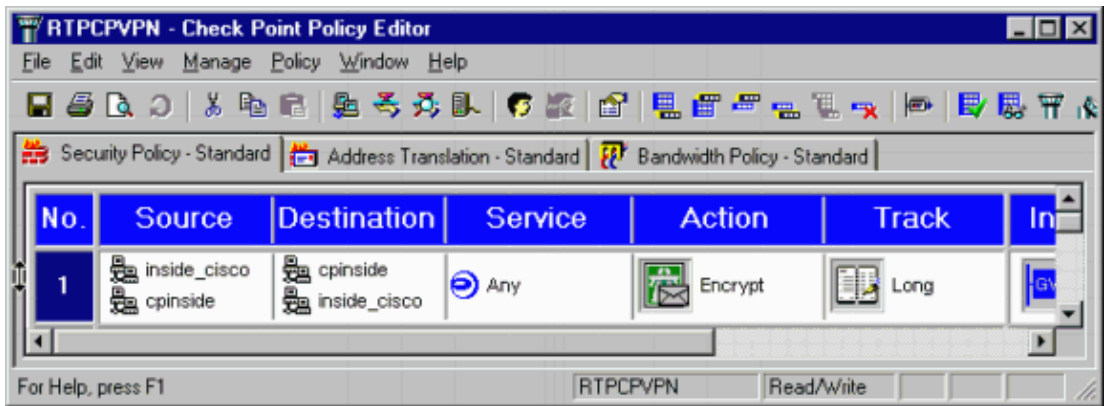

- Under the Action heading, click the green **Encrypt** icon and select **Edit properties** to configure encryption policies.

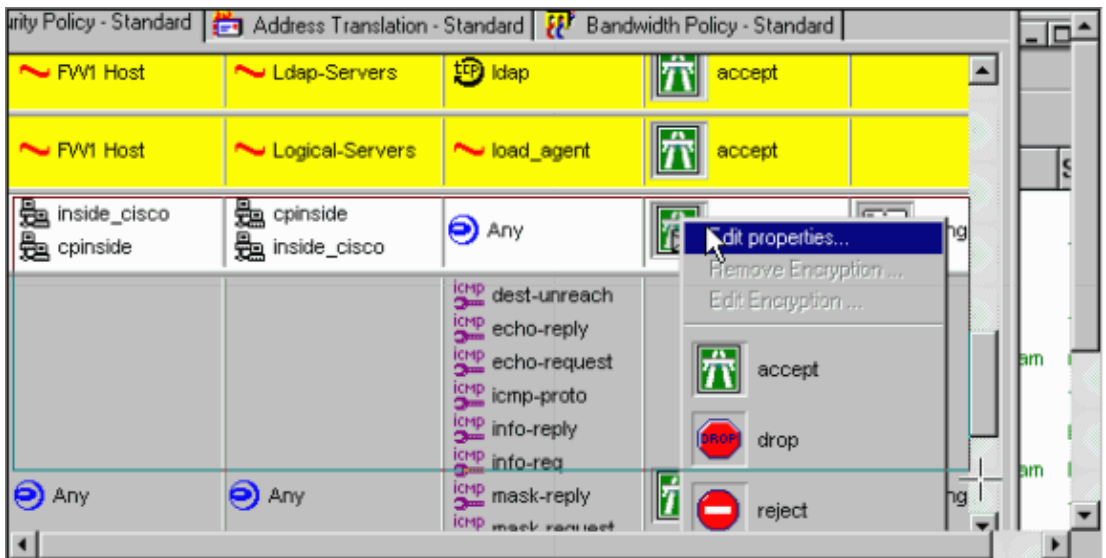

- Select **IKE**, and then click **Edit**.

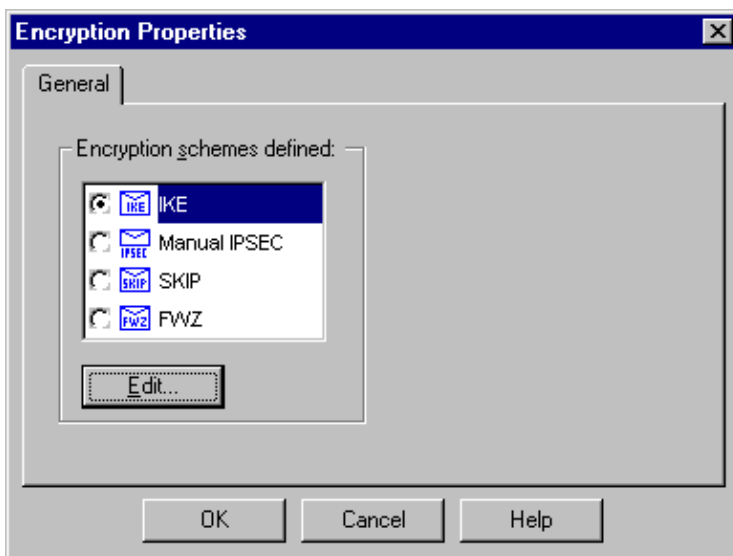

- On the IKE Properties window, change these properties to agree with the VPN Concentrator IPsec transforms.

Under Transform, select **Encryption + Data Integrity (ESP)**. The Encryption Algorithm should be **DES**, Data Integrity should be **SHA1**, and the Allowed Peer Gateway should be the external Cisco gateway (called "cisco_endpoint"). Click **OK**.

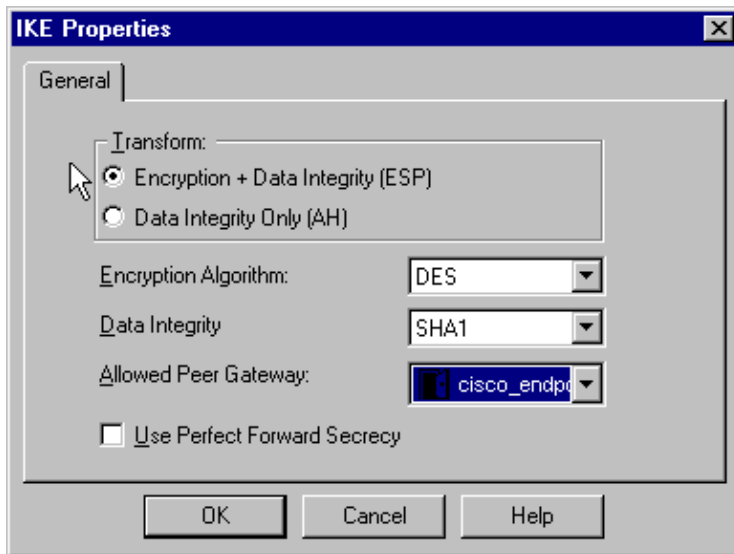

18. After you configure the Checkpoint, select **Policy > Install** on the Checkpoint menu to have the changes take effect.

Verify

There is currently no verification procedure available for this configuration.

Troubleshoot

This section provides information you can use to troubleshoot your configuration.

Network Summarization

When multiple adjacent inside networks are configured in the encryption domain on the Checkpoint, the device might automatically summarize them with regard to interesting traffic. If the VPN Concentrator is not configured to match, the tunnel is likely to fail. For example, if the inside networks of 10.0.0.0 /24 and 10.0.1.0 /24 are configured to be included in the tunnel, they might be summarized to 10.0.0.0 /23.

VPN 3000 Concentrator Debug

Possible VPN Concentrator debugs include IKE, IKEDBG, IKEDECODE, IPSEC, IPSECDBG, IPSECDECODE. This is set up in **Configuration > System > Events > Classes**.

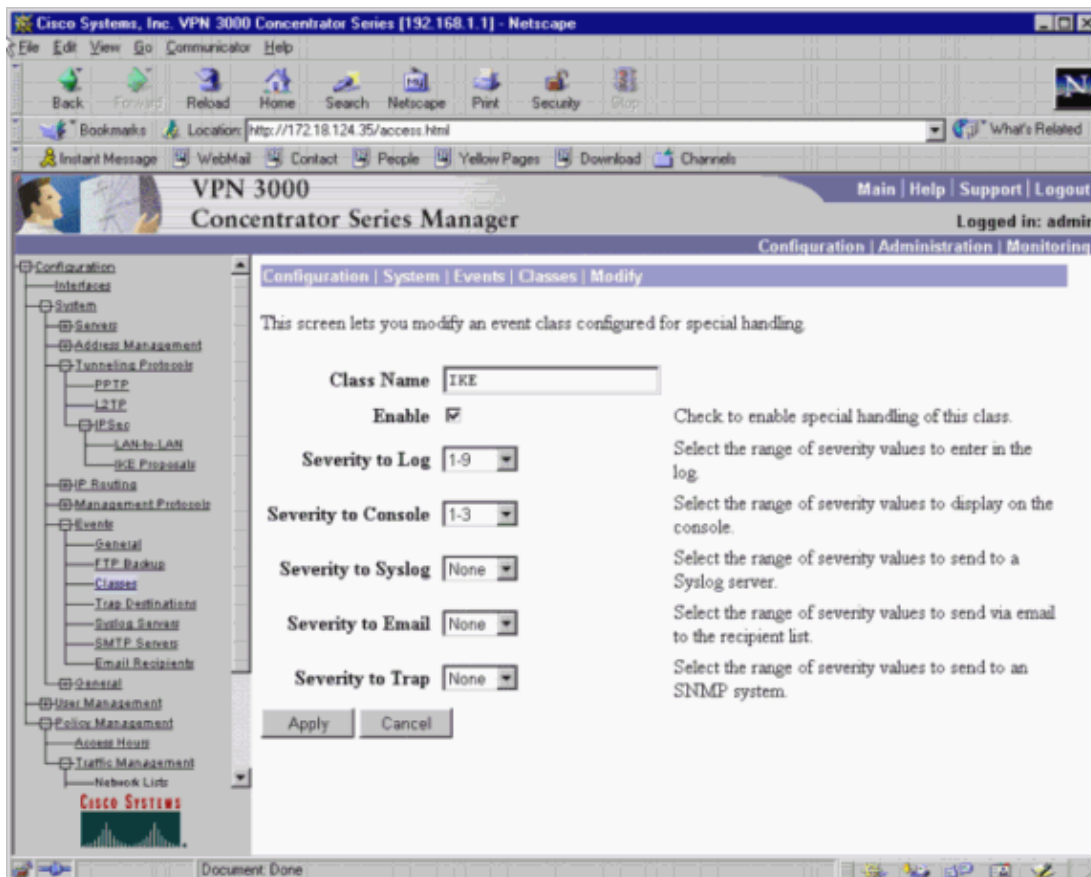
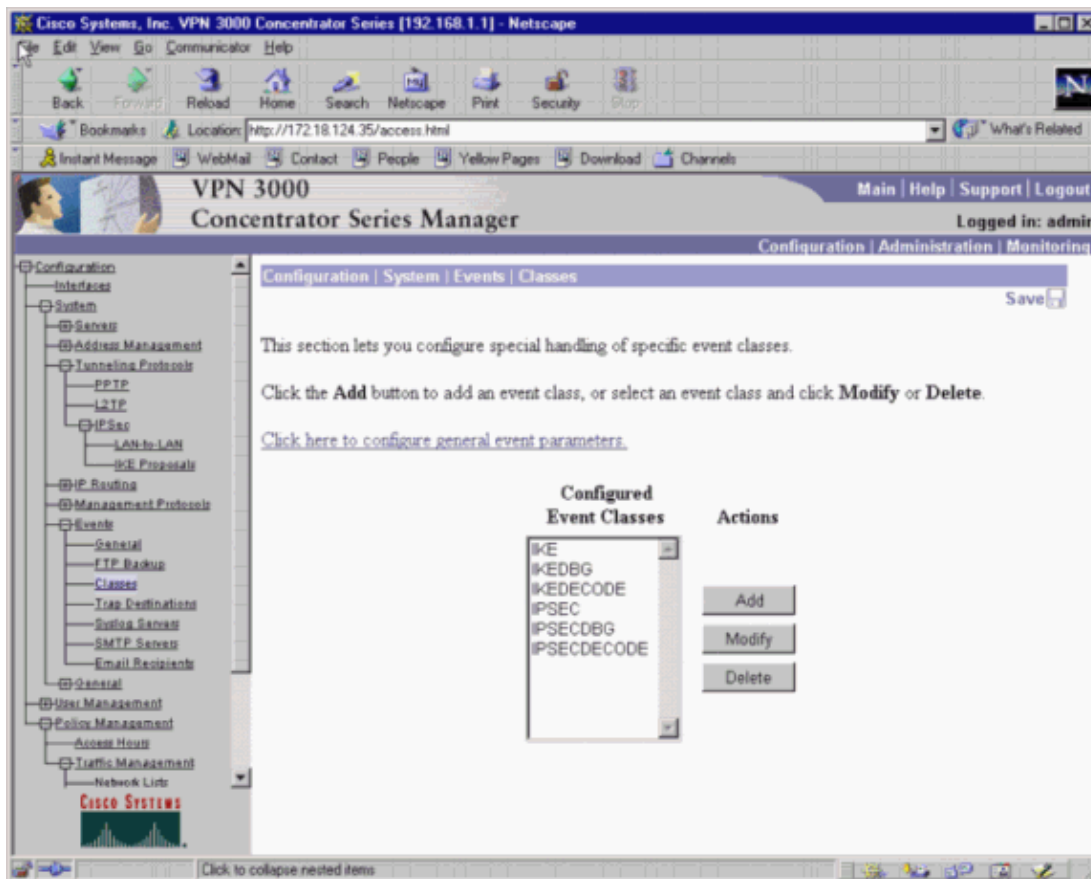

You can view debugs in **Monitoring > Event log > Get Log**.

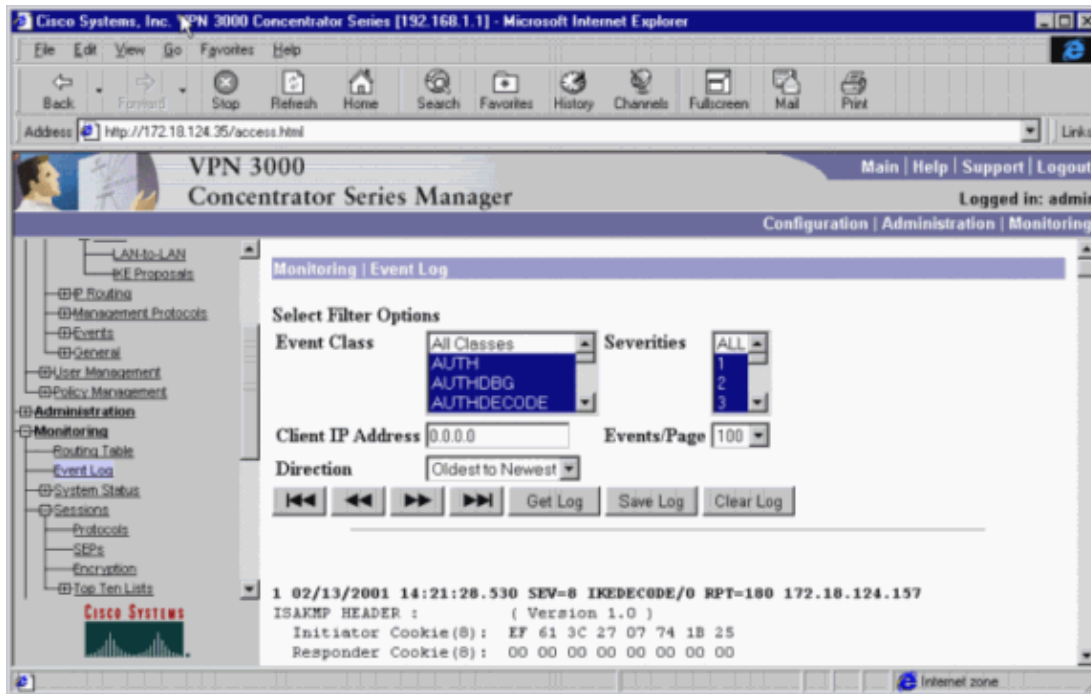

Select **Monitoring** > **Sessions** to monitor the LAN-to-LAN tunnel traffic.

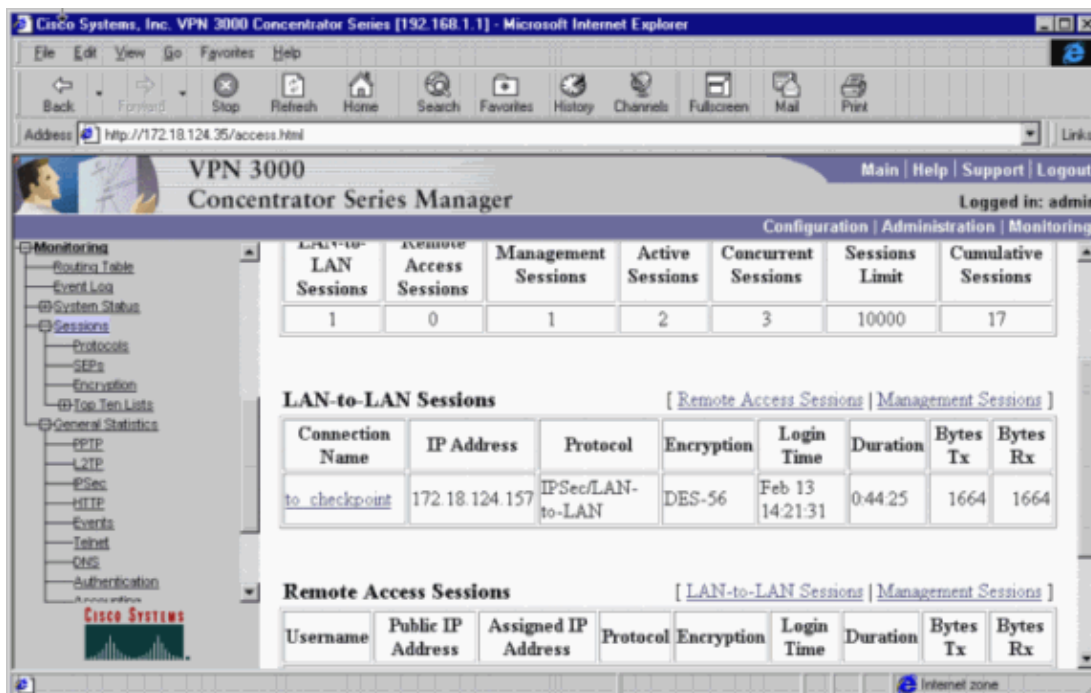

Select **Administration** > **Administer Sessions** > **LAN-to-LAN sessions** > **Actions** – **Logout** to clear the tunnel.

Checkpoint 4.1 Firewall Debug

Note: This was a Microsoft Windows NT installation. Because the Tracking was set for Long in the Policy Editor window, denied traffic should appear in red in the Log Viewer. More verbose debug can be obtained with:

```
C:\WINNT\FW1\4.1\fwstop
C:\WINNT\FW1\4.1\fw d -d
```

and in another window:

```
C:\WINNT\FW1\4.1\fwstart
```

Issue these commands to clear SAs on the Checkpoint:

```
fw tab -t IKE_SA_table -x
fw tab -t ISAKMP_ESP_table -x
fw tab -t inbound_SPI -x
fw tab -t ISAKMP_AH_table -x
```

Answer **yes** at the Are you sure? prompt.

Sample Debug Output

Cisco VPN 3000 Concentrator

```
1 02/13/2001 14:21:28.530 SEV=8 IKEDECODE/0 RPT=180 172.18.124.157
ISAKMP HEADER :      ( Version 1.0 )
  Initiator Cookie(8): EF 61 3C 27 07 74 1B 25
  Responder Cookie(8): 00 00 00 00 00 00 00 00
  Next Payload   :      SA (1)
  Exchange Type  :      Oakley Main Mode
  Flags          :      0
  Message ID     :      0
  Length         :      164

7 02/13/2001 14:21:28.530 SEV=8 IKEDBG/0 RPT=406 172.18.124.157
RECEIVED Message (msgid=0) with payloads :
HDR + SA (1) + VENDOR (13) + NONE (0) ... total length : 164

9 02/13/2001 14:21:28.530 SEV=9 IKEDBG/0 RPT=407 172.18.124.157
processing SA payload

10 02/13/2001 14:21:28.530 SEV=8 IKEDECODE/0 RPT=181 172.18.124.157
SA Payload Decode :
  DOI           :      IPSEC (1)
  Situation     :      Identity Only (1)
  Length       :      92

13 02/13/2001 14:21:28.530 SEV=8 IKEDECODE/0 RPT=182 172.18.124.157
Proposal Decode:
  Proposal #    :      1
  Protocol ID   :      ISAKMP (1)
  #of Transforms:      2
  Length       :      80

16 02/13/2001 14:21:28.530 SEV=8 IKEDECODE/0 RPT=183 172.18.124.157
Transform # 1 Decode for Proposal # 1:
  Transform #   :      1
  Transform ID  :      IKE (1)
  Length       :      36

18 02/13/2001 14:21:28.530 SEV=8 IKEDECODE/0 RPT=184 172.18.124.157
Phase 1 SA Attribute Decode for Transform # 1:
  Encryption Alg:      DES-CBC (1)
  Hash Alg       :      SHA (2)
  Auth Method    :      Preshared Key (1)
  DH Group       :      Oakley Group 2 (2)
  Life Time      :      86400 seconds

23 02/13/2001 14:21:28.530 SEV=8 IKEDECODE/0 RPT=185 172.18.124.157
Transform # 2 Decode for Proposal # 1:
```

```
Transform #      :      2
Transform ID    :      IKE (1)
Length         :      36

25 02/13/2001 14:21:28.530 SEV=8 IKEDECODE/0 RPT=186 172.18.124.157
Phase 1 SA Attribute Decode for Transform # 2:
Encryption Alg:      DES-CBC (1)
Hash Alg           :      SHA (2)
Auth Method        :      Preshared Key (1)
DH Group           :      Oakley Group 1 (1)
Life Time          :      86400 seconds

30 02/13/2001 14:21:28.530 SEV=8 IKEDBG/0 RPT=408 172.18.124.157
Proposal # 1, Transform # 1, Type ISAKMP, Id IKE
Parsing received transform:
Phase 1 failure against global IKE proposal # 1:
Mismatched attr types for class DH Group:
  Rcv'd: Oakley Group 2
  Cfg'd: Oakley Group 1

35 02/13/2001 14:21:28.530 SEV=8 IKEDBG/0 RPT=409 172.18.124.157
Phase 1 failure against global IKE proposal # 2:
Mismatched attr types for class DH Group:
  Rcv'd: Oakley Group 2
  Cfg'd: Oakley Group 1

38 02/13/2001 14:21:28.530 SEV=8 IKEDBG/0 RPT=410 172.18.124.157
Phase 1 failure against global IKE proposal # 3:
Mismatched attr types for class Encryption Alg:
  Rcv'd: DES-CBC
  Cfg'd: Triple-DES

41 02/13/2001 14:21:28.530 SEV=7 IKEDBG/0 RPT=411 172.18.124.157
Oakley proposal is acceptable

42 02/13/2001 14:21:28.530 SEV=9 IKEDBG/1 RPT=107 172.18.124.157
processing vid payload

43 02/13/2001 14:21:28.530 SEV=9 IKEDBG/0 RPT=412 172.18.124.157
processing IKE SA

44 02/13/2001 14:21:28.530 SEV=8 IKEDBG/0 RPT=413 172.18.124.157
Proposal # 1, Transform # 1, Type ISAKMP, Id IKE
Parsing received transform:
Phase 1 failure against global IKE proposal # 1:
Mismatched attr types for class DH Group:
  Rcv'd: Oakley Group 2
  Cfg'd: Oakley Group 1

49 02/13/2001 14:21:28.530 SEV=8 IKEDBG/0 RPT=414 172.18.124.157
Phase 1 failure against global IKE proposal # 2:
Mismatched attr types for class DH Group:
  Rcv'd: Oakley Group 2
  Cfg'd: Oakley Group 1

52 02/13/2001 14:21:28.530 SEV=8 IKEDBG/0 RPT=415 172.18.124.157
Phase 1 failure against global IKE proposal # 3:
Mismatched attr types for class Encryption Alg:
  Rcv'd: DES-CBC
  Cfg'd: Triple-DES

55 02/13/2001 14:21:28.530 SEV=7 IKEDBG/28 RPT=3 172.18.124.157
IKE SA Proposal # 1, Transform # 2 acceptable
Matches global IKE entry # 1

56 02/13/2001 14:21:28.530 SEV=9 IKEDBG/0 RPT=416 172.18.124.157
```

constructing ISA_SA for isakmp

57 02/13/2001 14:21:28.530 SEV=8 IKEDBG/0 RPT=417 172.18.124.157
SENDING Message (msgid=0) with payloads :
HDR + SA (1) ... total length : 84

58 02/13/2001 14:21:28.630 SEV=8 IKEDECODE/0 RPT=187 172.18.124.157
ISAKMP HEADER : (Version 1.0)
Initiator Cookie(8): EF 61 3C 27 07 74 1B 25
Responder Cookie(8): 24 18 40 A1 3B E4 95 26
Next Payload : KE (4)
Exchange Type : Oakley Main Mode
Flags : 0
Message ID : 0
Length : 152

64 02/13/2001 14:21:28.630 SEV=8 IKEDBG/0 RPT=418 172.18.124.157
RECEIVED Message (msgid=0) with payloads :
HDR + KE (4) + NONCE (10) + NONE (0) ... total length : 152

66 02/13/2001 14:21:28.630 SEV=8 IKEDBG/0 RPT=419 172.18.124.157
RECEIVED Message (msgid=0) with payloads :
HDR + KE (4) + NONCE (10) + NONE (0) ... total length : 152

68 02/13/2001 14:21:28.630 SEV=9 IKEDBG/0 RPT=420 172.18.124.157
processing ke payload

69 02/13/2001 14:21:28.630 SEV=9 IKEDBG/0 RPT=421 172.18.124.157
processing ISA_KE

70 02/13/2001 14:21:28.630 SEV=9 IKEDBG/1 RPT=108 172.18.124.157
processing nonce payload

71 02/13/2001 14:21:28.650 SEV=9 IKEDBG/0 RPT=422 172.18.124.157
constructing ke payload

72 02/13/2001 14:21:28.650 SEV=9 IKEDBG/1 RPT=109 172.18.124.157
constructing nonce payload

73 02/13/2001 14:21:28.650 SEV=9 IKEDBG/38 RPT=7 172.18.124.157
Constructing VPN 3000 spoofing IOS Vendor ID payload (version: 1.0.0, capabilities: 20000001)

75 02/13/2001 14:21:28.650 SEV=9 IKEDBG/1 RPT=110 172.18.124.157
constructing vid payload

76 02/13/2001 14:21:28.650 SEV=9 IKE/0 RPT=26 172.18.124.157
Generating keys for Responder...

77 02/13/2001 14:21:28.650 SEV=8 IKEDBG/0 RPT=423 172.18.124.157
SENDING Message (msgid=0) with payloads :
HDR + KE (4) ... total length : 192

78 02/13/2001 14:21:28.770 SEV=8 IKEDECODE/0 RPT=188 172.18.124.157
ISAKMP HEADER : (Version 1.0)
Initiator Cookie(8): EF 61 3C 27 07 74 1B 25
Responder Cookie(8): 24 18 40 A1 3B E4 95 26
Next Payload : ID (5)
Exchange Type : Oakley Main Mode
Flags : 1 (ENCRYPT)
Message ID : 0
Length : 68

84 02/13/2001 14:21:28.770 SEV=8 IKEDBG/0 RPT=424 172.18.124.157
RECEIVED Message (msgid=0) with payloads :
HDR + ID (5) + HASH (8) + NONE (0) ... total length : 64

86 02/13/2001 14:21:28.770 SEV=9 IKEDBG/1 RPT=111 172.18.124.157
Processing ID

87 02/13/2001 14:21:28.770 SEV=9 IKEDBG/0 RPT=425 172.18.124.157
processing hash

88 02/13/2001 14:21:28.770 SEV=9 IKEDBG/0 RPT=426 172.18.124.157
computing hash

89 02/13/2001 14:21:28.770 SEV=9 IKEDBG/23 RPT=7 172.18.124.157
Starting group lookup for peer 172.18.124.157

90 02/13/2001 14:21:28.870 SEV=7 IKEDBG/0 RPT=427 172.18.124.157
Found Phase 1 Group (172.18.124.157)

91 02/13/2001 14:21:28.870 SEV=7 IKEDBG/14 RPT=7 172.18.124.157
Authentication configured for Internal

92 02/13/2001 14:21:28.870 SEV=9 IKEDBG/1 RPT=112 172.18.124.157
constructing ID

93 02/13/2001 14:21:28.870 SEV=9 IKEDBG/0 RPT=428
construct hash payload

94 02/13/2001 14:21:28.870 SEV=9 IKEDBG/0 RPT=429 172.18.124.157
computing hash

95 02/13/2001 14:21:28.870 SEV=8 IKEDBG/0 RPT=430 172.18.124.157
SENDING Message (msgid=0) with payloads :
HDR + ID (5) ... total length : 64

96 02/13/2001 14:21:28.870 SEV=7 IKEDBG/0 RPT=431 172.18.124.157
Starting phase 1 rekey timer

97 02/13/2001 14:21:29.030 SEV=8 IKEDECODE/0 RPT=189 172.18.124.157
ISAKMP HEADER : (Version 1.0)
Initiator Cookie(8): EF 61 3C 27 07 74 1B 25
Responder Cookie(8): 24 18 40 A1 3B E4 95 26
Next Payload : HASH (8)
Exchange Type : Oakley Quick Mode
Flags : 1 (ENCRYPT)
Message ID : 7755aa11
Length : 164

104 02/13/2001 14:21:29.030 SEV=8 IKEDBG/0 RPT=432 172.18.124.157
RECEIVED Message (msgid=7755aa11) with payloads :
HDR + HASH (8) + SA (1) + NONCE (10) + ID (5) + ID (5) + NONE (0) ... total leng
th : 160

107 02/13/2001 14:21:29.030 SEV=9 IKEDBG/0 RPT=433 172.18.124.157
processing hash

108 02/13/2001 14:21:29.030 SEV=9 IKEDBG/0 RPT=434 172.18.124.157
processing SA payload

109 02/13/2001 14:21:29.030 SEV=8 IKEDECODE/0 RPT=190 172.18.124.157
SA Payload Decode :
DOI : IPSEC (1)
Situation : Identity Only (1)
Length : 52

112 02/13/2001 14:21:29.030 SEV=8 IKEDECODE/0 RPT=191 172.18.124.157
Proposal Decode:
Proposal # : 1

```
Protocol ID      :      ESP (3)
#of Transforms:      1
Spi             :      DA 16 3F E3
Length         :      40

116 02/13/2001 14:21:29.030 SEV=8 IKEDECODE/0 RPT=192 172.18.124.157
Transform # 1 Decode for Proposal # 1:
  Transform #    :      1
  Transform ID   :      DES-CBC (2)
  Length        :      28

118 02/13/2001 14:21:29.030 SEV=8 IKEDECODE/0 RPT=193 172.18.124.157
Phase 2 SA Attribute Decode for Transform # 1:
  Life Time     :      28800 seconds
  HMAC Algorithm:      SHA (2)
  Encapsulation :      Tunnel (1)

121 02/13/2001 14:21:29.030 SEV=9 IKEDBG/1 RPT=113 172.18.124.157
processing nonce payload

122 02/13/2001 14:21:29.030 SEV=9 IKEDBG/1 RPT=114 172.18.124.157
Processing ID

123 02/13/2001 14:21:29.030 SEV=5 IKE/35 RPT=14 172.18.124.157
Received remote IP Proxy Subnet data in ID Payload:
  Address 10.32.50.0, Mask 255.255.255.0, Protocol 0, Port 0

125 02/13/2001 14:21:29.030 SEV=9 IKEDBG/1 RPT=115 172.18.124.157
Processing ID

126 02/13/2001 14:21:29.030 SEV=5 IKE/34 RPT=14 172.18.124.157
Received local IP Proxy Subnet data in ID Payload:
  Address 192.168.1.0, Mask 255.255.255.0, Protocol 0, Port 0

128 02/13/2001 14:21:29.030 SEV=5 IKE/66 RPT=4 172.18.124.157
IKE Remote Peer configured for SA: L2L: to_checkpoint

129 02/13/2001 14:21:29.030 SEV=9 IKEDBG/0 RPT=435 172.18.124.157
processing IPSEC SA

130 02/13/2001 14:21:29.030 SEV=7 IKEDBG/27 RPT=1 172.18.124.157
IPSec SA Proposal # 1, Transform # 1 acceptable

131 02/13/2001 14:21:29.030 SEV=7 IKEDBG/0 RPT=436 172.18.124.157
IKE: requesting SPI!

132 02/13/2001 14:21:29.030 SEV=8 IKEDBG/6 RPT=6
IKE got SPI from key engine: SPI = 0x4d6e483f

133 02/13/2001 14:21:29.030 SEV=9 IKEDBG/0 RPT=437 172.18.124.157
oakley constructing quick mode

134 02/13/2001 14:21:29.030 SEV=9 IKEDBG/0 RPT=438 172.18.124.157
constructing blank hash

135 02/13/2001 14:21:29.030 SEV=9 IKEDBG/0 RPT=439 172.18.124.157
constructing ISA_SA for ipsec

136 02/13/2001 14:21:29.030 SEV=9 IKEDBG/1 RPT=116 172.18.124.157
constructing ipsec nonce payload

137 02/13/2001 14:21:29.030 SEV=9 IKEDBG/1 RPT=117 172.18.124.157
constructing proxy ID

138 02/13/2001 14:21:29.030 SEV=7 IKEDBG/0 RPT=440 172.18.124.157
Transmitting Proxy Id:
```

Remote subnet: 10.32.50.0 Mask 255.255.255.0 Protocol 0 Port 0
Local subnet: 192.168.1.0 mask 255.255.255.0 Protocol 0 Port 0

141 02/13/2001 14:21:29.030 SEV=9 IKEDBG/0 RPT=441 172.18.124.157
constructing qm hash

142 02/13/2001 14:21:29.030 SEV=8 IKEDBG/0 RPT=442 172.18.124.157
SENDING Message (msgid=7755aall) with payloads :
HDR + HASH (8) ... total length : 156

144 02/13/2001 14:21:29.270 SEV=8 IKEDECODE/0 RPT=194 172.18.124.157
ISAKMP HEADER : (Version 1.0)
Initiator Cookie(8): EF 61 3C 27 07 74 1B 25
Responder Cookie(8): 24 18 40 A1 3B E4 95 26
Next Payload : HASH (8)
Exchange Type : Oakley Quick Mode
Flags : 1 (ENCRYPT)
Message ID : 7755aall
Length : 60

151 02/13/2001 14:21:29.270 SEV=8 IKEDBG/0 RPT=443 172.18.124.157
RECEIVED Message (msgid=7755aall) with payloads :
HDR + HASH (8) + NONE (0) ... total length : 52

153 02/13/2001 14:21:29.270 SEV=9 IKEDBG/0 RPT=444 172.18.124.157
processing hash

154 02/13/2001 14:21:29.270 SEV=9 IKEDBG/0 RPT=445 172.18.124.157
loading all IPSEC SAs

155 02/13/2001 14:21:29.270 SEV=9 IKEDBG/1 RPT=118 172.18.124.157
Generating Quick Mode Key!

156 02/13/2001 14:21:29.270 SEV=9 IKEDBG/1 RPT=119 172.18.124.157
Generating Quick Mode Key!

157 02/13/2001 14:21:29.270 SEV=7 IKEDBG/0 RPT=446 172.18.124.157
Loading subnet:
Dst: 192.168.1.0 mask: 255.255.255.0
Src: 10.32.50.0 mask: 255.255.255.0

159 02/13/2001 14:21:29.270 SEV=4 IKE/49 RPT=6 172.18.124.157
Security negotiation complete for LAN-to-LAN Group (172.18.124.157)
Responder, Inbound SPI = 0x4d6e483f, Outbound SPI = 0xda163fe3

161 02/13/2001 14:21:29.270 SEV=8 IKEDBG/7 RPT=6
IKE got a KEY_ADD msg for SA: SPI = 0xda163fe3

162 02/13/2001 14:21:29.270 SEV=8 IKEDBG/0 RPT=447
pitcher: rcv KEY_UPDATE, spi 0x4d6e483f

163 02/13/2001 14:21:29.670 SEV=8 IKEDECODE/0 RPT=195 172.18.124.157
ISAKMP HEADER : (Version 1.0)
Initiator Cookie(8): EF 61 3C 27 07 74 1B 25
Responder Cookie(8): 24 18 40 A1 3B E4 95 26
Next Payload : HASH (8)
Exchange Type : Oakley Quick Mode
Flags : 1 (ENCRYPT)
Message ID : 7755aall
Length : 60

170 02/13/2001 14:21:29.670 SEV=6 IKE/0 RPT=27 172.18.124.157
Duplicate Phase 2 packet detected!

171 02/13/2001 14:21:29.760 SEV=8 IKEDECODE/0 RPT=196 172.18.124.157
ISAKMP HEADER : (Version 1.0)

Initiator Cookie(8): EF 61 3C 27 07 74 1B 25
Responder Cookie(8): 24 18 40 A1 3B E4 95 26
Next Payload : HASH (8)
Exchange Type : Oakley Quick Mode
Flags : 1 (ENCRYPT)
Message ID : 7755aall
Length : 60

178 02/13/2001 14:21:29.760 SEV=6 IKE/0 RPT=28 172.18.124.157
Duplicate Phase 2 packet detected!

179 02/13/2001 14:21:29.880 SEV=8 IKEDBG/0 RPT=448
pitcher: recv KEY_SA_ACTIVE spi 0x4d6e483f

180 02/13/2001 14:21:29.880 SEV=8 IKEDBG/0 RPT=449
KEY_SA_ACTIVE old rekey centry found with new spi 0x4d6e483f

181 02/13/2001 14:21:29.880 SEV=7 IKEDBG/9 RPT=5 172.18.124.157
IKE Deleting SA: Remote Proxy 10.32.50.0, Local Proxy 192.168.1.0

182 02/13/2001 14:21:29.880 SEV=9 IKEDBG/0 RPT=450 172.18.124.157
IKE SA MM:f2ea8e68 rcv'd Terminate: state MM_ACTIVE_REKEY
flags 0x000000e6, refcnt 1, tuncnt 0

184 02/13/2001 14:21:29.880 SEV=9 IKEDBG/0 RPT=451 172.18.124.157
IKE SA MM:f2ea8e68 terminating:
flags 0x000000a6, refcnt 0, tuncnt 0

185 02/13/2001 14:21:29.880 SEV=9 IKEDBG/0 RPT=452
sending delete message

186 02/13/2001 14:21:29.880 SEV=9 IKEDBG/0 RPT=453 172.18.124.157
constructing blank hash

187 02/13/2001 14:21:29.880 SEV=9 IKEDBG/0 RPT=454
constructing delete payload

188 02/13/2001 14:21:29.880 SEV=9 IKEDBG/0 RPT=455 172.18.124.157
constructing qm hash

189 02/13/2001 14:21:29.880 SEV=8 IKEDBG/0 RPT=456 172.18.124.157
SENDING Message (msgid=87b7cla4) with payloads :
HDR + HASH (8) ... total length : 80

191 02/13/2001 14:21:29.880 SEV=9 IKEDBG/0 RPT=457 172.18.124.157
IKE SA MM:241840al rcv'd Terminate: state MM_REKEY_DONE
flags 0x00000082, refcnt 1, tuncnt 1

193 02/13/2001 14:21:29.880 SEV=6 IKE/0 RPT=29 172.18.124.157
Removing peer from peer table failed, no match!

194 02/13/2001 14:21:29.880 SEV=9 IKEDBG/0 RPT=458
sending delete message

195 02/13/2001 14:21:29.880 SEV=9 IKEDBG/0 RPT=459 172.18.124.157
constructing blank hash

196 02/13/2001 14:21:29.880 SEV=9 IKEDBG/0 RPT=460
constructing ipsec delete payload

197 02/13/2001 14:21:29.880 SEV=9 IKEDBG/0 RPT=461 172.18.124.157
constructing qm hash

198 02/13/2001 14:21:29.880 SEV=8 IKEDBG/0 RPT=462 172.18.124.157
SENDING Message (msgid=63f2abb8) with payloads :
HDR + HASH (8) ... total length : 68

200 02/13/2001 14:21:29.880 SEV=7 IKEDBG/9 RPT=6 172.18.124.157
IKE Deleting SA: Remote Proxy 10.32.50.0, Local Proxy 192.168.1.0

201 02/13/2001 14:21:29.880 SEV=9 IKEDBG/0 RPT=463 172.18.124.157
IKE SA MM:241840al terminating:
flags 0x00000082, refcnt 0, tuncnt 0

202 02/13/2001 14:21:29.880 SEV=9 IKEDBG/0 RPT=464
sending delete message

203 02/13/2001 14:21:29.880 SEV=9 IKEDBG/0 RPT=465 172.18.124.157
constructing blank hash

204 02/13/2001 14:21:29.880 SEV=9 IKEDBG/0 RPT=466
constructing delete payload

205 02/13/2001 14:21:29.880 SEV=9 IKEDBG/0 RPT=467 172.18.124.157
constructing qm hash

206 02/13/2001 14:21:29.880 SEV=8 IKEDBG/0 RPT=468 172.18.124.157
SENDING Message (msgid=d6a00071) with payloads :
HDR + HASH (8) ... total length : 80

208 02/13/2001 14:21:29.880 SEV=4 AUTH/22 RPT=13
User 172.18.124.157 disconnected

209 02/13/2001 14:21:29.880 SEV=8 IKEDBG/0 RPT=469
pitcher: received key delete msg, spi 0x2962069b

210 02/13/2001 14:21:29.880 SEV=8 IKEDBG/0 RPT=470
pitcher: received key delete msg, spi 0xda163fe2

211 02/13/2001 14:21:29.880 SEV=8 IKEDBG/0 RPT=471
pitcher: received key delete msg, spi 0x4d6e483f

212 02/13/2001 14:21:29.880 SEV=8 IKEDBG/0 RPT=472
pitcher: received key delete msg, spi 0xda163fe3

213 02/13/2001 14:21:29.890 SEV=8 IKEDBG/0 RPT=473
pitcher: received a key acquire message!

214 02/13/2001 14:21:29.890 SEV=4 IKE/41 RPT=6 172.18.124.157
IKE Initiator: New Phase 1, Intf 2, IKE Peer 172.18.124.157
local Proxy Address 192.168.1.0, remote Proxy Address 10.32.50.0,
SA (L2L: to_checkpoint)

217 02/13/2001 14:21:29.890 SEV=9 IKEDBG/0 RPT=474 172.18.124.157
constructing ISA_SA for isakmp

218 02/13/2001 14:21:29.890 SEV=8 IKEDBG/0 RPT=475 172.18.124.157
SENDING Message (msgid=0) with payloads :
HDR + SA (1) ... total length : 84

219 02/13/2001 14:21:30.430 SEV=8 IKEDECODE/0 RPT=197 172.18.124.157
ISAKMP HEADER : (Version 1.0)
Initiator Cookie(8): FE 75 39 26 66 21 F6 F8
Responder Cookie(8): 67 1D 73 71 AE 2B 88 2E
Next Payload : SA (1)
Exchange Type : Oakley Main Mode
Flags : 0
Message ID : 0
Length : 84

225 02/13/2001 14:21:30.430 SEV=8 IKEDBG/0 RPT=476 172.18.124.157
RECEIVED Message (msgid=0) with payloads :

HDR + SA (1) + NONE (0) ... total length : 84

227 02/13/2001 14:21:30.430 SEV=8 IKEDBG/0 RPT=477 172.18.124.157
RECEIVED Message (msgid=0) with payloads :
HDR + SA (1) + NONE (0) ... total length : 84

229 02/13/2001 14:21:30.430 SEV=9 IKEDBG/0 RPT=478 172.18.124.157
processing SA payload

230 02/13/2001 14:21:30.430 SEV=8 IKEDECODE/0 RPT=198 172.18.124.157
SA Payload Decode :
DOI : IPSEC (1)
Situation : Identity Only (1)
Length : 56

233 02/13/2001 14:21:30.430 SEV=8 IKEDECODE/0 RPT=199 172.18.124.157
Proposal Decode:
Proposal # : 1
Protocol ID : ISAKMP (1)
#of Transforms: 1
Length : 44

236 02/13/2001 14:21:30.430 SEV=8 IKEDECODE/0 RPT=200 172.18.124.157
Transform # 1 Decode for Proposal # 1:
Transform # : 1
Transform ID : IKE (1)
Length : 36

238 02/13/2001 14:21:30.440 SEV=8 IKEDECODE/0 RPT=201 172.18.124.157
Phase 1 SA Attribute Decode for Transform # 1:
Encryption Alg: DES-CBC (1)
Hash Alg : SHA (2)
DH Group : Oakley Group 1 (1)
Auth Method : Preshared Key (1)
Life Time : 86400 seconds

243 02/13/2001 14:21:30.440 SEV=7 IKEDBG/0 RPT=479 172.18.124.157
Oakley proposal is acceptable

244 02/13/2001 14:21:30.440 SEV=9 IKEDBG/0 RPT=480 172.18.124.157
constructing ke payload

245 02/13/2001 14:21:30.440 SEV=9 IKEDBG/1 RPT=120 172.18.124.157
constructing nonce payload

246 02/13/2001 14:21:30.440 SEV=9 IKEDBG/38 RPT=8 172.18.124.157
Constructing VPN 3000 spoofing IOS Vendor ID payload (version: 1.0.0, capabilities: 20000001)

248 02/13/2001 14:21:30.440 SEV=9 IKEDBG/1 RPT=121 172.18.124.157
constructing vid payload

249 02/13/2001 14:21:30.440 SEV=8 IKEDBG/0 RPT=481 172.18.124.157
SENDING Message (msgid=0) with payloads :
HDR + KE (4) ... total length : 192

250 02/13/2001 14:21:30.540 SEV=8 IKEDECODE/0 RPT=202 172.18.124.157
ISAKMP HEADER : (Version 1.0)
Initiator Cookie(8): FE 75 39 26 66 21 F6 F8
Responder Cookie(8): 67 1D 73 71 AE 2B 88 2E
Next Payload : KE (4)
Exchange Type : Oakley Main Mode
Flags : 0
Message ID : 0
Length : 152

256 02/13/2001 14:21:30.540 SEV=8 IKEDBG/0 RPT=482 172.18.124.157
RECEIVED Message (msgid=0) with payloads :
HDR + KE (4) + NONCE (10) + NONE (0) ... total length : 152

258 02/13/2001 14:21:30.540 SEV=8 IKEDBG/0 RPT=483 172.18.124.157
RECEIVED Message (msgid=0) with payloads :
HDR + KE (4) + NONCE (10) + NONE (0) ... total length : 152

260 02/13/2001 14:21:30.540 SEV=9 IKEDBG/0 RPT=484 172.18.124.157
processing ke payload

261 02/13/2001 14:21:30.540 SEV=9 IKEDBG/0 RPT=485 172.18.124.157
processing ISA_KE

262 02/13/2001 14:21:30.540 SEV=9 IKEDBG/1 RPT=122 172.18.124.157
processing nonce payload

263 02/13/2001 14:21:30.560 SEV=9 IKE/0 RPT=30 172.18.124.157
Generating keys for Initiator...

264 02/13/2001 14:21:30.570 SEV=9 IKEDBG/1 RPT=123 172.18.124.157
constructing ID

265 02/13/2001 14:21:30.570 SEV=9 IKEDBG/0 RPT=486
construct hash payload

266 02/13/2001 14:21:30.570 SEV=9 IKEDBG/0 RPT=487 172.18.124.157
computing hash

267 02/13/2001 14:21:30.570 SEV=8 IKEDBG/0 RPT=488 172.18.124.157
SENDING Message (msgid=0) with payloads :
HDR + ID (5) ... total length : 64

268 02/13/2001 14:21:30.740 SEV=8 IKEDECODE/0 RPT=203 172.18.124.157
ISAKMP HEADER : (Version 1.0)
Initiator Cookie(8): FE 75 39 26 66 21 F6 F8
Responder Cookie(8): 67 1D 73 71 AE 2B 88 2E
Next Payload : ID (5)
Exchange Type : Oakley Main Mode
Flags : 1 (ENCRYPT)
Message ID : 0
Length : 68

274 02/13/2001 14:21:30.740 SEV=8 IKEDBG/0 RPT=489 172.18.124.157
RECEIVED Message (msgid=0) with payloads :
HDR + ID (5) + HASH (8) + NONE (0) ... total length : 64

276 02/13/2001 14:21:30.740 SEV=9 IKEDBG/1 RPT=124 172.18.124.157
Processing ID

277 02/13/2001 14:21:30.740 SEV=9 IKEDBG/0 RPT=490 172.18.124.157
processing hash

278 02/13/2001 14:21:30.740 SEV=9 IKEDBG/0 RPT=491 172.18.124.157
computing hash

279 02/13/2001 14:21:30.740 SEV=9 IKEDBG/23 RPT=8 172.18.124.157
Starting group lookup for peer 172.18.124.157

280 02/13/2001 14:21:30.830 SEV=8 IKEDECODE/0 RPT=204 172.18.124.157
ISAKMP HEADER : (Version 1.0)
Initiator Cookie(8): FE 75 39 26 66 21 F6 F8
Responder Cookie(8): 67 1D 73 71 AE 2B 88 2E
Next Payload : ID (5)
Exchange Type : Oakley Main Mode
Flags : 1 (ENCRYPT)

Message ID : 0
Length : 68

286 02/13/2001 14:21:30.830 SEV=6 IKE/0 RPT=31 172.18.124.157
Duplicate Phase 1 packet detected!

287 02/13/2001 14:21:30.830 SEV=6 IKE/0 RPT=32
MM received unexpected event EV_RESEND_MSG in state MM_I_DONE

288 02/13/2001 14:21:30.840 SEV=7 IKEDBG/0 RPT=492 172.18.124.157
Found Phase 1 Group (172.18.124.157)

289 02/13/2001 14:21:30.840 SEV=7 IKEDBG/14 RPT=8 172.18.124.157
Authentication configured for Internal

290 02/13/2001 14:21:30.840 SEV=9 IKEDBG/0 RPT=493 172.18.124.157
Oakley begin quick mode

291 02/13/2001 14:21:30.840 SEV=7 IKEDBG/0 RPT=494 172.18.124.157
Starting phase 1 rekey timer

292 02/13/2001 14:21:30.840 SEV=4 AUTH/21 RPT=15
User 172.18.124.157 connected

293 02/13/2001 14:21:30.840 SEV=8 IKEDBG/6 RPT=7
IKE got SPI from key engine: SPI = 0x08201539

294 02/13/2001 14:21:30.840 SEV=9 IKEDBG/0 RPT=495 172.18.124.157
oakley constructing quick mode

295 02/13/2001 14:21:30.840 SEV=9 IKEDBG/0 RPT=496 172.18.124.157
constructing blank hash

296 02/13/2001 14:21:30.840 SEV=9 IKEDBG/0 RPT=497 172.18.124.157
constructing ISA_SA for ipsec

297 02/13/2001 14:21:30.840 SEV=9 IKEDBG/1 RPT=125 172.18.124.157
constructing ipsec nonce payload

298 02/13/2001 14:21:30.840 SEV=9 IKEDBG/1 RPT=126 172.18.124.157
constructing proxy ID

299 02/13/2001 14:21:30.840 SEV=7 IKEDBG/0 RPT=498 172.18.124.157
Transmitting Proxy Id:
Local subnet: 192.168.1.0 mask 255.255.255.0 Protocol 0 Port 0
Remote subnet: 10.32.50.0 Mask 255.255.255.0 Protocol 0 Port 0

302 02/13/2001 14:21:30.840 SEV=9 IKEDBG/0 RPT=499 172.18.124.157
constructing qm hash

303 02/13/2001 14:21:30.840 SEV=8 IKEDBG/0 RPT=500 172.18.124.157
SENDING Message (msgid=23bc1709) with payloads :
HDR + HASH (8) ... total length : 184

305 02/13/2001 14:21:31.000 SEV=8 IKEDECODE/0 RPT=205 172.18.124.157
ISAKMP HEADER : (Version 1.0)
Initiator Cookie(8): FE 75 39 26 66 21 F6 F8
Responder Cookie(8): 67 1D 73 71 AE 2B 88 2E
Next Payload : HASH (8)
Exchange Type : Oakley Quick Mode
Flags : 1 (ENCRYPT)
Message ID : 23bc1709
Length : 164

312 02/13/2001 14:21:31.000 SEV=8 IKEDBG/0 RPT=501 172.18.124.157
RECEIVED Message (msgid=23bc1709) with payloads :

HDR + HASH (8) + SA (1) + NONCE (10) + ID (5) + ID (5) + NONE (0) ... total length : 156

315 02/13/2001 14:21:31.000 SEV=9 IKEDBG/0 RPT=502 172.18.124.157
processing hash

316 02/13/2001 14:21:31.000 SEV=9 IKEDBG/0 RPT=503 172.18.124.157
processing SA payload

317 02/13/2001 14:21:31.000 SEV=8 IKEDECODE/0 RPT=206 172.18.124.157
SA Payload Decode :
DOI : IPSEC (1)
Situation : Identity Only (1)
Length : 48

320 02/13/2001 14:21:31.000 SEV=8 IKEDECODE/0 RPT=207 172.18.124.157
Proposal Decode:
Proposal # : 1
Protocol ID : ESP (3)
#of Transforms: 1
Spi : DA 16 3F E4
Length : 36

324 02/13/2001 14:21:31.000 SEV=8 IKEDECODE/0 RPT=208 172.18.124.157
Transform # 1 Decode for Proposal # 1:
Transform # : 1
Transform ID : DES-CBC (2)
Length : 24

326 02/13/2001 14:21:31.000 SEV=8 IKEDECODE/0 RPT=209 172.18.124.157
Phase 2 SA Attribute Decode for Transform # 1:
Life Time : 28800 seconds
Encapsulation : Tunnel (1)
HMAC Algorithm: SHA (2)

329 02/13/2001 14:21:31.000 SEV=9 IKEDBG/1 RPT=127 172.18.124.157
processing nonce payload

330 02/13/2001 14:21:31.000 SEV=9 IKEDBG/1 RPT=128 172.18.124.157
Processing ID

331 02/13/2001 14:21:31.000 SEV=9 IKEDBG/1 RPT=129 172.18.124.157
Processing ID

332 02/13/2001 14:21:31.000 SEV=9 IKEDBG/0 RPT=504 172.18.124.157
loading all IPSEC SAs

333 02/13/2001 14:21:31.000 SEV=9 IKEDBG/1 RPT=130 172.18.124.157
Generating Quick Mode Key!

334 02/13/2001 14:21:31.010 SEV=9 IKEDBG/1 RPT=131 172.18.124.157
Generating Quick Mode Key!

335 02/13/2001 14:21:31.010 SEV=7 IKEDBG/0 RPT=505 172.18.124.157
Loading subnet:
Dst: 10.32.50.0 mask: 255.255.255.0
Src: 192.168.1.0 mask: 255.255.255.0

337 02/13/2001 14:21:31.010 SEV=4 IKE/49 RPT=7 172.18.124.157
Security negotiation complete for LAN-to-LAN Group (172.18.124.157)
Initiator, Inbound SPI = 0x08201539, Outbound SPI = 0xda163fe4

339 02/13/2001 14:21:31.010 SEV=9 IKEDBG/0 RPT=506 172.18.124.157
oakley constructing final quick mode

340 02/13/2001 14:21:31.010 SEV=8 IKEDBG/0 RPT=507 172.18.124.157

SENDING Message (msgid=23bc1709) with payloads :
HDR + HASH (8) ... total length : 76

342 02/13/2001 14:21:31.010 SEV=8 IKEDBG/7 RPT=7
IKE got a KEY_ADD msg for SA: SPI = 0xda163fe4

343 02/13/2001 14:21:31.010 SEV=8 IKEDBG/0 RPT=508
pitcher: rcv KEY_UPDATE, spi 0x8201539

344 02/13/2001 14:21:31.890 SEV=8 IKEDBG/0 RPT=509
pitcher: rcv KEY_SA_ACTIVE spi 0x8201539

345 02/13/2001 14:21:31.890 SEV=8 IKEDBG/0 RPT=510
KEY_SA_ACTIVE no old rekey centry found with new spi 0x8201539, mess_id 0x0

Related Information

- [IPsec Negotiation/IKE Protocols](#)
 - [Technical Support & Documentation – Cisco Systems](#)
-

[Contacts & Feedback](#) | [Help](#) | [Site Map](#)

© 2014 – 2015 Cisco Systems, Inc. All rights reserved. [Terms & Conditions](#) | [Privacy Statement](#) | [Cookie Policy](#) | [Trademarks of Cisco Systems, Inc.](#)

Updated: May 12, 2006

Document ID: 14104
