



# Interface Configuration

---

- [Gx Interface Configuration, on page 1](#)
- [Gy Interface Configuration, on page 3](#)
- [Sy Interface Configuration, on page 5](#)
- [Rx Interface Configuration, on page 10](#)
- [Sd Interface Configuration, on page 12](#)
- [Sh Interface Configuration, on page 16](#)
- [LDAP/Ud Interface Configuration, on page 20](#)

## Gx Interface Configuration

This procedure describes how to create a Gx service in which the PCRF mirrors the QoS received from the PCEF/Gateway. When the PCRF receives a Credit-Control-Request (Initial) message, it sends the same QoS parameters back to the PCEF in the Credit-Control-Answer (Initial) message.

### Procedure

---

**Step 1** Open Policy Builder, and select the **Services** tab.

**Step 2** In the left-hand pane, select **Use Case Templates > Summary**.

**Step 3** In the **Summary** pane, click **Use Case Template** under **Create Child**, and then do the following:

- In the **Name** field, type **MirrorQoS** (using this name for example Use Case Template).
- Select **Actions** tab.
- Click **Add** under **Service Configurations**.  
The **Select Service Configuration** dialog box opens, and all of the service configuration objects that are available on the PCRF are listed.
- Scroll down to the **gx** area in the list of service configuration objects, and select **DefaultBearerQoS**.
- Click **OK**.  
The **Select Service Configuration** dialog box closes, and the **DefaultBearerQoS** object is displayed under **Service Configurations**.
- Click **Add** again under **Service Configurations**.
- In the **Select Service Configuration** dialog box, scroll down to the **gx** section, and select **DefaultBearerQoSActions**.
- Click **OK**.

Now both added service configuration objects are displayed under **Service Configurations** pane.

**Step 4** From the left-hand pane, select **Services > Service Options**.

The new *MirrorQoS* option is displayed at the bottom of the list of service options.

**Step 5** Select **MirrorQoS** in the **Service Options** list, and do the following:

- In the **MirrorQoS Summary** pane, click **Service Option** under **Create Child**. The **Select Service Configuration** dialog box opens. Both of the service configuration objects that you added are listed under **Service Configurations**.

**Figure 1: Mirror QoS Summary**

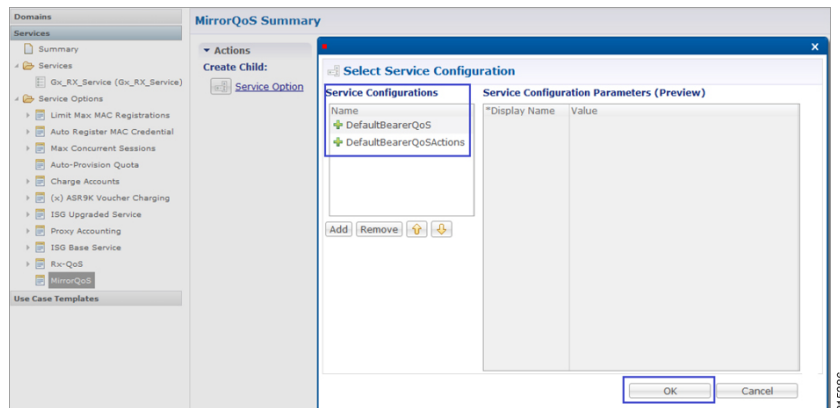

- Click **OK**.
- Type **MirrorQoS** in the **Name** field.
- Under **Service Configurations**, select **DefaultBearerQoSActions**. The **DefaultBearerQoSActions** parameters are displayed to the right.
- In the **Value** column, select **Mirror** for all of the attribute value pairs.

**Figure 2: Mirror QoS Summary - Service Option**

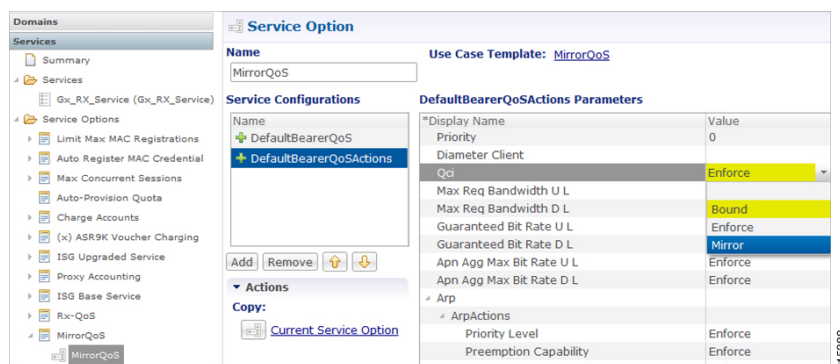

**Step 6** In the left-hand pane, select **Services > Services**.

**Step 7** In the **Services Summary** pane, click **Service** under **Create Child**, and do the following:

- Type a descriptive code for the MirrorQoS service in the **Code** field.
- Type **MirrorQoS** in the **Name** field.
- Uncheck the **Balance Service** option.

- d) Click **Add**.
- e) In the **Select Service Configuration** dialog box, select the MirrorQoS service option, and click **OK**.

**Step 8** Select **File > Publish to Runtime Environment**.

The new MirrorQoS service is now available to all Policy Server (QNS) nodes for processing.

**Step 9** Verify that the newly created service is available for use by doing the following:

- a) Open the Control Center GUI and go to the **Subscribers** section.
- b) Click **Create Subscriber**.
- c) Enter the IMSI/MSISDN and the name of the subscriber, and then click **Save & Continue**.

**Figure 3: Create Subscriber**

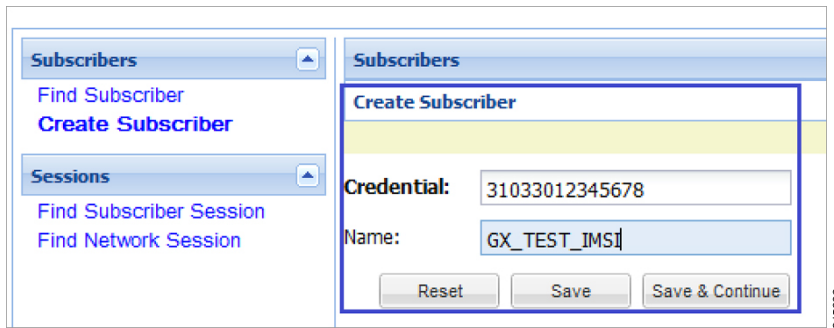

- d) Go to the **Services** section.
- e) Click the **Add** section, which lists the available services, and select the new MirrorQoS service.
- f) Click **Save** and run a test call to verify that the QoS parameters are mirrored by PCRF in Credit-Control-Answer(Initial) message back to the PCEF.

## Gy Interface Configuration

The Diameter Gy reference point is located between the OCS and the PCEF. The CPS supports using the Gy reference point for usage monitoring of the on-board OCS known as the Multi-service Balance Manager (MsBM) against a PCEF.

CPS uses the Gy RatingGroup Service Configuration Object within the Use Case Templates to hold the configuration parameters for Gy. The following procedure describes how to set up a Gy RatingGroup that will be sent upon a CCR-i request from the PCEF. The Gy RatingGroup service option would then be added to a service along with a Gx rule or QoS.

For more information, see [Gx Interface Configuration, on page 1](#) for details on how to create a valid Gx service.

The following procedure is based on the ASR5K acting as the PCEF supporting the Enhanced Charging Service (ECS) mechanism for Gy “Pull” Usage Monitoring. The RatingGroup configuration for Gy will work in a similar method with any supported PCEF using the Gy interface.

## Procedure

- Step 1** Open the Policy Builder GUI, and select the **Services** tab.
- Step 2** In the left-hand pane, select **Use Case Templates > Summary**.
- Step 3** In the **Summary** pane, click **Use Case Template** under **Create Child**, and then do the following:
- In the **Name** field, type **Gy**.
  - Select **Actions** tab.
  - Click **Add** under **Service Configurations**.  
The **Select Service Configuration** dialog box opens, and all of the service configuration objects that are available on the PCRF are listed.
  - Scroll down to the **gy** area in the list of service configuration objects, and select **RatingGroup**.  
The **Select Service Configuration** dialog box closes, and the RatingGroup object is displayed under **Service Configurations**.
- Step 4** In the left-hand pane, select **Services > Service Options**.  
The new Gy option is displayed at the bottom of the list of service options.
- Step 5** Select **Gy** in the **Service Options** list, and do the following:
- In the **Gy Summary** pane, click **Service Option** under **Create Child**.  
The **Select Service Configuration** dialog box opens. The RatingGroup service configuration object is listed under **Service Configurations**.
  - Click **OK**.
  - Type **Gy** in the **Name** field.
  - Under **Service Configurations**, select **RatingGroup**.  
The RatingGroup parameters display to the right.

The following table describes the parameters that are necessary to support the ASR5000 ECS Usage Monitoring for a volume quota service:

**Table 1: RatingGroup Parameters**

Parameter	Description
Rating Group	Corresponds to a value configured on the ASR5000 that represents which data should be monitored.
RG Type	Rating Group Type supports one of two values either “volume” or “time”.
Dosage	How much quota to initially give the client (in bytes).
<b>Balance Code</b>	
Final Unit Action	In this example, we will use TERMINATE as the default Final Unit Action on quota depletion, which will send a CCR-u with the final usage for the rating group. Other options supported include NONE (no action taken) RESTRICT_ACCESS (send a Restriction Filter Rule and Filter ID) and REDIRECT (send a Redirect Address of Redirect Address Type).

Parameter	Description
Validity Time	Sets a session timer for the Gy quota grant; even if quota is not exhausted the PCEF must check back in at the end of the validity time (in seconds).
Volume Quota Threshold	PCEF will check back in with OCS when the Volume Quota Threshold has been reached; value must be set as less than the overall Dosage (in bytes).
Quota Holding Time	The amount of time the quota should be available on the PCEF without activity from the user (in seconds)
Quota Consumption Time	Idle traffic threshold time (in seconds); only used with time quota rating groups.
Use Shared Bucket	Used in a shared quota use case in which the same account balance and rating group can be used within a shared group of users.  Default: false

Priority and Diameter Client do not need to be set. Priority can be used to set the priority for the RatingGroup if multiple RatingGroups are on a service.

Tariff Switch Model and Tariff Change Time are outside the scope of this document.

**Note**

If Tariff Switch Model is not set, any value set in Tariff Change Time is ignored.

**Step 6** Validate the Gy service configuration as follows:

- a) Create a new service in Policy Builder that contains a Gx rule service configuration and the Gy RatingGroup service configuration.

**Note**

The Gx rule must be a rule defined on the PGW that is associated with a Gy service to the CPS as the OCS.

- b) Per the Gy pull model, when the PCEF receives the appropriate Gx rule, it initiates a CCR-i to the OCS, which will reply back with the RatingGroup service option values in a CCA.
- c) Using **tcpdump**, verify that the CCA contains the appropriate values as defined in the RatingGroup.

## Sy Interface Configuration

The Sy reference point is located between the Policy and Charging Rules Function (PCRF) and the Online Charging System (OCS). The Sy reference point enables the transfer of information relating to subscriber spending from OCS to PCRF and supports the following functions:

- Request of policy counter status reporting from PCRF to OCS
- Notifications of policy counter status change from OCS to PCRF
- Cancellations of policy counter status reporting from PCRF to OCS

Since the Sy interface resides between PCRF and OCS in the HPLMN, roaming with home routed or visited access as well as non-roaming scenarios is supported in the same manner.

The following procedure describes how to subscribe to the OCS (Online charging system) counter status updates from the PCRF side by initiating a 'Spending Limit Request (SLR)' message:

## Procedure

---

- Step 1** Open the Policy Builder GUI, and select the **Services** tab.
- Step 2** Create a Gx service as described in [Gx Interface Configuration, on page 1](#).
- Now you are ready to create an Sy service as described in the following steps.
- Step 3** In the left-hand pane, select **Use Case Templates > Summary**.
- Step 4** In the **Summary** pane, click **Use Case Template** under **Create Child**, and then do the following:
- In the **Name** field, type **Sy**.
  - Select **Actions** tab.
  - Click **Add** under **Service Configurations**.  
The **Select Service Configuration** dialog box opens, and all of the service configuration objects that are available on the PCRF are listed.
  - Scroll down to the **sy** area in the list of service configuration objects, and select **SpendingLimitReport**.
  - Click **OK**.  
The **Select Service Configuration** dialog box closes, and the SpendingLimitReport object is displayed under **Service Configurations**.
- Step 5** In the left-hand pane, select **Services > Service Options**.
- The new Sy option is displayed at the bottom of the list of service options.
- Step 6** Select **Sy** in the **Service Options** list, and do the following:
- In the **Sy Summary** pane, click **Service Option** under **Create Child**.  
The **Select Service Configuration** dialog box opens. The SpendingLimitReport service configuration object is listed under **Service Configurations**.
  - Click **OK**.
  - Type **Sy** in the **Name** field.
  - Under **Service Configurations**, select **SpendingLimitReport**.  
The SpendingLimitReport parameters display to the right.
  - In the list of parameters, expand **Subscriber Id (List) > SubscriberId** parameter.  
The **Identifier** parameter appears.
  - Click in the **Value** column beside the **Identifier** parameter, and then click the **...** button.

Figure 4: Identifier Parameter

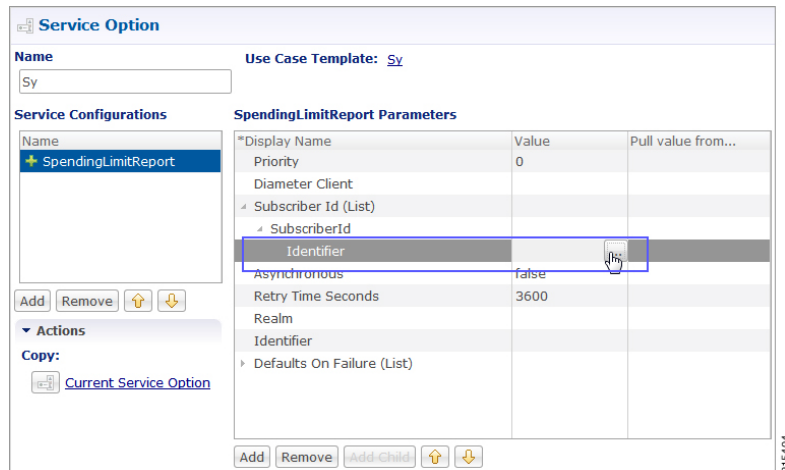

A dialog box containing a list of identifiers opens.

- g) Select **Session MSISDN** in the list, and click **OK**. Based on your requirements, you can also use other identifiers such as IMSI, and so on.

Figure 5: Session MSISDN Identifier

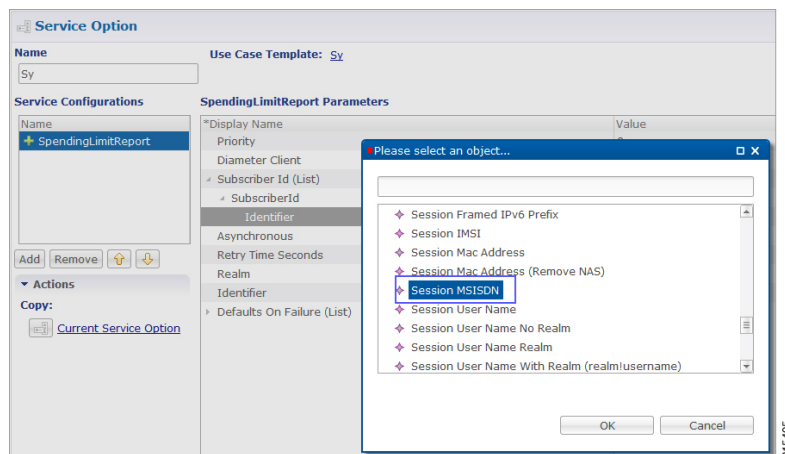

- h) Update the **Realm** parameter with the Sy peer realm (OCS Realm) where the message needs to be sent from PCRF. In this configuration we are not specifying any counter name in the Identifier columns, which means that the PCRF subscribes to all the counter statuses available on the OCS for the subscriber.

Figure 6: Realm Parameter

Name	Use Case Template: Sy																																													
Name: Sy																																														
<table border="1"> <thead> <tr> <th>Name</th> <th>*Display Name</th> <th>Value</th> </tr> </thead> <tbody> <tr> <td>SpendingLimitReport</td> <td>Priority</td> <td>0</td> </tr> <tr> <td></td> <td>Diameter Client</td> <td></td> </tr> <tr> <td></td> <td>Subscriber Id (List)</td> <td></td> </tr> <tr> <td></td> <td>SubscriberId</td> <td></td> </tr> <tr> <td></td> <td>Identifier</td> <td>Session MSISDN</td> </tr> <tr> <td></td> <td>Asynchronous</td> <td>false</td> </tr> <tr> <td></td> <td>Retry Time Seconds</td> <td>3600</td> </tr> <tr> <td></td> <td>Realm</td> <td>test-realm.com</td> </tr> <tr> <td></td> <td>Identifier</td> <td></td> </tr> <tr> <td></td> <td>Defaults On Failure (List)</td> <td></td> </tr> <tr> <td></td> <td>DefaultSpendingLimitReport</td> <td></td> </tr> <tr> <td></td> <td>Failure Reason</td> <td>NoPeerAvailable</td> </tr> <tr> <td></td> <td>Identifier</td> <td></td> </tr> <tr> <td></td> <td>Status</td> <td></td> </tr> </tbody> </table>		Name	*Display Name	Value	SpendingLimitReport	Priority	0		Diameter Client			Subscriber Id (List)			SubscriberId			Identifier	Session MSISDN		Asynchronous	false		Retry Time Seconds	3600		Realm	test-realm.com		Identifier			Defaults On Failure (List)			DefaultSpendingLimitReport			Failure Reason	NoPeerAvailable		Identifier			Status	
Name	*Display Name	Value																																												
SpendingLimitReport	Priority	0																																												
	Diameter Client																																													
	Subscriber Id (List)																																													
	SubscriberId																																													
	Identifier	Session MSISDN																																												
	Asynchronous	false																																												
	Retry Time Seconds	3600																																												
	Realm	test-realm.com																																												
	Identifier																																													
	Defaults On Failure (List)																																													
	DefaultSpendingLimitReport																																													
	Failure Reason	NoPeerAvailable																																												
	Identifier																																													
	Status																																													

**Step 7**

In the left-hand pane, select **Services > Services**.

**Step 8**

In the **Services Summary** pane, click **Service** under **Create Child**, and do the following:

- Type a descriptive code for the Sy service in the **Code** field.
- Type **Sy** in the **Name** field.
- Uncheck the **Balance Service** option.
- Click **Add**.
- In the **Select Service Configuration** dialog box, select the Sy service option, and click **OK**.
- Click **Add** again, select the MirrorQoS service option, and click **OK**.

Figure 7: Adding the Mirror QoS Service Option

The screenshot shows the 'Service' configuration page for 'Sy' with the 'Select Service Configuration' dialog box open. The dialog box has two panes: 'Please Select a Service Option' and 'Service Configuration Parameters (Preview)'. In the 'Please Select a Service Option' pane, 'MirrorQoS' is selected. The 'Service Configuration Parameters (Preview)' pane shows a table of parameters for the selected service option.

*Display Name	Value
Priority	0
Diameter Client	
Qci	
Max Req Bandwidth U L	
Max Req Bandwidth D L	
Guaranteed Bit Rate U L	
Guaranteed Bit Rate D L	
Apn Agg Max Bit Rate U L	
Apn Agg Max Bit Rate D L	
Arp	
Priority	0
Diameter Client	Mirror
Qci	Mirror
Max Req Bandwidth U L	

- By adding the Gx interface 'MirrorQoS' service, PCRF will mirror the QoS for this subscriber.
- By adding the Sy interface 'Sy' service, PCRF will subscribe with OCS for all the counters per user.
- Both Gx/Sy service options together will generate a successful end-to-end subscriber call.

**Step 9**

Select **File > Publish to Runtime Environment**.

The new Sy service is now available to all Policy Server (QNS) nodes for processing.

**Step 10**

Verify that the new Sy service is available for use by doing the following:

- Open the Control Center GUI and go to the **Subscribers** section.
- Click **Create Subscriber**.
- Enter the IMSI/MSISDN and the name of the subscriber, and then click **Save & Continue**.

**Figure 8: Create Subscriber**

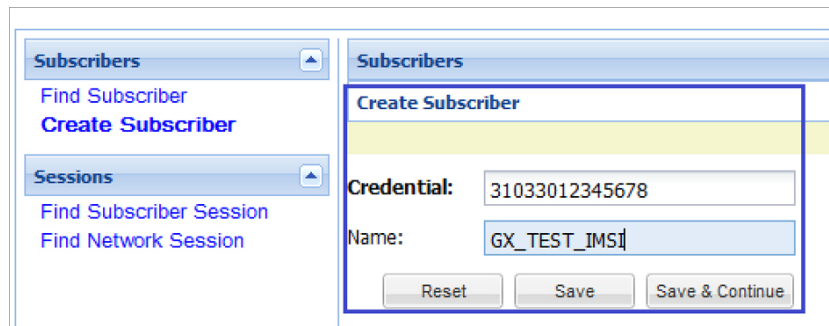

- Go to the **Services** section.

- Click **add** to open **Select Service** pop-up box which lists the available services. Select the new Sy service.

**Figure 9: Select New Service - 1**

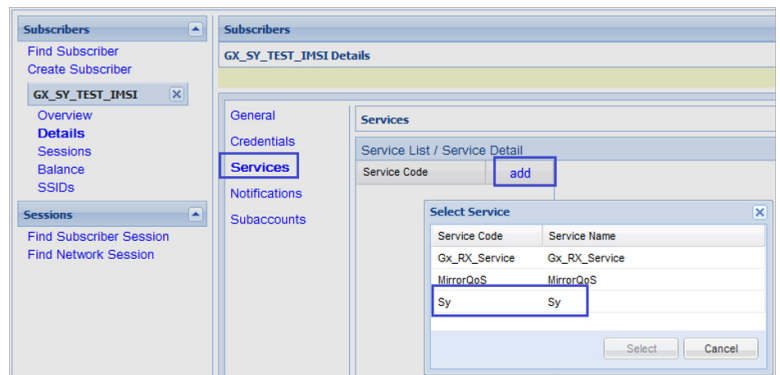

**Figure 10: Select New Service - 2**

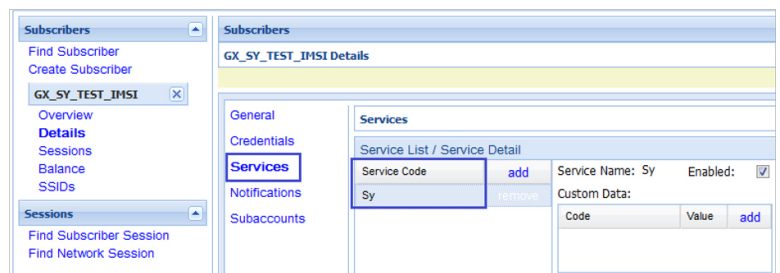

- Click **Save** and run a test call to verify the following:

- QoS parameters are mirrored by PCRF in Credit-Control-Answer (Initial) message back to the PCEF.

- PCRF sends a Spending Limit Request message to the PCS on the Sy interface receives Spending Limit Answer message from the OCS.

## Rx Interface Configuration

The Rx reference point is used to exchange application-level session information between the Policy and Charging Rules Function (PCRF) and the Application Function (AF). This information is part of the input used by the PCRF for the Policy and Charging Control (PCC) decisions.

The PCRF exchanges the PCC rules with the Policy and Charging Enforcement Function (PCEF) and QoS rules with the Bearer Binding and Event Reporting Function (BBERF).

**Figure 11: Rx Reference Point**

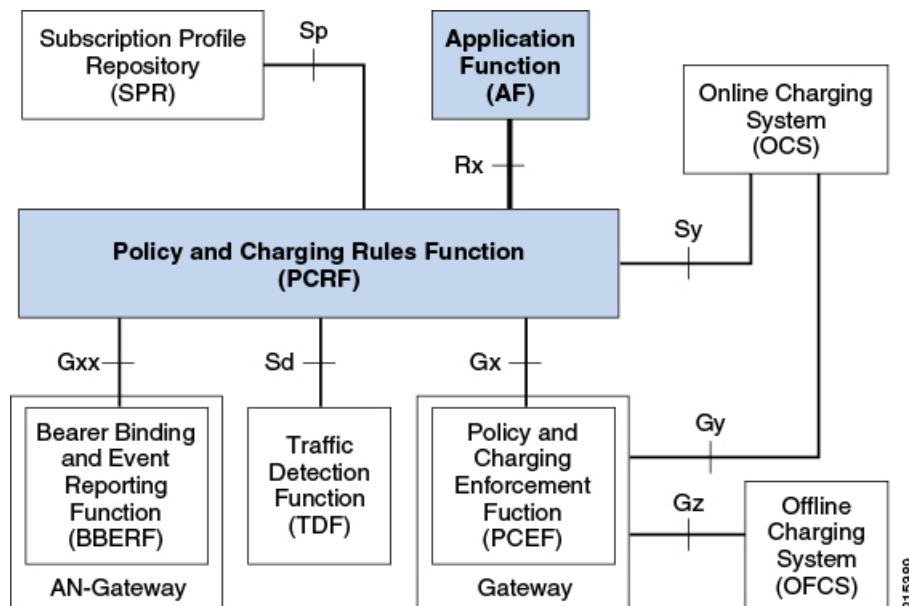

The PCRF provides network control regarding the service data flow detection gating QoS and flow based charging (except credit management) towards the PCEF. The PCRF receives session and media related information from the AF and informs AF of traffic plane events.

When a new AF session is being established and media information for this AF session is available at the AF and the related media require PCC supervision the AF shall open an Rx Diameter session with the PCRF for the AF session using an AA-Request command unless an Rx session has already been established for the AF session.

The AF shall provide the full IP address of the UE using either Framed-IP-Address AVP or Framed-Ipv6-Prefix AVP and the corresponding Service Information within Media-Component-Description AVP(s). The AF shall indicate to the PCRF as part of the Media-Component-Description whether the media IP flow(s) should be enabled or disabled with the Flow-Status AVP.

The AF may include the AF-Application-Identifier AVP into the AA-Request in order to indicate the particular service that the AF session belongs to. This AVP can be provided at both AF session level and

Media-Component-Description level. When provided at both levels the AF-Application Identifier provided within the Media-Component-Description AVP will have precedence.

#### Use Case:

The following procedure describes how to configure the Rx parameters that are necessary for the establishment of a dedicated bearer and calculating/deriving the QoS for the Dynamic Charging rule names that PCRF sends to the PCEF using a Gx RARmessage:

### Procedure

**Step 1** Open the Policy Builder GUI, and select the **Reference Data** tab.

**Step 2** In the left-hand pane, select **Diameter Defaults**.

**Step 3** In the **Summary** pane, click **Rx Profiles** under **Create Child**.

The Rx Profile configuration pane appears. When multiple Rx profiles are configured, the first profile should be configured as described in the following steps.

**Step 4** Select **Prefer answer Codec-Data** if you want the default priority to be given to the answer codec (when both answer and offer are present within the AAR). This option is not selected by default.

#### Note

CPS will by default select the first of offer or answer that is present in the sent XML. By selecting this checkbox, CPS will prefer answer regardless of the order sent by the Rx endpoint.

**Figure 12: Rx Profile Configuration**

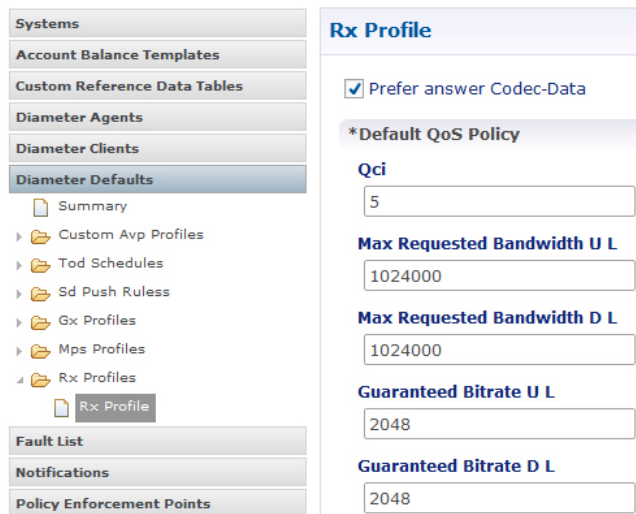

Systems	
Account Balance Templates	
Custom Reference Data Tables	
Diameter Agents	
Diameter Clients	
Diameter Defaults	
Summary	
Custom Avp Profiles	
Tod Schedules	
Sd Push Rules	
Gx Profiles	
Mps Profiles	
Rx Profiles	
Rx Profile	
Fault List	
Notifications	
Policy Enforcement Points	

Rx Profile	
<input checked="" type="checkbox"/>	Prefer answer Codec-Data
*Default QoS Policy	
Qci	5
Max Requested Bandwidth U L	1024000
Max Requested Bandwidth D L	1024000
Guaranteed Bitrate U L	2048
Guaranteed Bitrate D L	2048

**Step 5** In the **Default QoS Policy** area, update the mandatory attribute value pairs as required.

#### Note

The **Default QoS Policy** area is used when there is no Application QoS Policy or Codec QoS Policy defined, or when the incoming call doesn't match the configured values (with regard to AF ID or other parameters).

#### Note

If AF Application Identifier (AF-ID)-specific QoS handling is needed, the Application QoS Policy table needs to be updated. If the AF-ID received in the AAR message from the AF matches the AF Application Identifier configured under

the Application QoS Policy section, then the PCRF uses QoS attributes from this table to populate the dynamic rule QoS AVPs, which is then sent to the PCEF for dedicated bearer establishment.

**Step 6** Scroll down to the **Actions** area in the **Rx Profile** pane, and click **Dynamic Rule Charging Parameters** under **Create Child**.

**Step 7** Update the fields using one of the following methods as per requirements:

- Update the default Dynamic Rule Charging Parameters.

**Note**

This is used in case the provisioned values (AF Identifier based) do not match the incoming AAR message, essentially signifying that the AF ID in the AAR message is not provisioned or that the AAR message did not contain an AF Identifier.

- Update AF ID-specific Dynamic Rule Charging Parameters.

**Note**

This is used when the incoming AAR contains AF Identifier that is provisioned in the table shown in the following figure.

**Figure 13: Dynamic Rule Charging Parameters**

Service Identifier	Rating Group	Online	Offline	Metering Method	Reporting Level	Precedence	AF Application Id	Media Type
B1	1	DISABLE	ENABLE	VOLUME	SERVICE_IDENTIFIER	100	Internet	AUDIO

**Step 8** This configuration is applicable system wide or based on a particular Rx Client if needed. Validate the configuration by executing a basic VoLTE call with the standard Gx configuration. Verify that the CPS is able to handle the incoming AAR message on the Rx interface and can trigger dynamic charging rules on the Gx interface towards the PCEF using the RAR message.

## Sd Interface Configuration

The Sd reference point is located between the Policy and Charging Rules Function (PCRF) and the Traffic Detection Function (TDF).

For the solicited application reporting the Sd reference point is used for:

- Establishment and termination of TDF session between PCRF and TDF.
- Provisioning of Application Detection and Control rules from the PCRF for the purpose of traffic detection and enforcement at the TDF.
- Usage monitoring control of TDF session and of detected applications and reporting of the start and the stop of a detected applications traffic and transfer of service data flow descriptions for detected applications if deducible from the TDF to the PCRF.

For the unsolicited reporting the Sd reference point is used for:

- Establishment and termination of TDF session between PCRF and TDF.

- Reporting of the start and the stop of a detected application's traffic and transfer of service data flow descriptions for detected applications if deducible and transfer of Application instance identifier if service data flow descriptions are deducible from the TDF to the PCRF.

Figure 14: Sd Reference Point

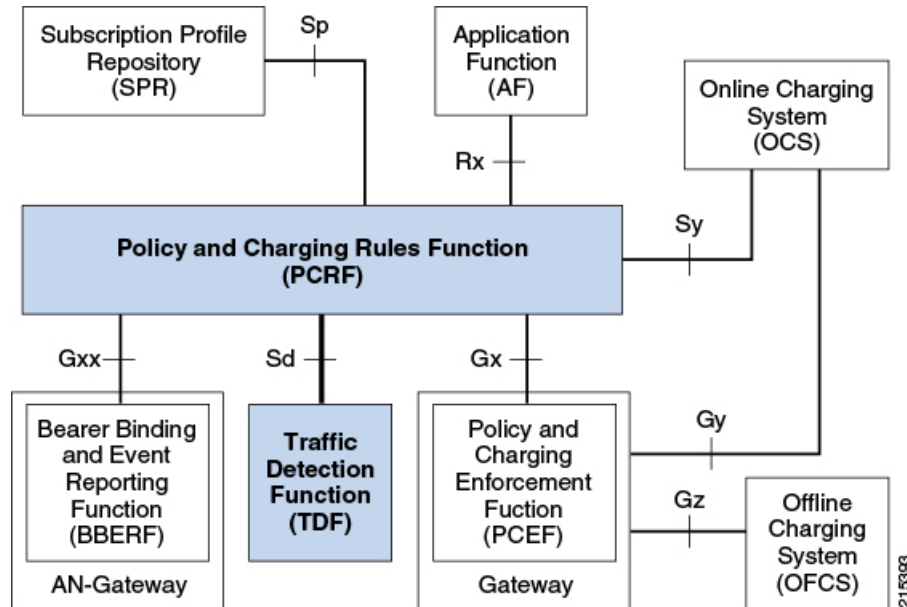

The PCRF may provide ADC Rules to the TDF by using Sd interface.

Once the start or stop of the application's traffic matching one of the ADC Rules is detected if PCRF has previously subscribed to the APPLICATION\_START/APPLICATION\_STOP Event-Triggers unless a request to mute such a notification (Mute-Notification AVP) is part of the corresponding ADC Rule the TDF shall report the information regarding the detected application's traffic to the PCRF and apply the enforcement actions if defined within the corresponding ADC Rule.

#### Use-Case:

The following procedure describes how to initiate an Sd session from PCRF towards the TDF by sending a Predefined ADC Rule using a TDF-Session-Request (TSR) message to the TDF and getting a successful TDF-Session-Answer (TSA) message on the PCRF:

#### Procedure

- 
- Step 1** Open the Policy Builder GUI, and select the **Services** tab.
- Step 2** Create a Gx service as described in [Gx Interface Configuration, on page 1](#).  
Now you are ready to create an Sd service as described in the following steps.
- Step 3** In the left-hand pane, select **Use Case Templates > Summary**.
- Step 4** In the **Summary** pane, click **Use Case Template** under **Create Child**, and then do the following:
- In the **Name** field, type **Sd**.
  - Select **Actions** tab.

- c) Click **Add** under **Service Configurations**.  
The **Select Service Configuration** dialog box opens, and all of the service configuration objects that are available on the PCRF are listed.
- d) Scroll down to the **sd** area in the list of service configuration objects, and select **ADCPredefinedRule**.
- e) Click **OK**.  
The **Select Service Configuration** dialog box closes, and the ADCPredefinedRule object is displayed under **Service Configurations**.

**Step 5** In the left-hand pane, select **Services > Service Options**.

The new Sd option is displayed at the bottom of the list of service options.

**Step 6** Select **Sd** in the **Service Options** list, and do the following:

- a) In the **Sd Summary** pane, click **Service Option** under **Create Child**.  
The **Select Service Configuration** dialog box opens. The ADCPredefinedRule service configuration object is listed under **Service Configurations**.
- b) Click **OK**.
- c) Type **sd** in the **Name** field.
- d) Under **Service Configurations**, select **ADCPredefinedRule**.  
The ADCPredefinedRule parameters display to the right.
- e) Click in the **Value** column beside the **Rule Name** parameter, and type the name of the ADC Rule that is provisioned on the TDF and that the PCRF needs the TDF to enforce. For this example, we used **test-rule-1**.

#### Note

The rule that is being configured here **MUST** already be provisioned on the TDF, or the TDF will return an error (unknown rule name).

**Figure 15: Rule Name parameter**

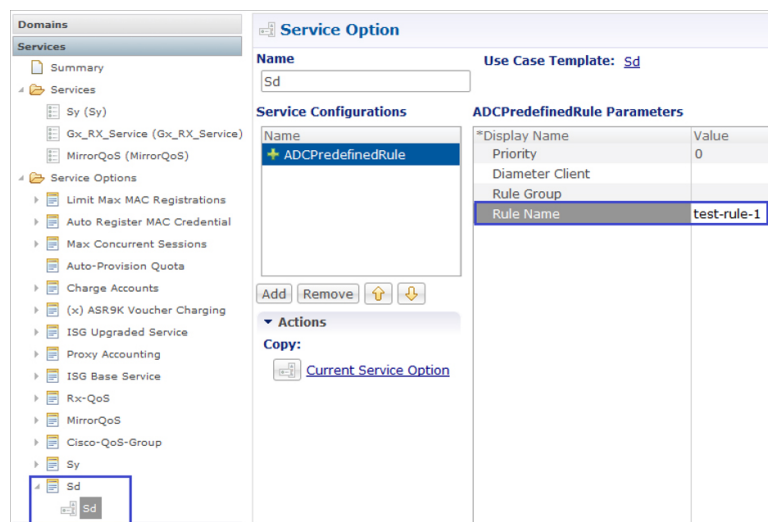

**Step 7** In the left-hand pane, select **Services > Services**.

**Step 8** In the **Services Summary** pane, click **Service** under **Create Child**, and do the following:

- a) Type a descriptive code for the Sd service in the **Code** field.
- b) Type **sd** in the **Name** field.
- c) Uncheck the **Balance Service** option (unless explicitly needed for the use case being developed).

- d) Click **Add**.
- e) In the **Select Service Configuration** dialog box, select the Sd service option, and click **OK**.
- f) Click **Add** again, select the MirrorQoS service option, and click **OK**.
  - By adding the Gx interface 'MirrorQoS' service, PCRF will mirror the QoS for this subscriber.
  - By adding the Sd interface 'Sd' service, PCRF will trigger a TSR request with an ADC rule towards TDF.
  - Both Gx/Sy service options together will generate a successful end-to-end subscriber call.

**Step 9** Select **File > Publish to Runtime Environment**.  
The new Sd service is now available to all Policy Server (QNS) nodes for processing.

**Step 10** Select the **Reference Data** tab.

**Step 11** In the left-hand pane, select **Diameter Defaults > Summary**.

**Step 12** In the **Summary** pane, click **Sd Push Rules** under **Create Child**.

The **Sd Push Rules** pane appears.

In order to initiate connections toward the TDF on the Sd interface, the table shown in the following figure needs to be populated with the origin and remote Host/Realm configuration.

The Sd service/template will send messages to the TDF based on the host/realm configuration defined here.

For more information on how to configure the parameters, see [Diameter Defaults](#).

**Figure 16: Sd Push Rules Configuration Parameters**



**Step 13** Verify that the new Sd service is available for use by doing the following:

- a) Open the control center GUI and go to the **Subscribers** section.
- b) Click **Create Subscriber**.
- c) Enter the IMSI/MSISDN and the name of the subscriber, and then click **Save & Continue**.

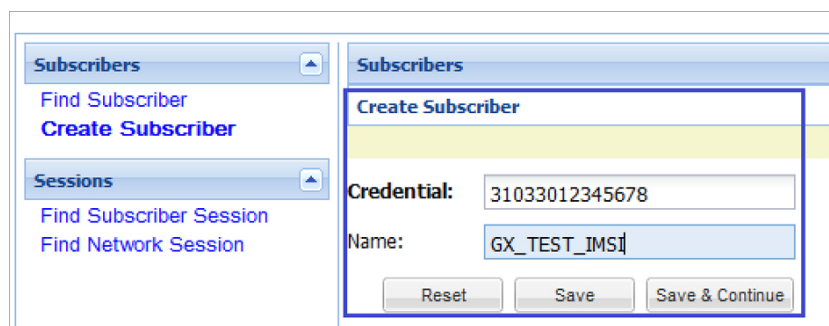

- d) Go to the **Services** section.

- e) Click **add** to open **Select Service** pop-up box which lists the available services, and select the new Sd service.

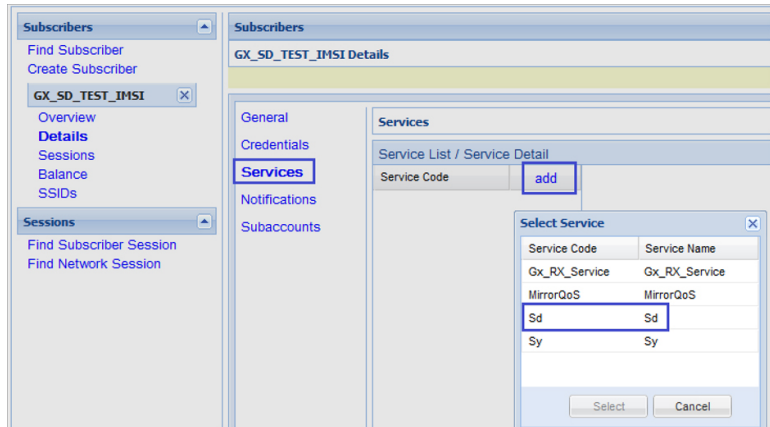

- f) Click **Save** and run a test call to verify the following:
- QoS parameters are mirrored by PCRF in Credit-Control-Answer (Initial) message back to the PCEF.
  - PCRF sends a TDF-Session-Request message to the TDF on the Sd interface (with the Predefined ADC rule), receives TDF-Session-Answer message from the TDF.

## Sh Interface Configuration

CPS supports the ability to connect to the Home Subscriber Server (HSS) over the Sh interface to parse subscriber profile data in order to make policy decisions.

CPS queries the HSS on Gx session establishment and caches the subscriber data locally. CPS allows the operator to configure which attributes need to be extracted from the User-Data AVP and stored.

### Create the Diameter Outbound Peer and Realm Connection to HSS

The connection to the HSS must be enabled by configuring it in the Outbound Peers section in the Diameter Stack configuration.

Refer to [Outbound Peers](#) for instructions.



**Note** When defining the Realm in the Realms table, enter the Processing Protocol as SH\_TGPP.

### Configure the Sh Domain

Sh interface connections in CPS are defined per domain and therefore are configured on the Domains screen in Policy Builder.

Refer to [Domains](#) for more information.



**Note** The following steps represent the most common way to configure an Sh interface connection, but other configuration options are available.

### Procedure

**Step 1** Follow the steps in [Defining the General Attributes of the Domain](#) to create a new domain for the Sh Interface.

**Step 2** On the **General** tab, set **Authorization** to **Allow all Users**.

**Note**

While **Allow all Users** is the most common setting, CPS can be set to have subscribers in the SPR (USuM Authorization) and still use the Sh mechanism for additional profile data.

**Step 3** On the **Provisioning** tab, set **Provisioning** to **<not set>**.

**Step 4** On the **Advanced Rules** tab, select the appropriate service in the **Default Service** field. The default service applies to all subscribers' requests that hit the Sh domain.

**Step 5** Continue with the instructions in [Defining the Additional Profile Data of the Domain](#).

## Configure Multiple Sh Entitlements



**Note** Enabling this feature may result in CPS system performance degradation.

CPS can now receive and parse multiple values via Sh that use the same location in the data structure. These values are then resolved in conjunction with CRD tables to determine the service and appropriate AVPs to add to the session. This capability allows duplicate data structures to be processed and resolved rather than requiring unique data structures for all values, as was the case for CPS versions prior to 11.0.

The following example illustrates an incoming Sh response that contains multiple Entitlement and Custom AttributeName='4GPFO' values that are not unique. A maximum of five values from the incoming response will be used to determine a "bundled" result. The incoming values are processed against the CRD to compress them into a final result based on priorities.

```
<Sh-Data>
  <RepositoryData>
    <ServiceIndication>CamiantUserData</ServiceIndication>
    <SequenceNumber>0</SequenceNumber>
    <ServiceData><CamiantShUser xmlns:xsi='http://www.w3.org/2001/XMLSchema-instance'
xsi:noNamespaceSchemaLocation='CamiantShUser.xsd'>
      <![CDATA[<Version>1.0</Version>
<AccountId>274500345196</AccountId>
<Entitlement>RTA</Entitlement>
<Entitlement>RTB</Entitlement>
<Entitlement>RTC</Entitlement>
<Custom AttributeName='BillingPlanCode'>L03</Custom>
<Custom AttributeName='4GPFO'>THR200k200k</Custom>
<Custom AttributeName='4GPFO'>THR200k300k</Custom>
```

```

    <UserId Type='E164' Scope='Public'>2345557890</UserId>
    <UserId Type='NAI'
Scope='Private'>0333444123456789@epc.mnc444.mcc333.3gpp.network.org</UserId>
    <EquipmentId Type='IMEISV' DeviceType='Phone'>35-209900-176148-23</EquipmentId>]]>
  </CamiantShUser>
</ServiceData>
</RepositoryData>
</Sh-Data>

```

This procedure describes how to configure Policy Builder to assign multiple entitlements to a subscriber, which allows services to be used in a more targeted manner.

## Procedure

- Step 1** Log in to Policy Builder.
- Step 2** Create a Search Table Group and a corresponding Custom Reference Data Table as follows:
- Select the **Reference Data** tab.
  - In the left pane, select **Custom Reference Data Tables**.
  - Click **Search Table Groups**.
  - In the **Search Table Groups Summary** pane, click **Search Table Group** under **Create Child**.
  - In the **Search Table Group** pane, type a name for the group; for example, **subscriber\_sh**. An example is shown below:

**Figure 17: Search Table Group**

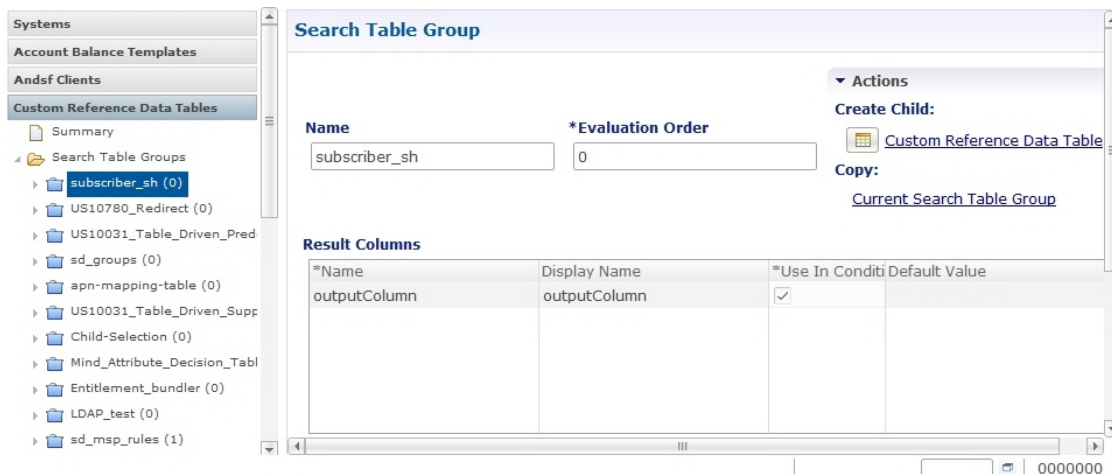

- Click **Custom Reference Data Table** under **Create Child**.
- In the **Custom Reference Data** pane, type a **Name** for the CDR; for example, **subscriber\_sh\_key**.
- Under **Columns**, add a key column, an output column, and a priority column. An example is shown below.

Figure 18: Custom Reference Data Table

**Custom Reference Data Table** Some or all columns in this table have been published and will be

\*Name: subscriber\_sh\_key      Display Name: subscriber\_sh\_key       Cache Results

Activation Condition:  select clear       Best Match      \*Evaluation Order: 1

*Name	Display Name	*Use In Condi	*Type
keyColumn	keyColumn	<input checked="" type="checkbox"/>	Text
outputColumn	outputColumn	<input checked="" type="checkbox"/>	Text
priorityColumn	priorityColumn	<input checked="" type="checkbox"/>	Number

Add Remove ↑ ↓

**Step 3**

Configure a bundle profile as follows:

- Under **Custom Reference Data Tables** in the left pane, click **Bundle Profiles**.
- In the **Bundle Profiles Summary** pane, click **Bundle Profile** under **Create Child**.
- In the **Bundle Profile** pane, type a **Name** for the profile; for example, **Entitlement**.
- If you want the bundle profile to apply to the CRD and/or Service Resolution processes, select **Use for Crd Resolution** and/or **Use for Service Resolution**.
- In the **Search Table Group** field, type the name of the search table group.
- In the **Key Column**, **Priority Column** and **Output Column** fields, use the **Select** button to select the names of the columns that were configured in the CRD table. An example is shown below:

Figure 19: Bundle Profile

**Bundle Profile**

\*Name: Entitlement       Use For Crd Resolution       Use For Service Resolution      \*Search Table Group: subscriber\_sh select clear

\*Key Column: keyColumn select clear      \*Priority Column: priorityColumn select clear      \*Output Column: outputColumn select clear

**Step 4**

Configure the Sh Profile in a new domain or in an existing one:

- Select the Policy Builder **Services** tab.
- In the left pane, select **Domains**.
- Select an existing domain under **Domains** to edit, or click **Domain** under **Create Child** in the **Service Reference Data Objects** pane to create a new one.

**Note**

If this is a new domain type a name for it; for example, **Sh MultipleEntitlements**.

- In the **Domain** pane, click the **Additional Profile Data** tab.
- Select **Sh Profile** in the pull-down menu on the right-hand side of the **Additional Profile** section heading.
- Under **Profile Mappings**, add a new **External Code** and name it using the bundle profile name; in our example, the bundle profile name is Entitlement. An example configuration is shown below:

Figure 20: External Code Configuration using Bundle Profile Name

**Domain**

Name:   Is Default

General | Provisioning | **Additional Profile Data** | Locations | Advanced Rules

Additional Profile: Sh Profile

**Profile Mappings**

*External Code	*Mapping Type	Regex Expression	*Regex Group	Missing Avp Value	Empty Avp Value
BillingPlanCode	SubscriberAttribute		1		
4GPFO	SubscriberAttribute		1		
L03	SubscriberAttribute		1		
Entitlement	SubscriberAttribute		1		

Buttons: Add, Remove, Up Arrow, Down Arrow

- g) On rare occasions, you may want to select the **Use Service Indications For Service Resolution** option if you want the Service Indications to be put into the policy state for services resolution. Service Indications are used in the outgoing UDR/SNR to tell the HSS what data to send back to CPS.

**Note**

If you decide to select this option, do so only after consulting with Cisco Advanced Services.

## LDAP/Ud Interface Configuration

For more information on LDAP/Ud interface configuration, refer to [Domains](#).