



Overview

- [USP Introduction, page 1](#)
- [USP Architecture, page 2](#)
- [Ultra Automation Services, page 3](#)
- [Ultra Web Services, page 10](#)
- [Installing the UWS, page 11](#)
- [Accessing the UWS GUI, page 11](#)

USP Introduction

The Ultra Services Platform (USP) is a 5G-ready virtual mobility network platform that provides a robust and highly scalable architecture that can quickly deploy mobility services across a distributed network in a virtualized environment. 5G will support countless emerging use cases with a variety of applications that drive significant variability in their performance attributes. From delay-sensitive mobile video applications to infrequent connectivity for simple devices, the diversity of use cases will demand substantially increased throughput, lower latency, ultra-high reliability with substantially higher connection densities.

The USP is a complex Virtual Network Function (VNF) conforming to the European Telecommunications Standards Institute (ETSI) Network Function Virtualization (NFV) and NFV Management and Orchestration (MANO) specifications. Unlike simple VNFs constrained to a single Virtual Machine (VM), the USP is a complex VNF comprised of multiple VNF Components (VNFCs) with a variable number of VMs depending on feature optioning and desired performance specifications.

Leveraging these virtualization, automation and orchestration technologies, the USP enables a NFV architecture that allows VNFs to be “sliced” into smaller, customizable end-to-end instances capable of seamless scaling

regardless of the use case. The flexibility brings network providers to true Mobility-as-a-Service (MaaS) offering.

Figure 1: USP Network Slicing

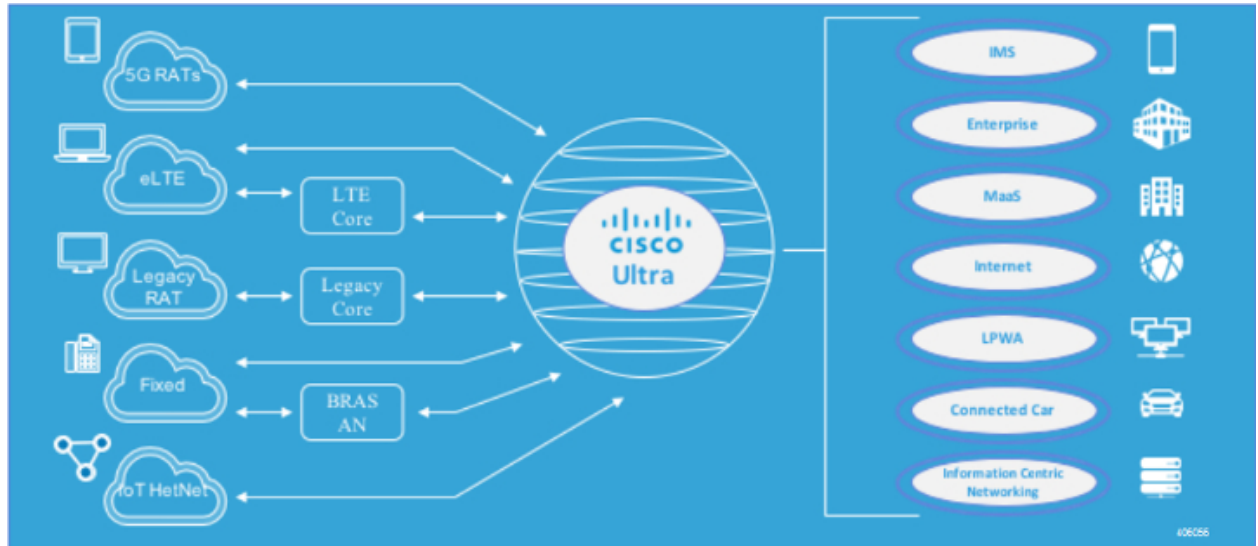

USP Architecture

The USP solution comprises the following components:

- Ultra Service Platform VNF:** The USP couples a Virtual Network Function Element Manager (VNF-EM) and multiple VNF components (VNFCs) into a single complex VNF. This coupling conforms to the European Telecommunications Standards Institute (ETSI) NFV Management and Orchestration (NFV MANO) standard and greatly simplifies MANO operations. A separate web-based customer portal called the Ultra Web Service (UWS) is supported in conjunction with the USP VNF and other network elements to simplify the deployment and management of the VNF.
- Ultra Web Services (UWS):** The UWS provides an environment to graphically construct the USP VNF by allowing a user to select which VNF components are present and enter the necessary deployment parameters needed to instantiate the solution. Once this composition process is complete, the UWS passes the configuration to Ultra Automation Services which generates an ETSI NFV-compliant VNF Descriptor (VNFD). The VNFD is then on-boarded into an NFV Orchestrator (NFVO).

- **Ultra Automation Services (UAS):** UAS provides a suite of automation tools that simplify the on-boarding process of the USP VNF into any Cisco or third-party NFV infrastructure (NFVI).

Figure 2: USP Solution Components in the ETSI MANO Network

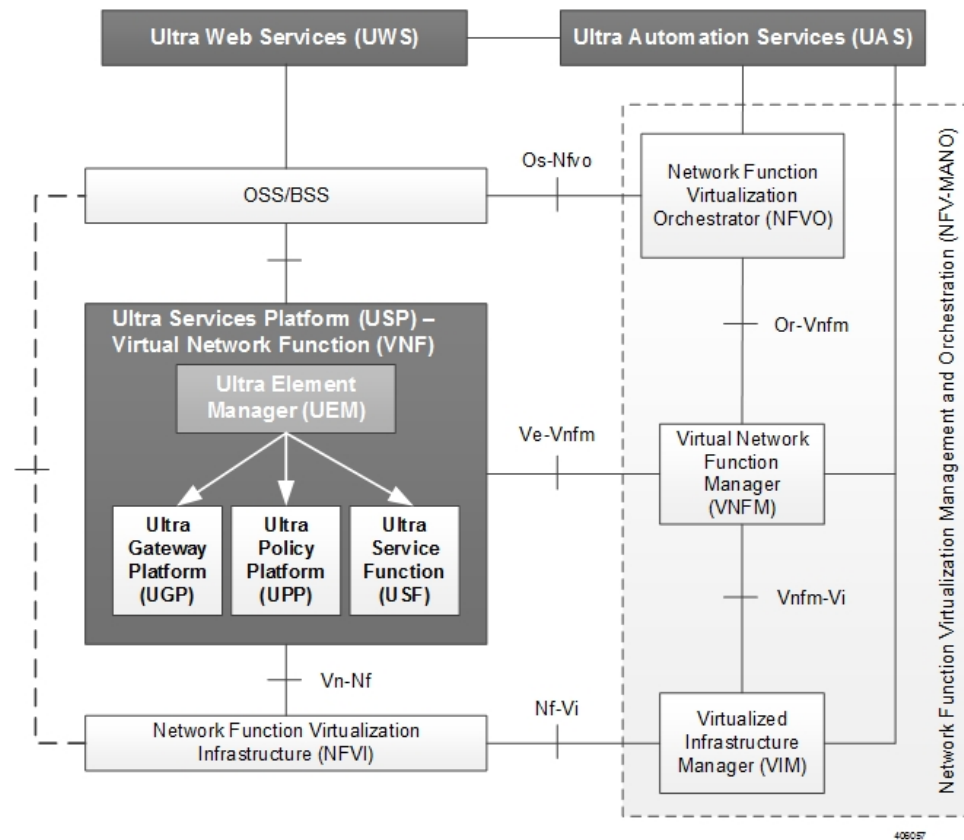

Ultra Automation Services

Ultra Automation Services (UAS) is an automation framework consisting of a set of software modules used to automate the USP-based VNF deployment and related components such as the VNFM. Beyond deployment automation, UAS manages software bundle components within an inventory manager. In addition, it can also be used to automate the deployment of third party components such as NFVI/VIM, test tools, and USFs that are not part of the distributed USP software bundle. The UAS consists of:

- [AutoIT-NFVI](#), on page 4
- [AutoIT-VNF](#), on page 5
- [AutoDeploy](#), on page 6
- [AutoVNF](#), on page 7

All of the above software modules within the UAS use the same software image. Their specific configurations dictate their operation.

[High-level Single VNF Deployment Automation Workflow](#) displays a high-level view of the deployment automation workflow for a single VNF. In a multi-VNF environment, AutoDeploy brings up the initial VNF through the point at which the UEM assigns VIP IP addresses to the CFs. Once that operation is successful, AutoDeploy begins the process of deploying AutoVNF for the next VNF. Additional details pertaining to the deployment automation process are provided in the Deployment Automation documentation.



Note In this release, multi-VNF deployments are supported only in the context of the Ultra M solution. Refer to the *Ultra M Solutions Guide* for details.

Figure 3: High-level Single VNF Deployment Automation Workflow

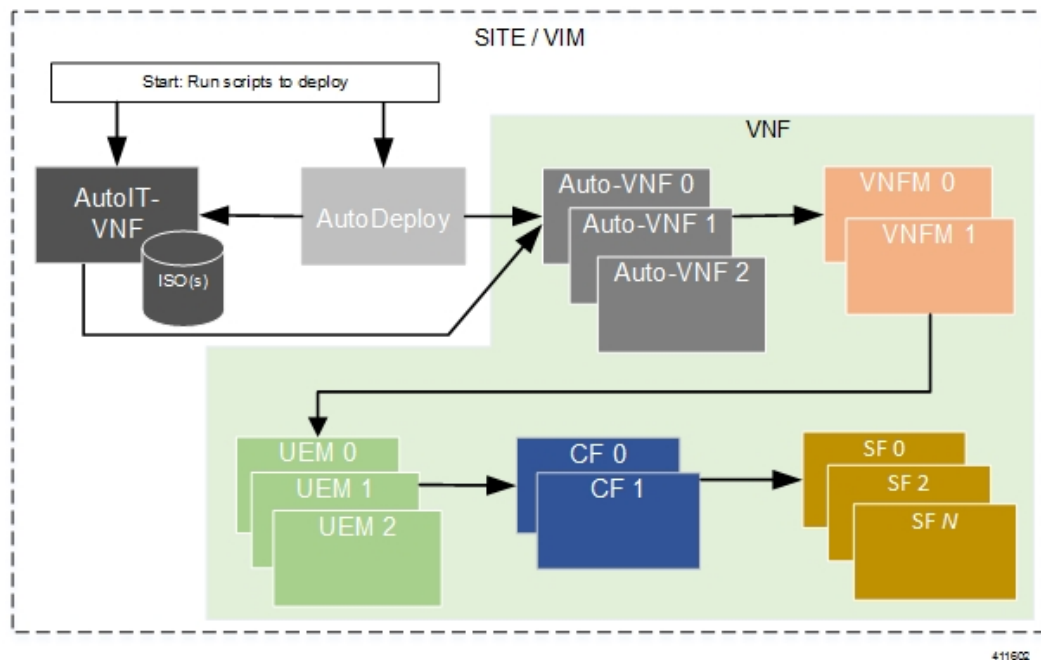

The UAS software modules can be configured/accessed through the command line interface. In addition, the [Ultra Web Services](#), on page 10 provides a graphical user interface (GUI) for performing the same operations and workflows.

AutoIT-NFVI

AutoIT-NFVI is the UAS software module used to automate the process of installing the virtual infrastructure manager (VIM, synonymous with the OpenStack Overcloud) which manages the network function virtualization infrastructure (NFVI). It is also used to deploy the VIM Orchestrator (synonymous with the OpenStack Undercloud).

AutoIT-NFVI is deployed as a VM on the same physical server as AutoDeploy and OSP-D VM and performs the installations based on manifests it receives from AutoDeploy. It provides the following functions:

- Sets up AutoIT-NFVI nodes
- API endpoint based on ConfD to Auto-Deploy and NSO

- Deploys the VIM Orchestrator
- Works through the VIM Orchestrator to deploy the VIM
- Brings up OSP-D as a VM

**Note**

In this release, AutoIT-NFVI is only supported for use with Ultra M solutions based on the Hyper-Converged architecture.

AutoIT-VNF

AutoIT-VNF is the UAS software module used to onboard/upgrade the USP ISO software package onto the Ultra M Manager Node . It also hosts a webserver to facilitate VM deployment and delivery of software packages using REST and ConfD APIs for provisioning Overcloud nodes. AutoIT-VNF is deployed as a single VM on one of the OSD Compute nodes to support the following additional functions:

- Onboarding Ultra Automation Services (UAS) VMs.
- VIM provisioning to onboard VNFs.
- Manages different version of software packages by hosting into YUM repo.
- APIs to onboard VNF packages.
- Brings up AutoVNF cluster and monitors for failures.

- Stores release public key information in the ISO database for RPM signature verification by YUM through the installation process.

Figure 4: AutoIT-VNF Functions

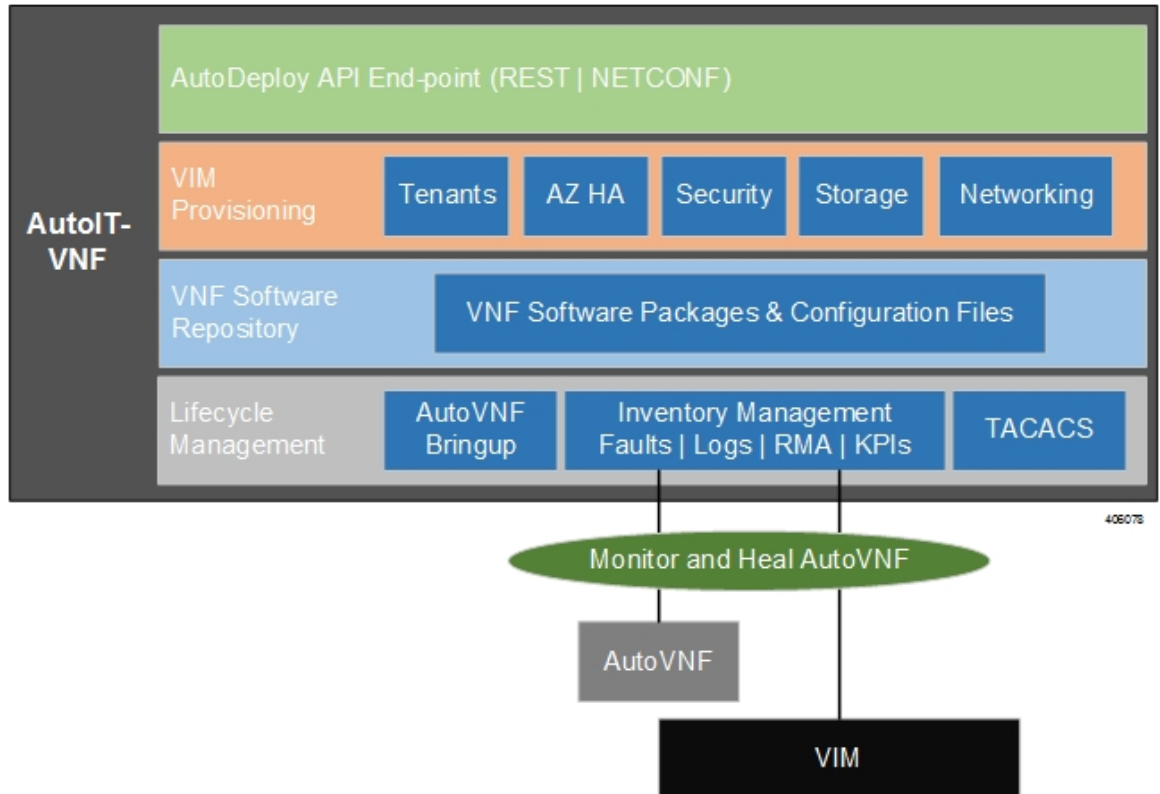

AutoDeploy

AutoDeploy is the UAS software module that provides single- and multi-Site AutoVNF orchestration. In this context, a “Site” is a single VIM instance. As such, a single AutoDeploy instance is capable of deploying AutoVNF UAS software modules within multiple deployment scenarios:

- Single VIM/Single VNF
- Single VIM/Multi-VNF



Note

In this release, multi-VNF deployments are supported only in the context of the Ultra M solution. Refer to the *Ultra M Solutions Guide* for details.

AutoDeploy is instantiated as a single VM on the same physical hardware as the AutoIT-NFVI and the OSP-D VMs. In this release, one AutoDeploy VM is deployed per VIM. The AutoDeploy VM must have network access to the VIM in order to provide orchestration.

Once instantiated, AutoDeploy provides the following functionality:

- AutoVNFs bootstrapping and provisioning for deployments (Day-0/Day-1/Day-N).
- AutoVNF Deployments Life-Cycle including start, stop and Inventory management (consolidated).
- Performs release image signing validation by verifying the certificate and public key provided in the release ISO.

Figure 5: AutoDeploy Functions

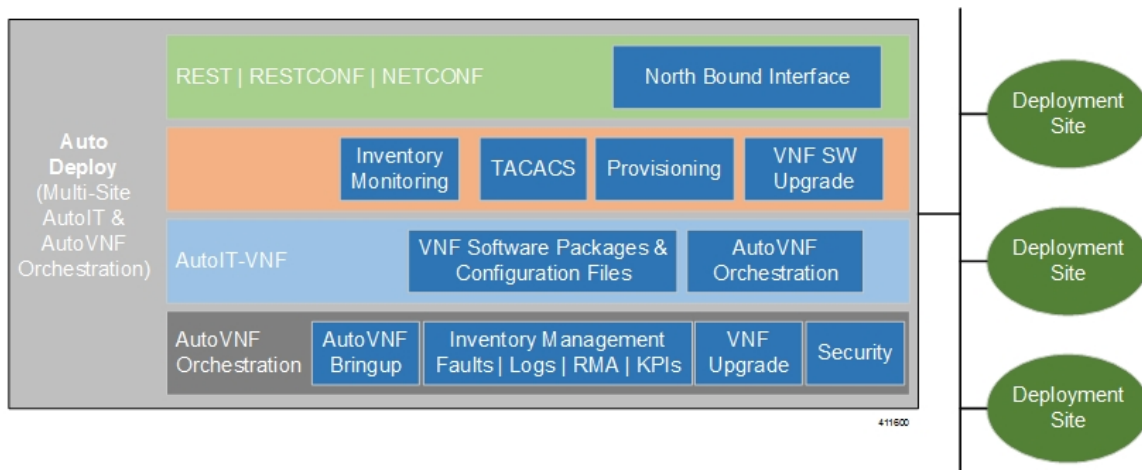

AutoDeploy operations are performed using any of the following methods:

- ConfD CLI based transactions
- WebUI based transactions

AutoVNF

AutoVNF is the software module within UAS that provides deployment orchestration for USP-based VNFs. It does this by emulating an NFVO and VNFM for deployments.

AutoVNF is instantiated by the AutoDeploy software module based on configuration data you provide. It is deployed in a HA cluster consisting of 3 VMs: 1 leader or master (active), 1 follower or slave (standby), and 1 follower (standby). Processes across the VMs are monitored and restarted if necessary. ConfD synchronizes the CDB between the master and slave VMs. Each of the 3 VMs are deployed on separate Compute nodes within your OpenStack Overcloud.

Once operational, AutoVNF provides the following functionality:

- Deploys the Elastic Services Controller (ESC), which serves as the VNFM, per configurable YANG-based definitions.



Note The Cisco Elastic Services Controller (ESC) is the only supported VNFM in this USP release.

- Onboards all required UEM VMs via the VNFM.

- Leverages configurable YANG-based definitions to generate the VNF descriptor (VNFD) required to onboard the VNF using UEM workflows.
- Determines all required resources for the VNF including images, flavors, networks, subnets and invokes NETCONF-based APIs to provision all of these resources into OpenStack through the VNFM.
- Ensures all references, network, images, and flavors exist on the VIM, if supplied.
- Monitors for NETCONF-based notifications, submits the transaction, and waits until the given transaction succeeds.
- Monitors inventory in terms of operational state and KPIs and auto-heals the VNFM and UEM.
- Orchestrates USP-based VNF upgrades regardless of whether or not Inter-Chassis Session Recovery (ICSR) is enabled on the VNF.
- Implements a ConfD-based architecture to provide life cycle management (LCM) through VNF-EM, VNFM, and VIM plugins as shown in [Figure 7: AutoVNF ConfD-based Architecture for Deployment Automation, on page 9](#).
- Supports standard, ConfD-based REST/RESTCONF/NETCONF north-bound interfaces (NBIs).
- Provides VNF security, credentials, and SSH keys through the use of secure-tokens.
- Hosts an HTTP server to serve GET URLs supplied into the VNFD that include such things as configuration files, VDU images, etc.
- Supplies the VNFD to the UEM upon instantiation as Day-0 configuration using an appropriate VNFM-supported mechanism (e.g. in the case of ESC as the VNFM, the VNFD is passed as a Day-0 configuration using the ESC's deployment APIs).
- Onboards all Day-0 configuration files onto the UEM to be passed on to VDUs.

- Allocates the management IP for the CF and UEM VMs along with Virtual IP (VIP) addresses.

Figure 6: AutoVNF Functions

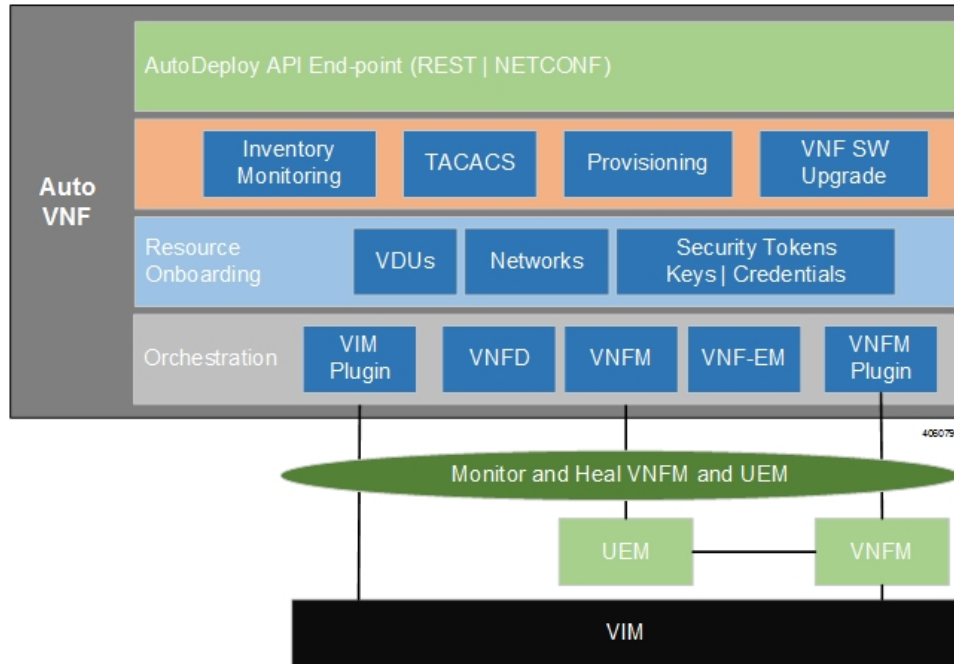
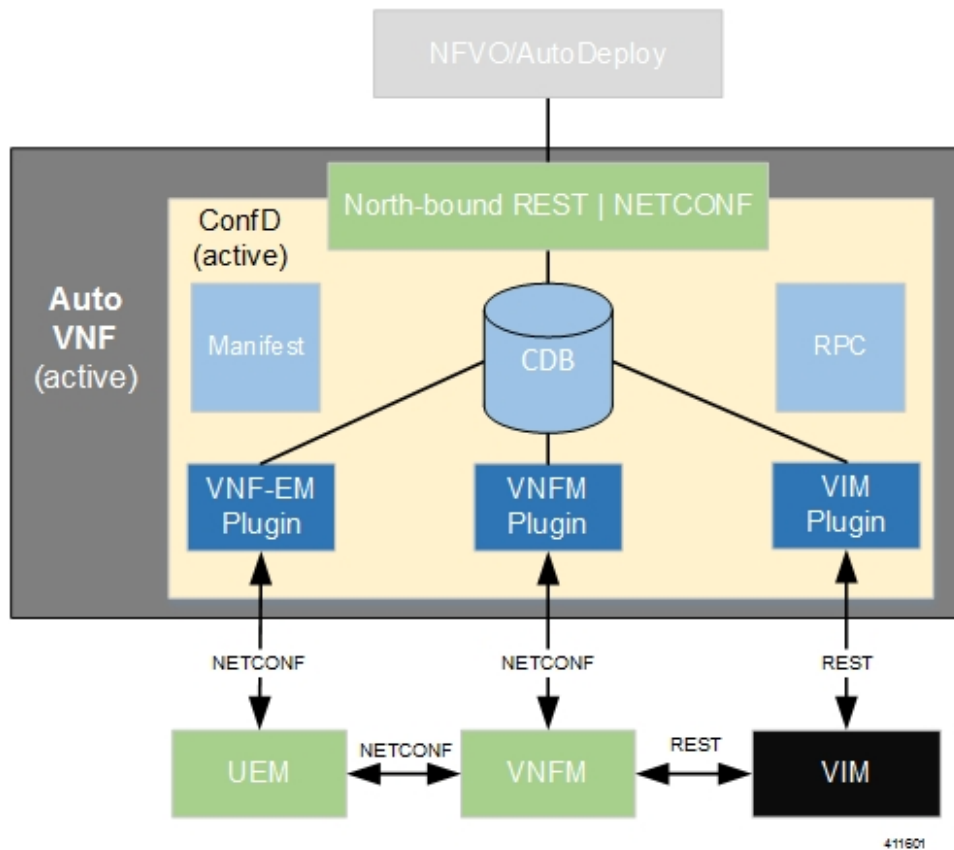

Figure 7: AutoVNF ConfD-based Architecture for Deployment Automation



AutoVNF operations can be performed using any of the following methods:

- ConfD CLI based transactions
- WebUI based transactions
- Netconf based transactions

Ultra Web Services

The Ultra Web Service (UWS) provides a web-based graphical user interface (GUI) and a set of functional modules that enable users to manage and interact with the USP VNF. It provides a single framework and a top-level dashboard for users to interact with the USP VNF. It includes the following features:

- Service Assurance
- Validation
- VNF-EM Virtualization
- VNF Components
- NFVI/VIM

Leveraging backend-APIs, the VNF visualization module of UWS is used to create, deploy and monitor a variety of USP VNFs based on specific use cases and applications. The VNFs can include definitions for the gateway type, policy options, service function chaining features, and more. After the VNFs are created, users can deploy each VNF to a target infrastructure choice. The USP tracks deploy operations. Users can display the tracked information on the dashboard, and can monitor the status of a selected deployment operation. The dashboard also displays aggregate KPIs from all deployed VNFs, allowing users to easily view and monitor aggregate metrics for a given environment.

UWS software is part of the UAS software package and is installed automatically with the AutoDeploy software module.

The following browser versions are supported for use with the UWS GUI:

- Firefox: 55.0.3 (64-bit)
- Safari: Version 10.1.1 (10603.2.5)
- Chrome: 58.0.3029.110 (64-bit)
- Edge: 38.14393.1066.0

Installing the UWS

The Ultra Web Services application is installed as part of the Ultra Automation Service. Refer to the *Cisco Ultra Services Platform Deployment Automation Guide* for information on installing the Ultra Automation Service including the Ultra Web Services application.

Accessing the UWS GUI

Use the following task to launch the UWS GUI:

Before You Begin

Ensure that the AutoDeploy is deployed and operational. For more information, see the *Cisco Ultra Services Platform Deployment Automation Guide*.

Step 1 Open your web browser.
NOTE: Refer to [Ultra Web Services, on page 10](#) for a list of supported web browsers.

Step 2 Enter the IP address in the supported web browser:
`https://<auto-deploy-vm-floating-ip-address>:8443/`

The address corresponds to the externally accessible IP address of the VM where you have installed the UWS followed by the port number (8443). For example:

192.168.251.1:8443

Step 3 Log in to the UWS - AutoDeploy GUI using the credentials configured previously for the user.

Step 4 Click **Login**.
