



# Unified CCE Reference Designs

- [Introduction to the Reference Designs, on page 1](#)
- [Benefits of a Reference Design Solution, on page 3](#)
- [Specifications for a Reference Design Solution, on page 3](#)
- [Contact Center Enterprise Reference Designs, on page 6](#)
- [Topologies for Reference Designs, on page 27](#)
- [Non-Reference Design Solutions, on page 29](#)

## Introduction to the Reference Designs



**Note** The first four chapters of this book are for anyone who wants to get familiar with the contact center enterprise solutions:

- Packaged Contact Center Enterprise
- Unified Contact Center Enterprise

For information about design considerations and guidelines specific to Unified CCE, see the remaining chapters.

The Contact Center Enterprise Reference Designs are a set of Cisco validated designs of our contact center enterprise solutions. The Reference Designs define the technologies and topologies that fit the needs for most deployments. The Reference Designs focus on simplifying the contact center enterprise solution design. They provide complete contact center functionality based on components that are strategic to Cisco.

We have defined the Reference Designs in the following table to cover most contact center needs:

**Table 1: Reference Design Use by Contact Center Enterprise Solution**

Reference Design	Packaged CCE	Unified CCE
2000 Agents	Yes	Yes
4000 Agents	Yes	Yes
12000 Agents	Yes	Yes

Reference Design	Packaged CCE	Unified CCE
24000 Agents	No	Yes
Contact Director	No	Yes
Non-Reference Designs	Avaya PG and ICM-to-ICM Gateway	Yes

If your solution exceeds the configuration limits for a particular Reference Design, use a Reference Design with higher limits. For example, if your 2000-agent deployment requires 350 active reporting users, use the 4000 Agent Reference Design for your solution.

Contact center solutions that include something not covered by the Contact Center Enterprise Reference Designs are called *Non-Reference Designs*.

You require Unified CCE for any other Non-Reference Design deployments.

## Reference Designs and Deployment Types

The Contact Center Enterprise Reference Designs are mapped to specific contact center solutions through deployment types. Deployment types are system codes that impose system limits and apply congestion control.

This table maps the Reference Designs and Non-Reference Designs with the deployment type that you use for each.

**Table 2: Deployment Type Usage by Reference Design**

Reference Design	Packaged CCE	Unified CCE
	Label	Label
2000 Agent	Packaged CCE: 2000 Agents	UCCE: 2000 Agents
4000 Agent	Packaged CCE: 4000 Agents	UCCE: 4000 Agents
12000 Agent	Packaged CCE: 12000 Agents	UCCE: 12000 Agents
24000 Agent	NA	UCCE: 24000 Agents Router/Logger
Contact Director	NA	Contact Director
Non-Reference Designs	Avaya PG and ICM-to-ICM Gateway Packaged CCE: 4000 Agents Packaged CCE: 12000 Agents	ICM Rogger
		ICM Router/Logger
		UCCE: 8000 Agents Router/Logger
Lab Only Designs	Packaged CCE: Lab Mode	UCCE: Progger (Lab Only)

## Benefits of a Reference Design Solution

Contact centers offer more possibilities with each new generation of software and hardware. New technology can make previously preferred methods obsolete for current contact centers. We created the Contact Center Enterprise Reference Designs to simplify your design choices and speed the development of your contact center. We expect that most new contact centers can use the Reference Designs to meet their needs.

By following the Reference Designs, you can:

- Guide your customers' expectations by presenting clear options.
- Streamline your design process with standard models.
- Avoid using components and features that are near the end of their lifecycle.
- Find powerful and efficient replacements for obsolete features.
- Align your designs with Cisco's vision of our future contact center developments.
- Enjoy quicker and easier approval processes.

## Specifications for a Reference Design Solution

The Reference Designs define our vision of the functionality that most contact centers use. The Reference Designs consist of:

- **Core components**—Components that make up every contact center:
  - Ingress, Egress, and VXML Gateways
  - Unified Customer Voice Portal (Unified CVP)
  - Unified Contact Center Enterprise (Unified CCE)
  - Cisco Virtualized Voice Browser (VVB)
  - Unified Communications Manager (Unified CM)
  - Cisco Finesse
  - Cisco Unified Intelligence Center
- **Optional Cisco components**—Components that add functionality that not every contact center needs.
  - Customer Collaboration Platform
  - Cisco Unified SIP Proxy
  - Enterprise Chat and Email
  - Cisco IdS
  - Cloud Connect
  - Custom Remote Server

- **Optional third-party components**—Third-party components that you can add to provide other features.
  - Load balancers
  - Recording
  - Speech servers - ASR/TTS
  - Wallboards
  - Workforce management
- **Integrated features**—These features do not require you to add an optional solution component to enable them. But, these features can require configuration in multiple solution components to activate them. They can affect your solution sizing and might have specific design considerations.
- **Call flows**—Standard contact handling and routing methods.
  - Inbound Calls:
    - New calls from a carrier
    - New internal calls
  - Supplementary services
    - Hold and resume
    - Transfers and conferences
    - Refer transfers
    - Network transfers
    - Requery and survivability
- **Topologies**—Standard layouts for your contact center components:
  - Centralized
  - Distributed
  - Global

This figure shows the high-level services that are part of the solutions and the components that provide those services. It also highlights some features and components that are outside of the Reference Designs:



---

**Note** This figure highlights only a few Non-Reference Design components and topologies. The Non-Reference Design sections expand on this list.

---

Figure 1: Contact Center Enterprise Reference and Non-Reference Designs

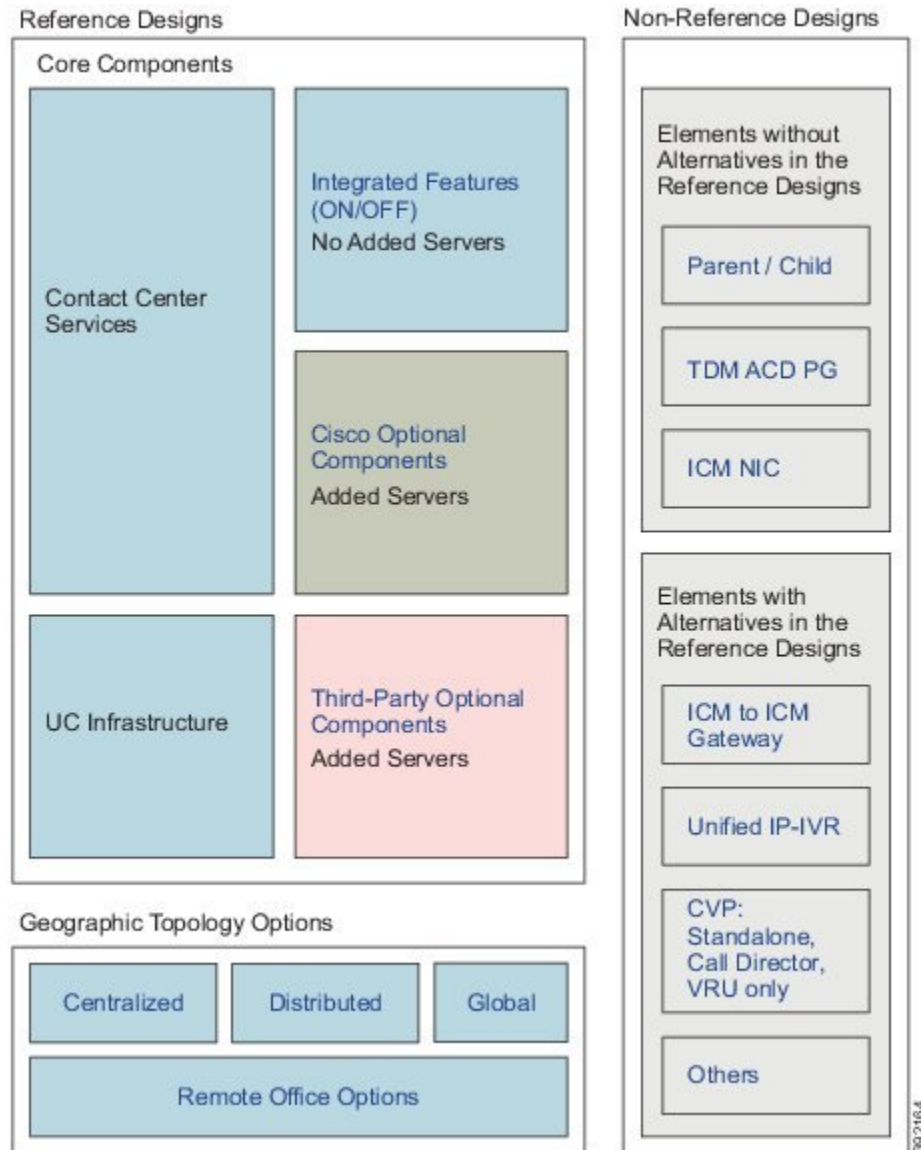

**Note** In general, you cannot use the ICM-to-ICM Gateway in Reference Designs. Only the Contact Director Reference Design allows you to use that gateway.

This figure encapsulates the basic requirements of a Reference Design-compliant deployment:

Figure 2: Contact Center Enterprise Components and Features

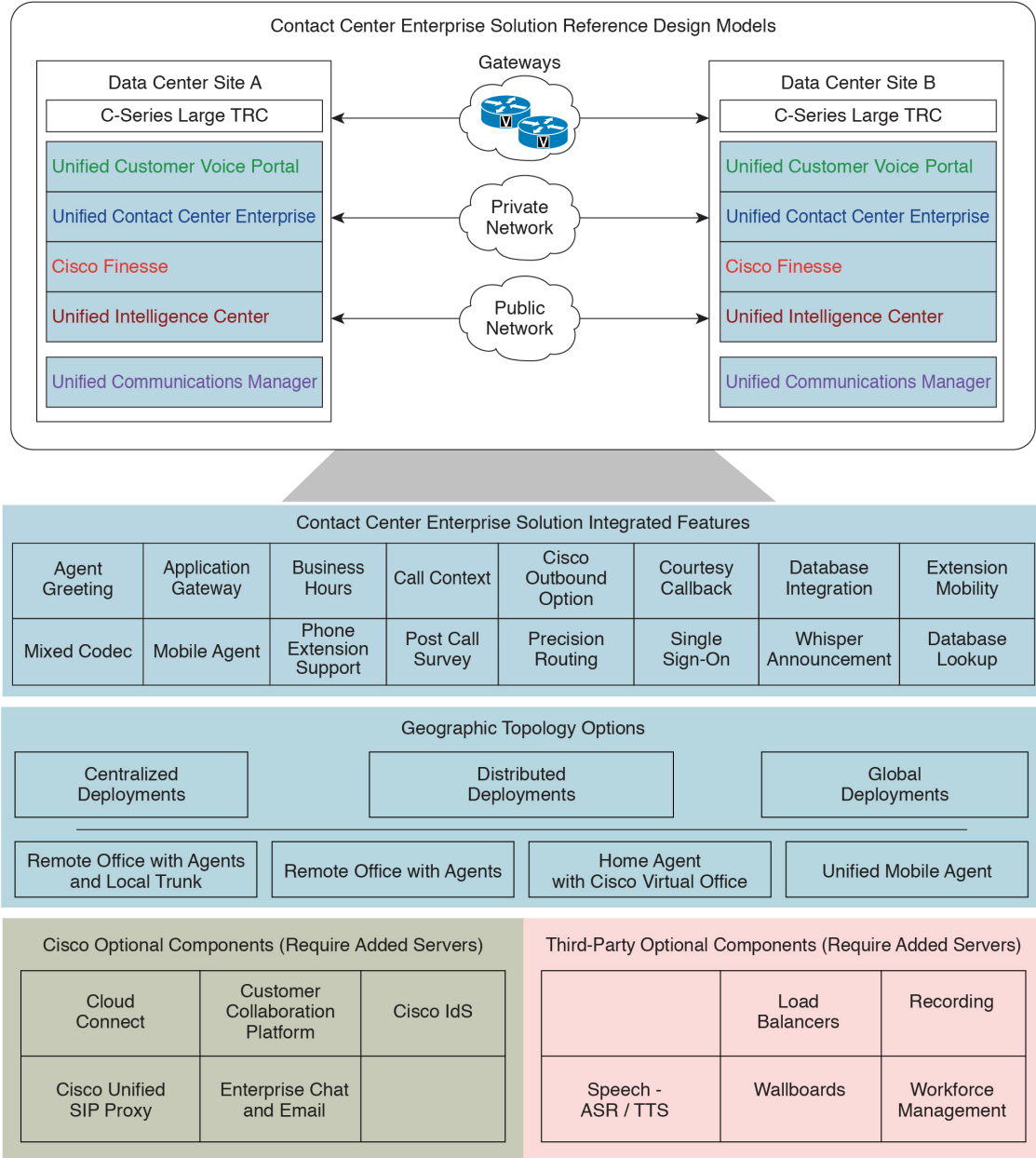

510652

# Contact Center Enterprise Reference Designs

The following sections describe the Contact Center Enterprise Reference Designs.

The Reference Designs are supported for Cisco UCS C240 M5SX, Cisco UCS C240 M6SX, and Cisco HX220c-M5SX Tested Reference Configuration (TRC) servers as detailed in the Cisco Collaboration Infrastructure Requirements wiki: [https://www.cisco.com/c/dam/en/us/td/docs/voice\\_ip\\_comm/uc\\_system/virtualization/cisco-collaboration-infrastructure.html](https://www.cisco.com/c/dam/en/us/td/docs/voice_ip_comm/uc_system/virtualization/cisco-collaboration-infrastructure.html).



**Note** For more details on supported servers for the Reference Designs, see the *Cisco Collaboration Virtualization* page for your solution at [http://www.cisco.com/c/dam/en/us/td/docs/voice\\_ip\\_comm/uc\\_system/virtualization/cisco-collaboration-virtualization.html](http://www.cisco.com/c/dam/en/us/td/docs/voice_ip_comm/uc_system/virtualization/cisco-collaboration-virtualization.html).

The following notes apply to all the Reference Designs:

- Contact Center Enterprise solutions use vCPU oversubscription. This policy applies for both Reference Design and Non-Reference Design solutions.
- The standard PG VM includes an Agent (Unified CM) PG, a VRU PG, and an MR PG. Unified CCE allow you to add more PGs and their peripherals onto this base layout.
- Cloud Connect can be on-box (as depicted in the following sections) for deployments on the Cisco HX220c-M5SX server, whereas, on the Cisco UCS C240 M5SX or Cisco UCS C240 M6SX servers, Cloud Connect must be off-box.
- Cloud Connect requires only 146 GB of disk space if the CCE Orchestration feature is not used.
- CVP Reporting server, Cisco VVB, and Cloud Connect are optional components.
- The TRC layouts for Cisco UCS C240 M5SX and Cisco UCS C240 M6SX servers are identical. Note that only a single-socket 28-core CPU is used for the Cisco UCS C240 M6SX servers. If customers wish to use the additional socket on the Cisco UCS C240 M6SX servers with corresponding increase in cores, memory, and disks, the hardware will be supported under spec-based VM provisioning policies.
- Cisco HX220c-M6S servers are supported in accordance with spec-based policies only.
- CVP Reporting server and Cisco VVB are optional components.
- Based on your business and deployment requirements, you may distribute the VVB VMs on external servers, or as depicted in this section, deploy them on additional servers or nodes (in the case of M5-HX clusters).
- If the layout is on the Cisco HX220c-M5SX or Cisco HX220c-M6S server, you can deploy the additional VVB servers on HX nodes in the same cluster, or on external M5 or M6 servers, respectively.
- VVB with AppD enabled CPU MHz utilization spikes during services start up. VVB OVA profiles has upper threshold set as unlimited so there are no changes in OVA profile. This impact is only during services start up but not under general or load scenarios.
- An HX cluster can consist of a combination of compute and converged nodes, provided that all resource requirements and resource constraints are satisfied in accordance with the Virtual Machine Resource Provisioning Policy. This is supported only as a spec-based deployment model.
- For information on the data source allocation of the components in the Reference Design layouts, see the *Cisco Unified Contact Center Enterprise Installation and Upgrade Guide* at <https://www.cisco.com/c/en/us/support/customer-collaboration/unified-contact-center-enterprise/products-installation-guides-list.html>
- The Reference Design layouts in this section do not show off-box components like Customer Collaboration Platform.
- If you upgrade to Release 12.6(1) on Cisco UCS C240 M4SX server, we recommend that you install an additional 32 GB of memory on all servers to accommodate the increased memory requirements of the Release 12.6(1) VMs.

## Virtual Machines Resource Provisioning Policy



---

**Note** The previously used Oversubscription policy is a part of the Virtual Machine (VM) Resource Provisioning Policy.

---

The Unified CCE Reference Designs support the virtual machine vCPU oversubscription of the physical CPU cores on a server. For the purposes of oversubscription, the hyper-thread cores do not count as physical cores. Whether or not you use oversubscription, use the VM Resource Provisioning policy. This policy limits the total available CPU MHz and the memory of a server that the host-resident VMs can consume.

Apply the VM Resource Provisioning policy when:

- You change the documented Reference Design VM layout by adding or replacing VMs. This means that you use a custom or non-Reference VM layout in a Reference Design solution.
- You provision a non-Reference Design server.
- You provision a Reference Design server for optional and third-party components that are not given a reference VM layout.
- You use UCS or third-party specifications-based servers.
- You upgrade an existing solution and do not migrate to a Reference Design VM layout.



---

**Note** Apply the VM Resource Provisioning policy on a per-server basis. This policy does not apply to the Reference Design VM layouts. Your solution can contain servers that use the Reference Design VM layouts and other VM layouts that use the VM Resource Provisioning policy rules.

---

The application of the VM Resource Provisioning policy requires meeting the following conditions:

- You can use up to two vCPUs for every physical core on each server.
- You can use up to 65% of the total available CPU MHz on each server.
- You can use up to 80% of the total available memory on each server.

For more information on virtualization and specification-based server policies, see the *Cisco Collaboration Virtualization* at [http://www.cisco.com/c/dam/en/us/td/docs/voice\\_ip\\_comm/uc\\_system/virtualization/cisco-collaboration-virtualization.html](http://www.cisco.com/c/dam/en/us/td/docs/voice_ip_comm/uc_system/virtualization/cisco-collaboration-virtualization.html).



---

**Note** The Virtual Machine Placement Tool does not currently allow you to oversubscribe. This limitation is only an issue with the tool. You can oversubscribe within the limits that are provided here.

---



---

**Note** The custom remote server should have the same provisioning specification as Unified CVP server.

---



## 2000 Agent Reference Designs

All contact center enterprise solutions support the 2000 Agent Reference design on the Cisco UCS C240 M5SX or Cisco UCS C240 M6SX and the Cisco HX220c-M5SX Large TRC servers.

- In this Reference Design, Cisco Unified Intelligence Center, Live Data, and the Identity Service for Single Sign-On are coresident on a single VM. In the larger Reference Designs, they reside in separate VMs.
- You can optionally deploy the Unified Communications Manager Publisher and Subscribers on separate servers, instead of deploying them as shown in the 2000 Agent Reference Design layout. You should dedicate two of the subscribers to Unified CCE. All devices on these subscribers must be SIP.

In 2000 Agent Reference Designs, a coresident Unified CM can support a maximum of 2000 phones. This includes your phones for all types of agents, whether contact center agents or back-office workers. If your solution requires more than 2000 phones, use a Unified CM on a separate server instead.

- In the global deployment topology, each remote site can have its own Unified CM cluster. A remote site cannot include a Cisco Unified Intelligence Center server.
- You can deploy optional AW-HDS-DDS per site on external servers for longer data retention.
- In 2000 Agent Reference Designs, you can deploy ECE Data Server on-box for up to 400 agents. Deploy ECE off-box for up to 1500 agents.

You can also deploy the ECE Data Server on a separate server.

- Deploy the ECE Web Server on an external server. You can place that server either in the same data center as the ECE Data Server or in a DMZ if customer chat interactions require that.



---

**Note** Adding more disks is not permitted in the Packaged CCE 2000 agent deployment. Any changes to the number of disks will result in a VM validation error.

---

## Support on the Cisco UCS C240 M5SX and Cisco UCS C240 M6SX Large TRC Servers



---

**Important** If you plan to upgrade to 12.x on Cisco UCS C240 M4SX servers, deploy Unified CM and ECE HA VMs on external servers.

---

The following figure shows the base layout of the components in a 2000 Agent Reference Design on Cisco UCS C240 M5SX and Cisco UCS C240 M6SX Large TRC servers.

Figure 3: 2000 Agent Reference Design Model

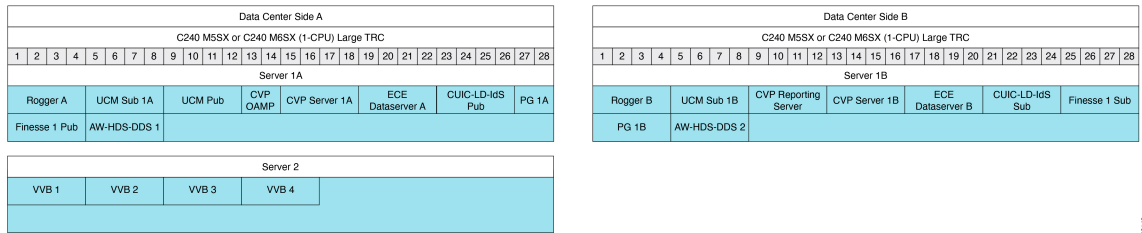

This table lists the specifications for VMs.

Table 3: VM Specifications for 2000 Agent Reference Design

VM	vCPU	MHz	vRAM	vDisk 1	vDisk 2	vDisk 3
Rogger	4	5000	6	80	150	
Unified CM	4	7200	8	110		
Unified CVP OAMP	2	400	4	80		
Unified CVP Server	4	3000	12	250		
Unified CVP Reporting Server	4	1800	6	80	438	
ECE Dataserver <sup>1</sup>	4	4000	20	80	50	300
CUIC-LD-Ids	4	5500	16	200		
AW-HDS-DDS	4	5000	16	80	500	
PG	2	4000	6	80		
Finesse	4	5000	16	146		
VVB	4	9000	10	146		

<sup>1</sup> For the latest VM specifications, see the row for 400 agents in the **Virtualization for Enterprise Chat and Email** page at [https://www.cisco.com/c/dam/en/us/td/docs/voice\\_ip\\_comm/uc\\_system/virtualization/virtualization-enterprise-chat-email.html](https://www.cisco.com/c/dam/en/us/td/docs/voice_ip_comm/uc_system/virtualization/virtualization-enterprise-chat-email.html).

Table 4: Total VM Requirements for 2000 Agent Reference Design

Server	vCPU	MHz	vRAM	vDisk
Data Center Site A	36	46300	112	2216
Data Center Site B	34	40500	106	2544
Server 2	16	36000	40	584

## Support on the Cisco HX220c-M5SX TRC Server

This figure shows the base layout of the components in a 2000 Agent Reference Design on Cisco HX220c-M5SX TRC server.

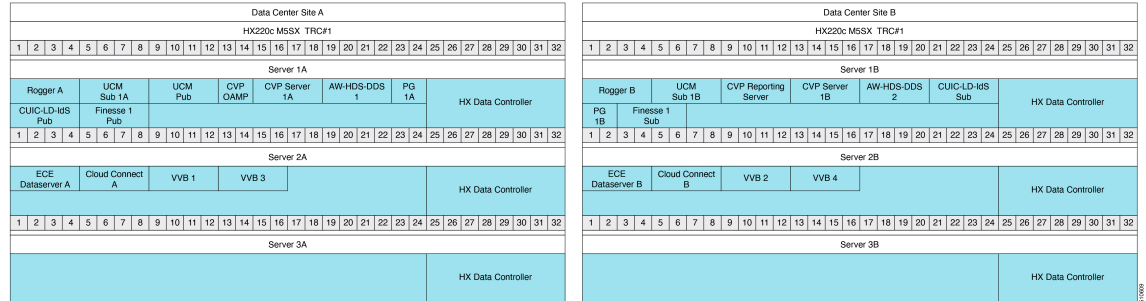

This table lists the specifications for VMs.

**Table 5: VM Specifications for 2000 Agent Reference Design**

VM	vCPU	MHz	vRAM	vDisk1	vDisk2	vDisk 3
HX Data Controller	16	10800	48			
Rogger	4	5000	6	80	150	
Unified CM	4	7200	8	110		
Unified CVP OAMP	2	400	4	80		
Unified CVP Server	4	3000	12	250		
Unified CVP Reporting Server	4	1800	6	80	438	
ECE Dataserver <sup>2</sup>	4	4000	20	80	50	300
CUIC-LD-IdS	4	5500	16	200		
AW-HDS-DDS	4	5000	16	80	750	
PG	2	4000	6	80		
Finesse	4	5000	16	146		
VVB	4	9000	10	146		
Cloud Connect	4	6000	10	246		

<sup>2</sup> For the latest VM specifications, see the row for 400 agents in the **Virtualization for Enterprise Chat and Email** page at [https://www.cisco.com/c/dam/en/us/td/docs/voice\\_ip\\_comm/uc\\_system/virtualization/virtualization-enterprise-chat-email.html](https://www.cisco.com/c/dam/en/us/td/docs/voice_ip_comm/uc_system/virtualization/virtualization-enterprise-chat-email.html).

**Table 6: Total VM Requirements for 2000 Agent Reference Design**

Server	vCPU	MHz	vRAM	vDisk
Data Center Site 1A	48	53100	140	1786
Data Center Site 1B	46	47300	134	2114
Data Center Site 2A	32	38800	98	968
Data Center Site 2B	32	38800	98	968

## 4000 Agent Reference Designs

All contact center enterprise solutions support the 4000 Agent Reference design on the following TRC servers:

- Cisco UCS C240 M5SX Large
- Cisco UCS C240 M6SX Large
- Cisco HX220c-M5SX

This model adds servers to scale up from the 2000 Agent Reference Design.



**Note** You can only deploy two AW-HDS-DDS per data center site in the 4000 Agent Reference Design. In larger solutions, you use a combination of HDS-DDS and AW-HDS.

## Support on the Cisco UCS C240 M5SX and Cisco UCS C240 M6SX TRC Servers



**Important** If you plan to upgrade to 12.x on Cisco UCS C240 M4SX servers, make the following changes to your servers and VM layouts:

- Deploy Unified CM and ECE HA VMs on external servers.
- Add 16 GB of physical RAM to each server that hosts Unified CVP call and VXML servers.
- Increase the memory reservations for the Unified CVP VMs to 12 GB.

This figure shows the base layout of the components in a 4000 Agent Reference Design on Cisco UCS C240 M5SX and Cisco UCS C240 M6SX TRC servers.

**Figure 4: 4000 Agent Reference Design Model**

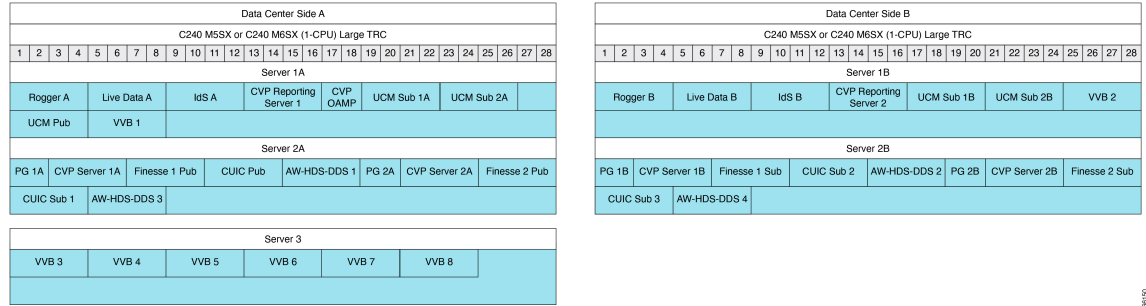

This table lists the specifications for VMs.

**Table 7: VM Specifications for 4000 Agent Reference Design**

VM	vCPU	MHz	vRAM	vDisk 1	vDisk 2
Rogger	4	5000	6	80	150
Live Data	4	5500	32	146	
IdS	4	1500	10	146	
Unified CVP Reporting Server	4	1800	6	80	438
Unified CVP OAMP	2	400	4	80	
Unified CM	4	7200	8	110	
PG	2	4000	6	80	
Unified CVP Server	4	3000	12	250	
Finesse	4	5000	16	146	
Unified Intelligence Center	4	3600	16	200	
AW-HDS-DDS	4	5000	16	80	500
VVB	4	9000	10	146	

**Table 8: Total VM Requirements for 4000 Agent Reference Design**

Server	vCPU	MHz	vRAM	vDisk
Data Center Site A - Server 1A	34	44800	92	1596
Data Center Site B - Server 1B	28	37200	80	1406
Data Center Site A - Server 2A	36	45000	132	2512

Server	vCPU	MHz	vRAM	vDisk
Data Center Site B - Server 2B	36	45000	132	2512
Server 3	24	54000	60	876

## Support on the Cisco HX220c-M5SX TRC Server

This figure shows the base layout of the components in a 4000 Agent Reference Design on Cisco HX220c-M5SX TRC server.

**Figure 5: 4000 Agent Reference Design Model**

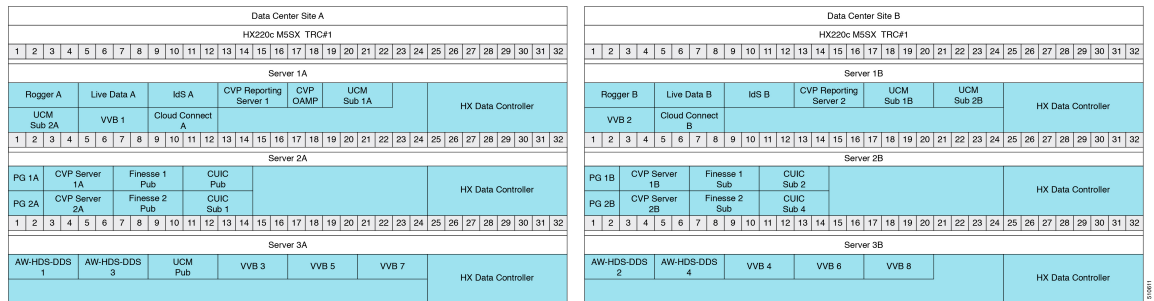

This table lists the specifications for VMs.

**Table 9: VM Specifications for 4000 Agent Reference Design**

VM	vCPU	MHz	vRAM	vDisk 1	vDisk 2
HX Data Controller	16	10800	48		
Rogger	4	5000	6	80	150
Live Data	4	5500	32	146	
IdS	4	1500	10	146	
Unified CVP Reporting Server	4	1800	6	80	438
Unified CVP OAMP	2	400	4	80	
Unified CM	4	7200	8	110	
PG	2	4000	6	80	
Unified CVP Server	4	3000	12	250	
Finesse	4	5000	16	146	
Unified Intelligence Center	4	3600	16	200	
AW-HDS-DDS	4	5000	16	80	500

VM	vCPU	MHz	vRAM	vDisk 1	vDisk 2	
VVB	4	9000	10	146		
Cloud Connect	4	6000	10	246		

**Table 10: Total VM Requirements for 4000 Agent Reference Design**

Server	vCPU	MHz	vRAM	vDisk
Data Center Site A - Server 1A	50	54400	142	1732
Data Center Site B - Server 1B	48	54000	138	1652
Data Center Site A - Server 2A	48	50800	164	1932
Data Center Site B - Server 2B	48	50800	164	1932
Data Center Site A - Server 3A	24	44200	70	1708
Data Center Site A - Server 3B	20	37000	62	1598

## 12000 Agent Reference Designs

This Reference Design for a contact center enterprise solution supports 12000 agents on the following TRC servers:

- Cisco UCS C240 M5SX Large
- Cisco UCS C240 M6SX Large
- Cisco HX220c-M5SX

This model adds servers to scale up from the 4000 Agent Reference Design.

### Support on the Cisco UCS C240 M5SX and Cisco UCS C240 M6SX Large TRC servers

The following figure shows the base layout of the components in a 12000 Agent Reference Design on Cisco UCS C240 M5SX and Cisco UCS C240 M6SX Large TRC servers.

Figure 6: 12000 Agent Reference Design Model

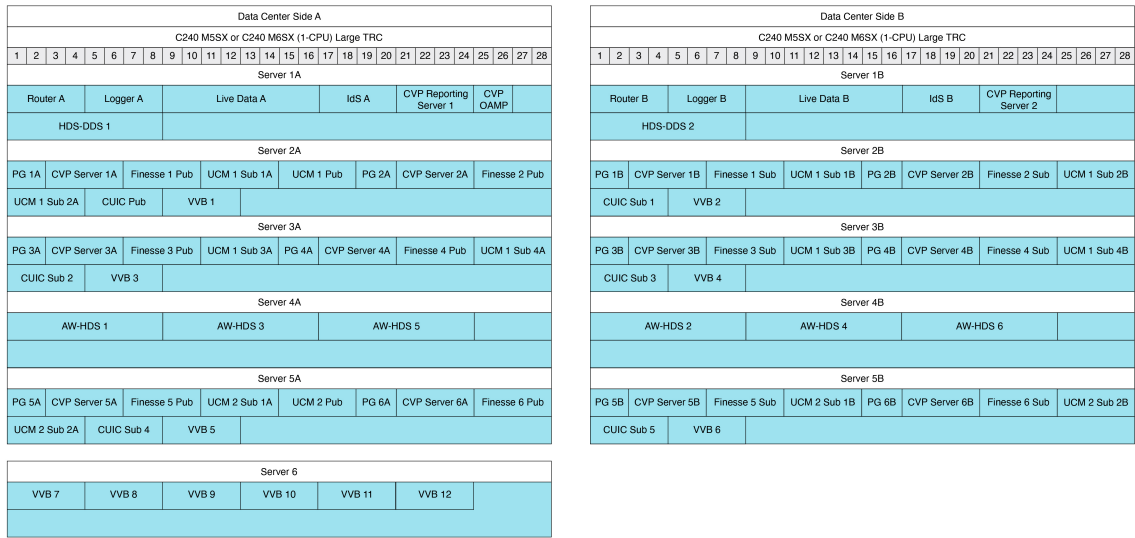

This table lists the specifications for VMs.

Table 11: VM Specifications for 12000 Agent Reference Design

VM	vCPU	MHz	vRAM	vDisk 1	vDisk 2
Router	4	4000	8	80	
Logger	4	6000	8	80	500
Live Data	8	16500	32	146	
IdS	4	1500	10	146	
Unified CVP Reporting Server	4	1800	6	80	438
Unified CVP OAMP	2	400	4	80	
HDS-DDS	8	17500	16	80	420
AW-HDS	8	17500	16	80	500
PG	2	4000	6	80	
Unified CVP Server	4	3000	12	250	
Finesse	4	5000	16	146	
Unified CM	4	7200	8	110	
Unified Intelligence Center	4	3600	16	200	
VVB	4	9000	10	146	



**Table 12: Total VM Requirements for 12000 Agent Reference Design**

<b>Server</b>	<b>vCPU</b>	<b>MHz</b>	<b>vRAM</b>	<b>vDisk</b>
Data Center Site A - Server 1A	34	47700	84	2050
Data Center Site B - Server 1B	32	47300	80	1970
Data Center Site A - Server 2A	40	60100	118	1628
Data Center Site B - Server 2B	36	52900	110	1518
Data Center Site A - Server 3A	36	52900	110	1518
Data Center Site B - Server 3B	36	52900	110	1518
Data Center Site A - Server 4A	24	52500	48	1740
Data Center Site B - Server 4B	24	52500	48	1740
Data Center Site A - Server 5A	40	60100	118	1628
Data Center Site B - Server 5B	36	52900	110	1518
Server 6	24	54000	60	876

## Support on the Cisco HX220c-M5SX TRC Server

This figure shows the base layout of the components in a 12000 Agent Reference Design on Cisco HX220c-M5SX TRC server.

Figure 7: 12000 Agent Reference Design Model

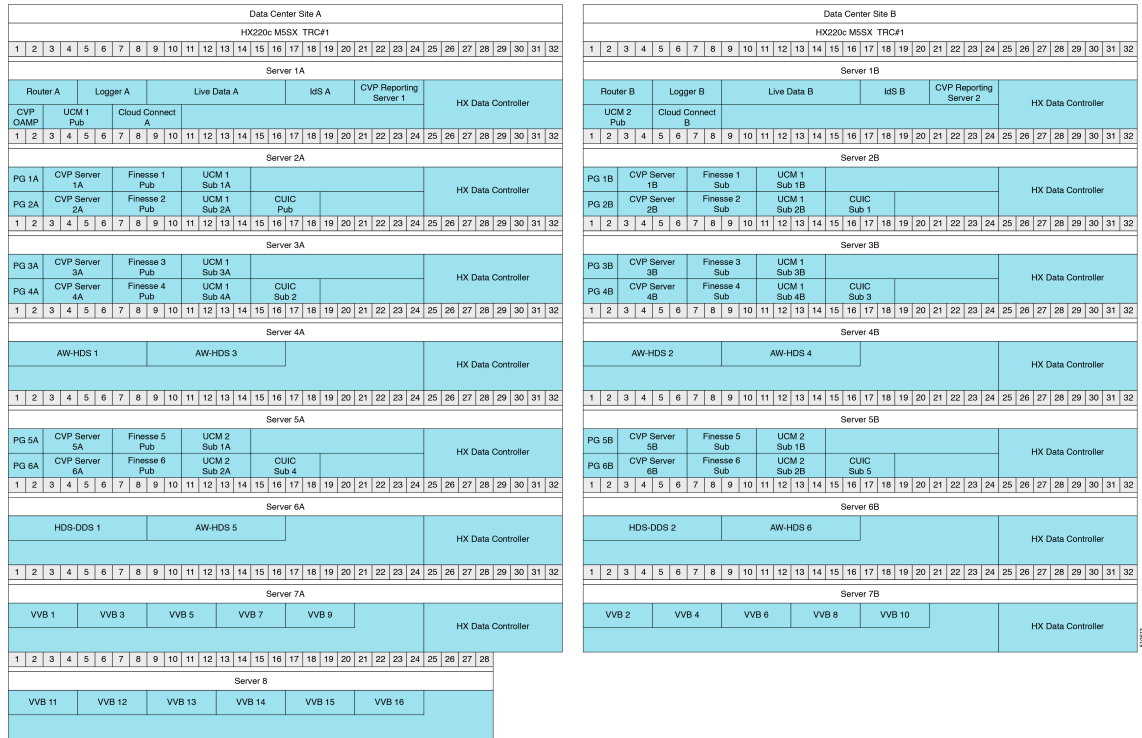

This table lists the specifications for VMs.

Table 13: VM Specifications for 12000 Agent Reference Design

VM	vCPU	MHz	vRAM	vDisk 1	vDisk 2
HX Data Controller	16	10800	48		
Router	4	4000	8	80	
Logger	4	6000	8	80	500
Live Data	8	16500	32	146	
IdS	4	1500	10	146	
Unified CVP Reporting Server	4	1800	6	80	438
Unified CVP OAMP	2	400	4	80	
HDS-DDS	8	17500	16	80	500
AW-HDS	8	17500	16	80	500
PG	2	4000	6	80	
Unified CVP Server	4	3000	12	250	

VM	vCPU	MHz	vRAM	vDisk 1	vDisk 2
Finesse	4	5000	16	146	
Unified CM	4	7200	8	110	
Unified Intelligence Center	4	3600	16	200	
VVB	4	9000	10	146	
Cloud Connect	4	6000	10	246	

**Table 14: Total VM Requirements for 12000 Agent Reference Design**

Server	vCPU	MHz	vRAM	vDisk
Data Center Site A - Server 1A	50	54200	134	1906
Data Center Site B - Server 1B	48	53800	130	1826
Data Center Site A - Server 2A	48	54700	148	1372
Data Center Site B - Server 2B	48	54700	148	1372
Data Center Site A - Server 3A	48	54700	148	1372
Data Center Site B - Server 3B	48	54700	148	1372
Data Center Site A - Server 4A	32	45800	80	1160
Data Center Site B - Server 4B	32	45800	80	1160
Data Center Site A - Server 5A	48	54700	148	1372
Data Center Site B - Server 5B	48	54700	148	1372
Data Center Site A - Server 6A	32	45800	80	1080
Data Center Site B - Server 6B	32	45800	80	1080
Data Center Site B - Server 7A	36	55800	98	730
Data Center Site B - Server 7B	36	55800	98	730
Server 8	24	54000	60	876

## Reporting Users in the 12000 Agent Reference Design Model

AW-HDS 3, AW-HDS 4, AW-HDS 5, and AW-HDS 6 in Servers 4A and 4B, are optional to support more than 400 reporting users. Servers 5A and 5B are optional to support more than 8000 agents. Servers 6A and 6B are optional to support more than 400 reporting users.

This Reference Design supports a maximum of six CUIC VMs and six AW-HDS VMs, three VMs on each site. This limit can accommodate a maximum of 1200 reporting users. If one site shuts down, the remaining site can only support 600 reporting users on its three nodes.

# 24000 Agent Reference Designs

This Reference Design for a contact center enterprise solution supports 24000 agents on the following TRC servers:

- Cisco UCS C240 M5SX Large
- Cisco UCS C240 M6SX Large
- Cisco HX220c-M5SX

This model adds servers to scale up from the 12000 Agent Reference Design.



**Note** A Unified CCE solution with PGs of version 11.6 and Packaged CCE do not support the 24000 Agent Deployment.

## Support on the Cisco UCS C240 M5SX and Cisco UCS C240 M6SX Large TRC Servers

The following figure shows the base layout of the components in a 24000 Agent Reference Design on Cisco UCS C240 M5SX and Cisco UCS C240 M6SX Large TRC servers.

**Figure 8: 24000 Agent Reference Design Model**

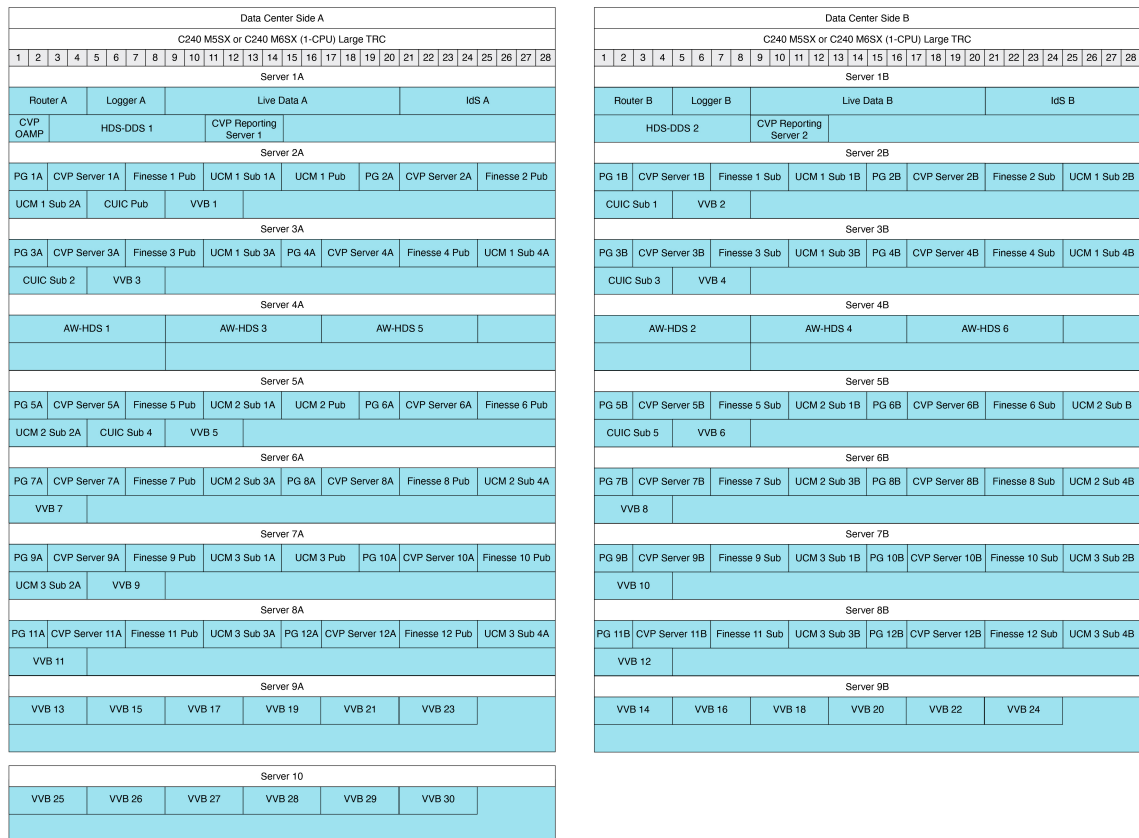

40012

This table lists the specifications for VMs.

**Table 15: VM Specifications for 24000 Agent Reference Design**

VM	vCPU	MHz	vRAM	vDisk 1	vDisk 2
Router	4	4000	8	80	
Logger	4	6000	8	80	500
Live Data	12	24000	46	146	
IdS	8	3000	10	146	
Unified CVP Reporting Server	4	1800	6	80	438
Unified CVP OAMP	2	400	4	80	
HDS-DDS	8	17500	16	80	500
AW-HDS	8	17500	16	80	500
PG	2	4000	6	80	
Unified CVP Server	4	3000	12	250	
Finesse	4	5000	16	146	
Unified CM	4	7200	8	110	
Unified Intelligence Center	4	3600	16	200	
VVB	4	9000	10	146	

**Table 16: Total VM Requirements for 24000 Agent Reference Design**

Server	vCPU	MHz	vRAM	vDisk
Data Center Site A - Server 1A	42	56700	98	2130
Data Center Site B - Server 1B	40	56300	94	2050
Data Center Site A - Server 2A	40	60100	118	1628
Data Center Site B - Server 2B	36	52900	110	1518
Data Center Site A - Server 3A	36	52900	110	1518
Data Center Site B - Server 3B	36	51400	110	1518
Data Center Site A - Server 4A	24	52500	48	1740
Data Center Site B - Server 4B	24	52500	48	1740
Data Center Site A - Server 5A	40	60100	118	1628

Server	vCPU	MHz	vRAM	vDisk
Data Center Site B - Server 5B	36	52900	110	1518
Data Center Site A - Server 6A	32	47400	94	1318
Data Center Site B - Server 6B	32	47400	94	1318
Data Center Site A - Server 7A	36	54600	102	1428
Data Center Site B - Server 7B	32	47400	94	1318
Data Center Site A - Server 8A	32	47400	94	1318
Data Center Site B - Server 8B	32	45900	94	1318
Data Center Site A - Server 9A	24	54000	60	876
Data Center Site B - Server 9B	24	54000	60	876
Server 10	24	54000	60	876

## Support on the Cisco HX220c-M5SX TRC Server

This figure shows the base layout of the components in a 24000 Agent Reference Design on Cisco HX220c-M5SX TRC server.



VM	vCPU	MHz	vRAM	vDisk 1	vDisk 2
Unified CVP OAMP	2	400	4	80	
HDS-DDS	8	17500	16	80	420
AW-HDS	8	17500	16	80	500
PG	2	4000	6	80	
Unified CVP Server	4	3000	12	250	
Finesse	4	5000	16	146	
Unified CM	4	7200	8	110	
Unified Intelligence Center	4	3600	16	200	
VVB	4	9000	10	146	
Cloud Connect	4	6000	10	246	

**Table 18: Total VM Requirements for 24000 Agent Reference Design**

Server	vCPU	MHz	vRAM	vDisk
Data Center Site A - Server 1A	54	56900	146	1770
Data Center Site B - Server 1B	48	49300	134	1580
Data Center Site A - Server 2A	48	54700	148	1372
Data Center Site B - Server 2B	48	54700	148	1372
Data Center Site A - Server 3A	48	54700	148	1372
Data Center Site B - Server 3B	48	54700	148	1372
Data Center Site A - Server 4A	32	45800	80	1160
Data Center Site B - Server 4B	32	45800	80	1160
Data Center Site A - Server 5A	48	54700	148	1372
Data Center Site B - Server 5B	48	54700	148	1372
Data Center Site A - Server 6A	44	49200	132	1172
Data Center Site B - Server 6B	44	49200	132	1172
Data Center Site A - Server 7A	44	49200	132	1172
Data Center Site B - Server 7B	44	49200	132	1172
Data Center Site A - Server 8A	44	49200	132	1172



Server	vCPU	MHz	vRAM	vDisk
Data Center Site B - Server 8B	44	49200	132	1172
Data Center Site A - Server 9A	36	51800	90	1326
Data Center Site B - Server 9B	36	51800	90	1326
Data Center Site A - Server 10A	36	55800	98	730
Data Center Site B - Server 10B	36	55800	98	730
Server 11	24	54000	60	876

## Reporting Users in the 24000 Agent Reference Design Model

AW-HDS 3, AW-HDS 4, AW-HDS 5, and AW-HDS 6 in Servers 4A and 4B, are optional to support more than 400 reporting users. Servers 5A and 5B are optional to support more than 8000 agents. Servers 6A and 6B are optional to support more than 400 reporting users.

This Reference Design supports a maximum of six CUIC VMs and six AW-HDS VMs, three VMs on each site. This limit can accommodate a maximum of 1200 reporting users. If one site shuts down, the remaining site can only support 600 reporting users on its three nodes.

## Scale up to 36000 Agents

You can modify your existing 24000 agent reference design to scale up to 36000 agents.



**Note** 36000 concurrent Agents and corresponding configuration limits while employing the 24k Agent deployment model is not supported through CCMP.

The 36000 agent deployment must adhere to the spec-based constraints with respect to supported processors and ESXi server resource reservations. For more information, see [Virtual Machines Resource Provisioning Policy, on page 8](#). You must also adhere to specific configuration limits as described in [Table 19: Parameter Values for 36000 Agents, on page 26](#).

Add more agent PGs, Unified CVP nodes, and Cisco Finesse nodes to support 36000 agents as required. Add two Cisco Unified Communications Manager clusters to the deployment to support the additional 12000 agents, with no more than eight subscriber nodes and 8000 users per cluster.

Make the following changes to the Live Data and Cisco IdS OVA files to enable support for 36000 agents:

- Live Data OVA file: Increase the VM memory reservation from 46 to 68 GB. Increase the number of vCPUs from 12 to 18 and the vCPU MHz reservation from 24000 to 36000.
- Cisco IdS OVA file: Increase the number of vCPUs from 8 to 10.

For Unified Intelligence Center, two 6-node clusters are required to support the overall reporting load. Dedicate one Unified Intelligence Center cluster to support 1200 reporting users and Live Data reports for a maximum of 18000 agents. Dedicate the second cluster to handle Live Data reports for the remaining agents. Configure Cisco Finesse desktop layouts so that each of the 12 Unified Intelligence Center nodes (across the two clusters) serves Live Data reports for a maximum of 3000 agents.

Use the Config Limit CLI tool to modify the value of calls per second (CPS) for your deployment. You can then use the Configuration Manager tool to modify the values for the other parameters listed in the following table. For more details, see the *Change Limits for Calls Per Second to Support 36000 Agents* topic in the *Administration Guide for Cisco Unified Contact Center Enterprise* at <https://www.cisco.com/c/en/us/support/customer-collaboration/unified-contact-center-enterprise/products-maintenance-guides-list.html>.

**Table 19: Parameter Values for 36000 Agents**

Parameter	Value
<b>Agent Limits</b>	
Configured Agents	108000
Average Skills per Agent	5
Number of Agents in a Skill Group	Same limit as for 24000 Agents
Maximum Number of Agent PGs	24
<b>Supervisor and Reporting User Limits</b>	
Active Supervisors	3600 Cisco Finesse Supervisors No change to the number of reporting users
Configured Supervisors	10800
<b>Precision Queue and Skill Groups Limits</b>	
Skill Groups per System	No change to the number of skill groups per system
<b>System Load Limits</b>	
Maximum Inbound Calls per Second (CPS)	235
Congestion Control (CPS)	310

## Contact Director

Only Unified CCE supports the Contact Director reference design. The Contact Director distributes incoming calls to other contact center instances. The targets can be Unified CCE instances or Unified ICM instances that connect to third-party contact centers. The Contact Sharing feature uses a Contact Director to distribute incoming contacts to a maximum of 3 Unified CCE instances. The 3 instances can support a total of 24000 active agents.

Figure 10: Contact Director Solution with Two Unified CCE Target Instances

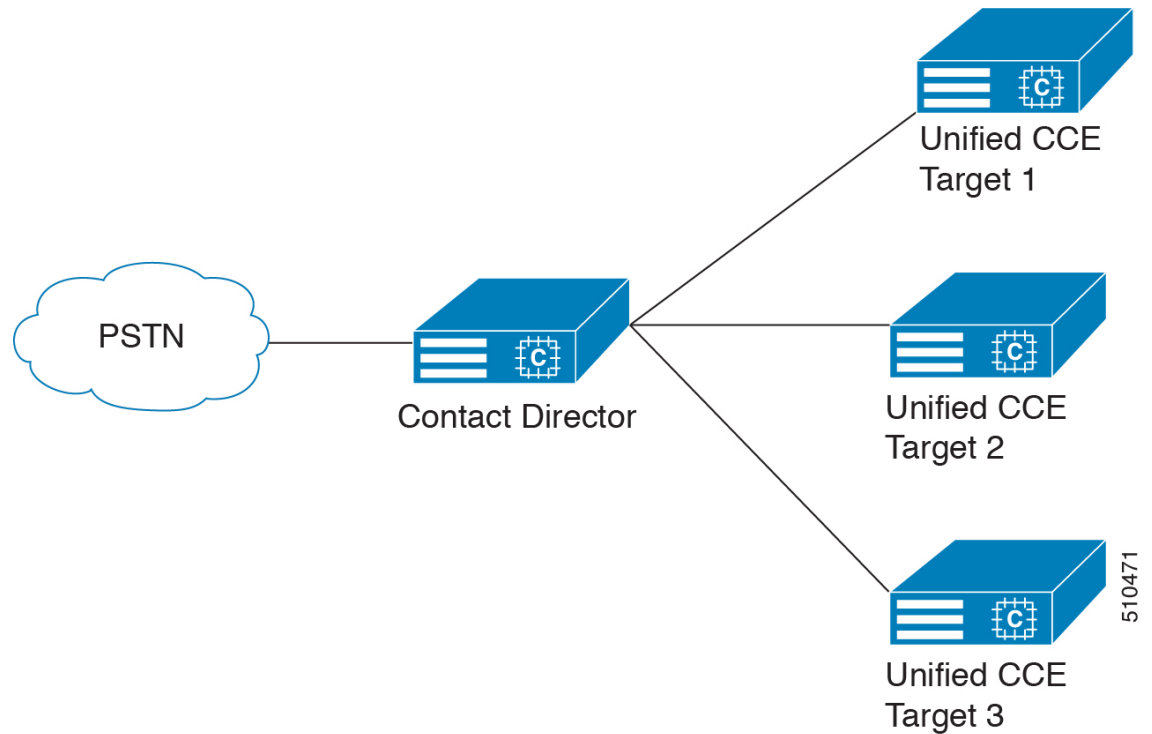

For information on the Contact Sharing feature, see the *Cisco Unified Contact Center Enterprise Features Guide* at <http://www.cisco.com/c/en/us/support/customer-collaboration/unified-contact-center-enterprise/products-feature-guides-list.html>.

## Topologies for Reference Designs

The Contact Center Enterprise Reference Designs also define the allowed topologies for your deployment. The deployment topology consists of where you install the VMs for your data center and how your agents connect to the data center. This figure shows the basic topologies that you can use in a Reference Design.

Figure 11: Reference Design Topologies

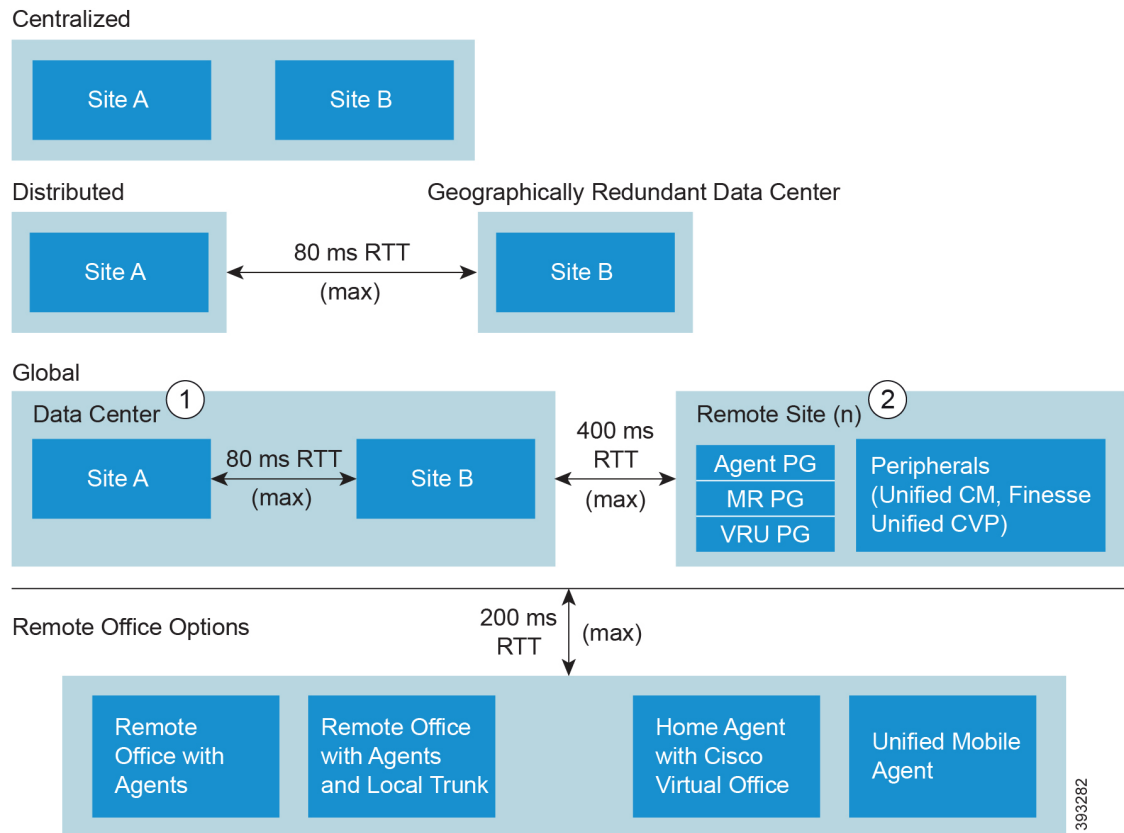

1. The Main Site can use either a Centralized or a Distributed topology.
2. A Remote Site can be geographically colocated with the Main Site.

The Reference Designs allow the following topologies:

Topology	Description
Centralized	You host both sites of the redundant components in the same physical data center. Even when they are on the same LAN, the maximum round-trip time between the two sites is 80 ms. The data center includes the core contact center components and Unified CM.
Distributed	You host each site of the redundant components in a different geographical location. Distributed sites allow you to keep running on the other site if one site fails. You can also handle routing without sending a contact to a site in a different geographical region. The maximum round-trip time between the two sites is 80 ms.

Topology	Description
Global	<p>You have a centralized or distributed main site. You also have a remote site that is generally in a different geographical location. The remote site gives you local access in that geographic region. The remote site allows you to handle your global work load without creating another contact center instance.</p> <p>The remote site requires a separate Unified CM cluster and a separate Cisco Finesse cluster if the RTT from the data center is greater than 80 ms. The maximum round-trip time between the main site and remote sites is 400 ms.</p> <p><b>Note</b> A remote site cannot include a Cisco Unified Intelligence Center server.</p> <p>This topology fits the outsourcer model where the outsourcer has a separate peripheral gateway and a corresponding peripheral.</p> <p><b>Note</b> Starting in Release 11.6, Packaged CCE supports this topology.</p>

The Reference Designs allow the following methods for connecting your agents to a site:

Remote Office Topology	Description
Remote Office with Agents	A contact center office with agent workstations that connects to a site through a WAN router. The voice termination is at the site. All contacts go through the site first and then to the agents.
Remote Office with Agents and Local Trunk	A contact center office with a connection to the local PSTN. Contacts come in on the local trunk and the local gateway passes them to the data center for routing.
Home Agent with Broadband - Cisco Virtual Office (CVO)	An agent at a remote location with a VPN connection to a site. The agent has a Cisco IP Phone and a Cisco Finesse desktop. The agent can optionally use a Cisco Virtual Office (CVO) router for a permanent VPN connection.
Unified Mobile Agent	An agent who uses a PSTN phone.



**Note** The maximum allowed round-trip time between any remote office and the data center is 200 ms.

**Related Topics**

- [Reference Design and Topology Design Considerations](#)
- [Topologies](#)

## Non-Reference Design Solutions

The Contact Center Enterprise Reference Designs define what you can use in your contact center solution. If your solution includes anything that the Reference Designs do not explicitly allow, your solution is a Non-Reference Design. Most Non-Reference Design solutions require Unified CCE.

Figure 12: Non-Reference Designs

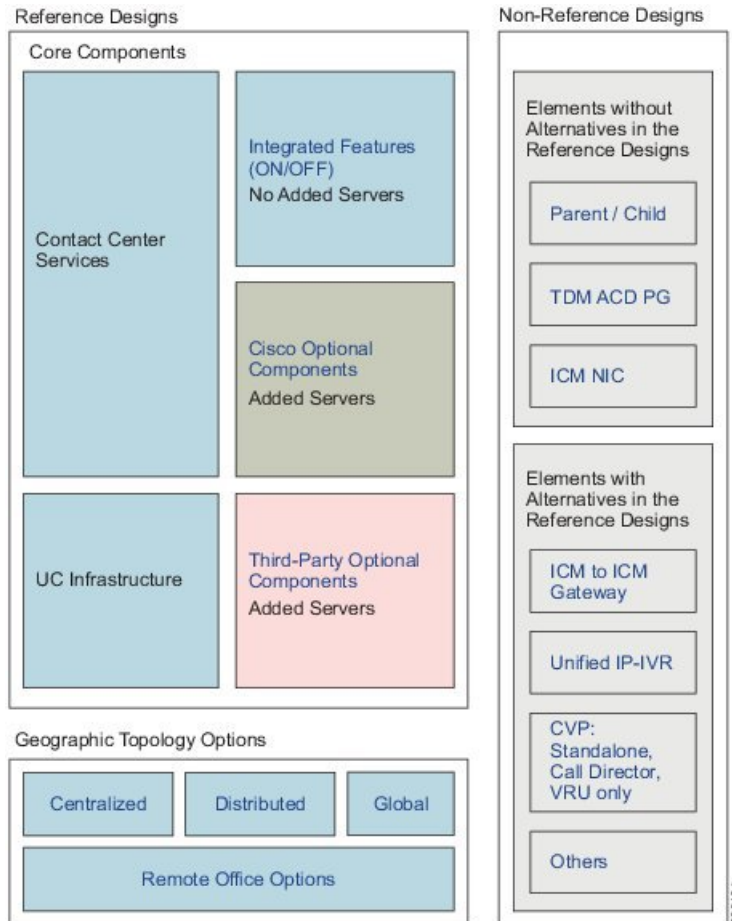

**Elements with Alternatives in the Reference Designs**

There are newer technologies that supersede most of the components, options, features, and configurations that are not supported in Reference Design solutions. Some of the elements in this category are:

Table 20: Non-Reference Designs and the Reference Design Alternatives

Non-Reference Design Element	Reference Design Alternative
Cisco ICM to ICM Gateway (Except in the Contact Director model)	Contact Director
Unified IP IVR or third-party Voice Response Unit (VRU) applications	Unified CVP
Mismatch versions in Unified CCE subcomponents (This is allowed only while upgrading your contact center from one release to another.)	All versions match after upgrade
Unified CVP Call Director	Unified CVP Comprehensive call flow

Non-Reference Design Element	Reference Design Alternative
Generic PG	Coresident Agent PG, VRU PG, and MR PG
Translation Route	Unified CVP Comprehensive call flow, except for third-party PGs
Multi-Unified CM PIM configuration	Multiple PGs on separate VMs
Unified CM Multi-cast Music on Hold (MoH)	Gateway-based MoH or Unicast MoH
Tomcat as the media server for Unified CVP	Prepackaged IIS included in the Unified CVP install
MGCP protocol	SIP
G.722, iSAC, and iLBC codecs	Mixed codec support
Dialed Number Plan (DNP)	Dialed Numbers and CTI Route Points



---

**Note** This is not an exhaustive list.

---

#### Elements Without Alternatives in the Reference Designs

There are some elements that you cannot use in Reference Design solutions that do not have a defined alternative. Some of the elements in this category are:

- Time-Division Multiplexing (TDM) (third-party legacy Automatic Call Distribution integration)
- TDM NIC
- Parent/Child topology for out-sourcing deployments



---

**Note** This is not an exhaustive list.

---

#### Related Topics

[Non-Reference Designs](#)

