



# Cisco Analog Telephone Adaptor Overview

This section describes the hardware and software features of the Cisco Analog Telephone Adaptor (Cisco ATA) and includes a brief overview of the Skinny Client Control Protocol (SCCP).

The Cisco ATA analog telephone adaptors are handset-to-Ethernet adaptors that allow regular analog telephones to operate on IP-based telephony networks. Cisco ATAs support two voice ports, each with an independent telephone number. The Cisco ATA 188 also has an RJ-45 10/100BASE-T data port.

This section covers the following topics:

- [Overview of the Skinny Client Control Protocol, page 1-2](#)
- [Hardware Overview, page 1-3](#)
- [Software Features, page 1-5](#)
- [Installation and Configuration Overview, page 1-9](#)

**Figure 1-1** Cisco ATA Analog Telephone Adaptor

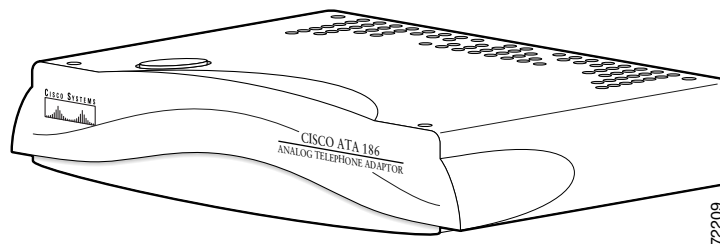

The Cisco ATA, which operates with Cisco voice-packet gateways, uses broadband pipes deployed through digital subscriber line (DSL), fixed wireless, cable modem, and other Ethernet connections.



**Note**

The term Cisco ATA refers to both the Cisco ATA 186 and the Cisco ATA 188, unless otherwise stated.

Figure 1-2 The Cisco ATA 186 as an Endpoint in an SCCP Network

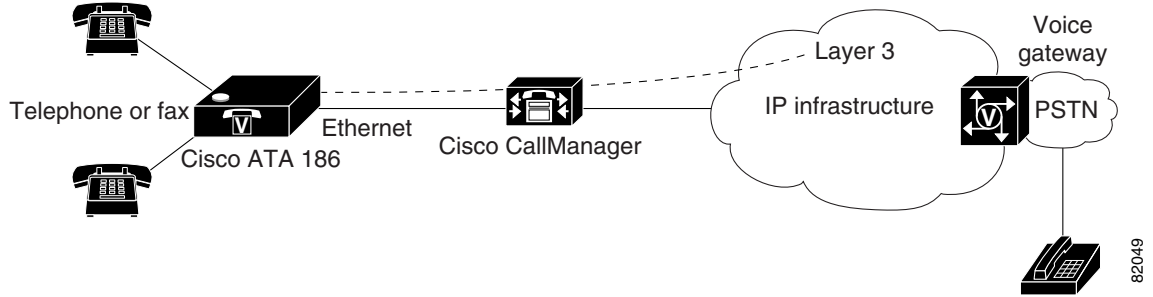
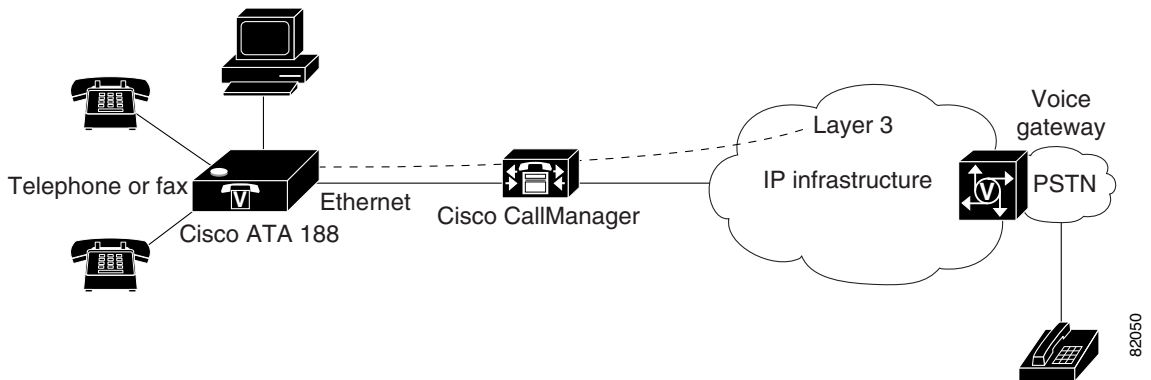

Figure 1-3 The Cisco ATA 188 as an Endpoint in an SCCP Network



## Overview of the Skinny Client Control Protocol

The Skinny Client Control Protocol (SCCP) is the Cisco standard for real-time calls and conferencing over Internet Protocol (IP). With SCCP, Cisco IP Phones can co-exist in an H.323 environment. When a Cisco CallManager is coupled with an H.323 Gatekeeper or an MGCP Call Agent, a Cisco ATA running SCCP interoperates with H.323 terminals on the far end to establish, control and clear audio calls.

Figure 1-4 illustrates the architecture of an SCCP network.

Figure 1-4 SCCP Architecture

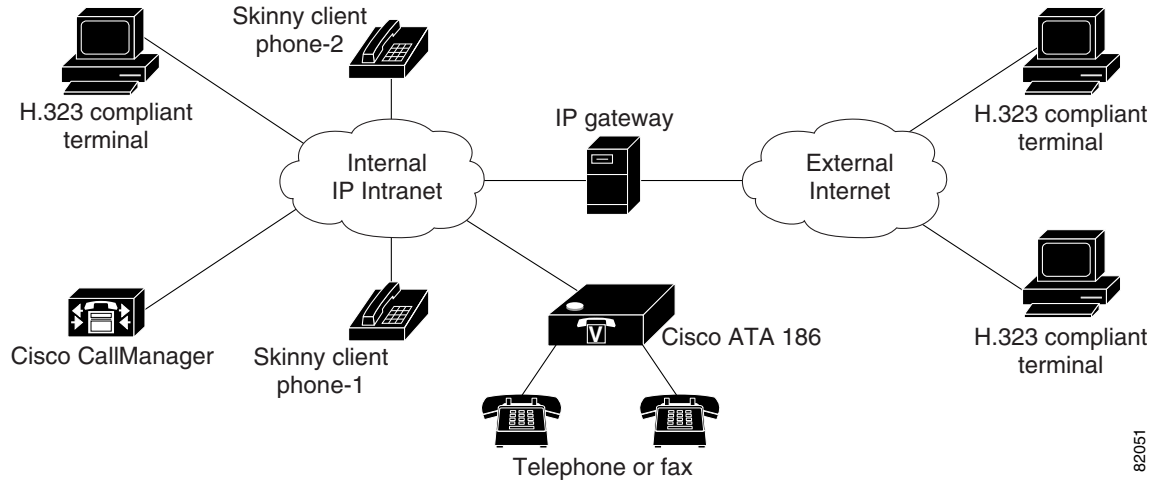

82051

# Hardware Overview

Cisco ATAs are compact, easy-to-install devices. Figure 1-5 shows the rear panel of the Cisco ATA 186. Figure 1-6 shows the rear panel of the Cisco ATA 188.

Figure 1-5 Cisco ATA 186—Rear View

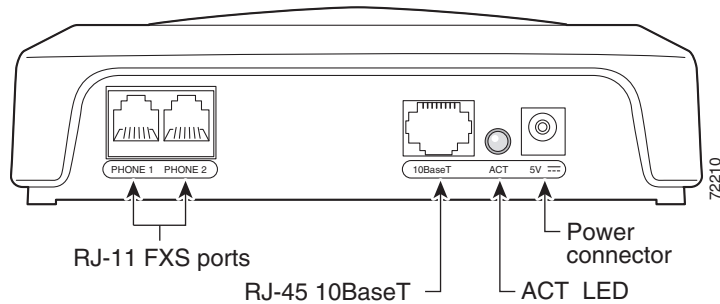
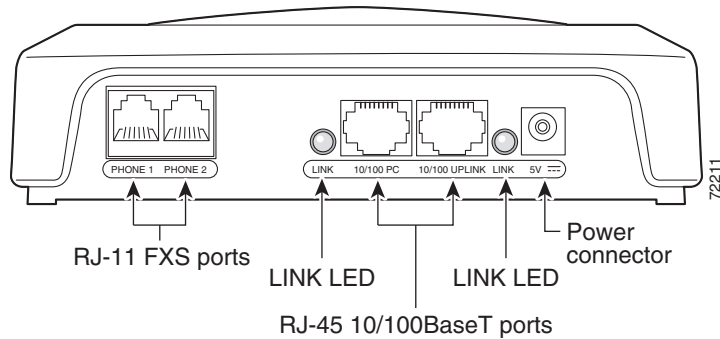

Figure 1-6 Cisco ATA 188—Rear View



The unit provides the following connectors and indicators:

- 5V power connector.
- Two RJ-11 FXS (Foreign Exchange Station) ports—The Cisco ATA supports two independent RJ-11 telephone ports that can connect to any standard analog telephone device. Each port supports either voice calls or fax sessions, and both ports can be used simultaneously.



---

**Note** The Cisco ATA186-I1 and Cisco ATA188-I1 provide 600-ohm resistive impedance. The Cisco ATA186-I2 and Cisco ATA188-I2 provide 270 ohm + 750 ohm // 150-nF complex impedance. The impedance option is requested when you place your order and should match your specific application. If you are not sure of the applicable configuration, check your country or regional telephone impedance requirements.

---

- Ethernet ports
  - The Cisco ATA 186 has one RJ-45 10BASE-T uplink Ethernet port to connect the Cisco ATA 186 to a 10/100BASE-T hub or another Ethernet device.
  - The Cisco ATA 188 has two Ethernet ports: an RJ-45 10/100BASE-T uplink port to connect the Cisco ATA 188 to a 10/100BASE-T hub or another Ethernet device and an RJ-45 10/100BASE-T data port to connect an Ethernet-capable device, such as a computer, to the network.





---

**Note** The Cisco ATA 188 performs auto-negotiation for duplexity and speed and is capable of 10/100 Mbps, full-duplex operation. The Cisco ATA 186 is fixed at 10 Mbps, half-duplex operation.

---

- The Cisco ATA 188 RJ-45 LED shows network link and activity. The LED blinks twice when the Cisco ATA is first powered on, then turns off if there is no link or activity. The LED blinks to show network activity and is solid when there is a link.
- The Cisco ATA 186 RJ-45 LED is solid when the Cisco ATA is powered on and blinks to show network activity.
- Function button—The function button is located on the top panel of the unit (see [Figure 1-7](#)).

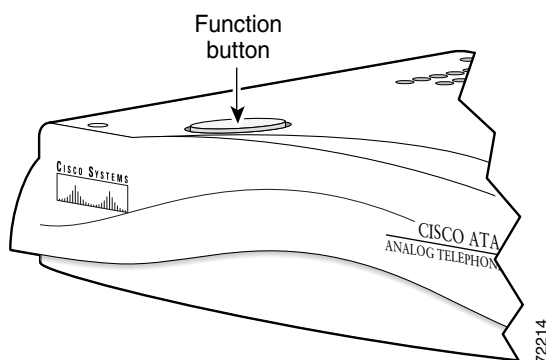
**Figure 1-7 Function Button**



The function button lights when you pick up the handset of a telephone attached to the Cisco ATA. The button blinks quickly when the Cisco ATA is upgrading its configuration.

**Note**

If the function button blinks slowly, the Cisco ATA cannot find the DHCP server. Check your Ethernet connections and make sure the DHCP server is available.

Pressing the function button allows you to access to the voice configuration menu. For additional information about the voice configuration menu, see the [“Voice Configuration Menu” section on page 3-18](#).

**Caution**

Never press the function button during an upgrade process. Doing so may interfere with the process and may permanently disable the Cisco ATA.

## Software Features

This section contains topics that cover the protocols and services that the Cisco ATA supports:

- [SCCP Version, page 1-5](#)
- [Voice Codecs Supported, page 1-5](#)
- [Additional Supported Signaling Protocols, page 1-6](#)
- [Other Supported Protocols, page 1-6](#)
- [Basic Services, page 1-6](#)
- [Fax Services, page 1-7](#)
- [Pre-call and Mid-call Services, page 1-7](#)

## SCCP Version

The Cisco ATA supports the Skinny Client Control Protocol (SCCP) Rev. 3.0 and 3.1.

## Voice Codecs Supported

The Cisco ATA supports the following voice codecs (check your other network devices for the codecs they support):

- G.711 $\mu$ -law
- G.711A-law
- G.723.1
- G.729
- G.729A
- G.729B
- G.729AB

When operating with a low-bit-rate codec, the Cisco ATA can support either two G.723.1 connections or one G.729 connection. The selection of G.723.1 or G.729 must be statically configured. When G.723.1 is the low-bit-rate codec, each FXS port is allocated with one G.723.1 connection. When G.729 is used, only one FXS port can use G.729. For more information, see the [“LBRCodec” section on page 5-11](#) and [“ConnectMode” section on page 5-13](#).

## Additional Supported Signaling Protocols

In addition to SCCP, the Cisco ATA supports the following signaling protocols:

- Media Gateway Control Protocol (MGCP)
- H.323
- Session Initiation Protocol (SIP)

SCCP and MGCP share the same software image. SIP and H.323 also share a software image, which is separate from the SCCP/MGCP image. If you wish to perform a cross-protocol upgrade from SCCP to another signaling image, see [Appendix E, “Performing a Cross-Protocol Upgrade.”](#)

## Other Supported Protocols

Other protocols that the Cisco ATA supports include the following:

- 802.1Q VLAN tagging
- Cisco Discovery Protocol (CDP)
- Domain Name System (DNS)
- Dynamic Host Configuration Protocol (DHCP)
- Internet Control Message Protocol (ICMP)
- Internet Protocol (IP)
- Real-Time Transport Protocol (RTP)
- Transmission Control Protocol (TCP)
- Trivial File Transfer Protocol (TFTP)
- User Datagram Protocol (UDP)

## Basic Services

For an alphabetical list of Cisco ATA basic services and the parameters for configuring each service, see [Table 3-5 on page 3-8](#).

These services include the following features:

- Configurable tone (dial tone, busy tone, confirm tone, reorder tone, call waiting tone)
- IP address assignment—DHCP-provided or statically configured
- Cisco ATA configuration by means of the Cisco CallManager TFTP server, web browser, or voice configuration menu.
- VLAN configuration
- Caller ID format

- Ring cadence format
- Silence suppression
- Low-bit-rate codec selection
- RTP media port configuration
- Hook-flash detection timing configuration
- Cisco Discovery Protocol (CDP)
- User interface password
- UDP Type of Service (ToS) configuration
- 802.1P Class of Service (Cos) Bit configuration
- Debugging and diagnostic tools

## Fax Services

The Cisco ATA supports two modes of fax services, in which fax signals are transmitted using the G.711 codec:

- Fax pass-through mode—Receiver-side Called Station Identification (CED) tone detection with automatic G.711A-law or G.711 $\mu$ -law switching.
- Fax mode—The Cisco ATA is configured as a G.711-only device.

How you set Cisco ATA fax parameters depends on what network gateways are being used. You may need to modify the default fax parameter values (see [Chapter 6, “Configuring and Debugging Fax Services”](#)).



---

**Note**

Success of fax transmission depends on network conditions and fax modem response to these conditions. The network must have reasonably low network jitter, network delay, and packet loss rate.

---

## Pre-call and Mid-call Services

This section provides an overview of telephone services that the Cisco ATA allows the user to perform either before or during a call. For end-user procedures on how to use these services, see [Appendix A, “How to Use Pre-call and Mid-call Services.”](#)

This section contains the following topics:

- [Pre-call Services, page 1-7](#)
- [Mid-call Services, page 1-8](#)



---

**Note**

The services listed in this section are supported by Cisco CallManager. For Cisco IOS Telephony Service (ITS)-supported services, refer to ITS documentation.

---

## Pre-call Services

[Table 1-1](#) lists the pre-call services that the Cisco ATA supports for the SCCP protocol. [Table 1-1](#) also includes references to where the user procedure is described for each service.

**Table 1-1 Pre-call Services and Where to Find End-user Procedures**

Service	Procedure Reference
Voice mail access	<a href="#">Access Voicemail, page A-1</a>
Forward all calls to another number	<a href="#">Activate Call-Forward-All, page A-2</a>
Cancel the forwarding of all calls	<a href="#">Cancel Call-Forward-All, page A-2</a>
Redial the most recent number dialed	<a href="#">Redial, page A-2</a>
Use speed dial	<a href="#">Speed Dial, page A-2</a>
Answer a call in your call-pickup group	<a href="#">Call Pickup, page A-3</a>
Answer a call outside of your call-pickup group	<a href="#">Group Call Pickup, page A-3</a>
Set up a conference	<a href="#">MeetMe Conference, page A-3</a>

## Mid-call Services

The method of initiating and using mid-call services for the SCCP protocol differs according to mode. The following three modes are available for invoking mid-call services:

- Bellcore Style (default)
- Cisco VG248 Style
- Cisco ATA Style

The mode can be configured using bits 28 and 29 of the ConnectMode parameter (see the “ConnectMode” section on page 5-13).

Table 1-2 lists the mid-call services that the Cisco ATA supports for each of the three modes. Table 1-2 also includes references to where the end-user procedure is described for each service.

**Table 1-2 Mid-call Services and Where to Find End-user Procedures**

Style and Related Services	Procedure Reference
Bellcore style (default) services: <ul style="list-style-type: none"> <li>• Call transfer</li> <li>• Conference call</li> </ul>	<a href="#">Bellcore Style, page A-4</a>
Cisco VG248 style services: <ul style="list-style-type: none"> <li>• Three-way call</li> <li>• Call transfer</li> <li>• Conference call</li> </ul>	<a href="#">Cisco VG248 Style, page A-5</a>
Cisco ATA style services: <ul style="list-style-type: none"> <li>• Call hold/resume</li> <li>• Call transfer</li> <li>• Conference call</li> </ul>	<a href="#">Cisco ATA Style, page A-6</a>



# Installation and Configuration Overview

Table 1-3 provides the basic steps required to install and configure the Cisco ATA to make it operational in a typical Cisco CallManager environment.

**Table 1-3 Overview of the Steps Required to Install and Configure the Cisco ATA and Make it Operational**

Action	Reference
1. Plan the network and Cisco ATA configuration.	
2. Install the Ethernet connection.	
3. Install and configure the other network devices.	
4. Install the Cisco ATA but do not power up the Cisco ATA yet.	<a href="#">What the Cisco ATA Package Includes, page 2-2</a>
<b>Note</b> If you power up the Cisco ATA before adding the Cisco ATA to the Cisco CallManager, you will need to perform a reset once you have added the Cisco ATA to the Cisco CallManager.	<a href="#">Resetting the Cisco ATA Using Cisco CallManager, page 3-23</a>
5. Download the desired Cisco ATA release software zip file from the Cisco web site, then configure the Cisco ATA.	<a href="#">Chapter 3, “Configuring the Cisco ATA for SCCP”</a>
6. Add the Cisco ATA to the Cisco CallManager.	<a href="#">Chapter 4, “Adding the Cisco ATA to the Cisco CallManager”</a>
7. Power up the Cisco ATA.	
8. Periodically, you can upgrade an individual Cisco ATA or all Cisco ATAs to a new signaling image by using the Cisco CallManager administration web pages.	<a href="#">Chapter 7, “Upgrading the Cisco ATA Signaling Image”</a>

