



Configuring Multiple Spanning-Tree Protocol

- [Finding Feature Information, on page 1](#)
- [Prerequisites for MSTP, on page 1](#)
- [Restrictions for MSTP, on page 2](#)
- [Information About MSTP, on page 3](#)
- [How to Configure MSTP Features, on page 19](#)
- [Examples, on page 38](#)
- [Monitoring MST Configuration and Status, on page 42](#)
- [Feature Information for MSTP, on page 43](#)

Finding Feature Information

Your software release may not support all the features documented in this module. For the latest caveats and feature information, see Bug Search Tool and the release notes for your platform and software release. To find information about the features documented in this module, and to see a list of the releases in which each feature is supported, see the feature information table at the end of this module.

Use Cisco Feature Navigator to find information about platform support and Cisco software image support. To access Cisco Feature Navigator, go to <https://cfng.cisco.com/>. An account on Cisco.com is not required.

Prerequisites for MSTP

- For two or more devices to be in the same multiple spanning tree (MST) region, they must have the same VLAN-to-instance map, the same configuration revision number, and the same name.
- For load-balancing across redundant paths in the network to work, all VLAN-to-instance mapping assignments must match; otherwise, all traffic flows on a single link.
- For load-balancing between a per-VLAN spanning tree plus (PVST+) and an MST cloud or between a rapid-PVST+ and an MST cloud to work, all MST boundary ports must be forwarding. MST boundary ports are forwarding when the root of the internal spanning tree (IST) of the MST cloud is the root of the common spanning tree (CST). If the MST cloud consists of multiple MST regions, one of the MST regions must contain the CST root, and all of the other MST regions must have a better path to the root contained within the MST cloud than a path through the PVST+ or rapid-PVST+ cloud. You might have to manually configure the devices in the clouds.

Related Topics

- [Specifying the MST Region Configuration and Enabling MSTP](#) , on page 19
- [MSTP Configuration Guidelines](#), on page 3
- [Multiple Spanning-Tree Regions](#), on page 4

Restrictions for MSTP

- The device stack supports up to 65 MST instances. The number of VLANs that can be mapped to a particular MST instance is unlimited.
- PVST+, Rapid PVST+, and MSTP are supported, but only one version can be active at any time. (For example, all VLANs run PVST+, all VLANs run Rapid PVST+, or all VLANs run MSTP.)
- VLAN Trunking Protocol (VTP) propagation of the MST configuration is not supported. However, you can manually configure the MST configuration (region name, revision number, and VLAN-to-instance mapping) on each device within the MST region by using the command-line interface (CLI) or through the Simple Network Management Protocol (SNMP) support.
- Partitioning the network into a large number of regions is not recommended. However, if this situation is unavoidable, we recommend that you partition the switched LAN into smaller LANs interconnected by routers or non-Layer 2 devices.
- A region can have one member or multiple members with the same MST configuration; each member must be capable of processing rapid spanning tree protocol (RSTP) Bridge Protocol Data Units (BPDUs). There is no limit to the number of MST regions in a network, but each region can only support up to 65 spanning-tree instances. You can assign a VLAN to only one spanning-tree instance at a time.
- After configuring a device as the root device, we recommend that you avoid manually configuring the hello time, forward-delay time, and maximum-age time through the **spanning-tree mst hello-time**, **spanning-tree mst forward-time**, and the **spanning-tree mst max-age** global configuration commands.

Table 1: PVST+, MSTP, and Rapid PVST+ Interoperability and Compatibility

	PVST+	MSTP	Rapid PVST+
PVST+	Yes	Yes (with restrictions)	Yes (reverts to PVST+)
MSTP	Yes (with restrictions)	Yes	Yes (reverts to PVST+)
Rapid PVST+	Yes (reverts to PVST+)	Yes (reverts to PVST+)	Yes

Related Topics

- [Specifying the MST Region Configuration and Enabling MSTP](#) , on page 19
- [MSTP Configuration Guidelines](#), on page 3
- [Multiple Spanning-Tree Regions](#), on page 4
- [Configuring the Root Device](#) , on page 22
- [Root Switch](#), on page 4

Information About MSTP

MSTP Configuration

MSTP, which uses RSTP for rapid convergence, enables multiple VLANs to be grouped into and mapped to the same spanning-tree instance, reducing the number of spanning-tree instances needed to support a large number of VLANs. The MSTP provides for multiple forwarding paths for data traffic, enables load balancing, and reduces the number of spanning-tree instances required to support a large number of VLANs. It improves the fault tolerance of the network because a failure in one instance (forwarding path) does not affect other instances (forwarding paths).



Note The multiple spanning-tree (MST) implementation is based on the IEEE 802.1s standard.

The most common initial deployment of MSTP is in the backbone and distribution layers of a Layer 2 switched network. This deployment provides the highly available network required in a service-provider environment.

When the device is in the MST mode, the RSTP, which is based on IEEE 802.1w, is automatically enabled. The RSTP provides rapid convergence of the spanning tree through explicit handshaking that eliminates the IEEE 802.1D forwarding delay and quickly transitions root ports and designated ports to the forwarding state.

Both MSTP and RSTP improve the spanning-tree operation and maintain backward compatibility with equipment that is based on the (original) IEEE 802.1D spanning tree, with existing Cisco-proprietary Multiple Instance STP (MISTP), and with existing Cisco PVST+ and rapid per-VLAN spanning-tree plus (Rapid PVST+).

MSTP Configuration Guidelines

- When you enable MST by using the **spanning-tree mode mst** global configuration command, RSTP is automatically enabled.
- For configuration guidelines about UplinkFast, BackboneFast, and cross-stack UplinkFast, see the relevant sections in the Related Topics section.
- When the device is in MST mode, it uses the long path-cost calculation method (32 bits) to compute the path cost values. With the long path-cost calculation method, the following path cost values are supported:

Speed	Path Cost Value
10 Mb/s	2,000,000
100 Mb/s	200,000
1 Gb/s	20,000
10 Gb/s	2,000
100 Gb/s	200

Related Topics

[Specifying the MST Region Configuration and Enabling MSTP](#) , on page 19

[Prerequisites for MSTP](#) , on page 1

[Restrictions for MSTP](#) , on page 2

[Spanning-Tree Interoperability and Backward Compatibility](#)

[Optional Spanning-Tree Configuration Guidelines](#)

[BackboneFast](#)

[UplinkFast](#)

Root Switch

The device maintains a spanning-tree instance for the group of VLANs mapped to it. A device ID, consisting of the device priority and the device MAC address, is associated with each instance. For a group of VLANs, the device with the lowest device ID becomes the root device.

When you configure a device as the root, you modify the device priority from the default value (32768) to a significantly lower value so that the device becomes the root device for the specified spanning-tree instance. When you enter this command, the device checks the device priorities of the root devices. Because of the extended system ID support, the device sets its own priority for the specified instance to 24576 if this value will cause this devices to become the root for the specified spanning-tree instance.

If any root device for the specified instance has a device priority lower than 24576, the device sets its own priority to 4096 less than the lowest device priority. (4096 is the value of the least-significant bit of a 4-bit device priority value. For more information, select "Bridge ID, Device Priority, and Extended System ID" link in Related Topics.

If your network consists of devices that support and do not support the extended system ID, it is unlikely that the device with the extended system ID support will become the root device. The extended system ID increases the device priority value every time the VLAN number is greater than the priority of the connected switches running older software.

The root device for each spanning-tree instance should be a backbone or distribution device. Do not configure an access device as the spanning-tree primary root.

Use the **diameter** keyword, which is available only for MST instance 0, to specify the Layer 2 network diameter (that is, the maximum number of device hops between any two end stations in the Layer 2 network). When you specify the network diameter, the device automatically sets an optimal hello time, forward-delay time, and maximum-age time for a network of that diameter, which can significantly reduce the convergence time. You can use the **hello** keyword to override the automatically calculated hello time.

Related Topics

[Configuring the Root Device](#) , on page 22

[Restrictions for MSTP](#) , on page 2

[Bridge ID, Device Priority, and Extended System ID](#)

Multiple Spanning-Tree Regions

For switches to participate in multiple spanning-tree (MST) instances, you must consistently configure the switches with the same MST configuration information. A collection of interconnected switches that have the same MST configuration comprises an MST region.

The MST configuration controls to which MST region each device belongs. The configuration includes the name of the region, the revision number, and the MST VLAN-to-instance assignment map. You configure the device for a region by specifying the MST region configuration on it. You can map VLANs to an MST instance, specify the region name, and set the revision number. For instructions and an example, select the "Specifying the MST Region Configuration and Enabling MSTP" link in Related Topics.

A region can have one or multiple members with the same MST configuration. Each member must be capable of processing RSTP bridge protocol data units (BPDUs). There is no limit to the number of MST regions in a network, but each region can support up to 65 spanning-tree instances. Instances can be identified by any number in the range from 0 to 4094. You can assign a VLAN to only one spanning-tree instance at a time.

Related Topics

[Illustration of MST Regions](#), on page 7

[Specifying the MST Region Configuration and Enabling MSTP](#), on page 19

[Prerequisites for MSTP](#), on page 1

[Restrictions for MSTP](#), on page 2

[Spanning-Tree Interoperability and Backward Compatibility](#)

[Optional Spanning-Tree Configuration Guidelines](#)

[BackboneFast](#)

[UplinkFast](#)

IST, CIST, and CST

Unlike PVST+ and Rapid PVST+ in which all the spanning-tree instances are independent, the MSTP establishes and maintains two types of spanning trees:

- An internal spanning tree (IST), which is the spanning tree that runs in an MST region.

Within each MST region, the MSTP maintains multiple spanning-tree instances. Instance 0 is a special instance for a region, known as the internal spanning tree (IST). All other MST instances are numbered from 1 to 4094.

The IST is the only spanning-tree instance that sends and receives BPDUs. All of the other spanning-tree instance information is contained in M-records, which are encapsulated within MSTP BPDUs. Because the MSTP BPDU carries information for all instances, the number of BPDUs that need to be processed to support multiple spanning-tree instances is significantly reduced.

All MST instances within the same region share the same protocol timers, but each MST instance has its own topology parameters, such as root device ID, root path cost, and so forth. By default, all VLANs are assigned to the IST.

An MST instance is local to the region; for example, MST instance 1 in region A is independent of MST instance 1 in region B, even if regions A and B are interconnected.

- A common and internal spanning tree (CIST), which is a collection of the ISTs in each MST region, and the common spanning tree (CST) that interconnects the MST regions and single spanning trees.

The spanning tree computed in a region appears as a subtree in the CST that encompasses the entire switched domain. The CIST is formed by the spanning-tree algorithm running among switches that support the IEEE 802.1w, IEEE 802.1s, and IEEE 802.1D standards. The CIST inside an MST region is the same as the CST outside a region.

Operations Within an MST Region

The IST connects all the MSTP switches in a region. When the IST converges, the root of the IST becomes the CIST regional root. It is the device within the region with the lowest device ID and path cost to the CIST root. The CIST regional root is also the CIST root if there is only one region in the network. If the CIST root is outside the region, one of the MSTP switches at the boundary of the region is selected as the CIST regional root.

When an MSTP device initializes, it sends BPDUs claiming itself as the root of the CIST and the CIST regional root, with both of the path costs to the CIST root and to the CIST regional root set to zero. The device also initializes all of its MST instances and claims to be the root for all of them. If the device receives superior MST root information (lower device ID, lower path cost, and so forth) than currently stored for the port, it relinquishes its claim as the CIST regional root.

During initialization, a region might have many subregions, each with its own CIST regional root. As switches receive superior IST information, they leave their old subregions and join the new subregion that contains the true CIST regional root. All subregions shrink except for the one that contains the true CIST regional root.

For correct operation, all switches in the MST region must agree on the same CIST regional root. Therefore, any two switches in the region only synchronize their port roles for an MST instance if they converge to a common CIST regional root.

Related Topics

[Illustration of MST Regions](#), on page 7

Operations Between MST Regions

If there are multiple regions or legacy IEEE 802.1D devices within the network, MSTP establishes and maintains the CST, which includes all MST regions and all legacy STP devices in the network. The MST instances combine with the IST at the boundary of the region to become the CST.

The IST connects all the MSTP devices in the region and appears as a subtree in the CIST that encompasses the entire switched domain. The root of the subtree is the CIST regional root. The MST region appears as a virtual device to adjacent STP devices and MST regions.

Only the CST instance sends and receives BPDUs, and MST instances add their spanning-tree information into the BPDUs to interact with neighboring devices and compute the final spanning-tree topology. Because of this, the spanning-tree parameters related to BPDU transmission (for example, hello time, forward time, max-age, and max-hops) are configured only on the CST instance but affect all MST instances. Parameters related to the spanning-tree topology (for example, device priority, port VLAN cost, and port VLAN priority) can be configured on both the CST instance and the MST instance.

MSTP devices use Version 3 RSTP BPDUs or IEEE 802.1D STP BPDUs to communicate with legacy IEEE 802.1D devices. MSTP devices use MSTP BPDUs to communicate with MSTP devices.

Related Topics

[Illustration of MST Regions](#), on page 7

IEEE 802.1s Terminology

Some MST naming conventions used in Cisco's prestandard implementation have been changed to identify some *internal* or *regional* parameters. These parameters are significant only within an MST region, as opposed to external parameters that are relevant to the whole network. Because the CIST is the only spanning-tree instance that spans the whole network, only the CIST parameters require the external rather than the internal or regional qualifiers.

- The CIST root is the root device for the unique instance that spans the whole network, the CIST.
- The CIST external root path cost is the cost to the CIST root. This cost is left unchanged within an MST region. Remember that an MST region looks like a single device for the CIST. The CIST external root path cost is the root path cost calculated between these virtual devices and devices that do not belong to any region.
- If the CIST root is in the region, the CIST regional root is the CIST root. Otherwise, the CIST regional root is the closest device to the CIST root in the region. The CIST regional root acts as a root device for the IST.
- The CIST internal root path cost is the cost to the CIST regional root in a region. This cost is only relevant to the IST, instance 0.

Illustration of MST Regions

This figure displays three MST regions and a legacy IEEE 802.1D device (D). The CIST regional root for region 1 (A) is also the CIST root. The CIST regional root for region 2 (B) and the CIST regional root for region 3 (C) are the roots for their respective subtrees within the CIST. The RSTP runs in all regions.

Figure 1: MST Regions, CIST Regional Root, and CIST Root

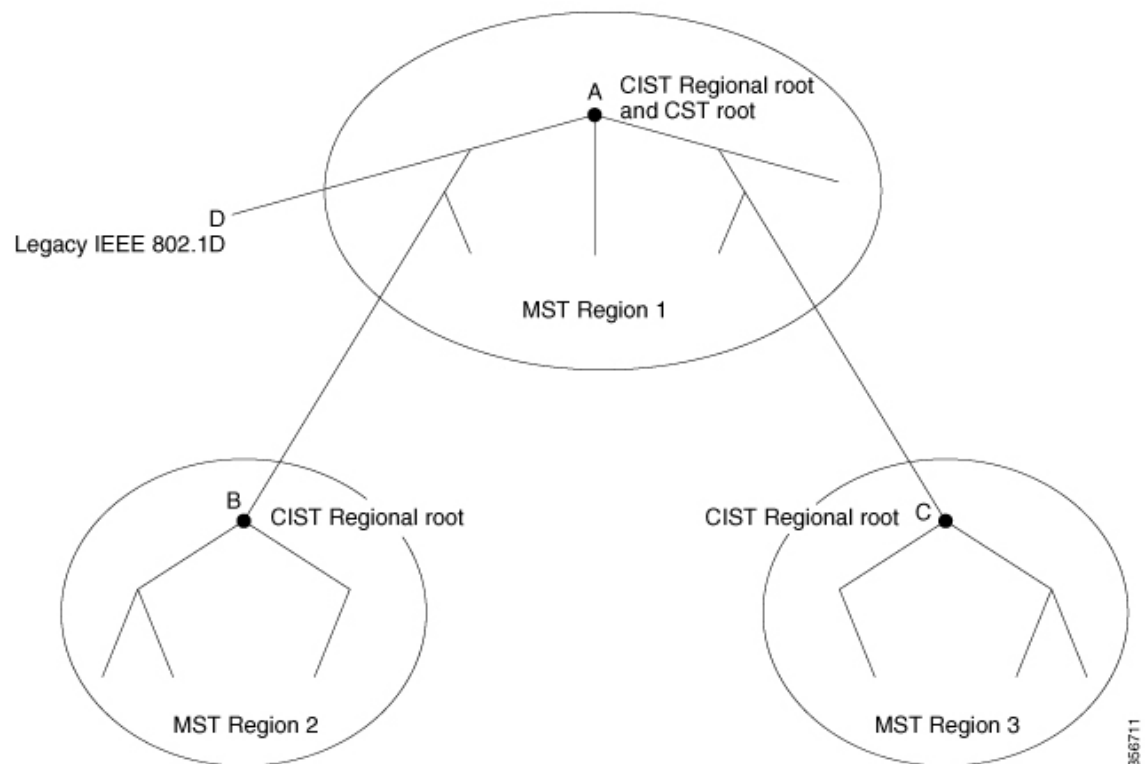

Related Topics

[Multiple Spanning-Tree Regions](#), on page 4

[Operations Within an MST Region](#), on page 6

[Operations Between MST Regions](#), on page 6

Hop Count

The IST and MST instances do not use the message-age and maximum-age information in the configuration BPDU to compute the spanning-tree topology. Instead, they use the path cost to the root and a hop-count mechanism similar to the IP time-to-live (TTL) mechanism.

By using the **spanning-tree mst max-hops** global configuration command, you can configure the maximum hops inside the region and apply it to the IST and all MST instances in that region. The hop count achieves the same result as the message-age information (triggers a reconfiguration). The root device of the instance always sends a BPDU (or M-record) with a cost of 0 and the hop count set to the maximum value. When a device receives this BPDU, it decrements the received remaining hop count by one and propagates this value as the remaining hop count in the BPDUs it generates. When the count reaches zero, the device discards the BPDU and ages the information held for the port.

The message-age and maximum-age information in the RSTP portion of the BPDU remain the same throughout the region, and the same values are propagated by the region designated ports at the boundary.

Boundary Ports

In the Cisco prestandard implementation, a boundary port connects an MST region to a single spanning-tree region running RSTP, to a single spanning-tree region running PVST+ or rapid PVST+, or to another MST region with a different MST configuration. A boundary port also connects to a LAN, the designated device of which is either a single spanning-tree device or a device with a different MST configuration.

There is no definition of a boundary port in the IEEE 802.1s standard. The IEEE 802.1Q-2002 standard identifies two kinds of messages that a port can receive:

- internal (coming from the same region)
- external (coming from another region)

When a message is internal, the CIST part is received by the CIST, and each MST instance receives its respective M-record.

When a message is external, it is received only by the CIST. If the CIST role is root or alternate, or if the external BPDU is a topology change, it could have an impact on the MST instances.

An MST region includes both devices and LANs. A segment belongs to the region of its designated port. Therefore, a port in a different region than the designated port for a segment is a boundary port. This definition allows two ports internal to a region to share a segment with a port belonging to a different region, creating the possibility of a port receiving both internal and external messages.

The primary change from the Cisco prestandard implementation is that a designated port is not defined as boundary, unless it is running in an STP-compatible mode.



Note If there is a legacy STP device on the segment, messages are always considered external.

The other change from the Cisco prestandard implementation is that the CIST regional root device ID field is now inserted where an RSTP or legacy IEEE 802.1Q device has the sender device ID. The whole region performs like a single virtual device by sending a consistent sender device ID to neighboring devices. In this example, device C would receive a BPDU with the same consistent sender device ID of root, whether or not A or B is designated for the segment.

IEEE 802.1s Implementation

The Cisco implementation of the IEEE MST standard includes features required to meet the standard, as well as some of the desirable prestandard functionality that is not yet incorporated into the published standard.

Port Role Naming Change

The boundary role is no longer in the final MST standard, but this boundary concept is maintained in Cisco's implementation. However, an MST instance port at a boundary of the region might not follow the state of the corresponding CIST port. Two boundary roles currently exist:

- The boundary port is the root port of the CIST regional root—When the CIST instance port is proposed and is in sync, it can send back an agreement and move to the forwarding state only after all the corresponding MSTI ports are in sync (and thus forwarding). The MSTI ports now have a special *primary* role.
- The boundary port is not the root port of the CIST regional root—The MSTI ports follow the state and role of the CIST port. The standard provides less information, and it might be difficult to understand why an MSTI port can be alternately blocking when it receives no BPDUs (MRecords). In this case, although the boundary role no longer exists, the **show** commands identify a port as boundary in the *type* column of the output.

Interoperation Between Legacy and Standard Devices

Because automatic detection of prestandard devices can fail, you can use an interface configuration command to identify prestandard ports. A region cannot be formed between a standard and a prestandard device, but they can interoperate by using the CIST. Only the capability of load-balancing over different instances is lost in that particular case. The CLI displays different flags depending on the port configuration when a port receives prestandard BPDUs. A syslog message also appears the first time a device receives a prestandard BPDU on a port that has not been configured for prestandard BPDU transmission.

Figure 2: Standard and Prestandard Device Interoperation

Assume that A is a standard device and B a prestandard device, both configured to be in the same region. A is the root device for the CIST, and B has a root port (BX) on segment X and an alternate port (BY) on segment Y. If segment Y flaps, and the port on BY becomes the alternate before sending out a single prestandard BPDU, AY cannot detect that a prestandard device is connected to Y and continues to send standard BPDUs. The port BY is fixed in a boundary, and no load balancing is possible between A and B. The same problem exists on segment X, but B might transmit topology

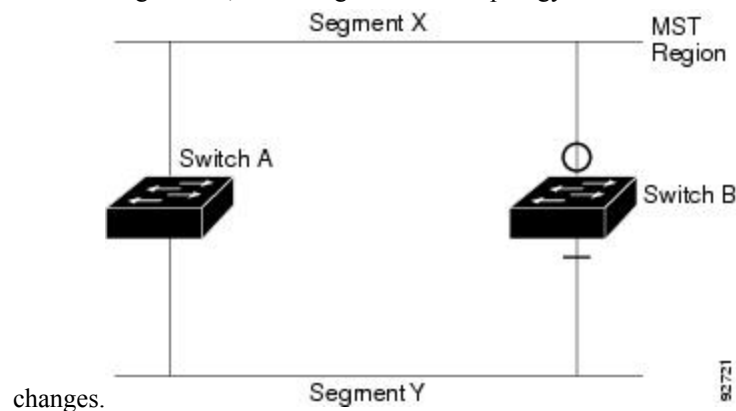



Note We recommend that you minimize the interaction between standard and prestandard MST implementations.

Detecting Unidirectional Link Failure

This feature is not yet present in the IEEE MST standard, but it is included in this Cisco IOS release. The software checks the consistency of the port role and state in the received BPDUs to detect unidirectional link failures that could cause bridging loops.

When a designated port detects a conflict, it keeps its role, but reverts to the discarding state because disrupting connectivity in case of inconsistency is preferable to opening a bridging loop.

Figure 3: Detecting Unidirectional Link Failure

This figure illustrates a unidirectional link failure that typically creates a bridging loop. Device A is the root device, and its BPDUs are lost on the link leading to device B. RSTP and MST BPDUs include the role and state of the sending port. With this information, device A can detect that device B does not react to the superior BPDUs it sends and that device B is the designated, not root device. As a result, device A blocks (or keeps

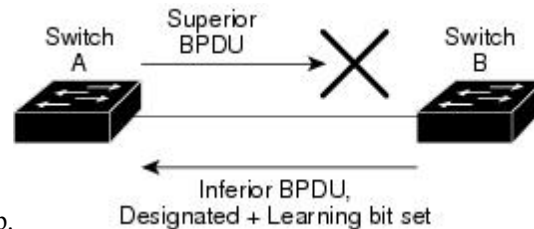

blocking) its port, which prevents the bridging loop.

Interoperability with IEEE 802.1D STP

A device running MSTP supports a built-in protocol migration mechanism that enables it to interoperate with legacy IEEE 802.1D devices. If this device receives a legacy IEEE 802.1D configuration BPDU (a BPDU with the protocol version set to 0), it sends only IEEE 802.1D BPDUs on that port. An MSTP device also can detect that a port is at the boundary of a region when it receives a legacy BPDU, an MSTP BPDU (Version 3) associated with a different region, or an RSTP BPDU (Version 2).

However, the device does not automatically revert to the MSTP mode if it no longer receives IEEE 802.1D BPDUs because it cannot detect whether the legacy device has been removed from the link unless the legacy device is the designated device. A device might also continue to assign a boundary role to a port when the device to which this device is connected has joined the region. To restart the protocol migration process (force the renegotiation with neighboring devices), use the **clear spanning-tree detected-protocols** privileged EXEC command.

If all the legacy devices on the link are RSTP devices, they can process MSTP BPDUs as if they are RSTP BPDUs. Therefore, MSTP devices send either a Version 0 configuration and TCN BPDUs or Version 3 MSTP BPDUs on a boundary port. A boundary port connects to a LAN, the designated device of which is either a single spanning-tree device or a device with a different MST configuration.

RSTP Overview

The RSTP takes advantage of point-to-point wiring and provides rapid convergence of the spanning tree. Reconfiguration of the spanning tree can occur in less than 1 second (in contrast to 50 seconds with the default settings in the IEEE 802.1D spanning tree).

Port Roles and the Active Topology

The RSTP provides rapid convergence of the spanning tree by assigning port roles and by learning the active topology. The RSTP builds upon the IEEE 802.1D STP to select the device with the highest device priority (lowest numerical priority value) as the root device. The RSTP then assigns one of these port roles to individual ports:

- Root port—Provides the best path (lowest cost) when the device forwards packets to the root device.
- Designated port—Connects to the designated device, which incurs the lowest path cost when forwarding packets from that LAN to the root device. The port through which the designated device is attached to the LAN is called the designated port.
- Alternate port—Offers an alternate path toward the root device to that provided by the current root port.
- Backup port—Acts as a backup for the path provided by a designated port toward the leaves of the spanning tree. A backup port can exist only when two ports are connected in a loopback by a point-to-point link or when a device has two or more connections to a shared LAN segment.
- Disabled port—Has no role within the operation of the spanning tree.

A port with the root or a designated port role is included in the active topology. A port with the alternate or backup port role is excluded from the active topology.

In a stable topology with consistent port roles throughout the network, the RSTP ensures that every root port and designated port immediately transition to the forwarding state while all alternate and backup ports are always in the discarding state (equivalent to blocking in IEEE 802.1D). The port state controls the operation of the forwarding and learning processes.

Table 2: Port State Comparison

Operational Status	STP Port State (IEEE 802.1D)	RSTP Port State	Is Port Included in the Active Topology?
Enabled	Blocking	Discarding	No
Enabled	Listening	Discarding	No
Enabled	Learning	Learning	Yes
Enabled	Forwarding	Forwarding	Yes
Disabled	Disabled	Discarding	No

To be consistent with Cisco STP implementations, this guide defines the port state as *blocking* instead of *discarding*. Designated ports start in the listening state.

Rapid Convergence

The RSTP provides for rapid recovery of connectivity following the failure of a device, a device port, or a LAN. It provides rapid convergence for edge ports, new root ports, and ports connected through point-to-point links as follows:

- **Edge ports**—If you configure a port as an edge port on an RSTP device by using the **spanning-tree portfast** interface configuration command, the edge port immediately transitions to the forwarding state. An edge port is the same as a Port Fast-enabled port, and you should enable it only on ports that connect to a single end station.
- **Root ports**—If the RSTP selects a new root port, it blocks the old root port and immediately transitions the new root port to the forwarding state.
- **Point-to-point links**—If you connect a port to another port through a point-to-point link and the local port becomes a designated port, it negotiates a rapid transition with the other port by using the proposal-agreement handshake to ensure a loop-free topology.

Figure 4: Proposal and Agreement Handshaking for Rapid Convergence

Device A is connected to Device B through a point-to-point link, and all of the ports are in the blocking state. Assume that the priority of Device A is a smaller numerical value than the priority of Device B. Device A sends a proposal message (a configuration BPDU with the proposal flag set) to Device B, proposing itself as the designated device.

After receiving the proposal message, Device B selects as its new root port the port from which the proposal message was received, forces all nonedge ports to the blocking state, and sends an agreement message (a BPDU with the agreement flag set) through its new root port.

After receiving Device B's agreement message, Device A also immediately transitions its designated port to the forwarding state. No loops in the network are formed because Device B blocked all of its nonedge ports and because there is a point-to-point link between Devices A and B.

When Device C is connected to Device B, a similar set of handshaking messages are exchanged. Device C selects the port connected to Device B as its root port, and both ends immediately transition to the forwarding state. With each iteration of this handshaking process, one more device joins the active topology. As the network converges, this proposal-agreement handshaking progresses from the root toward the leaves of the spanning tree.

The device learns the link type from the port duplex mode: a full-duplex port is considered to have a point-to-point connection; a half-duplex port is considered to have a shared connection. You can override the default setting that is controlled by the duplex setting by using the **spanning-tree link-type** interface configuration command.

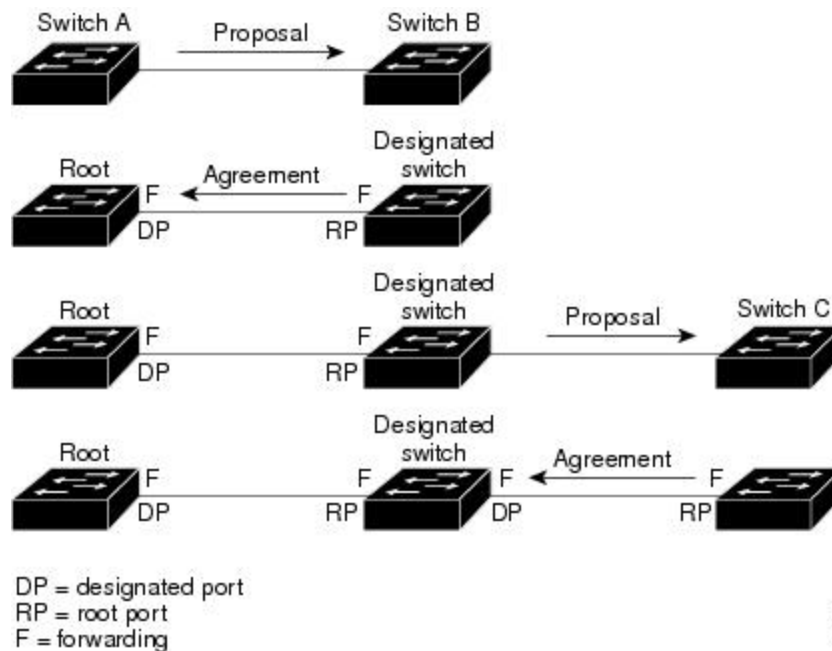

88790

Synchronization of Port Roles

When the device receives a proposal message on one of its ports and that port is selected as the new root port, the RSTP forces all other ports to synchronize with the new root information.

The device is synchronized with superior root information received on the root port if all other ports are synchronized. An individual port on the device is synchronized if

- That port is in the blocking state.
- It is an edge port (a port configured to be at the edge of the network).

If a designated port is in the forwarding state and is not configured as an edge port, it transitions to the blocking state when the RSTP forces it to synchronize with new root information. In general, when the RSTP forces a port to synchronize with root information and the port does not satisfy any of the above conditions, its port state is set to blocking.

Figure 5: Sequence of Events During Rapid Convergence

After ensuring that all of the ports are synchronized, the device sends an agreement message to the designated device corresponding to its root port. When the devices connected by a point-to-point link are in agreement

about their port roles, the RSTP immediately transitions the port states to forwarding.

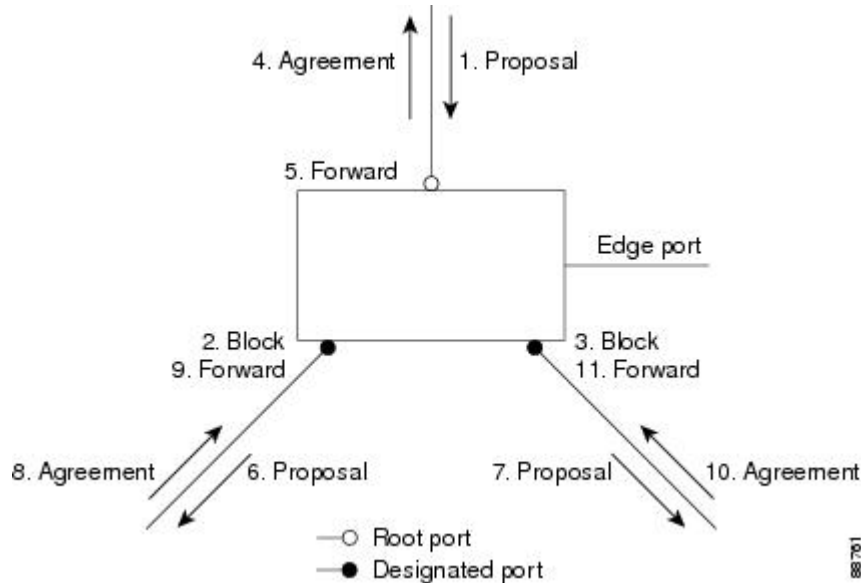

Bridge Protocol Data Unit Format and Processing

The RSTP BPDU format is the same as the IEEE 802.1D BPDU format except that the protocol version is set to 2. A new 1-byte Version 1 Length field is set to zero, which means that no version 1 protocol information is present.

Table 3: RSTP BPDU Flags

Bit	Function
0	Topology change (TC)
1	Proposal
2–3:	Port role:
00	Unknown
01	Alternate port
10	Root port
11	Designated port
4	Learning
5	Forwarding
6	Agreement
7	Topology change acknowledgement (TCA)

The sending device sets the proposal flag in the RSTP BPDU to propose itself as the designated device on that LAN. The port role in the proposal message is always set to the designated port.

The sending device sets the agreement flag in the RSTP BPDU to accept the previous proposal. The port role in the agreement message is always set to the root port.

The RSTP does not have a separate topology change notification (TCN) BPDU. It uses the topology change (TC) flag to show the topology changes. However, for interoperability with IEEE 802.1D devices, the RSTP device processes and generates TCN BPDUs.

The learning and forwarding flags are set according to the state of the sending port.

Processing Superior BPDU Information

If a port receives superior root information (lower device ID, lower path cost, and so forth) than currently stored for the port, the RSTP triggers a reconfiguration. If the port is proposed and is selected as the new root port, RSTP forces all the other ports to synchronize.

If the BPDU received is an RSTP BPDU with the proposal flag set, the device sends an agreement message after all of the other ports are synchronized. If the BPDU is an IEEE 802.1D BPDU, the device does not set the proposal flag and starts the forward-delay timer for the port. The new root port requires twice the forward-delay time to transition to the forwarding state.

If the superior information received on the port causes the port to become a backup or alternate port, RSTP sets the port to the blocking state but does not send the agreement message. The designated port continues sending BPDUs with the proposal flag set until the forward-delay timer expires, at which time the port transitions to the forwarding state.

Processing Inferior BPDU Information

If a designated port receives an inferior BPDU (such as a higher device ID or a higher path cost than currently stored for the port) with a designated port role, it immediately replies with its own information.

Topology Changes

This section describes the differences between the RSTP and the IEEE 802.1D in handling spanning-tree topology changes.

- **Detection**—Unlike IEEE 802.1D in which *any* transition between the blocking and the forwarding state causes a topology change, *only* transitions from the blocking to the forwarding state cause a topology change with RSTP (only an increase in connectivity is considered a topology change). State changes on an edge port do not cause a topology change. When an RSTP device detects a topology change, it deletes the learned information on all of its nonedge ports except on those from which it received the TC notification.
- **Notification**—Unlike IEEE 802.1D, which uses TCN BPDUs, the RSTP does not use them. However, for IEEE 802.1D interoperability, an RSTP device processes and generates TCN BPDUs.
- **Acknowledgement**—When an RSTP device receives a TCN message on a designated port from an IEEE 802.1D device, it replies with an IEEE 802.1D configuration BPDU with the TCA bit set. However, if the TC-while timer (the same as the topology-change timer in IEEE 802.1D) is active on a root port connected to an IEEE 802.1D device and a configuration BPDU with the TCA bit set is received, the TC-while timer is reset.

This behavior is only required to support IEEE 802.1D devices. The RSTP BPDUs never have the TCA bit set.

- **Propagation**—When an RSTP device receives a TC message from another device through a designated or root port, it propagates the change to all of its nonedge, designated ports and to the root port (excluding

the port on which it is received). The device starts the TC-while timer for all such ports and flushes the information learned on them.

- Protocol migration—For backward compatibility with IEEE 802.1D devices, RSTP selectively sends IEEE 802.1D configuration BPDUs and TCN BPDUs on a per-port basis.

When a port is initialized, the migrate-delay timer is started (specifies the minimum time during which RSTP BPDUs are sent), and RSTP BPDUs are sent. While this timer is active, the device processes all BPDUs received on that port and ignores the protocol type.

If the device receives an IEEE 802.1D BPDU after the port migration-delay timer has expired, it assumes that it is connected to an IEEE 802.1D device and starts using only IEEE 802.1D BPDUs. However, if the RSTP device is using IEEE 802.1D BPDUs on a port and receives an RSTP BPDU after the timer has expired, it restarts the timer and starts using RSTP BPDUs on that port.

Protocol Migration Process

A device running MSTP supports a built-in protocol migration mechanism that enables it to interoperate with legacy IEEE 802.1D devices. If this device receives a legacy IEEE 802.1D configuration BPDU (a BPDU with the protocol version set to 0), it sends only IEEE 802.1D BPDUs on that port. An MSTP device also can detect that a port is at the boundary of a region when it receives a legacy BPDU, an MST BPDU (Version 3) associated with a different region, or an RST BPDU (Version 2).

However, the device does not automatically revert to the MSTP mode if it no longer receives IEEE 802.1D BPDUs because it cannot detect whether the legacy device has been removed from the link unless the legacy device is the designated device. A device also might continue to assign a boundary role to a port when the device to which it is connected has joined the region.

Related Topics

[Restarting the Protocol Migration Process](#), on page 35

Default MSTP Configuration

Table 4: Default MSTP Configuration

Feature	Default Setting
Spanning-tree mode	MSTP
Switch priority (configurable on a per-CIST port basis)	32768
Spanning-tree port priority (configurable on a per-CIST port basis)	128
Spanning-tree port cost (configurable on a per-CIST port basis)	1000 Mb/s: 20000 100 Mb/s: 20000 10 Mb/s: 20000
Hello time	3 seconds
Forward-delay time	20 seconds
Maximum-aging time	20 seconds

Feature	Default Setting
Maximum hop count	20 hops

Related Topics

[Supported Spanning-Tree Instances](#)

[Specifying the MST Region Configuration and Enabling MSTP](#) , on page 19

About MST-to-PVST+ Interoperability (PVST+ Simulation)

The PVST+ simulation feature enables seamless interoperability between MST and Rapid PVST+. You can enable or disable this per port, or globally. PVST+ simulation is enabled by default.

However, you may want to control the connection between MST and Rapid PVST+ to protect against accidentally connecting an MST-enabled port to a Rapid PVST+-enabled port. Because Rapid PVST+ is the default STP mode, you may encounter many Rapid PVST+-enabled connections.

Disabling this feature causes the switch to stop the MST region from interacting with PVST+ regions. The MST-enabled port moves to a PVST peer inconsistent (blocking) state once it detects it is connected to a Rapid PVST+-enabled port. This port remains in the inconsistent state until the port stops receiving Shared Spanning Tree Protocol (SSTP) BPDUs, and then the port resumes the normal STP transition process.

You can for instance, disable PVST+ simulation, to prevent an incorrectly configured switch from connecting to a network where the STP mode is not MSTP (the default mode is PVST+).

Observe these guidelines when you configure MST switches (in the same region) to interact with PVST+ switches:

- Configure the root for all VLANs inside the MST region as shown in this example:

```
Switch# show spanning-tree mst interface gigabitethernet 1/1
GigabitEthernet1/1 of MST00 is root forwarding
Edge port: no (trunk) port guard : none (default)
Link type: point-to-point (auto) bpdu filter: disable (default)
Boundary : boundary (PVST) bpdu guard : disable (default)
Bpdus sent 10, received 310
```

```
Instance Role Sts Cost Prio.Nbr Vlans mapped
-----
0 Root FWD 20000 128.1 1-2,4-2999,4000-4094
3 Boun FWD 20000 128.1 3,3000-3999
```

The ports that belong to the MST switch at the boundary simulate PVST+ and send PVST+ BPDUs for all the VLANs.

If you enable loop guard on the PVST+ switches, the ports might change to a loop-inconsistent state when the MST switches change their configuration. To correct the loop-inconsistent state, you must disable and re-enable loop guard on that PVST+ switch.

- Do not locate the root for some or all of the VLANs inside the PVST+ side of the MST switch because when the MST switch at the boundary receives PVST+ BPDUs for all or some of the VLANs on its designated ports, root guard sets the port to the blocking state.
- When you connect a PVST+ switch to two different MST regions, the topology change from the PVST+ switch does not pass beyond the first MST region. In such a case, the topology changes are propagated only in the instance to which the VLAN is mapped. The topology change stays local to the first MST region, and the Cisco Access Manager (CAM) entries in the other region are not flushed. To make the

topology change visible throughout other MST regions, you can map that VLAN to IST or connect the PVST+ switch to the two regions through access links.

- When you disable the PVST+ simulation, note that the PVST+ peer inconsistency can also occur while the port is already in other states of inconsistency. For example, the root bridge for all STP instances must all be in either the MST region or the Rapid PVST+ side. If the root bridge for all STP instances are not on one side or the other, the software moves the port into a PVST + simulation-inconsistent state.



Note We recommend that you put the root bridge for all STP instances in the MST region.

About Detecting Unidirectional Link Failure

The dispute mechanism that detects unidirectional link failures is included in the IEEE 802.1D-2004 RSTP and IEEE 802.1Q-2005 MSTP standard, and requires no user configuration.

The switch checks the consistency of the port role and state in the BPDUs it receives, to detect unidirectional link failures that could cause bridging loops. When a designated port detects a conflict, it keeps its role, but reverts to a discarding (blocking) state because disrupting connectivity in case of inconsistency is preferable to opening a bridging loop.

For example, in the figure below, Switch A is the root bridge and Switch B is the designated port. BPDUs from Switch A are lost on the link leading to switch B.

Figure 6: Detecting Unidirectional Link Failure

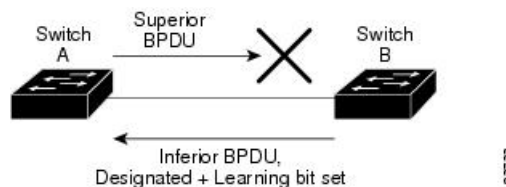

Since Rapid PVST+ (802.1w) and MST BPDUs include the role and state of the sending port, Switch A detects (from the inferior BPDU), that switch B does not react to the superior BPDUs it sends, because switch B has the role of a designated port and not the root bridge. As a result, switch A blocks (or keeps blocking) its port, thus preventing the bridging loop.

Note these guidelines and limitations relating to the dispute mechanism:

- It works only on switches running RSTP or MST (the dispute mechanism requires reading the role and state of the port initiating BPDUs).
- It may result in loss of connectivity. For example, in the figure below, Bridge A cannot transmit on the port it elected as a root port. As a result of this situation, there is loss of connectivity (r1 and r2 are designated, a1 is root and a2 is alternate. There is only a one way connectivity between A and R).

Figure 7: Loss of Connectivity

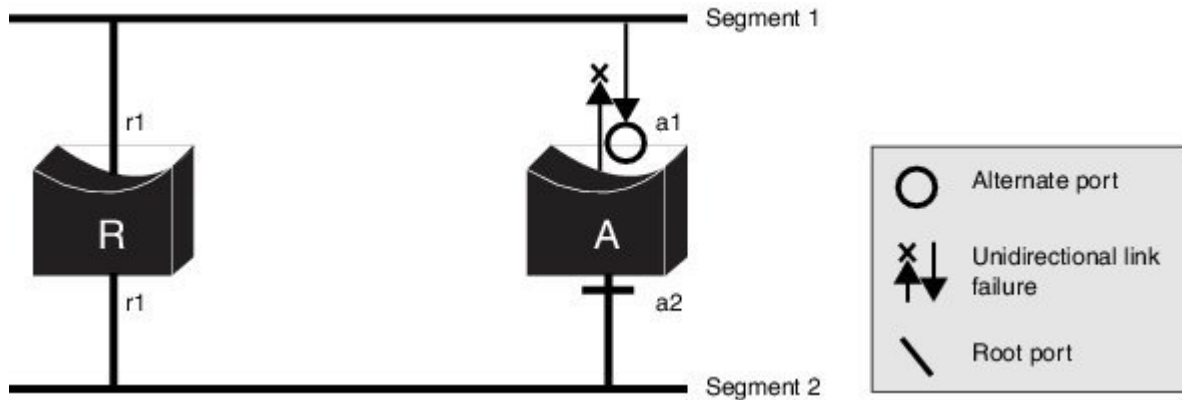

- It may cause permanent bridging loops on shared segments. For example, in the figure below, suppose that bridge R has the best priority, and that port b1 cannot receive any traffic from the shared segment 1 and sends inferior designated information on segment 1. Both r1 and a1 can detect this inconsistency. However, with the current dispute mechanism, only r1 will revert to discarding while the root port a1 opens a permanent loop. However, this problem does not occur in Layer 2 switched networks that are connected by point-to-point links.

Figure 8: Bridging Loops on Shared Segments

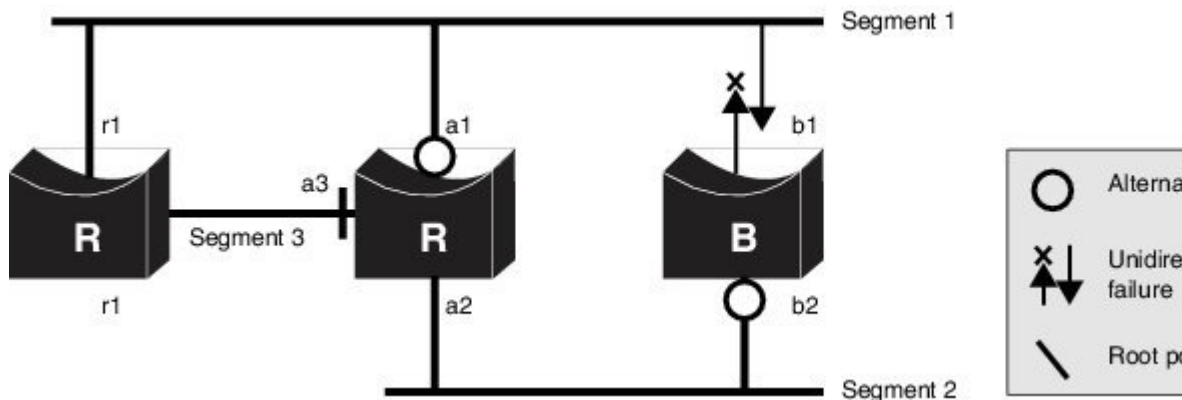

How to Configure MSTP Features

Specifying the MST Region Configuration and Enabling MSTP

For two or more switches to be in the same MST region, they must have the same VLAN-to-instance mapping, the same configuration revision number, and the same name.

A region can have one member or multiple members with the same MST configuration; each member must be capable of processing RSTP BPDUs. There is no limit to the number of MST regions in a network, but each region can only support up to 65 spanning-tree instances. You can assign a VLAN to only one spanning-tree instance at a time.

SUMMARY STEPS

1. **enable**
2. **configure terminal**
3. **spanning-tree mst configuration**
4. **instance** *instance-id* **vlan** *vlan-range*
5. **name** *name*
6. **revision** *version*
7. **show pending**
8. **exit**
9. **spanning-tree mode mst**
10. **end**

DETAILED STEPS

	Command or Action	Purpose
Step 1	enable Example: Device> enable	Enables privileged EXEC mode. <ul style="list-style-type: none"> • Enter your password if prompted.
Step 2	configure terminal Example: Device# configure terminal	Enters global configuration mode.
Step 3	spanning-tree mst configuration Example: Device(config)# spanning-tree mst configuration	Enters MST configuration mode.
Step 4	instance <i>instance-id</i> vlan <i>vlan-range</i> Example: Device(config-mst)# instance 1 vlan 10-20	Maps VLANs to an MST instance. <ul style="list-style-type: none"> • For <i>instance-id</i>, the range is 0 to 4094. • For vlan <i>vlan-range</i>, the range is 1 to 4094. When you map VLANs to an MST instance, the mapping is incremental, and the VLANs specified in the command are added to or removed from the VLANs that were previously mapped. <p>To specify a VLAN range, use a hyphen; for example, instance 1 vlan 1-63 maps VLANs 1 through 63 to MST instance 1.</p> <p>To specify a VLAN series, use a comma; for example, instance 1 vlan 10, 20, 30 maps VLANs 10, 20, and 30 to MST instance 1.</p>

	Command or Action	Purpose
Step 5	name <i>name</i> Example: Device(config-mst)# name region1	Specifies the configuration name. The <i>name</i> string has a maximum length of 32 characters and is case sensitive.
Step 6	revision <i>version</i> Example: Device(config-mst)# revision 1	Specifies the configuration revision number. The range is 0 to 65535.
Step 7	show pending Example: Device(config-mst)# show pending	Verifies your configuration by displaying the pending configuration.
Step 8	exit Example: Device(config-mst)# exit	Applies all changes, and returns to global configuration mode.
Step 9	spanning-tree mode mst Example: Device(config)# spanning-tree mode mst	Enables MSTP. RSTP is also enabled. Changing spanning-tree modes can disrupt traffic because all spanning-tree instances are stopped for the previous mode and restarted in the new mode. You cannot run both MSTP and PVST+ or both MSTP and Rapid PVST+ at the same time.
Step 10	end Example: Device(config)# end	Returns to privileged EXEC mode.

Related Topics

- [MSTP Configuration Guidelines](#), on page 3
- [Multiple Spanning-Tree Regions](#), on page 4
- [Prerequisites for MSTP](#), on page 1
- [Restrictions for MSTP](#), on page 2
- [Spanning-Tree Interoperability and Backward Compatibility](#)
- [Optional Spanning-Tree Configuration Guidelines](#)
- [BackboneFast](#)
- [UplinkFast](#)
- [Default MSTP Configuration](#), on page 16
- [Configuring the Root Device](#), on page 22
- [Bridge ID, Device Priority, and Extended System ID](#)

- [Configuring a Secondary Root Device](#) , on page 23
- [Configuring Port Priority](#) , on page 24
- [Configuring Path Cost](#) , on page 26
- [Configuring the Device Priority](#) , on page 27
- [Configuring the Hello Time](#) , on page 29
- [Configuring the Forwarding-Delay Time](#) , on page 30
- [Configuring the Maximum-Aging Time](#) , on page 31
- [Configuring the Maximum-Hop Count](#) , on page 31
- [Specifying the Link Type to Ensure Rapid Transitions](#) , on page 32
- [Designating the Neighbor Type](#) , on page 34
- [Restarting the Protocol Migration Process](#) , on page 35

Configuring the Root Device

This procedure is optional.

Before you begin

A multiple spanning tree (MST) must be specified and enabled on the device. For instructions, see [Related Topics](#).

You must also know the specified MST instance ID. Step 2 in the example uses 0 as the instance ID because that was the instance ID set up by the instructions listed under [Related Topics](#).

SUMMARY STEPS

1. **enable**
2. **configure terminal**
3. **spanning-tree mst *instance-id* root primary**
4. **end**

DETAILED STEPS

	Command or Action	Purpose
Step 1	enable Example: Device> enable	Enables privileged EXEC mode. <ul style="list-style-type: none"> • Enter your password if prompted.
Step 2	configure terminal Example: Device# configure terminal	Enters global configuration mode.
Step 3	spanning-tree mst <i>instance-id</i> root primary Example:	Configures a device as the root device.

	Command or Action	Purpose
	Device(config)# spanning-tree mst 0 root primary	<ul style="list-style-type: none"> For <i>instance-id</i>, you can specify a single instance, a range of instances separated by a hyphen, or a series of instances separated by a comma. The range is 0 to 4094.
Step 4	end Example: Device(config)# end	Returns to privileged EXEC mode.

Related Topics

- [Root Switch](#), on page 4
- [Specifying the MST Region Configuration and Enabling MSTP](#), on page 19
- [Restrictions for MSTP](#), on page 2
- [Bridge ID, Device Priority, and Extended System ID](#)
- [Configuring a Secondary Root Device](#), on page 23

Configuring a Secondary Root Device

When you configure a device with the extended system ID support as the secondary root, the device priority is modified from the default value (32768) to 28672. The device is then likely to become the root device for the specified instance if the primary root device fails. This is assuming that the other network devices use the default device priority of 32768 and therefore are unlikely to become the root device.

You can execute this command on more than one device to configure multiple backup root devices. Use the same network diameter and hello-time values that you used when you configured the primary root device with the **spanning-tree mst *instance-id* root primary** global configuration command.

This procedure is optional.

Before you begin

A multiple spanning tree (MST) must be specified and enabled on the device. For instructions, see Related Topics.

You must also know the specified MST instance ID. This example uses 0 as the instance ID because that was the instance ID set up by the instructions listed under Related Topics.

SUMMARY STEPS

1. **enable**
2. **configure terminal**
3. **spanning-tree mst *instance-id* root secondary**
4. **end**

DETAILED STEPS

	Command or Action	Purpose
Step 1	enable Example: Device> enable	Enables privileged EXEC mode. <ul style="list-style-type: none"> • Enter your password if prompted.
Step 2	configure terminal Example: Device# configure terminal	Enters global configuration mode.
Step 3	spanning-tree mst <i>instance-id</i> root secondary Example: Device(config)# spanning-tree mst 0 root secondary	Configures a device as the secondary root device. <ul style="list-style-type: none"> • For <i>instance-id</i>, you can specify a single instance, a range of instances separated by a hyphen, or a series of instances separated by a comma. The range is 0 to 4094.
Step 4	end Example: Device(config)# end	Returns to privileged EXEC mode.

Related Topics

[Specifying the MST Region Configuration and Enabling MSTP](#) , on page 19

[Configuring the Root Device](#) , on page 22

Configuring Port Priority

If a loop occurs, the MSTP uses the port priority when selecting an interface to put into the forwarding state. You can assign higher priority values (lower numerical values) to interfaces that you want selected first and lower priority values (higher numerical values) that you want selected last. If all interfaces have the same priority value, the MSTP puts the interface with the lowest interface number in the forwarding state and blocks the other interfaces.

This procedure is optional.

Before you begin

A multiple spanning tree (MST) must be specified and enabled on the device. For instructions, see Related Topics.

You must also know the specified MST instance ID and the interface used. This example uses 0 as the instance ID and GigabitEthernet0/1 as the interface because that was the instance ID and interface set up by the instructions listed under Related Topics.

SUMMARY STEPS

1. **enable**
2. **configure terminal**
3. **interface** *interface-id*
4. **spanning-tree mst** *instance-id* **port-priority** *priority*
5. **end**

DETAILED STEPS

	Command or Action	Purpose
Step 1	enable Example: Device> enable	Enables privileged EXEC mode. <ul style="list-style-type: none"> • Enter your password if prompted.
Step 2	configure terminal Example: Device# configure terminal	Enters global configuration mode.
Step 3	interface <i>interface-id</i> Example: Device(config)# interface gigabitethernet 0/1	Specifies an interface to configure, and enters interface configuration mode.
Step 4	spanning-tree mst <i>instance-id</i> port-priority <i>priority</i> Example: Device(config-if)# spanning-tree mst 0 port-priority 64	Configures port priority. <ul style="list-style-type: none"> • For <i>instance-id</i>, you can specify a single instance, a range of instances separated by a hyphen, or a series of instances separated by a comma. The range is 0 to 4094. • For <i>priority</i>, the range is 0 to 240 in increments of 16. The default is 128. The lower the number, the higher the priority. The priority values are 0, 16, 32, 48, 64, 80, 96, 112, 128, 144, 160, 176, 192, 208, 224, and 240. All other values are rejected.
Step 5	end Example: Device(config-if)# end	Returns to privileged EXEC mode.

The **show spanning-tree mst interface** *interface-id* privileged EXEC command displays information only if the port is in a link-up operative state. Otherwise, you can use the **show running-config interface** privileged EXEC command to confirm the configuration.

Related Topics

[Specifying the MST Region Configuration and Enabling MSTP](#) , on page 19
[Configuring Path Cost](#) , on page 26

Configuring Path Cost

The MSTP path cost default value is derived from the media speed of an interface. If a loop occurs, the MSTP uses cost when selecting an interface to put in the forwarding state. You can assign lower cost values to interfaces that you want selected first and higher cost values that you want selected last. If all interfaces have the same cost value, the MSTP puts the interface with the lowest interface number in the forwarding state and blocks the other interfaces.

This procedure is optional.

Before you begin

A multiple spanning tree (MST) must be specified and enabled on the device. For instructions, see Related Topics.

You must also know the specified MST instance ID and the interface used. This example uses 0 as the instance ID and GigabitEthernet0/1 as the interface because that was the instance ID and interface set up by the instructions listed under Related Topics.

SUMMARY STEPS

1. **enable**
2. **configure terminal**
3. **interface** *interface-id*
4. **spanning-tree mst** *instance-id* **cost** *cost*
5. **end**

DETAILED STEPS

	Command or Action	Purpose
Step 1	enable Example: Device> enable	Enables privileged EXEC mode. <ul style="list-style-type: none"> • Enter your password if prompted.
Step 2	configure terminal Example: Device# configure terminal	Enters global configuration mode.

	Command or Action	Purpose
Step 3	interface <i>interface-id</i> Example: Device(config)# interface gigabitethernet 0/1	Specifies an interface to configure, and enters interface configuration mode. Valid interfaces include physical ports and port-channel logical interfaces. The port-channel range is 1 to 48.
Step 4	spanning-tree mst <i>instance-id</i> cost <i>cost</i> Example: Device(config-if)# spanning-tree mst 0 cost 17031970	Configures the cost. If a loop occurs, the MSTP uses the path cost when selecting an interface to place into the forwarding state. A lower path cost represents higher-speed transmission. <ul style="list-style-type: none"> • For <i>instance-id</i>, you can specify a single instance, a range of instances separated by a hyphen, or a series of instances separated by a comma. The range is 0 to 4094. • For <i>cost</i>, the range is 1 to 200000000; the default value is derived from the media speed of the interface.
Step 5	end Example: Device(config-if)# end	Returns to privileged EXEC mode.

The **show spanning-tree mst interface** *interface-id* privileged EXEC command displays information only for ports that are in a link-up operative state. Otherwise, you can use the **show running-config** privileged EXEC command to confirm the configuration.

Related Topics

[Configuring Port Priority](#) , on page 24

[Specifying the MST Region Configuration and Enabling MSTP](#) , on page 19

Configuring the Device Priority

Changing the priority of a device makes it more likely to be chosen as the root device whether it is a standalone device.



Note Exercise care when using this command. For normal network configurations, we recommend that you use the **spanning-tree mst** *instance-id* **root primary** and the **spanning-tree mst** *instance-id* **root secondary** global configuration commands to specify a device as the root or secondary root device. You should modify the device priority only in circumstances where these commands do not work.

This procedure is optional.

Before you begin

A multiple spanning tree (MST) must be specified and enabled on the device. For instructions, see Related Topics.

You must also know the specified MST instance ID used. This example uses 0 as the instance ID because that was the instance ID set up by the instructions listed under Related Topics.

SUMMARY STEPS

1. **enable**
2. **configure terminal**
3. **spanning-tree mst *instance-id* priority *priority***
4. **end**

DETAILED STEPS

	Command or Action	Purpose
Step 1	enable Example: Device> enable	Enables privileged EXEC mode. <ul style="list-style-type: none"> • Enter your password if prompted.
Step 2	configure terminal Example: Device# configure terminal	Enters global configuration mode.
Step 3	spanning-tree mst <i>instance-id</i> priority <i>priority</i> Example: Device(config)# spanning-tree mst 0 priority 40960	Configures the device priority. <ul style="list-style-type: none"> • For <i>instance-id</i>, you can specify a single instance, a range of instances separated by a hyphen, or a series of instances separated by a comma. The range is 0 to 4094. • For <i>priority</i>, the range is 0 to 61440 in increments of 4096; the default is 32768. The lower the number, the more likely the device will be chosen as the root device. Priority values are 0, 4096, 8192, 12288, 16384, 20480, 24576, 28672, 32768, 36864, 40960, 45056, 49152, 53248, 57344, and 61440. These are the only acceptable values.
Step 4	end Example: Device(config-if)# end	Returns to privileged EXEC mode.

Related Topics

[Specifying the MST Region Configuration and Enabling MSTP](#) , on page 19

Configuring the Hello Time

The hello time is the time interval between configuration messages generated and sent by the root device. This procedure is optional.

Before you begin

A multiple spanning tree (MST) must be specified and enabled on the device. For instructions, see Related Topics.

SUMMARY STEPS

1. **enable**
2. **configure terminal**
3. **spanning-tree mst hello-time *seconds***
4. **end**

DETAILED STEPS

	Command or Action	Purpose
Step 1	enable Example: Device> enable	Enables privileged EXEC mode. <ul style="list-style-type: none"> • Enter your password if prompted.
Step 2	configure terminal Example: Device# configure terminal	Enters global configuration mode.
Step 3	spanning-tree mst hello-time <i>seconds</i> Example: Device(config)# spanning-tree mst hello-time 4	Configures the hello time for all MST instances. The hello time is the time interval between configuration messages generated and sent by the root device. These messages indicate that the device is alive. For <i>seconds</i> , the range is 1 to 10; the default is 3.
Step 4	end Example: Device(config)# end	Returns to privileged EXEC mode.

Related Topics

[Specifying the MST Region Configuration and Enabling MSTP](#) , on page 19

Configuring the Forwarding-Delay Time

Before you begin

A multiple spanning tree (MST) must be specified and enabled on the device. For instructions, see Related Topics.

SUMMARY STEPS

1. **enable**
2. **configure terminal**
3. **spanning-tree mst forward-time *seconds***
4. **end**

DETAILED STEPS

	Command or Action	Purpose
Step 1	enable Example: Device> enable	Enables privileged EXEC mode. <ul style="list-style-type: none"> • Enter your password if prompted.
Step 2	configure terminal Example: Device# configure terminal	Enters global configuration mode.
Step 3	spanning-tree mst forward-time <i>seconds</i> Example: Device(config)# spanning-tree mst forward-time 25	Configures the forward time for all MST instances. The forwarding delay is the number of seconds a port waits before changing from its spanning-tree learning and listening states to the forwarding state. For <i>seconds</i> , the range is 4 to 30; the default is 20.
Step 4	end Example: Device(config)# end	Returns to privileged EXEC mode.

Related Topics

[Specifying the MST Region Configuration and Enabling MSTP](#) , on page 19

Configuring the Maximum-Aging Time

Before you begin

A multiple spanning tree (MST) must be specified and enabled on the device. For instructions, see [Related Topics](#).

SUMMARY STEPS

1. `enable`
2. `configure terminal`
3. `spanning-tree mst max-age seconds`
4. `end`

DETAILED STEPS

	Command or Action	Purpose
Step 1	enable Example: Device> <code>enable</code>	Enables privileged EXEC mode. <ul style="list-style-type: none"> • Enter your password if prompted.
Step 2	configure terminal Example: Device# <code>configure terminal</code>	Enters global configuration mode.
Step 3	spanning-tree mst max-age seconds Example: Device(config)# <code>spanning-tree mst max-age 40</code>	Configures the maximum-aging time for all MST instances. The maximum-aging time is the number of seconds a device waits without receiving spanning-tree configuration messages before attempting a reconfiguration. For <i>seconds</i> , the range is 6 to 40; the default is 20.
Step 4	end Example: Device(config)# <code>end</code>	Returns to privileged EXEC mode.

Related Topics

[Specifying the MST Region Configuration and Enabling MSTP](#), on page 19

Configuring the Maximum-Hop Count

This procedure is optional.

Before you begin

A multiple spanning tree (MST) must be specified and enabled on the device. For instructions, see Related Topics.

SUMMARY STEPS

1. **enable**
2. **configure terminal**
3. **spanning-tree mst max-hops *hop-count***
4. **end**

DETAILED STEPS

	Command or Action	Purpose
Step 1	enable Example: Device> enable	Enables privileged EXEC mode. <ul style="list-style-type: none"> • Enter your password if prompted.
Step 2	configure terminal Example: Device# configure terminal	Enters global configuration mode.
Step 3	spanning-tree mst max-hops <i>hop-count</i> Example: Device(config)# spanning-tree mst max-hops 25	Specifies the number of hops in a region before the BPDU is discarded, and the information held for a port is aged. For <i>hop-count</i> , the range is 1 to 255; the default is 20.
Step 4	end Example: Device(config)# end	Returns to privileged EXEC mode.

Related Topics

[Specifying the MST Region Configuration and Enabling MSTP](#) , on page 19

Specifying the Link Type to Ensure Rapid Transitions

If you connect a port to another port through a point-to-point link and the local port becomes a designated port, the RSTP negotiates a rapid transition with the other port by using the proposal-agreement handshake to ensure a loop-free topology.

By default, the link type is controlled from the duplex mode of the interface: a full-duplex port is considered to have a point-to-point connection; a half-duplex port is considered to have a shared connection. If you have

a half-duplex link physically connected point-to-point to a single port on a remote device running MSTP, you can override the default setting of the link type and enable rapid transitions to the forwarding state.

This procedure is optional.

Before you begin

A multiple spanning tree (MST) must be specified and enabled on the device. For instructions, see Related Topics.

You must also know the specified MST instance ID and the interface used. This example uses 0 as the instance ID and GigabitEthernet0/1 as the interface because that was the instance ID and interface set up by the instructions listed under Related Topics.

SUMMARY STEPS

1. **enable**
2. **configure terminal**
3. **interface** *interface-id*
4. **spanning-tree link-type point-to-point**
5. **end**

DETAILED STEPS

	Command or Action	Purpose
Step 1	enable Example: Device> enable	Enables privileged EXEC mode. <ul style="list-style-type: none"> • Enter your password if prompted.
Step 2	configure terminal Example: Device# configure terminal	Enters global configuration mode.
Step 3	interface <i>interface-id</i> Example: Device(config)# interface gigabitethernet 0/1	Specifies an interface to configure, and enters interface configuration mode. Valid interfaces include physical ports, VLANs, and port-channel logical interfaces. The VLAN ID range is 1 to 4094. The port-channel range is 1 to 48.
Step 4	spanning-tree link-type point-to-point Example: Device(config-if)# spanning-tree link-type point-to-point	Specifies that the link type of a port is point-to-point.
Step 5	end Example:	Returns to privileged EXEC mode.

	Command or Action	Purpose
	Device(config-if)# end	

Related Topics

[Specifying the MST Region Configuration and Enabling MSTP](#), on page 19

Designating the Neighbor Type

A topology could contain both prestandard and IEEE 802.1s standard compliant devices. By default, ports can automatically detect prestandard devices, but they can still receive both standard and prestandard BPDUs. When there is a mismatch between a device and its neighbor, only the CIST runs on the interface.

You can choose to set a port to send only prestandard BPDUs. The prestandard flag appears in all the **show** commands, even if the port is in STP compatibility mode.

This procedure is optional.

Before you begin

A multiple spanning tree (MST) must be specified and enabled on the device. For instructions, see Related Topics.

SUMMARY STEPS

1. **enable**
2. **configure terminal**
3. **interface** *interface-id*
4. **spanning-tree mst pre-standard**
5. **end**

DETAILED STEPS

	Command or Action	Purpose
Step 1	enable Example: Device> enable	Enables privileged EXEC mode. <ul style="list-style-type: none"> • Enter your password if prompted.
Step 2	configure terminal Example: Device# configure terminal	Enters global configuration mode.
Step 3	interface <i>interface-id</i> Example: Device(config)# interface gigabitethernet 0/1	Specifies an interface to configure, and enters interface configuration mode. Valid interfaces include physical ports.

	Command or Action	Purpose
Step 4	spanning-tree mst pre-standard Example: Device(config-if) # spanning-tree mst pre-standard	Specifies that the port can send only prestandard BPDUs.
Step 5	end Example: Device(config-if) # end	Returns to privileged EXEC mode.

Related Topics

[Specifying the MST Region Configuration and Enabling MSTP](#) , on page 19

Restarting the Protocol Migration Process

This procedure restarts the protocol migration process and forces renegotiation with neighboring devices. It reverts the device to MST mode. It is needed when the device no longer receives IEEE 802.1D BPDUs after it has been receiving them.

Follow these steps to restart the protocol migration process (force the renegotiation with neighboring devices) on the device.

Before you begin

A multiple spanning tree (MST) must be specified and enabled on the device. For instructions, see Related Topics.

If you want to use the interface version of the command, you must also know the MST interface used. This example uses GigabitEthernet0/1 as the interface because that was the interface set up by the instructions listed under Related Topics.

SUMMARY STEPS

1. **enable**
2. Enter one of the following commands:
 - **clear spanning-tree detected-protocols**
 - **clear spanning-tree detected-protocols interface** *interface-id*

DETAILED STEPS

	Command or Action	Purpose
Step 1	enable Example: Device> enable	Enables privileged EXEC mode. <ul style="list-style-type: none"> • Enter your password if prompted.

	Command or Action	Purpose
Step 2	Enter one of the following commands: <ul style="list-style-type: none"> • clear spanning-tree detected-protocols • clear spanning-tree detected-protocols interface <i>interface-id</i> Example: Device# clear spanning-tree detected-protocols or Device# clear spanning-tree detected-protocols interface gigabitethernet 0/1	The device reverts to the MSTP mode, and the protocol migration process restarts.

What to do next

This procedure may need to be repeated if the device receives more legacy IEEE 802.1D configuration BPDUs (BPDUs with the protocol version set to 0).

Related Topics

[Specifying the MST Region Configuration and Enabling MSTP](#), on page 19
[Protocol Migration Process](#), on page 16

Configuring PVST+ Simulation

PVST+ simulation is enabled by default. This means that all ports automatically interoperate with a connected device that is running in Rapid PVST+ mode. If you disabled the feature and want to re-configure it, refer to the following tasks.

To enable PVST+ simulation globally, perform this task:

SUMMARY STEPS

1. **enable**
2. **configure terminal**
3. **spanning-tree mst simulate pvst global**
4. **end**

DETAILED STEPS

	Command or Action	Purpose
Step 1	enable Example: Device> enable	Enables privileged EXEC mode. <ul style="list-style-type: none"> • Enter your password if prompted.
Step 2	configure terminal Example:	Enters global configuration mode.

	Command or Action	Purpose
	Device# <code>configure terminal</code>	
Step 3	spanning-tree mst simulate pvst global Example: Device(config)# <code>spanning-tree mst simulate pvst global</code>	Enables PVST+ simulation globally. To prevent the switch from automatically interoperating with a connecting switch that is running Rapid PVST+, enter the no version of the command.
Step 4	end Example: Device(config)# <code>end</code>	Returns to privileged EXEC mode.

Enabling PVST+ Simulation on a Port

To enable PVST+ simulation on a port, perform this task:

SUMMARY STEPS

1. `enable`
2. `configure terminal`
3. `interface interface-id`
4. `spanning-tree mst simulate pvst`
5. `end`
6. `show spanning-tree summary`

DETAILED STEPS

	Command or Action	Purpose
Step 1	enable Example: Device> <code>enable</code>	Enables privileged EXEC mode. • Enter your password if prompted.
Step 2	configure terminal Example: Device# <code>configure terminal</code>	Enters global configuration mode.
Step 3	interface interface-id Example:	Selects a port to configure.

	Command or Action	Purpose
	Device(config) # interface gi1/0/1	
Step 4	spanning-tree mst simulate pvst Example: Device(config-if) # spanning-tree mst simulate pvst	Enables PVST+ simulation on the specified interface. To prevent a specified interface from automatically interoperating with a connecting switch that is not running MST, enter the spanning-tree mst simulate pvst disable command.
Step 5	end Example: Device(config) # end	Returns to privileged EXEC mode.
Step 6	show spanning-tree summary Example: Device# show spanning-tree summary	Verifies the configuration.

Examples

Examples: PVST+ Simulation

This example shows how to prevent the switch from automatically interoperating with a connecting switch that is running Rapid PVST+:

```
Switch# configure terminal
Switch(config)# no spanning-tree mst simulate pvst global
```

This example shows how to prevent a port from automatically interoperating with a connecting device that is running Rapid PVST+:

```
Switch(config)# interface 1/0/10/1
Switch(config-if)# spanning-tree mst simulate pvst disable
```

The following sample output shows the system message you receive when a SSTP BPDU is received on a port and PVST+ simulation is disabled:

```
Message
SPANTREE_PVST_PEER_BLOCK: PVST BPDU detected on port %s [port number].
```

```
Severity
Critical
```

```
Explanation
A PVST+ peer was detected on the specified interface on the switch. PVST+
```

simulation feature is disabled, as a result of which the interface was moved to the spanning tree Blocking state.

Action

Identify the PVST+ switch from the network which might be configured incorrectly.

The following sample output shows the system message you receive when peer inconsistency on the interface is cleared:

Message

```
SPANTREE_PVST_PEER_UNBLOCK: Unblocking port %s [port number].
```

Severity

Critical

Explanation

The interface specified in the error message has been restored to normal spanning tree state.

Action

None.

This example shows the spanning tree status when port **1/0/10/1** has been configured to disable PVST+ simulation and is currently in the peer type inconsistent state:

```
Switch# show spanning-tree
VLAN0010
  Spanning tree enabled protocol mstp
  Root ID Priority 32778
        Address 0002.172c.f400
        This bridge is the root
  Hello Time 2 sec Max Age 20 sec Forward Delay 15 sec
  Bridge ID Priority 32778 (priority 32768 sys-id-ext 10)
        Address 0002.172c.f400
        Hello Time 2 sec Max Age 20 sec Forward Delay 15 sec
        Aging Time 300
Interface      Role Sts Cost          Prio.Nbr Type
-----
Gi1/0/10/1    Desg BKN*4      128.270 P2p *PVST_Peer_Inc
```

This example shows the spanning tree summary when PVST+ simulation is enabled in the MSTP mode:

```
Switch# show spanning-tree summary
Switch is in mst mode (IEEE Standard)
Root bridge for: MST0
EtherChannel misconfig guard is enabled
Extended system ID is enabled
Portfast Default is disabled
PortFast BPDU Guard Default is disabled
Portfast BPDU Filter Default is disabled
Loopguard Default is disabled
UplinkFast is disabled
BackboneFast is disabled
```

```

Pathcost method used is long
PVST Simulation Default is enabled
Name                Blocking Listening Learning Forwarding STP Active
-----
MST0                 2          0          0          0          2
-----
1 mst                2          0          0          0          2

```

This example shows the spanning tree summary when PVST+ simulation is disabled in any STP mode:

```

Switch# show spanning-tree summary
Switch is in mst mode (IEEE Standard)
Root bridge for: MST0
EtherChannel misconfig guard is enabled
Extended system ID is enabled
Portfast Default is disabled
PortFast BPDU Guard Default is disabled
Portfast BPDU Filter Default is disabled
Loopguard Default is disabled
UplinkFast is disabled
BackboneFast is disabled
Pathcost method used is long
PVST Simulation Default is disabled
Name                Blocking Listening Learning Forwarding STP Active
-----
MST0                 2          0          0          0          2
-----
1 mst                2          0          0          0          2

```

This example shows the spanning tree summary when the switch is not in MSTP mode, that is, the switch is in PVST or Rapid-PVST mode. The output string displays the current STP mode:

```

Switch# show spanning-tree summary
Switch is in rapid-pvst mode
Root bridge for: VLAN0001, VLAN2001-VLAN2002
EtherChannel misconfig guard is enabled
Extended system ID is enabled
Portfast Default is disabled
PortFast BPDU Guard Default is disabled
Portfast BPDU Filter Default is disabled
Loopguard Default is disabled
UplinkFast is disabled
BackboneFast is disabled
Pathcost method used is short
PVST Simulation Default is enabled but inactive in rapid-pvst mode
Name                Blocking Listening Learning Forwarding STP Active
-----
VLAN0001            2          0          0          0          2
VLAN2001            2          0          0          0          2
VLAN2002            2          0          0          0          2
-----
3 vlans             6          0          0          0          6

```

This example shows the interface details when PVST+ simulation is globally enabled, or the default configuration:

```
Switch# show spanning-tree interfacel/0/10/1 detail
Port 269 (GigabitEthernet1/0/10/1) of VLAN0002 is forwarding
  Port path cost 4, Port priority 128, Port Identifier 128.297.
  Designated root has priority 32769, address 0013.5f20.01c0
  Designated bridge has priority 32769, address 0013.5f20.01c0
  Designated port id is 128.297, designated path cost 0
  Timers: message age 0, forward delay 0, hold 0
  Number of transitions to forwarding state: 1
  Link type is point-to-point by default
  PVST Simulation is enabled by default
  BPDU: sent 132, received 1
```

This example shows the interface details when PVST+ simulation is globally disabled:

```
Switch# show spanning-tree interfacel/0/10/1 detail
Port 269 (GigabitEthernet1/0/10/1) of VLAN0002 is forwarding
  Port path cost 4, Port priority 128, Port Identifier 128.297.
  Designated root has priority 32769, address 0013.5f20.01c0
  Designated bridge has priority 32769, address 0013.5f20.01c0
  Designated port id is 128.297, designated path cost 0
  Timers: message age 0, forward delay 0, hold 0
  Number of transitions to forwarding state: 1
  Link type is point-to-point by default
  PVST Simulation is disabled by default
  BPDU: sent 132, received 1
```

This example shows the interface details when PVST+ simulation is explicitly enabled on the port:

```
Switch# show spanning-tree interfacel/0/10/1 detail
Port 269 (GigabitEthernet1/0/10/1) of VLAN0002 is forwarding
  Port path cost 4, Port priority 128, Port Identifier 128.297.
  Designated root has priority 32769, address 0013.5f20.01c0
  Designated bridge has priority 32769, address 0013.5f20.01c0
  Designated port id is 128.297, designated path cost 0
  Timers: message age 0, forward delay 0, hold 0
  Number of transitions to forwarding state: 1
  Link type is point-to-point by default
  PVST Simulation is enabled
  BPDU: sent 132, received 1
```

This example shows the interface details when the PVST+ simulation feature is disabled and a PVST Peer inconsistency has been detected on the port:

```
Switch# show spanning-tree interfacel/0/10/1 detail
Port 269 (GigabitEthernet1/0/10/1) of VLAN0002 is broken (PVST Peer Inconsistent)
  Port path cost 4, Port priority 128, Port Identifier 128.297.
  Designated root has priority 32769, address 0013.5f20.01c0
  Designated bridge has priority 32769, address 0013.5f20.01c0
  Designated port id is 128.297, designated path cost 0
  Timers: message age 0, forward delay 0, hold 0
  Number of transitions to forwarding state: 1
  Link type is point-to-point by default
  PVST Simulation is disabled
  BPDU: sent 132, received 1
```

Examples: Detecting Unidirectional Link Failure

This example shows the spanning tree status when port **1/0/10/1 detail** has been configured to disable PVST+ simulation and the port is currently in the peer type inconsistent state:

```
Switch# show spanning-tree
VLAN0010
  Spanning tree enabled protocol rstp
  Root ID    Priority 32778
             Address 0002.172c.f400
             This bridge is the root
             Hello Time 2 sec Max Age 20 sec Forward Delay 15 sec
  Bridge ID  Priority 32778 (priority 32768 sys-id-ext 10)
             Address 0002.172c.f400
             Hello Time 2 sec Max Age 20 sec Forward Delay 15 sec
             Aging Time 300

Interface          Role Sts Cost          Prio.Nbr Type
-----
Gi1/0/10/1        Desg BKN 4          128.270 P2p Dispute
```

This example shows the interface details when a dispute condition is detected:

```
Switch# show spanning-tree interface1/0/10/1 detail
Port 269 (GigabitEthernet1/0/10/1) of VLAN0002 is designated blocking (dispute)
  Port path cost 4, Port priority 128, Port Identifier 128.297.
  Designated root has priority 32769, address 0013.5f20.01c0
  Designated bridge has priority 32769, address 0013.5f20.01c0
  Designated port id is 128.297, designated path cost 0
  Timers: message age 0, forward delay 0, hold 0
  Number of transitions to forwarding state: 1
  Link type is point-to-point by default
  BPDU: sent 132, received 1
```

Monitoring MST Configuration and Status

Table 5: Commands for Displaying MST Status

show spanning-tree mst configuration	Displays the MST region configuration.
show spanning-tree mst configuration digest	Displays the MD5 digest included in the current MSTCI.
show spanning-tree mst	Displays MST information for the all instances. Note This command displays information for ports in a link-up state.
show spanning-tree mst instance-id	Displays MST information for the specified instance. Note This command displays information only if the port is in operative state.
show spanning-tree mst interface interface-id	Displays MST information for the specified interface.

Feature Information for MSTP

Release	Modification
Cisco IOS 15.0(2)EX	This feature was introduced.

