



IP Multicast Routing Technology Overview

- [Information About IP Multicast Technology, on page 1](#)
- [Additional References for IP Multicast, on page 15](#)
- [Feature History and Information for IP Multicast, on page 16](#)

Information About IP Multicast Technology

This section provides information about IP multicast technology.

About IP Multicast

Controlling the transmission rate to a multicast group is not supported.

At one end of the IP communication spectrum is IP unicast, where a source IP host sends packets to a specific destination IP host. In IP unicast, the destination address in the IP packet is the address of a single, unique host in the IP network. These IP packets are forwarded across the network from the source to the destination host by devices. At each point on the path between source and destination, a device uses a unicast routing table to make unicast forwarding decisions, based on the IP destination address in the packet.

At the other end of the IP communication spectrum is an IP broadcast, where a source host sends packets to all hosts on a network segment. The destination address of an IP broadcast packet has the host portion of the destination IP address set to all ones and the network portion set to the address of the subnet. IP hosts, including devices, understand that packets, which contain an IP broadcast address as the destination address, are addressed to all IP hosts on the subnet. Unless specifically configured otherwise, devices do not forward IP broadcast packets, so IP broadcast communication is normally limited to a local subnet.

IP multicasting falls between IP unicast and IP broadcast communication. IP multicast communication enables a host to send IP packets to a group of hosts anywhere within the IP network. To send information to a specific group, IP multicast communication uses a special form of IP destination address called an IP multicast group address. The IP multicast group address is specified in the IP destination address field of the packet.

To multicast IP information, Layer 3 switches and devices must forward an incoming IP packet to all output interfaces that lead to members of the IP multicast group.

We tend to think of IP multicasting and video conferencing as the same thing. Although the first application in a network to use IP multicast is often video conferencing, video is only one of many IP multicast applications that can add value to a company's business model. Other IP multicast applications that have potential for improving productivity include multimedia conferencing, data replication, real-time data multicasts, and simulation applications.

Role of IP Multicast in Information Delivery

IP multicast is a bandwidth-conserving technology that reduces traffic by delivering a single stream of information simultaneously to potentially thousands of businesses and homes. Applications that take advantage of multicast include video conferencing, corporate communications, distance learning, and distribution of software, stock quotes, and news.

IP multicast routing enables a host (source) to send packets to a group of hosts (receivers) anywhere within the IP network by using a special form of IP address called the IP multicast group address. The sending host inserts the multicast group address into the IP destination address field of the packet and IP multicast routers and multilayer switches forward incoming IP multicast packets out all interfaces that lead to the members of the multicast group. Any host, regardless of whether it is a member of a group, can send to a group. However, only the members of a group receive the message.

IP Multicast Routing Protocols

The software supports the following protocols to implement IP multicast routing:

- IGMP is used between hosts on a LAN and the routers (and multilayer devices) on that LAN to track the multicast groups of which hosts are members. To participate in IP multicasting, multicast hosts, routers, and multilayer devices must have the Internet Group Management Protocol (IGMP) operating.
- Protocol Independent Multicast (PIM) is used between routers so that they can track which multicast packets to forward to each other and to their directly connected LANs.
- IGMP Snooping is used for multicasting in a Layer 2 switching environment. It helps reduce the flooding of multicast traffic by dynamically configuring Layer 2 interfaces so that multicast traffic is forwarded to only those interfaces associated with IP multicast devices.

This figure shows where these protocols operate within the IP multicast environment.

Figure 1: IP Multicast Routing Protocols



According to IPv4 multicast standards, the MAC destination multicast address begins with 0100:5e and is appended by the last 23 bits of the IP address. For example, if the IP destination address is 239.1.1.39, the MAC destination address is 0100:5e01:0127.

A multicast packet is unmatched when the destination IPv4 address does not match the destination MAC address. The device forwards the unmatched packet in hardware based upon the MAC address table. If the destination MAC address is not in the MAC address table, the device floods the packet to the all port in the same VLAN as the receiving port.

Internet Group Management Protocol

IGMP messages are used by IP multicast hosts to send their local Layer 3 switch or router a request to join a specific multicast group and begin receiving multicast traffic. With some extensions in IGMPv2, IP hosts can also send a request to a Layer 3 switch or router to leave an IP multicast group and not receive the multicast group traffic.

Using the information obtained by using IGMP, a Layer 3 switch or router maintains a list of multicast group memberships on a per-interface basis. A multicast group membership is active on an interface if at least one host on the interface sends an IGMP request to receive multicast group traffic.

Protocol-Independent Multicast

Protocol-Independent Multicast (PIM) is protocol independent because it can leverage whichever unicast routing protocol is used to populate the unicast routing table, including EIGRP, OSPF, BGP, or static route, to support IP multicast.

PIM also uses a unicast routing table to perform the reverse path forwarding (RPF) check function instead of building a completely independent multicast routing table. PIM does not send and receive multicast routing updates between routers like other routing protocols do.

PIM Sparse Mode

PIM Sparse Mode (PIM-SM) uses a pull model to deliver multicast traffic. Only networks with active receivers that have explicitly requested the data are forwarded the traffic. PIM-SM is intended for networks with several different multicasts, such as desktop video conferencing and collaborative computing, that go to a small number of receivers and are typically in progress simultaneously.

Rendezvous Point

If you configure PIM to operate in sparse mode, you must also choose one or more devices to be rendezvous points (RPs). Senders to a multicast group use RPs to announce their presence. Receivers of multicast packets use RPs to learn about new senders. You can configure Cisco IOS software so that packets for a single multicast group can use one or more RPs.

The RP address is used by first hop devices to send PIM register messages on behalf of a host sending a packet to the group. The RP address is also used by last hop devices to send PIM join and prune messages to the RP to inform it about group membership. You must configure the RP address on all devices (including the RP device).

A PIM device can be an RP for more than one group. Only one RP address can be used at a time within a PIM domain for the same group. The conditions specified by the access list determine for which groups the device is an RP (as different groups can have different RPs).

IGMP Snooping

IGMP snooping is used for multicasting in a Layer 2 switching environment. With IGMP snooping, a Layer 3 switch or router examines Layer 3 information in the IGMP packets in transit between hosts and a device. When the switch receives the IGMP Host Report from a host for a particular multicast group, the switch adds the host's port number to the associated multicast table entry. When the switch receives the IGMP Leave Group message from a host, it removes the host's port from the table entry.

Because IGMP control messages are transmitted as multicast packets, they are indistinguishable from multicast data if only the Layer 2 header is examined. A switch running IGMP snooping examines every multicast data packet to determine whether it contains any pertinent IGMP control information. If IGMP snooping is implemented on a low end switch with a slow CPU, performance could be severely impacted when data is transmitted at high rates.

IP Multicast Tables

The following illustration shows some key data structures that the device uses to forward IP multicast packets in hardware.

Figure 2: IP Multicast Tables and Protocols

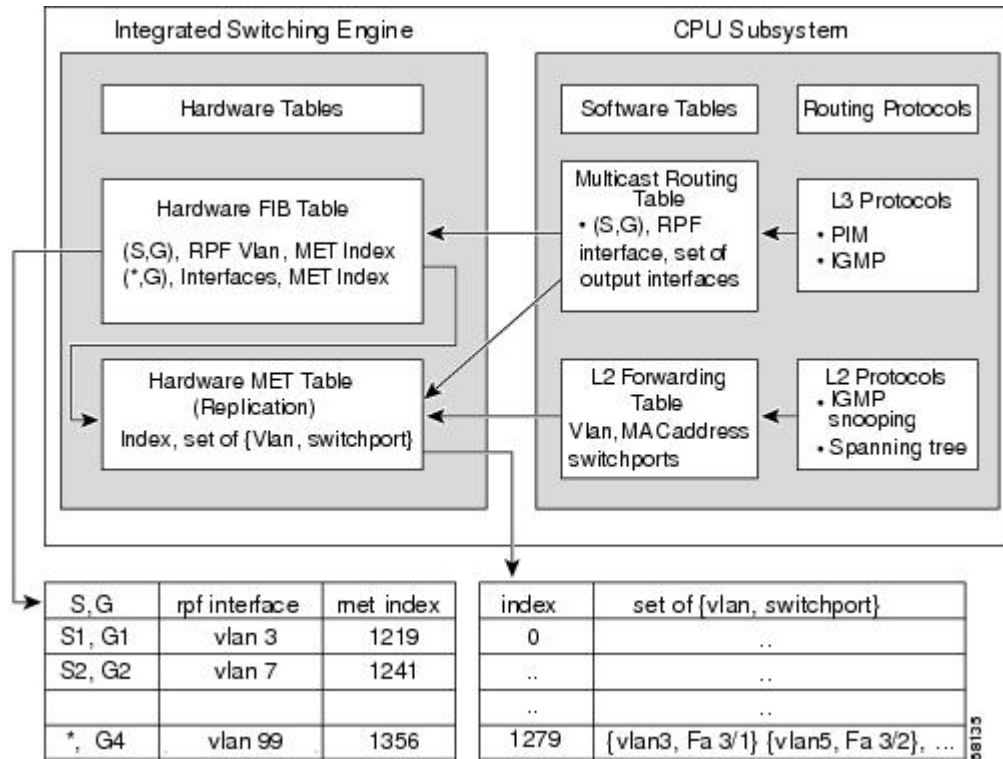

The Integrated Switching Engine maintains the hardware FIB table to identify individual IP multicast routes. Each entry consists of a destination group IP address and an optional source IP address. Multicast traffic flows on primarily two types of routes: (S,G) and (*,G). The (S,G) routes flow from a source to a group based on the IP address of the multicast source and the IP address of the multicast group destination. Traffic on a (*,G) route flows from the PIM RP to all receivers of group G. Only sparse-mode groups use (*,G) routes. The Integrated Switching Engine hardware contains space for a total of 128,000 routes, which are shared by unicast routes, multicast routes, and multicast fast-drop entries.

Output interface lists are stored in the multicast expansion table (MET). The MET has room for up to 32,000 output interface lists. (For RET, we can have up to 102 K entries (32 K used for floodsets, 70,000 used for multicast entries)). The MET resources are shared by both Layer 3 multicast routes and by Layer 2 multicast entries. The actual number of output interface lists available in hardware depends on the specific configuration. If the total number of multicast routes exceed 32,000, multicast packets might not be switched by the Integrated Switching Engine. They would be forwarded by the CPU subsystem at much slower speeds.



Note For RET, a maximum of 102 K entries is supported (32 K used for floodsets, 70 K used for multicast entries).

Hardware and Software Forwarding

The Integrated Switching Engine forwards the majority of packets in hardware at very high rates of speed. The CPU subsystem forwards exception packets in software. Statistical reports should show that the Integrated Switching Engine is forwarding the vast majority of packets in hardware.

The following illustration shows a logical view of the hardware and software forwarding components.

Figure 3: Hardware and Software Forwarding Components

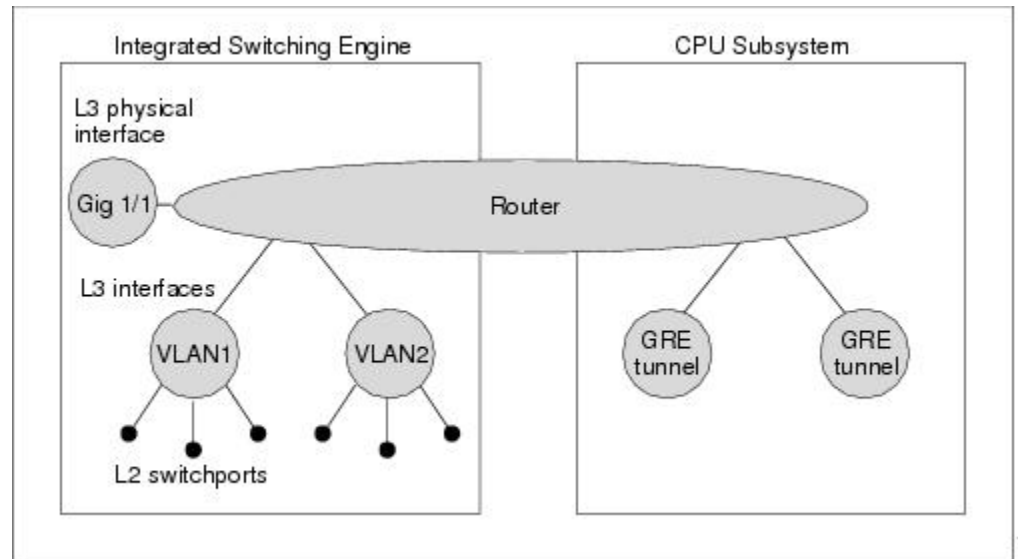

In the normal mode of operation, the Integrated Switching Engine performs inter-VLAN routing in hardware. The CPU subsystem supports generic routing encapsulation (GRE) tunnels for forwarding in software.

Replication is a particular type of forwarding where, instead of sending out one copy of the packet, the packet is replicated and multiple copies of the packet are sent out. At Layer 3, replication occurs only for multicast packets; unicast packets are never replicated to multiple Layer 3 interfaces. In IP multicasting, for each incoming IP multicast packet that is received, many replicas of the packet are sent out.

IP multicast packets can be transmitted on the following types of routes:

- Hardware routes
- Software routes
- Partial routes

Hardware routes occur when the Integrated Switching Engine hardware forwards all replicas of a packet. Software routes occur when the CPU subsystem software forwards all replicas of a packet. Partial routes occur when the Integrated Switching Engine forwards some of the replicas in hardware and the CPU subsystem forwards some of the replicas in software.

Partial Routes



Note The conditions listed below cause the replicas to be forwarded by the CPU subsystem software, but the performance of the replicas that are forwarded in hardware is not affected.

The following conditions cause some replicas of a packet for a route to be forwarded by the CPU subsystem:

- The switch is configured with the **ip igmp join-group** command as a member of the IP multicast group on the RPF interface of the multicast source.

- The switch is the first-hop to the source in PIM sparse mode. The switch must send PIM-register messages to the RP.

Software Routes



Note If any one of the following conditions is configured on the RPF interface or the output interface, all replication of the output is performed in software.

The following conditions cause all replicas of a packet for a route to be forwarded by the CPU subsystem software:

- The interface is configured with multicast helper.
- The interface is a generic routing encapsulation (GRE) or Distance Vector Multicast Routing Protocol (DVMRP) tunnel.
- The interface uses non-Advanced Research Products Agency (ARPA) encapsulation.

The following packets are always forwarded in software:

- Packets sent to multicast groups that fall into the range 224.0.0.* (where * is in the range from 0 to 255). This range is used by routing protocols. Layer 3 switching supports all other multicast group addresses.
- Packets with IP options.

Non-Reverse Path Forwarding Traffic

Traffic that fails an Reverse Path Forwarding (RPF) check is called non-RPF traffic. Non-RPF traffic is forwarded by the Integrated Switching Engine by filtering (persistently dropping) or rate limiting the non-RPF traffic.

In a redundant configuration where multiple Layer 3 switches or routers connect to the same LAN segment, only one device forwards the multicast traffic from the source to the receivers on the outgoing interfaces. The following illustration shows how non-RPF traffic can occur in a common network configuration.

Figure 4: Redundant Multicast Router Configuration in a Stub Network

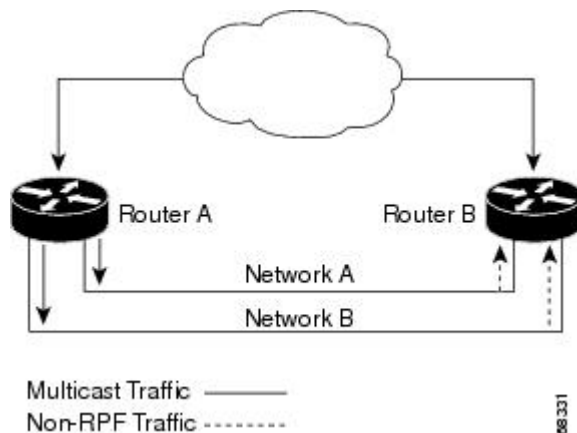

In this kind of topology, only Router A, the PIM designated router (PIM DR), forwards data to the common VLAN. Router B receives the forwarded multicast traffic, but must drop this traffic because it has arrived on the wrong interface and fails the RPF check. Traffic that fails the RPF check is called non-RPF traffic.

Multicast Group Transmission Scheme

IP communication consists of hosts that act as senders and receivers of traffic as shown in the first figure. Senders are called sources. Traditional IP communication is accomplished by a single host source sending packets to another single host (unicast transmission) or to all hosts (broadcast transmission). IP multicast provides a third scheme, allowing a host to send packets to a subset of all hosts (multicast transmission). This subset of receiving hosts is called a multicast group. The hosts that belong to a multicast group are called group members.

Multicast is based on this group concept. A multicast group is an arbitrary number of receivers that join a group in order to receive a particular data stream. This multicast group has no physical or geographical boundaries--the hosts can be located anywhere on the Internet or on any private internetwork. Hosts that are interested in receiving data from a source to a particular group must join that group. Joining a group is accomplished by a host receiver by way of the Internet Group Management Protocol (IGMP).

In a multicast environment, any host, regardless of whether it is a member of a group, can send to a group. However, only the members of a group can receive packets sent to that group. Multicast packets are delivered to a group using best-effort reliability, just like IP unicast packets.

Unicast transmission—One host sends and the other receives.



Broadcast transmission—One sender to all receivers.

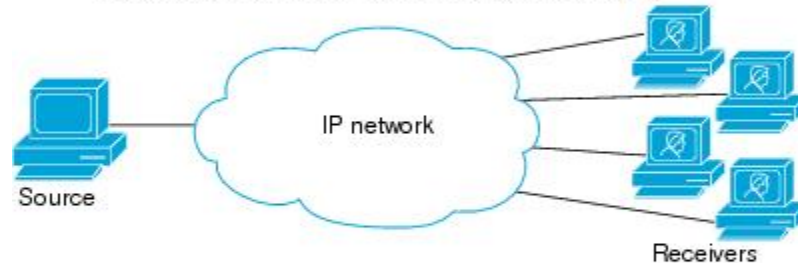

Multicast transmission—One sender to a group of receivers.

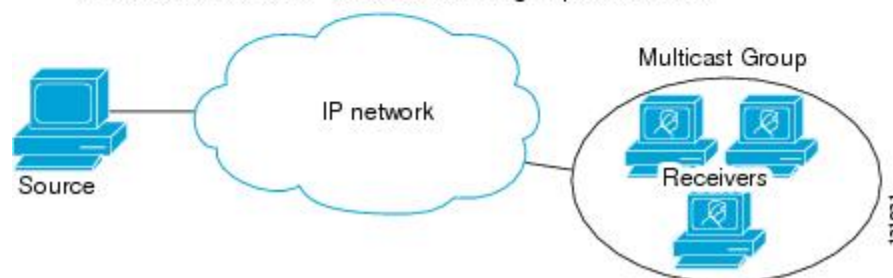

In the next figure, the receivers (the designated multicast group) are interested in receiving the video data stream from the source. The receivers indicate their interest by sending an IGMP host report to the routers in the network. The routers are then responsible for delivering the data from the source to the receivers. The routers use Protocol Independent Multicast (PIM) to dynamically create a multicast distribution tree. The video data stream will then be delivered only to the network segments that are in the path between the source and the receivers.

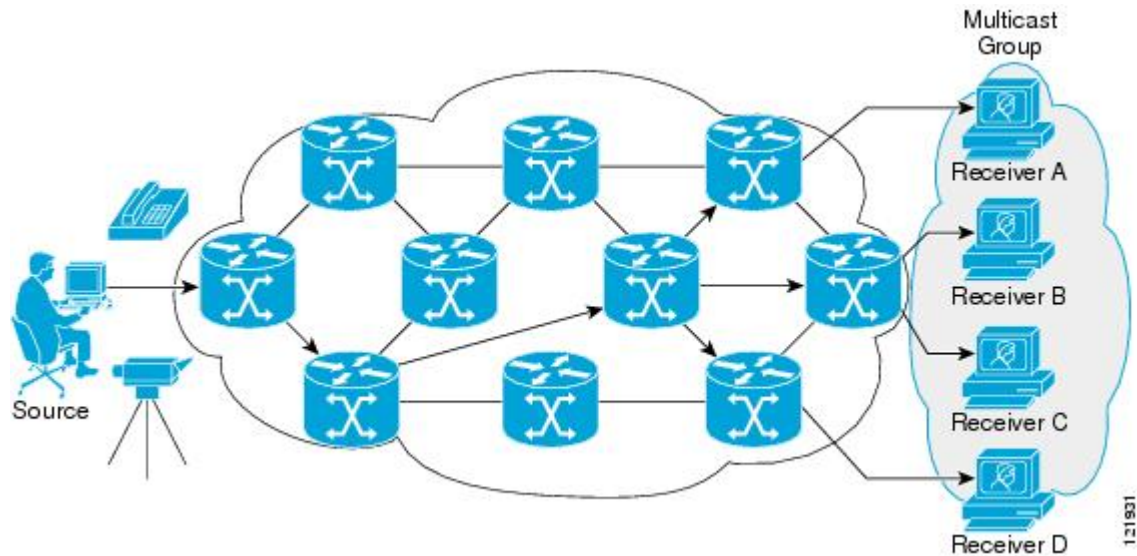

IP Multicast Boundary

As shown in the figure, address scoping defines domain boundaries so that domains with RPs that have the same IP address do not leak into each other. Scoping is performed on the subnet boundaries within large domains and on the boundaries between the domain and the Internet.

Figure 5: Address Scoping at Boundaries

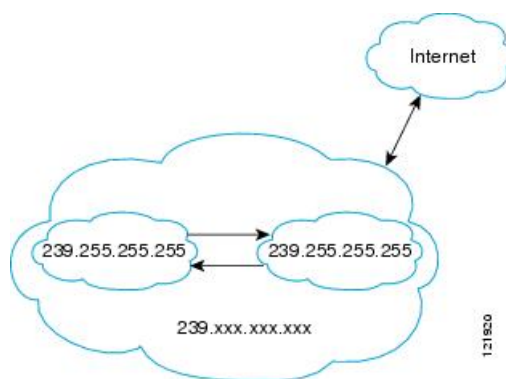

You can set up an administratively scoped boundary on an interface for multicast group addresses using the **ip multicast boundary** command with the *access-list* argument. A standard access list defines the range of addresses affected. When a boundary is set up, no multicast data packets are allowed to flow across the boundary from either direction. The boundary allows the same multicast group address to be reused in different administrative domains.

The Internet Assigned Numbers Authority (IANA) has designated the multicast address range 239.0.0.0 to 239.255.255.255 as the administratively scoped addresses. This range of addresses can be reused in domains administered by different organizations. They would be considered local, not globally unique.

You can configure the **filter-autorp** keyword to examine and filter Auto-RP discovery and announcement messages at the administratively scoped boundary. Any Auto-RP group range announcements from the Auto-RP packets that are denied by the boundary access control list (ACL) are removed. An Auto-RP group range announcement is permitted and passed by the boundary only if all addresses in the Auto-RP group range are permitted by the boundary ACL. If any address is not permitted, the entire group range is filtered and removed from the Auto-RP message before the Auto-RP message is forwarded.

IP Multicast Group Addressing

A multicast group is identified by its multicast group address. Multicast packets are delivered to that multicast group address. Unlike unicast addresses that uniquely identify a single host, multicast IP addresses do not identify a particular host. To receive the data sent to a multicast address, a host must join the group that address identifies. The data is sent to the multicast address and received by all the hosts that have joined the group indicating that they wish to receive traffic sent to that group. The multicast group address is assigned to a group at the source. Network administrators who assign multicast group addresses must make sure the addresses conform to the multicast address range assignments reserved by the Internet Assigned Numbers Authority (IANA).

IP Class D Addresses

IP multicast addresses have been assigned to the IPv4 Class D address space by IANA. The high-order four bits of a Class D address are 1110. Therefore, host group addresses can be in the range 224.0.0.0 to 239.255.255.255. A multicast address is chosen at the source (sender) for the receivers in a multicast group.



Note The Class D address range is used only for the group address or destination address of IP multicast traffic. The source address for multicast datagrams is always the unicast source address.

IP Multicast Address Scoping

The multicast address range is subdivided to provide predictable behavior for various address ranges and for address reuse within smaller domains. The table provides a summary of the multicast address ranges. A brief summary description of each range follows.

Table 1: Multicast Address Range Assignments

Name	Range	Description
Reserved Link-Local Addresses	224.0.0.0 to 224.0.0.255	Reserved for use by network protocols on a local network segment.
Globally Scoped Addresses	224.0.1.0 to 238.255.255.255	Reserved to send multicast data between organizations and across the Internet.
Source Specific Multicast	232.0.0.0 to 232.255.255.255	Reserved for use with the SSM datagram delivery model where data is forwarded only to receivers that have explicitly joined the group.

Name	Range	Description
GLOP Addresses	233.0.0.0 to 233.255.255.255	Reserved for statically defined addresses by organizations that already have an assigned autonomous system (AS) domain number.
Limited Scope Address	239.0.0.0 to 239.255.255.255	Reserved as administratively or limited scope addresses for use in private multicast domains.

Reserved Link-Local Addresses

The IANA has reserved the range 224.0.0.0 to 224.0.0.255 for use by network protocols on a local network segment. Packets with an address in this range are local in scope and are not forwarded by IP routers. Packets with link local destination addresses are typically sent with a time-to-live (TTL) value of 1 and are not forwarded by a router.

Within this range, reserved link-local addresses provide network protocol functions for which they are reserved. Network protocols use these addresses for automatic router discovery and to communicate important routing information. For example, Open Shortest Path First (OSPF) uses the IP addresses 224.0.0.5 and 224.0.0.6 to exchange link-state information.

IANA assigns single multicast address requests for network protocols or network applications out of the 224.0.1.xxx address range. Multicast routers forward these multicast addresses.



Note All the packets with reserved link-local addresses are punted to CPU by default in the ASR 903 RSP2 Module.

Globally Scoped Addresses

Addresses in the range 224.0.1.0 to 238.255.255.255 are called globally scoped addresses. These addresses are used to send multicast data between organizations across the Internet. Some of these addresses have been reserved by IANA for use by multicast applications. For example, the IP address 224.0.1.1 is reserved for Network Time Protocol (NTP).

Source Specific Multicast Addresses

Addresses in the range 232.0.0.0/8 are reserved for Source Specific Multicast (SSM) by IANA. In Cisco IOS software, you can use the `ip pim ssm` command to configure SSM for arbitrary IP multicast addresses also. SSM is an extension of Protocol Independent Multicast (PIM) that allows for an efficient data delivery mechanism in one-to-many communications. SSM is described in the [IP Multicast Delivery Modes, on page 13](#) section.

GLOP Addresses

GLOP addressing (as proposed by RFC 2770, GLOP Addressing in 233/8) proposes that the 233.0.0.0/8 range be reserved for statically defined addresses by organizations that already have an AS number reserved. This practice is called GLOP addressing. The AS number of the domain is embedded into the second and third octets of the 233.0.0.0/8 address range. For example, AS 62010 is written in hexadecimal format as F23A. Separating the two octets F2 and 3A results in 242 and 58 in decimal format. These values result in a subnet of 233.242.58.0/24 that would be globally reserved for AS 62010 to use.

Limited Scope Addresses

The range 239.0.0.0 to 239.255.255.255 is reserved as administratively or limited scoped addresses for use in private multicast domains. These addresses are constrained to a local group or organization. Companies, universities, and other organizations can use limited scope addresses to have local multicast applications that will not be forwarded outside their domain. Routers typically are configured with filters to prevent multicast traffic in this address range from flowing outside an autonomous system (AS) or any user-defined domain. Within an AS or domain, the limited scope address range can be further subdivided so that local multicast boundaries can be defined.



Note Network administrators may use multicast addresses in this range, inside a domain, without conflicting with others elsewhere in the Internet.

Layer 2 Multicast Addresses

Historically, network interface cards (NICs) on a LAN segment could receive only packets destined for their burned-in MAC address or the broadcast MAC address. In IP multicast, several hosts need to be able to receive a single data stream with a common destination MAC address. Some means had to be devised so that multiple hosts could receive the same packet and still be able to differentiate between several multicast groups. One method to accomplish this is to map IP multicast Class D addresses directly to a MAC address. Using this method, NICs can receive packets destined to many different MAC address.

Cisco Group Management Protocol (CGMP) is used on routers connected to Catalyst switches to perform tasks similar to those performed by IGMP. CGMP is necessary for those Catalyst switches that cannot distinguish between IP multicast data packets and IGMP report messages, both of which are addressed to the same group address at the MAC level.

Cisco Express Forwarding, MFIB, and Layer 2 Forwarding

The implementation of IP multicast is an extension of centralized Cisco Express Forwarding. Cisco Express Forwarding extracts information from the unicast routing table, which is created by unicast routing protocols, such as BGP, OSPF, and EIGRP and loads it into the hardware

Forwarding Information Base (FIB). With the unicast routes in the FIB, when a route is changed in the upper-layer routing table, only one route needs to be changed in the hardware routing state. To forward unicast packets in hardware, the Integrated Switching Engine looks up source and destination routes in ternary content addressable memory (TCAM), takes the adjacency index from the hardware FIB, and gets the Layer 2 rewrite information and next-hop address from the hardware adjacency table.

The new Multicast Forwarding Information Base (MFIB) subsystem is the multicast analog of the unicast Cisco Express Forwarding. The MFIB subsystem extracts the multicast routes that PIM and IGMP create and refines them into a protocol-independent format for forwarding in hardware. The MFIB subsystem removes the protocol-specific information and leaves only the essential forwarding information. Each entry in the MFIB table consists of an (S,G) or (*,G) route, an input RPF VLAN, and a list of Layer 3 output interfaces. The MFIB subsystem, together with platform-dependent management software, loads this multicast routing information into the hardware FIB and Replica Expansion Table (RET). The device performs Layer 3 routing and Layer 2 bridging at the same time. There can be multiple Layer 2 switch ports on any VLAN interface.

The following illustration shows a functional overview of how a Cisco device combines unicast routing, multicast routing, and Layer 2 bridging information to forward in hardware:

Figure 6: Combining Cisco Express Forwarding, MFIB, and Layer 2 Forwarding Information in Hardware

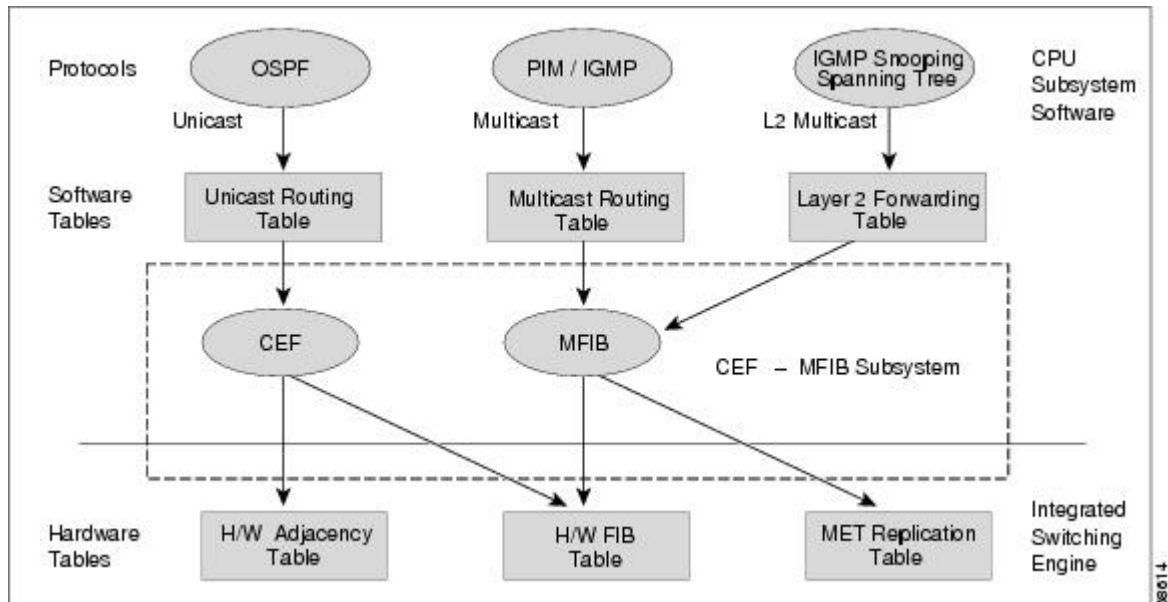

Like the Cisco Express Forwarding unicast routes, the MFIB routes are Layer 3 and must be merged with the appropriate Layer 2 information. The following example shows an MFIB route:

```
(* ,203.0.113.1)
RPF interface is Vlan3
Output Interfaces are:
Vlan 1
Vlan 2
```

The route (*,203.0.113.1) is loaded in the hardware FIB table and the list of output interfaces is loaded into the MET. A pointer to the list of output interfaces, the MET index, and the RPF interface are also loaded in the hardware FIB with the (*,203.0.113.1) route. With this information loaded in hardware, merging of the Layer 2 information can begin. For the output interfaces on VLAN1, the Integrated Switching Engine must send the packet to all switch ports in VLAN1 that are in the spanning tree forwarding state. The same process applies to VLAN 2. To determine the set of switch ports in VLAN 2, the Layer 2 Forwarding Table is used.

When the hardware routes a packet, in addition to sending it to all of the switch ports on all output interfaces, the hardware also sends the packet to all switch ports (other than the one it arrived on) in the input VLAN. For example, assume that VLAN 3 has two switch ports in it, GigabitEthernet 3/1 and GigabitEthernet 3/2. If a host on GigabitEthernet 3/1 sends a multicast packet, the host on GigabitEthernet 3/2 might also need to receive the packet. To send a multicast packet to the host on GigabitEthernet 3/2, all of the switch ports in the ingress VLAN must be added to the port set that is loaded in the MET.

If VLAN 1 contains 1/1 and 1/2, VLAN 2 contains 2/1 and 2/2, and VLAN 3 contains 3/1 and 3/2, the MET chain for this route would contain these switch ports: (1/1,1/2,2/1,2/2,3/1, and 3/2).

If IGMP snooping is on, the packet should not be forwarded to all output switch ports on VLAN 2. The packet should be forwarded only to switch ports where IGMP snooping has determined that there is either a group member or router. For example, if VLAN 1 had IGMP snooping enabled, and IGMP snooping determined that only port 1/2 had a group member on it, then the MET chain would contain these switch ports: (1/1,1/2, 2/1, 2/2, 3/1, and 3/2).

IP Multicast Delivery Modes

IP multicast delivery modes differ only for the receiver hosts, not for the source hosts. A source host sends IP multicast packets with its own IP address as the IP source address of the packet and a group address as the IP destination address of the packet.

Source Specific Multicast

Source Specific Multicast (SSM) is a datagram delivery model that best supports one-to-many applications, also known as broadcast applications. SSM is a core network technology for the Cisco implementation of IP multicast targeted for audio and video broadcast application environments.

For the SSM delivery mode, an IP multicast receiver host must use IGMP Version 3 (IGMPv3) to subscribe to channel (S,G). By subscribing to this channel, the receiver host is indicating that it wants to receive IP multicast traffic sent by source host S to group G. The network will deliver IP multicast packets from source host S to group G to all hosts in the network that have subscribed to the channel (S, G).

SSM does not require group address allocation within the network, only within each source host. Different applications running on the same source host must use different SSM groups. Different applications running on different source hosts can arbitrarily reuse SSM group addresses without causing any excess traffic on the network.

Multicast Fast Drop

In IP multicast protocols, such as PIM-SM and PIM-DM, every (S,G) or (*,G) route has an incoming interface associated with it. This interface is referred to as the reverse path forwarding interface. In some cases, when a packet arrives on an interface other than the expected RPF interface, the packet must be forwarded to the CPU subsystem software to allow PIM to perform special protocol processing on the packet. One example of this special protocol processing that PIM performs is the PIM Assert protocol.

By default, the Integrated Switching Engine hardware sends all packets that arrive on a non-RPF interface to the CPU subsystem software. However, processing in software is not necessary in many cases, because these non-RPF packets are often not needed by the multicast routing protocols. The problem is that if no action is taken, the non-RPF packets that are sent to the software can overwhelm the CPU.

Instead of installing fast-drop entries, the Cisco device uses Dynamic Buffer Limiting (DBL). This flow-based congestion avoidance mechanism provides active queue management by tracking the queue length for each traffic flow. When the queue length of a flow exceeds its set limit, DBL drops packets. Rate DBL limits the non-rpf traffic to the cpu subsystem so that the CPU is not overwhelmed. The packets are rate limited per flow to the CPU. Because installing fast-drop entries in the CAM is inaccessibly, the number of fast-drop flows that can be handled by the switch need not be limited.

Protocol events, such as a link going down or a change in the unicast routing table, can impact the set of packets that can safely be fast dropped. A packet that was correctly fast dropped before might, after a topology change, need to be forwarded to the CPU subsystem software so that PIM can process it. The CPU subsystem software handles flushing fast-drop entries in response to protocol events so that the PIM code in IOS can process all the necessary RPF failures.

The use of fast-drop entries in the hardware is critical in some common topologies because you may have persistent RPF failures. Without the fast-drop entries, the CPU is exhausted by RPF failed packets that it did not need to process.

Multicast Forwarding Information Base

The Multicast Forwarding Information Base (MFIB) subsystem supports IP multicast routing in the Integrated Switching Engine hardware on Cisco devices. The MFIB logically resides between the IP multicast routing protocols in the CPU subsystem software (PIM, IGMP, MSDP, MBGP, and DVMRP) and the platform-specific code that manages IP multicast routing in hardware. The MFIB translates the routing table information created by the multicast routing protocols into a simplified format that can be efficiently processed and used for forwarding by the Integrated Switching Engine hardware.

To display the information in the multicast routing table, use the **show ip mroute** command. To display the MFIB table information, use the **show ip mfib** command.

The MFIB table contains a set of IP multicast routes. IP multicast routes include (S,G) and (*,G). Each route in the MFIB table can have one or more optional flags associated with it. The route flags indicate how a packet that matches a route should be forwarded. For example, the Internal Copy (IC) flag on an MFIB route indicates that a process on the switch needs to receive a copy of the packet. The following flags can be associated with MFIB routes:

- Internal Copy (IC) flag—Sets on a route when a process on the router needs to receive a copy of all packets matching the specified route.
- Signalling (S) flag—Sets on a route when a process needs to be notified when a packet matching the route is received; the expected behavior is that the protocol code updates the MFIB state in response to receiving a packet on a signalling interface.
- Connected (C) flag—When set on an MFIB route, has the same meaning as the Signaling (S) flag, except that the C flag indicates that only packets sent by directly connected hosts to the route should be signaled to a protocol process.

A route can also have a set of optional flags associated with one or more interfaces. For example, an (S,G) route with the flags on VLAN 1 indicates how packets arriving on VLAN 1 should be handled, and whether packets matching the route should be forwarded onto VLAN 1. The per-interface flags supported in the MFIB include the following:

- Accepting (A)—Sets on the interface that is known in multicast routing as the RPF interface. A packet that arrives on an interface that is marked as Accepting (A) is forwarded to all Forwarding (F) interfaces.
- Forwarding (F)—Used in conjunction with the Accepting (A) flag as described above. The set of Forwarding interfaces that form what is often referred to as the multicast “olist” or output interface list.
- Signaling (S)—Sets on an interface when some multicast routing protocol process in Cisco IOS needs to be notified of packets arriving on that interface.



Note When PIM-SM routing is in use, the MFIB route might include an interface as in this example:

```
PimTunnel [1.2.3.4]
```

It is a virtual interface that the MFIB subsystem creates to indicate that packets are being tunnelled to the specified destination address. A PimTunnel interface cannot be displayed with the normal **show interface** command.

S/M, 224/4

An (S/M, 224/4) entry is created in the MFIB for every multicast-enabled interface. This entry ensures that all packets sent by directly connected neighbors can be register-encapsulated to the PIM-SM RP. Typically, only a small number of packets are forwarded using the (S/M,224/4) route, until the (S,G) route is established by PIM-SM.

For example, on an interface with IP address 10.0.0.1 and netmask 255.0.0.0, a route is created matching all IP multicast packets in which the source address is anything in the class A network 10. This route can be written in conventional subnet/masklength notation as (10/8,224/4). If an interface has multiple assigned IP addresses, then one route is created for each such IP address.

Multicast High Availability

Cisco Catalyst 9500 Series Switches support multicast high availability, which ensures uninterrupted multicast traffic flow if a supervisor engine failure. MFIB states are synced to the standby supervisor engine before a switchover, ensuring NSF availability with a fast convergence upon switchover during a supervisor engine failure.



Note For Cisco IOS XE Fuji 16.8.x and Cisco IOS XE Fuji 16.9.x, multicast high availability is not supported on C9500-32C, C9500-32QC, C9500-48Y4C, and C9500-24Y4C models of the Cisco Catalyst 9500 Series Switches.

Beginning from Cisco IOS XE Gibraltar 16.10.x, multicast high availability is supported on C9500-32C, C9500-32QC, C9500-48Y4C, and C9500-24Y4C models of the Cisco Catalyst 9500 Series Switches.

Multicast HA (SSO / NSF / ISSU) is supported for the PIM Sparse mode and SSM mode; and in Layer 2 for IGMP and MLD Snooping.

Additional References for IP Multicast

Related Documents

Related Topic	Document Title
For complete syntax and usage information for the commands used in this chapter.	See the IP Multicast Routing Commands section of the <i>Command Reference (Catalyst 9500 Series Switches)</i>

Standards and RFCs

Standard/RFC	Title
RFC 1112	<i>Host Extensions for IP Multicasting</i>
RFC 2236	<i>Internet Group Management Protocol, Version 2</i>
RFC 4601	<i>Protocol-Independent Multicast-Sparse Mode (PIM-SM): Protocol Specification</i>

Feature History and Information for IP Multicast

The following table provides release information about the feature or features described in this module. This table lists only the software release that introduced support for a given feature in a given software release train. Unless noted otherwise, subsequent releases of that software release train also support that feature.

Use Cisco Feature Navigator to find information about platform support and Cisco software image support. To access Cisco Feature Navigator, go to www.cisco.com/go/cfn. An account on Cisco.com is not required.

Table 2: Feature Information for IP Multicast

Feature Name	Releases	Feature Information
IP Multicast	Cisco IOS XE Everest 16.5.1a	IP multicast routing enables a host (source) to send packets to a group of hosts (receivers) anywhere within the IP network by using a special form of IP address called the IP multicast group address.