



Configuring Protocol Independent Multicast (PIM)

- [Prerequisites for PIM, on page 1](#)
- [Restrictions for PIM, on page 2](#)
- [Information about PIM, on page 4](#)
- [How to Configure PIM, on page 21](#)
- [Verifying PIM Operations, on page 47](#)
- [Monitoring and Troubleshooting PIM, on page 56](#)
- [Configuration Examples for PIM, on page 58](#)
- [Feature History for PIM, on page 61](#)

Prerequisites for PIM

Before you begin the PIM configuration process, decide which PIM mode to use. This is based on the applications you intend to support on your network. Use the following guidelines:

- In general, if the application is one-to-many or many-to-many in nature, then PIM-SM can be used successfully.
- For optimal one-to-many application performance, SSM is appropriate but requires IGMP version 3 support.

Before you configure PIM stub routing, check that you have met these conditions:

- You must have IP multicast routing configured on both the stub router and the central router. You must also have PIM mode configured on the uplink interface of the stub router.
- You must also configure either Enhanced Interior Gateway Routing Protocol (EIGRP) stub routing or Open Shortest Path First (OSPF) stub routing on the device.
- The PIM stub router does not route the transit traffic between the distribution routers. Unicast (EIGRP) stub routing enforces this behavior. You must configure unicast stub routing to assist the PIM stub router behavior.

Restrictions for PIM

The following are the restrictions for configuring PIM:

- Use ACLs to designate a specified port only as a multicast host port and not as a multicast router port. Multicast router control-packets received on this port are dropped.
- PIM nonbroadcast multiaccess (NBMA) mode is not supported on an ethernet interface.
- Hot Standby Router Protocol-aware (HSRP-aware) PIM is not supported.

PIMv1 and PIMv2 Interoperability

To avoid misconfiguring multicast routing on your device, review the information in this section.

The Cisco PIMv2 implementation provides interoperability and transition between Version 1 and Version 2, although there might be some minor problems.

You can upgrade to PIMv2 incrementally. PIM Versions 1 and 2 can be configured on different routers and multilayer switches within one network. Internally, all routers and multilayer switches on a shared media network must run the same PIM version. Therefore, if a PIMv2 device detects a PIMv1 device, the Version 2 device downgrades itself to Version 1 until all Version 1 devices have been shut down or upgraded.

PIMv2 uses the BSR to discover and announce RP-set information for each group prefix to all the routers and multilayer switches in a PIM domain. PIMv1, together with the Auto-RP feature, can perform the same tasks as the PIMv2 BSR. However, Auto-RP is a standalone protocol, separate from PIMv1, and is a proprietary Cisco protocol. PIMv2 is a standards track protocol in the IETF.



Note We recommend that you use PIMv2. The BSR function interoperates with Auto-RP on Cisco routers and multilayer switches.

When PIMv2 devices interoperate with PIMv1 devices, Auto-RP should have already been deployed. A PIMv2 BSR that is also an Auto-RP mapping agent automatically advertises the RP elected by Auto-RP. That is, Auto-RP sets its single RP on every router or multilayer switch in the group. Not all routers and switches in the domain use the PIMv2 hash function to select multiple RPs.

Sparse-mode groups in a mixed PIMv1 and PIMv2 region are possible because the Auto-RP feature in PIMv1 interoperates with the PIMv2 RP feature. Although all PIMv2 devices can also use PIMv1, we recommend that the RPs be upgraded to PIMv2. To ease the transition to PIMv2, we recommend:

- Using Auto-RP throughout the region.

If Auto-RP is not already configured in the PIMv1 regions, configure Auto-RP.

Restrictions for Bidirectional PIM

Phantom rendezvous point (RP) is not supported.

Restrictions for Configuring PIM Stub Routing

- Only directly connected multicast (IGMP) receivers and sources are allowed in the Layer 2 access domains. The PIM protocol is not supported in access domains.
- In a network using PIM stub routing, the only allowable route for IP traffic to the user is through a device that is configured with PIM stub routing.
- The redundant PIM stub router topology is not supported. Only the nonredundant access router topology is supported by the PIM stub feature.

Restrictions for Configuring Auto-RP and BSR

Take into consideration your network configuration, and the following restrictions when configuring Auto-RP and BSR:

Restrictions for Configuring Auto-RP

The following are restrictions for configuring Auto-RP (if used in your network configuration):

- If routed interfaces are configured in sparse mode, Auto-RP can still be used if all devices are configured with a manual RP address for the Auto-RP groups.
- If routed interfaces are configured in sparse mode and you enter the **ip pim autorp listener** global configuration command, Auto-RP can still be used even if all devices are not configured with a manual RP address for the Auto-RP groups.

Restrictions for Configuring BSR

The following are the restrictions for configuring BSR (if used in your network configuration):

- Configure the candidate BSRs as the RP-mapping agents for Auto-RP.
- For group prefixes advertised through Auto-RP, the PIMv2 BSR mechanism should not advertise a subrange of these group prefixes served by a different set of RPs. In a mixed PIMv1 and PIMv2 domain, have backup RPs serve the same group prefixes. This prevents the PIMv2 DRs from selecting a different RP from those PIMv1 DRs, due to the longest match lookup in the RP-mapping database.

Restrictions and Guidelines for Configuring Auto-RP and BSR

The following are restrictions for configuring Auto-RP and BSR (if used in your network configuration):

- If your network is all Cisco routers and multilayer switches, you can use either Auto-RP or BSR.
- If you have non-Cisco routers in your network, you must use BSR.
- If you have Cisco PIMv1 and PIMv2 routers and multilayer switches and non-Cisco routers, you must use both Auto-RP and BSR. If your network includes routers from other vendors, configure the Auto-RP mapping agent and the BSR on a Cisco PIMv2 device. Ensure that no PIMv1 device is located in the path between the BSR and a non-Cisco PIMv2 device.



Note There are two approaches to using PIMv2. You can use Version 2 exclusively in your network or migrate to Version 2 by employing a mixed PIM version environment.

- Because bootstrap messages are sent hop-by-hop, a PIMv1 device prevents these messages from reaching all routers and multilayer switches in your network. Therefore, if your network has a PIMv1 device in it and only Cisco routers and multilayer switches, it is best to use Auto-RP.
- If you have a network that includes non-Cisco routers, configure the Auto-RP mapping agent and the BSR on a Cisco PIMv2 router or multilayer switch. Ensure that no PIMv1 device is on the path between the BSR and a non-Cisco PIMv2 router.
- If you have non-Cisco PIMv2 routers that need to interoperate with Cisco PIMv1 routers and multilayer switches, both Auto-RP and a BSR are required. We recommend that a Cisco PIMv2 device be both the Auto-RP mapping agent and the BSR.

Restrictions for Auto-RP Enhancement

The simultaneous deployment of Auto-RP and bootstrap router (BSR) is not supported.

Information about PIM

Protocol Independent Multicast Overview

The Protocol Independent Multicast (PIM) protocol maintains the current IP multicast service mode of receiver-initiated membership. PIM is not dependent on a specific unicast routing protocol; it is IP routing protocol independent and can leverage whichever unicast routing protocols are used to populate the unicast routing table, including Enhanced Interior Gateway Routing Protocol (EIGRP), Open Shortest Path First (OSPF), Border Gateway Protocol (BGP), and static routes. PIM uses unicast routing information to perform the multicast forwarding function.

Although PIM is called a multicast routing protocol, it actually uses the unicast routing table to perform the reverse path forwarding (RPF) check function instead of building up a completely independent multicast routing table. Unlike other routing protocols, PIM does not send and receive routing updates between routers.

PIM is defined in RFC 4601, Protocol Independent Multicast - Sparse Mode (PIM-SM)

PIM Versions

PIMv2 includes these improvements over PIMv1:

- A single, active rendezvous point (RP) exists per multicast group, with multiple backup RPs. This single RP compares to multiple active RPs for the same group in PIMv1.
- A bootstrap router (BSR) provides a fault-tolerant, automated RP discovery and distribution function that enables routers and multilayer switches to dynamically learn the group-to-RP mappings.
- PIM join and prune messages have more flexible encoding for multiple address families.

- A more flexible hello packet format replaces the query packet to encode current and future capability options.
- Register messages sent to an RP specify whether they are sent by a border router or a designated router.
- PIM packets are no longer inside IGMP packets; they are standalone packets.

Multicast Source Discovery Protocol (MSDP)

Multicast Source Discovery Protocol (MSDP) is used for inter-domain source discovery when PIM SM is used. Each PIM administrative domain has its own RP. In order for the RP in one domain to signal new sources to the RP in the other domain, MSDP is used.

When RP in a domain receives a PIM register message for a new source, with MSDP configured it sends a new source-active (SA) message to all its MSDP peers in other domains. Each intermediate MSDP peer floods this SA message away from the originating RP. The MSDP peers install this SA message in their MSDP sa-cache. If the RPs in other domains have any join requests for the group in the SA message (indicated by the presence of a (*,G) entry with non empty outgoing interface list), the domain is interested in the group, and the RP triggers an (S,G) join toward the source.

PIM Sparse Mode

PIM sparse mode (PIM-SM) uses a pull model to deliver multicast traffic. Only network segments with active receivers that have explicitly requested the data will receive the traffic.

Sparse mode interfaces are added to the multicast routing table only when periodic Join messages are received from downstream routers, or when a directly connected member is on the interface. When forwarding from a LAN, sparse mode operation occurs if an RP is known for the group. If so, the packets are encapsulated and sent toward the RP. If the multicast traffic from a specific source is sufficient, the first hop router of the receiver may send Join messages toward the source to build a source-based distribution tree.

PIM-SM distributes information about active sources by forwarding data packets on the shared tree. Because PIM-SM uses shared trees (at least, initially), it requires the use of a rendezvous point (RP). The RP must be administratively configured in the network. See the [Rendezvous Points, on page 10](#) section for more information.

In sparse mode, a router assumes that other routers do not want to forward multicast packets for a group, unless there is an explicit request for the traffic. When hosts join a multicast group, the directly connected routers send PIM Join messages toward the RP. The RP keeps track of multicast groups. Hosts that send multicast packets are registered with the RP by the first hop router of that host. The RP then sends Join messages toward the source. At this point, packets are forwarded on a shared distribution tree. If the multicast traffic from a specific source is sufficient, the first hop router of the host may send Join messages toward the source to build a source-based distribution tree.

Sources register with the RP and then data is forwarded down the shared tree to the receivers. The edge routers learn about a particular source when they receive data packets on the shared tree from that source through the RP. The edge router then sends PIM (S,G) Join messages toward that source. Each router along the reverse path compares the unicast routing metric of the RP address to the metric of the source address. If the metric for the source address is better, it will forward a PIM (S,G) Join message toward the source. If the metric for the RP is the same or better, then the PIM (S,G) Join message will be sent in the same direction as the RP. In this case, the shared tree and the source tree would be considered congruent.

If the shared tree is not an optimal path between the source and the receiver, the routers dynamically create a source tree and stop traffic from flowing down the shared tree. This behavior is the default behavior in

software. Network administrators can force traffic to stay on the shared tree by using the **ip pim spt-threshold infinity** command.

PIM-SM scales well to a network of any size, including those with WAN links. The explicit join mechanism prevents unwanted traffic from flooding the WAN links.

Bidirectional PIM

Bidirectional PIM is a variant of the PIM suite of routing protocols for IP multicast. In PIM, packet traffic for a multicast group is routed according to the rules of the mode configured for that multicast group.

In bidirectional mode, traffic is routed only along a bidirectional shared tree that is rooted at the rendezvous point (RP) for the group. In bidir-PIM, the IP address of the RP acts as the key to having all routers establish a loop-free spanning tree topology rooted in that IP address. This IP address need not be a router, but can be any unassigned IP address on a network that is reachable throughout the PIM domain. This technique is the preferred configuration method for establishing a redundant RP configuration for bidir-PIM.

Membership to a bidirectional group is signalled via explicit join messages. Traffic from sources is unconditionally sent up the shared tree toward the RP and passed down the tree toward the receivers on each branch of the tree.

Bidir-PIM is designed to be used for many-to-many applications within individual PIM domains. Multicast groups in bidirectional mode can scale to an arbitrary number of sources without incurring overhead due to the number of sources.

PIM-SM cannot forward traffic in the upstream direction of a tree, because it only accepts traffic from one Reverse Path Forwarding (RPF) interface. This interface (for the shared tree) points toward the RP, therefore allowing only downstream traffic flow. In this case, upstream traffic is first encapsulated into unicast register messages, which are passed from the designated router (DR) of the source toward the RP. In a second step, the RP joins an SPT that is rooted at the source. Therefore, in PIM-SM, traffic from sources traveling toward the RP does not flow upstream in the shared tree, but downstream along the SPT of the source until it reaches the RP. From the RP, traffic flows along the shared tree toward all receivers.

Bidir-PIM is derived from the mechanisms of PIM-SM and shares many shortest-path tree (SPT) operations. Bidir-PIM also has unconditional forwarding of source traffic toward the RP upstream on the shared tree, but no registering process for sources as in PIM-SM. These modifications are necessary and sufficient to allow forwarding of traffic in all routers solely based on the (*, G) multicast routing entries. This feature eliminates any source-specific state and allows scaling capability to an arbitrary number of sources. The following figures show the difference in state created per router for a unidirectional shared tree and source tree versus a bidirectional shared tree.

Figure 1: Unidirectional Shared Tree and Source Tree

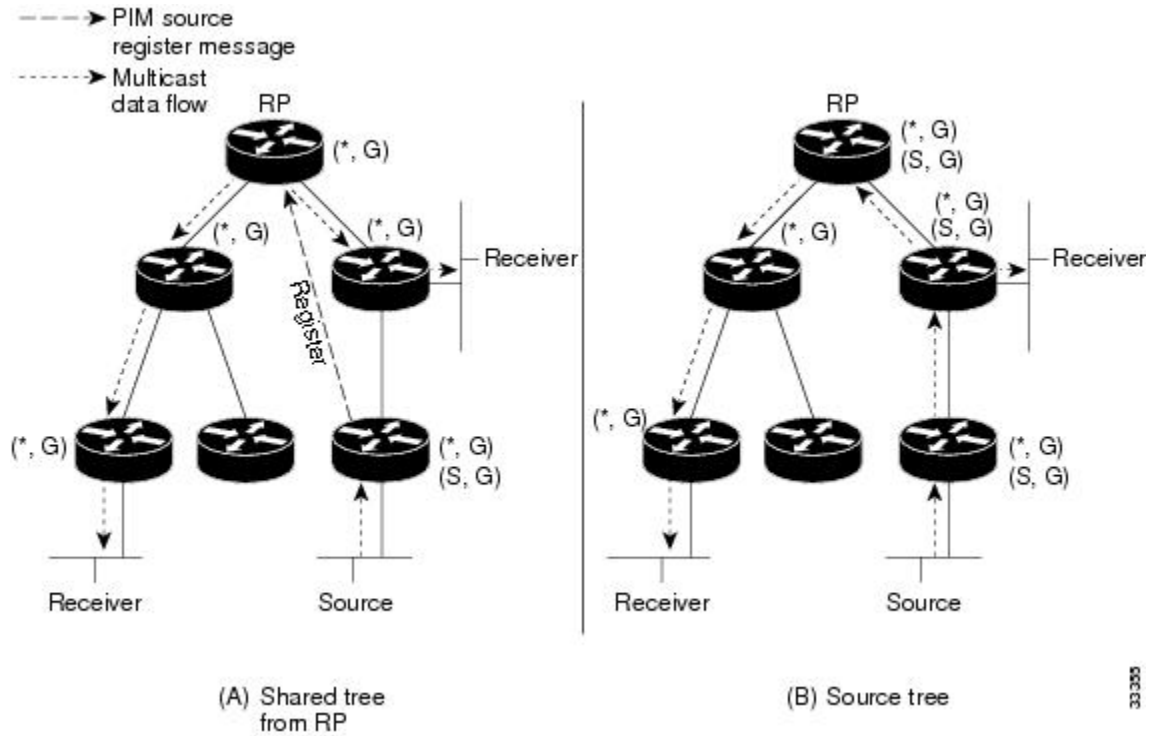

33305

Figure 2: Bidirectional Shared Tree

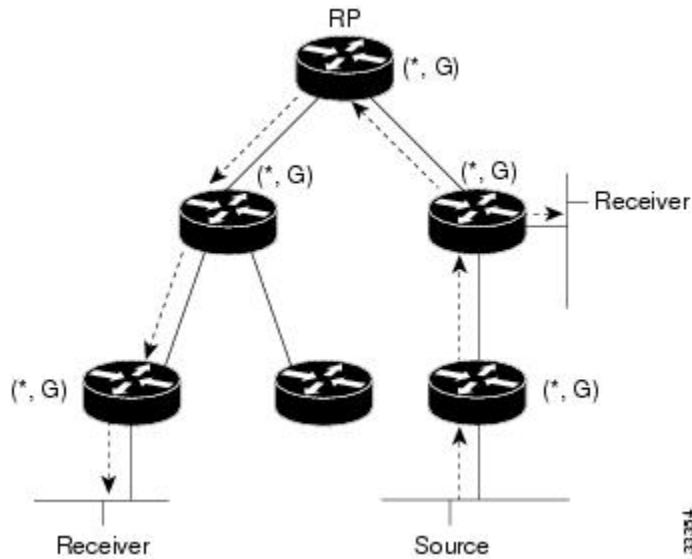

33344

When packets are forwarded downstream from the RP toward receivers, there are no fundamental differences between bidir-PIM and PIM-SM. Bidir-PIM deviates substantially from PIM-SM when passing traffic from sources upstream toward the RP.

In bidir-PIM, the packet forwarding rules have been improved over PIM-SM, allowing traffic to be passed up the shared tree toward the RP. To avoid multicast packet looping, bidir-PIM introduces a new mechanism called designated forwarder (DF) election, which establishes a loop-free SPT rooted at the RP.

Designated Forwarder Election

On every network segment and point-to-point link, all PIM routers participate in a procedure called Designated Forwarder (DF) election. The procedure selects one router as the DF for every RP of bidirectional groups. This router is responsible for forwarding multicast packets received on that network upstream to the RP.

The DF election is based on unicast routing metrics and uses the same tie-break rules employed by PIM assert processes. The router with the most preferred unicast routing metric to the RP becomes the DF. Use of this method ensures that only one copy of every packet will be sent to the RP, even if there are parallel equal cost paths to the RP.

A DF is selected for every RP of bidirectional groups. As a result, multiple routers may be elected as DF on any network segment, one for each RP. In addition, any particular router may be elected as DF on more than one interface.

Bidirectional Group Tree Building

The procedure for joining the shared tree of a bidirectional group is almost identical to that used in PIM SM. One main difference is that, for bidirectional groups, the role of the DR is assumed by the DF for the RP.

On a network with local receivers, only the router elected as the DF populates the outgoing interface list (olist) upon receiving Internet Group Management Protocol (IGMP) join messages, and sends (*, G) join and leave messages upstream toward the RP. When a downstream router wishes to join the shared tree, the RPF neighbor in the PIM join and leave messages is always the DF elected for the interface leading to the RP.

When a router receives a join or leave message, and the router is not the DF for the receiving interface, the message is ignored. Otherwise, the router updates the shared tree in the same way as in sparse mode.

In a network where all routers support bidirectional shared trees, (S, G) join and leave messages are ignored. There is also no need to send PIM assert messages, because the DF election procedure eliminates parallel downstream paths from any RP. In addition, an RP never joins a path back to the source, nor will it send any register stops.

Packet Forwarding

A router only creates (*, G) entries for bidirectional groups. The olist of a (*, G) entry includes all the interfaces for which the router has been elected DF and that have received either an IGMP or PIM join message. If a router is located on a sender-only branch, it will also create (*, G) state, but the olist will not include any interfaces.

If a packet is received from the RPF interface toward the RP, the packet is forwarded downstream according to the olist of the (*, G) entry. Otherwise, only the router that is the DF for the receiving interface forwards the packet upstream toward the RP; all other routers must discard the packet.

IPv4 Bidirectional PIM

For Bidirectional PIM to be operational, designated forwarder is required. The designated forwarder is the router elected to forward packets to and from a segment for a IPv4 bidirectional PIM group. In DF mode, the switch accepts packets from the RPF and from the DF interfaces.

When the switch is forwarding IPv4 bidirectional PIM groups, the RPF interface is always included in the outgoing interface list of (*,G) entry, and the DF interfaces are included depending on IGMP/PIM joins.

If the route to the RP becomes unavailable, the group is changed to dense mode. Should the RPF link to the RP become unavailable, the IPv4 bidirectional PIM flow is removed from the hardware FIB.

PIM Stub Routing

The PIM stub routing feature, available in all of the device software images, reduces resource usage by moving routed traffic closer to the end user.

The PIM stub routing feature supports multicast routing between the distribution layer and the access layer. It supports two types of PIM interfaces, uplink PIM interfaces, and PIM passive interfaces. A routed interface configured with the PIM passive mode does not pass or forward PIM control traffic, it only passes and forwards IGMP traffic.

In a network using PIM stub routing, the only allowable route for IP traffic to the user is through a device that is configured with PIM stub routing. PIM passive interfaces are connected to Layer 2 access domains, such as VLANs, or to interfaces that are connected to other Layer 2 devices. Only directly connected multicast (IGMP) receivers and sources are allowed in the Layer 2 access domains. The PIM passive interfaces do not send or process any received PIM control packets.

When using PIM stub routing, you should configure the distribution and remote routers to use IP multicast routing and configure only the device as a PIM stub router. The device does not route transit traffic between distribution routers. You also need to configure a routed uplink port on the device. The device uplink port cannot be used with SVIs. If you need PIM for an SVI uplink port, you should upgrade to the Network Advantage license.



Note You must also configure EIGRP stub routing when configuring PIM stub routing on the device

The redundant PIM stub router topology is not supported. The redundant topology exists when there is more than one PIM router forwarding multicast traffic to a single access domain. PIM messages are blocked, and the PIM asset and designated router election mechanisms are not supported on the PIM passive interfaces. Only the nonredundant access router topology is supported by the PIM stub feature. By using a nonredundant topology, the PIM passive interface assumes that it is the only interface and designated router on that access domain.

Figure 3: PIM Stub Router Configuration

In the following figure, the Device A routed uplink port 25 is connected to the router and PIM stub routing is enabled on the VLAN 100 interfaces and on Host 3. This configuration allows the directly connected hosts to receive traffic from multicast source 200.1.1.3.

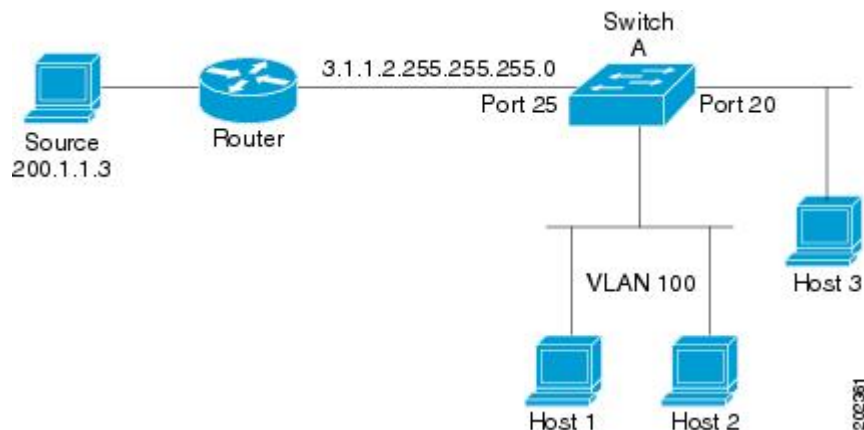

Rendezvous Points

A rendezvous point (RP) is a role that a device performs when operating in Protocol Independent Multicast (PIM) Sparse Mode (SM). An RP is required only in networks running PIM SM. In the PIM-SM model, only network segments with active receivers that have explicitly requested multicast data will be forwarded the traffic.

An RP acts as the meeting place for sources and receivers of multicast data. In a PIM-SM network, sources must send their traffic to the RP. This traffic is then forwarded to receivers down a shared distribution tree. By default, when the first hop device of the receiver learns about the source, it will send a Join message directly to the source, creating a source-based distribution tree from the source to the receiver. This source tree does not include the RP unless the RP is located within the shortest path between the source and receiver.

In most cases, the placement of the RP in the network is not a complex decision. By default, the RP is needed only to start new sessions with sources and receivers. Consequently, the RP experiences little overhead from traffic flow or processing. In PIM version 2, the RP performs less processing than in PIM version 1 because sources must only periodically register with the RP to create state.

Auto-RP

In the first version of PIM-SM, all leaf routers (routers directly connected to sources or receivers) were required to be manually configured with the IP address of the RP. This type of configuration is also known as static RP configuration. Configuring static RPs is relatively easy in a small network, but it can be laborious in a large, complex network.

Following the introduction of PIM-SM version 1, Cisco implemented a version of PIM-SM with the Auto-RP feature. Auto-RP automates the distribution of group-to-RP mappings in a PIM network. Auto-RP has the following benefits:

- Configuring the use of multiple RPs within a network to serve different groups is easy.
- Auto-RP allows load splitting among different RPs and arrangement of RPs according to the location of group participants.
- Auto-RP avoids inconsistent, manual RP configurations that can cause connectivity problems.

Multiple RPs can be used to serve different group ranges or serve as backups to each other. For Auto-RP to work, a router must be designated as an RP-mapping agent, which receives the RP-announcement messages from the RPs and arbitrates conflicts. The RP-mapping agent then sends the consistent group-to-RP mappings to all other routers. Thus, all routers automatically discover which RP to use for the groups they support.



Note If router interfaces are configured in sparse mode, Auto-RP can still be used if all routers are configured with a static RP address for the Auto-RP groups.

To make Auto-RP work, a router must be designated as an RP mapping agent, which receives the RP announcement messages from the RPs and arbitrates conflicts. Thus, all routers automatically discover which RP to use for the groups they support. The Internet Assigned Numbers Authority (IANA) has assigned two group addresses, 224.0.1.39 and 224.0.1.40, for Auto-RP. One advantage of Auto-RP is that any change to the RP designation must be configured only on the routers that are RPs and not on the leaf routers. Another advantage of Auto-RP is that it offers the ability to scope the RP address within a domain. Scoping can be achieved by defining the time-to-live (TTL) value allowed for the Auto-RP advertisements.

Each method for configuring an RP has its own strengths, weaknesses, and level of complexity. In conventional IP multicast network scenarios, we recommend using Auto-RP to configure RPs because it is easy to configure, well-tested, and stable. The alternative ways to configure an RP are static RP, Auto-RP, and bootstrap router.

The Role of Auto-RP in a PIM Network

Auto-RP automates the distribution of group-to- rendezvous point (RP) mappings in a PIM network. To make Auto-RP work, a device must be designated as an RP mapping agent, which receives the RP announcement messages from the RPs and arbitrates conflicts.

Thus, all routers automatically discover which RP to use for the groups they support. The Internet Assigned Numbers Authority (IANA) has assigned two group addresses, 224.0.1.39 and 224.0.1.40, for Auto-RP.

The mapping agent receives announcements of intention to become the RP from Candidate-RPs. The mapping agent then announces the winner of the RP election. This announcement is made independently of the decisions by the other mapping agents.

Multicast Boundaries

Administratively-scoped boundaries can be used to limit the forwarding of multicast traffic outside of a domain or subdomain. This approach uses a special range of multicast addresses, called administratively-scoped addresses, as the boundary mechanism. If you configure an administratively-scoped boundary on a routed interface, multicast traffic whose multicast group addresses fall in this range cannot enter or exit this interface, which provides a firewall for multicast traffic in this address range.



Note Multicast boundaries and TTL thresholds control the scoping of multicast domains; however, TTL thresholds are not supported by the device. You should use multicast boundaries instead of TTL thresholds to limit the forwarding of multicast traffic outside of a domain or a subdomain.

Figure 4: Administratively-Scoped Boundaries

The following figure shows that Company XYZ has an administratively-scoped boundary set for the multicast address range 239.0.0.0/8 on all routed interfaces at the perimeter of its network. This boundary prevents any multicast traffic in the range 239.0.0.0 through 239.255.255.255 from entering or leaving the network. Similarly, the engineering and marketing departments have an administratively-scoped boundary of 239.128.0.0/16 around the perimeter of their networks. This boundary prevents multicast traffic in the range of 239.128.0.0

through 239.128.255.255 from entering or leaving their respective networks.

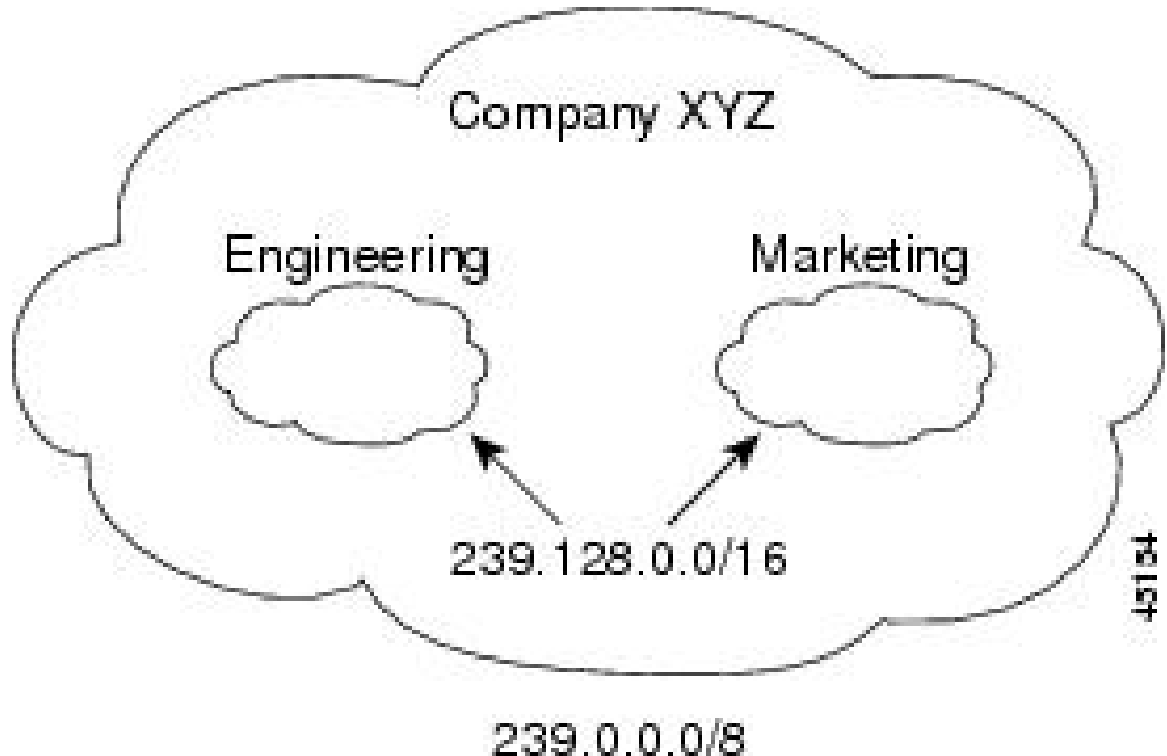

You can define an administratively-scoped boundary on a routed interface for multicast group addresses. A standard access list defines the range of addresses affected. When a boundary is defined, no multicast data packets are allowed to flow across the boundary from either direction. The boundary allows the same multicast group address to be reused in different administrative domains.

The IANA has designated the multicast address range 239.0.0.0 to 239.255.255.255 as the administratively-scoped addresses. This range of addresses can then be reused in domains administered by different organizations. The addresses would be considered local, not globally unique.

You can configure the **filter-autorp** keyword to examine and filter Auto-RP discovery and announcement messages at the administratively scoped boundary. Any Auto-RP group range announcements from the Auto-RP packets that are denied by the boundary access control list (ACL) are removed. An Auto-RP group range announcement is permitted and passed by the boundary only if all addresses in the Auto-RP group range are permitted by the boundary ACL. If any address is not permitted, the entire group range is filtered and removed from the Auto-RP message before the Auto-RP message is forwarded.

Sparse-Dense Mode for Auto-RP

A prerequisite of Auto-RP is that all interfaces must be configured in sparse-dense mode using the **ip pim sparse-dense-mode** interface configuration command. An interface configured in sparse-dense mode is treated in either sparse mode or dense mode of operation, depending on which mode the multicast group operates. If a multicast group has a known RP, the interface is treated in sparse mode. If a group has no known RP, by default the interface is treated in dense mode and data will be flooded over this interface. (You can prevent dense-mode fallback; see the module “Configuring Basic IP Multicast.”)

To successfully implement Auto-RP and prevent any groups other than 224.0.1.39 and 224.0.1.40 from operating in dense mode, we recommend configuring a “sink RP” (also known as “RP of last resort”). A sink

RP is a statically configured RP that may or may not actually exist in the network. Configuring a sink RP does not interfere with Auto-RP operation because, by default, Auto-RP messages supersede static RP configurations. We recommend configuring a sink RP for all possible multicast groups in your network, because it is possible for an unknown or unexpected source to become active. If no RP is configured to limit source registration, the group may revert to dense mode operation and be flooded with data.

Auto RP Benefits

Benefits of Auto-RP in a PIM Network

- Auto-RP allows any change to the RP designation to be configured only on the devices that are RPs, not on the leaf routers.
- Auto-RP offers the ability to scope the RP address within a domain.

PIM Domain Border

As IP multicast becomes more widespread, the chance of one PIMv2 domain bordering another PIMv2 domain increases. Because two domains probably do not share the same set of RPs, BSR, candidate RPs, and candidate BSRs, you need to constrain PIMv2 BSR messages from flowing into or out of the domain. Allowing messages to leak across the domain borders could adversely affect the normal BSR election mechanism and elect a single BSR across all bordering domains and comingle candidate RP advertisements, resulting in the election of RPs in the wrong domain.

This figure displays how you can configure the PIM domain border by using the `ip pim bsr-border` command.

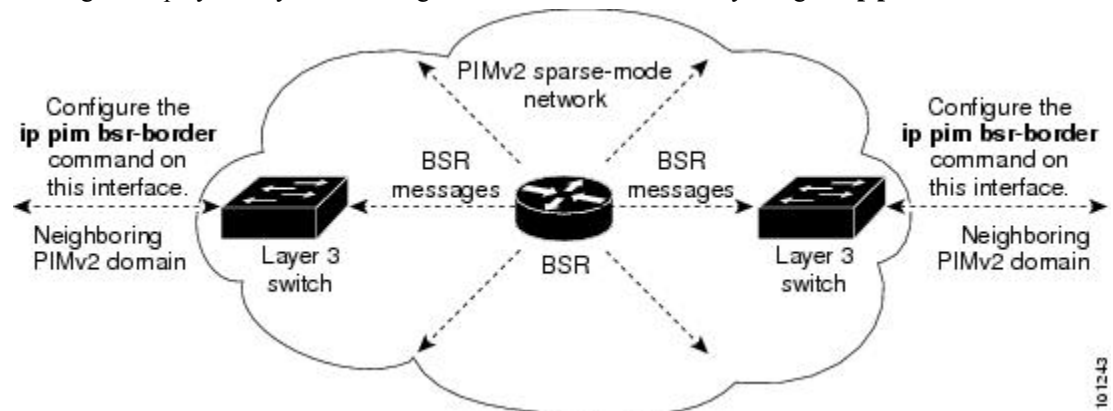

PIMv2 Bootstrap Router

PIMv2 Bootstrap Router (BSR) is another method to distribute group-to-RP mapping information to all PIM routers and multilayer devices in the network. It eliminates the need to manually configure RP information in every router and switch in the network. However, instead of using IP multicast to distribute group-to-RP mapping information, BSR uses hop-by-hop flooding of special BSR messages to distribute the mapping information.

The BSR is elected from a set of candidate routers and switches in the domain that have been configured to function as BSRs. The election mechanism is similar to the root-bridge election mechanism used in bridged LANs. The BSR election is based on the BSR priority of the device contained in the BSR messages that are sent hop-by-hop through the network. Each BSR device examines the message and forwards out all interfaces only the message that has either a higher BSR priority than its BSR priority or the same BSR priority, but with a higher BSR IP address. Using this method, the BSR is elected.

The elected BSR sends BSR messages with a TTL of 1. Neighboring PIMv2 routers or multilayer devices receive the BSR message and multicast it out all other interfaces (except the one on which it was received) with a TTL of 1. In this way, BSR messages travel hop-by-hop throughout the PIM domain. Because BSR messages contain the IP address of the current BSR, the flooding mechanism enables candidate RPs to automatically learn which device is the elected BSR.

Candidate RPs send candidate RP advertisements showing the group range for which they are responsible to the BSR, which stores this information in its local candidate-RP cache. The BSR periodically advertises the contents of this cache in BSR messages to all other PIM devices in the domain. These messages travel hop-by-hop through the network to all routers and switches, which store the RP information in the BSR message in their local RP cache. The routers and switches select the same RP for a given group because they all use a common RP hashing algorithm.

Multicast Forwarding

Forwarding of multicast traffic is accomplished by multicast-capable routers. These routers create distribution trees that control the path that IP multicast traffic takes through the network in order to deliver traffic to all receivers.

Multicast traffic flows from the source to the multicast group over a distribution tree that connects all of the sources to all of the receivers in the group. This tree may be shared by all sources (a shared tree) or a separate distribution tree can be built for each source (a source tree). The shared tree may be one-way or bidirectional.

Before describing the structure of source and shared trees, it is helpful to explain the notations that are used in multicast routing tables. These notations include the following:

- (S,G) = (unicast source for the multicast group G, multicast group G)
- (*,G) = (any source for the multicast group G, multicast group G)

The notation of (S,G), pronounced “S comma G,” enumerates a shortest path tree where S is the IP address of the source and G is the multicast group address.

Shared trees are (*,G) and the source trees are (S,G) and always routed at the sources.

Multicast Distribution Source Tree

The simplest form of a multicast distribution tree is a source tree. A source tree has its root at the source host and has branches forming a spanning tree through the network to the receivers. Because this tree uses the shortest path through the network, it is also referred to as a shortest path tree (SPT).

The figure shows an example of an SPT for group 224.1.1.1 rooted at the source, Host A, and connecting two receivers, Hosts B and C.

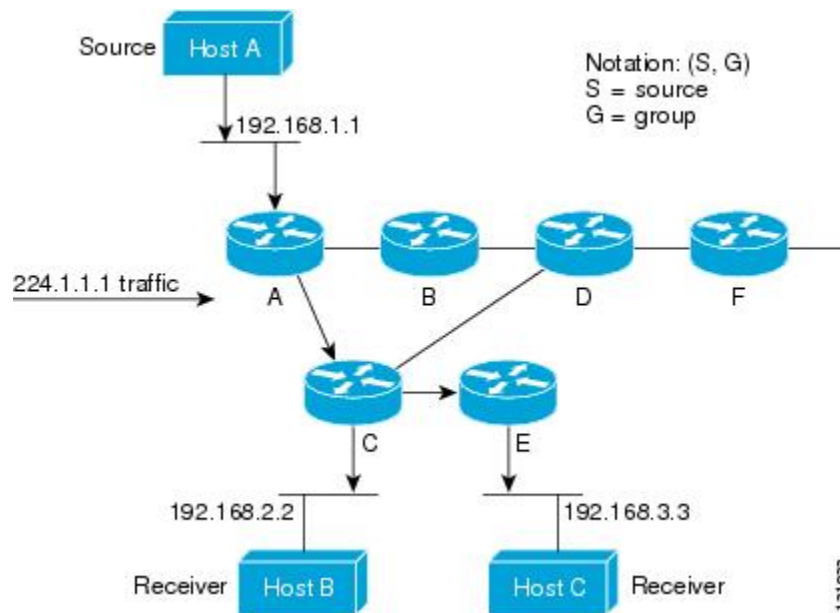

Using standard notation, the SPT for the example shown in the figure would be (192.168.1.1, 224.1.1.1).

The (S,G) notation implies that a separate SPT exists for each individual source sending to each group--which is correct.

Multicast Distribution Shared Tree

Unlike source trees that have their root at the source, shared trees use a single common root placed at some chosen point in the network. This shared root is called a rendezvous point (RP).

The following figure shows a shared tree for the group 224.2.2.2 with the root located at Router D. This shared tree is unidirectional. Source traffic is sent towards the RP on a source tree. The traffic is then forwarded down the shared tree from the RP to reach all of the receivers (unless the receiver is located between the source and the RP, in which case it will be serviced directly).

Figure 5: Shared Tree

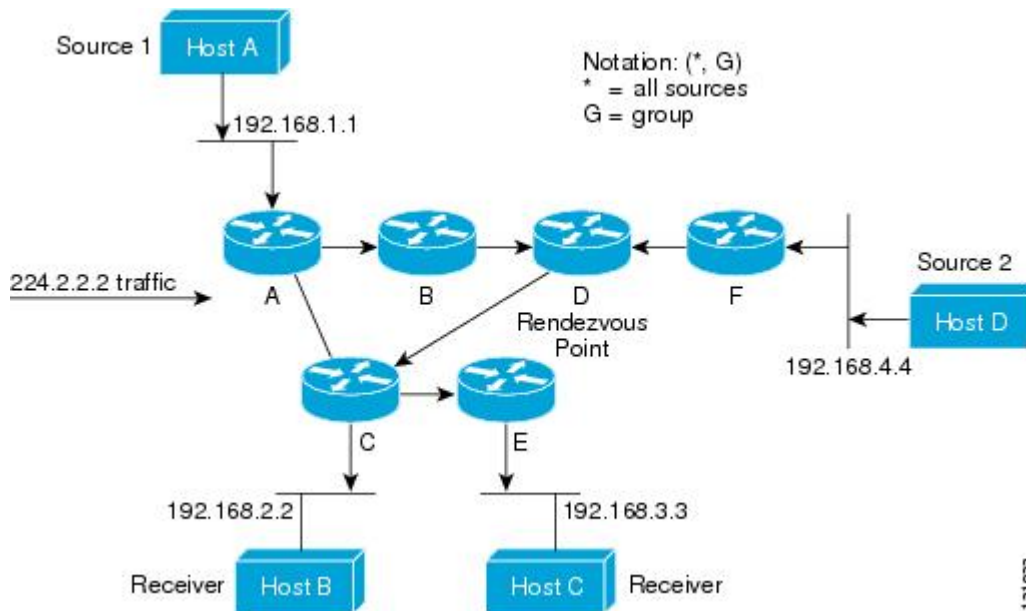

In this example, multicast traffic from the sources, Hosts A and D, travels to the root (Router D) and then down the shared tree to the two receivers, Hosts B and C. Because all sources in the multicast group use a common shared tree, a wildcard notation written as (*, G), pronounced "star comma G", represents the tree. In this case, * means all sources, and G represents the multicast group. Therefore, the shared tree shown in the figure would be written as (*, 224.2.2.2).

Both source trees and shared trees are loop-free. Messages are replicated only where the tree branches. Members of multicast groups can join or leave at any time; therefore the distribution trees must be dynamically updated. When all the active receivers on a particular branch stop requesting the traffic for a particular multicast group, the routers prune that branch from the distribution tree and stop forwarding traffic down that branch. If one receiver on that branch becomes active and requests the multicast traffic, the router will dynamically modify the distribution tree and start forwarding traffic again.

Source Tree Advantage

Source trees have the advantage of creating the optimal path between the source and the receivers. This advantage guarantees the minimum amount of network latency for forwarding multicast traffic. However, this optimization comes at a cost. The routers must maintain path information for each source. In a network that has thousands of sources and thousands of groups, this overhead can quickly become a resource issue on the routers. Memory consumption from the size of the multicast routing table is a factor that network designers must take into consideration.

Shared Tree Advantage

Shared trees have the advantage of requiring the minimum amount of state in each router. This advantage lowers the overall memory requirements for a network that only allows shared trees. The disadvantage of shared trees is that under certain circumstances the paths between the source and receivers might not be the optimal paths, which might introduce some latency in packet delivery. For example, in the figure above the shortest path between Host A (source 1) and Host B (a receiver) would be Router A and Router C. Because we are using Router D as the root for a shared tree, the traffic must traverse Routers A, B, D and then C.

Network designers must carefully consider the placement of the rendezvous point (RP) when implementing a shared tree-only environment.

In unicast routing, traffic is routed through the network along a single path from the source to the destination host. A unicast router does not consider the source address; it considers only the destination address and how to forward the traffic toward that destination. The router scans through its routing table for the destination address and then forwards a single copy of the unicast packet out the correct interface in the direction of the destination.

In multicast forwarding, the source is sending traffic to an arbitrary group of hosts that are represented by a multicast group address. The multicast router must determine which direction is the upstream direction (toward the source) and which one is the downstream direction (or directions) toward the receivers. If there are multiple downstream paths, the router replicates the packet and forwards it down the appropriate downstream paths (best unicast route metric)--which is not necessarily all paths. Forwarding multicast traffic away from the source, rather than to the receiver, is called Reverse Path Forwarding (RPF). RPF is described in the following section.

PIM Shared Tree and Source Tree

By default, members of a group receive data from senders to the group across a single data-distribution tree rooted at the RP.

Figure 6: Shared Tree and Source Tree (Shortest-Path Tree)

The following figure shows this type of shared-distribution tree. Data from senders is delivered to the RP for distribution to group members joined to the shared tree.

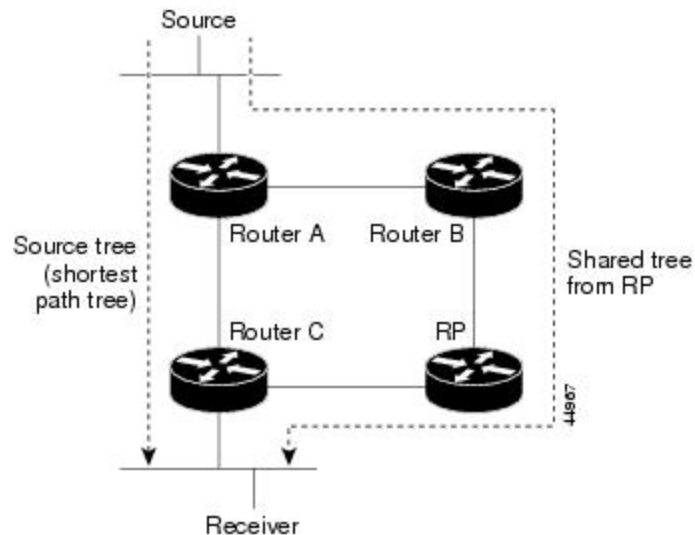

If the data rate warrants, leaf routers (routers without any downstream connections) on the shared tree can use the data distribution tree rooted at the source. This type of distribution tree is called a shortest-path tree or source tree. By default, the software device to a source tree upon receiving the first data packet from a source.

This process describes the move from a shared tree to a source tree:

1. A receiver joins a group; leaf Router C sends a join message toward the RP.
2. The RP puts a link to Router C in its outgoing interface list.
3. A source sends data; Router A encapsulates the data in a register message and sends it to the RP.

4. The RP forwards the data down the shared tree to Router C and sends a join message toward the source. At this point, data might arrive twice at Router C, once encapsulated and once natively.
5. When data arrives natively (unencapsulated) at the RP, it sends a register-stop message to Router A.
6. By default, reception of the first data packet prompts Router C to send a join message toward the source.
7. When Router C receives data on (S, G), it sends a prune message for the source up the shared tree.
8. The RP deletes the link to Router C from the outgoing interface of (S, G). The RP triggers a prune message toward the source.

Join and prune messages are sent for sources and RPs. They are sent hop-by-hop and are processed by each PIM device along the path to the source or RP. Register and register-stop messages are not sent hop-by-hop. They are sent by the designated router that is directly connected to a source and are received by the RP for the group.

Multiple sources sending to groups use the shared tree. You can configure the PIM device to stay on the shared tree.

The change from shared to source tree happens when the first data packet arrives at the last-hop router. This change depends upon the threshold that is configured by using the **ip pim spt-threshold** global configuration command.

The shortest-path tree requires more memory than the shared tree but reduces delay. You may want to postpone its use. Instead of allowing the leaf router to immediately move to the shortest-path tree, you can specify that the traffic must first reach a threshold.

You can configure when a PIM leaf router should join the shortest-path tree for a specified group. If a source sends at a rate greater than or equal to the specified kbps rate, the multilayer switch triggers a PIM join message toward the source to construct a source tree (shortest-path tree). If the traffic rate from the source drops below the threshold value, the leaf router switches back to the shared tree and sends a prune message toward the source.

You can specify to which groups the shortest-path tree threshold applies by using a group list (a standard access list). If a value of 0 is specified or if the group list is not used, the threshold applies to all groups.

Reverse Path Forwarding

In unicast routing, traffic is routed through the network along a single path from the source to the destination host. A unicast router does not consider the source address; it considers only the destination address and how to forward the traffic toward that destination. The router scans through its routing table for the destination network and then forwards a single copy of the unicast packet out the correct interface in the direction of the destination.

In multicast forwarding, the source is sending traffic to an arbitrary group of hosts that are represented by a multicast group address. The multicast router must determine which direction is the upstream direction (toward the source) and which one is the downstream direction (or directions) toward the receivers. If there are multiple downstream paths, the router replicates the packet and forwards it down the appropriate downstream paths (best unicast route metric)--which is not necessarily all paths. Forwarding multicast traffic away from the source, rather than to the receiver, is called Reverse Path Forwarding (RPF). RPF is an algorithm used for forwarding multicast datagrams.

Protocol Independent Multicast (PIM) uses the unicast routing information to create a distribution tree along the reverse path from the receivers towards the source. The multicast routers then forward packets along the distribution tree from the source to the receivers. RPF is a key concept in multicast forwarding. It enables

routers to correctly forward multicast traffic down the distribution tree. RPF makes use of the existing unicast routing table to determine the upstream and downstream neighbors. A router will forward a multicast packet only if it is received on the upstream interface. This RPF check helps to guarantee that the distribution tree will be loop-free.

RPF Check

When a multicast packet arrives at a router, the router performs an RPF check on the packet. If the RPF check succeeds, the packet is forwarded. Otherwise, it is dropped.

For traffic flowing down a source tree, the RPF check procedure works as follows:

1. The router looks up the source address in the unicast routing table to determine if the packet has arrived on the interface that is on the reverse path back to the source.
2. If the packet has arrived on the interface leading back to the source, the RPF check succeeds and the packet is forwarded out the interfaces present in the outgoing interface list of a multicast routing table entry.
3. If the RPF check in Step 2 fails, the packet is dropped.

The figure shows an example of an unsuccessful RPF check.

Figure 7: RPF Check Fails

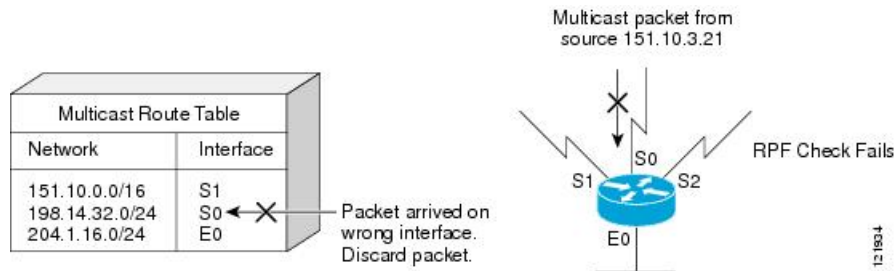

As the figure illustrates, a multicast packet from source 151.10.3.21 is received on serial interface 0 (S0). A check of the unicast route table shows that S1 is the interface this router would use to forward unicast data to 151.10.3.21. Because the packet has arrived on interface S0, the packet is discarded.

The figure shows an example of a successful RPF check.

Figure 8: RPF Check Succeeds

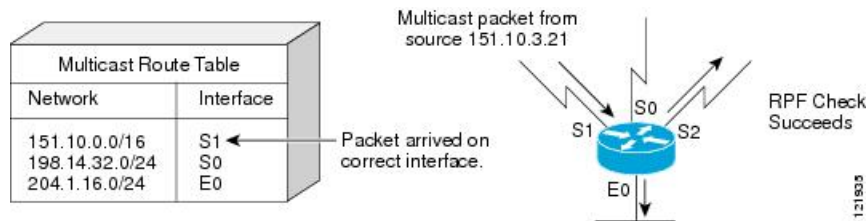

In this example, the multicast packet has arrived on interface S1. The router refers to the unicast routing table and finds that S1 is the correct interface. The RPF check passes, and the packet is forwarded.

PIM uses both source trees and RP-rooted shared trees to forward datagrams. The RPF check is performed differently for each:

- If a PIM router or multilayer switch has a source-tree state (that is, an (S, G) entry is present in the multicast routing table), it performs the RPF check against the IP address of the source of the multicast packet.
- If a PIM router or multilayer switch has a shared-tree state (and no explicit source-tree state), it performs the RPF check on the RP address (which is known when members join the group).



Note DVMRP is not supported on the switch.

Sparse-mode PIM uses the RPF lookup function to decide where it needs to send joins and prunes:

- (S, G) joins (which are source-tree states) are sent toward the source.
- (*,G) joins (which are shared-tree states) are sent toward the RP.

Default PIM Routing Configuration

This table displays the default PIM routing configuration for the device.

Table 1: Default Multicast Routing Configuration

Feature	Default Setting
Multicast routing	Disabled on all interfaces.
PIM version	Version 2.
PIM mode	No mode is defined.
PIM stub routing	None configured.
PIM RP address	None configured.
PIM domain border	Disabled.
PIM multicast boundary	None.
Candidate BSRs	Disabled.
Candidate RPs	Disabled.
Shortest-path tree threshold rate	0 kb/s.
PIM router query message interval	30 seconds.

How to Configure PIM

Enabling PIM Stub Routing

This procedure is optional.

Procedure

	Command or Action	Purpose
Step 1	enable Example: Device> enable	Enables privileged EXEC mode. Enter your password if prompted.
Step 2	configure terminal Example: Device# configure terminal	Enters global configuration mode.
Step 3	interface <i>interface-id</i> Example: Device(config)# interface gigabitethernet 1/0/1	Specifies the interface on which you want to enable PIM stub routing, and enters interface configuration mode. The specified interface must be one of the following: These interfaces must have IP addresses assigned to them. <ul style="list-style-type: none"> • A routed port—A physical port that has been configured as a Layer 3 port by entering the no switchport interface configuration command. • An SVI—A VLAN interface created by using the interface vlan <i>vlan-id</i> global configuration command.
Step 4	ip pim passive Example: Device(config-if)# ip pim passive	Configures the PIM stub feature on the interface.
Step 5	end Example: Device(config)# end	Returns to privileged EXEC mode.

	Command or Action	Purpose
Step 6	show ip pim interface Example: Device# <code>show ip pim interface</code>	(Optional) Displays the PIM stub that is enabled on each interface.
Step 7	show ip igmp groups detail Example: Device# <code>show ip igmp groups detail</code>	(Optional) Displays the interested clients that have joined the specific multicast source group.
Step 8	show ip mroute Example: Device# <code>show ip mroute</code>	(Optional) Displays the IP multicast routing table.
Step 9	show running-config Example: Device# <code>show running-config</code>	Verifies your entries.
Step 10	copy running-config startup-config Example: Device# <code>copy running-config startup-config</code>	(Optional) Saves your entries in the configuration file.

Configuring a Rendezvous Point

You must have a rendezvous point (RP), if the interface is in sparse-dense mode and if you want to handle the group as a sparse group. You can use these methods:

- By manually assigning an RP to multicast groups.
- As a standalone, Cisco-proprietary protocol separate from PIMv1, which includes:
- By using a standards track protocol in the Internet Engineering Task Force (IETF), which includes configuring PIMv2 BSR .



Note You can use Auto-RP, BSR, or a combination of both, depending on the PIM version that you are running and the types of routers in your network. For information about working with different PIM versions in your network, see [PIMv1 and PIMv2 Interoperability, on page 2](#).

Manually Assigning an RP to Multicast Groups

If the rendezvous point (RP) for a group is learned through a dynamic mechanism (such as Auto-RP or BSR), you need not perform this task for that RP.

Senders of multicast traffic announce their existence through register messages received from the source first-hop router (designated router) and forwarded to the RP. Receivers of multicast packets use RPs to join a multicast group by using explicit join messages.



Note RPs are not members of the multicast group; they serve as a *meeting place* for multicast sources and group members.

You can configure a single RP for multiple groups defined by an access list. If there is no RP configured for a group, the multilayer switch responds to the group as dense and uses the dense-mode PIM techniques.

This procedure is optional.

Procedure

	Command or Action	Purpose
Step 1	enable Example: Device> enable	Enables privileged EXEC mode. Enter your password if prompted.
Step 2	configure terminal Example: Device# configure terminal	Enters global configuration mode.
Step 3	ip pim rp-address <i>ip-address</i> <i>[access-list-number]</i> [override] Example: Device(config)# ip pim rp-address 10.1.1.1 20 override	Configures the address of a PIM RP. By default, no PIM RP address is configured. You must configure the IP address of RPs on all routers and multilayer switches (including the RP). Note If there is no RP configured for a group, the device treats the group as dense, using the dense-mode PIM techniques. A PIM device can be an RP for more than one group. Only one RP address can be used at a time within a PIM domain. The access list conditions specify for which groups the device is an RP. <ul style="list-style-type: none"> For <i>ip-address</i>, enter the unicast address of the RP in dotted-decimal notation.

	Command or Action	Purpose
		<ul style="list-style-type: none"> • (Optional) For <i>access-list-number</i>, enter an IP standard access list number from 1 to 99. If no access list is configured, the RP is used for all groups. • (Optional) The override keyword indicates that if there is a conflict between the RP configured with this command and one learned by Auto-RP or BSR, the RP configured with this command prevails.
Step 4	<p>access-list <i>access-list-number</i> {deny permit} <i>source</i> [<i>source-wildcard</i>]</p> <p>Example:</p> <pre>Device(config)# access-list 25 permit 10.5.0.1 255.224.0.0</pre>	<p>Creates a standard access list, repeating the command as many times as necessary.</p> <ul style="list-style-type: none"> • For <i>access-list-number</i>, enter the access list number specified in Step 2. • The deny keyword denies access if the conditions are matched. • The permit keyword permits access if the conditions are matched. • For <i>source</i>, enter the multicast group address for which the RP should be used. • (Optional) For <i>source-wildcard</i>, enter the wildcard bits in dotted decimal notation to be applied to the source. Place ones in the bit positions that you want to ignore. <p>The access list is always terminated by an implicit deny statement for everything.</p>
Step 5	<p>end</p> <p>Example:</p> <pre>Device(config)# end</pre>	Returns to privileged EXEC mode.
Step 6	<p>show running-config</p> <p>Example:</p> <pre>Device# show running-config</pre>	Verifies your entries.
Step 7	<p>copy running-config startup-config</p> <p>Example:</p> <pre>Device# copy running-config startup-config</pre>	(Optional) Saves your entries in the configuration file.

Setting Up Auto-RP in a New Internetwork



Note Omit Step 3 in the following procedure, if you want to configure a PIM router as the RP for the local group.

Procedure

	Command or Action	Purpose
Step 1	<p>enable</p> <p>Example:</p> <pre>Device> enable</pre>	<p>Enables privileged EXEC mode.</p> <p>Enter your password if prompted.</p>
Step 2	<p>show running-config</p> <p>Example:</p> <pre>Device# show running-config</pre>	<p>Verifies that a default RP is already configured on all PIM devices and the RP in the sparse-mode network. It was previously configured with the ip pim rp-address global configuration command.</p> <p>Note This step is not required for spare-dense-mode environments.</p> <p>The selected RP should have good connectivity and be available across the network. Use this RP for the global groups (for example, 224.x.x.x and other global groups). Do not reconfigure the group address range that this RP serves. RPs dynamically discovered through Auto-RP take precedence over statically configured RPs. Assume that it is desirable to use a second RP for the local groups.</p>
Step 3	<p>configure terminal</p> <p>Example:</p> <pre>Device# configure terminal</pre>	<p>Enters global configuration mode.</p>
Step 4	<p>ip pim send-rp-announce interface-id scope ttl group-list access-list-number interval seconds</p> <p>Example:</p> <pre>Device(config)# ip pim send-rp-announce gigabitethernet 1/0/5 scope 20 group-list 10 interval 120</pre>	<p>Configures another PIM device to be the candidate RP for local groups.</p> <ul style="list-style-type: none"> For <i>interface-id</i>, enter the interface type and number that identifies the RP address. Valid interfaces include physical ports, port channels, and VLANs. For scope <i>ttl</i>, specify the time-to-live value in hops. Enter a hop count that is

	Command or Action	Purpose
		<p>high enough so that the RP-announce messages reach all mapping agents in the network. There is no default setting. The range is 1 to 255.</p> <ul style="list-style-type: none"> For group-list <i>access-list-number</i>, enter an IP standard access list number from 1 to 99. If no access list is configured, the RP is used for all groups. For interval <i>seconds</i>, specify how often the announcement messages must be sent. The default is 60 seconds. The range is 1 to 16383.
Step 5	<p>access-list <i>access-list-number</i> {deny permit} <i>source</i> [<i>source-wildcard</i>]</p> <p>Example:</p> <pre>Device(config)# access-list 10 permit 10.10.0.0</pre>	<p>Creates a standard access list, repeating the command as many times as necessary.</p> <ul style="list-style-type: none"> For <i>access-list-number</i>, enter the access list number specified in Step 3. The deny keyword denies access if the conditions are matched. The permit keyword permits access if the conditions are matched. For <i>source</i>, enter the multicast group address range for which the RP should be used. (Optional) For <i>source-wildcard</i>, enter the wildcard bits in dotted decimal notation to be applied to the source. Place ones in the bit positions that you want to ignore. <p>Note Recall that the access list is always terminated by an implicit deny statement for everything.</p>
Step 6	<p>ip pim send-rp-discovery scope <i>tll</i></p> <p>Example:</p> <pre>Device(config)# ip pim send-rp-discovery scope 50</pre>	<p>Finds a device whose connectivity is not likely to be interrupted, and assign it the role of RP-mapping agent.</p> <p>For scope <i>tll</i>, specify the time-to-live value in hops to limit the RP discovery packets. All devices within the hop count from the source device receive the Auto-RP discovery messages. These messages tell other devices which group-to-RP mapping to use to avoid conflicts (such as overlapping group-to-RP</p>

	Command or Action	Purpose
		ranges). There is no default setting. The range is 1 to 255.
Step 7	end Example: Device (config) # end	Returns to privileged EXEC mode.
Step 8	show running-config Example: Device# show running-config	Verifies your entries.
Step 9	show ip pim rp mapping Example: Device# show ip pim rp mapping	Displays active RPs that are cached with associated multicast routing entries.
Step 10	show ip pim rp Example: Device# show ip pim rp	Displays the information cached in the routing table.
Step 11	copy running-config startup-config Example: Device# copy running-config startup-config	(Optional) Saves your entries in the configuration file.

Adding Auto-RP to an Existing Sparse-Mode Cloud

This section contains suggestions for the initial deployment of Auto-RP into an existing sparse-mode cloud to minimize disruption of the existing multicast infrastructure.

This procedure is optional.

Procedure

	Command or Action	Purpose
Step 1	enable Example: Device> enable	Enables privileged EXEC mode. Enter your password if prompted.

	Command or Action	Purpose
Step 2	<p>show running-config</p> <p>Example:</p> <pre>Device# show running-config</pre>	<p>Verifies that a default RP is already configured on all PIM devices and the RP in the sparse-mode network. It was previously configured with the ip pim rp-address global configuration command.</p> <p>Note This step is not required for spare-dense-mode environments.</p> <p>The selected RP should have good connectivity and be available across the network. Use this RP for the global groups (for example, 224.x.x.x and other global groups). Do not reconfigure the group address range that this RP serves. RPs dynamically discovered through Auto-RP take precedence over statically configured RPs. Assume that it is desirable to use a second RP for the local groups.</p>
Step 3	<p>configure terminal</p> <p>Example:</p> <pre>Device# configure terminal</pre>	<p>Enters global configuration mode.</p>
Step 4	<p>ip pim send-rp-announce interface-id scope ttl group-list access-list-number interval seconds</p> <p>Example:</p> <pre>Device(config)# ip pim send-rp-announce gigabitethernet 1/0/5 scope 20 group-list 10 interval 120</pre>	<p>Configures another PIM device to be the candidate RP for local groups.</p> <ul style="list-style-type: none"> For <i>interface-id</i>, enter the interface type and number that identifies the RP address. Valid interfaces include physical ports, port channels, and VLANs. For scope <i>ttl</i>, specify the time-to-live value in hops. Enter a hop count that is high enough so that the RP-announce messages reach all mapping agents in the network. There is no default setting. The range is 1 to 255. For group-list <i>access-list-number</i>, enter an IP standard access list number from 1 to 99. If no access list is configured, the RP is used for all groups. For interval <i>seconds</i>, specify how often the announcement messages must be sent. The default is 60 seconds. The range is 1 to 16383.

	Command or Action	Purpose
Step 5	<p>access-list <i>access-list-number</i> {deny permit} <i>source</i> [<i>source-wildcard</i>]</p> <p>Example:</p> <pre>Device(config)# access-list 10 permit 224.0.0.0 15.255.255.255</pre>	<p>Creates a standard access list, repeating the command as many times as necessary.</p> <ul style="list-style-type: none"> For <i>access-list-number</i>, enter the access list number specified in Step 3. The deny keyword denies access if the conditions are matched. The permit keyword permits access if the conditions are matched. For <i>source</i>, enter the multicast group address range for which the RP should be used. (Optional) For <i>source-wildcard</i>, enter the wildcard bits in dotted decimal notation to be applied to the source. Place ones in the bit positions that you want to ignore. <p>Recall that the access list is always terminated by an implicit deny statement for everything.</p>
Step 6	<p>ip pim send-rp-discovery scope <i>ttl</i></p> <p>Example:</p> <pre>Device(config)# ip pim send-rp-discovery scope 50</pre>	<p>Finds a device whose connectivity is not likely to be interrupted, and assigns it the role of RP-mapping agent.</p> <p>For scope <i>ttl</i>, specify the time-to-live value in hops to limit the RP discovery packets. All devices within the hop count from the source device receive the Auto-RP discovery messages. These messages tell other devices which group-to-RP mapping to use to avoid conflicts (such as overlapping group-to-RP ranges). There is no default setting. The range is 1 to 255.</p> <p>Note To remove the device as the RP-mapping agent, use the no ip pim send-rp-discovery global configuration command.</p>
Step 7	<p>end</p> <p>Example:</p> <pre>Device(config)# end</pre>	<p>Returns to privileged EXEC mode.</p>
Step 8	<p>show running-config</p> <p>Example:</p>	<p>Verifies your entries.</p>

	Command or Action	Purpose
	Device# <code>show running-config</code>	
Step 9	show ip pim rp mapping Example: Device# <code>show ip pim rp mapping</code>	Displays active RPs that are cached with associated multicast routing entries.
Step 10	show ip pim rp Example: Device# <code>show ip pim rp</code>	Displays the information cached in the routing table.
Step 11	copy running-config startup-config Example: Device# <code>copy running-config startup-config</code>	(Optional) Saves your entries in the configuration file.

Preventing Join Messages to False RPs

Determine whether the `ip pim accept-rp` command was previously configured throughout the network by using the `show running-config` privileged EXEC command. If the `ip pim accept-rp` command is not configured on any device, this problem can be addressed later. In those routers or multilayer switches already configured with the `ip pim accept-rp` command, you must enter the command again to accept the newly advertised RP.

Filtering Incoming RP Announcement Messages

You can add configuration commands to the mapping agents to prevent a maliciously configured router from masquerading as a candidate RP and causing problems.

This procedure is optional.

Procedure

	Command or Action	Purpose
Step 1	enable Example: Device> <code>enable</code>	Enables privileged EXEC mode. Enter your password if prompted.
Step 2	configure terminal Example:	Enters global configuration mode.

	Command or Action	Purpose
	Device# <code>configure terminal</code>	
Step 3	<p>ip pim rp-announce-filter rp-list access-list-number group-list access-list-number</p> <p>Example:</p> <pre>Device(config)# ip pim rp-announce-filter rp-list 10 group-list 14</pre>	<p>Filters incoming RP announcement messages.</p> <p>Enter this command on each mapping agent in the network. Without this command, all incoming RP-announce messages are accepted by default.</p> <p>For rp-list access-list-number, configure an access list of candidate RP addresses that, if permitted, is accepted for the group ranges supplied in the group-list access-list-number variable. If this variable is omitted, the filter applies to all multicast groups.</p> <p>If more than one mapping agent is used, the filters must be consistent across all mapping agents to ensure that no conflicts occur in the group-to-RP mapping information.</p>
Step 4	<p>access-list access-list-number {deny permit} source [source-wildcard]</p> <p>Example:</p> <pre>Device(config)# access-list 10 permit 10.8.1.0 255.255.224.0</pre>	<p>Creates a standard access list, repeating the command as many times as necessary.</p> <ul style="list-style-type: none"> • For <i>access-list-number</i>, enter the access list number specified in Step 2. • The deny keyword denies access if the conditions are matched. • The permit keyword permits access if the conditions are matched. • Create an access list that specifies from which routers and multilayer switches the mapping agent accepts candidate RP announcements (rp-list ACL). • Create an access list that specifies the range of multicast groups from which to accept or deny (group-list ACL). • For <i>source</i>, enter the multicast group address range for which the RP should be used. • (Optional) For <i>source-wildcard</i>, enter the wildcard bits in dotted decimal notation to be applied to the source. Place ones in the bit positions that you want to ignore. <p>The access list is always terminated by an implicit deny statement for everything.</p>

	Command or Action	Purpose
Step 5	end Example: Device(config)# end	Returns to privileged EXEC mode.
Step 6	show running-config Example: Device# show running-config	Verifies your entries.
Step 7	copy running-config startup-config Example: Device# copy running-config startup-config	(Optional) Saves your entries in the configuration file.

Configuring PIMv2 BSR

The process for configuring PIMv2 BSR may involve the following optional tasks:

- Defining the PIM domain border
- Defining the IP multicast boundary
- Configuring candidate BSRs
- Configuring candidate RPs

Defining the PIM Domain Border

Perform the following steps to configure the PIM domain border. This procedure is optional.

Procedure

	Command or Action	Purpose
Step 1	enable Example: Device> enable	Enables privileged EXEC mode. <ul style="list-style-type: none"> • Enter your password if prompted.
Step 2	configure terminal Example:	Enters global configuration mode.

	Command or Action	Purpose
	Device# <code>configure terminal</code>	
Step 3	<p>interface <i>interface-id</i></p> <p>Example:</p> <pre>Device(config)# interface gigabitethernet 1/0/1</pre>	<p>Specifies the interface to be configured, and enters interface configuration mode.</p> <p>The specified interface must be one of the following:</p> <ul style="list-style-type: none"> • A routed port—A physical port that has been configured as a Layer 3 port by entering the no switchport interface configuration command. • An SVI—A VLAN interface created by using the interface vlan <i>vlan-id</i> global configuration command. <p>These interfaces must have IP addresses assigned to them.</p>
Step 4	<p>ip pim bsr-border</p> <p>Example:</p> <pre>Device(config-if)# ip pim bsr-border</pre>	<p>Defines a PIM bootstrap message boundary for the PIM domain.</p> <p>Enter this command on each interface that connects to other bordering PIM domains. This command instructs the device to neither send nor receive PIMv2 BSR messages on this interface.</p> <p>Note To remove the PIM border, use the no ip pim bsr-border interface configuration command.</p>
Step 5	<p>end</p> <p>Example:</p> <pre>Device(config)# end</pre>	<p>Returns to privileged EXEC mode.</p>
Step 6	<p>show running-config</p> <p>Example:</p> <pre>Device# show running-config</pre>	<p>Verifies your entries.</p>
Step 7	<p>copy running-config startup-config</p> <p>Example:</p> <pre>Device# copy running-config startup-config</pre>	<p>(Optional) Saves your entries in the configuration file.</p>

Defining the IP Multicast Boundary

You define a multicast boundary to prevent Auto-RP messages from entering the PIM domain. You create an access list to deny packets destined for 224.0.1.39 and 224.0.1.40, which carry Auto-RP information.

This procedure is optional.

Procedure

	Command or Action	Purpose
Step 1	enable Example: Device> enable	Enables privileged EXEC mode. <ul style="list-style-type: none"> • Enter your password if prompted.
Step 2	configure terminal Example: # configure terminal	Enters global configuration mode.
Step 3	access-list <i>access-list-number</i> deny <i>source</i> [<i>source-wildcard</i>] Example: Device(config)# access-list 12 deny 224.0.1.39 access-list 12 deny 224.0.1.40	Creates a standard access list, repeating the command as many times as necessary. <ul style="list-style-type: none"> • For <i>access-list-number</i>, the range is 1 to 99. • The deny keyword denies access if the conditions are matched. • For <i>source</i>, enter multicast addresses 224.0.1.39 and 224.0.1.40, which carry Auto-RP information. • (Optional) For <i>source-wildcard</i>, enter the wildcard bits in dotted decimal notation to be applied to the source. Place ones in the bit positions that you want to ignore. <p>The access list is always terminated by an implicit deny statement for everything.</p>
Step 4	interface <i>interface-id</i> Example: Device(config)# interface gigabitethernet 1/0/1	Specifies the interface to be configured, and enters interface configuration mode. <p>The specified interface must be one of the following:</p> <ul style="list-style-type: none"> • A routed port—A physical port that has been configured as a Layer 3 port by entering the no switchport interface configuration command.

	Command or Action	Purpose
		<ul style="list-style-type: none"> An SVI—A VLAN interface created by using the interface vlan <i>vlan-id</i> global configuration command. <p>These interfaces must have IP addresses assigned to them.</p>
Step 5	ip multicast boundary <i>access-list-number</i> Example: <pre>Device(config-if)# ip multicast boundary 12</pre>	Configures the boundary, specifying the access list you created in Step 2.
Step 6	end Example: <pre>Device(config)# end</pre>	Returns to privileged EXEC mode.
Step 7	show running-config Example: <pre>Device# show running-config</pre>	Verifies your entries.
Step 8	copy running-config startup-config Example: <pre>Device# copy running-config startup-config</pre>	(Optional) Saves your entries in the configuration file.

Configuring Candidate BSRs

You can configure one or more candidate BSRs. The devices serving as candidate BSRs should have good connectivity to other devices and be in the backbone portion of the network.

This procedure is optional.

Procedure

	Command or Action	Purpose
Step 1	enable Example: <pre>Device> enable</pre>	<p>Enables privileged EXEC mode.</p> <p>Enter your password if prompted.</p>

	Command or Action	Purpose
Step 2	configure terminal Example: <pre>Device# configure terminal</pre>	Enters global configuration mode.
Step 3	ip pim bsr-candidate interface-id hash-mask-length [priority] Example: <pre>Device(config)# ip pim bsr-candidate gigabitethernet 1/0/3 28 100</pre>	Configures your device to be a candidate BSR. <ul style="list-style-type: none"> • For <i>interface-id</i>, enter the interface on this device from which the BSR address is derived to make it a candidate. This interface must be enabled with PIM. Valid interfaces include physical ports, port channels, and VLANs. • For <i>hash-mask-length</i>, specify the mask length (32 bits maximum) that is to be ANDed with the group address before the hash function is called. All groups with the same seed hash correspond to the same RP. For example, if this value is 24, only the first 24 bits of the group addresses matter. • (Optional) For <i>priority</i>, enter a number from 0 to 255. The BSR with the larger priority is preferred. If the priority values are the same, the device with the highest IP address is selected as the BSR. The default is 0.
Step 4	end Example: <pre>Device(config)# end</pre>	Returns to privileged EXEC mode.
Step 5	show running-config Example: <pre>Device# show running-config</pre>	Verifies your entries.
Step 6	copy running-config startup-config Example: <pre>Device# copy running-config startup-config</pre>	(Optional) Saves your entries in the configuration file.

Configuring the Candidate RPs

You can configure one or more candidate RPs. Similar to BSRs, the RPs should also have good connectivity to other devices and be in the backbone portion of the network. An RP can serve the entire IP multicast address space or a portion of it. Candidate RPs send candidate RP advertisements to the BSR.

This procedure is optional.

Before you begin

When deciding which devices should be RPs, consider these options:

- In a network of Cisco routers and multilayer switches where only Auto-RP is used, any device can be configured as an RP.
- In a network that includes only Cisco PIMv2 routers and multilayer switches and with routers from other vendors, any device can be used as an RP.
- In a network of Cisco PIMv1 routers, Cisco PIMv2 routers, and routers from other vendors, configure only Cisco PIMv2 routers and multilayer switches as RPs.

Procedure

	Command or Action	Purpose
Step 1	enable Example: Device> enable	Enables privileged EXEC mode. Enter your password if prompted.
Step 2	configure terminal Example: Device# configure terminal	Enters global configuration mode.
Step 3	ip pim rp-candidate <i>interface-id</i> [group-list <i>access-list-number</i>] Example: Device(config)# ip pim rp-candidate gigabitethernet 1/0/5 group-list 10	Configures your device to be a candidate RP. <ul style="list-style-type: none"> • For <i>interface-id</i>, specify the interface whose associated IP address is advertised as a candidate RP address. Valid interfaces include physical ports, port channels, and VLANs. • (Optional) For group-list <i>access-list-number</i>, enter an IP standard access list number from 1 to 99. If no group-list is specified, the device is a candidate RP for all groups.
Step 4	access-list <i>access-list-number</i> {deny permit} <i>source</i> [<i>source-wildcard</i>]	Creates a standard access list, repeating the command as many times as necessary.

	Command or Action	Purpose
	<p>Example:</p> <pre>Device(config)# access-list 10 permit 239.0.0.0 0.255.255.255</pre>	<ul style="list-style-type: none"> • For <i>access-list-number</i>, enter the access list number specified in Step 2. • The deny keyword denies access if the conditions are matched. The permit keyword permits access if the conditions are matched. • For <i>source</i>, enter the number of the network or host from which the packet is being sent. • (Optional) For <i>source-wildcard</i>, enter the wildcard bits in dotted decimal notation to be applied to the source. Place ones in the bit positions that you want to ignore. <p>The access list is always terminated by an implicit deny statement for everything.</p>
Step 5	<p>end</p> <p>Example:</p> <pre>Device(config)# end</pre>	Returns to privileged EXEC mode.
Step 6	<p>show running-config</p> <p>Example:</p> <pre>Device# show running-config</pre>	Verifies your entries.
Step 7	<p>copy running-config startup-config</p> <p>Example:</p> <pre>Device# copy running-config startup-config</pre>	(Optional) Saves your entries in the configuration file.

Configuring Sparse Mode with Auto-RP

Before you begin

- All access lists that are needed when Auto-RP is configured should be configured prior to beginning the configuration task.



- Note**
- If a group has no known RP and the interface is configured to be sparse-dense mode, the interface is treated as if it were in dense mode, and data is flooded over the interface. To avoid this data flooding, configure the Auto-RP listener and then configure the interface as sparse mode.
 - When configuring Auto-RP, you must either configure the Auto-RP listener feature (Step 5) and specify sparse mode (Step 7).
 - When you configure sparse-dense mode, dense mode failover may result in a network dense-mode flood. To avoid this condition, use PIM sparse mode with the Auto-RP listener feature.

Follow this procedure to configure auto-rendezvous point (Auto-RP). Auto-RP can also be optionally used with anycast RP.

Procedure

	Command or Action	Purpose
Step 1	enable Example: Device> enable	Enables privileged EXEC mode. <ul style="list-style-type: none"> • Enter your password if prompted.
Step 2	configure terminal Example: Device# configure terminal	Enters global configuration mode.
Step 3	ip multicast-routing Example: Device(config)# ip multicast-routing	Enables IP multicast routing.
Step 4	Either perform Steps 5 through 7 or perform Steps 6 and 8.	--
Step 5	interface <i>type number</i> Example: Device(config)# interface Gigabitethernet 1/0/0	Selects an interface that is connected to hosts on which PIM can be enabled.
Step 6	ip pim sparse-mode Example: Device(config-if)# ip pim sparse-mode	Enables PIM sparse mode on an interface. When configuring Auto-RP in sparse mode, you must also configure the Auto-RP listener in the next step. <ul style="list-style-type: none"> • Skip this step if you are configuring sparse-dense mode in Step 8.

	Command or Action	Purpose
Step 7	exit Example: <pre>Device(config-if)# exit</pre>	Exits interface configuration mode and returns to global configuration mode.
Step 8	Repeat Steps 1 through 9 on all PIM interfaces.	--
Step 9	ip pim send-rp-announce <i>{interface-type interface-number ip-address}</i> scope <i>ttl-value</i> [group-list <i>access-list</i>] [interval <i>seconds</i>] [bidir] Example: <pre>Device(config)# ip pim send-rp-announce loopback0 scope 31 group-list 5</pre>	<p>Sends RP announcements out all PIM-enabled interfaces.</p> <ul style="list-style-type: none"> • Perform this step on the RP device only. • Use the <i>interface-type</i> and <i>interface-number</i> arguments to define which IP address is to be used as the RP address. • Use the <i>ip-address</i> argument to specify a directly connected IP address as the RP address. <p>Note If the <i>ip-address</i> argument is configured for this command, the RP-announce message will be sourced by the interface to which this IP address is connected (that is, the source address in the IP header of the RP-announce message is the IP address of that interface).</p> <ul style="list-style-type: none"> • This example shows that the interface is enabled with a maximum of 31 hops. The IP address by which the device wants to be identified as RP is the IP address associated with loopback interface 0. Access list 5 describes the groups for which this device serves as RP.
Step 10	ip pim send-rp-discovery [<i>interface-type interface-number</i>] scope <i>ttl-value</i> [interval <i>seconds</i>] Example: <pre>Device(config)# ip pim send-rp-discovery loopback 1 scope 31</pre>	<p>Configures the device to be an RP mapping agent.</p> <ul style="list-style-type: none"> • Perform this step on RP mapping agent devices or on combined RP/RP mapping agent devices.

	Command or Action	Purpose
		<p>Note Auto-RP allows the RP function to run separately on one device and the RP mapping agent to run on one or multiple devices. It is possible to deploy the RP and the RP mapping agent on a combined RP/RP mapping agent device.</p> <ul style="list-style-type: none"> • Use the optional <i>interface-type</i> and <i>interface-number</i> arguments to define which IP address is to be used as the source address of the RP mapping agent. • Use the scope keyword and <i>ttl-value</i> argument to specify the Time-to-Live (TTL) value in the IP header of Auto-RP discovery messages. • Use the optional interval keyword and <i>seconds</i> argument to specify the interval at which Auto-RP discovery messages are sent. <p>Note Lowering the interval at which Auto-RP discovery messages are sent from the default value of 60 seconds results in more frequent floodings of the group-to-RP mappings. In some network environments, the disadvantages of lowering the interval (more control packet overhead) may outweigh the advantages (more frequent group-to-RP mapping updates).</p> <ul style="list-style-type: none"> • The example shows limiting the Auto-RP discovery messages to 31 hops on loopback interface 1.
<p>Step 11</p>	<p>ip pim rp-announce-filter rp-list <i>access-list</i> group-list <i>access-list</i></p> <p>Example:</p> <pre>Device(config)# ip pim rp-announce-filter rp-list 1 group-list 2</pre>	<p>Filters incoming RP announcement messages sent from candidate RPs (C-RPs) to the RP mapping agent.</p> <ul style="list-style-type: none"> • Perform this step on the RP mapping agent only.
<p>Step 12</p>	<p>interface <i>type number</i></p> <p>Example:</p>	<p>Selects an interface that is connected to hosts on which PIM can be enabled.</p>

	Command or Action	Purpose
	Device (config)# interface gigabitethernet 1/0/0	
Step 13	ip multicast boundary <i>access-list</i> [filter-autorp] Example: Device (config-if)# ip multicast boundary 10 filter-autorp	Configures an administratively scoped boundary. <ul style="list-style-type: none"> • Perform this step on the interfaces that are boundaries to other devices. • The access list is not shown in this task. • An access list entry that uses the deny keyword creates a multicast boundary for packets that match that entry.
Step 14	end Example: Device (config-if)# end	Returns to global configuration mode.
Step 15	show ip pim autorp Example: Device# show ip pim autorp	(Optional) Displays the Auto-RP information.
Step 16	show ip pim rp [mapping] [rp-address] Example: Device# show ip pim rp mapping	(Optional) Displays RPs known in the network and shows how the device learned about each RP.
Step 17	show ip igmp groups [<i>group-name</i> <i>group-address</i> <i>interface-type</i> <i>interface-number</i>] [detail] Example: Device# show ip igmp groups	(Optional) Displays the multicast groups having receivers that are directly connected to the device and that were learned through Internet Group Management Protocol (IGMP). <ul style="list-style-type: none"> • A receiver must be active on the network at the time that this command is issued in order for receiver information to be present on the resulting display.
Step 18	show ip mroute [<i>group-address</i> <i>group-name</i>] [<i>source-address</i> <i>source-name</i>] [<i>interface-type</i> <i>interface-number</i>] [summary] [count] [active <i>kbps</i>] Example: Device# show ip mroute cbone-audio	(Optional) Displays the contents of the IP multicast routing (mroute) table.

Configuring IPv4 Bidirectional PIM

This section provides information about configuring Bidirectional PIM.

Enabling Bidirectional PIM Globally

To enable IPv4 bidirectional PIM, perform this task:

Before you begin

Before configuring bidirectional PIM, ensure that the feature is supported on all IP multicast-enabled routers in that domain. It is not possible to enable groups for bidirectional PIM operation in a partially upgraded network. Packet loops will occur immediately in networks that are only partially upgraded to support bidirectional PIM.

Procedure

	Command or Action	Purpose
Step 1	enable Example: Device> enable	Enables privileged EXEC mode. <ul style="list-style-type: none">• Enter your password if prompted.
Step 2	configure terminal Example: Device# configure terminal	Enters global configuration mode.
Step 3	ip pim bidir-enable Example: Device(config)# ip pim bidir-enable	Enables IPv4 bidirectional PIM globally on the device.

Configuring the Rendezvous Point for IPv4 Bidirectional PIM Groups

To statically configure the rendezvous point for an IPv4 bidirectional PIM group, perform this task:

Before you begin

Before configuring rendezvous points for IPv4 Bidirectional PIM groups, ensure that you have enabled bidirectional PIM globally.

Procedure

	Command or Action	Purpose
Step 1	ip pim [vrf vrf-name] rp-address ip-address [access-list] [override] bidir Example: Device(config)# ip pim rp-address 10.0.0.1 10 override bidir	Statically configures the IP address of the rendezvous point for the group. When you specify the override option, the static rendezvous point is used.

	Command or Action	Purpose
Step 2	access-list <i>access-list</i> [permit deny] <i>ip-address</i> Example: Device(config)# access-list 10 permit 224.1.0.0 0.0.255.255	Configures an access list.
Step 3	ip pim [<i>vrf vrf-name</i>] send-rp-announce <i>interface-type interface-number scope ttl-value</i> [group-list <i>access-list</i>] [interval <i>seconds</i>] [bidir] Example: Device(config)# ip pim send-rp-announce Loopback0 scope 16 group-list c21-rp-list-0 bidir	Configures the system to use auto-RP to configure groups for which the router will act as a rendezvous point (RP).
Step 4	ip access-list standard <i>access-list-name</i> [permit deny] <i>ip-address</i> Example: Device(config)# ip access-list standard c21-rp-list-0 permit 230.31.31.1 0.0.255.255	Configures a standard IP access list.

Delaying the Use of PIM Shortest-Path Tree

Perform these steps to configure a traffic rate threshold that must be reached before multicast routing is switched from the source tree to the shortest-path tree.

This procedure is optional.

Procedure

	Command or Action	Purpose
Step 1	enable Example: Device> enable	Enables privileged EXEC mode. <ul style="list-style-type: none"> • Enter your password if prompted.
Step 2	configure terminal Example: Device# configure terminal	Enters global configuration mode.
Step 3	access-list <i>access-list-number</i> { deny permit } <i>source</i> [<i>source-wildcard</i>] Example:	Creates a standard access list. <ul style="list-style-type: none"> • For <i>access-list-number</i>, the range is 1 to 99.

	Command or Action	Purpose
	<pre>Device(config)# access-list 16 permit 225.0.0.0 0.255.255.255</pre>	<ul style="list-style-type: none"> • The deny keyword denies access if the conditions are matched. • The permit keyword permits access if the conditions are matched. • For <i>source</i>, specify the multicast group to which the threshold will apply. • (Optional) For <i>source-wildcard</i>, enter the wildcard bits in dotted decimal notation to be applied to the source. Place ones in the bit positions that you want to ignore. <p>The access list is always terminated by an implicit deny statement for everything.</p>
Step 4	<p>ip pim spt-threshold {<i>kbps</i> infinity} [group-list <i>access-list-number</i>]</p> <p>Example:</p> <pre>Device(config)# ip pim spt-threshold infinity group-list 16</pre>	<p>Specifies the threshold that must be reached before moving to shortest-path tree (spt).</p> <ul style="list-style-type: none"> • For <i>kbps</i>, specify the traffic rate in kilobits per second. The default is 0 kbps. <p>Note Because of device hardware limitations, 0 kbps is the only valid entry even though the range is 0 to 4294967.</p> <ul style="list-style-type: none"> • Specify infinity if you want all sources for the specified group to use the shared tree, never switching to the source tree. • (Optional) For group-list <i>access-list-number</i>, specify the access list created in Step 2. If the value is 0 or if the group list is not used, the threshold applies to all groups.
Step 5	<p>end</p> <p>Example:</p> <pre>Device(config)# end</pre>	<p>Returns to privileged EXEC mode.</p>
Step 6	<p>show running-config</p> <p>Example:</p> <pre>Device# show running-config</pre>	<p>Verifies your entries.</p>

	Command or Action	Purpose
Step 7	copy running-config startup-config Example: <pre>Device# copy running-config startup-config</pre>	(Optional) Saves your entries in the configuration file.

Modifying the PIM Router-Query Message Interval

PIM routers and multilayer switches send PIM router-query messages to find which device will be the designated router (DR) for each LAN segment (subnet). The DR is responsible for sending IGMP host-query messages to all hosts on the directly connected LAN.

With PIM DM operation, the DR has meaning only if IGMPv1 is in use. IGMPv1 does not have an IGMP querier election process, so the elected DR functions as the IGMP querier. With PIM-SM operation, the DR is the device that is directly connected to the multicast source. It sends PIM register messages to notify the RP that multicast traffic from a source needs to be forwarded down the shared tree. In this case, the DR is the device with the highest IP address.

This procedure is optional.

Procedure

	Command or Action	Purpose
Step 1	enable Example: <pre>Device> enable</pre>	Enables privileged EXEC mode. Enter your password if prompted.
Step 2	configure terminal Example: <pre>Device# configure terminal</pre>	Enters global configuration mode.
Step 3	interface <i>interface-id</i> Example: <pre>Device(config)# interface gigabitethernet 1/0/1</pre>	Specifies the interface to be configured, and enters interface configuration mode. The specified interface must be one of the following: <ul style="list-style-type: none"> • A routed port—A physical port that has been configured as a Layer 3 port by entering the no switchport interface configuration command. • An SVI—A VLAN interface created by using the interface vlan <i>vlan-id</i> global configuration command.

	Command or Action	Purpose
		These interfaces must have IP addresses assigned to them.
Step 4	ip pim query-interval <i>seconds</i> Example: <pre>Device(config-if)# ip pim query-interval 45</pre>	Configures the frequency at which the device sends PIM router-query messages. The default is 30 seconds. The range is 1 to 65535.
Step 5	end Example: <pre>Device(config)# end</pre>	Returns to privileged EXEC mode.
Step 6	show ip igmp interface [<i>interface-id</i>] Example: <pre>Device# show ip igmp interface</pre>	Verifies your entries.
Step 7	copy running-config startup-config Example: <pre>Device# copy running-config startup-config</pre>	(Optional) Saves your entries in the configuration file.

Verifying PIM Operations

Verifying IP Multicast Operation in a PIM-SM or a PIM-SSM Network

When you verify the operation of IP multicast in a PIM-SM network environment or in an PIM-SSM network environment, a useful approach is to begin the verification process on the last hop router, and then continue the verification process on the routers along the SPT until the first hop router has been reached. The goal of the verification is to ensure that IP multicast traffic is being routed properly through an IP multicast network.

Perform the following optional tasks to verify IP multicast operation in a PIM-SM or a PIM-SSM network. The steps in these tasks help to locate a faulty hop when sources and receivers are not operating as expected.



Note If packets are not reaching their expected destinations, you might want consider disabling IP multicast fast switching, which would place the router in process switching mode. If packets begin reaching their proper destinations after IP multicast fast switching has been disabled, then the issue most likely was related to IP multicast fast switching.

Verifying IP Multicast on the First Hop Router

Enter these commands on the first hop router to verify IP multicast operations on the first hop router:

Procedure

	Command or Action	Purpose
Step 1	enable Example: Device> enable	Enables privileged EXEC mode. <ul style="list-style-type: none"> • Enter your password if prompted.
Step 2	show ip mroute [<i>group-address</i>] Example: Device# show ip mroute 239.1.2.3 (*, 239.1.2.3), 00:18:10/stopped, RP 172.16.0.1, flags: SPF Incoming interface: Serial1/0, RPF nbr 172.31.200.2 Outgoing interface list: Null (10.0.0.1, 239.1.2.3), 00:18:10/00:03:22, flags: FT Incoming interface: GigabitEthernet0/0/0, RPF nbr 0.0.0.0 Outgoing interface list: Serial1/0, Forward/Sparse, 00:18:10/00:03:19	Confirms that the F flag has been set for mroutes on the first hop router.
Step 3	show ip mroute active [<i>kb/s</i>] Example: Device# show ip mroute active Active IP Multicast Sources - sending >= 4 kbps	Displays information about active multicast sources sending to groups. The output of this command provides information about the multicast packet rate for active sources.

	Command or Action	Purpose
	<pre>Group: 239.1.2.3, (?) Source: 10.0.0.1 (?) Rate: 20 pps/4 kbps(1sec), 4 kbps(last 30 secs), 4 kbps(life avg)</pre>	<p>Note By default, the output of the show ip mroute command with the active keyword displays information about active sources sending traffic to groups at a rate greater than or equal to 4 kb/s. To display information about active sources sending low-rate traffic to groups (that is, traffic less than 4 kb/s), specify a value of 1 for the <i>kb/s</i> argument. Specifying a value of 1 for this argument displays information about active sources sending traffic to groups at a rate equal to or greater than 1 kb/s, which effectively displays information about all possible active source traffic.</p>

Verifying IP Multicast on Routers Along the SPT

Enter these commands on routers along the SPT to verify IP multicast operations on routers along the SPT in a PIM-SM or PIM-SSM network:

Procedure

	Command or Action	Purpose
<p>Step 1</p>	<p>enable</p> <p>Example:</p> <pre>Device> enable</pre>	<p>Enables privileged EXEC mode.</p> <ul style="list-style-type: none"> • Enter your password if prompted.
<p>Step 2</p>	<p>show ip mroute [<i>group-address</i>]</p> <p>Example:</p> <pre>Device# show ip mroute 239.1.2.3 (*, 239.1.2.3), 00:17:56/00:03:02, RP 172.16.0.1, flags: S Incoming interface: Null, RPF nbr 0.0.0.0 Outgoing interface list: GigabitEthernet0/0/0, Forward/Sparse, 00:17:56/00:03:02 (10.0.0.1, 239.1.2.3), 00:15:34/00:03:28, flags: T Incoming interface: Serial1/0, RPF nbr 172.31.200.1 Outgoing interface list:</pre>	<p>Confirms the RPF neighbor towards the source for a particular group or groups.</p>

	Command or Action	Purpose
	GigabitEthernet0/0/0, Forward/Sparse, 00:15:34/00:03:02	
Step 3	<p>show ip mroute active</p> <p>Example:</p> <pre>Device# show ip mroute active Active IP Multicast Sources - sending >= 4 kbps Group: 239.1.2.3, (?) Source: 10.0.0.1 (?) Rate: 20 pps/4 kbps(1sec), 4 kbps(last 30 secs), 4 kbps(life avg)</pre>	<p>Displays information about active multicast sources sending to groups. The output of this command provides information about the multicast packet rate for active sources.</p> <p>Note By default, the output of the show ip mroute command with the active keyword displays information about active sources sending traffic to groups at a rate greater than or equal to 4 kb/s. To display information about active sources sending low-rate traffic to groups (that is, traffic less than 4 kb/s), specify a value of 1 for the <i>kb/s</i> argument. Specifying a value of 1 for this argument displays information about active sources sending traffic to groups at a rate equal to or greater than 1 kb/s, which effectively displays information about all possible active source traffic.</p>

Verifying IP Multicast Operation on the Last Hop Router

Enter these commands on the last hop router to verify IP multicast operations on the last hop router:

Procedure

	Command or Action	Purpose
Step 1	<p>enable</p> <p>Example:</p> <pre>Device> enable</pre>	<p>Enables privileged EXEC mode.</p> <ul style="list-style-type: none"> • Enter your password if prompted.
Step 2	<p>show ip igmp groups</p> <p>Example:</p> <pre>Device# show ip igmp groups IGMP Connected Group Membership Group Address Interface Uptime Expires Last Reporter 239.1.2.3 GigabitEthernet1/0/0 00:05:14 00:02:14 10.1.0.6</pre>	<p>Verifies IGMP memberships on the last hop router. This information will confirm the multicast groups with receivers that are directly connected to the last hop router and that are learned through IGMP.</p>

	Command or Action	Purpose
	<pre>224.0.1.39 GigabitEthernet0/0/0 00:09:11 00:02:08 172.31.100.1</pre>	
<p>Step 3</p>	<p>show ip pim rp mapping</p> <p>Example:</p> <pre>Device# show ip pim rp mapping PIM Group-to-RP Mappings Group(s) 224.0.0.0/4 RP 172.16.0.1 (?), v2v1 Info source: 172.16.0.1 (?), elected via Auto-RP Uptime: 00:09:11, expires: 00:02:47</pre>	<p>Confirms that the group-to-RP mappings are being populated correctly on the last hop router.</p> <p>Note Ignore this step if you are verifying a last hop router in a PIM-SSM network. The show ip pim rp mapping command does not work with routers in a PIM-SSM network because PIM-SSM does not use RPs. In addition, if configured correctly, PIM-SSM groups do not appear in the output of the show ip pim rp mapping command.</p>
<p>Step 4</p>	<p>show ip mroute</p> <p>Example:</p> <pre>Device# show ip mroute (*, 239.1.2.3), 00:05:14/00:03:04, RP 172.16.0.1, flags: SJC Incoming interface: GigabitEthernet0/0/0, RPF nbr 172.31.100.1 Outgoing interface list: GigabitEthernet1/0, Forward/Sparse, 00:05:10/00:03:04 (10.0.0.1, 239.1.2.3), 00:02:49/00:03:29, flags: T Incoming interface: GigabitEthernet0/0/0, RPF nbr 172.31.100.1 Outgoing interface list: GigabitEthernet1/0, Forward/Sparse, 00:02:49/00:03:04 (*, 224.0.1.39), 00:10:05/stopped, RP 0.0.0.0, flags: DC Incoming interface: Null, RPF nbr 0.0.0.0 Outgoing interface list: GigabitEthernet1/0, Forward/Sparse, 00:05:15/00:00:00 GigabitEthernet0/0, Forward/Sparse, 00:10:05/00:00:00 (172.16.0.1, 224.0.1.39), 00:02:00/00:01:33, flags: PTX Incoming interface: GigabitEthernet0/0/0, RPF nbr 172.31.100.1</pre>	<p>Verifies that the mroute table is being populated properly on the last hop router.</p>

	Command or Action	Purpose
Step 5	<p>show ip interface <i>[type number]</i></p> <p>Example:</p> <pre>Device# show ip interface GigabitEthernet 0/0/0 GigabitEthernet0/0/0 is up, line protocol is up Internet address is 172.31.100.2/24 Broadcast address is 255.255.255.255 Address determined by setup command MTU is 1500 bytes Helper address is not set Directed broadcast forwarding is disabled Multicast reserved groups joined: 224.0.0.1 224.0.0.22 224.0.0.13 224.0.0.5 224.0.0.6 Outgoing access list is not set Inbound access list is not set Proxy ARP is enabled Local Proxy ARP is disabled Security level is default Split horizon is enabled ICMP redirects are always sent ICMP unreachable are always sent ICMP mask replies are never sent IP fast switching is enabled IP fast switching on the same interface is disabled IP Flow switching is disabled IP CEF switching is disabled IP Fast switching turbo vector IP multicast fast switching is enabled IP route-cache flags are Fast Router Discovery is disabled IP output packet accounting is disabled IP access violation accounting is disabled TCP/IP header compression is disabled RTP/IP header compression is disabled Policy routing is disabled Network address translation is disabled WCCP Redirect outbound is disabled WCCP Redirect inbound is disabled WCCP Redirect exclude is disabled BGP Policy Mapping is disabled</pre>	<p>Verifies that multicast fast switching is enabled for optimal performance on the outgoing interface on the last hop router.</p> <p>Note Using the no ip mroute-cache interface command disables IP multicast fast-switching. When IP multicast fast switching is disabled, packets are forwarded through the process-switched path.</p>
Step 6	<p>show ip mfib</p> <p>Example:</p> <pre>Device# show ip mfib</pre>	<p>Displays the forwarding entries and interfaces in the IP Multicast Forwarding Information Base (MFIB).</p>
Step 7	<p>show ip pim interface count</p> <p>Example:</p> <pre>Device# show ip pim interface count</pre>	<p>Confirms that multicast traffic is being forwarded on the last hop router.</p>

	Command or Action	Purpose
	<pre> State: * - Fast Switched, H - Hardware Switching Enabled Address Interface FS Mpackets In/Out 172.31.100.2 GigabitEthernet0/0/0 * 4122/0 10.1.0.1 GigabitEthernet1/0/0 * 0/3193 </pre>	
Step 8	<p>show ip mroute count</p> <p>Example:</p> <pre> Device# show ip mroute count IP Multicast Statistics 6 routes using 4008 bytes of memory 3 groups, 1.00 average sources per group Forwarding Counts: Pkt Count/Pkts per second/Avg Pkt Size/Kilobits per second Other counts: Total/RPF failed/Other drops (OIF-null, rate-limit etc) Group: 239.1.2.3, Source count: 1, Packets forwarded: 3165, Packets received: 3165 RP-tree: Forwarding: 0/0/0/0, Other: 0/0/0 Source: 10.0.0.1/32, Forwarding: 3165/20/28/4, Other: 0/0/0 Group: 224.0.1.39, Source count: 1, Packets forwarded: 21, Packets received: 120 Source: 172.16.0.1/32, Forwarding: 21/1/48/0, Other: 120/0/99 Group: 224.0.1.40, Source count: 1, Packets forwarded: 10, Packets received: 10 Source: 172.16.0.1/32, Forwarding: 10/1/48/0, Other: 10/0/0 </pre>	Confirms that multicast traffic is being forwarded on the last hop router.
Step 9	<p>show ip mroute active [kb/s]</p> <p>Example:</p> <pre> Device# show ip mroute active Active IP Multicast Sources - sending >= 4 kbps </pre>	Displays information about active multicast sources sending traffic to groups on the last hop router. The output of this command provides information about the multicast packet rate for active sources.

	Command or Action	Purpose
	<pre>Group: 239.1.2.3, (?) Source: 10.0.0.1 (?) Rate: 20 pps/4 kbps(1sec), 4 kbps(last 50 secs), 4 kbps(life avg)</pre>	<p>Note By default, the output of the show ip mroute command with the active keyword displays information about active sources sending traffic to groups at a rate greater than or equal to 4 kb/s. To display information about active sources sending low-rate traffic to groups (that is, traffic less than 4 kb/s), specify a value of 1 for the <i>kb/s</i> argument. Specifying a value of 1 for this argument displays information about active sources sending traffic to groups at a rate equal to or greater than 1 kb/s, which effectively displays information about all possible active source traffic.</p>

Using PIM-Enabled Routers to Test IP Multicast Reachability

If all the PIM-enabled routers and access servers that you administer are members of a multicast group, pinging that group causes all routers to respond, which can be a useful administrative and debugging tool.

To use PIM-enabled routers to test IP multicast reachability, perform the following tasks:

Configuring Routers to Respond to Multicast Pings

Follow these steps to configure a router to respond to multicast pings. Perform the task on all the interfaces of a router and on all the routers participating in the multicast network:

Procedure

	Command or Action	Purpose
Step 1	<pre>enable</pre> <p>Example:</p> <pre>Device> enable</pre>	Enables privileged EXEC mode. Enter your password if prompted.
Step 2	<pre>configure terminal</pre> <p>Example:</p> <pre>Device# configure terminal</pre>	Enters global configuration mode.
Step 3	<pre>interface type number</pre> <p>Example:</p>	Enters interface configuration mode.

	Command or Action	Purpose
	Device(config)# interface gigabitethernet 1/0/0	For the <i>type</i> and <i>number</i> arguments, specify an interface that is directly connected to hosts or is facing hosts.
Step 4	ip igmp join-group <i>group-address</i> Example: Device(config-if)# ip igmp join-group 225.2.2.2	(Optional) Configures an interface on the router to join the specified group. For the purpose of this task, configure the same group address for the <i>group-address</i> argument on all interfaces on the router participating in the multicast network. Note With this method, the router accepts the multicast packets in addition to forwarding them. Accepting the multicast packets prevents the router from fast switching.
Step 5	Repeat Step 3 and Step 4 for each interface on the router participating in the multicast network.	--
Step 6	end Example: Device(config-if)# end	Ends the current configuration session and returns to privileged EXEC mode.

Pinging Routers Configured to Respond to Multicast Pings

Follow these steps on a router to initiate a ping test to the routers configured to respond to multicast pings. This task is used to test IP multicast reachability in a network.

Procedure

	Command or Action	Purpose
Step 1	enable Example: Device> enable	Enables privileged EXEC mode. Enter your password if prompted.
Step 2	ping <i>group-address</i> Example: Device# ping 225.2.2.2	Pings an IP multicast group address. A successful response indicates that the group address is functioning.

Monitoring and Troubleshooting PIM

Monitoring PIM Information

Use the privileged EXEC commands in the following table to monitor your PIM configurations.

Table 2: PIM Monitoring Commands

Command	Purpose
show ip pim all-vrfs tunnel [tunnel <i>tunnel_number</i> verbose]	Displays all VRFs.
show ip pim autorp	Displays global auto-RP information.
show ip pim boundary	Displays information about mroutes filtered by administratively scoped IPv4 multicast boundaries configured on an interface.
show ip pim interface	Displays information about interfaces configured for Protocol Independent Multicast (PIM).
show ip pim neighbor	Displays the PIM neighbor information.
show ip pim rp [<i>group-name</i> <i>group-address</i>]	Displays RP routers associated with a sparse-mode multicast group. This command is available in all software images.
show ip pim tunnel [tunnel verbose]	Displays information about Protocol Independent Multicast (PIM) tunnel interfaces
show ip pim vrf { word { all-vrfs autorp boundary bsr-router interface mdt neighbor rp rp-hash tunnel } }	Displays the VPN routing/forwarding instance.
show ip igmp groups detail	Displays the interested clients that have joined the specific multicast source group.

Monitoring the RP Mapping and BSR Information

Use the privileged EXEC mode in the following table to verify the consistency of group-to-RP mappings:

Table 3: RP Mapping Monitoring Commands

Command	Purpose
show ip pim rp [<i>hostname</i> or <i>IP address</i> mapping [<i>hostname</i> or <i>IP address</i> elected in-use] metric [<i>hostname</i> or <i>IP address</i>]]	<p>Displays all available RP mappings and metrics. This tells you how the device learns of the RP (through the BSR or the Auto-RP mechanism).</p> <ul style="list-style-type: none"> • (Optional) For the <i>hostname</i>, specify the IP name of the group about which to display RPs. • (Optional) For the <i>IP address</i>, specify the IP address of the group about which to display RPs. • (Optional) Use the mapping keyword to display all group-to-RP mappings of which the Cisco device is aware (either configured or learned from Auto-RP). • (Optional) Use the metric keyword to display the RP RPF metric.
show ip pim rp-hash <i>group</i>	Displays the RP that was selected for the specified group. That is, on a PIMv2 router or multilayer switch, confirms that the same RP is the one that a PIMv1 system chooses. For <i>group</i> , enter the group address for which to display RP information.

Use the privileged EXEC commands in the following table to monitor BSR information:

Table 4: BSR Monitoring Commands

Command	Purpose
show ip pim bsr	Displays information about the elected BSR.
show ip pim bsr-router	Displays information about the BSRv2.

Troubleshooting PIMv1 and PIMv2 Interoperability Problems

When debugging interoperability problems between PIMv1 and PIMv2, check these in the order shown:

1. Verify RP mapping with the **show ip pim rp-hash** privileged EXEC command, making sure that all systems agree on the same RP for the same group.
2. Verify interoperability between different versions of DRs and RPs. Make sure that the RPs are interacting with the DRs properly (by responding with register-stops and forwarding decapsulated data packets from registers).

Monitoring IPv4 Bidirectional PIM Information

Use the privileged EXEC commands in the following table to monitor your Bidirectional PIM configurations.

Command	Purpose
<code>show ip mfib</code>	Displays MFIB information for bidirectional PIM.
<code>show platform software fed switch {switch-number active standby } ip multicast groups</code>	Displays platform-dependent IP multicast tables and other information.
<code>show ip pim [vrf vrf-name] interface interface-type interface-number df [rp-address]</code>	Displays information about interfaces configured for PIM.
<code>show ip pim [vrf vrf-name] rp [mapping metric] [rp-address]</code>	Displays active rendezvous points (RPs) that are cached with associated multicast routing entries.
<code>show platform software fed switch {switch-number active standby } ip multicast df [vrf-id vrf-id vrf-name vrf-name] [df-index]</code>	Displays information about IP multicast designated forwarders (DF).

Configuration Examples for PIM

Example: Enabling PIM Stub Routing

In this example, IP multicast routing is enabled, Switch A PIM uplink port 25 is configured as a routed uplink port with **sparse-dense-mode** enabled. PIM stub routing is enabled on the VLAN 100 interfaces and on Gigabit Ethernet port 20.

```
Device(config)# ip multicast-routing
Device(config)# interface GigabitEthernet3/0/25
Device(config-if)# no switchport
Device(config-if)# ip address 3.1.1.2 255.255.255.0
Device(config-if)# ip pim sparse-dense-mode
Device(config-if)# exit
Device(config)# interface vlan100
Device(config-if)# ip pim passive
Device(config-if)# exit
Device(config)# interface GigabitEthernet3/0/20
Device(config-if)# ip pim passive
Device(config-if)# exit
Device(config)# interface vlan100
Device(config-if)# ip address 100.1.1.1 255.255.255.0
Device(config-if)# ip pim passive
Device(config-if)# exit
Device(config)# interface GigabitEthernet3/0/20
Device(config-if)# no switchport
Device(config-if)# ip address 10.1.1.1 255.255.255.0
Device(config-if)# ip pim passive
Device(config-if)# end
```

Example: Verifying PIM Stub Routing

To verify that PIM stub is enabled for each interface, use the **show ip pim interface** command in privileged EXEC mode:

```
Device# show ip pim interface
Address Interface Ver/ Nbr Query DR DR
Mode Count Intvl Prior
3.1.1.2 GigabitEthernet3/0/25 v2/SD 1 30 1 3.1.1.2
100.1.1.1 Vlan100 v2/P 0 30 1 100.1.1.1
10.1.1.1 GigabitEthernet3/0/20 v2/P 0 30 1 10.1.1.1
```

Example: Manually Assigning an RP to Multicast Groups

This example shows how to configure the address of the RP to 147.106.6.22 for multicast group 225.2.2.2 only:

```
Device(config)# access-list 1 permit 225.2.2.2 0.0.0.0
Device(config)# ip pim rp-address 147.106.6.22 1
```

Example: Configuring Auto-RP

This example shows how to send RP announcements out all PIM-enabled interfaces for a maximum of 31 hops. The IP address of port 1 is the RP. Access list 5 describes the group for which this device serves as RP:

```
Device(config)# ip pim send-rp-announce gigabitethernet1/0/1 scope 31 group-list 5
Device(config)# access-list 5 permit 224.0.0.0 15.255.255.255
```

Example: Sparse Mode with Auto-RP

The following example configures sparse mode with Auto-RP:

```
Device(config)# ip multicast-routing
Device(config)# ip pim autorp listener
Device(config)# ip pim send-rp-announce Loopback0 scope 16 group-list 1
Device(config)# ip pim send-rp-discovery Loopback1 scope 16
Device(config)# no ip pim dm-fallback
Device(config)# access-list 1 permit 239.254.2.0 0.0.0.255
Device(config)# access-list 1 permit 239.254.3.0 0.0.0.255
.
.
.
Device(config)# access-list 10 permit 224.0.1.39
Device(config)# access-list 10 permit 224.0.1.40
Device(config)# access-list 10 permit 239.254.2.0 0.0.0.255
Device(config)# access-list 10 permit 239.254.3.0 0.0.0.255
```

Example: Defining the IP Multicast Boundary to Deny Auto-RP Information

This example shows a portion of an IP multicast boundary configuration that denies Auto-RP information:

```
Device(config)# access-list 1 deny 224.0.1.39
Device(config)# access-list 1 deny 224.0.1.40
Device(config)# access-list 1 permit all
Device(config)# interface gigabitethernet1/0/1
Device(config-if)# ip multicast boundary 1
```

Example: Filtering Incoming RP Announcement Messages

This example shows a sample configuration on an Auto-RP mapping agent that is used to prevent candidate RP announcements from being accepted from unauthorized candidate RPs:

```
Device(config)# ip pim rp-announce-filter rp-list 10 group-list 20
Device(config)# access-list 10 permit host 172.16.5.1
Device(config)# access-list 10 permit host 172.16.2.1
Device(config)# access-list 20 deny 239.0.0.0 0.0.255.255
Device(config)# access-list 20 permit 224.0.0.0 15.255.255.255
```

The mapping agent accepts candidate RP announcements from only two devices, 172.16.5.1 and 172.16.2.1. The mapping agent accepts candidate RP announcements from these two devices only for multicast groups that fall in the group range of 224.0.0.0 to 239.255.255.255. The mapping agent does not accept candidate RP announcements from any other devices in the network. Furthermore, the mapping agent does not accept candidate RP announcements from 172.16.5.1 or 172.16.2.1 if the announcements are for any groups in the 239.0.0.0 through 239.255.255.255 range. This range is the administratively scoped address range.

Example: Preventing Join Messages to False RPs

If all interfaces are in sparse mode, use a default-configured RP to support the two well-known groups 224.0.1.39 and 224.0.1.40. Auto-RP uses these two well-known groups to collect and distribute RP-mapping information. When this is the case and the **ip pim accept-rp auto-rp** command is configured, another **ip pim accept-rp** command accepting the RP must be configured as follows:

```
Device(config)# ip pim accept-rp 172.10.20.1 1
Device(config)# access-list 1 permit 224.0.1.39
Device(config)# access-list 1 permit 224.0.1.40
```

Example: Configuring Candidate BSRs

This example shows how to configure a candidate BSR, which uses the IP address 172.21.24.18 on a port as the advertised BSR address, uses 30 bits as the hash-mask-length, and has a priority of 10.

```
Device(config)# interface gigabitethernet1/0/2
Device(config-if)# ip address 172.21.24.18 255.255.255.0
Device(config-if)# ip pim sparse-mode
Device(config-if)# ip pim bsr-candidate gigabitethernet1/0/2 30 10
```

Example: Configuring Candidate RPs

This example shows how to configure the device to advertise itself as a candidate RP to the BSR in its PIM domain. Standard access list number 4 specifies the group prefix associated with the RP that has the address identified by a port. That RP is responsible for the groups with the prefix 239.

```
Device(config)# ip pim rp-candidate gigabitethernet1/0/2 group-list 4
Device(config)# access-list 4 permit 239.0.0.0 0.255.255.255
```

Feature History for PIM

This table provides release and related information for the features explained in this module.

These features are available in all the releases subsequent to the one they were introduced in, unless noted otherwise.

Release	Feature	Feature Information
Cisco IOS XE Everest 16.5.1a	PIM	The Protocol Independent Multicast (PIM) protocol maintains the current IP multicast service mode of receiver-initiated membership. PIM is not dependent on a specific unicast routing protocol; it is IP routing protocol independent and can leverage whichever unicast routing protocols are used to populate the unicast routing table, including Enhanced Interior Gateway Routing Protocol (EIGRP), Open Shortest Path First (OSPF), Border Gateway Protocol (BGP), and static routes. PIM uses unicast routing information to perform the multicast forwarding function. Support for this feature was introduced only on the C9500-12Q, C9500-16X, C9500-24Q, C9500-40X models of the Cisco Catalyst 9500 Series Switches.
Cisco IOS XE Fuji 16.8.1a	PIM	Support for this feature was introduced only on the C9500-32C, C9500-32QC, C9500-48Y4C, and C9500-24Y4C models of the Cisco Catalyst 9500 Series Switches.
Cisco IOS XE Gibraltar 16.12.1	Bidirectional PIM	Bidirectional PIM is a variant of the PIM suite of routing protocols for IP multicast.

Use the Cisco Feature Navigator to find information about platform and software image support. To access Cisco Feature Navigator, go to <http://www.cisco.com/go/cfn>.

