

31

Spanning Tree Protocols

- [Prerequisites for Spanning Tree Protocols, page 31-1](#)
- [Restrictions for Spanning Tree Protocols, page 31-1](#)
- [Information About Spanning Tree Protocols, page 31-2](#)
- [Default Settings for Spanning Tree Protocols, page 31-25](#)
- [How to Configure Spanning Tree Protocols, page 31-26](#)

**Note**

- For complete syntax and usage information for the commands used in this chapter, see these publications:
http://www.cisco.com/en/US/products/ps11846/prod_command_reference_list.html
 - Cisco IOS Release 15.4SY supports only Ethernet interfaces. Cisco IOS Release 15.4SY does not support any WAN features or commands.
 - This chapter describes the Spanning Tree Protocol (STP) and Multiple Spanning Tree (MST) protocol. For information on configuring the PortFast, UplinkFast, and BackboneFast STP enhancements, see [Chapter 32, “Optional STP Features.”](#)
-

**Tip**

For additional information about Cisco Catalyst 6500 Series Switches (including configuration examples and troubleshooting information), see the documents listed on this page:

http://www.cisco.com/en/US/products/hw/switches/ps708/tsd_products_support_series_home.html

[Participate in the Technical Documentation Ideas forum](#)

Prerequisites for Spanning Tree Protocols

None.

Restrictions for Spanning Tree Protocols

- The 802.1s MST standard allows up to 65 MST instances. You can map an unlimited number of VLANs to an MST instance.
- Rapid PVST+ and MST are supported, but only one version can be active at any time.

- VTP does not propagate the MST configuration. You must manually configure the MST configuration (region name, revision number, and VLAN-to-instance mapping) on each switch within the MST region through the command-line interface (CLI) or SNMP.
- For load balancing across redundant paths in the network to work, all VLAN-to-instance mapping assignments must match; otherwise, all traffic flows on a single link.
- All MST boundary ports must be forwarding for load balancing between a PVST+ and an MST cloud or between a rapid-PVST+ and an MST cloud. For this to occur, the CIST regional root of the MST cloud must be the root of the CST. If the MST cloud consists of multiple MST regions, one of the MST regions must contain the CST root, and all of the other MST regions must have a better path to the root contained within the MST cloud than a path through the rapid-PVST+ cloud.
- Partitioning the network into a large number of regions is not recommended. However, if this situation is unavoidable, we recommend that you partition the switched LAN into smaller LANs interconnected by non-Layer 2 devices.
- Adding or removing VLANs to an existing MST instance will trigger spanning tree recalculation for that MST instance, and the traffic of all the VLANs for that MST instance will be disrupted.
- The **show vlan virtual-port** command displays the number of virtual interfaces. The maximum numbers of virtual interfaces supported on stand-alone switch/VSS system limits are as follows:
 - MST: 100,000 total
 - RPVST+: 12,000 total
 - PVST+: 15,000 total



Note Cisco IOS software displays a message if you exceed the maximum number of virtual interfaces.

Information About Spanning Tree Protocols

- [Information about STP, page 31-2](#)
- [Information about IEEE 802.1w RSTP, page 31-13](#)
- [Information about MST, page 31-18](#)
- [Detecting Unidirectional Link Failure, page 31-25](#)

Information about STP

- [STP Overview, page 31-3](#)
- [Information about the Bridge ID, page 31-3](#)
- [Information about Bridge Protocol Data Units, page 31-4](#)
- [Election of the Root Bridge, page 31-5](#)
- [STP Protocol Timers, page 31-5](#)
- [Creating the Spanning Tree Topology, page 31-5](#)
- [STP Port States, page 31-6](#)
- [STP and IEEE 802.1Q Trunks, page 31-12](#)

STP Overview

STP, the IEEE 802.1D bridge protocol, is a Layer 2 link-management protocol that provides path redundancy while preventing undesirable loops in the network. For a Layer 2 Ethernet network to function properly, only one active path can exist between any two stations. STP operation is transparent to end stations, which cannot detect whether they are connected to a single LAN segment or a switched LAN of multiple segments.

In an extension known as per-VLAN spanning tree (PVST), Layer 2 Ethernet ports can use STP on all VLANs. Rapid-PVST+, enabled by default on each configured VLAN (provided you do not manually disable it), uses RSTP to provide faster convergence. Independent VLANs run their own RSTP instance.

With rapid-PVST+, dynamic entries are flushed immediately on a per-port basis upon receiving a topology change. UplinkFast and BackboneFast configurations are ignored in rapid-PVST+ mode; both features are included in RSTP. Rapid-PVST+ mode supports unidirectional link failure detection as described in the [“Detecting Unidirectional Link Failure” section on page 31-25](#).

When you create fault-tolerant internetworks, you must have a loop-free path between all nodes in a network. The STP algorithm calculates the best loop-free path throughout a switched Layer 2 network. Layer 2 LAN ports send and receive STP frames at regular intervals. Network devices do not forward these frames, but use the frames to construct a loop-free path.

Multiple active paths between end stations cause loops in the network. If a loop exists in the network, end stations might receive duplicate messages and network devices might learn end station MAC addresses on multiple Layer 2 LAN ports. These conditions result in an unstable network.

STP defines a tree with a root bridge and a loop-free path from the root to all network devices in the Layer 2 network. STP forces redundant data paths into a standby (blocked) state. If a network segment in the spanning tree fails and a redundant path exists, the STP algorithm recalculates the spanning tree topology and activates the standby path.

When two Layer 2 LAN ports on a network device are part of a loop, the STP port priority and port path cost setting determine which port is put in the forwarding state and which port is put in the blocking state. The STP port priority value represents the location of a port in the network topology and how efficiently that location allows the port to pass traffic. The STP port path cost value represents media speed.

Information about the Bridge ID

- [Bridge Priority Value, page 31-3](#)
- [Extended System ID, page 31-3](#)
- [STP MAC Address Allocation, page 31-4](#)

Bridge Priority Value

Each VLAN on each network device has a unique 64-bit bridge ID consisting of a bridge priority value, an extended system ID, and an STP MAC address allocation. The bridge priority is a 4-bit value when the extended system ID is enabled (see [Table 31-1 on page 31-4](#) and the [“Configuring the Bridge Priority of a VLAN” section on page 31-34](#)).

Extended System ID

A 12-bit extended system ID field is part of the bridge ID (see [Table 31-1 on page 31-4](#)). Chassis that support only 64 MAC addresses always use the 12-bit extended system ID. On chassis that support 1,024 MAC addresses, you can enable use of the extended system ID.

The extended system ID is enabled by default under the following conditions:

- Chassis that support only 64 MAC addresses
- When the STP mode is MST

STP uses the VLAN ID as the extended system ID. See the [“Enabling the Extended System ID” section on page 31-28](#).

Table 31-1 Bridge Priority Value and Extended System ID with the Extended System ID Enabled

Bridge Priority Value				Extended System ID (Set Equal to the VLAN/MST Instance ID)											
Bit 16	Bit 15	Bit 14	Bit 13	Bit 12	Bit 11	Bit 10	Bit 9	Bit 8	Bit 7	Bit 6	Bit 5	Bit 4	Bit 3	Bit 2	Bit 1
32768	16384	8192	4096	2048	1024	512	256	128	64	32	16	8	4	2	1

STP MAC Address Allocation

The chassis has either 64 or 1024 MAC addresses available to support software features such as STP. To view the MAC address range on your chassis, enter the **show catalyst6000 chassis-mac-address** command.

For chassis with 64 MAC addresses, STP uses the extended system ID plus a MAC address to make the bridge ID unique for each VLAN.

When the extended system ID is not enabled, STP uses one MAC address per VLAN to make the bridge ID unique for each VLAN.

If you have a network device in your network with the extended system ID enabled, you should also enable the extended system ID on all other Layer 2 connected network devices to avoid undesirable root bridge election and spanning tree topology issues.

When the extended system ID is enabled, the root bridge priority becomes a multiple of 4096 plus the VLAN ID. With the extended system ID enabled, a switch bridge ID (used by the spanning tree algorithm to determine the identity of the root bridge, the lowest being preferred) can only be specified as a multiple of 4096. Only the following values are possible: 0, 4096, 8192, 12288, 16384, 20480, 24576, 28672, 32768, 36864, 40960, 45056, 49152, 53248, 57344, and 61440.

If another bridge in the same spanning tree domain does not have the extended system ID enabled, it could win root bridge ownership because of the finer granularity in the selection of its bridge ID.

Information about Bridge Protocol Data Units

Bridge protocol data units (BPDUs) are transmitted in one direction from the root bridge. Each network device sends configuration BPDUs to communicate and compute the spanning tree topology. Each configuration BPDU contains the following minimal information:

- The unique bridge ID of the network device that the transmitting network device believes to be the root bridge
- The STP path cost to the root
- The bridge ID of the transmitting bridge
- Message age
- The identifier of the transmitting port
- Values for the hello, forward delay, and max-age protocol timers

When a network device transmits a BPDU frame, all network devices connected to the LAN on which the frame is transmitted receive the BPDU. When a network device receives a BPDU, it does not forward the frame but instead uses the information in the frame to calculate a BPDU, and, if the topology changes, initiate a BPDU transmission.

A BPDU exchange results in the following:

- One network device is elected as the root bridge.
- The shortest distance to the root bridge is calculated for each network device based on the path cost.
- A designated bridge for each LAN segment is selected. This is the network device closest to the root bridge through which frames are forwarded to the root.
- A root port is selected. This is the port providing the best path from the bridge to the root bridge.
- Ports included in the spanning tree are selected.

Election of the Root Bridge

For each VLAN, the network device with the highest-priority bridge ID (the lowest numerical ID value) is elected as the root bridge. If all network devices are configured with the default priority (32768), the network device with the lowest MAC address in the VLAN becomes the root bridge. The bridge priority value occupies the most significant bits of the bridge ID.

When you change the bridge priority value, you change the probability that the switch will be elected as the root bridge. Configuring a higher-priority value increases the probability; a lower-priority value decreases the probability.

The STP root bridge is the logical center of the spanning tree topology in a Layer 2 network. All paths that are not needed to reach the root bridge from anywhere in the Layer 2 network are placed in STP blocking mode.

BPDU contains information about the transmitting bridge and its ports, including bridge and MAC addresses, bridge priority, port priority, and path cost. STP uses this information to elect the root bridge for the Layer 2 network, to elect the root port leading to the root bridge, and to determine the designated port for each Layer 2 segment.

STP Protocol Timers

Variable	Description
Hello timer	Determines how often the network device broadcasts hello messages to other network devices.
Forward delay timer	Determines how long each of the listening and learning states last before the port begins forwarding.
Maximum age timer	Determines the amount of time protocol information received on an port is stored by the network device.

Creating the Spanning Tree Topology

In [Figure 31-1](#), Switch A is elected as the root bridge because the bridge priority of all the network devices is set to the default (32768) and Switch A has the lowest MAC address. However, due to traffic patterns, number of forwarding ports, or link types, Switch A might not be the ideal root bridge. By

increasing the priority (lowering the numerical value) of the ideal network device so that it becomes the root bridge, you force an STP recalculation to form a new spanning tree topology with the ideal network device as the root.

Figure 31-1 Spanning Tree Topology

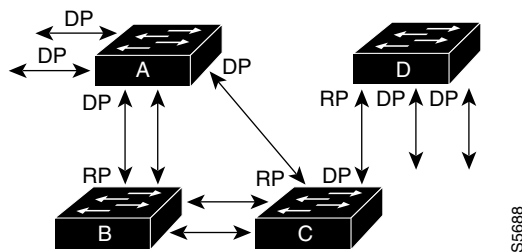

RP = Root Port
DP = Designated Port

When the spanning tree topology is calculated based on default parameters, the path between source and destination end stations in a switched network might not be ideal. For instance, connecting higher-speed links to a port that has a higher number than the current root port can cause a root-port change. The goal is to make the fastest link the root port.

For example, assume that one port on Switch B is a fiber-optic link, and another port on Switch B (an unshielded twisted-pair [UTP] link) is the root port. Network traffic might be more efficient over the high-speed fiber-optic link. By changing the STP port priority on the fiber-optic port to a higher priority (lower numerical value) than the root port, the fiber-optic port becomes the new root port.

STP Port States

- [STP Port State Overview, page 31-6](#)
- [Blocking State, page 31-8](#)
- [Listening State, page 31-9](#)
- [Learning State, page 31-10](#)
- [Forwarding State, page 31-11](#)
- [Disabled State, page 31-12](#)

STP Port State Overview

Propagation delays can occur when protocol information passes through a switched LAN. As a result, topology changes can take place at different times and at different places in a switched network. When a Layer 2 LAN port transitions directly from nonparticipation in the spanning tree topology to the forwarding state, it can create temporary data loops. Ports must wait for new topology information to propagate through the switched LAN before starting to forward frames. They must allow the frame lifetime to expire for frames that have been forwarded using the old topology.

Each Layer 2 LAN port using STP exists in one of the following five states:

- **Blocking**—The Layer 2 LAN port does not participate in frame forwarding.
- **Listening**—First transitional state after the blocking state when STP determines that the Layer 2 LAN port should participate in frame forwarding.

- Learning—The Layer 2 LAN port prepares to participate in frame forwarding.
- Forwarding—The Layer 2 LAN port forwards frames.
- Disabled—The Layer 2 LAN port does not participate in STP and is not forwarding frames.

A Layer 2 LAN port moves through these five states as follows:

- From initialization to blocking
- From blocking to listening or to disabled
- From listening to learning or to disabled
- From learning to forwarding or to disabled
- From forwarding to disabled

Figure 31-2 illustrates how a Layer 2 LAN port moves through the five states.

Figure 31-2 STP Layer 2 LAN Interface States

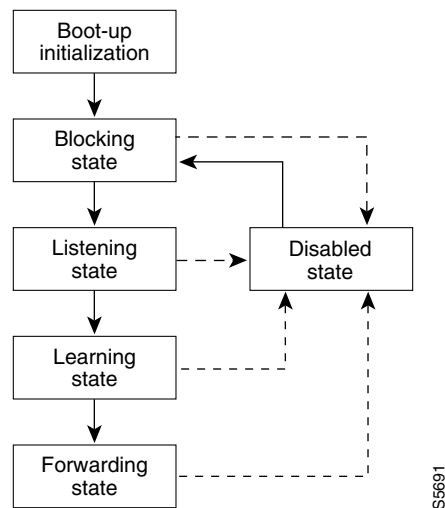

When you enable STP, every port, VLAN, and network goes through the blocking state and the transitory states of listening and learning at power up. If properly configured, each Layer 2 LAN port stabilizes to the forwarding or blocking state.

When the STP algorithm places a Layer 2 LAN port in the forwarding state, the following process occurs:

1. The Layer 2 LAN port is put into the listening state while it waits for protocol information that suggests it should go to the blocking state.
2. The Layer 2 LAN port waits for the forward delay timer to expire, moves the Layer 2 LAN port to the learning state, and resets the forward delay timer.
3. In the learning state, the Layer 2 LAN port continues to block frame forwarding as it learns end station location information for the forwarding database.
4. The Layer 2 LAN port waits for the forward delay timer to expire and then moves the Layer 2 LAN port to the forwarding state, where both learning and frame forwarding are enabled.

Blocking State

A Layer 2 LAN port in the blocking state does not participate in frame forwarding, as shown in Figure 31-3. After initialization, a BPDU is sent out to each Layer 2 LAN port. A network device initially assumes it is the root until it exchanges BPDUs with other network devices. This exchange establishes which network device in the network is the root or root bridge. If only one network device is in the network, no exchange occurs, the forward delay timer expires, and the ports move to the listening state. A port always enters the blocking state following initialization.

Figure 31-3 Interface 2 in Blocking State

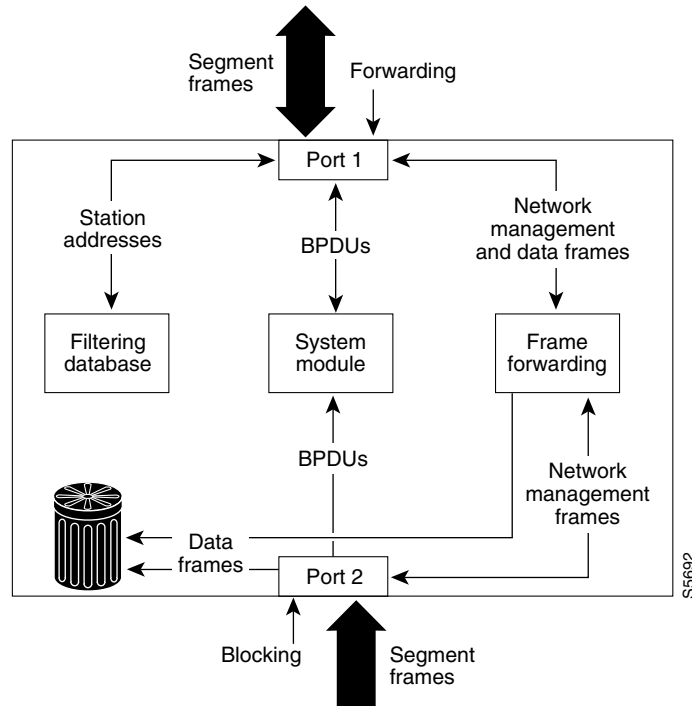

A Layer 2 LAN port in the blocking state performs as follows:

- Discards frames received from the attached segment.
- Discards frames switched from another port for forwarding.
- Does not incorporate end station location into its address database. (There is no learning on a blocking Layer 2 LAN port, so there is no address database update.)
- Receives BPDUs and directs them to the system module.
- Does not transmit BPDUs received from the system module.
- Receives and responds to network management messages.

Listening State

The listening state is the first transitional state a Layer 2 LAN port enters after the blocking state. The Layer 2 LAN port enters this state when STP determines that the Layer 2 LAN port should participate in frame forwarding. [Figure 31-4](#) shows a Layer 2 LAN port in the listening state.

Figure 31-4 Interface 2 in Listening State

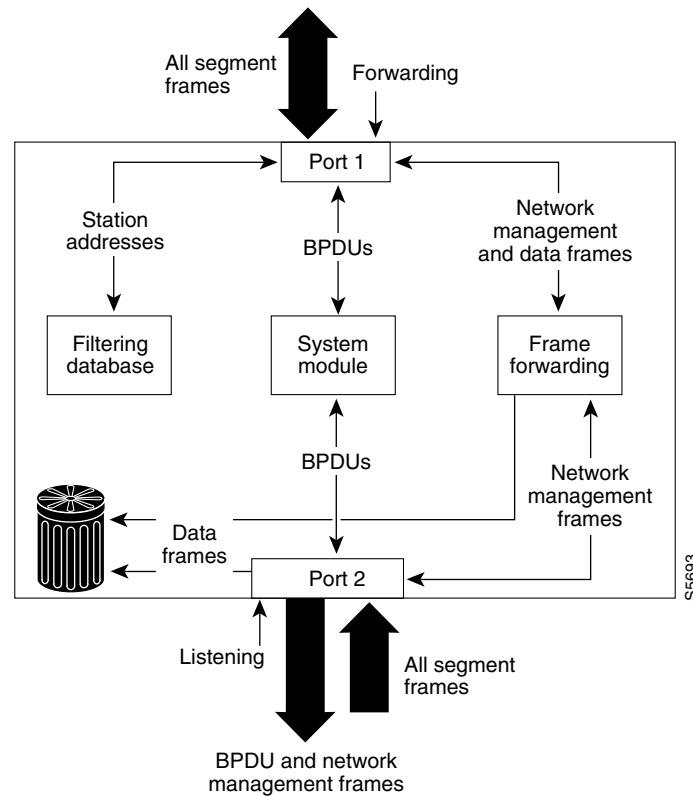

A Layer 2 LAN port in the listening state performs as follows:

- Discards frames received from the attached segment.
- Discards frames switched from another LAN port for forwarding.
- Does not incorporate end station location into its address database. (There is no learning at this point, so there is no address database update.)
- Receives BPDUs and directs them to the system module.
- Receives, processes, and transmits BPDUs received from the system module.
- Receives and responds to network management messages.

Learning State

A Layer 2 LAN port in the learning state prepares to participate in frame forwarding. The Layer 2 LAN port enters the learning state from the listening state. [Figure 31-5](#) shows a Layer 2 LAN port in the learning state.

Figure 31-5 Interface 2 in Learning State

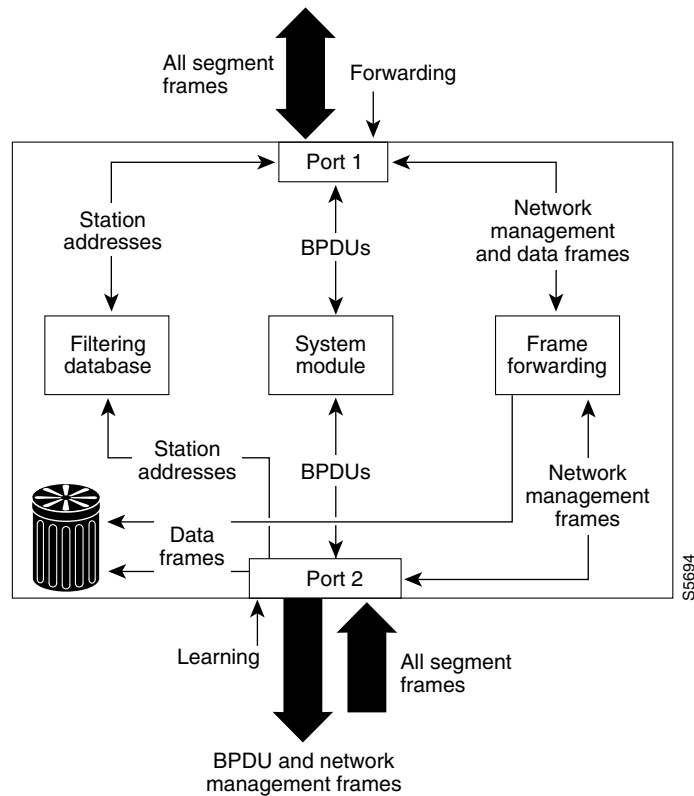

A Layer 2 LAN port in the learning state performs as follows:

- Discards frames received from the attached segment.
- Discards frames switched from another port for forwarding.
- Incorporates end station location into its address database.
- Receives BPDUs and directs them to the system module.
- Receives, processes, and transmits BPDUs received from the system module.
- Receives and responds to network management messages.

Forwarding State

A Layer 2 LAN port in the forwarding state forwards frames, as shown in [Figure 31-6](#). The Layer 2 LAN port enters the forwarding state from the learning state.

Figure 31-6 Interface 2 in Forwarding State

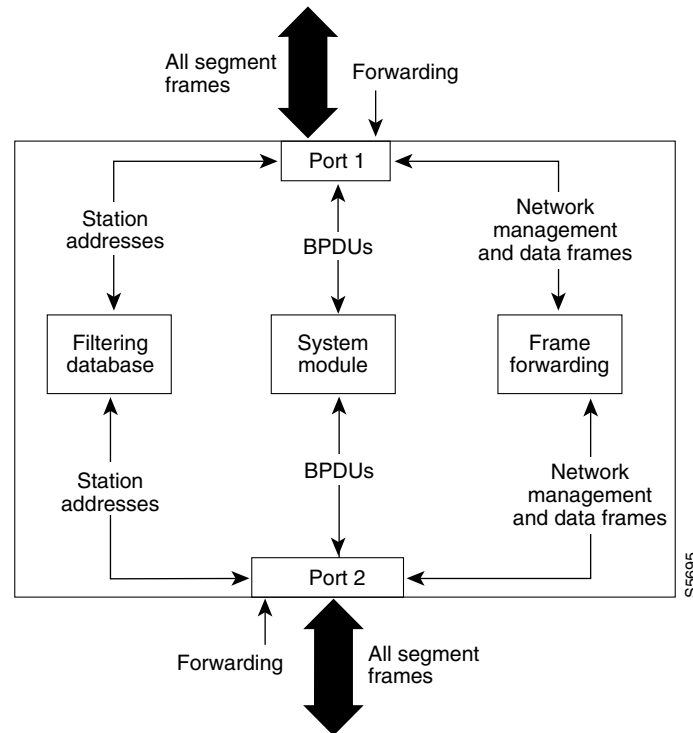

A Layer 2 LAN port in the forwarding state performs as follows:

- Forwards frames received from the attached segment.
- Forwards frames switched from another port for forwarding.
- Incorporates end station location information into its address database.
- Receives BPDU's and directs them to the system module.
- Processes BPDU's received from the system module.
- Receives and responds to network management messages.

Disabled State

A Layer 2 LAN port in the disabled state does not participate in frame forwarding or STP, as shown in Figure 31-7. A Layer 2 LAN port in the disabled state is virtually nonoperational.

Figure 31-7 Interface 2 in Disabled State

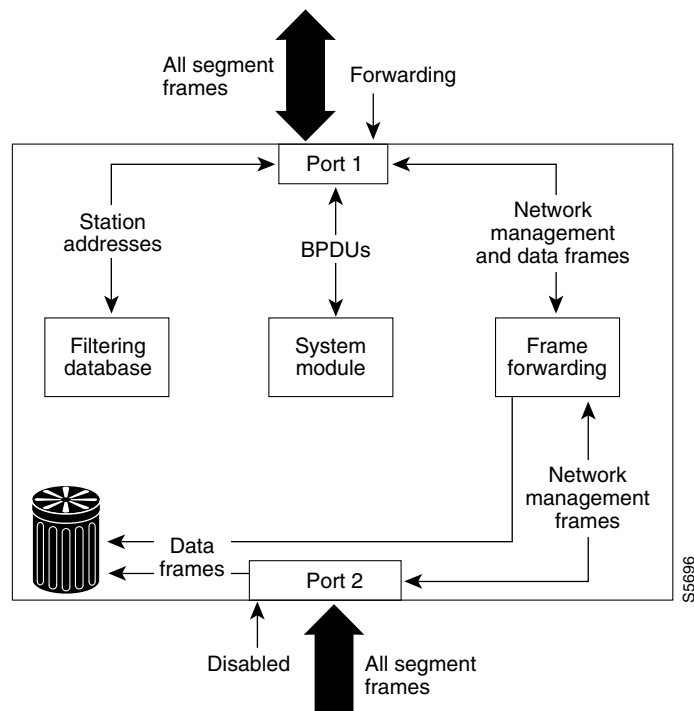

A disabled Layer 2 LAN port performs as follows:

- Discards frames received from the attached segment.
- Discards frames switched from another port for forwarding.
- Does not incorporate end station location into its address database. (There is no learning, so there is no address database update.)
- Does not receive BPDUs.
- Does not receive BPDUs for transmission from the system module.

STP and IEEE 802.1Q Trunks

802.1Q trunks impose some limitations on the STP strategy for a network. In a network of Cisco network devices connected through 802.1Q trunks, the network devices maintain one instance of STP for each VLAN allowed on the trunks. However, non-Cisco 802.1Q network devices maintain only one instance of STP for all VLANs allowed on the trunks.

When you connect a Cisco network device to a non-Cisco device through an 802.1Q trunk, the Cisco network device combines the STP instance of the 802.1Q VLAN of the trunk with the STP instance of the non-Cisco 802.1Q network device. However, all per-VLAN STP information is maintained by Cisco network devices separated by a cloud of non-Cisco 802.1Q network devices. The non-Cisco 802.1Q cloud separating the Cisco network devices is treated as a single trunk link between the network devices.

For more information on 802.1Q trunks, see [Chapter 21, “LAN Ports for Layer 2 Switching.”](#)

Information about IEEE 802.1w RSTP

- [RSTP Overview, page 31-13](#)
- [Port Roles and the Active Topology, page 31-13](#)
- [Rapid Convergence, page 31-14](#)
- [Synchronization of Port Roles, page 31-15](#)
- [Bridge Protocol Data Unit Format and Processing, page 31-16](#)
- [Topology Changes, page 31-17](#)

RSTP Overview

RSTP, which is enabled by default, takes advantage of point-to-point wiring and provides rapid convergence of the spanning tree. Reconfiguration of the spanning tree can occur in less than 1 second (in contrast to 50 seconds with the default settings in the 802.1D spanning tree).

Port Roles and the Active Topology

The RSTP provides rapid convergence of the spanning tree by assigning port roles and by learning the active topology. The RSTP builds upon the 802.1D STP to select the switch with the highest switch priority (lowest numerical priority value) as the root bridge as described in the [“Election of the Root Bridge” section on page 31-5](#). The RSTP then assigns one of these port roles to individual ports:

- Root port—Provides the best path (lowest cost) when the switch forwards packets to the root bridge.
- Designated port—Connects to the designated switch, which incurs the lowest path cost when forwarding packets from that LAN to the root bridge. The port through which the designated switch is attached to the LAN is called the designated port.
- Alternate port—Offers an alternate path toward the root bridge to that provided by the current root port.
- Backup port—Acts as a backup for the path provided by a designated port toward the leaves of the spanning tree. A backup port can exist only when two ports are connected in a loopback by a point-to-point link or when a switch has two or more connections to a shared LAN segment.
- Disabled port—Has no role within the operation of the spanning tree.

A port with the root or a designated port role is included in the active topology. A port with the alternate or backup port role is excluded from the active topology.

In a stable topology with consistent port roles throughout the network, the RSTP ensures that every root port and designated port immediately transition to the forwarding state while all alternate and backup ports are always in the discarding state (equivalent to blocking in 802.1D). The port state controls the operation of the forwarding and learning processes. [Table 31-2](#) provides a comparison of 802.1D and RSTP port states.

Table 31-2 Port State Comparison

Operational Status	STP Port State (IEEE 802.1D)	RSTP Port State	Is Port Included in the Active Topology?
Enabled	Blocking	Discarding	No
Enabled	Listening	Discarding	No
Enabled	Learning	Learning	Yes
Enabled	Forwarding	Forwarding	Yes
Disabled	Disabled	Discarding	No

To be consistent with Cisco STP implementations, this guide defines the port state as *blocking* instead of *discarding*. Designated ports start in the listening state.

Rapid Convergence

The RSTP provides for rapid recovery of connectivity following the failure of a switch, a switch port, or a LAN. It provides rapid convergence for edge ports, new root ports, and ports connected through point-to-point links as follows:

- **Edge ports**—If you configure a port as an edge port on an RSTP switch by using the **spanning-tree portfast** interface configuration command, the edge port immediately transitions to the forwarding state. An edge port is the same as a Port Fast-enabled port, and you should enable it only on ports that connect to a single end station.
- **Root ports**—If the RSTP selects a new root port, it blocks the old root port and immediately transitions the new root port to the forwarding state.
- **Point-to-point links**—If you connect a port to another port through a point-to-point link and the local port becomes a designated port, it negotiates a rapid transition with the other port by using the proposal-agreement handshake to ensure a loop-free topology.

As shown in [Figure 31-8](#), switch A is connected to switch B through a point-to-point link, and all of the ports are in the blocking state. Assume that the priority of switch A is a smaller numerical value than the priority of switch B. Switch A sends a proposal message (a configuration BPDU with the proposal flag set) to switch B, proposing itself as the designated switch.

After receiving the proposal message, switch B selects as its new root port the port from which the proposal message was received, forces all nonedge ports to the blocking state, and sends an agreement message (a BPDU with the agreement flag set) through its new root port.

After receiving switch B's agreement message, switch A also immediately transitions its designated port to the forwarding state. No loops in the network are formed because switch B blocked all of its nonedge ports and because there is a point-to-point link between switches A and B.

When switch C is connected to switch B, a similar set of handshaking messages are exchanged. Switch C selects the port connected to switch B as its root port, and both ends immediately transition to the forwarding state. With each iteration of this handshaking process, one more switch joins the active topology. As the network converges, this proposal-agreement handshaking progresses from the root toward the leaves of the spanning tree.

The switch learns the link type from the port duplex mode: a full-duplex port is considered to have a point-to-point connection and a half-duplex port is considered to have a shared connection. You can override the default setting that is controlled by the duplex setting by using the **spanning-tree link-type** interface configuration command.

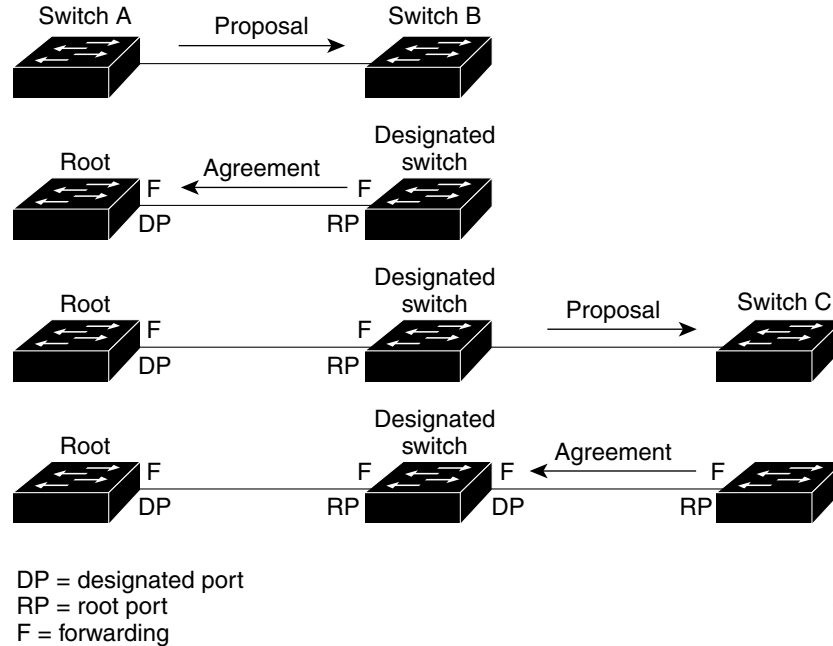
Figure 31-8 Proposal and Agreement Handshaking for Rapid Convergence

Synchronization of Port Roles

When the switch receives a proposal message on one of its ports and that port is selected as the new root port, the RSTP forces all other ports to synchronize with the new root information.

The switch is synchronized with superior root information received on the root port if all other ports are synchronized. An individual port on the switch is synchronized if:

- That port is in the blocking state.
- It is an edge port (a port configured to be at the edge of the network).

If a designated port is in the forwarding state and is not configured as an edge port, it transitions to the blocking state when the RSTP forces it to synchronize with new root information. In general, when the RSTP forces a port to synchronize with root information and the port does not satisfy any of the above conditions, its port state is set to blocking.

After ensuring that all of the ports are synchronized, the switch sends an agreement message to the designated switch corresponding to its root port. When the switches connected by a point-to-point link are in agreement about their port roles, the RSTP immediately transitions the port states to forwarding. The sequence of events is shown in [Figure 31-9](#).

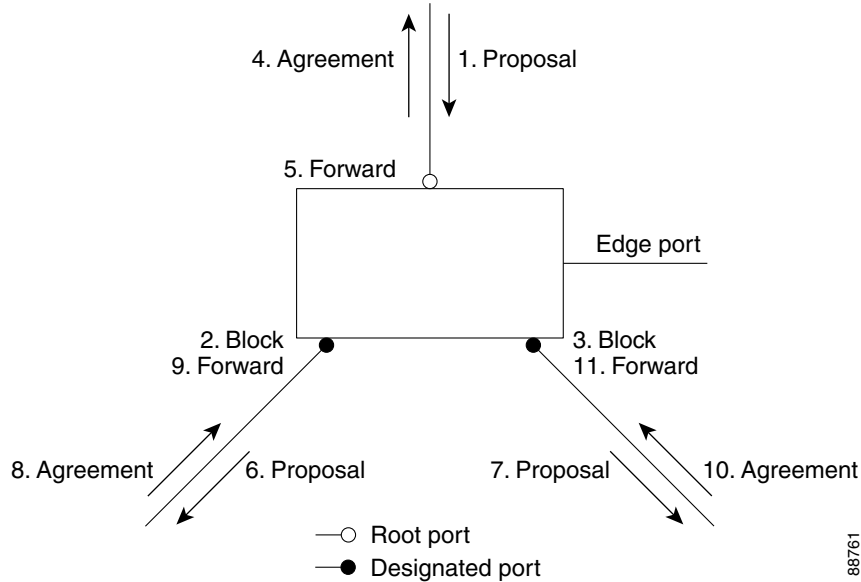
Figure 31-9 Sequence of Events During Rapid Convergence

88761

Bridge Protocol Data Unit Format and Processing

- [BPDU Format and Processing Overview, page 31-16](#)
- [Processing Superior BPDU Information, page 31-17](#)
- [Processing Inferior BPDU Information, page 31-17](#)

BPDU Format and Processing Overview

The RSTP BPDU format is the same as the 802.1D BPDU format except that the protocol version is set to 2. A new 1-byte Version 1 Length field is set to zero, which means that no Version 1 protocol information is present. [Table 31-3](#) describes the RSTP flag fields.

Table 31-3 RSTP BPDU Flags

Bit	Function
0	Topology change (TC)
1	Proposal
2–3:	Port role:
00	Unknown
01	Alternate port or backup port
10	Root port
11	Designated port
4	Learning
5	Forwarding
6	Agreement
7	Topology change acknowledgement (TCA)

The sending switch sets the proposal flag in the RSTP BPDU to propose itself as the designated switch on that LAN. The port role in the proposal message is always set to the designated port.

The sending switch sets the agreement flag in the RSTP BPDU to accept the previous proposal. The port role in the agreement message is always set to the root port.

The RSTP does not have a separate TCN BPDU. It uses the topology change (TC) flag to show the topology changes. However, for interoperability with 802.1D switches, the RSTP switch processes and generates TCN BPDUs.

The learning and forwarding flags are set according to the state of the sending port.

Processing Superior BPDU Information

A superior BPDU is a BPDU with root information (such as lower switch ID or lower path cost) that is superior to what is currently stored for the port.

If a port receives a superior BPDU, the RSTP triggers a reconfiguration. If the port is proposed and is selected as the new root port, RSTP forces all the other ports to synchronize.

If the BPDU received is an RSTP BPDU with the proposal flag set, the switch sends an agreement message after all of the other ports are synchronized. If the BPDU is an 802.1D BPDU, the switch does not set the proposal flag and starts the forward-delay timer for the port. The new root port requires twice the forward-delay time to transition to the forwarding state.

If the superior information received on the port causes the port to become a backup port or an alternate port, RSTP sets the port to the blocking state and sends an agreement message. The designated port continues sending BPDUs with the proposal flag set until the forward-delay timer expires, at which time the port transitions to the forwarding state.

Processing Inferior BPDU Information

An inferior BPDU is a BPDU with root information (such as higher switch ID or higher path cost) that is inferior to what is currently stored for the port.

If a designated port receives an inferior BPDU, it immediately replies with its own information.

Topology Changes

These are the differences between the RSTP and the 802.1D in handling spanning tree topology changes:

- **Detection**—Unlike 802.1D in which *any* transition between the blocking and the forwarding state causes a topology change, *only* transitions from the blocking to the forwarding state cause a topology change with RSTP (only an increase in connectivity is considered a topology change). State changes on an edge port do not cause a topology change. When an RSTP switch detects a topology change, it deletes the learned information on all of its nonedge ports except on those from which it received the TC notification.
- **Notification**—The RSTP does not use TCN BPDUs, unlike 802.1D. However, for 802.1D interoperability, an RSTP switch processes and generates TCN BPDUs.
- **Acknowledgement**—When an RSTP switch receives a TCN message on a designated port from an 802.1D switch, it replies with an 802.1D configuration BPDU with the TCA bit set. However, if the TC-while timer (the same as the TC timer in 802.1D) is active on a root port connected to an 802.1D switch and a configuration BPDU with the TCA set is received, the TC-while timer is reset.

This method of operation is only required to support 802.1D switches. The RSTP BPDUs never have the TCA bit set.

- Propagation—When an RSTP switch receives a TC message from another switch through a designated or root port, it propagates the change to all of its nonedge, designated ports and to the root port (excluding the port on which it is received). The switch starts the TC-while timer for all such ports and flushes the information learned on them.
- Protocol migration—For backward compatibility with 802.1D switches, RSTP selectively sends 802.1D configuration BPDUs and TCN BPDUs on a per-port basis.

When a port is initialized, the migrate-delay timer is started (specifies the minimum time during which RSTP BPDUs are sent), and RSTP BPDUs are sent. While this timer is active, the switch processes all BPDUs received on that port and ignores the protocol type.

If the switch receives an 802.1D BPDU after the port migration-delay timer has expired, it assumes that it is connected to an 802.1D switch and starts using only 802.1D BPDUs. However, if the RSTP switch is using 802.1D BPDUs on a port and receives an RSTP BPDU after the timer has expired, it restarts the timer and starts using RSTP BPDUs on that port.

Information about MST

- [MST Overview, page 31-18](#)
- [MST Regions, page 31-19](#)
- [IST, CIST, and CST, page 31-19](#)
- [Hop Count, page 31-22](#)
- [Boundary Ports, page 31-22](#)
- [Standard-Compliant MST Implementation, page 31-23](#)
- [Interoperability with IEEE 802.1D-1998 STP, page 31-24](#)

MST Overview

MST maps multiple VLANs into a spanning tree instance, with each instance having a spanning tree topology independent of other spanning tree instances. This architecture provides multiple forwarding paths for data traffic, enables load balancing, and reduces the number of spanning tree instances required to support a large number of VLANs. MST improves the fault tolerance of the network because a failure in one instance (forwarding path) does not affect other instances (forwarding paths).

The most common initial deployment of MST is in the backbone and distribution layers of a Layer 2 switched network. This deployment provides the kind of highly available network that is required in a service-provider environment.

MST provides rapid spanning tree convergence through explicit handshaking, which eliminates the 802.1D forwarding delay and quickly transitions root bridge ports and designated ports to the forwarding state.

MST improves spanning tree operation and maintains backward compatibility with these STP versions:

- Original 802.1D spanning tree
- Existing Cisco-proprietary Multiple Instance STP (MISTP)
- Existing Cisco per-VLAN spanning tree plus (PVST+)
- Rapid per-VLAN spanning tree plus (rapid PVST+)

**Note**

- IEEE 802.1w defined the Rapid Spanning Tree Protocol (RSTP) and was incorporated into IEEE 802.1D.
- IEEE 802.1s defined MST and was incorporated into IEEE 802.1Q.

MST Regions

For switches to participate in MST instances, you must consistently configure the switches with the same MST configuration information. A collection of interconnected switches that have the same MST configuration comprises an MST region as shown in [Figure 31-10 on page 31-21](#).

The MST configuration controls to which MST region each switch belongs. The configuration includes the name of the region, the revision number, and the MST VLAN-to-instance assignment map.

A region can have one or multiple members with the same MST configuration; each member must be capable of processing RSTP bridge protocol data units (BPDUs). There is no limit to the number of MST regions in a network, but each region can support up to 65 spanning tree instances. Instances can be identified by any number in the range from 0 to 4094. You can assign a VLAN to only one spanning tree instance at a time.

IST, CIST, and CST

- [IST, CIST, and CST Overview, page 31-19](#)
- [Spanning Tree Operation Within an MST Region, page 31-20](#)
- [Spanning Tree Operations Between MST Regions, page 31-20](#)
- [IEEE 802.1s Terminology, page 31-21](#)

IST, CIST, and CST Overview

Unlike other spanning tree protocols, in which all the spanning tree instances are independent, MST establishes and maintains internal spanning tree (IST), common and internal spanning tree (CIST), and common spanning tree (CST) instances:

- An IST is the spanning tree that runs in an MST region.

Within each MST region, MST maintains multiple spanning tree instances. Instance 0 is a special instance for a region, known as the IST. All other MST instances are numbered from 1 to 4094.

The IST is the only spanning tree instance that sends and receives BPDUs. All of the other spanning tree instance information is contained in MSTP records (M-records), which are encapsulated within MST BPDUs. Because the MST BPDU carries information for all instances, the number of BPDUs that need to be processed to support multiple spanning tree instances is significantly reduced.

All MST instances within the same region share the same protocol timers, but each MST instance has its own topology parameters, such as root bridge ID, root path cost, and so forth. By default, all VLANs are assigned to the IST.

An MST instance is local to the region; for example, MST instance 1 in region A is independent of MST instance 1 in region B, even if regions A and B are interconnected.

- A CIST is a collection of the ISTs in each MST region.
- The CST interconnects the MST regions and single spanning trees.

The spanning tree computed in a region appears as a subtree in the CST that encompasses the entire switched domain. The CIST is formed by the spanning tree algorithm running among switches that support the 802.1w, 802.1s, and 802.1D standards. The CIST inside an MST region is the same as the CST outside a region.

For more information, see the [“Spanning Tree Operation Within an MST Region” section on page 31-20](#) and the [“Spanning Tree Operations Between MST Regions” section on page 31-20](#).

Spanning Tree Operation Within an MST Region

The IST connects all the MST switches in a region. When the IST converges, the root of the IST becomes the CIST regional root (called the *IST master* before the implementation of the 802.1s standard) as shown in [Figure 31-10 on page 31-21](#). The CIST regional root is also the CIST root if there is only one region in the network. If the CIST root is outside the region, one of the MST switches at the boundary of the region is selected as the CIST regional root.

When an MST switch initializes, it sends BPDUs that identify itself as the root of the CIST and the CIST regional root, with both of the path costs to the CIST root and to the CIST regional root set to zero. The switch also initializes all of its MST instances and claims to be the root for all of them. If the switch receives superior MST root information (lower switch ID, lower path cost, and so forth) than currently stored for the port, it relinquishes its claim as the CIST regional root.

During initialization, a region might have many subregions, each with its own CIST regional root. As switches receive superior IST information from a neighbor in the same region, they leave their old subregions and join the new subregion that contains the true CIST regional root, which causes all subregions to shrink except for the one that contains the true CIST regional root.

For correct operation, all switches in the MST region must agree on the same CIST regional root. Therefore, any two switches in the region only synchronize their port roles for an MST instance if they converge to a common CIST regional root.

Spanning Tree Operations Between MST Regions

If there are multiple regions or 802.1D switches within the network, MST establishes and maintains the CST, which includes all MST regions and all 802.1D STP switches in the network. The MST instances combine with the IST at the boundary of the region to become the CST.

The IST connects all the MST switches in the region and appears as a subtree in the CIST that encompasses the entire switched domain. The root of the subtree is the CIST regional root. The MST region appears as a virtual switch to adjacent STP switches and MST regions.

[Figure 31-10](#) shows a network with three MST regions and an 802.1D switch (D). The CIST regional root for region 1 (A) is also the CIST root. The CIST regional root for region 2 (B) and the CIST regional root for region 3 (C) are the roots for their respective subtrees within the CIST.

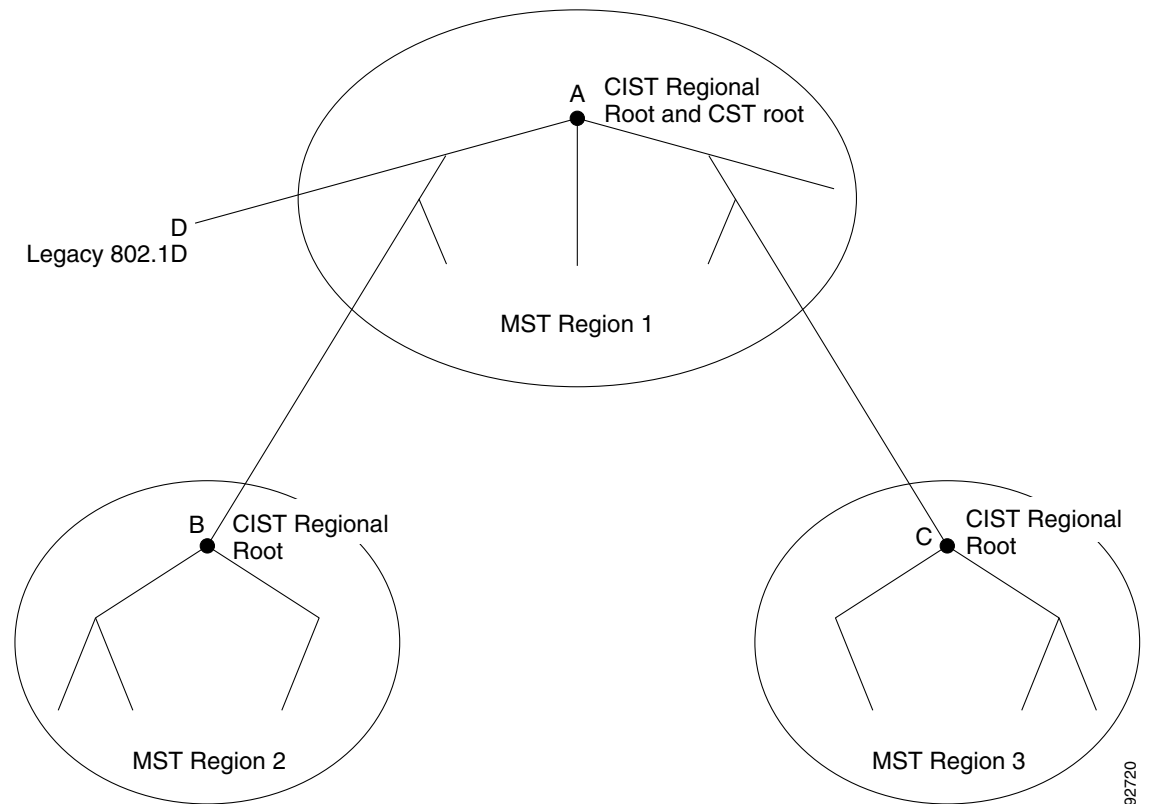
Figure 31-10 MST Regions, CIST Regional Roots, and CST Root

Only the CST instance sends and receives BPDUs, and MST instances add their spanning tree information into the BPDUs to interact with neighboring switches and compute the final spanning tree topology. Because of this, the spanning tree parameters related to BPDU transmission (for example, hello time, forward time, max-age, and max-hops) are configured only on the CST instance but affect all MST instances. Parameters related to the spanning tree topology (for example, switch priority, port VLAN cost, and port VLAN priority) can be configured on both the CST instance and the MST instance.

MST switches use Version 3 BPDUs or 802.1D STP BPDUs to communicate with 802.1D switches. MST switches use MST BPDUs to communicate with MST switches.

IEEE 802.1s Terminology

Some MST naming conventions used in the prestandard implementation have been changed to include identification of some *internal* and *regional* parameters. These parameters are used only within an MST region, compared to external parameters that are used throughout the whole network. Because the CIST is the only spanning tree instance that spans the whole network, only the CIST parameters require the external qualifiers and not the internal or regional qualifiers.

- The CIST root is the root bridge for the CIST, which is the unique instance that spans the whole network.
- The CIST external root path cost is the cost to the CIST root. This cost is left unchanged within an MST region. Remember that an MST region looks like a single switch to the CIST. The CIST external root path cost is the root path cost calculated between these virtual switches and switches that do not belong to any region.

- The CIST regional root was called the IST master in the prestandard implementation. If the CIST root is in the region, the CIST regional root is the CIST root. Otherwise, the CIST regional root is the closest switch to the CIST root in the region. The CIST regional root acts as a root bridge for the IST.
- The CIST internal root path cost is the cost to the CIST regional root in a region. This cost is only relevant to the IST, instance 0.

Table 31-4 compares the IEEE standard and the Cisco prestandard terminology.

Table 31-4 Prestandard and Standard Terminology

IEEE Standard Definition	Cisco Prestandard Implementation	Cisco Standard Implementation
CIST regional root	IST master	CIST regional root
CIST internal root path cost	IST master path cost	CIST internal path cost
CIST external root path cost	Root path cost	Root path cost
MSTI regional root	Instance root	Instance root
MSTI internal root path cost	Root path cost	Root path cost

Hop Count

MST does not use the message-age and maximum-age information in the configuration BPDU to compute the spanning tree topology. Instead, they use the path cost to the root and a hop-count mechanism similar to the IP time-to-live (TTL) mechanism.

By using the **spanning-tree mst max-hops** global configuration command, you can configure the maximum hops inside the region and apply it to the IST and all MST instances in that region. The hop count achieves the same result as the message-age information (triggers a reconfiguration). The root bridge of the instance always sends a BPDU (or M-record) with a cost of 0 and the hop count set to the maximum value. When a switch receives this BPDU, it decrements the received remaining hop count by one and propagates this value as the remaining hop count in the BPDUs it generates. When the count reaches zero, the switch discards the BPDU and ages the information held for the port.

The message-age and maximum-age information in the RSTP portion of the BPDU remain the same throughout the region, and the same values are propagated by the region-designated ports at the boundary.

Boundary Ports

In the Cisco prestandard implementation, a boundary port connects an MST region to one of these STP regions:

- A single spanning tree region running RSTP
- A single spanning tree region running PVST+ or rapid PVST+
- Another MST region with a different MST configuration

A boundary port also connects to a LAN, the designated switch of which is either a single spanning tree switch or a switch with a different MST configuration.

There is no definition of a boundary port in the 802.1s standard. The 802.1Q-2002 standard identifies two kinds of messages that a port can receive: internal (coming from the same region) and external. When a message is external, it is received only by the CIST. If the CIST role is root or alternate, or if the external BPDU is a topology change, it could have an impact on the MST instances. When a message

is internal, the CIST part is received by the CIST, and each MST instance receives its respective M-record. The Cisco prestandard implementation treats a port that receives an external message as a boundary port, which means a port cannot receive a mix of internal and external messages.

An MST region includes both switches and LANs. A segment belongs to the region of its designated port. Therefore, a port in a different region from the designated port for a segment is a boundary port. This definition allows two ports internal to a region to share a segment with a port belonging to a different region, creating the possibility of receiving both internal and external messages on a port.

The primary change from the Cisco prestandard implementation is that a designated port is not defined as boundary unless it is running in an STP-compatible mode.

**Note**

If there is an 802.1D STP switch on the segment, messages are always considered external.

The other change from the prestandard implementation is that the CIST regional root bridge ID field is now inserted where an RSTP or legacy 802.1s switch has the sender switch ID. The whole region performs like a single virtual switch by sending a consistent sender switch ID to neighboring switches. In this example, switch C would receive a BPDU with the same consistent sender switch ID of root, whether or not A or B is designated for the segment.

Standard-Compliant MST Implementation

- [Changes in Port-Role Naming, page 31-23](#)
- [Spanning Tree Interoperation Between Legacy and Standard-Compliant Switches, page 31-23](#)

**Note**

The standard-compliant MST implementation includes features required to meet the standard, as well as some of the desirable prestandard functionality that is not yet incorporated into the published standard.

Changes in Port-Role Naming

The boundary role was deleted from the final MST standard, but this boundary concept is maintained in the standard-compliant implementation. However, an MST instance (MSTI) port at a boundary of the region might not follow the state of the corresponding CIST port. The following two situations currently exist:

- The boundary port is the root port of the CIST regional root—When the CIST instance port is proposed and is synchronized, it can send back an agreement and move to the forwarding state only after all the corresponding MSTI ports are synchronized (and thus forwarding). The MSTI ports now have a special *master* role.
- The boundary port is not the root port of the CIST regional root—The MSTI ports follow the state and role of the CIST port. The standard provides less information, and it might be difficult to understand why an MSTI port can be alternately blocking when it receives no BPDUs (M-records). In this situation, although the boundary role no longer exists, when you enter the **show** commands, they identify a port as boundary in the *type* column of the output.

Spanning Tree Interoperation Between Legacy and Standard-Compliant Switches

Because automatic detection of prestandard switches can fail, you can use an interface configuration command to identify prestandard ports. A region cannot be formed between a standard and a prestandard switch, but they can interoperate before using the CIST. Only the capability of load balancing over different instances is lost in this specific situation. The CLI displays different flags depending on the

port configuration when the port receives prestandard BPDUs. A syslog message also appears the first time a switch receives a prestandard BPDU on a port that has not been configured for prestandard BPDU transmission.

Figure 31-11 illustrates a standard-compliant switch connected to a prestandard switch. Assume that A is the standard-compliant switch and B is a prestandard switch, both configured to be in the same region. A is the root bridge for the CIST, and so B has a root port (BX) on segment X and an alternate port (BY) on segment Y. If segment Y flaps, and the port on BY becomes the alternate before sending out a single prestandard BPDU, AY cannot detect that a prestandard switch is connected to Y and continues to send standard BPDUs. The port BY is fixed in a boundary, and no load balancing is possible between A and B. The same problem exists on segment X, but B might transmit topology changes.

Figure 31-11 Standard-Compliant and Prestandard Switch Interoperation

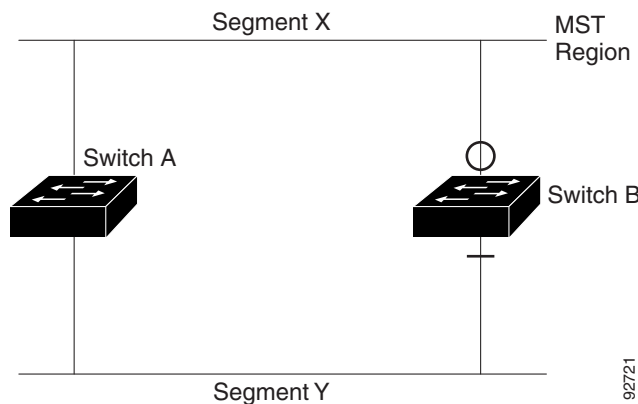

Note

We recommend that you minimize the interaction between standard and prestandard MST implementations.

Interoperability with IEEE 802.1D-1998 STP

A switch running MST supports a built-in protocol migration feature that enables it to interoperate with 802.1D switches. If this switch receives an 802.1D configuration BPDU (a BPDU with the protocol version set to 0), it sends only 802.1D BPDUs on that port. An MST switch also can detect that a port is at the boundary of a region when it receives an 802.1D BPDU, an MST BPDU (Version 3) associated with a different region, or an RSTP BPDU (Version 2).

However, the switch does not automatically revert to the MST mode if it no longer receives 802.1D BPDUs because it cannot detect whether the 802.1D switch has been removed from the link unless the 802.1D switch is the designated switch. A switch might also continue to assign a boundary role to a port when the switch to which this switch is connected has joined the region. To restart the protocol migration process (force the renegotiation with neighboring switches), use the **clear spanning-tree detected-protocols** privileged EXEC command.

If all the 802.1D switches on the link are RSTP switches, they can process MST BPDUs as if they are RSTP BPDUs. Therefore, MST switches send either a Version 0 configuration and topology change notification (TCN) BPDUs or Version 3 MST BPDUs on a boundary port. A boundary port connects to a LAN, the designated switch of which is either a single spanning tree switch or a switch with a different MST configuration.

Detecting Unidirectional Link Failure

Using the dispute mechanism included in the IEEE 802.1D-2004 RSTP and IEEE 802.1Q-2005 MSTP standard, the switch checks the consistency of the port role and state in the received BPDUs to detect unidirectional link failures that could cause bridging loops.

When a designated port detects a conflict, it keeps its role, but reverts to a discarding (blocking) state because disrupting connectivity in case of inconsistency is preferable to opening a bridging loop.

Figure 31-12 illustrates a unidirectional link failure that typically creates a bridging loop. Switch A is the root bridge, and its BPDUs are lost on the link leading to switch B. RSTP and MST BPDUs include the role and state of the sending port. With this information, switch A can detect that switch B does not react to the superior BPDUs it sends and that switch B is the designated, not root bridge. As a result, switch A blocks (or keeps blocking) its port, thus preventing the bridging loop.

Figure 31-12 Detecting Unidirectional Link Failure

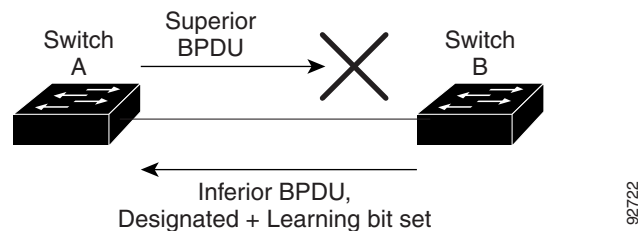

Default Settings for Spanning Tree Protocols

- [Default STP Configuration, page 31-25](#)
- [Default MST Configuration, page 31-26](#)

Default STP Configuration

Feature	Default Value
Mode	Rapid PVST+
Enable state	Enabled for all VLANs
Bridge priority	32768
STP port priority (configurable on a per-port basis—used on LAN ports configured as Layer 2 access ports)	128
STP port cost (configurable on a per-port basis—used on LAN ports configured as Layer 2 access ports)	10-Gigabit Ethernet: 2
	Gigabit Ethernet: 4
	Fast Ethernet: 19
	Ethernet: 100
STP VLAN port priority (configurable on a per-VLAN basis—used on LAN ports configured as Layer 2 trunk ports)	128

Feature	Default Value	
STP VLAN port cost (configurable on a per-VLAN basis—used on LAN ports configured as Layer 2 trunk ports)	10-Gigabit Ethernet:	2
	Gigabit Ethernet:	4
	Fast Ethernet:	19
	Ethernet:	100
Hello time	2 seconds	
Forward delay time	15 seconds	
Maximum aging time	20 seconds	

Default MST Configuration

Feature	Default Setting	
Spanning tree mode	Rapid PVST+ (MST is disabled)	
Switch priority (configurable on a per-MST port basis)	32768	
Spanning tree port priority (configurable on a per-MST instance port basis)	128	
Spanning tree port cost (configurable on a per-MST instance port basis)	10-Gigabit Ethernet:	2,000
	Gigabit Ethernet:	20,000
	Fast Ethernet:	200,000
	Ethernet:	2,000,000
Hello time	2 seconds	
Forward-delay time	15 seconds	
Maximum-aging time	20 seconds	
Maximum hop count	20 hops	

How to Configure Spanning Tree Protocols

- [Configuring STP, page 31-26](#)
- [Configuring MST, page 31-37](#)

Configuring STP

- [Enabling STP, page 31-27](#)
- [Enabling the Extended System ID, page 31-28](#)
- [Configuring the Root Bridge, page 31-29](#)
- [Configuring a Secondary Root Bridge, page 31-30](#)

- [Configuring STP Port Priority, page 31-31](#)
- [Configuring STP Port Cost, page 31-32](#)
- [Configuring the Bridge Priority of a VLAN, page 31-34](#)
- [Configuring the Hello Time, page 31-35](#)
- [Configuring the Forward-Delay Time for a VLAN, page 31-35](#)
- [Configuring the Maximum Aging Time for a VLAN, page 31-36](#)
- [Enabling Rapid-PVST+, page 31-36](#)

**Note**

The STP commands described in this chapter can be configured on any LAN port, but they are in effect only on LAN ports configured with the **switchport** keyword.

**Caution**

We do not recommend disabling spanning tree, even in a topology that is free of physical loops. Spanning tree serves as a safeguard against misconfigurations and cabling errors. Do not disable spanning tree in a VLAN without ensuring that there are no physical loops present in the VLAN.

Enabling STP

**Note**

STP is enabled by default on VLAN 1 and on all newly created VLANs.

You can enable STP on a per-VLAN basis. The switch maintains a separate instance of STP for each VLAN (except on VLANs on which you disable STP).

To enable STP on a per-VLAN basis, perform this task:

	Command	Purpose
Step 1	Router(config)# spanning-tree vlan <i>vlan_ID</i>	Enables STP on a per-VLAN basis. The <i>vlan_ID</i> value can be 1 through 4094, except reserved VLANs (see “Default STP Configuration” section on page 31-25).
	Router(config)# default spanning-tree vlan <i>vlan_ID</i>	Reverts all STP parameters to default values for the specified VLAN.
	Router(config)# no spanning-tree vlan <i>vlan_ID</i>	Disables STP on the specified VLAN; see the following Cautions for information regarding this command.
Step 2	Router(config)# end	Exits configuration mode.

**Caution**

Do not disable spanning tree on a VLAN unless all switches and bridges in the VLAN have spanning tree disabled. You cannot disable spanning tree on some switches and bridges in a VLAN and leave it enabled on other switches and bridges in the VLAN. This action can have unexpected results because switches and bridges with spanning tree enabled will have incomplete information regarding the physical topology of the network.

**Caution**

We do not recommend disabling spanning tree, even in a topology that is free of physical loops. Spanning tree serves as a safeguard against misconfigurations and cabling errors. Do not disable spanning tree in a VLAN without ensuring that there are no physical loops present in the VLAN.

This example shows how to enable STP on VLAN 200:

```
Router# configure terminal
Router(config)# spanning-tree vlan 200
Router(config)# end
Router#
```

**Note**

Because STP is enabled by default, entering a **show running** command to view the resulting configuration does not display the command you entered to enable STP.

This example shows how to verify the configuration:

```
Router# show spanning-tree vlan 200

VLAN0200
  Spanning tree enabled protocol ieee
  Root ID    Priority    32768
             Address     00d0.00b8.14c8
             This bridge is the root
             Hello Time  2 sec  Max Age 20 sec  Forward Delay 15 sec

  Bridge ID  Priority    32768
             Address     00d0.00b8.14c8
             Hello Time  2 sec  Max Age 20 sec  Forward Delay 15 sec
             Aging Time 300

Interface          Role Sts Cost          Prio.Nbr Status
-----
Gi1/4              Desg FWD 200000        128.196 P2p
Gi1/5              Back BLK 200000        128.197 P2p

Router#
```

**Note**

You must have at least one interface that is active in VLAN 200 to create a VLAN 200 spanning tree. In this example, two interfaces are active in VLAN 200.

Enabling the Extended System ID

**Note**

- The extended system ID is enabled permanently on chassis that support 64 MAC addresses.
- You must enable the extended system ID to configure extended range VLANs (1006-4094).
- You must enable the extended system ID if it is enabled on any switches in the VTP domain.

You can enable the extended system ID on chassis that support 1024 MAC addresses (see the [“Information about the Bridge ID” section on page 31-3](#)).

To enable the extended system ID, perform this task:

	Command	Purpose
Step 1	Router(config)# spanning-tree extend system-id	Enables the extended system ID. Note You cannot disable the extended system ID on chassis that support 64 MAC addresses or when you have configured extended range VLANs (see the “VLAN Ranges” section on page 26-2).
Step 2	Router(config)# end	Exits configuration mode.

**Note**

When you enable or disable the extended system ID, the bridge IDs of all active STP instances are updated, which might change the spanning tree topology.

This example shows how to enable the extended system ID:

```
Router# configure terminal
Router(config)# spanning-tree extend system-id
Router(config)# end
Router#
```

This example shows how to verify the configuration:

```
Router# show spanning-tree summary | include Extended
Extended system ID is enabled.
```

Configuring the Root Bridge

The switches supported by Cisco IOS Release 15.4SY maintain a separate instance of STP for each active VLAN. A bridge ID, consisting of the bridge priority and the bridge MAC address, is associated with each instance. For each VLAN, the network device with the lowest bridge ID becomes the root bridge for that VLAN.

To configure a VLAN instance to become the root bridge, enter the **spanning-tree vlan *vlan_ID* root** command to modify the bridge priority from the default value (32768) to a significantly lower value.

When you enter the **spanning-tree vlan *vlan_ID* root** command, the switch checks the bridge priority of the current root bridges for each VLAN. With the extended system ID enabled, the switch sets the bridge priority for the specified VLANs to 24576 if this value will cause the switch to become the root for the specified VLANs.

With the extended system ID enabled, if any root bridge for the specified VLANs has a bridge priority lower than 24576, the switch sets the bridge priority for the specified VLANs to 4096 less than the lowest bridge priority. (4096 is the value of the least significant bit of a 4-bit bridge priority value; see [Table 31-1 on page 31-4](#).)

**Note**

The **spanning-tree vlan *vlan_ID* root** command fails if the value required to be the root bridge is less than 1.

With the extended system ID enabled, if all network devices in, for example, VLAN 20 have the default priority of 32768, entering the **spanning-tree vlan 20 root primary** command on the switch sets the bridge priority to 24576, which causes the switch to become the root bridge for VLAN 20.

**Caution**

The root bridge for each instance of STP should be a backbone or distribution switch. Do not configure an access switch as the STP primary root.

Use the **diameter** keyword to specify the Layer 2 network diameter (that is, the maximum number of bridge hops between any two end stations in the Layer 2 network). When you specify the network diameter, the switch automatically selects an optimal hello time, forward delay time, and maximum age time for a network of that diameter, which can significantly reduce the STP convergence time. You can use the **hello** keyword to override the automatically calculated hello time.

**Note**

To preserve a stable STP topology, we recommend that you avoid configuring the hello time, forward delay time, and maximum age time manually after configuring the switch as the root bridge.

To configure the switch as the root bridge, perform this task:

	Command	Purpose
Step 1	Router(config)# spanning-tree vlan <i>vlan_ID</i> root primary [diameter <i>hops</i> [hello-time <i>seconds</i>]]	Configures the switch as the root bridge. The <i>vlan_ID</i> value can be 1 through 4094, except reserved VLANs (see “Default STP Configuration” section on page 31-25).
	Router(config)# no spanning-tree vlan <i>vlan_ID</i> root	Clears the root bridge configuration.
Step 2	Router(config)# end	Exits configuration mode.

This example shows how to configure the switch as the root bridge for VLAN 10, with a network diameter of 4:

```
Router# configure terminal
Router(config)# spanning-tree vlan 10 root primary diameter 4
Router(config)# end
Router#
```

Configuring a Secondary Root Bridge

When you configure a switch as the secondary root, the STP bridge priority is modified from the default value (32768) so that the switch is likely to become the root bridge for the specified VLANs if the primary root bridge fails (assuming the other network devices in the network use the default bridge priority of 32768).

With the extended system ID is enabled, STP sets the bridge priority to 28672.

You can run this command on more than one switch to configure multiple backup root bridges. Use the same network diameter and hello time values as you used when configuring the primary root bridge.

To configure the switch as the secondary root bridge, perform this task:

	Command	Purpose
Step 1	Router(config)# [no] spanning-tree vlan <i>vlan_ID</i> root secondary [diameter <i>hops</i> [hello-time <i>seconds</i>]]	Configures the switch as the secondary root bridge. The <i>vlan_ID</i> value can be 1 through 4094, except reserved VLANs (see “Default STP Configuration” section on page 31-25).
	Router(config)# no spanning-tree vlan <i>vlan_ID</i> root	Clears the root bridge configuring.
Step 2	Router(config)# end	Exits configuration mode.

This example shows how to configure the switch as the secondary root bridge for VLAN 10, with a network diameter of 4:

```
Router# configure terminal
Router(config)# spanning-tree vlan 10 root secondary diameter 4
Router(config)# end
Router#
```

Configuring STP Port Priority

If a loop occurs, STP considers port priority when selecting a LAN port to put into the forwarding state. You can assign higher priority values to LAN ports that you want STP to select first and lower priority values to LAN ports that you want STP to select last. If all LAN ports have the same priority value, STP puts the LAN port with the lowest LAN port number in the forwarding state and blocks other LAN ports. The possible priority range is 0 through 240 (default 128), configurable in increments of 16.

Cisco IOS uses the port priority value when the LAN port is configured as an access port and uses VLAN port priority values when the LAN port is configured as a trunk port.

To configure the STP port priority of a Layer 2 LAN interface, perform this task:

	Command	Purpose
Step 1	Router(config)# interface { fastethernet gigabitethernet tengigabitethernet } <i>slot/port</i> { port-channel <i>port_channel_number</i> }	Selects an interface to configure.
Step 2	Router(config-if)# spanning-tree port-priority <i>port_priority</i>	Configures the port priority for the LAN interface. The <i>port_priority</i> value can be from 1 to 252 in increments of 4.
Step 3	Router(config-if)# spanning-tree vlan <i>vlan_ID</i> port-priority <i>port_priority</i>	Configures the VLAN port priority for the LAN interface. The <i>port_priority</i> value can be from 1 to 252 in increments of 4. The <i>vlan_ID</i> value can be 1 through 4094, except reserved VLANs (see Table 26-1 on page 26-3).
Step 4	Router(config-if)# end	Exits configuration mode.

This example shows how to configure the STP port priority of Gigabit Ethernet port 1/4:

```
Router# configure terminal
Router(config)# interface gigabitethernet 1/4
Router(config-if)# spanning-tree port-priority 160
Router(config-if)# end
Router#
```

This example shows how to verify the configuration of Gigabit Ethernet port 1/4:

```
Router# show spanning-tree interface gigabitethernet 1/4
Vlan          Role Sts Cost      Prio.Nbr Status
-----
VLAN0001      Back BLK 200000    160.196 P2p
VLAN0006      Back BLK 200000    160.196 P2p
...
VLAN0198      Back BLK 200000    160.196 P2p
VLAN0199      Back BLK 200000    160.196 P2p
VLAN0200      Back BLK 200000    160.196 P2p
Router#
```

Gigabit Ethernet port 1/4 is a trunk. Several VLANs are configured and active as shown in the example. The port priority configuration applies to all VLANs on this interface.



Note

The **show spanning-tree interface** command only displays information if the port is connected and operating. If this condition is not met, enter a **show running-config interface** command to verify the configuration.

This example shows how to configure the VLAN port priority of Gigabit Ethernet port 1/4:

```
Router# configure terminal
Enter configuration commands, one per line. End with CNTL/Z.
Router(config)# interface gigabitethernet 1/4
Router(config-if)# spanning-tree vlan 200 port-priority 64
Router(config-if)# end
Router#
```

The configuration entered in the example only applies to VLAN 200. All VLANs other than 200 still have a port priority of 160.

This example shows how to verify the configuration:

```
Router# show spanning-tree interface gigabitethernet 1/4
Vlan          Role Sts Cost      Prio.Nbr Status
-----
VLAN0001      Back BLK 200000    160.196 P2p
VLAN0006      Back BLK 200000    160.196 P2p
...
VLAN0199      Back BLK 200000    160.196 P2p
VLAN0200      Desg FWD 200000     64.196  P2p
Router#
```

You also can display spanning tree information for VLAN 200 using the following command:

```
Router# show spanning-tree vlan 200 interface gigabitethernet 1/4
Interface      Role Sts Cost      Prio.Nbr Status
-----
Gi1/4          Desg LRN 200000     64.196  P2p
```

Configuring STP Port Cost

The STP port path cost default value is determined from the media speed of a LAN interface. If a loop occurs, STP considers port cost when selecting a LAN interface to put into the forwarding state. You can assign lower cost values to LAN interfaces that you want STP to select first and higher cost values to LAN interfaces that you want STP to select last. If all LAN interfaces have the same cost value, STP puts the LAN interface with the lowest LAN interface number in the forwarding state and blocks other LAN interfaces. The possible cost range is 0 through 200000000 (the default is media specific).

STP uses the port cost value when the LAN interface is configured as an access port and uses VLAN port cost values when the LAN interface is configured as a trunk port.

To configure the STP port cost of a Layer 2 LAN interface, perform this task:

	Command	Purpose
Step 1	Router(config)# interface {fastethernet gigabitethernet tengigabitethernet} slot/port {port-channel port_channel_number}}	Selects an interface to configure.
Step 2	Router(config-if)# spanning-tree cost port_cost	Configures the port cost for the LAN interface. The <i>port_cost</i> value can be from 1 to 200000000.
	Router(config-if)# no spanning-tree cost	Reverts to the default port cost.
Step 3	Router(config-if)# spanning-tree vlan vlan_ID cost port_cost	Configures the VLAN port cost for the LAN interface. The <i>port_cost</i> value can be from 1 to 200000000. The <i>vlan_ID</i> value can be 1 through 4094, except reserved VLANs (see Table 26-1 on page 26-3).
	Router(config-if)# no spanning-tree vlan vlan_ID cost	Reverts to the default VLAN port cost.
Step 4	Router(config-if)# end	Exits configuration mode.

This example shows how to change the STP port cost of Gigabit Ethernet port 1/4:

```
Router# configure terminal
Enter configuration commands, one per line. End with CNTL/Z.
Router(config)# interface gigabitethernet 1/4
Router(config-if)# spanning-tree cost 1000
Router(config-if)# end
Router#
```

This example shows how to verify the configuration:

```
Router# show spanning-tree interface gigabitethernet 1/4
Vlan          Role Sts Cost      Prio.Nbr Status
-----
VLAN0001      Back BLK 1000     160.196 P2p
VLAN0006      Back BLK 1000     160.196 P2p
VLAN0007      Back BLK 1000     160.196 P2p
VLAN0008      Back BLK 1000     160.196 P2p
VLAN0009      Back BLK 1000     160.196 P2p
VLAN0010      Back BLK 1000     160.196 P2p
Router#
```

This example shows how to configure the port priority at an individual port VLAN cost for VLAN 200:

```
Router# configure terminal
Enter configuration commands, one per line. End with CNTL/Z.
Router(config)# interface gigabitethernet 1/4
Router(config-if)# spanning-tree vlan 200 cost 2000
Router(config-if)# end
Router#
```

This example shows how to verify the configuration:

```
Router# show spanning-tree vlan 200 interface gigabitethernet 1/4
Interface      Role Sts Cost      Prio.Nbr Status
-----
Gi1/4          Desg FWD 2000     64.196 P2p
```

**Note**

In the following output other VLANs (VLAN 1 for example) have not been affected by this configuration.

```
Router# show spanning-tree vlan 1 interface gigabitethernet 1/4
Interface          Role Sts Cost          Prio.Nbr Status
-----
Gi1/4              Back BLK 1000        160.196 P2p
Router#
```

**Note**

The **show spanning-tree** command only displays information for ports that are in link-up operative state and are appropriately configured for DTP. If these conditions are not met, you can enter a **show running-config** command to confirm the configuration.

Configuring the Bridge Priority of a VLAN

**Note**

Be careful when using this command. For most situations, we recommend that you enter the **spanning-tree vlan *vlan_ID* root primary** and the **spanning-tree vlan *vlan_ID* root secondary** commands to modify the bridge priority.

To configure the STP bridge priority of a VLAN, perform this task:

	Command	Purpose
Step 1	Router(config)# spanning-tree vlan <i>vlan_ID</i> priority {0 4096 8192 12288 16384 20480 24576 28672 32768 36864 40960 45056 49152 53248 57344 61440}	Configures the bridge priority of a VLAN when the extended system ID is enabled. The <i>vlan_ID</i> value can be 1 through 4094, except reserved VLANs (see Table 26-1 on page 26-3).
Step 2	Router(config)# end	Exits configuration mode.

This example shows how to configure the bridge priority of VLAN 200 to 32768 when the extended system ID is disabled:

```
Router# configure terminal
Router(config)# spanning-tree vlan 200 priority 32768
Router(config)# end
Router#
```

This example shows how to verify the configuration:

```
Router# show spanning-tree vlan 200 bridge

Vlan          Bridge ID          Hello Max  Fwd
              Time  Age  Delay  Protocol
-----
VLAN200      32768 0050.3e8d.64c8  2    20    15  ieee
Router#
```

Configuring the Hello Time



Note

Be careful when using this command. For most situations, we recommend that you use the **spanning-tree vlan *vlan_ID* root primary** and **spanning-tree vlan *vlan_ID* root secondary** commands to modify the hello time.

To configure the STP hello time of a VLAN, perform this task:

	Command	Purpose
Step 1	Router(config)# spanning-tree vlan <i>vlan_ID</i> hello-time <i>hello_time</i>	Configures the hello time of a VLAN. The <i>hello_time</i> value can be from 1 to 10 seconds. The <i>vlan_ID</i> value can be 1 through 4094, except reserved VLANs (see Table 26-1 on page 26-3).
Step 2	Router(config)# end	Exits configuration mode.

This example shows how to configure the hello time for VLAN 200 to 7 seconds:

```
Router# configure terminal
Router(config)# spanning-tree vlan 200 hello-time 7
Router(config)# end
Router#
```

This example shows how to verify the configuration:

```
Router# show spanning-tree vlan 200 bridge

Vlan                Bridge ID           Hello Time  Max Age  Fwd Delay  Protocol
-----
VLAN200             49152 0050.3e8d.64c8  7         20       15        ieee
Router#
```

Configuring the Forward-Delay Time for a VLAN

To configure the STP forward delay time for a VLAN, perform this task:

	Command	Purpose
Step 1	Router(config)# spanning-tree vlan <i>vlan_ID</i> forward-time <i>forward_time</i>	Configures the forward time of a VLAN. The <i>forward_time</i> value can be from 4 to 30 seconds. The <i>vlan_ID</i> value can be 1 through 4094, except reserved VLANs (see Table 26-1 on page 26-3).
	Router(config)# no spanning-tree vlan <i>vlan_ID</i> forward-time	Reverts to the default forward time.
Step 2	Router(config)# end	Exits configuration mode.

This example shows how to configure the forward delay time for VLAN 200 to 21 seconds:

```
Router# configure terminal
Router(config)# spanning-tree vlan 200 forward-time 21
Router(config)# end
Router#
```

This example shows how to verify the configuration:

```
Router# show spanning-tree vlan 200 bridge
Vlan                Bridge ID          Hello Max   Fwd
-----            -
VLAN200             49152 0050.3e8d.64c8  2   20   21  ieee
Router#
```

Configuring the Maximum Aging Time for a VLAN

To configure the STP maximum aging time for a VLAN, perform this task:

	Command	Purpose
Step 1	Router(config)# spanning-tree vlan <i>vlan_ID</i> max-age <i>max_age</i>	Configures the maximum aging time of a VLAN. The <i>max_age</i> value can be from 6 to 40 seconds. The <i>vlan_ID</i> value can be 1 through 4094, except reserved VLANs (see Table 26-1 on page 26-3).
Step 2	Router(config)# end	Exits configuration mode.

This example shows how to configure the maximum aging time for VLAN 200 to 36 seconds:

```
Router# configure terminal
Router(config)# spanning-tree vlan 200 max-age 36
Router(config)# end
Router#
```

This example shows how to verify the configuration:

```
Router# show spanning-tree vlan 200 bridge
Vlan                Bridge ID          Hello Max   Fwd
-----            -
VLAN200             49152 0050.3e8d.64c8  2   36   15  ieee
Router#
```

Enabling Rapid-PVST+

- [Rapid-PVST+ Overview, page 31-36](#)
- [Specifying the Link Type, page 31-37](#)
- [Restarting Protocol Migration, page 31-37](#)



Note

Rapid-PVST+ is enabled by default. Use the procedures to reenable Rapid-PVST+.

Rapid-PVST+ Overview

Rapid-PVST+ uses the existing PVST+ framework for configuration and interaction with other features. It also supports some of the PVST+ extensions.

To enable Rapid-PVST+ mode on the switch, enter the **spanning-tree mode rapid-pvst** command in privileged mode. To configure the switch in Rapid-PVST+ mode, see the “[Configuring STP](#)” section on [page 31-26](#).

Specifying the Link Type

Rapid connectivity is established only on point-to-point links. Spanning tree views a point-to-point link as a segment connecting only two switches running the spanning tree algorithm. Because the switch assumes that all full-duplex links are point-to-point links and that half-duplex links are shared links, you can avoid explicitly configuring the link type. To configure a specific link type, enter the **spanning-tree linktype** command.

Restarting Protocol Migration

A switch running both MSTP and RSTP supports a built-in protocol migration process that enables the switch to interoperate with legacy 802.1D switches. If this switch receives a legacy 802.1D configuration BPDU (a BPDU with the protocol version set to 0), it sends only 802.1D BPDUs on that port. An MSTP switch can also detect that a port is at the boundary of a region when it receives a legacy BPDU, or an MST BPDU (version 3) associated with a different region, or an RST BPDU (version 2).

However, the switch does not automatically revert to the MSTP mode if it no longer receives 802.1D BPDUs because it cannot determine whether the legacy switch has been removed from the link unless the legacy switch is the designated switch. A switch also might continue to assign a boundary role to a port when the switch to which it is connected has joined the region.

To restart the protocol migration process (force the renegotiation with neighboring switches) on the entire switch, you can use the **clear spanning-tree detected-protocols** privileged EXEC command. To restart the protocol migration process on a specific interface, enter the **clear spanning-tree detected-protocols interface** *interface-id* privileged EXEC command.

Configuring MST

- [Default MST Configuration, page 31-26](#)
- [Specifying the MST Region Configuration and Enabling MST, page 31-38](#) (required)
- [Configuring the Root Bridge, page 31-39](#) (optional)
- [Configuring a Secondary Root Bridge, page 31-30](#) (optional)
- [Configuring STP Port Priority, page 31-31](#) (optional)
- [Configuring Path Cost, page 31-42](#) (optional)
- [Configuring the Switch Priority, page 31-43](#) (optional)
- [Configuring the Hello Time, page 31-44](#) (optional)
- [Configuring the Transmit Hold Count, page 31-45](#) (optional)
- [Configuring the Maximum-Aging Time, page 31-45](#) (optional)
- [Configuring the Maximum-Hop Count, page 31-46](#) (optional)
- [Specifying the Link Type to Ensure Rapid Transitions, page 31-46](#) (optional)
- [Designating the Neighbor Type, page 31-46](#) (optional)
- [Restarting the Protocol Migration Process, page 31-47](#) (optional)
- [Displaying the MST Configuration and Status, page 31-47](#)

Specifying the MST Region Configuration and Enabling MST

For two or more switches to be in the same MST region, they must have the same VLAN-to-instance mapping, the same configuration revision number, and the same MST name.

A region can have one member or multiple members with the same MST configuration; each member must be capable of processing RSTP BPDUs. There is no limit to the number of MST regions in a network, but each region can only support up to 65 spanning tree instances. You can assign a VLAN to only one spanning tree instance at a time.

To specify the MST region configuration and enable MST, perform this task:

	Command	Purpose
Step 1	Router# configure terminal	Enters global configuration mode.
Step 2	Router(config)# spanning-tree mst configuration	Enters MST configuration mode.
Step 3	Router(config-mst)# instance <i>instance_id</i> vlan <i>vlan_range</i>	Maps VLANs to an MST instance. <ul style="list-style-type: none"> For <i>instance_id</i>, the range is 0 to 4094. For vlan <i>vlan_range</i>, the range is 1 to 4094. When you map VLANs to an MST instance, the mapping is incremental, and the VLANs specified in the command are added to or removed from the VLANs that were previously mapped. <p>To specify a VLAN range, use a hyphen; for example, instance 1 vlan 1-63 maps VLANs 1 through 63 to MST instance 1.</p> <p>To specify a VLAN series, use a comma; for example, instance 1 vlan 10, 20, 30 maps VLANs 10, 20, and 30 to MST instance 1.</p>
Step 4	Router(config-mst)# name <i>instance_name</i>	Specifies the instance name. The <i>name</i> string has a maximum length of 32 characters and is case sensitive.
Step 5	Router(config-mst)# revision <i>version</i>	Specifies the configuration revision number. The range is 0 to 65535.
Step 6	Router(config-mst)# show pending	Verifies your configuration by displaying the pending configuration.
Step 7	Router(config)# exit	Applies all changes, and return to global configuration mode.
Step 8	Router(config)# spanning-tree mode mst	Enables MST and RSTP. <div style="border: 1px solid black; padding: 5px; margin-top: 10px;">  <p>Caution Changing the spanning tree mode can disrupt traffic because all spanning tree instances are stopped for the previous mode and restarted in the new mode.</p> </div> <p>You cannot run both MST and rapid PVST+ at the same time.</p>
Step 9	Router(config)# end	Returns to privileged EXEC mode.

To return to defaults, do the following:

- To return to the default MST region configuration, use the **no spanning-tree mst configuration** global configuration command.
- To return to the default VLAN-to-instance map, use the **no instance *instance_id* [vlan *vlan_range*]** MST configuration command.
- To return to the default name, use the **no name** MST configuration command.
- To return to the default revision number, use the **no revision** MST configuration command.

This example shows how to enter MST configuration mode, map VLANs 10 to 20 to MST instance 1, name the region *region1*, set the configuration revision to 1, display the pending configuration, apply the changes, and return to global configuration mode:

```
Router(config)# spanning-tree mst configuration
Router(config-mst)# instance 1 vlan 10-20
Router(config-mst)# name region1
Router(config-mst)# revision 1
Router(config-mst)# show pending
Pending MST configuration
Name      [region1]
Revision  1
Instances configured 2
Instance  Vlans Mapped
-----
0          1-9,21-4094
1          10-20
-----

Router(config-mst)# exit
Router(config)#
```

Configuring the Root Bridge

The switch maintains a spanning tree instance for the group of VLANs mapped to it. A switch ID, consisting of the switch priority and the switch MAC address, is associated with each instance. For a group of VLANs, the switch with the lowest switch ID becomes the root bridge.

To configure a switch to become the root bridge, use the **spanning-tree mst *instance_id* root** global configuration command to modify the switch priority from the default value (32768) to a significantly lower value so that the switch becomes the root bridge for the specified spanning tree instance. When you enter this command, the switch checks the switch priorities of the root bridges. Because of extended system ID support, the switch sets its own priority for the specified instance to 24576 if this value will cause this switch to become the root bridge for the specified spanning tree instance.

If any root bridge for the specified instance has a switch priority lower than 24576, the switch sets its own priority to 4096 less than the lowest switch priority. (4096 is the value of the least-significant bit of a 4-bit switch priority value as shown in [Table 31-1 on page 31-4](#).)

If your network consists of switches that both do and do not support the extended system ID, it is unlikely that the switch with the extended system ID support will become the root bridge. The extended system ID increases the switch priority value every time the VLAN number is greater than the priority of the connected switches running older software.

The root bridge for each spanning tree instance should be a backbone or distribution switch. Do not configure an access switch as the spanning tree primary root bridge.

Use the **diameter** keyword, which is available only for MST instance 0, to specify the Layer 2 network diameter (that is, the maximum number of Layer 2 hops between any two end stations in the Layer 2 network). When you specify the network diameter, the switch automatically sets an optimal hello time,

forward-delay time, and maximum-age time for a network of that diameter, which can significantly reduce the convergence time. You can use the **hello** keyword to override the automatically calculated hello time.

**Note**

With the switch configured as the root bridge, do not manually configure the hello time, forward-delay time, and maximum-age time with the **spanning-tree mst hello-time**, **spanning-tree mst forward-time**, and **spanning-tree mst max-age** global configuration commands.

To configure a switch as the root bridge, perform this task:

	Command	Purpose
Step 1	Router(config)# configure terminal	Enters global configuration mode.
Step 2	Router(config-config)# spanning-tree mst <i>instance_id</i> root primary [diameter <i>net_diameter</i> hello-time <i>seconds</i>]	(Optional) Configures a switch as the root bridge. <ul style="list-style-type: none"> For <i>instance_id</i>, you can specify a single instance, a range of instances separated by a hyphen, or a series of instances separated by a comma. The range is 0 to 4094. (Optional) For diameter <i>net_diameter</i>, specify the maximum number of Layer 2 hops between any two end stations. The range is 2 to 7. This keyword is available only for MST instance 0. (Optional) For hello-time <i>seconds</i>, specify the interval in seconds between the generation of configuration messages by the root bridge. The range is 1 to 10 seconds; the default is 2 seconds.
Step 3	Router(config-config)# end	Returns to privileged EXEC mode.

Configuring a Secondary Root Bridge

When you configure a switch with the extended system ID support as the secondary root, the switch priority is modified from the default value (32768) to 28672. The switch is then likely to become the root bridge for the specified instance if the primary root bridge fails. This is assuming that the other network switches use the default switch priority of 32768 and therefore are unlikely to become the root bridge.

You can execute this command on more than one switch to configure multiple backup root bridges. Use the same network diameter and hello-time values that you used when you configured the primary root bridge with the **spanning-tree mst instance_id root primary** global configuration command.

To configure a switch as the secondary root bridge, perform this task:

	Command	Purpose
Step 1	Router# configure terminal	Enters global configuration mode.
Step 2	Router(config)# spanning-tree mst <i>instance_id</i> root secondary [diameter <i>net_diameter</i> [hello-time <i>seconds</i>]]	<p>(Optional) Configures a switch as the secondary root bridge.</p> <ul style="list-style-type: none"> For <i>instance_id</i>, you can specify a single instance, a range of instances separated by a hyphen, or a series of instances separated by a comma. The range is 0 to 4094. (Optional) For diameter <i>net_diameter</i>, specify the maximum number of switches between any two end stations. The range is 2 to 7. This keyword is available only for MST instance 0. (Optional) For hello-time <i>seconds</i>, specify the interval in seconds between the generation of configuration messages by the root bridge. The range is 1 to 10 seconds; the default is 2 seconds. <p>Use the same network diameter and hello-time values that you used when configuring the primary root bridge. See the “Configuring the Root Bridge” section on page 31-39.</p>
Step 3	Router(config)# end	Returns to privileged EXEC mode.

Configuring Port Priority

If a loop occurs, MST uses the port priority when selecting an interface to put into the forwarding state. You can assign higher priority values (lower numerical values) to interfaces that you want selected first and lower priority values (higher numerical values) that you want selected last. If all interfaces have the same priority value, MST puts the interface with the lowest interface number in the forwarding state and blocks the other interfaces.

To configure the MST port priority of an interface, perform this task:

	Command	Purpose
Step 1	Router# configure terminal	Enters global configuration mode.
Step 2	Router(config)# interface { fastethernet gigabitethernet tengigabitethernet } <i>slot/port</i> { port-channel <i>number</i> }	(Optional) Specifies an interface to configure, and enters interface configuration mode.

	Command	Purpose
Step 3	Router(config-if)# spanning-tree mst <i>instance_id</i> port-priority <i>priority</i>	Configures the port priority. <ul style="list-style-type: none"> For <i>instance_id</i>, you can specify a single instance, a range of instances separated by a hyphen, or a series of instances separated by a comma. The range is 0 to 4094. For <i>priority</i>, the range is 0 to 240 in increments of 16. The default is 128. The lower the number, the higher the priority. <p>The priority values are 0, 16, 32, 48, 64, 80, 96, 112, 128, 144, 160, 176, 192, 208, 224, and 240. All other values are rejected.</p>
Step 4	Router(config-if)# end	Returns to privileged EXEC mode.



Note The **show spanning-tree mst interface** *interface_id* privileged EXEC command displays information only if the port is in a link-up operative state. Otherwise, you can use the **show running-config interface** privileged EXEC command to confirm the configuration.

Configuring Path Cost

The MST path cost default value is derived from the media speed of an interface. If a loop occurs, MST uses cost when selecting an interface to put in the forwarding state. You can assign lower cost values to interfaces that you want selected first and higher cost values that you want selected last. If all interfaces have the same cost value, MST puts the interface with the lowest interface number in the forwarding state and blocks the other interfaces.

To configure the MST cost of an interface, perform this task:

	Command	Purpose
Step 1	Router# configure terminal	Enters global configuration mode.
Step 2	Router(config)# interface { fastethernet gigabitethernet tengigabitethernet } <i>slot/port</i> { port-channel <i>number</i> }	(Optional) Specifies an interface to configure, and enters interface configuration mode.

	Command	Purpose
Step 3	Router(config-if)# spanning-tree mst instance_id cost cost	Configures the cost. If a loop occurs, MST uses the path cost when selecting an interface to place into the forwarding state. A lower path cost represents higher-speed transmission. <ul style="list-style-type: none"> For <i>instance_id</i>, you can specify a single instance, a range of instances separated by a hyphen, or a series of instances separated by a comma. The range is 0 to 4094. For <i>cost</i>, the range is 1 to 200000000; the default value is derived from the media speed of the interface.
Step 4	Router(config-if)# end	Returns to privileged EXEC mode.

**Note**

The **show spanning-tree mst interface interface_id** privileged EXEC command displays information only for ports that are in a link-up operative state. Otherwise, you can use the **show running-config** privileged EXEC command to confirm the configuration.

Configuring the Switch Priority

You can configure the switch priority so that it is more likely that a switch is chosen as the root bridge.

**Note**

Exercise care when using this command. For most situations, we recommend that you use the **spanning-tree mst instance_id root primary** and the **spanning-tree mst instance_id root secondary** global configuration commands to modify the switch priority.

To configure the switch priority, perform this task:

	Command	Purpose
Step 1	Router# configure terminal	Enters global configuration mode.

	Command	Purpose
Step 2	Router(config)# spanning-tree mst <i>instance_id</i> priority <i>priority</i>	(Optional) Configures the switch priority. <ul style="list-style-type: none"> For <i>instance_id</i>, you can specify a single instance, a range of instances separated by a hyphen, or a series of instances separated by a comma. The range is 0 to 4094. For <i>priority</i>, the range is 0 to 61440 in increments of 4096; the default is 32768. The lower the number, the more likely the switch will be chosen as the root bridge. <p>Priority values are 0, 4096, 8192, 12288, 16384, 20480, 24576, 28672, 32768, 36864, 40960, 45056, 49152, 53248, 57344, and 61440. All other values are rejected.</p>
Step 3	Router(config)# end	Returns to privileged EXEC mode.

Configuring the Hello Time

You can configure the interval between the generation of configuration messages by the root bridge by changing the hello time.



Note

Exercise care when using this command. For most situations, we recommend that you use the **spanning-tree mst** *instance_id* **root primary** and the **spanning-tree mst** *instance_id* **root secondary** global configuration commands to modify the hello time.

To configure the hello time for all MST instances, perform this task:

	Command	Purpose
Step 1	Router# configure terminal	Enters global configuration mode.
Step 2	Router(config)# spanning-tree mst hello-time <i>seconds</i>	(Optional) Configures the hello time for all MST instances. The hello time is the interval between the generation of configuration messages by the root bridge. These messages mean that the switch is alive. For <i>seconds</i> , the range is 1 to 10; the default is 2.
Step 3	Router(config)# end	Returns to privileged EXEC mode.

Configuring the Forwarding-Delay Time

To configure the forwarding-delay time for all MST instances, perform this task:

	Command	Purpose
Step 1	Router# configure terminal	Enters global configuration mode.
Step 2	Router(config)# spanning-tree mst forward-time <i>seconds</i>	(Optional) Configures the forward time for all MST instances. The forward delay is the number of seconds a port waits before changing from its spanning-tree learning and listening states to the forwarding state. For <i>seconds</i> , the range is 4 to 30; the default is 15.
Step 3	Router(config)# end	Returns to privileged EXEC mode.

Configuring the Transmit Hold Count

To configure the transmit hold count for all MST instances, perform this task:

	Command	Purpose
Step 1	Router# configure terminal	Enters global configuration mode.
Step 2	Router(config)# spanning-tree transmit hold-count <i>hold_count_value</i>	Configures the transmit hold count for all MST instances. For <i>hold_count_value</i> , the range is 1 to 20; the default is 6.
Step 3	Router(config)# end	Returns to privileged EXEC mode.

Configuring the Maximum-Aging Time

To configure the maximum-aging time for all MST instances, perform this task:

	Command	Purpose
Step 1	Router# configure terminal	Enters global configuration mode.
Step 2	Router(config)# spanning-tree mst max-age <i>seconds</i>	(Optional) Configures the maximum-aging time for all MST instances. The maximum-aging time is the number of seconds a switch waits without receiving spanning-tree configuration messages before attempting a reconfiguration. For <i>seconds</i> , the range is 6 to 40; the default is 20.
Step 3	Router(config)# end	Returns to privileged EXEC mode.

Configuring the Maximum-Hop Count

To configure the maximum-hop count for all MST instances, perform this task:

	Command	Purpose
Step 1	Router# configure terminal	Enters global configuration mode.
Step 2	Router(config)# spanning-tree mst max-hops <i>hop_count</i>	(Optional) Specifies the number of hops in a region before the BPDU is discarded, and the information held for a port is aged. For <i>hop_count</i> , the range is 1 to 255; the default is 20.
Step 3	Router(config)# end	Returns to privileged EXEC mode.

Specifying the Link Type to Ensure Rapid Transitions

If you connect a port to another port through a point-to-point link and the local port becomes a designated port, the RSTP negotiates a rapid transition with the other port by using the proposal-agreement handshake to ensure a loop-free topology as described in the [“Rapid Convergence” section on page 31-14](#).

By default, the link type is controlled from the duplex mode of the interface: a full-duplex port is considered to have a point-to-point connection; a half-duplex port is considered to have a shared connection. If you have a half-duplex link physically connected point-to-point to a single port on a remote switch running MST, you can override the default setting of the link type and enable rapid transitions to the forwarding state.

To override the default link-type setting, perform this task:

	Command	Purpose
Step 1	Router# configure terminal	Enters global configuration mode.
Step 2	Router(config)# interface { fastethernet gigabitethernet tengigabitethernet } <i>slot/port</i> { port-channel <i>number</i> }	(Optional) Specifies an interface to configure, and enters interface configuration mode.
Step 3	Router(config)# spanning-tree link-type point-to-point	Specifies that the link type of a port is point-to-point.
Step 4	Router(config)# end	Returns to privileged EXEC mode.

Designating the Neighbor Type

A topology could contain both prestandard and 802.1s standard compliant devices. By default, ports can automatically detect prestandard devices, but they can still receive both standard and prestandard BPDUs. When there is a mismatch between a device and its neighbor, only the CIST runs on the interface.

You can choose to set a port to send only prestandard BPDUs. The prestandard flag appears in all the **show** commands, even if the port is in STP compatibility mode.

To override the default link-type setting, perform this task:

	Command	Purpose
Step 1	Router# configure terminal	Enters global configuration mode.
Step 2	Router(config)# interface { fastethernet gigabitethernet tengigabitethernet } <i>slot/port</i> { port-channel <i>number</i> }	(Optional) Specifies an interface to configure, and enters interface configuration mode.
Step 3	Router(config)# spanning-tree mst pre-standard	Specifies that the port can send only prestandard BPDUs.
Step 4	Router(config)# end	Returns to privileged EXEC mode.

Restarting the Protocol Migration Process

A switch running MST supports a built-in protocol migration feature that enables it to interoperate with 802.1D switches. If this switch receives an 802.1D configuration BPDU (a BPDU with the protocol version set to 0), it sends only 802.1D BPDUs on that port. An MST switch also can detect that a port is at the boundary of a region when it receives an 802.1D BPDU, an MST BPDU (Version 3) associated with a different region, or an RST BPDU (Version 2).

However, the switch does not automatically revert to the MST mode if it no longer receives 802.1D BPDUs because it cannot detect whether the 802.1D switch has been removed from the link unless the 802.1D switch is the designated switch. A switch also might continue to assign a boundary role to a port when the switch to which it is connected has joined the region.

To restart the protocol migration process (force the renegotiation with neighboring switches) on the switch, use the **clear spanning-tree detected-protocols** privileged EXEC command.

To restart the protocol migration process on a specific interface, use the **clear spanning-tree detected-protocols interface** *interface_id* privileged EXEC command.

Displaying the MST Configuration and Status

To display the spanning-tree status, use one or more of the privileged EXEC commands that are described in [Table 31-5](#).

Table 31-5 Commands for Displaying MST Status

Command	Purpose
show spanning-tree mst configuration	Displays the MST region configuration.
show spanning-tree mst configuration digest	Displays the MD5 digest included in the current MSTCI.
show spanning-tree mst <i>instance_id</i>	Displays MST information for the specified instance.
show spanning-tree mst interface <i>interface_id</i>	Displays MST information for the specified interface.

**Tip**

For additional information about Cisco Catalyst 6500 Series Switches (including configuration examples and troubleshooting information), see the documents listed on this page:

http://www.cisco.com/en/US/products/hw/switches/ps708/tsd_products_support_series_home.html

[Participate in the Technical Documentation Ideas forum](#)
