



CHAPTER 9

Configuring IEEE 802.1x Port-Based Authentication

This chapter describes how to configure IEEE 802.1x port-based authentication on the Catalyst 2960 switch. Port-based authentication prevents unauthorized devices (clients) from gaining access to the network.



Note

For complete syntax and usage information for the commands used in this chapter, see the command reference for this release and the “RADIUS Commands” section in the *Cisco IOS Security Command Reference, Release 12.2* from the Cisco.com page under **Documentation > Cisco IOS Software > 12.2 Mainline > Command References**.

This chapter consists of these sections:

- [Understanding IEEE 802.1x Port-Based Authentication, page 9-1](#)
- [Configuring IEEE 802.1x Authentication, page 9-25](#)
- [Displaying IEEE 802.1x Statistics and Status, page 9-52](#)

Understanding IEEE 802.1x Port-Based Authentication

The IEEE 802.1x standard defines a client-server-based access control and authentication protocol that prevents clients from connecting to a LAN through publicly accessible ports unless they are authenticated. The authentication server authenticates each client connected to a switch port before making available any services offered by the switch or the LAN.

Until the client is authenticated, IEEE 802.1x access control allows only Extensible Authentication Protocol over LAN (EAPOL), Cisco Discovery Protocol (CDP), and Spanning Tree Protocol (STP) traffic through the port to which the client is connected. After authentication, normal traffic can pass through the port.

These sections describe IEEE 802.1x port-based authentication:

- [Device Roles, page 9-3](#)
- [Authentication Process, page 9-4](#)
- [Authentication Initiation and Message Exchange, page 9-6](#)
- [Ports in Authorized and Unauthorized States, page 9-8](#)
- [IEEE 802.1x Host Mode, page 9-8](#)

- [IEEE 802.1x Accounting, page 9-9](#)
- [IEEE 802.1x Accounting Attribute-Value Pairs, page 9-9](#)
- [Using 802.1x Readiness Check, page 9-10](#)
- [Using IEEE 802.1x Authentication with VLAN Assignment, page 9-11](#)
- [Using IEEE 802.1x Authentication with Guest VLAN, page 9-12](#)
- [Using IEEE 802.1x Authentication with Restricted VLAN, page 9-13](#)



Note To use IEEE 802.1x authentication with restricted VLAN, the switch must be running the LAN base image.

- [Using IEEE 802.1x Authentication with Inaccessible Authentication Bypass, page 9-14](#)



Note To use IEEE 802.1x authentication with inaccessible authentication bypass, the switch must be running the LAN base image.

- [Using IEEE 802.1x Authentication with Voice VLAN Ports, page 9-15](#)
- [Using IEEE 802.1x Authentication with Port Security, page 9-16](#)
- [Using IEEE 802.1x Authentication with Wake-on-LAN, page 9-17](#)



Note To use IEEE 802.1x authentication with wake-on-LAN, the switch must be running the LAN base image.

- [Using IEEE 802.1x Authentication with MAC Authentication Bypass, page 9-18](#)



Note To use IEEE 802.1x authentication with MAC authentication bypass, the switch must be running the LAN base image.

- [Using Network Admission Control Layer 2 IEEE 802.1x Validation, page 9-19](#)



Note To use Network Admission Control, the switch must be running the LAN base image.

- [Using Voice Aware 802.1x Security, page 9-21](#)
- [Using Web Authentication, page 9-21](#)



Note To use Web Authentication, the switch must be running the LAN base image.

- [Using IEEE 802.1x Authentication with ACLs and the RADIUS Filter-Id Attribute, page 9-24](#)



Note To use IEEE 802.1x authentication with ACLs and the Filter-Id attribute, the switch must be running the LAN base image.

Device Roles

With IEEE 802.1x port-based authentication, the devices in the network have specific roles, as shown in Figure 9-1.

Figure 9-1 IEEE 802.1x Device Roles

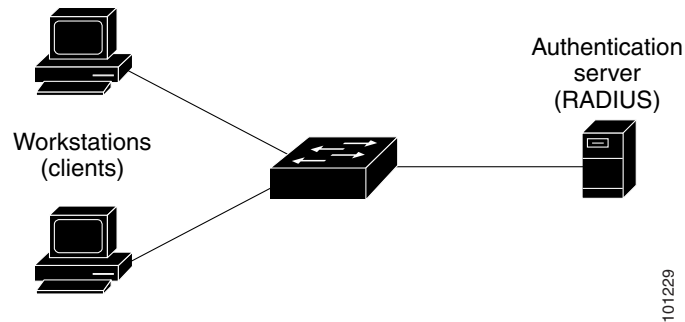

- *Client*—the device (workstation) that requests access to the LAN and switch services and responds to requests from the switch. The workstation must be running IEEE 802.1x-compliant client software such as that offered in the Microsoft Windows XP operating system. (The client is the *supplicant* in the IEEE 802.1x standard.)



Note To resolve Windows XP network connectivity and IEEE 802.1x authentication issues, read the Microsoft Knowledge Base article at this URL:

<http://support.microsoft.com/support/kb/articles/Q303/5/97.ASP>

- *Authentication server*—performs the actual authentication of the client. The authentication server validates the identity of the client and notifies the switch whether or not the client is authorized to access the LAN and switch services. Because the switch acts as the proxy, the authentication service is transparent to the client. In this release, the RADIUS security system with Extensible Authentication Protocol (EAP) extensions is the only supported authentication server. It is available in Cisco Secure Access Control Server Version 3.0 or later. RADIUS operates in a client/server model in which secure authentication information is exchanged between the RADIUS server and one or more RADIUS clients.
- *Switch* (edge switch or wireless access point)—controls the physical access to the network based on the authentication status of the client. The switch acts as an intermediary (proxy) between the client and the authentication server, requesting identity information from the client, verifying that information with the authentication server, and relaying a response to the client. The switch includes the RADIUS client, which is responsible for encapsulating and decapsulating the EAP frames and interacting with the authentication server. (The switch is the *authenticator* in the IEEE 802.1x standard.)

When the switch receives EAPOL frames and relays them to the authentication server, the Ethernet header is stripped, and the remaining EAP frame is re-encapsulated in the RADIUS format. The EAP frames are not modified during encapsulation, and the authentication server must support EAP within the native frame format. When the switch receives frames from the authentication server, the server's frame header is removed, leaving the EAP frame, which is then encapsulated for Ethernet and sent to the client.

The devices that can act as intermediaries include the Catalyst 3750-E, Catalyst 3560-E, Catalyst 3750, Catalyst 3560, Catalyst 3550, Catalyst 2970, Catalyst 2960, Catalyst 2955, Catalyst 2950, Catalyst 2940 switches, or a wireless access point. These devices must be running software that supports the RADIUS client and IEEE 802.1x authentication.

Authentication Process

When IEEE 802.1x port-based authentication is enabled and the client supports IEEE 802.1x-compliant client software, these events occur:

- If the client identity is valid and the IEEE 802.1x authentication succeeds, the switch grants the client access to the network.
- If IEEE 802.1x authentication times out while waiting for an EAPOL message exchange and MAC authentication bypass is enabled, the switch can use the client MAC address for authorization. If the client MAC address is valid and the authorization succeeds, the switch grants the client access to the network. If the client MAC address is invalid and the authorization fails, the switch assigns the client to a guest VLAN that provides limited services if a guest VLAN is configured.
- If the switch gets an invalid identity from an IEEE 802.1x-capable client and a restricted VLAN is specified, the switch can assign the client to a restricted VLAN that provides limited services.
- If the RADIUS authentication server is unavailable (down) and inaccessible authentication bypass is enabled, the switch grants the client access to the network by putting the port in the critical-authentication state in the RADIUS-configured or the user-specified access VLAN.



Note

Inaccessible authentication bypass is also referred to as critical authentication or the AAA fail policy.

Figure 9-2 shows the authentication process.

If Multi Domain Authentication (MDA) is enabled on a port, this flow can be used with some exceptions that are applicable to voice authorization. For more information on MDA, see “Using Multidomain Authentication” section on page 9-19.

Figure 9-2 Authentication Flowchart

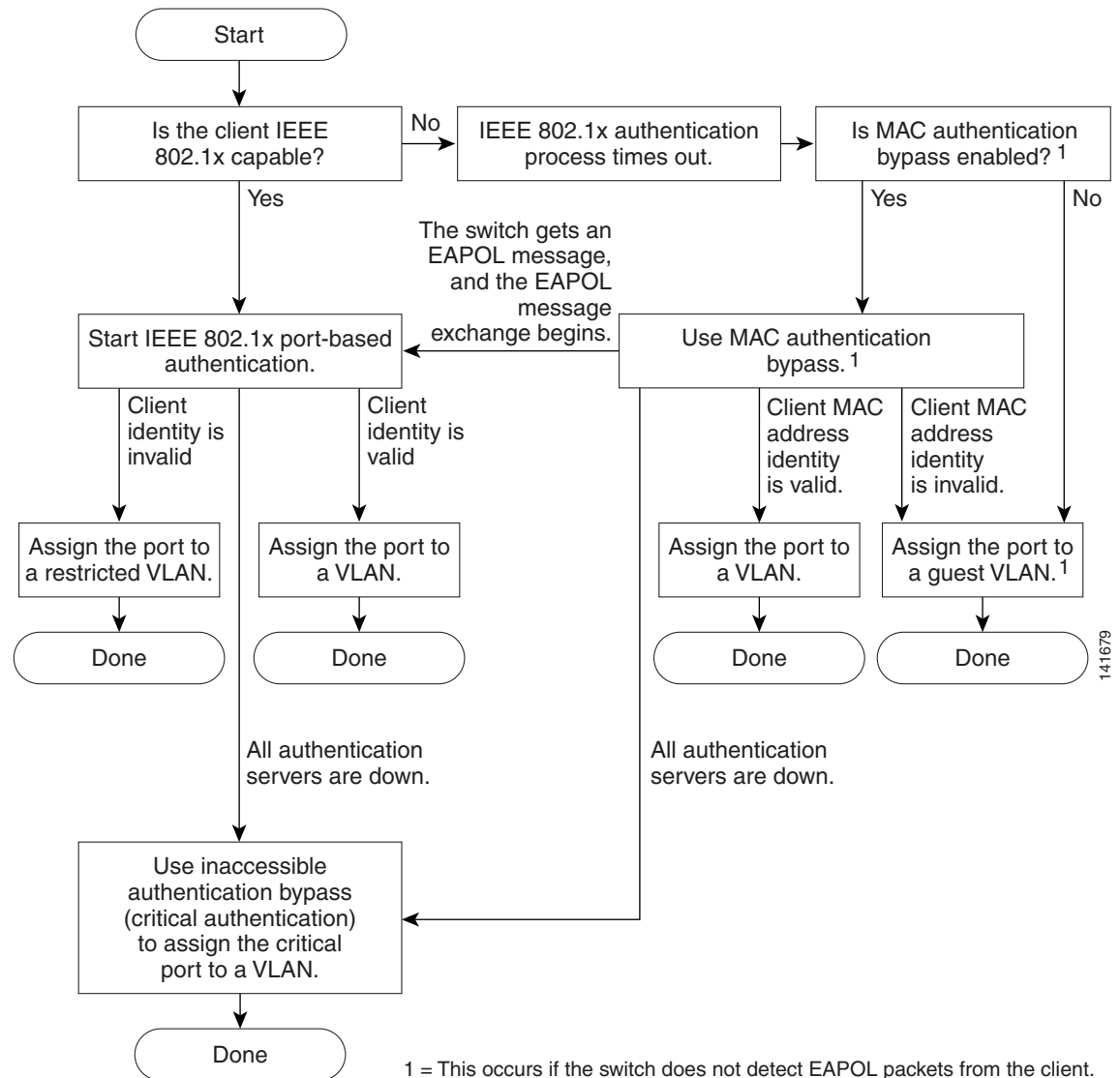

The switch re-authenticates a client when one of these situations occurs:

- Periodic re-authentication is enabled, and the re-authentication timer expires.

You can configure the re-authentication timer to use a switch-specific value or to be based on values from the RADIUS server.

After IEEE 802.1x authentication using a RADIUS server is configured, the switch uses timers based on the Session-Timeout RADIUS attribute (Attribute[27]) and the Termination-Action RADIUS attribute (Attribute [29]).

The Session-Timeout RADIUS attribute (Attribute[27]) specifies the time after which re-authentication occurs.

The Termination-Action RADIUS attribute (Attribute [29]) specifies the action to take during re-authentication. The actions are *Initialize* and *ReAuthenticate*. When the *Initialize* action is set (the attribute value is *DEFAULT*), the IEEE 802.1x session ends, and connectivity is lost during re-authentication. When the *ReAuthenticate* action is set (the attribute value is RADIUS-Request), the session is not affected during re-authentication.

- You manually re-authenticate the client by entering the **dot1x re-authenticate interface interface-id** privileged EXEC command.

Authentication Initiation and Message Exchange

During IEEE 802.1x authentication, the switch or the client can initiate authentication. If you enable authentication on a port by using the **dot1x port-control auto** interface configuration command, the switch initiates authentication when the link state changes from down to up or periodically as long as the port remains up and unauthenticated. The switch sends an EAP-request/identity frame to the client to request its identity. Upon receipt of the frame, the client responds with an EAP-response/identity frame.

However, if during boot up, the client does not receive an EAP-request/identity frame from the switch, the client can initiate authentication by sending an EAPOL-start frame, which prompts the switch to request the client's identity.



Note

If IEEE 802.1x authentication is not enabled or supported on the network access device, any EAPOL frames from the client are dropped. If the client does not receive an EAP-request/identity frame after three attempts to start authentication, the client sends frames as if the port is in the authorized state. A port in the authorized state effectively means that the client has been successfully authenticated. For more information, see the [“Ports in Authorized and Unauthorized States” section on page 9-8](#).

When the client supplies its identity, the switch begins its role as the intermediary, passing EAP frames between the client and the authentication server until authentication succeeds or fails. If the authentication succeeds, the switch port becomes authorized. If the authentication fails, authentication can be retried, the port might be assigned to a VLAN that provides limited services, or network access is not granted. For more information, see the [“Ports in Authorized and Unauthorized States” section on page 9-8](#).

The specific exchange of EAP frames depends on the authentication method being used. [Figure 9-3](#) shows a message exchange initiated by the client when the client uses the One-Time-Password (OTP) authentication method with a RADIUS server.

Figure 9-3 Message Exchange

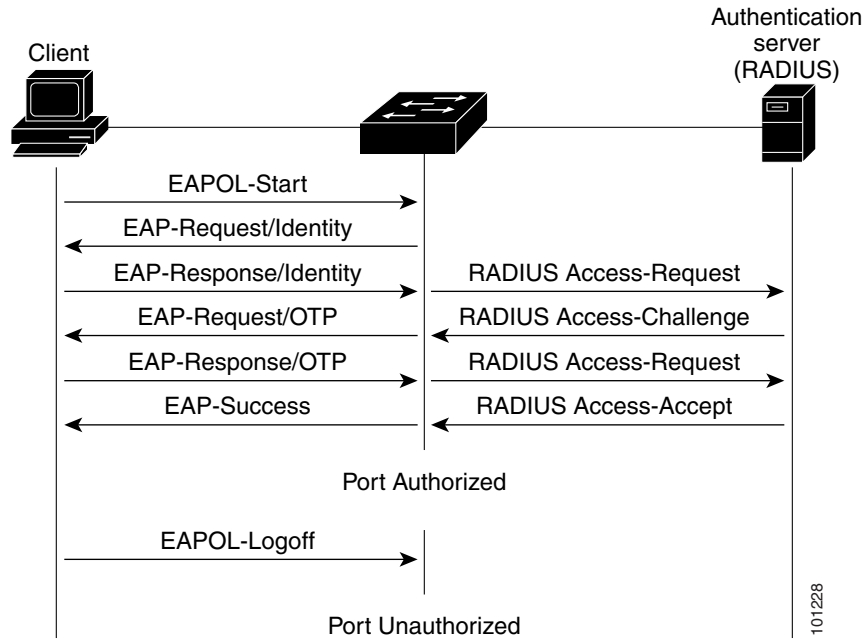

If IEEE 802.1x authentication times out while waiting for an EAPOL message exchange and MAC authentication bypass is enabled, the switch can authorize the client when the switch detects an Ethernet packet from the client. The switch uses the MAC address of the client as its identity and includes this information in the RADIUS-access/request frame that is sent to the RADIUS server. After the server sends the switch the RADIUS-access/accept frame (authorization is successful), the port becomes authorized. If authorization fails and a guest VLAN is specified, the switch assigns the port to the guest VLAN. If the switch detects an EAPOL packet while waiting for an Ethernet packet, the switch stops the MAC authentication bypass process and stops IEEE 802.1x authentication.

Figure 9-4 shows the message exchange during MAC authentication bypass.

Figure 9-4 Message Exchange During MAC Authentication Bypass

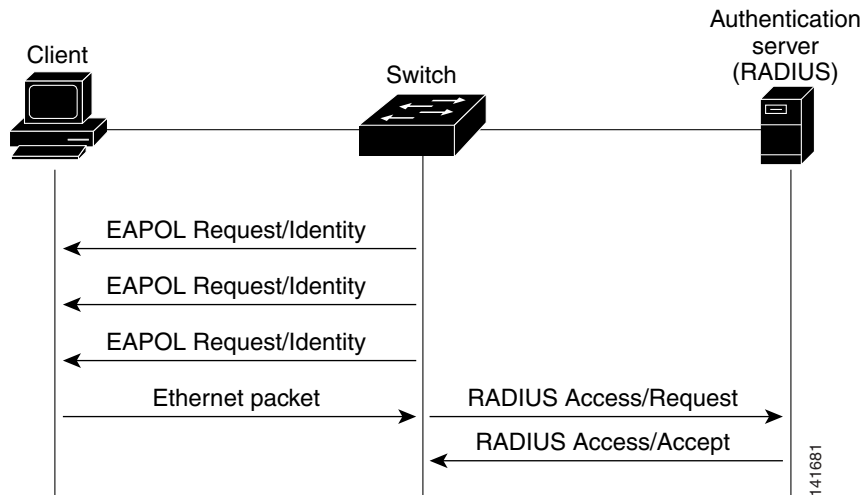

Ports in Authorized and Unauthorized States

During IEEE 802.1x authentication, depending on the switch port state, the switch can grant a client access to the network. The port starts in the *unauthorized* state. While in this state, the port that is not configured as a voice VLAN port disallows all ingress and egress traffic except for IEEE 802.1x authentication, CDP, and STP packets. When a client is successfully authenticated, the port changes to the *authorized* state, allowing all traffic for the client to flow normally. If the port is configured as a voice VLAN port, the port allows VoIP traffic and IEEE 802.1x protocol packets before the client is successfully authenticated.

If a client that does not support IEEE 802.1x authentication connects to an unauthorized IEEE 802.1x port, the switch requests the client's identity. In this situation, the client does not respond to the request, the port remains in the unauthorized state, and the client is not granted access to the network.

In contrast, when an IEEE 802.1x-enabled client connects to a port that is not running the IEEE 802.1x standard, the client initiates the authentication process by sending the EAPOL-start frame. When no response is received, the client sends the request for a fixed number of times. Because no response is received, the client begins sending frames as if the port is in the authorized state.

You control the port authorization state by using the **dot1x port-control** interface configuration command and these keywords:

- **force-authorized**—disables IEEE 802.1x authentication and causes the port to change to the authorized state without any authentication exchange required. The port sends and receives normal traffic without IEEE 802.1x-based authentication of the client. This is the default setting.
- **force-unauthorized**—causes the port to remain in the unauthorized state, ignoring all attempts by the client to authenticate. The switch cannot provide authentication services to the client through the port.
- **auto**—enables IEEE 802.1x authentication and causes the port to begin in the unauthorized state, allowing only EAPOL frames to be sent and received through the port. The authentication process begins when the link state of the port changes from down to up or when an EAPOL-start frame is received. The switch requests the identity of the client and begins relaying authentication messages between the client and the authentication server. Each client attempting to access the network is uniquely identified by the switch by using the client MAC address.

If the client is successfully authenticated (receives an Accept frame from the authentication server), the port state changes to authorized, and all frames from the authenticated client are allowed through the port. If the authentication fails, the port remains in the unauthorized state, but authentication can be retried. If the authentication server cannot be reached, the switch can resend the request. If no response is received from the server after the specified number of attempts, authentication fails, and network access is not granted.

When a client logs off, it sends an EAPOL-logoff message, causing the switch port to change to the unauthorized state.

If the link state of a port changes from up to down, or if an EAPOL-logoff frame is received, the port returns to the unauthorized state.

IEEE 802.1x Host Mode

You can configure an IEEE 802.1x port for single-host or for multiple-hosts mode. In single-host mode (see [Figure 9-1 on page 9-3](#)), only one client can be connected to the IEEE 802.1x-enabled switch port. The switch detects the client by sending an EAPOL frame when the port link state changes to the up state. If a client leaves or is replaced with another client, the switch changes the port link state to down, and the port returns to the unauthorized state.

In multiple-hosts mode, you can attach multiple hosts to a single IEEE 802.1x-enabled port. [Figure 9-5 on page 9-9](#) shows IEEE 802.1x port-based authentication in a wireless LAN. In this mode, only one of the attached clients must be authorized for all clients to be granted network access. If the port becomes unauthorized (re-authentication fails or an EAPOL-logoff message is received), the switch denies network access to all of the attached clients. In this topology, the wireless access point is responsible for authenticating the clients attached to it, and it also acts as a client to the switch.

With the multiple-hosts mode enabled, you can use IEEE 802.1x authentication to authenticate the port and port security to manage network access for all MAC addresses, including that of the client.

Figure 9-5 Multiple Host Mode Example

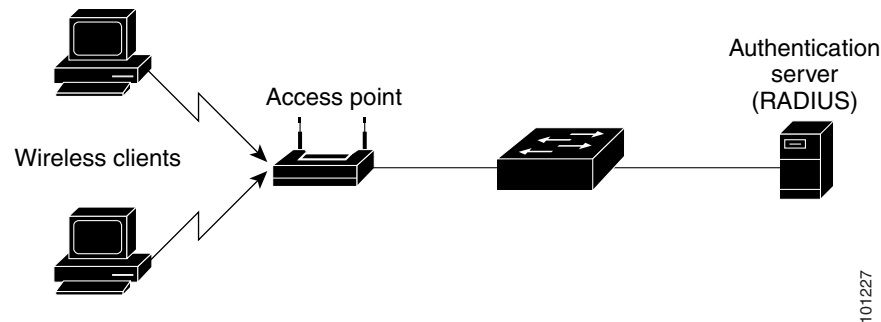

Cisco IOS Release 12.2(46)SE and later supports Multi-Domain Authentication (MDA), which allows both a data device and a voice device, such as an IP Phone (Cisco or non-Cisco), to connect to the same switch port. For more information, see the [“Using Multidomain Authentication” section on page 9-19](#).



Note

To use MDA, the switch must be running the LAN base image.

IEEE 802.1x Accounting

The IEEE 802.1x standard defines how users are authorized and authenticated for network access but does not keep track of network usage. IEEE 802.1x accounting is disabled by default. You can enable IEEE 802.1x accounting to monitor this activity on IEEE 802.1x-enabled ports:

- User successfully authenticates.
- User logs off.
- Link-down occurs.
- Re-authentication successfully occurs.
- Re-authentication fails.

The switch does not log IEEE 802.1x accounting information. Instead, it sends this information to the RADIUS server, which must be configured to log accounting messages.

IEEE 802.1x Accounting Attribute-Value Pairs

The information sent to the RADIUS server is represented in the form of Attribute-Value (AV) pairs. These AV pairs provide data for different applications. (For example, a billing application might require information that is in the Acct-Input-Octets or the Acct-Output-Octets attributes of a RADIUS packet.)

AV pairs are automatically sent by a switch that is configured for IEEE 802.1x accounting. Three types of RADIUS accounting packets are sent by a switch:

- START—sent when a new user session starts
- INTERIM—sent during an existing session for updates
- STOP—sent when a session terminates

Table 9-1 lists the AV pairs and when they are sent are sent by the switch:

Table 9-1 Accounting AV Pairs

Attribute Number	AV Pair Name	START	INTERIM	STOP
Attribute[1]	User-Name	Always	Always	Always
Attribute[4]	NAS-IP-Address	Always	Always	Always
Attribute[5]	NAS-Port	Always	Always	Always
Attribute[8]	Framed-IP-Address	Never	Sometimes ¹	Sometimes ¹
Attribute[25]	Class	Always	Always	Always
Attribute[30]	Called-Station-ID	Always	Always	Always
Attribute[31]	Calling-Station-ID	Always	Always	Always
Attribute[40]	Acct-Status-Type	Always	Always	Always
Attribute[41]	Acct-Delay-Time	Always	Always	Always
Attribute[42]	Acct-Input-Octets	Never	Always	Always
Attribute[43]	Acct-Output-Octets	Never	Always	Always
Attribute[44]	Acct-Session-ID	Always	Always	Always
Attribute[45]	Acct-Authentic	Always	Always	Always
Attribute[46]	Acct-Session-Time	Never	Always	Always
Attribute[49]	Acct-Terminate-Cause	Never	Never	Always
Attribute[61]	NAS-Port-Type	Always	Always	Always

1. The Framed-IP-Address AV pair is sent only if a valid Dynamic Host Control Protocol (DHCP) binding exists for the host in the DHCP snooping bindings table.

You can view the AV pairs that are being sent by the switch by entering the **debug radius accounting** privileged EXEC command. For more information about this command, see the *Cisco IOS Debug Command Reference, Release 12.2* at this URL:

http://www.cisco.com/en/US/products/sw/iosswrel/ps1835/products_command_reference_book09186a00800872ce.html

For more information about AV pairs, see RFC 3580, “IEEE 802.1X Remote Authentication Dial In User Service (RADIUS) Usage Guidelines.”

Using 802.1x Readiness Check



Note

To use 802.1x readiness check, the switch must be running the LAN base image.

The 802.1x readiness check monitors IEEE 802.1x activity on all the switch ports and displays information about the devices connected to the ports that support IEEE 802.1x. You can use this feature to determine if the devices connected to the switch ports are IEEE 802.1x-capable. You use an alternate authentication such as MAC authentication bypass or web authentication for the devices that do not support IEEE 802.1x functionality.

This feature only works if the supplicant on the client supports a query with the NOTIFY EAP notification packet. The client must respond within the IEEE 802.1x timeout value.

For information on configuring the switch for the 802.1x readiness check, see the [“Configuring 802.1x Readiness Check” section on page 9-29](#).

Using IEEE 802.1x Authentication with VLAN Assignment

The RADIUS server sends the VLAN assignment to configure the switch port. The RADIUS server database maintains the username-to-VLAN mappings, assigning the VLAN based on the username of the client connected to the switch port. You can use this feature to limit network access for certain users.

Voice device authentication is supported with multidomain host mode in Cisco IOS Release 12.2(37)SE. In Cisco IOS Release 12.2(40)SE and later, when a voice device is authorized and the RADIUS server returned an authorized VLAN, the voice VLAN on the port is configured to send and receive packets on the assigned voice VLAN. Voice VLAN assignment behaves the same as data VLAN assignment on multidomain authentication (MDA)-enabled ports. For more information, see the [“Using Multidomain Authentication” section on page 9-19](#).

When configured on the switch and the RADIUS server, IEEE 802.1x authentication with VLAN assignment has these characteristics:

- If no VLAN is supplied by the RADIUS server or if IEEE 802.1x authentication is disabled, the port is configured in its access VLAN after successful authentication. Recall that an access VLAN is a VLAN assigned to an access port. All packets sent from or received on this port belong to this VLAN.
- If IEEE 802.1x authentication is enabled but the VLAN information from the RADIUS server is not valid, authorization fails and configured VLAN remains in use. This prevents ports from appearing unexpectedly in an inappropriate VLAN because of a configuration error.

Configuration errors could include specifying a malformed VLAN ID, a nonexistent VLAN ID, an RSPAN VLAN, a shut down or suspended VLAN. In the case of a multidomain host port, configuration errors can also be due to an attempted assignment of a data VLAN that matches the configured or assigned voice VLAN ID (or the reverse).

- If IEEE 802.1x authentication is enabled and all information from the RADIUS server is valid, the authorized device is placed in the specified VLAN after authentication.
- If the multiple-hosts mode is enabled on an IEEE 802.1x port, all hosts are placed in the same VLAN (specified by the RADIUS server) as the first authenticated host.
- Enabling port security does not impact the RADIUS server-assigned VLAN behavior.
- If IEEE 802.1x authentication is disabled on the port, it is returned to the configured access VLAN and configured voice VLAN.
- If an IEEE 802.1x port is authenticated and put in the RADIUS server-assigned VLAN, any change to the port access VLAN configuration does not take effect. In the case of a multidomain host, the same applies to voice devices when the port is fully authorized with these exceptions:

- If the VLAN configuration change of one device results in matching the other device configured or assigned VLAN, then authorization of all devices on the port is terminated and multidomain host mode is disabled until a valid configuration is restored where data and voice device configured VLANs no longer match.
- If a voice device is authorized and is using a downloaded voice VLAN, the removal of the voice VLAN configuration, or modifying the configuration value to *dot1p* or *untagged* results in voice device un-authorization and the disablement of multi-domain host mode.

When the port is in the force authorized, force unauthorized, unauthorized, or shutdown state, it is put into the configured access VLAN.

The IEEE 802.1x authentication with VLAN assignment feature is not supported on trunk ports, dynamic ports, or with dynamic-access port assignment through a VLAN Membership Policy Server (VMPS).

To configure VLAN assignment you need to perform these tasks:

- Enable AAA authorization by using the **network** keyword to allow interface configuration from the RADIUS server.
- Enable IEEE 802.1x authentication. (The VLAN assignment feature is automatically enabled when you configure IEEE 802.1x authentication on an access port).
- Assign vendor-specific tunnel attributes in the RADIUS server. The RADIUS server must return these attributes to the switch:
 - [64] Tunnel-Type = VLAN
 - [65] Tunnel-Medium-Type = 802
 - [81] Tunnel-Private-Group-ID = VLAN name or VLAN ID

Attribute [64] must contain the value *VLAN* (type 13). Attribute [65] must contain the value *802* (type 6). Attribute [81] specifies the *VLAN name* or *VLAN ID* assigned to the IEEE 802.1x-authenticated user.

For examples of tunnel attributes, see the [“Configuring the Switch to Use Vendor-Specific RADIUS Attributes”](#) section on page 8-29.

Using IEEE 802.1x Authentication with Guest VLAN

You can configure a guest VLAN for each IEEE 802.1x port on the switch to provide limited services to clients, such as downloading the IEEE 802.1x client. These clients might be upgrading their system for IEEE 802.1x authentication, and some hosts, such as Windows 98 systems, might not be IEEE 802.1x-capable.

When you enable a guest VLAN on an IEEE 802.1x port, the switch assigns clients to a guest VLAN when the switch does not receive a response to its EAP request/identity frame or when EAPOL packets are not sent by the client.

The switch maintains the EAPOL packet history. If an EAPOL packet is detected on the interface during the lifetime of the link, the switch determines that the device connected to that interface is an IEEE 802.1x-capable supplicant, and the interface does not change to the guest VLAN state. EAPOL history is cleared if the interface link status goes down. If no EAPOL packet is detected on the interface, the interface changes to the guest VLAN state.

In Cisco IOS Release 12.2(25)SEE and later, if devices send EAPOL packets to the switch during the lifetime of the link, the switch no longer allows clients that fail authentication access to the guest VLAN.

If the switch is trying to authorize an IEEE 802.1x-capable voice device and the AAA server is unavailable, the authorization attempt fails, but the detection of the EAPOL packet is saved in the EAPOL history. When the AAA server becomes available, the switch authorizes the voice device. However, the switch no longer allows other devices access to the guest VLAN. To prevent this situation, use one of these command sequences:

- Enter the **dot1x guest-vlan supplicant** global configuration command to allow access to the guest VLAN.
- Enter the **shutdown** interface configuration command followed by the **no shutdown** interface configuration command to restart the port.

**Note**

If an EAPOL packet is detected after the interface has changed to the guest VLAN, the interface reverts to an unauthorized state, and IEEE 802.1x authentication restarts.

Any number of IEEE 802.1x-incapable clients are allowed access when the switch port is moved to the guest VLAN. If an IEEE 802.1x-capable client joins the same port on which the guest VLAN is configured, the port is put into the unauthorized state in the user-configured access VLAN, and authentication is restarted.

Guest VLANs are supported on IEEE 802.1x ports in single-host or multiple-hosts mode.

You can configure any active VLAN except an RSPAN VLAN or a voice VLAN as an IEEE 802.1x guest VLAN. The guest VLAN feature is not supported on trunk ports; it is supported only on access ports.

The switch supports *MAC authentication bypass* in Cisco IOS Release 12.2(25)SEE and later. When MAC authentication bypass is enabled on an IEEE 802.1x port, the switch can authorize clients based on the client MAC address when IEEE 802.1x authentication times out while waiting for an EAPOL message exchange. After detecting a client on an IEEE 802.1x port, the switch waits for an Ethernet packet from the client. The switch sends the authentication server a RADIUS-access/request frame with a username and password based on the MAC address. If authorization succeeds, the switch grants the client access to the network. If authorization fails, the switch assigns the port to the guest VLAN if one is specified. For more information, see the [“Using IEEE 802.1x Authentication with MAC Authentication Bypass”](#) section on page 9-18.

For more information, see the [“Configuring a Guest VLAN”](#) section on page 9-41.

Using IEEE 802.1x Authentication with Restricted VLAN

**Note**

To use IEEE 802.1x authentication with restricted VLAN, the switch must be running the LAN base image.

You can configure a restricted VLAN (also referred to as an *authentication failed VLAN*) for each IEEE 802.1x port on a switch to provide limited services to clients that cannot access the guest VLAN. These clients are IEEE 802.1x-compliant and cannot access another VLAN because they fail the authentication process. A restricted VLAN allows users without valid credentials in an authentication server (typically, visitors to an enterprise) to access a limited set of services. The administrator can control the services available to the restricted VLAN.

**Note**

You can configure a VLAN to be both the guest VLAN and the restricted VLAN if you want to provide the same services to both types of users.

Without this feature, the client attempts and fails authentication indefinitely, and the switch port remains in the spanning-tree blocking state. With this feature, you can configure the switch port to be in the restricted VLAN after a specified number of authentication attempts (the default value is 3 attempts).

The authenticator counts the failed authentication attempts for the client. When this count exceeds the configured maximum number of authentication attempts, the port moves to the restricted VLAN. The failed attempt count increments when the RADIUS server replies with either an *EAP failure* or an empty response without an EAP packet. When the port moves into the restricted VLAN, the failed attempt counter resets.

Users who fail authentication remain in the restricted VLAN until the next re-authentication attempt. A port in the restricted VLAN tries to re-authenticate at configured intervals (the default is 60 seconds). If re-authentication fails, the port remains in the restricted VLAN. If re-authentication is successful, the port moves either to the configured VLAN or to a VLAN sent by the RADIUS server. You can disable re-authentication. If you do this, the only way to restart the authentication process is for the port to receive a *link down* or *EAP logoff* event. We recommend that you keep re-authentication enabled if a client might connect through a hub. When a client disconnects from the hub, the port might not receive the *link down* or *EAP logoff* event.

After a port moves to the restricted VLAN, a simulated EAP success message is sent to the client. This prevents clients from indefinitely attempting authentication. Some clients (for example, devices running Windows XP) cannot implement DHCP without EAP success.

Restricted VLANs are supported only on IEEE 802.1x ports in single-host mode and on Layer 2 ports.

You can configure any active VLAN except an RSPAN VLAN or a voice VLAN as an IEEE 802.1x restricted VLAN. The restricted VLAN feature is not supported on trunk ports; it is supported only on access ports.

This feature works with port security. As soon as the port is authorized, a MAC address is provided to port security. If port security does not permit the MAC address or if the maximum secure address count is reached, the port becomes unauthorized and error disabled.

Other port security features such as dynamic ARP Inspection, DHCP snooping, and IP source guard can be configured independently on a restricted VLAN.

For more information, see the [“Configuring a Restricted VLAN” section on page 9-41](#).

Using IEEE 802.1x Authentication with Inaccessible Authentication Bypass



Note

To use IEEE 802.1x authentication with inaccessible authentication bypass, the switch must be running the LAN base image.

In Cisco IOS Release 12.2(25)SEE and later, when the switch cannot reach the configured RADIUS servers and hosts cannot be authenticated, you can configure the switch to allow network access to the hosts connected to *critical* ports. A critical port is enabled for the inaccessible authentication bypass feature, also referred to as *critical authentication* or the *AAA fail policy*.

When this feature is enabled, the switch checks the status of the configured RADIUS servers whenever the switch tries to authenticate a host connected to a critical port. If a server is available, the switch can authenticate the host. However, if all the RADIUS servers are unavailable, the switch grants network access to the host and puts the port in the critical-authentication state, which is a special case of the authentication state.

The behavior of the inaccessible authentication bypass feature depends on the authorization state of the port:

- If the port is unauthorized when a host connected to a critical port tries to authenticate and all servers are unavailable, the switch puts the port in the critical-authentication state in the RADIUS-configured or user-specified access VLAN.
- If the port is already authorized and re-authentication occurs, the switch puts the critical port in the critical-authentication state in the current VLAN, which might be the one previously assigned by the RADIUS server.
- If the RADIUS server becomes unavailable during an authentication exchange, the current exchanges times out, and the switch puts the critical port in the critical-authentication state during the next authentication attempt.

When a RADIUS server that can authenticate the host is available, all critical ports in the critical-authentication state are automatically re-authenticated.

Inaccessible authentication bypass interacts with these features:

- Guest VLAN—Inaccessible authentication bypass is compatible with guest VLAN. When a guest VLAN is enabled on IEEE 802.1x port, the features interact as follows:
 - If at least one RADIUS server is available, the switch assigns a client to a guest VLAN when the switch does not receive a response to its EAP request/identity frame or when EAPOL packets are not sent by the client.
 - If all the RADIUS servers are not available and the client is connected to a critical port, the switch authenticates the client and puts the critical port in the critical-authentication state in the RADIUS-configured or user-specified access VLAN.
 - If all the RADIUS servers are not available and the client is not connected to a critical port, the switch might not assign clients to the guest VLAN if one is configured.
 - If all the RADIUS servers are not available and if a client is connected to a critical port and was previously assigned to a guest VLAN, the switch keeps the port in the guest VLAN.
- Restricted VLAN—If the port is already authorized in a restricted VLAN and the RADIUS servers are unavailable, the switch puts the critical port in the critical-authentication state in the restricted VLAN.
- IEEE 802.1x accounting—Accounting is not affected if the RADIUS servers are unavailable.
- Private VLAN—You can configure inaccessible authentication bypass on a private VLAN host port. The access VLAN must be a secondary private VLAN.
- Voice VLAN—Inaccessible authentication bypass is compatible with voice VLAN, but the RADIUS-configured or user-specified access VLAN and the voice VLAN must be different.
- Remote Switched Port Analyzer (RSPAN)—Do not configure an RSPAN VLAN as the RADIUS-configured or user-specified access VLAN for inaccessible authentication bypass.

Using IEEE 802.1x Authentication with Voice VLAN Ports

A voice VLAN port is a special access port associated with two VLAN identifiers:

- VVID to carry voice traffic to and from the IP phone. The VVID is used to configure the IP phone connected to the port.
- PVID to carry the data traffic to and from the workstation connected to the switch through the IP phone. The PVID is the native VLAN of the port.

The IP phone uses the VVID for its voice traffic, regardless of the authorization state of the port. This allows the phone to work independently of IEEE 802.1x authentication.

In single-host mode, only the IP phone is allowed on the voice VLAN. In multiple-hosts mode, additional clients can send traffic on the voice VLAN after a supplicant is authenticated on the PVID. When multiple-hosts mode is enabled, the supplicant authentication affects both the PVID and the VVID.

A voice VLAN port becomes active when there is a link, and the device MAC address appears after the first CDP message from the IP phone. Cisco IP phones do not relay CDP messages from other devices. As a result, if several IP phones are connected in series, the switch recognizes only the one directly connected to it. When IEEE 802.1x authentication is enabled on a voice VLAN port, the switch drops packets from unrecognized IP phones more than one hop away.

When IEEE 802.1x authentication is enabled on a port, you cannot configure a port VLAN that is equal to a voice VLAN.

**Note**

If you enable IEEE 802.1x authentication on an access port on which a voice VLAN is configured and to which a Cisco IP Phone is connected, the Cisco IP phone loses connectivity to the switch for up to 30 seconds.

For more information about voice VLANs, see [Chapter 14, “Configuring Voice VLAN.”](#)

Using IEEE 802.1x Authentication with Port Security

You can configure an IEEE 802.1x port with port security in either single-host or multiple-hosts mode. (You also must configure port security on the port by using the **switchport port-security** interface configuration command.) When you enable port security and IEEE 802.1x authentication on a port, IEEE 802.1x authentication authenticates the port, and port security manages network access for all MAC addresses, including that of the client. You can then limit the number or group of clients that can access the network through an IEEE 802.1x port.

These are some examples of the interaction between IEEE 802.1x authentication and port security on the switch:

- When a client is authenticated, and the port security table is not full, the client MAC address is added to the port security list of secure hosts. The port then proceeds to come up normally.

When a client is authenticated and manually configured for port security, it is guaranteed an entry in the secure host table (unless port security static aging has been enabled).

A security violation occurs if the client is authenticated, but the port security table is full. This can happen if the maximum number of secure hosts has been statically configured or if the client ages out of the secure host table. If the client address is aged, its place in the secure host table can be taken by another host.

If the security violation is caused by the first authenticated host, the port becomes error-disabled and immediately shuts down.

The port security violation modes determine the action for security violations. For more information, see the [“Security Violations” section on page 21-10](#).

- When you manually remove an IEEE 802.1x client address from the port security table by using the **no switchport port-security mac-address** *mac-address* interface configuration command, you should re-authenticate the IEEE 802.1x client by using the **dot1x re-authenticate interface** *interface-id* privileged EXEC command.

- When an IEEE 802.1x client logs off, the port changes to an unauthenticated state, and all dynamic entries in the secure host table are cleared, including the entry for the client. Normal authentication then takes place.
- If the port is administratively shut down, the port becomes unauthenticated, and all dynamic entries are removed from the secure host table.
- Port security and a voice VLAN can be configured simultaneously on an IEEE 802.1x port that is in either single-host or multiple-hosts mode. Port security applies to both the voice VLAN identifier (VVID) and the port VLAN identifier (PVID).
- You can configure the **dot1x violation-mode** interface configuration command so that a port shuts down, generates a syslog error, or discards packets from a new device when it connects to an IEEE 802.1x-enabled port or when the maximum number of allowed devices have been authenticated. For more information see the [“Maximum Number of Allowed Devices Per Port” section on page 9-29](#) and the command reference for this release.

For more information about enabling port security on your switch, see the [“Configuring Port Security” section on page 21-8](#).

Using IEEE 802.1x Authentication with Wake-on-LAN



Note

To use IEEE 802.1x authentication with wake-on-LAN, the switch must be running the LAN base image.

The IEEE 802.1x authentication with the wake-on-LAN (WoL) feature allows dormant PCs to be powered when the switch receives a specific Ethernet frame, known as the *magic packet*. You can use this feature in environments where administrators need to connect to systems that have been powered down.

When a host that uses WoL is attached through an IEEE 802.1x port and the host powers off, the IEEE 802.1x port becomes unauthorized. The port can only receive and send EAPOL packets, and WoL magic packets cannot reach the host. When the PC is powered off, it is not authorized, and the switch port is not opened.

When the switch uses IEEE 802.1x authentication with WoL, the switch forwards traffic to unauthorized IEEE 802.1x ports, including magic packets. While the port is unauthorized, the switch continues to block ingress traffic other than EAPOL packets. The host can receive packets but cannot send packets to other devices in the network.



Note

If PortFast is not enabled on the port, the port is forced to the bidirectional state.

When you configure a port as unidirectional by using the **dot1x control-direction in** interface configuration command, the port changes to the spanning-tree forwarding state. The port can send packets to the host but cannot receive packets from the host.

When you configure a port as bidirectional by using the **dot1x control-direction both** interface configuration command, the port is access-controlled in both directions. The port does not receive packets from or send packets to the host.

Using IEEE 802.1x Authentication with MAC Authentication Bypass

**Note**

To use IEEE 802.1x authentication with MAC authentication bypass, the switch must be running the LAN base image.

You can configure the switch to authorize clients based on the client MAC address (see [Figure 9-2 on page 9-5](#)) by using the MAC authentication bypass feature. For example, you can enable this feature on IEEE 802.1x ports connected to devices such as printers.

If IEEE 802.1x authentication times out while waiting for an EAPOL response from the client, the switch tries to authorize the client by using MAC authentication bypass.

When the MAC authentication bypass feature is enabled on an IEEE 802.1x port, the switch uses the MAC address as the client identity. The authentication server has a database of client MAC addresses that are allowed network access. After detecting a client on an IEEE 802.1x port, the switch waits for an Ethernet packet from the client. The switch sends the authentication server a RADIUS-access/request frame with a username and password based on the MAC address. If authorization succeeds, the switch grants the client access to the network. If authorization fails, the switch assigns the port to the guest VLAN if one is configured.

If an EAPOL packet is detected on the interface during the lifetime of the link, the switch determines that the device connected to that interface is an IEEE 802.1x-capable supplicant and uses IEEE 802.1x authentication (not MAC authentication bypass) to authorize the interface. EAPOL history is cleared if the interface link status goes down.

If the switch already authorized a port by using MAC authentication bypass and detects an IEEE 802.1x supplicant, the switch does not unauthorize the client connected to the port. When re-authentication occurs, the switch uses IEEE 802.1x authentication as the preferred re-authentication process if the previous session ended because the Termination-Action RADIUS attribute value is `DEFAULT`.

Clients that were authorized with MAC authentication bypass can be re-authenticated. The re-authentication process is the same as that for clients that were authenticated with IEEE 802.1x. During re-authentication, the port remains in the previously assigned VLAN. If re-authentication is successful, the switch keeps the port in the same VLAN. If re-authentication fails, the switch assigns the port to the guest VLAN, if one is configured.

If re-authentication is based on the Session-Timeout RADIUS attribute (Attribute[27]) and the Termination-Action RADIUS attribute (Attribute [29]) and if the Termination-Action RADIUS attribute (Attribute [29]) action is *Initialize*, (the attribute value is `DEFAULT`), the MAC authentication bypass session ends, and connectivity is lost during re-authentication. If MAC authentication bypass is enabled and the IEEE 802.1x authentication times out, the switch uses the MAC authentication bypass feature to initiate re-authorization. For more information about these AV pairs, see RFC 3580, “IEEE 802.1X Remote Authentication Dial In User Service (RADIUS) Usage Guidelines.”

MAC authentication bypass interacts with the features:

- IEEE 802.1x authentication—You can enable MAC authentication bypass only if IEEE 802.1x authentication is enabled on the port.
- Guest VLAN—If a client has an invalid MAC address identity, the switch assigns the client to a guest VLAN if one is configured.
- Restricted VLAN—This feature is not supported when the client connected to an IEEE 802.1x port is authenticated with MAC authentication bypass.
- Port security—See the “[Using IEEE 802.1x Authentication with Port Security](#)” section on [page 9-16](#).

- Voice VLAN—See the “[Using IEEE 802.1x Authentication with Voice VLAN Ports](#)” section on page 9-15.
- VLAN Membership Policy Server (VMPS)—IEEE802.1x and VMPS are mutually exclusive.
- Private VLAN—You can assign a client to a private VLAN.

Using Network Admission Control Layer 2 IEEE 802.1x Validation

**Note**

To use Network Admission Control, the switch must be running the LAN base image.

In Cisco IOS Release 12.2(25)SED and later, the switch supports the Network Admission Control (NAC) Layer 2 IEEE 802.1x validation, which checks the antivirus condition or *posture* of endpoint systems or clients before granting the devices network access. With NAC Layer 2 IEEE 802.1x validation, you can do these tasks:

- Download the Session-Timeout RADIUS attribute (Attribute[27]) and the Termination-Action RADIUS attribute (Attribute[29]) from the authentication server.
- Set the number of seconds between re-authentication attempts as the value of the Session-Timeout RADIUS attribute (Attribute[27]) and get an access policy against the client from the RADIUS server.
- Set the action to be taken when the switch tries to re-authenticate the client by using the Termination-Action RADIUS attribute (Attribute[29]). If the value is the *DEFAULT* or is not set, the session ends. If the value is RADIUS-Request, the re-authentication process starts.
- View the NAC posture token, which shows the posture of the client, by using the **show dot1x** privileged EXEC command.
- Configure secondary private VLANs as guest VLANs.

Configuring NAC Layer 2 IEEE 802.1x validation is similar to configuring IEEE 802.1x port-based authentication except that you must configure a posture token on the RADIUS server. For information about configuring NAC Layer 2 IEEE 802.1x validation, see the “[Configuring NAC Layer 2 IEEE 802.1x Validation](#)” section on page 9-47 and the “[Configuring Periodic Re-Authentication](#)” section on page 9-36.

For more information about NAC, see the *Network Admission Control Software Configuration Guide*.

Using Multidomain Authentication

The switch supports multidomain authentication (MDA), which allows both a data device and voice device, such as an IP phone (Cisco or non-Cisco), to authenticate on the same switch port. The port is divided into a data domain and a voice domain.

**Note**

To use MDA, the switch must be running the LAN base image.

MDA does not enforce the order of device authentication. However, for best results, we recommend that a voice device is authenticated before a data device on an MDA-enabled port.

Follow these guidelines for configuring MDA:

- To configure a switch port for MDA, see the “[Configuring the Host Mode](#)” section on page 9-35.

- You must configure the voice VLAN for the IP phone when the host mode is set to multidomain. For more information, see [Chapter 14, “Configuring Voice VLAN.”](#)
- Voice VLAN assignment on an MDA-enabled port is supported in Cisco IOS Release 12.2(40)SE and later.



Note If you use a dynamic VLAN to assign a voice VLAN on an MDA-enabled switch port on a switch running Cisco IOS Release 12.2(37)SE, the voice device fails authorization.

- To authorize a voice device, the AAA server must be configured to send a Cisco Attribute-Value (AV) pair attribute with a value of `device-traffic-class=voice`. Without this value, the switch treats the voice device as a data device.
- The guest VLAN and restricted VLAN **features only apply to the data devices on an MDA-enabled port. The switch treats a voice device that fails authorization as a data device.**
- If more than one device attempts authorization on either the voice or the data domain of a port, it is error disabled.
- Until a device is authorized, the port drops its traffic. Non-Cisco IP phones or voice devices are allowed into both the data and voice VLANs. The data VLAN allows the voice device to contact a DHCP server to obtain an IP address and acquire the voice VLAN information. After the voice device starts sending on the voice VLAN, its access to the data VLAN is blocked.
- A voice device MAC address that is binding on the data VLAN is not counted towards the port security MAC address limit.
- You can use dynamic VLAN assignment from a RADIUS server only for data devices.
- MDA can use MAC authentication bypass as a fallback mechanism to allow the switch port to connect to devices that do not support IEEE 802.1x authentication. For more information, see the [“MAC Authentication Bypass” section on page 9-29.](#)
- When a *data* or a *voice* device is detected on a port, its MAC address is blocked until authorization succeeds. If the authorization fails, the MAC address remains blocked for 5 minutes.
- If more than five devices are detected on the *data* VLAN or more than one voice device is detected on the *voice* VLAN while a port is unauthorized, the port is error disabled.
- When a port host mode is changed from single- or multihost to multidomain mode, an authorized data device remains authorized on the port. However, a Cisco IP phone that has been allowed on the port voice VLAN is automatically removed and must be reauthenticated on that port.
- Active fallback mechanisms such as guest VLAN and restricted VLAN remain configured after a port changes from single- or multihost mode to multidomain mode.
- Switching a port host mode from multidomain to single- or multihost mode removes all authorized devices from the port.
- If a data domain is authorized first and placed in the guest VLAN, non-IEEE 802.1x-capable voice devices need to tag their packets on the voice VLAN to trigger authentication.
- We do not recommend per-user ACLs with an MDA-enabled port. An authorized device with a per-user ACL policy might impact traffic on both the voice and data VLANs of the port. If used, only one device on the port should enforce per-user ACLs.

Using Voice Aware 802.1x Security

**Note**

To use voice aware IEEE 802.1x authentication, the switch must be running the LAN base image.

You use the voice aware 802.1x security feature to configure the switch to disable only the VLAN on which a security violation occurs, whether it is a data or voice VLAN. In previous releases, when an attempt to authenticate the data client caused a security violation, the entire port shut down, resulting in a complete loss of connectivity.

You can use this feature in IP phone deployments where a PC is connected to the IP phone. A security violation found on the data VLAN results in the shutdown of only the data VLAN. The traffic on the voice VLAN flows through the switch without interruption.

For information on configuring voice aware 802.1x security, see the [“Configuring Voice Aware 802.1x Security” section on page 9-30](#).

Using Web Authentication

**Note**

To use Web Authentication, the switch must be running the LAN base image.

You can use a web browser to authenticate a client that does not support IEEE 802.1x functionality. This feature can authenticate up to eight users on the same shared port and apply the appropriate policies for each end host on a shared port.

You can configure a port to use only web authentication. You can also configure the port to first try and use IEEE 802.1x authentication and then to use web authorization if the client does not support IEEE 802.1x authentication.

Web authentication requires two Cisco Attribute-Value (AV) pair attributes:

- The first attribute, `priv-lvl=15`, must always be set to `15`. This sets the privilege level of the user who is logging into the switch.
- The second attribute is an access list to be applied for web-authenticated hosts. The syntax is similar to IEEE 802.1x per-user access control lists (ACLs). However, instead of `ip:inacl`, this attribute must begin with `proxyacl`, and the `source` field in each entry must be `any`. (After authentication, the client IP address replaces the `any` field when the ACL is applied.)

For example:

```

proxyacl# 10=permit ip any 10.0.0.0 255.0.0.0
proxyacl# 20=permit ip any 11.1.0.0 255.255.0.0
proxyacl# 30=permit udp any any eq syslog
proxyacl# 40=permit udp any any eq tftp

```



Note The *proxyacl* entry determines the type of allowed network access.

For more information, see the [“Configuring Web Authentication”](#) section on page 9-48.

Web Authentication with Automatic MAC Check

You can use web authentication with automatic MAC check to authenticate a client that does not support IEEE 802.1x or web-browser functionality. End hosts, such as printers, can automatically authenticate by using the MAC address without any other requirements.

Web authentication with automatic MAC check only works in web authentication standalone mode. You cannot use this if web authentication is configured as a fallback to IEEE 802.1x authentication.

The MAC address of the device must be configured in the Access Control Server (ACS) for the automatic MAC check to succeed. The automatic MAC check allows managed devices, such as printers, to skip web authentication.



Note

The interoperability of web authentication (with automatic MAC check) and IEEE 802.1x MAC authentication configured on different ports of the same switch is not supported.

Local Web Authentication Banner



Note

To use the Local Web Authentication Feature, the switch must be running the LAN base image.

You can create a banner that will appear when you log into a switch by using web authentication.

The Banner appears on both the login page and the authentication-result pop-up page. The banner appears in these authentication-result pop-up pages

- *Authentication Successful*
- *Authentication Failed*
- *Authentication Expired*

You create a banner by using the **ip admission auth-proxy-banner http** global configuration command. The default banner *Cisco Systems* and *Switch host-name Authentication* appear on the Login Page. *Cisco System* appears on the authentication result pop-up page, as shown in [Figure 9-6](#).

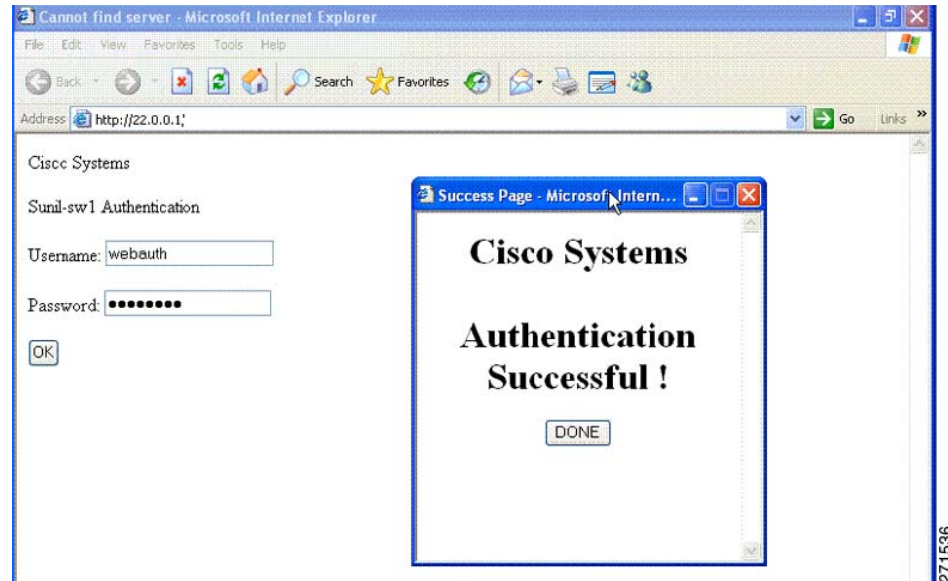
Figure 9-6 Authentication Successful" Banner

This banner can also be customized, as shown in

- Add a switch, router, or company name to the banner by using the **ip admission auth-proxy-banner http banner-text** global configuration command.
- Add a logo or text file to the banner by using the **ip admission auth-proxy-banner http file-path** global configuration command.

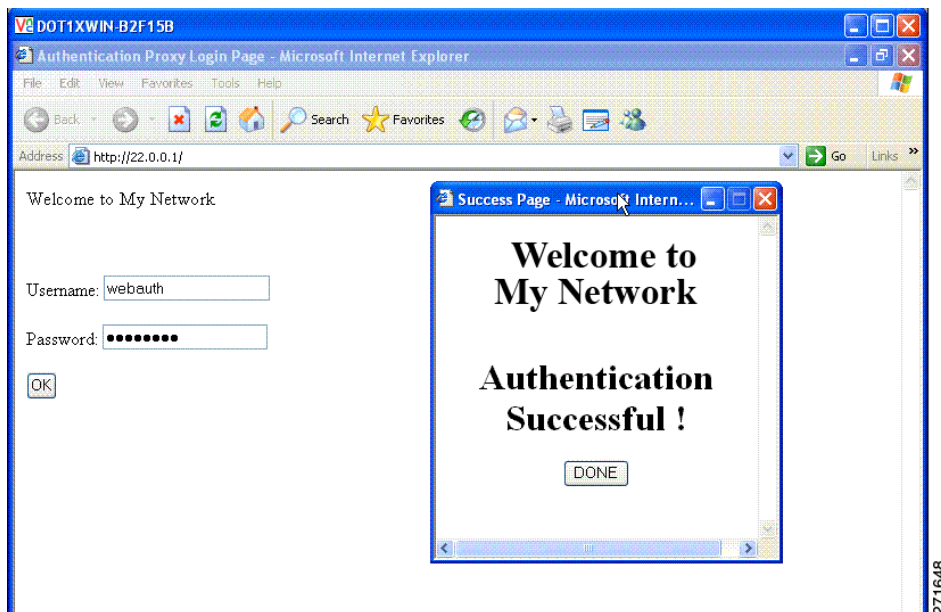
Figure 9-7 Customized Web Banner

If you do not enable a banner, only the username and password dialog boxes appear in the web authentication login screen, and no banner appears when you log into the switch, as shown in Figure 9-8

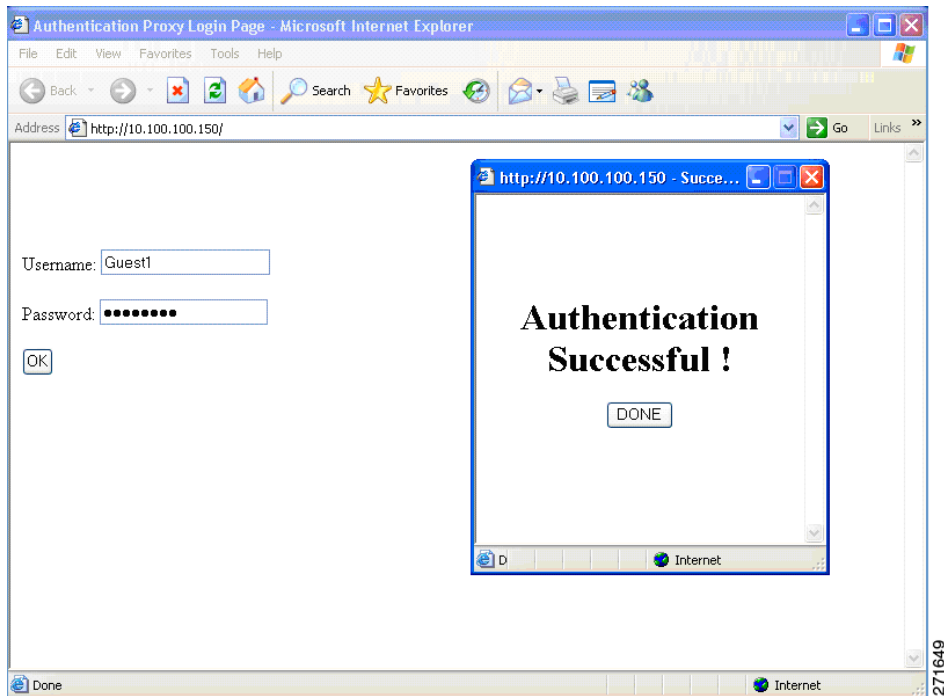
Figure 9-8 Login Screen With No Banner

For more information, see the [“Configuring a Web Authentication Local Banner”](#) section on page 9-50

Using IEEE 802.1x Authentication with ACLs and the RADIUS Filter-Id Attribute



Note

To use IEEE 802.1x authentication with ACLs and the *Filter-Id* attribute, the switch must be running the LAN base image.

The switch supports only IP standard and IP extended port access control lists (ACLs) applied to ingress ports.

- ACLs that you configure
- ACLs from the Access Control Server (ACS)

An IEEE 802.1x port in single-host mode uses ACLs from the ACS to provide different levels of service to an IEEE 802.1x-authenticated user. When the RADIUS server authenticates this type of user and port, it sends ACL attributes based on the user identity to the switch. The switch applies the attributes to the port for the duration of the user session. If the session is over, authentication fails, or a link fails, the port becomes unauthorized, and the switch removes the ACL on the port.

Only IP standard and IP extended port ACLs from the ACS support the Filter-Id attribute. It specifies the name or number of an ACL. The Filter-id attribute can also specify the direction (inbound or outbound) and a user or a group to which the user belongs.

- The Filter-Id attribute for the user takes precedence over that for the group.
- If a Filter-Id attribute from the ACS specifies an ACL that is already configured, it takes precedence over a user-configured ACL.
- If the RADIUS server sends more than one Filter-Id attribute, only the last attribute is applied.

If the Filter-Id attribute is not defined on the switch, authentication fails, and the port returns to the unauthorized state.

Configuring IEEE 802.1x Authentication

These sections contain this configuration information:

- [Default IEEE 802.1x Authentication Configuration, page 9-26](#)
- [IEEE 802.1x Authentication Configuration Guidelines, page 9-27](#)
- [Upgrading from a Previous Software Release, page 9-29](#)
- [Configuring 802.1x Readiness Check, page 9-29](#)(optional)
- [Configuring Voice Aware 802.1x Security, page 9-30](#)(optional)
- [Configuring IEEE 802.1x Violation Modes, page 9-32](#) (optional)
- [Configuring the Switch-to-RADIUS-Server Communication, page 9-34](#) (required)
- [Configuring the Host Mode, page 9-35](#) (optional)
- [Configuring Periodic Re-Authentication, page 9-36](#) (optional)
- [Manually Re-Authenticating a Client Connected to a Port, page 9-37](#) (optional)
- [Changing the Quiet Period, page 9-37](#) (optional)
- [Changing the Switch-to-Client Retransmission Time, page 9-38](#) (optional)
- [Setting the Switch-to-Client Frame-Retransmission Number, page 9-38](#) (optional)
- [Setting the Re-Authentication Number, page 9-39](#) (optional)
- [Configuring IEEE 802.1x Accounting, page 9-40](#) (optional)
- [Configuring a Guest VLAN, page 9-41](#) (optional)
- [Configuring a Restricted VLAN, page 9-41](#) (optional)
- [Configuring the Inaccessible Authentication Bypass Feature, page 9-43](#) (optional)
- [Configuring IEEE 802.1x Authentication with WoL, page 9-45](#) (optional)
- [Configuring MAC Authentication Bypass, page 9-46](#) (optional)
- [Configuring NAC Layer 2 IEEE 802.1x Validation, page 9-47](#) (optional)
- [Configuring Web Authentication, page 9-48](#) (optional)
- [Configuring a Web Authentication Local Banner, page 9-50](#) (optional)
- [Disabling IEEE 802.1x Authentication on the Port, page 9-51](#) (optional)
- [Resetting the IEEE 802.1x Authentication Configuration to the Default Values, page 9-52](#) (optional)

Default IEEE 802.1x Authentication Configuration

Table 9-2 shows the default IEEE 802.1x authentication configuration.

Table 9-2 Default IEEE 802.1x Authentication Configuration

Feature	Default Setting
Switch IEEE 802.1x enable state	Disabled.
Per-port IEEE 802.1x enable state	Disabled (force-authorized). The port sends and receives normal traffic without IEEE 802.1x-based authentication of the client.
AAA	Disabled.
RADIUS server <ul style="list-style-type: none"> IP address UDP authentication port Key 	<ul style="list-style-type: none"> None specified. 1812. None specified.
Host mode	Single-host mode.
Control direction	Bidirectional control.
Periodic re-authentication	Disabled.
Number of seconds between re-authentication attempts	3600 seconds.
Re-authentication number	2 times (number of times that the switch restarts the authentication process before the port changes to the unauthorized state).
Quiet period	60 seconds (number of seconds that the switch remains in the quiet state following a failed authentication exchange with the client).
Retransmission time	30 seconds (number of seconds that the switch should wait for a response to an EAP request/identity frame from the client before resending the request).
Maximum retransmission number	2 times (number of times that the switch will send an EAP-request/identity frame before restarting the authentication process).
Client timeout period	30 seconds (when relaying a request from the authentication server to the client, the amount of time the switch waits for a response before resending the request to the client.)
Authentication server timeout period	30 seconds (when relaying a response from the client to the authentication server, the amount of time the switch waits for a reply before resending the response to the server.) You can change this timeout period by using the dot1x timeout server-timeout interface configuration command.
Inactivity timeout	Disabled.
Guest VLAN	None specified.
Inaccessible authentication bypass	Disabled.
Restricted VLAN	None specified.
Authenticator (switch) mode	None specified.

Table 9-2 Default IEEE 802.1x Authentication Configuration (continued)

Feature	Default Setting
MAC authentication bypass	Disabled.
Voice-aware security	Disabled

IEEE 802.1x Authentication Configuration Guidelines

This section has configuration guidelines for these features:

- [IEEE 802.1x Authentication, page 9-27](#)
- [VLAN Assignment, Guest VLAN, Restricted VLAN, and Inaccessible Authentication Bypass, page 9-28](#)
- [MAC Authentication Bypass, page 9-29](#)
- [Maximum Number of Allowed Devices Per Port, page 9-29](#)

IEEE 802.1x Authentication

These are the IEEE 802.1x authentication configuration guidelines:

- When IEEE 802.1x authentication is enabled, ports are authenticated before any other Layer 2 feature is enabled.
- If you try to change the mode of an IEEE 802.1x-enabled port (for example, from access to trunk), an error message appears, and the port mode is not changed.
- If the VLAN to which an IEEE 802.1x-enabled port is assigned changes, this change is transparent and does not affect the switch. For example, this change occurs if a port is assigned to a RADIUS server-assigned VLAN and is then assigned to a different VLAN after re-authentication.
If the VLAN to which an IEEE 802.1x port is assigned to shut down, disabled, or removed, the port becomes unauthorized. For example, the port is unauthorized after the access VLAN to which a port is assigned shuts down or is removed.
- The IEEE 802.1x protocol is supported on Layer 2 static-access ports and voice VLAN ports, but it is not supported on these port types:
 - Trunk port—If you try to enable IEEE 802.1x authentication on a trunk port, an error message appears, and IEEE 802.1x authentication is not enabled. If you try to change the mode of an IEEE 802.1x-enabled port to trunk, an error message appears, and the port mode is not changed.
 - Dynamic ports—A port in dynamic mode can negotiate with its neighbor to become a trunk port. If you try to enable IEEE 802.1x authentication on a dynamic port, an error message appears, and IEEE 802.1x authentication is not enabled. If you try to change the mode of an IEEE 802.1x-enabled port to dynamic, an error message appears, and the port mode is not changed.
 - Dynamic-access ports—If you try to enable IEEE 802.1x authentication on a dynamic-access (VLAN Query Protocol [VQP]) port, an error message appears, and IEEE 802.1x authentication is not enabled. If you try to change an IEEE 802.1x-enabled port to dynamic VLAN assignment, an error message appears, and the VLAN configuration is not changed.

- EtherChannel port—Do not configure a port that is an active or a not-yet-active member of an EtherChannel as an IEEE 802.1x port. If you try to enable IEEE 802.1x authentication on an EtherChannel port, an error message appears, and IEEE 802.1x authentication is not enabled.
- Switched Port Analyzer (SPAN) and Remote SPAN (RSPAN) destination ports—You can enable IEEE 802.1x authentication on a port that is a SPAN or RSPAN destination port. However, IEEE 802.1x authentication is disabled until the port is removed as a SPAN or RSPAN destination port. You can enable IEEE 802.1x authentication on a SPAN or RSPAN source port.
- Before globally enabling IEEE 802.1x authentication on a switch by entering the **dot1x system-auth-control** global configuration command, remove the EtherChannel configuration from the interfaces on which IEEE 802.1x authentication and EtherChannel are configured.

VLAN Assignment, Guest VLAN, Restricted VLAN, and Inaccessible Authentication Bypass

These are the configuration guidelines for VLAN assignment, guest VLAN, restricted VLAN, and inaccessible authentication bypass:

- When IEEE 802.1x authentication is enabled on a port, you cannot configure a port VLAN that is equal to a voice VLAN.
- The IEEE 802.1x authentication with VLAN assignment feature is not supported on trunk ports, dynamic ports, or with dynamic-access port assignment through a VMPS.
- You can configure any VLAN except an RSPAN VLAN or a voice VLAN as an IEEE 802.1x guest VLAN. The guest VLAN feature is not supported on trunk ports; it is supported only on access ports.
- After you configure a guest VLAN for an IEEE 802.1x port to which a DHCP client is connected, you might need to get a host IP address from a DHCP server. You can change the settings for restarting the IEEE 802.1x authentication process on the switch before the DHCP process on the client times out and tries to get a host IP address from the DHCP server. Decrease the settings for the IEEE 802.1x authentication process (**dot1x timeout quiet-period** and **dot1x timeout tx-period** interface configuration commands). The amount to decrease the settings depends on the connected IEEE 802.1x client type.
- When configuring the inaccessible authentication bypass feature, follow these guidelines:
 - The feature is supported on IEEE 802.1x port in single-host mode and multihosts mode.
 - If the client is running Windows XP and the port to which the client is connected is in the critical-authentication state, Windows XP might report that the interface is not authenticated.
 - If the Windows XP client is configured for DHCP and has an IP address from the DHCP server, receiving an EAP-Success message on a critical port might not re-initiate the DHCP configuration process.
 - You can configure the inaccessible authentication bypass feature and the restricted VLAN on an IEEE 802.1x port. If the switch tries to re-authenticate a critical port in a restricted VLAN and all the RADIUS servers are unavailable, switch changes the port state to the critical authentication state and remains in the restricted VLAN.
 - You can configure the inaccessible bypass feature and port security on the same switch port.
- You can configure any VLAN except an RSPAN VLAN or a voice VLAN as an IEEE 802.1x restricted VLAN. The restricted VLAN feature is not supported on trunk ports; it is supported only on access ports.

MAC Authentication Bypass

These are the MAC authentication bypass configuration guidelines:

- Unless otherwise stated, the MAC authentication bypass guidelines are the same as the IEEE 802.1x authentication guidelines. For more information, see the [“IEEE 802.1x Authentication” section on page 9-27](#).
- If you disable MAC authentication bypass from a port after the port has been authorized with its MAC address, the port state is not affected.
- If the port is in the unauthorized state and the client MAC address is not the authentication-server database, the port remains in the unauthorized state. However, if the client MAC address is added to the database, the switch can use MAC authentication bypass to re-authorize the port.
- If the port is in the authorized state, the port remains in this state until re-authorization occurs.
- In Cisco IOS Release 12.2(35)SE and later, you can configure a timeout period for hosts that are connected by MAC authentication bypass but are inactive. The range is 1 to 65535 seconds. You must enable port security before configuring a time out value. For more information, see the [“Configuring Port Security” section on page 21-8](#).

Maximum Number of Allowed Devices Per Port

This is the maximum number of devices allowed on an IEEE 802.1x-enabled port:

- In single-host mode, only one device is allowed on the access VLAN. If the port is also configured with a voice VLAN, an unlimited number of Cisco IP phones can send and receive traffic through the voice VLAN.
- In multidomain authentication (MDA) mode, one device is allowed for the access VLAN, and one IP phone is allowed for the voice VLAN.
- In multihost mode, only one IEEE 802.1x supplicant is allowed on the port, but an unlimited number of non-IEEE 802.1x hosts are allowed on the access VLAN. An unlimited number of devices are allowed on the voice VLAN.

Upgrading from a Previous Software Release

In Cisco IOS Release 12.2(25)SEE, the implementation for IEEE 802.1x authentication changed from the previous releases. When IEEE 802.1x authentication is enabled, information about Port Fast is no longer added to the configuration and this information appears in the running configuration:

```
dot1x pae authenticator
```

Configuring 802.1x Readiness Check

The 802.1x readiness check monitors IEEE 802.1x activity on all the switch ports and displays information about the devices connected to the ports that support IEEE 802.1x. You can use this feature to determine if the devices connected to the switch ports are IEEE 802.1x-capable.

The 802.1x readiness check is allowed on all ports that can be configured for IEEE 802.1x. The readiness check is not available on a port that is configured as **dot1x force-unauthorized**.

Follow these guidelines to enable the readiness check on the switch:

- The readiness check is typically used before IEEE 802.1x is enabled on the switch.
- If you use the **dot1x test eapol-capable** privileged EXEC command without specifying an interface, all the ports on the switch stack are tested.
- When you configure the **dot1x test eapol-capable** command on an IEEE 802.1x-enabled port, and the link comes up, the port queries the connected client about its IEEE 802.1x capability. When the client responds with a notification packet, it is IEEE 802.1x-capable. A syslog message is generated if the client responds within the timeout period. If the client does not respond to the query, the client is not IEEE 802.1x-capable. No syslog message is generated.
- The readiness check can be sent on a port that handles multiple hosts (for example, a PC that is connected to an IP phone). A syslog message is generated for each of the clients that respond to the readiness check within the timer period.

Beginning in privileged EXEC mode, follow these steps to enable the IEEE 802.1x readiness check on the switch:

	Command	Purpose
Step 1	dot1x test eapol-capable [interface <i>interface-id</i>]	Enable the 802.1x readiness check on the switch. (Optional) For <i>interface-id</i> specify the port on which to check for IEEE 802.1x readiness. Note If you omit the optional interface keyword, all interfaces on the switch are tested.
Step 1	configure terminal	(Optional) Enter global configuration mode.
Step 2	dot1x test timeout <i>timeout</i>	(Optional) Configure the timeout used to wait for EAPOL response. The range is from 1 to 65535 seconds. The default is 10 seconds.
Step 3	end	(Optional) Return to privileged EXEC mode.
Step 4	show running-config	(Optional) Verify your modified timeout values.

This example shows how to enable a readiness check on a switch to query a port. It also shows the response received from the queried port verifying that the device connected to it is IEEE 802.1x-capable:

```
switch# dot1x test eapol-capable interface gigabitethernet0/13
```

```
DOT1X_PORT_EAPOL_CAPABLE:DOT1X: MAC 00-01-02-4b-f1-a3 on gigabitethernet0/13 is EAPOL capable
```

Configuring Voice Aware 802.1x Security



Note

To use voice aware IEEE 802.1x authentication, the switch must be running the LAN base image.

You use the voice aware 802.1x security feature on the switch to disable only the VLAN on which a security violation occurs, whether it is a data or voice VLAN. You can use this feature in IP phone deployments where a PC is connected to the IP phone. A security violation found on the data VLAN results in the shutdown of only the data VLAN. The traffic on the voice VLAN flows through the switch without interruption.

Follow these guidelines to configure voice aware 802.1x voice security on the switch:

- You enable voice aware 802.1x security by entering the **errdisable detect cause security-violation shutdown vlan** global configuration command. You disable voice aware 802.1x security by entering the **no** version of this command. This command applies to all IEEE 802.1x-configured ports in the switch.

**Note**

If you do not include the **shutdown vlan** keywords, the entire port is shut down when it enters the error-disabled state.

- If you use the **errdisable recovery cause security-violation** global configuration command to configure error-disabled recovery, the port is automatically re-enabled. If error-disabled recovery is not configured for the port, you re-enable it by using the **shutdown** and **no-shutdown** interface configuration commands.
- You can re-enable individual VLANs by using the **clear errdisable interface interface-id vlan [vlan-list]** privileged EXEC command. If you do not specify a range, all VLANs on the port are enabled.

Beginning in privileged EXEC mode, follow these steps to enable voice aware 802.1x security:

	Command	Purpose
Step 1	configure terminal	Enter global configuration mode.
Step 2	errdisable detect cause security-violation shutdown vlan	Shut down any VLAN on which a security violation error occurs. Note If the shutdown vlan keywords are not included, the entire port enters the error-disabled state and shuts down.
Step 3	errdisable recovery cause security-violation	(Optional) Enable automatic per-VLAN error recovery.
Step 4	clear errdisable interface interface-id vlan [vlan-list]	(Optional) Reenable individual VLANs that have been error disabled. <ul style="list-style-type: none"> For <i>interface-id</i> specify the port on which to reenable individual VLANs. (Optional) For <i>vlan-list</i> specify a list of VLANs to be re-enabled. If <i>vlan-list</i> is not specified, all VLANs are re-enabled.
Step 5	shutdown no-shutdown	(Optional) Re-enable an error-disabled VLAN, and clear all error-disable indications.
Step 6	end	Return to privileged EXEC mode.
Step 7	show errdisable detect	Verify your entries.
Step 8	copy running-config startup-config	(Optional) Save your entries in the configuration file.

This example shows how to configure the switch to shut down any VLAN on which a security violation error occurs:

```
Switch(config)# errdisable detect cause security-violation shutdown vlan
```

This example shows how to re-enable all VLANs that were error disabled on port Gi4/0/2.

```
Switch# clear errdisable interface GigabitEthernet4/0/2 vlan
```

You can verify your settings by entering the **show errdisable detect** privileged EXEC command.

Configuring IEEE 802.1x Violation Modes



Note

To configure violation modes, the switch must be running the LAN base image.

You can configure an IEEE 802.1x port so that it shuts down, generates a syslog error, or discards packets from a new device when:

- a device connects to an IEEE 802.1x-enable port
- the maximum number of allowed about devices have been authenticated on the port

Beginning in privileged EXEC mode, follow these steps to configure the security violation actions on the switch:

	Command	Purpose
Step 1	<code>configure terminal</code>	Enter global configuration mode.
Step 2	<code>aaa new-model</code>	Enable AAA.
Step 3	<code>aaa authentication dot1x {default} method1</code>	<p>Create an IEEE 802.1x authentication method list.</p> <p>To create a default list that is used when a named list is <i>not</i> specified in the authentication command, use the default keyword followed by the method that is to be used in default situations. The default method list is automatically applied to all ports.</p> <p>For <i>method1</i>, enter the group radius keywords to use the list of all RADIUS servers for authentication.</p> <p>Note Though other keywords are visible in the command-line help string, only the group radius keywords are supported.</p>
Step 4	<code>interface interface-id</code>	Specify the port connected to the client that is to be enabled for IEEE 802.1x authentication, and enter interface configuration mode.
Step 5	<code>switchport mode access</code>	Set the port to access mode.
Step 6	<code>dot1x violation-mode {shutdown restrict protect}</code>	<p>Configure the violation mode. The keywords have these meanings:</p> <ul style="list-style-type: none"> • shutdown—Error disable the port. • restrict—Generate a syslog error. • protect—Drop packets from any new device that sends traffic to the port.
Step 7	<code>end</code>	Return to privileged EXEC mode.
Step 8	<code>show dot1x</code>	Verify your entries.
Step 9	<code>copy running-config startup-config</code>	(Optional) Save your entries in the configuration file.

Configuring IEEE 802.1x Authentication

To configure IEEE 802.1x port-based authentication, you must enable authentication, authorization, and accounting (AAA) and specify the authentication method list. A method list describes the sequence and authentication method to be queried to authenticate a user.

To allow VLAN assignment, you must enable AAA authorization to configure the switch for all network-related service requests.

This is the IEEE 802.1x AAA process:

-
- Step 1** A user connects to a port on the switch.
 - Step 2** Authentication is performed.
 - Step 3** VLAN assignment is enabled, as appropriate, based on the RADIUS server configuration.
 - Step 4** The switch sends a start message to an accounting server.
 - Step 5** Re-authentication is performed, as necessary.
 - Step 6** The switch sends an interim accounting update to the accounting server that is based on the result of re-authentication.
 - Step 7** The user disconnects from the port.
 - Step 8** The switch sends a stop message to the accounting server.
-

Beginning in privileged EXEC mode, follow these steps to configure IEEE 802.1x port-based authentication:

	Command	Purpose
Step 1	configure terminal	Enter global configuration mode.
Step 2	aaa new-model	Enable AAA.
Step 3	aaa authentication dot1x {default} <i>method1</i>	<p>Create an IEEE 802.1x authentication method list.</p> <p>To create a default list that is used when a named list is <i>not</i> specified in the authentication command, use the default keyword followed by the method that is to be used in default situations. The default method list is automatically applied to all ports.</p> <p>For <i>method1</i>, enter the group radius keywords to use the list of all RADIUS servers for authentication.</p> <p>Note Though other keywords are visible in the command-line help string, only the group radius keywords are supported.</p>
Step 4	dot1x system-auth-control	Enable IEEE 802.1x authentication globally on the switch.
Step 5	aaa authorization network {default} <i>group radius</i>	(Optional) Configure the switch to use user-RADIUS authorization for all network-related service requests, such as VLAN assignment.
Step 6	radius-server host <i>ip-address</i>	(Optional) Specify the IP address of the RADIUS server.
Step 7	radius-server key <i>string</i>	(Optional) Specify the authentication and encryption key used between the switch and the RADIUS daemon running on the RADIUS server.
Step 8	interface <i>interface-id</i>	Specify the port connected to the client that is to be enabled for IEEE 802.1x authentication, and enter interface configuration mode.
Step 9	switchport mode access	(Optional) Set the port to access mode only if you configured the RADIUS server in Step 6 and Step 7.

	Command	Purpose
Step 10	dot1x port-control auto	Enable IEEE 802.1x authentication on the port. For feature interaction information, see the “IEEE 802.1x Authentication Configuration Guidelines” section on page 9-27.
Step 11	end	Return to privileged EXEC mode.
Step 12	show dot1x	Verify your entries.
Step 13	copy running-config startup-config	(Optional) Save your entries in the configuration file.

Configuring the Switch-to-RADIUS-Server Communication

RADIUS security servers are identified by their hostname or IP address, hostname and specific UDP port numbers, or IP address and specific UDP port numbers. The combination of the IP address and UDP port number creates a unique identifier, which enables RADIUS requests to be sent to multiple UDP ports on a server at the same IP address. If two different host entries on the same RADIUS server are configured for the same service—for example, authentication—the second host entry configured acts as the fail-over backup to the first one. The RADIUS host entries are tried in the order that they were configured.

Beginning in privileged EXEC mode, follow these steps to configure the RADIUS server parameters on the switch. This procedure is required.

	Command	Purpose
Step 1	configure terminal	Enter global configuration mode.
Step 2	radius-server host { <i>hostname</i> <i>ip-address</i> } auth-port <i>port-number</i> key <i>string</i>	Configure the RADIUS server parameters. For <i>hostname</i> <i>ip-address</i> , specify the hostname or IP address of the remote RADIUS server. For auth-port <i>port-number</i> , specify the UDP destination port for authentication requests. The default is 1812. The range is 0 to 65536. For key <i>string</i> , specify the authentication and encryption key used between the switch and the RADIUS daemon running on the RADIUS server. The key is a text string that must match the encryption key used on the RADIUS server. Note Always configure the key as the last item in the radius-server host command syntax because leading spaces are ignored, but spaces within and at the end of the key are used. If you use spaces in the key, do not enclose the key in quotation marks unless the quotation marks are part of the key. This key must match the encryption used on the RADIUS daemon. If you want to use multiple RADIUS servers, re-enter this command.
Step 3	end	Return to privileged EXEC mode.
Step 4	show running-config	Verify your entries.
Step 5	copy running-config startup-config	(Optional) Save your entries in the configuration file.

To delete the specified RADIUS server, use the **no radius-server host** {*hostname* | *ip-address*} global configuration command.

This example shows how to specify the server with IP address 172.20.39.46 as the RADIUS server, to use port 1612 as the authorization port, and to set the encryption key to *rad123*, matching the key on the RADIUS server:

```
Switch(config)# radius-server host 172.120.39.46 auth-port 1612 key rad123
```

You can globally configure the timeout, retransmission, and encryption key values for all RADIUS servers by using the **radius-server host** global configuration command. If you want to configure these options on a per-server basis, use the **radius-server timeout**, **radius-server retransmit**, and the **radius-server key** global configuration commands. For more information, see the “[Configuring Settings for All RADIUS Servers](#)” section on page 8-29.

You also need to configure some settings on the RADIUS server. These settings include the IP address of the switch and the key string to be shared by both the server and the switch. For more information, see the RADIUS server documentation.

Configuring the Host Mode

Beginning in privileged EXEC mode, follow these steps to allow a single host (client) or multiple hosts on an IEEE 802.1x-authorized port that has the dot1x port-control interface configuration command set to **auto**. Use the **multi-domain** keyword to configure multidomain authentication (MDA) to enable authentication of both a host and a voice device, such as an IP phone (Cisco or non-Cisco) on the same switch port. This procedure is optional.

	Command	Purpose
Step 1	configure terminal	Enter global configuration mode.
Step 2	radius-server vsa send authentication	Configure the network access server to recognize and use vendor-specific attributes (VSAs).
Step 3	interface <i>interface-id</i>	Specify the port to which multiple hosts are indirectly attached, and enter interface configuration mode.
Step 4	dot1x host-mode { single-host multi-host multi-domain }	<p>The keywords have these meanings:</p> <ul style="list-style-type: none"> single-host—Allow a single host (client) on an IEEE 802.1x-authorized port. multi-host—Allow multiple hosts on an IEEE 802.1x-authorized port after a single host has been authenticated. multi-domain—Allow both a host and a voice device, such as an IP phone (Cisco or non-Cisco), to be authenticated on an IEEE 802.1x-authorized port. <p>Note You must configure the voice VLAN for the IP phone when the host mode is set to multi-domain. For more information, see Chapter 14, “Configuring Voice VLAN.”</p> <p>Make sure that the dot1x port-control interface configuration command set is set to auto for the specified interface.</p>
Step 5	switchport voice vlan <i>vlan-id</i>	(Optional) Configure the voice VLAN.
Step 6	end	Return to privileged EXEC mode.
Step 7	show dot1x interface <i>interface-id</i>	Verify your entries.
Step 8	copy running-config startup-config	(Optional) Save your entries in the configuration file.

To disable multiple hosts on the port, use the **no dot1x host-mode multi-host** interface configuration command.

This example shows how to enable IEEE 802.1x authentication and to allow multiple hosts:

```
Switch(config)# interface gigabitethernet0/1

Switch(config-if)# dot1x port-control auto
Switch(config-if)# dot1x host-mode multi-host
Switch(config-if)# end
```

This example shows how to enable MDA and to allow both a host and a voice device on the port:

```
Switch(config)# interface gigabitethernet3/0/1
Switch(config-if)# dot1x port-control auto
Switch(config-if)# dot1x host-mode multi-domain
Switch(config-if)# switchport voice vlan 101
Switch(config-if)# end
```

Configuring Periodic Re-Authentication

You can enable periodic IEEE 802.1x client re-authentication and specify how often it occurs. If you do not specify a time period before enabling re-authentication, the number of seconds between attempts is 3600.

Beginning in privileged EXEC mode, follow these steps to enable periodic re-authentication of the client and to configure the number of seconds between re-authentication attempts. This procedure is optional.

	Command	Purpose
Step 1	configure terminal	Enter global configuration mode.
Step 2	interface <i>interface-id</i>	Specify the port to be configured, and enter interface configuration mode.
Step 3	dot1x reauthentication	Enable periodic re-authentication of the client, which is disabled by default.
Step 4	dot1x timeout reauth-period { <i>seconds</i> <i>server</i> }	Set the number of seconds between re-authentication attempts. The keywords have these meanings: <ul style="list-style-type: none"> <i>seconds</i>—Sets the number of seconds from 1 to 65535; the default is 3600 seconds. server—Sets the number of seconds based on the value of the Session-Timeout RADIUS attribute (Attribute[27]) and the Termination-Action RADIUS attribute (Attribute [29]). This command affects the behavior of the switch only if periodic re-authentication is enabled.
Step 5	end	Return to privileged EXEC mode.
Step 6	show dot1x interface <i>interface-id</i>	Verify your entries.
Step 7	copy running-config startup-config	(Optional) Save your entries in the configuration file.

To disable periodic re-authentication, use the **no dot1x reauthentication** interface configuration command. To return to the default number of seconds between re-authentication attempts, use the **no dot1x timeout reauth-period** interface configuration command.

This example shows how to enable periodic re-authentication and set the number of seconds between re-authentication attempts to 4000:

```
Switch(config-if)# dot1x reauthentication
Switch(config-if)# dot1x timeout reauth-period 4000
```

Manually Re-Authenticating a Client Connected to a Port

You can manually re-authenticate the client connected to a specific port at any time by entering the **dot1x re-authenticate interface** *interface-id* privileged EXEC command. This step is optional. If you want to enable or disable periodic re-authentication, see the [“Configuring Periodic Re-Authentication” section on page 9-36](#).

This example shows how to manually re-authenticate the client connected to a port:

```
Switch# dot1x re-authenticate interface gigabitethernet0/1
```

Changing the Quiet Period

When the switch cannot authenticate the client, the switch remains idle for a set period of time and then tries again. The **dot1x timeout quiet-period** interface configuration command controls the idle period. A failed authentication of the client might occur because the client provided an invalid password. You can provide a faster response time to the user by entering a number smaller than the default.

Beginning in privileged EXEC mode, follow these steps to change the quiet period. This procedure is optional.

	Command	Purpose
Step 1	configure terminal	Enter global configuration mode.
Step 2	interface <i>interface-id</i>	Specify the port to be configured, and enter interface configuration mode.
Step 3	dot1x timeout quiet-period <i>seconds</i>	Set the number of seconds that the switch remains in the quiet state following a failed authentication exchange with the client. The range is 1 to 65535 seconds; the default is 60.
Step 4	end	Return to privileged EXEC mode.
Step 5	show dot1x interface <i>interface-id</i>	Verify your entries.
Step 6	copy running-config startup-config	(Optional) Save your entries in the configuration file.

To return to the default quiet time, use the **no dot1x timeout quiet-period** interface configuration command.

This example shows how to set the quiet time on the switch to 30 seconds:

```
Switch(config-if)# dot1x timeout quiet-period 30
```

Changing the Switch-to-Client Retransmission Time

The client responds to the EAP-request/identity frame from the switch with an EAP-response/identity frame. If the switch does not receive this response, it waits a set period of time (known as the retransmission time) and then resends the frame.



Note

You should change the default value of this command only to adjust for unusual circumstances such as unreliable links or specific behavioral problems with certain clients and authentication servers.

Beginning in privileged EXEC mode, follow these steps to change the amount of time that the switch waits for client notification. This procedure is optional.

	Command	Purpose
Step 1	configure terminal	Enter global configuration mode.
Step 2	interface <i>interface-id</i>	Specify the port to be configured, and enter interface configuration mode.
Step 3	dot1x timeout tx-period <i>seconds</i>	Set the number of seconds that the switch waits for a response to an EAP-request/identity frame from the client before resending the request. The range is 1 to 65535 seconds; the default is 5.
Step 4	end	Return to privileged EXEC mode.
Step 5	show dot1xinterface <i>interface-id</i>	Verify your entries.
Step 6	copy running-config startup-config	(Optional) Save your entries in the configuration file.

To return to the default retransmission time, use the **no dot1x timeout tx-period** interface configuration command.

This example shows how to set 60 as the number of seconds that the switch waits for a response to an EAP-request/identity frame from the client before resending the request:

```
Switch(config-if)# dot1x timeout tx-period 60
```

Setting the Switch-to-Client Frame-Retransmission Number

In addition to changing the switch-to-client retransmission time, you can change the number of times that the switch sends an EAP-request/identity frame (assuming no response is received) to the client before restarting the authentication process.



Note

You should change the default value of this command only to adjust for unusual circumstances such as unreliable links or specific behavioral problems with certain clients and authentication servers.

Beginning in privileged EXEC mode, follow these steps to set the switch-to-client frame-retransmission number. This procedure is optional.

	Command	Purpose
Step 1	configure terminal	Enter global configuration mode.
Step 2	interface <i>interface-id</i>	Specify the port to be configured, and enter interface configuration mode.

	Command	Purpose
Step 3	<code>dot1x max-reauth-req count</code>	Set the number of times that the switch sends an EAP-request/identity frame to the client before restarting the authentication process. The range is 1 to 10; the default is 2.
Step 4	<code>end</code>	Return to privileged EXEC mode.
Step 5	<code>show dot1x interface interface-id</code>	Verify your entries.
Step 6	<code>copy running-config startup-config</code>	(Optional) Save your entries in the configuration file.

To return to the default retransmission number, use the **no dot1x max-req** interface configuration command.

This example shows how to set 5 as the number of times that the switch sends an EAP-request/identity request before restarting the authentication process:

```
Switch(config-if)# dot1x max-req 5
```

Setting the Re-Authentication Number

You can also change the number of times that the switch restarts the authentication process before the port changes to the unauthorized state.



Note

You should change the default value of this command only to adjust for unusual circumstances such as unreliable links or specific behavioral problems with certain clients and authentication servers.

Beginning in privileged EXEC mode, follow these steps to set the re-authentication number. This procedure is optional.

	Command	Purpose
Step 1	<code>configure terminal</code>	Enter global configuration mode.
Step 2	<code>interface interface-id</code>	Specify the port to be configured, and enter interface configuration mode.
Step 3	<code>dot1x max-reauth-req count</code>	Set the number of times that the switch restarts the authentication process before the port changes to the unauthorized state. The range is 0 to 10; the default is 2.
Step 4	<code>end</code>	Return to privileged EXEC mode.
Step 5	<code>show dot1x interface interface-id</code>	Verify your entries.
Step 6	<code>copy running-config startup-config</code>	(Optional) Save your entries in the configuration file.

To return to the default re-authentication number, use the **no dot1x max-reauth-req** interface configuration command.

This example shows how to set 4 as the number of times that the switch restarts the authentication process before the port changes to the unauthorized state:

```
Switch(config-if)# dot1x max-reauth-req 4
```

Configuring IEEE 802.1x Accounting

Enabling AAA system accounting with IEEE 802.1x accounting allows system reload events to be sent to the accounting RADIUS server for logging. The server can then infer that all active IEEE 802.1x sessions are closed.

Because RADIUS uses the unreliable UDP transport protocol, accounting messages might be lost due to poor network conditions. If the switch does not receive the accounting response message from the RADIUS server after a configurable number of retransmissions of an accounting request, this system message appears:

```
Accounting message %s for session %s failed to receive Accounting Response.
```

When the stop message is not sent successfully, this message appears:

```
00:09:55: %RADIUS-4-RADIUS_DEAD: RADIUS server 172.20.246.201:1645,1646 is not responding.
```



Note

You must configure the RADIUS server to perform accounting tasks, such as logging start, stop, and interim-update messages and time stamps. To turn on these functions, enable logging of “Update/Watchdog packets from this AAA client” in your RADIUS server Network Configuration tab. Next, enable “CVS RADIUS Accounting” in your RADIUS server System Configuration tab.

Beginning in privileged EXEC mode, follow these steps to configure IEEE 802.1x accounting after AAA is enabled on your switch. This procedure is optional.

	Command	Purpose
Step 1	configure terminal	Enter global configuration mode.
Step 2	interface <i>interface-id</i>	Specify the port to be configured, and enter interface configuration mode.
Step 3	aaa accounting dot1x default start-stop group radius	Enable IEEE 802.1x accounting using the list of all RADIUS servers.
Step 4	aaa accounting system default start-stop group radius	(Optional) Enables system accounting (using the list of all RADIUS servers) and generates system accounting reload event messages when the switch reloads.
Step 5	end	Return to privileged EXEC mode.
Step 6	show running-config	Verify your entries.
Step 7	copy running-config startup-config	(Optional) Saves your entries in the configuration file.

Use the **show radius statistics** privileged EXEC command to display the number of RADIUS messages that do not receive the accounting response message.

This example shows how to configure IEEE 802.1x accounting. The first command configures the RADIUS server, specifying 1813 as the UDP port for accounting:

```
Switch(config)# radius-server host 172.120.39.46 auth-port 1812 acct-port 1813 key rad123
Switch(config)# aaa accounting dot1x default start-stop group radius
Switch(config)# aaa accounting system default start-stop group radius
```

Configuring a Guest VLAN

When you configure a guest VLAN, clients that are not IEEE 802.1x-capable are put into the guest VLAN when the server does not receive a response to its EAP request/identity frame. Clients that are IEEE 802.1x-capable but that fail authentication are not granted network access. The switch supports guest VLANs in single-host or multiple-hosts mode.

Beginning in privileged EXEC mode, follow these steps to configure a guest VLAN. This procedure is optional.

	Command	Purpose
Step 1	configure terminal	Enter global configuration mode.
Step 2	interface <i>interface-id</i>	Specify the port to be configured, and enter interface configuration mode. For the supported port types, see the “ IEEE 802.1x Authentication Configuration Guidelines ” section on page 9-27.
Step 3	switchport mode access	Set the port to access mode.
Step 4	dot1x port-control auto	Enable IEEE 802.1x authentication on the port.
Step 5	dot1x guest-vlan <i>vlan-id</i>	Specify an active VLAN as an IEEE 802.1x guest VLAN. The range is 1 to 4094. You can configure any active VLAN except an RSPAN VLAN or a voice VLAN as an IEEE 802.1x guest VLAN.
Step 6	end	Return to privileged EXEC mode.
Step 7	show dot1x interface <i>interface-id</i>	Verify your entries.
Step 8	copy running-config startup-config	(Optional) Save your entries in the configuration file.

To disable and remove the guest VLAN, use the **no dot1x guest-vlan** interface configuration command. The port returns to the unauthorized state.

This example shows how to enable VLAN 2 as an IEEE 802.1x guest VLAN:

```
Switch(config)# interface gigabitethernet0/2
Switch(config-if)# dot1x guest-vlan 2
```

This example shows how to set 3 as the quiet time on the switch, to set 15 as the number of seconds that the switch waits for a response to an EAP-request/identity frame from the client before re-sending the request, and to enable VLAN 2 as an IEEE 802.1x guest VLAN when an IEEE 802.1x port is connected to a DHCP client:

```
Switch(config-if)# dot1x timeout quiet-period 3
Switch(config-if)# dot1x timeout tx-period 15
Switch(config-if)# dot1x guest-vlan 2
```

Configuring a Restricted VLAN

When you configure a restricted VLAN on a switch, clients that are IEEE 802.1x-compliant are moved into the restricted VLAN when the authentication server does not receive a valid username and password. The switch supports restricted VLANs only in single-host mode.

Beginning in privileged EXEC mode, follow these steps to configure a restricted VLAN. This procedure is optional.

	Command	Purpose
Step 1	configure terminal	Enter global configuration mode.
Step 2	interface <i>interface-id</i>	Specify the port to be configured, and enter interface configuration mode. For the supported port types, see the “IEEE 802.1x Authentication Configuration Guidelines” section on page 9-27.
Step 3	switchport mode access	Set the port to access mode.
Step 4	dot1x port-control auto	Enable IEEE 802.1x authentication on the port.
Step 5	dot1x auth-fail vlan <i>vlan-id</i>	Specify an active VLAN as an IEEE 802.1x restricted VLAN. The range is 1 to 4094. You can configure any active VLAN except an RSPAN VLAN or a voice VLAN as an IEEE 802.1x restricted VLAN.
Step 6	end	Return to privileged EXEC mode.
Step 7	show dot1x interface <i>interface-id</i>	(Optional) Verify your entries.
Step 8	copy running-config startup-config	(Optional) Save your entries in the configuration file.

To disable and remove the restricted VLAN, use the **no dot1x auth-fail vlan** interface configuration command. The port returns to the unauthorized state.

This example shows how to enable VLAN 2 as an IEEE 802.1x restricted VLAN:

```
Switch(config)# interface gigabitethernet0/2
Switch(config-if)# dot1x auth-fail vlan 2
```

You can configure the maximum number of authentication attempts allowed before a user is assigned to the restricted VLAN by using the **dot1x auth-fail max-attempts** interface configuration command. The range of allowable authentication attempts is 1 to 3. The default is 3 attempts.

Beginning in privileged EXEC mode, follow these steps to configure the maximum number of allowed authentication attempts. This procedure is optional.

	Command	Purpose
Step 1	configure terminal	Enter global configuration mode.
Step 2	interface <i>interface-id</i>	Specify the port to be configured, and enter interface configuration mode. For the supported port types, see the “IEEE 802.1x Authentication Configuration Guidelines” section on page 9-27.
Step 3	switchport mode access	Set the port to access mode.
Step 4	dot1x port-control auto	Enable IEEE 802.1x authentication on the port.
Step 5	dot1x auth-fail vlan <i>vlan-id</i>	Specify an active VLAN as an IEEE 802.1x restricted VLAN. The range is 1 to 4094. You can configure any active VLAN except an RSPAN VLAN or a voice VLAN as an IEEE 802.1x restricted VLAN.
Step 6	dot1x auth-fail max-attempts <i>max attempts</i>	Specify a number of authentication attempts to allow before a port moves to the restricted VLAN. The range is 1 to 3, and the default is 3.
Step 7	end	Return to privileged EXEC mode.

	Command	Purpose
Step 8	show dot1x interface <i>interface-id</i>	(Optional) Verify your entries.
Step 9	copy running-config startup-config	(Optional) Save your entries in the configuration file.

To return to the default value, use the **no dot1x auth-fail max-attempts** interface configuration command.

This example shows how to set 2 as the number of authentication attempts allowed before the port moves to the restricted VLAN:

```
Switch(config-if)# dot1x auth-fail max-attempts 2
```

Configuring the Inaccessible Authentication Bypass Feature

You can configure the inaccessible bypass feature, also referred to as critical authentication or the AAA fail policy.

Beginning in privileged EXEC mode, follow these steps to configure the port as a critical port and enable the inaccessible authentication bypass feature. This procedure is optional.

	Command	Purpose
Step 1	configure terminal	Enter global configuration mode.
Step 2	radius-server dead-criteria time <i>time</i> tries <i>tries</i>	(Optional) Set the conditions that are used to decide when a RADIUS server is considered unavailable or <i>dead</i> . The range for <i>time</i> is from 1 to 120 seconds. The switch dynamically determines the default <i>seconds</i> value that is 10 to 60 seconds. The range for <i>tries</i> is from 1 to 100. The switch dynamically determines the default <i>tries</i> parameter that is 10 to 100.
Step 3	radius-server deadtime <i>minutes</i>	(Optional) Set the number of minutes that a RADIUS server is not sent requests. The range is from 0 to 1440 minutes (24 hours). The default is 0 minutes.

Command	Purpose
Step 4 radius-server host <i>ip-address</i> [acct-port <i>udp-port</i>] [auth-port <i>udp-port</i>] [test username <i>name</i> [idle-time <i>time</i>] [ignore-acct-port] [ignore-auth-port] [key <i>string</i>]	<p>(Optional) Configure the RADIUS server parameters by using these keywords:</p> <ul style="list-style-type: none"> • acct-port <i>udp-port</i>—Specify the UDP port for the RADIUS accounting server. The range for the UDP port number is from 0 to 65536. The default is 1646. • auth-port <i>udp-port</i>—Specify the UDP port for the RADIUS authentication server. The range for the UDP port number is from 0 to 65536. The default is 1645. <p>Note You should configure the UDP port for the RADIUS accounting server and the UDP port for the RADIUS authentication server to nondefault values.</p> <ul style="list-style-type: none"> • test username <i>name</i>—Enable automated testing of the RADIUS server status, and specify the username to be used. • idle-time <i>time</i>—Set the interval of time in minutes after which the switch sends test packets to the server. The range is from 1 to 35791 minutes. The default is 60 minutes (1 hour). • ignore-acct-port—Disable testing on the RADIUS-server accounting port. • ignore-auth-port—Disable testing on the RADIUS-server authentication port. • key <i>string</i>—Specify the authentication and encryption key for all RADIUS communication between the switch and the RADIUS daemon. <p>Note Always configure the key as the last item in the radius-server host command syntax because leading spaces are ignored, but spaces within and at the end of the key are used. If you use spaces in the key, do not enclose the key in quotation marks unless the quotation marks are part of the key. This key must match the encryption used on the RADIUS daemon.</p> <p>You can also configure the authentication and encryption key by using the radius-server key {0 <i>string</i> 7 <i>string</i> <i>string</i>} global configuration command.</p>
Step 5 dot1x critical { eapol recovery delay <i>milliseconds</i> }	<p>(Optional) Configure the parameters for inaccessible authentication bypass:</p> <p>eapol—Specify that the switch sends an EAPOL-Success message when the switch successfully authenticates the critical port.</p> <p>recovery delay <i>milliseconds</i>—Set the recovery delay period during which the switch waits to re-initialize a critical port when a RADIUS server that was unavailable becomes available. The range is from 1 to 10000 milliseconds. The default is 1000 milliseconds (a port can be re-initialized every second).</p>
Step 6 interface <i>interface-id</i>	<p>Specify the port to be configured, and enter interface configuration mode. For the supported port types, see the “IEEE 802.1x Authentication Configuration Guidelines” section on page 9-27.</p>

	Command	Purpose
Step 7	dot1x critical [recovery action reinitialize vlan <i>vlan-id</i>]	Enable the inaccessible authentication bypass feature, and use these keywords to configure the feature: <ul style="list-style-type: none"> • recovery action reinitialize—Enable the recovery feature, and specify that the recovery action is to authenticate the port when an authentication server is available. • vlan <i>vlan-id</i>—Specify the access VLAN to which the switch can assign a critical port. The range is from 1 to 4094.
Step 8	end	Return to privileged EXEC mode.
Step 9	show dot1x [interface <i>interface-id</i>]	(Optional) Verify your entries.
Step 10	copy running-config startup-config	(Optional) Save your entries in the configuration file.

To return to the RADIUS server default settings, use the **no radius-server dead-criteria**, the **no radius-server deadtime**, and the **no radius-server host** global configuration commands. To return to the default settings of inaccessible authentication bypass, use the **no dot1x critical {eapol | recovery delay}** global configuration command. To disable inaccessible authentication bypass, use the **no dot1x critical** interface configuration command.

This example shows how to configure the inaccessible authentication bypass feature:

```
Switch(config)# radius-server dead-criteria time 30 tries 20
Switch(config)# radius-server deadtime 60
Switch(config)# radius-server host 1.1.1.2 acct-port 1550 auth-port 1560 test username
user1 idle-time 30 key abc1234
Switch(config)# dot1x critical eapol
Switch(config)# dot1x critical recovery delay 2000
Switch(config)# interface gigabitethernet 0/1
Switch(config)# radius-server deadtime 60
Switch(config-if)# dot1x critical
Switch(config-if)# dot1x critical recovery action reinitialize
Switch(config-if)# dot1x critical vlan 20
Switch(config-if)# end
```

Configuring IEEE 802.1x Authentication with WoL

Beginning in privileged EXEC mode, follow these steps to enable IEEE 802.1x authentication with WoL. This procedure is optional.

	Command	Purpose
Step 1	configure terminal	Enter global configuration mode.
Step 2	interface <i>interface-id</i>	Specify the port to be configured, and enter interface configuration mode. For the supported port types, see the “ IEEE 802.1x Authentication Configuration Guidelines ” section on page 9-27.
Step 3	dot1x control-direction { both in }	Enable IEEE 802.1x authentication with WoL on the port, and use these keywords to configure the port as bidirectional or unidirectional. <ul style="list-style-type: none"> • both—Sets the port as bidirectional. The port cannot receive packets from or send packets to the host. By default, the port is bidirectional. • in—Sets the port as unidirectional. The port can send packets to the host but cannot receive packets from the host.

	Command	Purpose
Step 4	end	Return to privileged EXEC mode.
Step 5	show dot1x interface <i>interface-id</i>	Verify your entries.
Step 6	copy running-config startup-config	(Optional) Save your entries in the configuration file.

To disable IEEE 802.1x authentication with WoL, use the **no dot1x control-direction** interface configuration command.

This example shows how to enable IEEE 802.1x authentication with WoL and set the port as bidirectional:

```
Switch(config-if)# dot1x control-direction both
```

Configuring MAC Authentication Bypass

Beginning in privileged EXEC mode, follow these steps to enable MAC authentication bypass. This procedure is optional.

	Command	Purpose
Step 1	configure terminal	Enter global configuration mode.
Step 2	interface <i>interface-id</i>	Specify the port to be configured, and enter interface configuration mode. For the supported port types, see the “IEEE 802.1x Authentication Configuration Guidelines” section on page 9-27.
Step 3	dot1x port-control auto	Enable IEEE 802.1x authentication on the port.
Step 4	dot1x mac-auth-bypass [eap timeout activity { <i>value</i> }]	Enable MAC authentication bypass. (Optional) Use the eap keyword to configure the switch to use EAP for authorization. (Optional) Use the timeout activity keywords to configured the number of seconds that a connected host can be inactive before it is placed in an unauthorized state. The range is 1 to 65535. You must enable port security before configuring a time out value. For more information, see the “Configuring Port Security” section on page 21-8.
Step 5	end	Return to privileged EXEC mode.
Step 6	show dot1x interface <i>interface-id</i>	Verify your entries.
Step 7	copy running-config startup-config	(Optional) Save your entries in the configuration file.

To disable MAC authentication bypass, use the **no dot1x mac-auth-bypass** interface configuration command.

This example shows how to enable MAC authentication bypass:

```
Switch(config-if)# dot1x mac-auth-bypass
```

Configuring NAC Layer 2 IEEE 802.1x Validation

In Cisco IOS Release 12.2(25)SED or later, you can configure NAC Layer 2 IEEE 802.1x validation, which is also referred to as IEEE 802.1x authentication with a RADIUS server.

Beginning in privileged EXEC mode, follow these steps to configure NAC Layer 2 IEEE 802.1x validation. The procedure is optional.

	Command	Purpose
Step 1	configure terminal	Enter global configuration mode.
Step 2	interface <i>interface-id</i>	Specify the port to be configured, and enter interface configuration mode.
Step 3	dot1x guest-vlan <i>vlan-id</i>	Specify an active VLAN as an IEEE 802.1x guest VLAN. The range is 1 to 4094. You can configure any active VLAN except an RSPAN VLAN, or a voice VLAN as an IEEE 802.1x guest VLAN.
Step 4	dot1x reauthentication	Enable periodic re-authentication of the client, which is disabled by default.
Step 5	dot1x timeout reauth-period { <i>seconds</i> <i>server</i> }	Set the number of seconds between re-authentication attempts. The keywords have these meanings: <ul style="list-style-type: none"> <i>seconds</i>—Sets the number of seconds from 1 to 65535; the default is 3600 seconds. <i>server</i>—Sets the number of seconds based on the value of the Session-Timeout RADIUS attribute (Attribute[27]) and the Termination-Action RADIUS attribute (Attribute [29]). This command affects the behavior of the switch only if periodic re-authentication is enabled.
Step 6	end	Return to privileged EXEC mode.
Step 7	show dot1x interface <i>interface-id</i>	Verify your IEEE 802.1x authentication configuration.
Step 8	copy running-config startup-config	(Optional) Save your entries in the configuration file.

This example shows how to configure NAC Layer 2 IEEE 802.1x validation:

```
Switch# configure terminal
Switch(config)# interface gigabitethernet0/1
Switch(config-if)# dot1x reauthentication
Switch(config-if)# dot1x timeout reauth-period server
```

Configuring Web Authentication

Note

To configure Web Authentication, the switch must be running the LAN base image.

Beginning in privileged EXEC mode, follow these steps to configure authentication, authorization, accounting (AAA) and RADIUS on a switch before configuring web authentication. The steps enable AAA by using RADIUS authentication and enable device tracking.

	Command	Purpose
Step 1	configure terminal	Enter global configuration mode.
Step 2	aaa new-model	Enable AAA.
Step 3	aaa authentication login default group radius	Use RADIUS authentication. Before you can use this authentication method, you must configure the RADIUS server. For more information, see Chapter 8, “Configuring Switch-Based Authentication.” The console prompts you for a username and password on future attempts to access the switch console after entering the aaa authentication login command. If you do not want to be prompted for a username and password, configure a second login authentication list: Switch# config t Switch(config)# aaa authentication login line-console none Switch(config)# line console 0 Switch(config-line)# login authentication line-console Switch(config-line)# end
Step 4	aaa authorization auth-proxy default group radius	Use RADIUS for authentication-proxy (auth-proxy) authorization.
Step 5	radius-server host key radius-key	Specify the authentication and encryption key for RADIUS communication between the switch and the RADIUS daemon.
Step 6	radius-server attribute 8 include-in-access-req	Configure the switch to send the Framed-IP-Address RADIUS attribute (Attribute[8]) in access-request or accounting-request packets.
Step 7	radius-server vsa send authentication	Configure the network access server to recognize and use vendor-specific attributes (VSAs).
Step 8	ip device tracking	Enable the IP device tracking table. To disable the IP device tracking table, use the no ip device tracking global configuration commands.
Step 9	end	Return to privileged EXEC mode.

This example shows how to enable AAA, use RADIUS authentication and enable device tracking:

```
Switch(config) configure terminal
Switch(config)# aaa new-model
Switch(config)# aaa authentication login default group radius
Switch(config)# aaa authorization auth-proxy default group radius
Switch(config)# radius-server host 1.1.1.2 key key1
Switch(config)# radius-server attribute 8 include-in-access-req
```

```
Switch(config)# radius-server vsa send authentication
Switch(config)# ip device tracking
Switch(config) end
```

Beginning in privileged EXEC mode, follow these steps to configure a port to use web authentication:

	Command	Purpose
Step 1	configure terminal	Enter global configuration mode.
Step 2	ip admission name rule proxy http	Define a web authentication rule. Note The same rule cannot be used for both web authentication and NAC Layer 2 IP validation. For more information, see the Network Admission Control Software Configuration Guide on Cisco.com.
Step 3	interface interface-id	Specify the port to be configured, and enter interface configuration mode.
Step 4	switchport mode access	Set the port to access mode.
Step 5	ip access-group access-list in	Specify the default access control list to be applied to network traffic before web authentication.
Step 6	ip admission rule	Apply an IP admission rule to the interface.
Step 7	end	Return to privileged EXEC mode.
Step 8	show running-config interface interface-id	Verify your configuration.
Step 9	copy running-config startup-config	(Optional) Save your entries in the configuration file.

This example shows how to configure only web authentication on a switch port:

```
Switch# configure terminal
Switch(config)# ip admission name rule1 proxy http
Switch(config)# interface gigabit0/1
Switch(config-if)# switchport mode access
Switch(config-if)# ip access-group policy1 in
Switch(config-if)# ip admission rule1
Switch(config-if)# end
```

Beginning in privileged EXEC mode, follow these steps to configure a switch port for IEEE 802.1x authentication with web authentication as a fallback method:

	Command	Purpose
Step 1	configure terminal	Enter global configuration mode.
Step 2	ip admission name rule proxy http	Define a web authentication rule.
Step 3	fallback profile fallback-profile	Define a fallback profile to allow an IEEE 802.1x port to authenticate a client by using web authentication.
Step 4	ip access-group policy in	Specify the default access control list to apply to network traffic before web authentication.
Step 5	ip admission rule	Associate an IP admission rule with the profile, and specify that a client connecting by web authentication uses this rule.
Step 6	end	Return to privileged EXEC mode.

	Command	Purpose
Step 7	<code>interface interface-id</code>	Specify the port to be configured, and enter interface configuration mode.
Step 8	<code>switchport mode access</code>	Set the port to access mode.
Step 9	<code>dot1x port-control auto</code>	Enable IEEE 802.1x authentication on the interface.
Step 10	<code>dot1x fallback fallback-profile</code>	Configure the port to authenticate a client by using web authentication when no IEEE 802.1x supplicant is detected on the port. Any change to the fallback-profile global configuration takes effect the next time IEEE 802.1x fallback is invoked on the interface. Note Web authorization cannot be used as a fallback method for IEEE 802.1x if the port is configured for multidomain authentication.
Step 11	<code>exit</code>	Return to privileged EXEC mode.
Step 12	<code>show dot1x interface interface-id</code>	Verify your configuration.
Step 13	<code>copy running-config startup-config</code>	(Optional) Save your entries in the configuration file.

This example shows how to configure IEEE 802.1x authentication with web authentication as a fallback method.

```
Switch(config) configure terminal
Switch(config)# ip admission name rule1 proxy http
Switch(config)# fallback profile fallback1
Switch(config-fallback-profile)# ip access-group default-policy in
Switch(config-fallback-profile)# ip admission rule1
Switch(config-fallback-profile)# exit
Switch(config)# interface gigabit0/1
Switch(config-if)# switchport mode access
Switch(config-if)# dot1x port-control auto
Switch(config-if)# dot1x fallback fallback1
Switch(config-if)# end
```

For more information about the `dot1x fallback` command, see the command reference for this release. For more information about the `ip admission name` and `ip access-group` commands, see the [Network Admission Control Software Configuration Guide](#) on Cisco.com.

Configuring a Web Authentication Local Banner



Note

To configure a Web Authentication Local Banner, the switch must be running the LAN base image.

Beginning in privileged EXEC mode, follow these steps to configure a local banner on a switch that has web authentication configured.

	Command	Purpose
Step 1	configure terminal	Enter global configuration mode.
Step 2	ip admission auth-proxy-banner http [<i>banner-text</i> <i>file-path</i>]	Enable the local banner. (Optional) Create a custom banner by entering <i>C banner-text C</i> , where <i>C</i> is a delimiting character or <i>file-path</i> indicates a file (for example, a logo or text file) that appears in the banner.
Step 3	end	Return to privileged EXEC mode.

This example shows how to configure a local banner with the custom message *My Switch*:

```
Switch(config) configure terminal
Switch(config)# aaa new-model
Switch(config)# aaa ip auth-proxy auth-proxy-banner C My Switch C
Switch(config) end
```

For more information about the **ip auth-proxy auth-proxy-banner** command, see the “Authentication Proxy Commands” section of the [Cisco IOS Security Command Reference](#) on Cisco.com.

Disabling IEEE 802.1x Authentication on the Port

You can disable IEEE 802.1x authentication on the port by using the **no dot1x pae** interface configuration command.

Beginning in privileged EXEC mode, follow these steps to disable IEEE 802.1x authentication on the port. This procedure is optional.

	Command	Purpose
Step 1	configure terminal	Enter global configuration mode.
Step 2	interface <i>interface-id</i>	Specify the port to be configured, and enter interface configuration mode.
Step 3	no dot1x pae	Disable IEEE 802.1x authentication on the port.
Step 4	end	Return to privileged EXEC mode.
Step 5	show dot1x interface <i>interface-id</i>	Verify your entries.
Step 6	copy running-config startup-config	(Optional) Save your entries in the configuration file.

To configure the port as an IEEE 802.1x port access entity (PAE) authenticator, which enables IEEE 802.1x on the port but does not allow clients connected to the port to be authorized, use the **dot1x pae authenticator** interface configuration command.

This example shows how to disable IEEE 802.1x authentication on the port:

```
Switch(config)# interface gigabitethernet0/1
Switch(config-if)# no dot1x pae authenticator
```

Resetting the IEEE 802.1x Authentication Configuration to the Default Values

Beginning in privileged EXEC mode, follow these steps to reset the IEEE 802.1x authentication configuration to the default values. This procedure is optional.

	Command	Purpose
Step 1	configure terminal	Enter global configuration mode.
Step 2	interface <i>interface-id</i>	Enter interface configuration mode, and specify the port to be configured.
Step 3	dot1x default	Reset the IEEE 802.1x parameters to the default values.
Step 4	end	Return to privileged EXEC mode.
Step 5	show dot1x interface <i>interface-id</i>	Verify your entries.
Step 6	copy running-config startup-config	(Optional) Save your entries in the configuration file.

Displaying IEEE 802.1x Statistics and Status

To display IEEE 802.1x statistics for all ports, use the **show dot1x all statistics** privileged EXEC command. To display IEEE 802.1x statistics for a specific port, use the **show dot1x statistics interface** *interface-id* privileged EXEC command.

To display the IEEE 802.1x administrative and operational status for the switch, use the **show dot1x all [details | statistics | summary]** privileged EXEC command. To display the IEEE 802.1x administrative and operational status for a specific port, use the **show dot1x interface** *interface-id* privileged EXEC command.

For detailed information about the fields in these displays, see the command reference for this release.

