



Configuring Layer 4 - Layer 7 Network Services Integration

This chapter contains the following sections:

- [About VXLAN Layer 4 - Layer 7 Services, on page 1](#)
- [Integrating Layer 3 Firewalls in VXLAN Fabrics, on page 1](#)
- [Firewall as Default Gateway, on page 15](#)
- [Transparent Firewall Insertion, on page 16](#)

About VXLAN Layer 4 - Layer 7 Services

This chapter covers insertion of Layer 4 – Layer 7 network services (firewall, load balancer, and so on) in a VXLAN fabric.

As opposed to traditional 3-tier network topologies, in which L4-L7 services are connected to the switches hosting the default gateway (aggregation/distribution), L4-L7 services in VXLAN fabrics are typically connected to the leaf or border switches, often referred to as *services leafs*.

You can attach a L4-L7 services device to a VXLAN fabric in various ways. This chapter addresses the considerations you must take depending on how the L4-L7 services device is attached and the requirements of the device and the network.

Integrating Layer 3 Firewalls in VXLAN Fabrics

This section provides details on how to integrate a firewall within a VXLAN EVPN fabric. A Layer-3 firewall involves separating different security zones.

When integrating a Layer-3 firewall in a VXLAN EVPN fabric with a distributed Anycast Gateway, each of these zones must correspond to a VRF/tenant on the fabric. The traffic within a tenant is routed by the fabric. Traffic between the tenants is routed by the firewall. This scenario often refers to an inter-tenant or tenant edge firewall.

Consider two zones: an inside zone and an outside zone. This scenario requires a VRF definition on the fabric. You can call the VRFs the inside VRF and the outside VRF. Traffic between subnets within the same VRF is routed on the VXLAN fabric using the distributed gateway. Traffic between VRFs is routed by the firewall where the rules are applied.

Figure 1: Topology Overview with Firewall Attachment

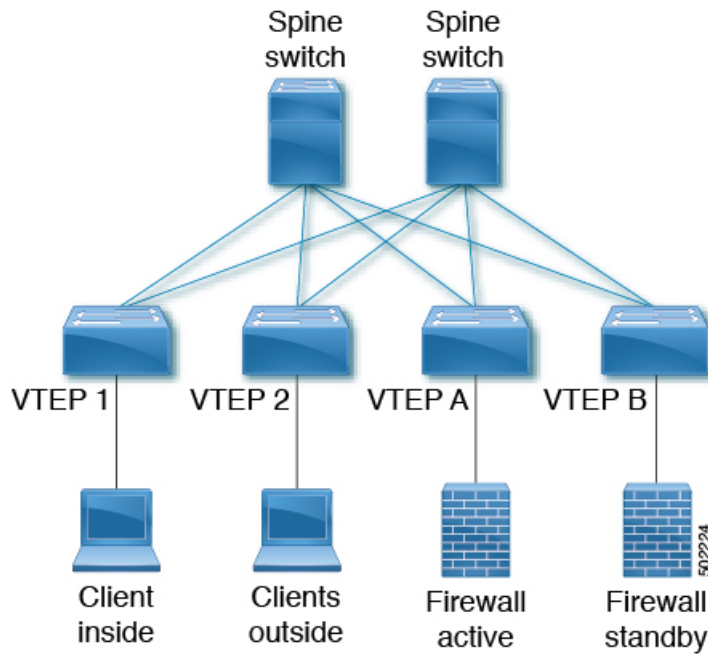

Single-Attached Firewall with Static Routing

If the firewall does not support running a routing protocol, you must have static routes on each VTEP pointing to the firewall as the next hop. The firewall also has static routes pointing to the Anycast Gateway IP as the next hop. The challenge with a static route is that the VTEP with an active firewall must be the one advertising the routes to the fabric. One way to accomplish this is to track the active firewall reachability via HMM and use this tracking to advertise routes into the fabric. When the active firewall is connected to VTEP A, VTEP A has a static route that tracks where the route is advertised if the firewall IP is learned as the HMM route. When the firewall fails and the standby firewall takes over, VTEP A learns the firewall IP using BGP, and VTEP B learns the firewall IP using HMM. VTEP A withdraws the route, and VTEP B advertises the route into the fabric. See the following example.

VTEP A and VTEP B:

```
Vlan 10
  Name inside
  Vn-segment 10010

Vlan 20
  Name outside
  Vn-segment 10020

Interface VLAN 10
  Description inside_vlan
  VRF member INSIDE
  IP address 10.1.1.254/24
  fabric forwarding mode anycast-gateway

Interface VLAN 20
  Description outside_vlan
  VRF member OUTSIDE
```

```

IP address 20.1.1.254/24
fabric forwarding mode anycast-gateway

interface nve1
 no shutdown
 host-reachability protocol bgp
 source-interface loopback1
 member vni 10010
   mcastgroup 239.1.1.1
 member vni 10020
   mcastgroup 239.1.1.1
 member vni 1001000 associate-vrf
 member vni 1002000 associate-vrf

track 10 ip route 10.1.1.1/32 reachability hmm
 vrf member INSIDE
!
VRF context INSIDE
 Vni 1001000
 IP route 20.1.1.0/24 10.1.1.1 track 10

track 20 ip route 20.1.1.1/32 reachability hmm
 vrf member OUTSIDE

!
VRF context OUTSIDE
 Vni 1001000
 IP route 10.1.1.0/24 20.1.1.1 track 20

VTEPA# show track 10 Track 10
IP Route 20.1.1.1/32 Reachability Reachability is UP

VTEPA# show ip route 20.1.1.0/24 vrf INSIDE
IP Route Table for VRF "INSIDE"
 '*' denotes best ucast next-hop
 '**' denotes best mcast next-hop
 '[x/y]' denotes [preference/metric]
 '%<string>' in via output denotes VRF <string>

20.1.1.0/24, ubest/mbest: 1/0
 *via 10.1.1.1 [1/0], 00:00:08, static

Firewall Failure on VTEP A caused the track to go down causing VTEP A to withdraw the static
route.

VTEPA# show track 20 Track 20
IP Route 20.1.1.1/32 Reachability Reachability is DOWN

VTEPA# show ip route 20.1.1.0/24 vrf INSIDE
IP Route Table for VRF "RED"
 '*' denotes best ucast next-hop
 '**' denotes best mcast next-hop
 '[x/y]' denotes [preference/metric]
 '%<string>' in via output denotes VRF <string>

Route not found

```

Recursive Static Routes Distributed to the Rest of the Fabric

With this approach, the static routes are configured wherever the inside or outside VRF exists. As the next-hop is reachable through host routes (EVPN Route-Type2), the change of the active firewall to standby and vice versa is only seen locally and doesn't introduce any churn to the other VXLAN fabric. This approach can help to better scale and improve convergence.

Any VTEP:

```
VRF context OUTSIDE
Vni 1002000
IP route 10.1.1.0/24 20.1.1.1
! static route on VTEP pointing to Firewall next hop
! firewall VIP 20.1.1.1

VRF context INSIDE
Vni 1001000
IP route 20.1.1.0/24 10.1.1.1
! static route on VTEP pointing to Firewall next hop
! firewall VIP 10.1.1.1
```

Redistribute Static Routes into BGP and Advertise to the Rest of the Fabric

Through redistribution, we make the route toward the active firewall shown to the VTEP where it resides. The route is seen as a prefix route (EVPN Route-Type5), and as such, only the route toward the VTEP with the active firewall is seen. In the case of a firewall active/standby change, the tracking needs to detect the change and inform all of the remote VTEPs of this change. This behavior is equal to a route "delete" followed by an "add." This approach needs to notify all VTEPs with the VRF, and hence a wider churn can be seen.

VTEP A and VTEP B:

```
router bgp 65000
vrf OUTSIDE
address-family ipv4 unicast
redistribute static route-map Static-to-BGP
```

Dual-Attached Firewall with Static Routing

Figure 2: Dual-Attached Firewall with Static Routing

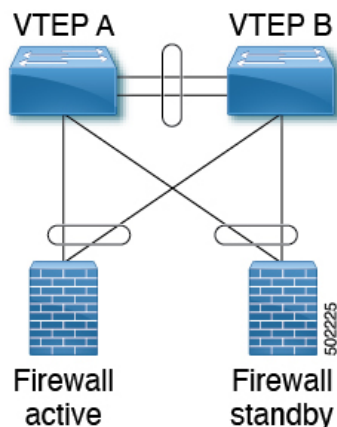

VTEP A and VTEP B:

```

Vlan 10
  Name inside
  Vn-segment 10010

Vlan 20
  Name outside
  Vn-segment 10020

interface nve1
  no shutdown
  host-reachability protocol bgp
  source-interface loopback1
  member vni 10010
    mcastgroup 239.1.1.1
  member vni 10020
    mcastgroup 239.1.1.1
  member vni 1001000 associate-vrf
  member vni 1002000 associate-vrf

Interface VLAN 10
  Description inside_vlan
  VRF member INSIDE
  IP address 10.1.1.254/24
  fabric forwarding mode anycast-gateway

Interface VLAN 20
  Description outside_vlan
  VRF member OUTSIDE
  IP address 20.1.1.254/24
  fabric forwarding mode anycast-gateway

VRF context INSIDE
  Vni 1001000
  IP route 20.1.1.0/24 10.1.1.1
  ! static route on VTEP pointing to Firewall next hop
  ! firewall VIP 10.1.1.1
VRF context OUTSIDE
  Vni 1002000
  IP route 10.1.1.0/24 20.1.1.1
  ! static route on VTEP pointing to Firewall next hop
  ! firewall VIP 20.1.1.1

router bgp 65000
  vrf INSIDE
    address-family ipv4 unicast
      redistribute static route-map INSIDE-to-BGP
  vrf OUTSIDE
    address-family ipv4 unicast
      redistribute static route-map OUTSIDE-to-BGP

```

Single-Attached Firewall with eBGP Routing

If the firewall supports BGP, one option is to use BGP as a protocol between the firewall and the service VTEP. Peering using the anycast IP is not supported. The recommended design is to use dedicated loopback IPs on each VTEP and peer using the loopback. As long as the loopback interfaces are not advertised via

EVPN, the same IP address could be used on all of the belonging VTEPs. We recommend using individual IP addresses on a per-VTEP basis.

Reachability to the loopback from the firewall can be configured using a static route on the firewall, pointing to the Anycast Gateway IP on the VTEPs.

In the following example, an eBGP peering is established from the VTEPs, which are in AS 65000, and the firewall in AS 65002. The BGP peering with iBGP is not supported.



Note When having eBGP peering to active/standby firewalls connected to different VTEPs, **export-gateway-ip** must be enabled.

Do not use Anycast Gateway for BGP peerings.

VTEP A:

```
Vlan 10
  Name inside
  Vn-segment 10010

Vlan 20
  Name outside
  Vn-segment 10020

Interface VLAN 10
  Description inside_vlan
  VRF member INSIDE
  IP address 10.1.1.254/24
  fabric forwarding mode anycast-gateway

Interface loopback100
  Vrf member INSIDE
  Ip address 172.16.1.253/32

Interface VLAN 20
  Description outside_vlan
  VRF member OUTSIDE
  IP address 20.1.1.254/24
  fabric forwarding mode anycast-gateway

Interface loopback101
  Vrf member OUTSIDE
  Ip address 172.18.1.253/32

router bgp 65000
  vrf INSIDE
  ! peer with Firewall Inside
  neighbor 10.1.1.0/24 remote-as 65123
  update-source loopback100
  ebgp-multihop 5
  address-family ipv4 unicast
    local-as 65051 no-prepend replace-as

  vrf OUTSIDE
  ! peer with Firewall Outside
  neighbor 20.1.1.0/24 remote-as 65123
  update-source loopback101
  ebgp-multihop 5
```

```

address-family ipv4 unicast
  local-as 65052 no-prepend replace-as

```

VTEP B:

```

Vlan 10
  Name inside
  Vn-segment 10010

Vlan 20
  Name outside
  Vn-segment 10020
Interface VLAN 10
  Description inside_vlan
  VRF member INSIDE
  IP address 10.1.1.254/24
  fabric forwarding mode anycast-gateway

Interface loopback100
  Vrf member INSIDE
  Ip address 172.16.1.254/32

Interface VLAN 20
  Description outside_vlan
  VRF member OUTSIDE
  IP address 20.1.1.254/24
  fabric forwarding mode anycast-gateway

Interface loopback101
  Vrf member OUTSIDE
  Ip address 172.18.1.254/32

router bgp 65000
  vrf INSIDE
    ! peer with Firewall Inside
    neighbor 10.1.1.0/24 remote-as 65123
    update-source loopback100
    ebgp-multihop 5
    address-family ipv4 unicast
      local-as 65051 no-prepend replace-as

  vrf OUTSIDE
    ! peer with Firewall Outside
    neighbor 20.1.1.0/24 remote-as 65123
    update-source loopback101
    ebgp-multihop 5
    address-family ipv4 unicast
      local-as 65052 no-prepend replace-as

```

With the VXLAN fabric generally being in a single BGP Autonomous System (AS), the AS of the inside VRF and the outside VRF is the same. BGP does not install routes that are received from its own AS. Therefore, we need to adjust the AS-path to override this rule. Various approaches exist, including disabling the rule that BGP drops routes from its own AS, which has further implications to the network. To keep all of the BGP protection mechanics in place, the “local-as” approach allows you to mimic routes being originated from a different AS. We recommend inserting the “local-as #ASN# no-prepend replace-as” on each firewall peering with different “local-as” per VRF.

Figure 3: eBGP AS-Path Check

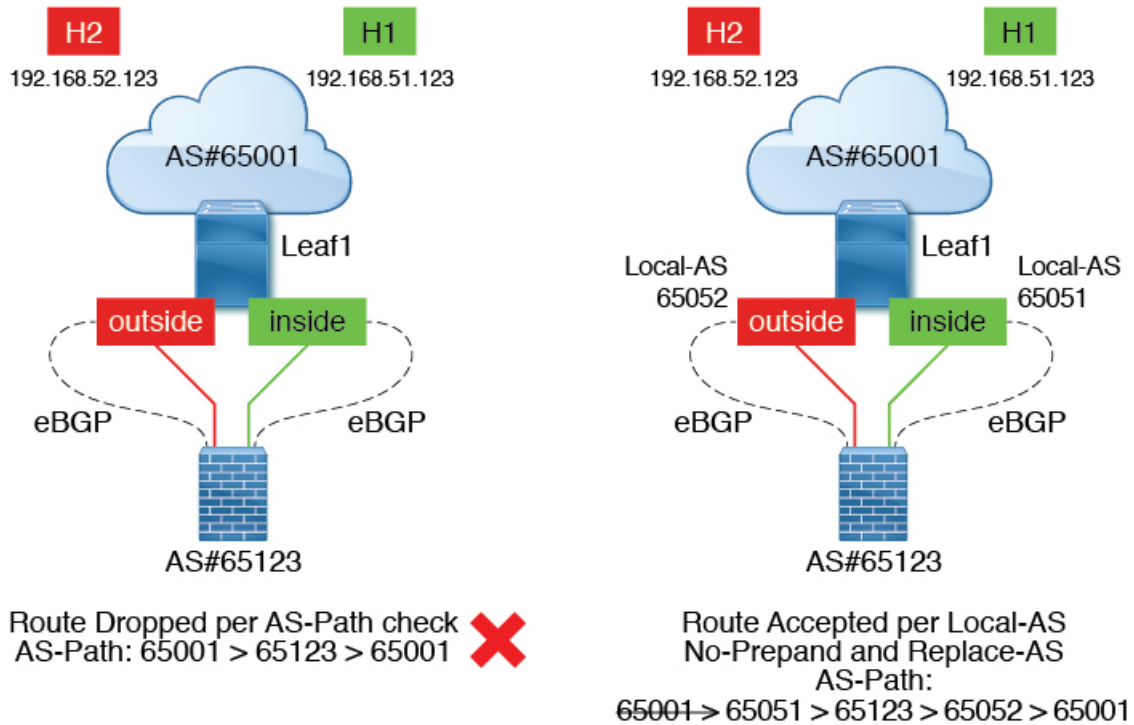

Dual-Attached Firewall with eBGP Routing

If the firewall supports BGP, one option is to use BGP as a protocol between the firewall and the service VTEP. Peering using the anycast IP is not supported. The recommended design is to use dedicated loopback IPs on each VTEP and peer using the loopback. As long as the loopback interfaces are not advertised via EVPN, the same IP address could be used on all of the belonging VTEPs. We recommend using individual IP addresses on a per-VTEP basis. For vPC environments, it is required.

Reachability to the loopback from the firewall can be configured using a static route on the firewall, pointing to the Anycast Gateway IP on the VTEPs.

In vPC deployments, you must have a per-VRF peering via a vPC peer-link. In addition to the per-VRF peering, you can enable the advertisement of prefix routes (EVPN Route-Type 5) using the **advertise-pip** command. For vPC with fabric peering, the per-VRF peering is not necessary, and the advertisement of prefix routes (EVPN Route-Type5) is required.

In the following example, an eBGP peering is established from the VTEPs, which are in AS 65000, and the firewall in AS 65002. The BGP peering with iBGP is not supported.

Figure 4: Dual-Attached Firewall with eBGP

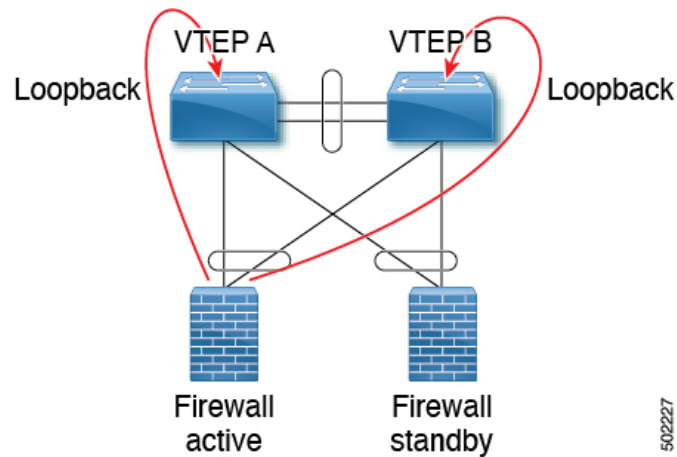

Note When having eBGP peering to active/standby firewalls connected to different VTEPs, **export-gateway-ip** must be enabled.

Do not use Anycast Gateway for BGP peerings.

VTEP A:

```

Vlan 10
  Name inside
  Vn-segment 10010

Vlan 20
  Name outside
  Vn-segment 10020

Interface VLAN 10
  Description inside_vlan
  VRF member INSIDE
  IP address 10.1.1.254/24
  fabric forwarding mode anycast-gateway

Interface loopback100
  Vrf member INSIDE
  Ip address 172.16.1.253/32

Interface VLAN 20
  Description outside_vlan
  VRF member OUTSIDE
  IP address 20.1.1.254/24
  fabric forwarding mode anycast-gateway

Interface loopback101
  Vrf member OUTSIDE
  Ip address 172.18.1.253/32

router bgp 65000
vrf INSIDE
  ! peer with Firewall Inside

```

```

neighbor 10.1.1.0/24 remote-as 65123
update-source loopback100
ebgp-multihop 5
address-family ipv4 unicast
  local-as 65051 no-prepend replace-as

vrf OUTSIDE
  ! peer with Firewall Outside
neighbor 20.1.1.0/24 remote-as 65123
update-source loopback101
ebgp-multihop 5
address-family ipv4 unicast
  local-as 65052 no-prepend replace-as

```

VTEP B:

```

Vlan 10
  Name inside
  Vn-segment 10010

Vlan 20
  Name outside
  Vn-segment 10020

Interface VLAN 10
  Description inside_vlan
  VRF member INSIDE
  IP address 10.1.1.254/24
  fabric forwarding mode anycast-gateway

Interface loopback100
  Vrf member INSIDE
  Ip address 172.16.1.254/32

Interface VLAN 20
  Description outside_vlan
  VRF member OUTSIDE
  IP address 20.1.1.254/24
  fabric forwarding mode anycast-gateway

Interface loopback101
  Vrf member OUTSIDE
  Ip address 172.18.1.254/32

router bgp 65000
  vrf INSIDE
  ! peer with Firewall Inside
  neighbor 10.1.1.0/24 remote-as 65123
  update-source loopback100
  ebgp-multihop 5
  address-family ipv4 unicast
    local-as 65051 no-prepend replace-as

  vrf OUTSIDE
  ! peer with Firewall Outside
  neighbor 20.1.1.0/24 remote-as 65123
  update-source loopback101
  ebgp-multihop 5
  address-family ipv4 unicast
    local-as 65052 no-prepend replace-as

```

Per-VRF Peering via vPC Peer-Link

VTEP A and VTEP B:

```

vlan 3966
! vlan use for peering between the vPC VTEPS

vlan 3967
! vlan use for peering between the vPC VTEPS

system nve infra-vlans 3966,3967

interface vlan 3966
vrf member INSIDE
ip address 100.1.1.1/31

interface vlan 3967
vrf member OUTSIDE
ip address 100.1.2.1/31

router bgp 65000
vrf INSIDE
neighbor 100.1.1.0 remote-as 65000
update-source vlan 3966
next-hop self
address-family ipv4 unicast

vrf OUTSIDE
neighbor 100.1.2.0 remote-as 65000
update-source vlan 3967
next-hop self
address-family ipv4 unicast

```

The routes learned in each VRF are advertised to the rest of the fabric via BGP EVPN updates.

Single-Attached Firewall with OSPF

The following example shows a configuration snippet from VTEP A running OSPF peering with the firewall. SVIs are defined on the VTEP for both inside and outside VRFs. The VTEP peers with the firewall on each of these VRFs dynamically learn routing information to go from one VRF to the other.

VTEP A and VTEP B:

```

vlan 10
name inside
vn-segment 10010

vlan 20
name outside
vn-segment 10020

interface VLAN 10
Description inside_vlan
VRF member INSIDE
IP address 10.1.1.254/24
IP router ospf 1 area 0
fabric forwarding mode anycast-gateway

Interface VLAN 20
Description outside_vlan
VRF member OUTSIDE

```

```

IP address 20.1.1.254/24
IP router ospf 1 area 0
fabric forwarding mode anycast-gateway

interface nve1
no shutdown
host-reachability protocol bgp
source-interface loopback1
member vni 10010
  mcastgroup 239.1.1.1
member vni 10020
  mcastgroup 239.1.1.1
member vni 1001000 associate-vrf
member vni 1002000 associate-vrf

router ospf 1
router-id 192.168.1.1
vrf INSIDE
VRF OUTSIDE

VTEPA# show ip route ospf-1 vrf OUTSIDE
IP Route Table for VRF "OUTSIDE"
'*' denotes best ucast next-hop
'***' denotes best mcast next-hop
'[x/y]' denotes [preference/metric]
'%<string>' in via output denotes VRF <string>

10.1.1.0/24, ubest/mbest: 1/0
  *via 20.1.1.1 Vlan20, [110/41], 1w5d, ospf-1, intra

VTEPA# show ip route ospf-1 vrf INSIDE
IP Route Table for VRF "INSIDE"
'*' denotes best ucast next-hop
'***' denotes best mcast next-hop
'[x/y]' denotes [preference/metric]
'%<string>' in via output denotes VRF <string>

20.1.1.0/24, ubest/mbest: 1/0
  *via 10.1.1.1 Vlan10, [110/41], 1w5d, ospf-1, intra

```

This route is then redistributed into BGP and advertised through the EVPN fabric so that all other VTEPs have all routes in each VRF pointing to VTEP A as the next hop.

Redistribute OSPF Routes into BGP and Advertise to the Rest of the Fabric

VTEP A and VTEP B:

```

router bgp 65000
vrf OUTSIDE
  address-family ipv4 unicast
    redistribute ospf 1 route-map OUTSIDEOSPF-to-BGP
vrf INSIDE
  address-family ipv4 unicast
    redistribute ospf 1 route-map INSIDEOSPF-to-BGP

VTEPA# show ip route 10.1.1.0/24 vrf OUTSIDE

10.1.1.0/24 ubest/mbest: 1/0
  *via 10.1.1.18%default, [200/41], 1w1d, bgp-65000, internal, tag 65000 (evpn) segid:
200100 tunnelid: 0xa010112 encap: VXLAN

```

Traffic is VXLAN encapsulated from VTEP to services VTEP and decapsulated and sent to the firewall. The firewall enforces the rules and sends the traffic to the services VTEP on the inside VRF. This traffic is then VXLAN encapsulated and sent to the destination VTEP where traffic is decapsulated and sent to the end client.

Firewall Failover

When the active firewall fails and the standby firewall takes over, routes are withdrawn from service VTEP A and advertised to the fabric by service VTEP B.

Dual-Attached Firewall with OSPF

Cisco NX-OS supports dynamic OSPF peering over vPC using Layer 3, which enables firewall connectivity using vPC and establishes OSPF peering over this link. The VLAN used to establish peering between the Cisco Nexus 9000 switches and the firewall must be a non-VXLAN-enabled VLAN.

Figure 5: Dual-Attached Firewall with OSPF

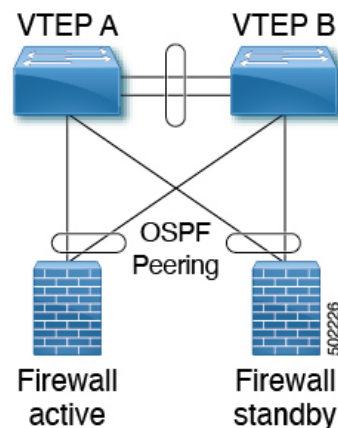

Note Do not use Anycast Gateway for OSPF adjacencies.

VTEP A:

```
Vlan 10
  Name inside

Vlan 20
  Name outside

Interface VLAN 10
  Description inside_vlan
  VRF member INSIDE
  IP address 10.1.1.253/24
  Ip router ospf 1 area 0

Interface VLAN 20
  Description outside_vlan
  VRF member OUTSIDE
  IP address 20.1.1.253/24
  Ip router ospf 1 area 0
```

```
vpc domain 100
 layer3 peer-router
 peer-gateway
 peer-switch
 peer-keepalive destination x.x.x.x source x.x.x.x peer-gateway
 ipv6 nd synchronize
 ip arp synchronize

router ospf 1
 vrf INSIDE VRF OUTSIDE
```

VTEP B:

```
Vlan 10
 Name inside
```

```
Vlan 20
 Name outside
```

```
Interface VLAN 10
 Description inside_vlan
 VRF member INSIDE
 IP address 10.1.1.254/24
 Ip router ospf 1 area 0
```

```
Interface VLAN 20
 Description outside_vlan
 VRF member OUTSIDE
 IP address 20.1.1.254/24
 Ip router ospf 1 area 0
```

```
vpc domain 100
 layer3 peer-router
 peer-gateway
 peer-switch
 peer-keepalive destination x.x.x.x source x.x.x.x peer-gateway
 ipv6 nd synchronize
 ip arp synchronize

router ospf 1
 vrf INSIDE VRF OUTSIDE
```

```
VTEPA# show ip route ospf-1 vrf OUTSIDE
IP Route Table for VRF "OUTSIDE"
 '*' denotes best ucast next-hop
 '**' denotes best mcast next-hop
 '[x/y]' denotes [preference/metric]
 '%<string>' in via output denotes VRF <string>
```

```
10.1.1.0/24, ubest/mbest: 1/0
 *via 20.1.1.1 Vlan20, [110/41], 1w5d, ospf-1, intra
```

```
VTEPA# show ip route ospf-1 vrf INSIDE
IP Route Table for VRF "INSIDE"
 '*' denotes best ucast next-hop
 '**' denotes best mcast next-hop
 '[x/y]' denotes [preference/metric]
 '%<string>' in via output denotes VRF <string>
```

```
20.1.1.0/24, ubest/mbest: 1/0
 *via 10.1.1.1 Vlan10, [110/41], 1w5d, ospf-1, intra
```

Redistribute OSPF Routes into BGP and Advertise to the Rest of the Fabric

VTEP A and VTEP B:

```
router bgp 65000
vrf OUTSIDE
  address-family ipv4 unicast
    redistribute ospf 1 route-map OUTSIDEOSPF-to-BGP
vrf INSIDE
  address-family ipv4 unicast
    redistribute ospf 1 route-map INSIDEOSPF-to-BGP
```

Firewall as Default Gateway

In this deployment model, the VXLAN fabric is a Layer 2 fabric, and the default gateway resides on the firewall.

For example:

```
vlan 10
  name WEB
  vn-segment 10010
vlan 20
  name APPLICATION
  vn-segment 10020
vlan 30
  name DATABASE
  vn-segment 10030

interface nve1
  no shutdown
  host-reachability protocol bgp
  source-interface loopback1
  member vni 10010
    mcastgroup 239.1.1.1
  member vni 10020
    mcastgroup 239.1.1.1
  member vni 10030
    mcastgroup 239.1.1.1
```

The firewall has a logical interface in each VNI and is the default gateway for all endpoints. Every inter-VNI communication flows through the firewall. Take special care with the sizing of the firewall so that it does not become a bottleneck. Therefore, use this design in environments with low-bandwidth requirements.

Figure 6: Firewall as Default Gateway with a Layer-2 VXLAN Fabric

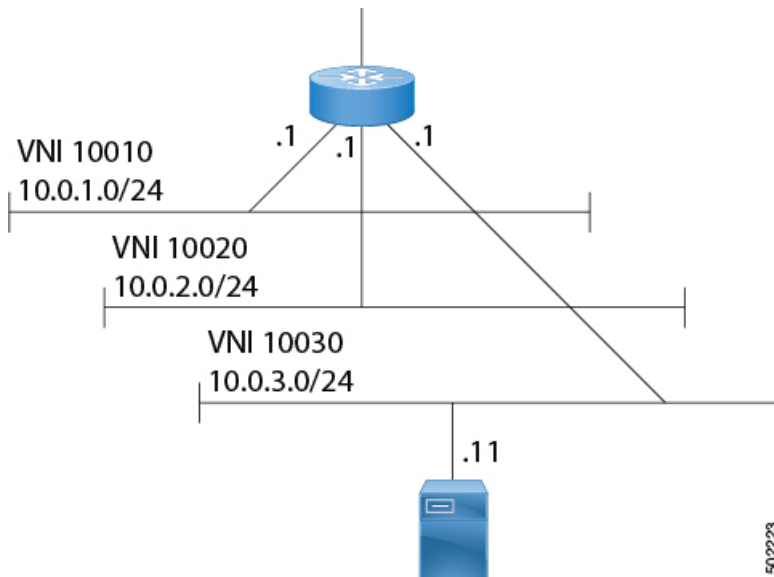

Transparent Firewall Insertion

Transparent firewalls or Layer 2 firewalls (including IPS/IDS) typically bridge between an inside VLAN and outside VLAN and inspect traffic as it traverses through them. VLAN stitching is done by placing the default gateway for the service on the inside VLAN. The Layer 2 reachability to this gateway is done on the outside VLAN.

Overview of EVPN with Transparent Firewall Insertion

The topology contains the following types of VLANs:

- Internal VLAN (a regular VXLAN on ToR leafs with Anycast Gateway)
- Firewall untrusted VLAN X
- Firewall trusted VLAN Y

In this topology, the traffic that goes from VLAN X to other VLANs must go through a transparent Layer 2 firewall that is attached to the service leafs. This topology utilizes an approach of an untrusted VLAN X and a trusted VLAN Y. All ToR leafs have a Layer 2 VNI VLAN X. There is no SVI for VLAN X. The service leafs that are connected to the firewall have Layer 2 VNI VLAN X, non-VXLAN VLAN Y, and SVI Y with an HSRP gateway.

Overview of EVPN with Transparent Firewall Insertion

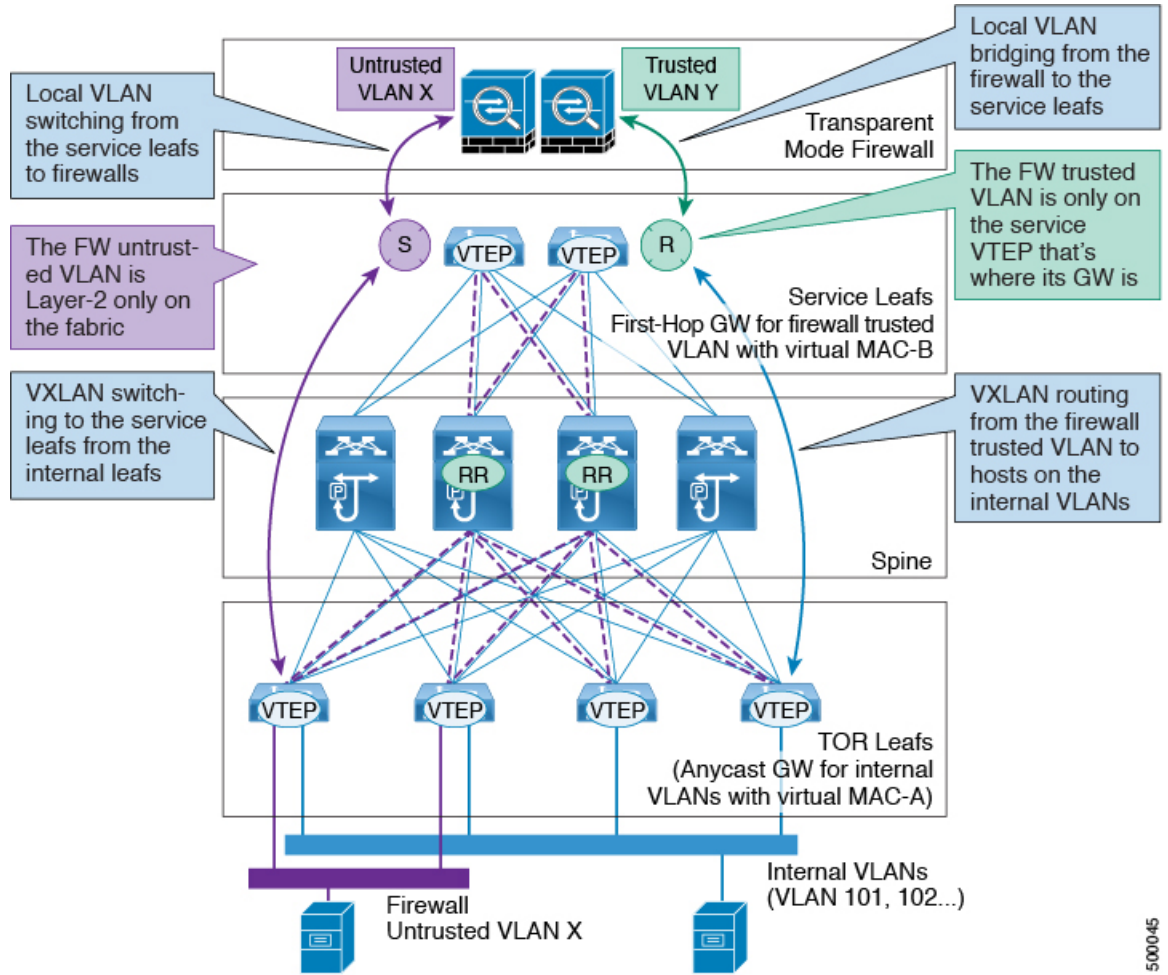

500045



Note For VXLAN EVPN, we recommend using the distributed Anycast Gateway with transparent firewall insertion. Doing so allows all VLANs to be VXLAN enabled. When using an HSRP/VRRP-based First-Hop Gateway, the VLAN for the SVI can't be VXLAN enabled and should reside on a vPC pair for redundancy.

EVPN with Transparent Firewall Insertion Example

Example of EVPN with Transparent Firewall Insertion

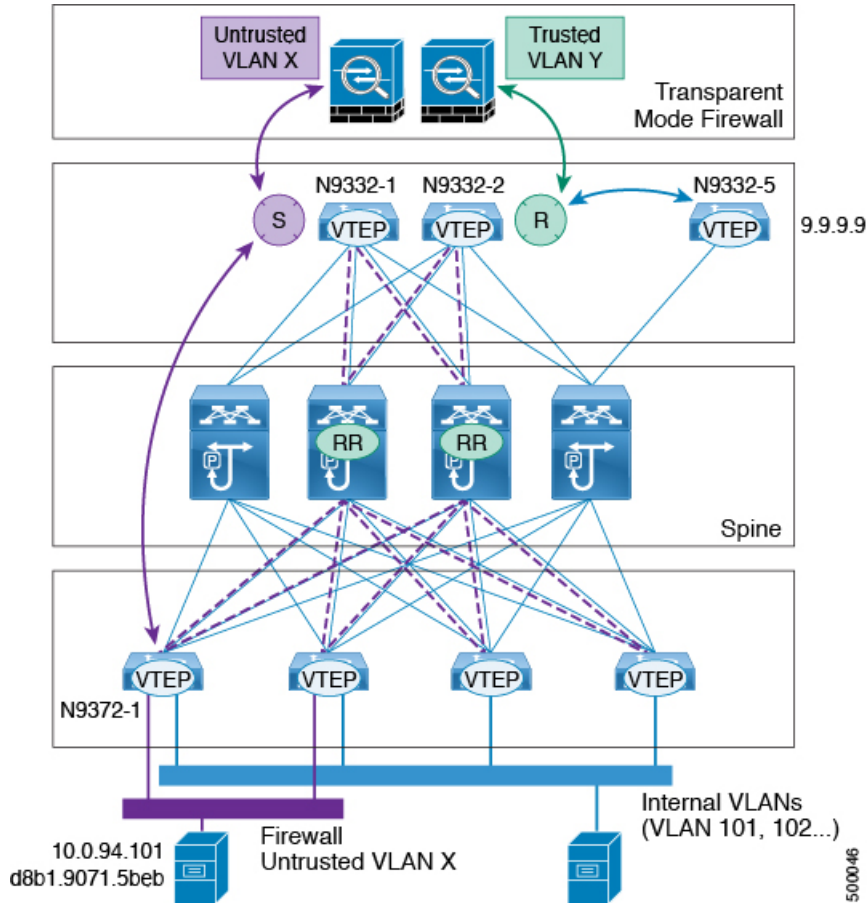

- Host in VLAN X: 10.1.94.101
- ToR leaf: N9372-1
- Service leaf in vPC: N9332-1 and N9332-2
- Border leaf: N9332-5

ToR Leaf Configuration

```

vlan 94
vn-segment 100094

interface nve1
 member vni 100094
 mcastgroup 239.1.1.1

router bgp 64500
 routerid 1.1.2.1
 neighbor 1.1.1.1 remote-as 64500
 address-family l2vpn evpn
 send-community extended
  
```

```

neighbor 1.1.1.2 remote-as 64500
address-family l2vpn evpn
  send-community extended
vrf Ten1
  address-family ipv4 unicast
  advertise l2vpn evpn

evpn
vni 100094 l2
  rd auto
  route-target import auto
  route-target export auto

```

Service Leaf 1 Configuration Using HSRP

```

vlan 94
description untrusted_vlan
  vn-segment 100094

vlan 95
  description trusted_vlan

vpc domain 10
  peer-switch
  peer-keepalive destination 10.1.59.160
  peer-gateway
  auto-recovery
  ip arp synchronize

interface Vlan2
description vpc_backup_svi_for_overlay
  no shutdown
  no ip redirects
  ip address 10.10.60.17/30
  no ipv6 redirects
  ip router ospf 100 area 0.0.0.0
  ip ospf bfd
  ip pim sparsemode

interface Vlan95
description SVI_for_trusted_vlan
  no shutdown
  mtu 9216
  vrf member Ten-1
  no ip redirects
  ip address 10.0.94.2/24
  hsrp 0
  preempt priority 255
  ip 10.0.94.1

interface nve1
  member vni 100094
  mcast-group 239.1.1.1

router bgp 64500
  routerid 1.1.2.1
  neighbor 1.1.1.1 remote-as 64500
  address-family l2vpn evpn
  send-community extended
  neighbor 1.1.1.2 remote-as 64500
  address-family l2vpn evpn
  send-community extended
vrf Ten-1
  address-family ipv4 unicast

```

```

network 10.0.94.0/24 /*advertise /24 for SVI 95 subnet; it is not VXLAN anymore*/
advertise l2vpn evpn

```

```

evpn
vni 100094 l2
rd auto
route-target import auto
route-target export auto

```

Service Leaf 2 Configuration Using HSRP

```

vlan 94
description untrusted_vlan
vnsegment 100094

vlan 95
description trusted_vlan

vpc domain 10
peer-switch
peer-keepalive destination 10.1.59.159
peer-gateway
auto-recovery
ip arp synchronize

interface Vlan2
description vpc_backup_svi_for_overlay
no shutdown
no ip redirects
ip address 10.10.60.18/30
no ipv6 redirects
ip router ospf 100 area 0.0.0.0
ip pim sparsemode

interface Vlan95
description SVI_for_trusted_vlan
no shutdown
mtu 9216
vrf member Ten-1
no ip redirects
ip address 10.0.94.3/24
hsrp 0
preempt priority 255
ip 10.0.94.1

interface nve1
member vni 100094
mcastgroup 239.1.1.1

router bgp 64500
router-id 1.1.2.1
neighbor 1.1.1.1 remote-as 64500
address-family l2vpn evpn
send-community extended
neighbor 1.1.1.2 remote-as 64500
address-family l2vpn evpn
send-community extended
vrf Ten-1
address-family ipv4 unicast
network 10.0.94.0/24 /*advertise /24 for SVI 95 subnet; it is not VXLAN anymore*/
advertise l2vpn evpn

evpn
vni 100094 l2

```

```
rd auto
route-target import auto
route-target export auto
```

Show Command Examples

Display information about the ingress leaf learned local MAC from host:

```
switch# sh mac add vl 94 | i 5b|MAC
* primary entry, G - Gateway MAC, (R) Routed - MAC, O - Overlay MAC
VLAN MAC Address Type age Secure NTFY Ports
* 94 d8b1.9071.5beb dynamic 0 F F Eth1/1
```

Display information about the service leaf found MAC of host:



Note In VLAN 94, the service leaf learned the host MAC from the remote peer by BGP.

```
switch# sh mac add vl 94 | i VLAN|eb

VLAN MAC Address Type age Secure NTFY Ports
* 94 d8b1.9071.5beb dynamic 0 F F nvel(1.1.2.1)

switch# sh mac add vl 94 | i VLAN|eb

VLAN MAC Address Type age Secure NTFY Ports
* 94 d8b1.9071.5beb dynamic 0 F F nvel(1.1.2.1)

switch# sh mac add vl 95 | i VLAN|eb

VLAN MAC Address Type age Secure NTFY Ports
+ 95 d8b1.9071.5beb dynamic 0 F F Po300

switch# sh mac add vl 95 | i VLAN|eb

VLAN MAC Address Type age Secure NTFY Ports
+ 95 d8b1.9071.5beb dynamic 0 F F Po300
```

Display information about service leaf learned ARP for host on VLAN 95:

```
switch# sh ip arp vrf ten-1
Address      Age      MAC Address      Interface
10.0.94.101 00:00:26 d8b1.9071.5beb  Vlan95
```

Service Leaf learns 9.9.9.9 from EVPN.

```
switch# sh ip route vrf ten-1 9.9.9.9
IP Route Table for VRF "Ten-1"
'*' denotes best ucast nexthop
'**' denotes best mcast nexthop
'[x/y]' denotes [preference/metric]
'%<string>' in via output denotes VRF <string>

9.9.9.9/32, ubest/mbest: 1/0
 *via 1.1.2.7%default, [200/0], 02:57:27, bgp64500,internal, tag 65000 (evpn) segid: 10011
tunnelid: 0x1
010207 encap: VXLAN
```

Display information about the border leaf learned host routes by BGP:

```
switch# sh ip route 10.0.94.101

IP Route Table for VRF "default"
'*' denotes best ucast nexthop
 '**' denotes best mcast nexthop
 '[x/y]' denotes [preference/metric]
 '%<string>' in via output denotes VRF <string>

10.0.94.0/24, ubest/mbest: 1/0
  *via 10.100.5.0, [20/0], 03:14:27, bgp65000,external, tag 6450
```