



## **Cisco Nexus 9364E-SG2 (N9364E-SG2-0) NX-OS-Mode Hardware Installation Guide**

**First Published:** 2025-01-20

**Last Modified:** 2025-04-17

### **Americas Headquarters**

Cisco Systems, Inc.  
170 West Tasman Drive  
San Jose, CA 95134-1706  
USA  
<http://www.cisco.com>  
Tel: 408 526-4000  
800 553-NETS (6387)  
Fax: 408 527-0883





## CONTENTS

---

### CHAPTER 1

#### Overview 1

Overview 1

---

### CHAPTER 2

#### Preparing the Site 5

Temperature Requirements 5

Humidity Requirements 6

Altitude Requirements 6

Dust and Particulate Requirements 7

Minimizing Electromagnetic and Radio Frequency Interference 7

Shock and Vibration Requirements 8

Preventing Electrostatic Discharge Damage 8

Grounding Requirements 8

Planning for Power Requirements 9

Airflow Requirements 9

Rack and Cabinet Requirements 10

Clearance Requirements 10

Network Equipment-Building System (NEBS) Statements 12

---

### CHAPTER 3

#### Installing the Chassis 17

Safety 17

Installation Options with Rack-Mount Kits 21

Install a Rack 21

Unpacking and Inspecting a New Switch 22

Procure Tools and Equipment 22

Switch Accessory Kit 23

Planning How to Position the Chassis in the Rack 23

Installing the Chassis in a Four-Post Rack 23  
 Rack-Mount the Chassis in a 4-Post Rack 24  
 Grounding the Chassis 27  
 Starting the Switch 28

---

**CHAPTER 4**      **Connecting the Switch to the Network 31**  
 Overview of Network Connections 31  
 Connecting a Console to the Switch 32  
 Creating the Initial Switch Configuration 33  
 Setting Up the Management Interface 34  
 Connecting Interface Ports to Other Devices 35  
 Maintaining Transceivers and Optical Cables 35

---

**CHAPTER 5**      **Replacing Components 37**  
 Replacing a Fan Module During Operations 37  
 Replacing a Power Supply Module 38  
     Removing an AC Power Supply 38  
     Installing an HVAC/HVDC Power Supply 39  
 Installing and Removing Small-Form Pluggable Modules 40  
 Install and Remove OSFP/QSFP Transceiver Modules 41  
 Attaching the Optical Network Cable 44  
 Removing the Transceiver Module 45

---

**APPENDIX A**      **Rack Specifications 47**  
 Overview of Racks 47  
 General Requirements for Cabinets and Racks 47  
 Requirements Specific to Standard Open Racks 48  
 Requirements Specific to Perforated Cabinets 48  
 Cable Management Guidelines 49

---

**APPENDIX B**      **System Specifications 51**  
 Environmental Specifications 51  
 Switch Dimensions 52  
 Switch and Module Weights and Quantities 52

Transceiver and Cable Specifications	52
Switch Power Input Requirements	52
Power Specifications	53
3000-W AC Power Supply Specifications	53
Power Cable Specifications	53
Power Cable Specifications for AC Power Supplies	53
HVAC/HVDC Power Cables	54
Regulatory Standards Compliance Specifications	55

---

**APPENDIX C**

<b>LEDs</b>	<b>57</b>
Switch Chassis LEDs	57
Uplink Module LEDs	58
Fan Module LEDs	58
Power Supply LEDs	59





# CHAPTER 1

## Overview

- [Overview, on page 1](#)

## Overview

The Cisco Nexus 9364E-SG2-O switch (N9364E-SG2-O) is a 2-rack unit (RU), fixed-port, high-density switch designed to support high-density 800G fabrics for next generation leaf and spine designs. This switch contains Cisco Silicon One G200 which focuses specifically on enhanced Ethernet-based artificial intelligence/machine learning AI/ML and web-scale spine deployments. It is a 5 nm, 51.2 TeraBits per second (Tbps), 512 X 112 Gbps serializer-deserializer (SerDes) switch. This switch has these ports and capabilities:

- 64 OSFP (octal small form-factor pluggable) ports that provide high-speed interface connection to networking equipment
- 1 QSFP28 (quad small form-factor pluggable) Punt Injection Engine (PIE) port

**Figure 1: Cisco Nexus 9364E-SG2-O Switch**

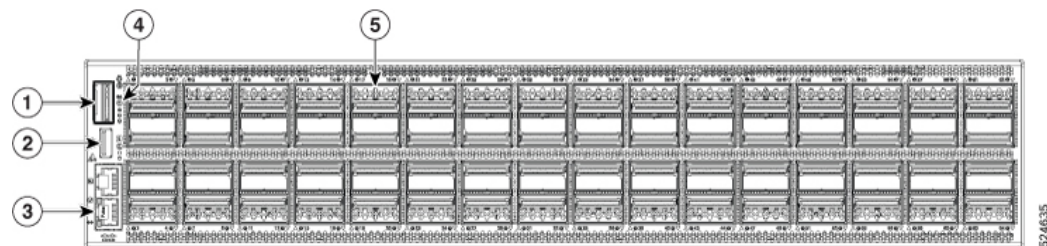

1	PIE port (QSFP28)	4	Chassis LEDs
2	USB 3.0 port, Type A	5	OSFP800 data ports (64)
3	RJ45 ports (2): 1 Console + 1G Management port		

Each OSFP port has its own bi-color (amber or green) LED that can be used to display the link status indication. For port LED status information, see [Switch Chassis LEDs](#).

The G200 NPU (neural processing unit) and all 64 OSFP ports connect directly to the NPU. The maximum power provided to each OSFP port is 20W per instance.

Figure 2: Cisco Nexus 9364E-SG2-0—Rear View

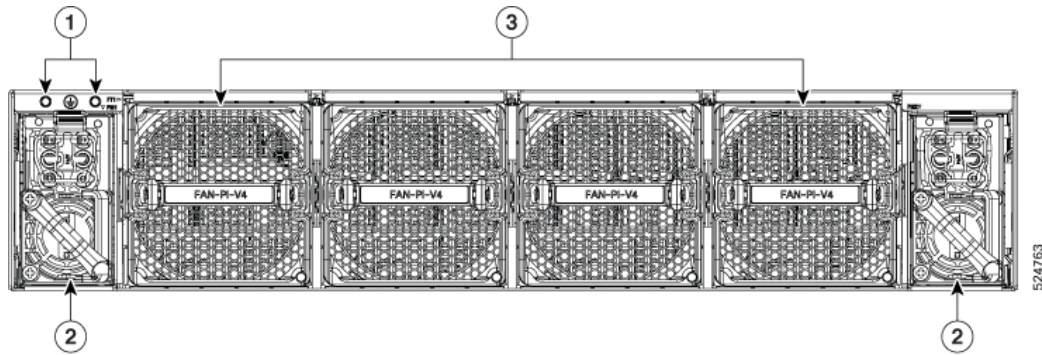

1	Ground lug location
2	Power supply (PSU-1 and PSU-2)
3	Fan Tray Four Fans: FT1, FT2, FT3, FT4

**This switch includes these user-replaceable components:**

Fan modules (four) with one airflow choice: Port-side intake fan module (FAN-PI-V4)



**Note** The switch functions normally when only one fan tray fails. If more than one fan tray fails, the switch issues a warning and powers down within two minutes unless you take corrective actions to replace the failed fan trays.

The switch has four, latched fan modules that install into the chassis from the rear. Fans cool the system and maintain proper airflow through the system. The fan modules work with N+1 redundancy.

Power supply modules (two—one for operations and one for redundancy [1+1]). The power supply module can be AC type ONLY. The option is: 3kW AC, PSU3KW-HVPI.



**Note**

- All the fan modules and power supplies must use the same airflow direction. For this switch, the air flow direction is front-to-back.

The figure shows the switch on the port side of the chassis.



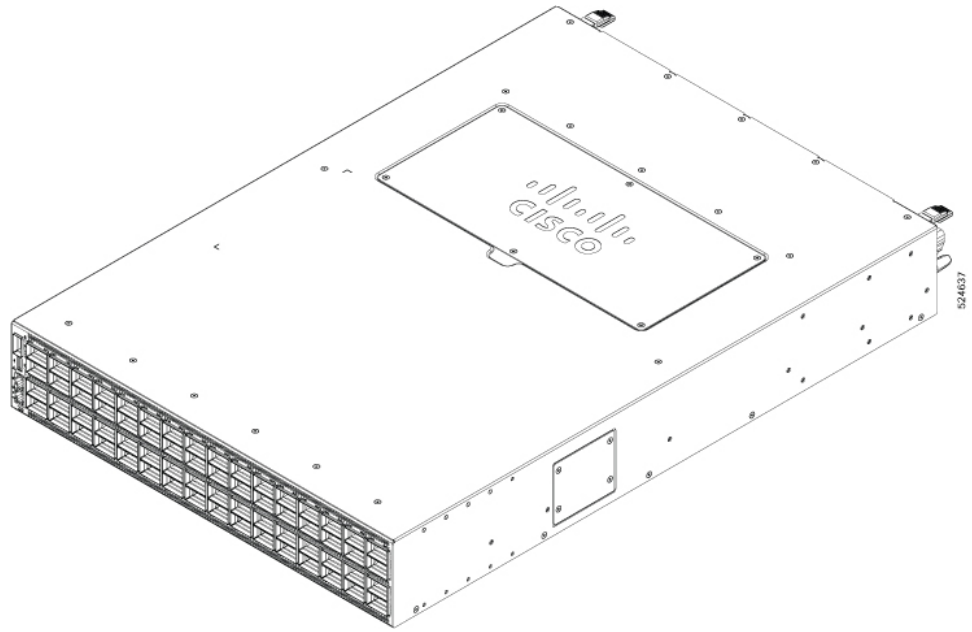





## CHAPTER 2

# Preparing the Site

---

- [Temperature Requirements, on page 5](#)
- [Humidity Requirements, on page 6](#)
- [Altitude Requirements, on page 6](#)
- [Dust and Particulate Requirements, on page 7](#)
- [Minimizing Electromagnetic and Radio Frequency Interference, on page 7](#)
- [Shock and Vibration Requirements, on page 8](#)
- [Preventing Electrostatic Discharge Damage, on page 8](#)
- [Grounding Requirements, on page 8](#)
- [Planning for Power Requirements, on page 9](#)
- [Airflow Requirements, on page 9](#)
- [Rack and Cabinet Requirements, on page 10](#)
- [Clearance Requirements, on page 10](#)
- [Network Equipment-Building System \(NEBS\) Statements, on page 12](#)

## Temperature Requirements

The operating temperature of the switch is 32 to 104 degrees Fahrenheit (0 to 40 degrees Celsius) at sea level. For every 300 meters (1000 feet) above sea level, the maximum temperature is reduced by 1 degree Celsius. The non-operating temperature of the switch is -40 to 158 degrees Fahrenheit (-40 to 70 degrees Celsius).

### Overview of Module Temperatures

Built-in, automatic sensors in all switches in the Cisco Nexus 9000 Series monitor your switch at all times. Each module (supervisor, I/O, and fabric) has temperature sensors with two thresholds:



---

**Note** For any Major temperature alarms from the sensors, the switch powers down in 2 minutes. Power on the switch after fixing the temperature issue.

---

- Minor temperature threshold—If exceeded, a minor alarm occurs and these actions happen for all four sensors:
  - System messages display.
  - System sends Call Home alerts (if configured).

- System sends SNMP notifications (if configured).
  - System fan speed will increment.
- Major temperature threshold—If exceeded, a major alarm occurs and these actions happen:  
If the threshold is exceeded in a switching module, only that module is shut down.  
For all sensors:
    - System messages display.
    - System sends Call Home alerts (if configured).
    - System sends SNMP notifications (if configured).
    - System fan speed will increment.
    - If the major threshold is exceeded in a switching module, only that module is shut down.
    - If the major threshold is exceeded in an active supervisor module with HA-standby or standby present, only that supervisor module is shut down and the standby supervisor module takes over.
    - If you do not have a standby supervisor module in your switch, you have 2 minutes to decrease the temperature. For Cisco Nexus 9364E-SG2 switches, there is no standby SUP. For any major alarms, the switch powers down in 2 minutes. During this interval, the software monitors the temperature every 5 seconds and continuously sends system messages every 10 seconds, as configured.

## Humidity Requirements

High humidity can cause moisture to enter the switch. Moisture can cause corrosion of internal components and degradation of properties such as electrical resistance, thermal conductivity, physical strength, and size. The switch is rated to withstand from 5- to 95-percent (nonoperating) and 5- to 90-percent (operating) relative humidity.

Climate-controlled buildings usually maintain an acceptable level of humidity for the switch equipment. If the switch is located in an unusually humid location, use a dehumidifier to maintain the humidity within an acceptable range.

This switch operates at 5- to 90-percent non-condensing relative humidity.

## Altitude Requirements

Altitude rating is 10,000 ft (3048 m). For China, it is 6,562 ft (2000 m).

For every 1000 feet (300 meters) of elevation, the maximum ambient temperature is reduced by one degree Celsius.

## Dust and Particulate Requirements

Exhaust fans cool power supplies. System fans cool switches by drawing in air and exhausting air out through various openings in the chassis. Fans also introduce dust and other particles, causing contaminant buildup in the switch and increased internal chassis temperature. Dust and particles can act as insulators and interfere with the mechanical components in the switch. Keep a clean operating environment to reduce the negative effects of dust and other particles.

In addition to keeping your environment free of dust and particles, use these precautions to avoid contamination of your switch:

- Do not smoke near the switch.
- Do not eat or drink near the switch.

## Minimizing Electromagnetic and Radio Frequency Interference

Electromagnetic interference (EMI) and radio frequency interference (RFI) from the switch can adversely affect other devices, such as radio and television (TV) receivers. Radio frequencies that emanate from the switch can also interfere with cordless and low-power telephones. Conversely, RFI from high-power telephones can cause spurious characters to appear on the switch monitor.

RFI is defined as any EMI with a frequency above 10 kHz. This type of interference can travel from the switch to other devices through the power cable and power source or through the air as transmitted radio waves. The Federal Communications Commission (FCC) publishes specific regulations to limit the amount of EMI and RFI that are emitted by computing equipment. Each switch meets these FCC regulations.

To reduce the possibility of EMI and RFI, use these guidelines:

- Cover all open expansion slots with a blank filler plate.
- Always use shielded cables with metal connector shells for attaching peripherals to the switch.

When wires are run for any significant distance in an electromagnetic field, interference can occur to the signals on the wires with these implications:

- Bad wiring can result in radio interference emanating from the plant wiring.
- Strong EMI, especially when it is caused by lightning or radio transmitters, can destroy the signal drivers and receivers in the chassis and even create an electrical hazard by conducting power surges through lines into equipment.



---

**Note** To predict and prevent strong EMI, consult experts in radio frequency interference (RFI).

---

The wiring is unlikely to emit radio interference if you use a twisted-pair cable with a good distribution of grounding conductors. Copper cables should not be longer than maximum distances for the media type.

**Caution**

If the wires exceed the recommended distances, or if wires pass between buildings, give special consideration to the effect of a lightning strike in your vicinity. The electromagnetic pulse that is caused by lightning or other high-energy phenomena can easily couple enough energy into unshielded conductors to destroy electronic switches. Consult experts in electrical surge suppression and shielding if you have had similar problems in the past.

## Shock and Vibration Requirements

The switch has been shock- and vibration-tested for operating ranges, handling, and earthquake standards.

## Preventing Electrostatic Discharge Damage

Many switch components can be damaged by static electricity. Not exercising the proper electrostatic discharge (ESD) precautions can result in intermittent or complete component failures. To minimize the potential for ESD damage, always use an ESD-preventive anti-static wrist strap (or ankle strap) and ensure that it makes adequate skin contact.

**Note**

Check the resistance value of the ESD-preventive strap periodically. The measurement should be 1–10 megohms. Before you perform any of the procedures in this guide, attach an ESD-preventive strap to your wrist and connect the leash to the chassis.

## Grounding Requirements

The switch is sensitive to variations in voltage that is supplied by the power sources. Overvoltage, undervoltage, and transients (spikes) can erase data from memory or cause components to fail. To protect against these types of problems, ensure that there is an earth-ground connection for the switch.

Connect the grounding pad on the switch either directly to the earth-ground connection or to a fully bonded and grounded rack.

When the chassis is properly installed in a grounded rack, the switch is grounded because it has a metal-to-metal (no paint, stain, dirt, or anything else on it) contact to the rack. See Note to ensure proper conductivity between rack and switch is maintained.

Alternatively, ground the chassis by using a customer-supplied grounding cable that meets your local and national installation requirements. For U.S. installations, we recommend 6-AWG wire. Connect your grounding cable to the chassis with a grounding lug (provided in the switch accessory kit) and to the facility ground.



---

**Note** Create an electrical conducting path between the product chassis and the metal surface of the enclosure, or rack in which it is mounted, or to a grounding conductor. Provide electrical continuity by using thread-forming type mounting screws that remove any paint or non-conductive coatings and establish a metal-to-metal contact. Remove any paint or other non-conductive coatings on the surfaces between the mounting hardware and the enclosure or rack. Clean the surfaces and apply an antioxidant before installation.

---

## Planning for Power Requirements

The switch includes two power supplies (1-to-1 redundancy with current sharing) in this combination: PSU-1 and PSU-2 are both 3kW dual AC power supplies (PSU3KW-HVPI) in a 1+1 redundancy.



---

**Note** For 1+1 redundancy, you must use two power sources and connect each power supply to a separate power source.

---

The power supplies are rated to output up to 3000 W (AC power supplies).



---

**Note** Some of the power supply modules have rating capabilities that exceed the switch requirements. When calculating your power requirements, use the switch requirements to determine the amount of power that is required for the power supplies.

---

To minimize the possibility of circuit failure, verify that each power-source circuit that is used by the switch is dedicated to the switch.

This Warning applies to AC input application.



---

**Warning** **Statement 1005**—Circuit Breaker when using AC power supplies

---

This product relies on the building's installation for short-circuit (overcurrent) protection. Ensure that the protective devices are rated not greater than 20A (North America), 16A (Europe), and 13A (UK).

---

## Airflow Requirements

The switch is positioned with its ports in either the front or the rear of the rack, depending on your cabling and maintenance requirements. To identify the airflow options for your switch, see the user-replaceable components in the *Overview* section of this document. Position the fan and power supply modules to move the coolant air from the cold aisle to the hot aisle in one of these ways:

- Port-side intake airflow—Cool air enters the chassis through the port end in the cold aisle and exhausts through the fan and power supply modules in the hot aisle.
- Single-direction airflow—The direction of the installed fan modules determines the airflow.

- For the N9364E-SG2-O switch, port-side exhaust configuration is *not* supported.
- For the N9364E-SG2-O switch, only port-side intake configuration is supported.

Identify the airflow direction of each fan and power supply module by its coloring.

- Red coloring indicates port-side intake airflow.

**Note**

- To prevent the switch from overheating and shutting down, position the air intake for the switch in a cold aisle. The fan and power supply modules must have the same direction of airflow.
- The airflow direction must be the same for all power supply and fan modules in the chassis. Airflow direction is front (ports) to back (fans and power supplies) of the chassis.

## Rack and Cabinet Requirements

Install these types of racks or cabinets for your switch:

- Standard perforated cabinets
- Solid-walled cabinets with a roof fan tray (bottom-to-top cooling)
- Standard open four-post Telco racks

Work with your cabinet vendors to determine which of their cabinets meet these requirements or see the Cisco Technical Assistance Center (TAC) for recommendations:

- Use a standard 19-inch (48.3-cm), four-post Electronic Industries Alliance (EIA) cabinet or rack with mounting rails that conform to English universal hole spacing per section 1 of the ANSI/EIA-310-D-1992 standard.
- The depth of a four-post rack must be 24 to 32 inches (61.0 to 81.3 cm) between the front and rear mounting rails (for proper mounting of the bottom-support brackets or other mounting hardware).

Also, you must have power receptacles that are located within reach of the power cords that are used with the switch.

**Warning Statement 1048**—Rack Stabilization

The rack stabilizing mechanism must be in place, or the rack must be bolted to the floor before installation or servicing. Failure to stabilize the rack can cause bodily injury.

## Clearance Requirements

Provide the chassis with adequate clearance between the chassis and any other rack, device, or structure so that you can properly install the switch. Provide the chassis with adequate clearance to route cables, provide



airflow, and maintain the switch. For the clearances required for an installation of this chassis in a four-post rack, see the figure.

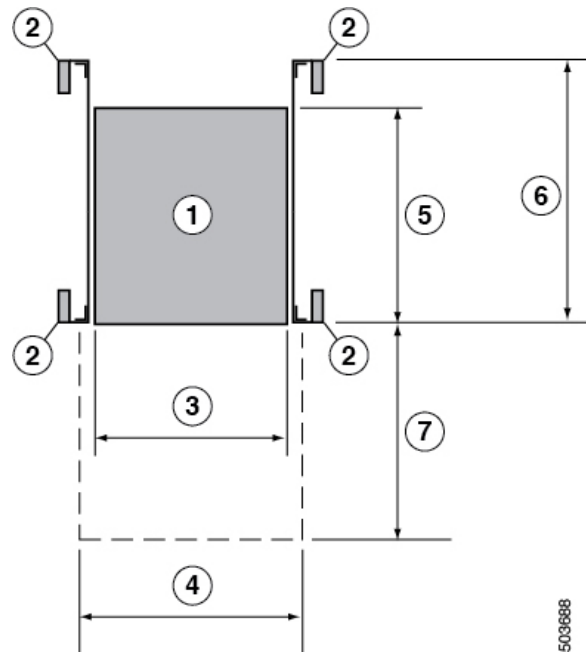

**Note** Both the front and rear of the chassis must be open to both aisles for airflow.

1	Chassis	5	Depth of the chassis 24.70 inches (62.74 cm) without fan module and power supply module 26.26 inches (66.70 cm) with fan module and power supply module
2	Vertical rack-mount posts and rails	6	Maximum extension of the bottom-support rails 36.0 in (91.0 cm)
3	Chassis width 17.4 in (44.2 cm)	7	Depth of the front clearance area (equal to the depth of the chassis).
4	Width of the front clearance area (equal to the width of the chassis with two rack-mount brackets that are attached to it). 19.0 in (48.26 cm)		Chassis height 3.43 inches (8.71 cm)

Figure 3: Clearance Required around the Chassis for Cisco Nexus N9364E-SG2-0

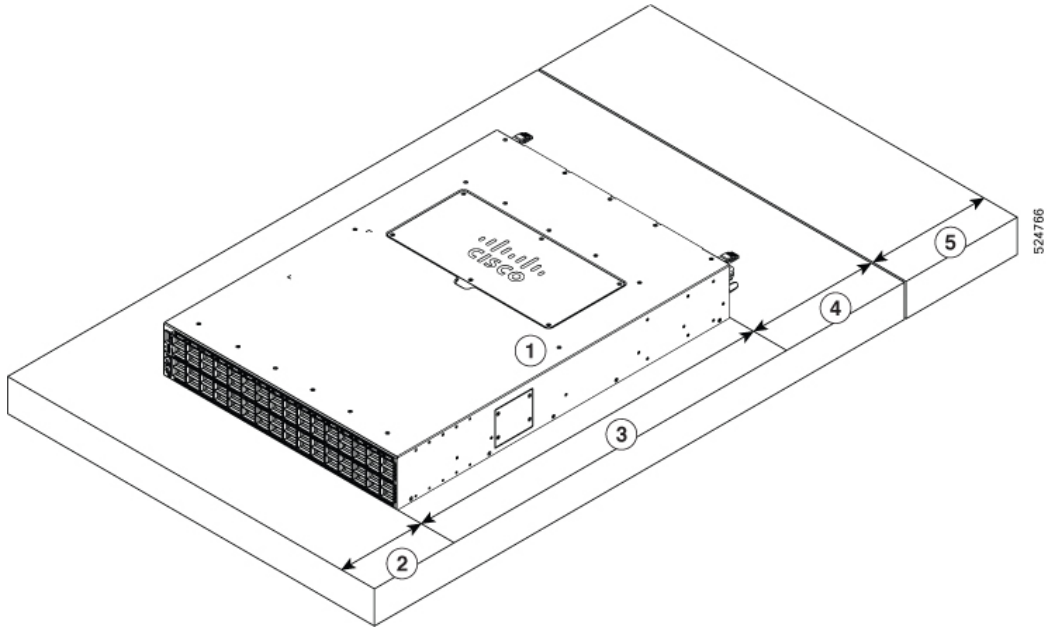

1	Chassis	4	6.0 in. (15.24 cm) rear clearance for air exhaust
2	6.0 in. (15.24 cm) front clearance for air intake	5	Additional 6.0 in. (15.24 cm) rear clearance for removal and installation of power supplies and fan modules
3	Chassis dimensions: 17.2 in. (43.94 cm) width, 26.26 in. (66.70 cm) with Fan Module and Power Supply depth, 3.43 in (8.71 cm) height		

## Network Equipment-Building System (NEBS) Statements

NEBS describes the environment of a typical United States Regional Bell Operating Company (RBOC) central office. NEBS is the most common set of safety, spatial, and environmental design standards applied to telecommunications equipment in the United States. It is not a legal or regulatory requirement, but rather an industry requirement.

These NEBS statements apply to the Cisco N9364C-SG2 switches.



---

**Warning** **Statement 1056**—Unterminated Fiber Cable

Invisible laser radiation may be emitted from the end of the unterminated fiber cable or connector. Do not view directly with optical instruments. Viewing the laser output with certain optical instruments, for example, eye loupes, magnifiers, and microscopes, within a distance of 100 mm, may pose an eye hazard.

---



---

**Warning** **Statement 1255**—Laser Compliance Statement

Pluggable optical modules comply with IEC 60825-1 Ed. 3 and 21 CFR 1040.10 and 1040.11 with or without exception for conformance with IEC 60825-1 Ed. 3 as described in Laser Notice No. 56, dated May 8, 2019.

---



---

**Note** **Statement 7001**—ESD Mitigation

This equipment may be ESD sensitive. Always use an ESD ankle or wrist strap before handling equipment. Connect the equipment end of the ESD strap to an unfinished surface of the equipment chassis or to the ESD jack on the equipment if provided.

---



---

**Warning** **Statement 7003**—Shielded Cable Shielded Cable Requirements for Intrabuilding Lightning Surge

The intrabuilding port(s) of the equipment or subassembly must use shielded intrabuilding cabling/wiring that is grounded at both ends.

The following port(s) are considered intrabuilding ports on this equipment:

RJ-45 Management Ethernet Port

---



---

**Note** **Statement 7004**—Special Accessories Required to Comply with GR-1089 Emission and Immunity Requirements

To comply with the emission and immunity requirements of GR-1089, shielded cables are required for the following ports:

Copper RJ-45 Ethernet Management port

---

**Warning Statement 7005**—Intrabuilding Lightning Surge and AC Power Fault

The intrabuilding port(s) of the equipment or subassembly must not be metallically connected to interfaces that connect to the outside plant (OSP) or its wiring. These interfaces are designed for use as intrabuilding interfaces only (Type 2 or Type 4 ports as described in GR-1089-CORE) and require isolation from the exposed OSP cabling. The addition of primary protectors is not sufficient protection to connect these interfaces metallically to OSP wiring.

This statement applies to the intrabuilding ports listed below:

RJ-45 Ethernet Management port

**Warning Statement 7012**—Equipment Interfacing with AC Power Ports

Connect this equipment to AC mains that are provided with a surge protective device (SPD) at the service equipment that complies with NFPA 70, the National Electrical Code (NEC).

**Note Statement 7013**—Equipment Grounding Systems—Common Bonding Network (CBN)

This equipment is suitable for installations using the CBN.

**Note Statement 7015**—Equipment Bonding and Grounding

When you use thread-forming screws to bond equipment to its mounting metalwork, remove any paint and nonconductive coatings and clean the joining surfaces. Apply an antioxidant compound before joining the surfaces between the equipment and mounting metalwork.

**Note Statement 7016**—Battery Return Conductor

Treat the battery return conductor of this equipment as DC-I.

**Note Statement 7018**—System Recover Time

The equipment is designed to boot up in less than 30 minutes provided the neighboring devices are fully operational.

**Note Statement 8015**—Installation Location Network Telecommunications Facilities

This equipment is suitable for installation in network telecommunications facilities.



---

**Note** **Statement 8016**—Installation Location Where the National Electric Code (NEC) Applies  
This equipment is suitable for installation in locations where the NEC applies.

---





## CHAPTER 3

# Installing the Chassis

---

- [Safety, on page 17](#)
- [Installation Options with Rack-Mount Kits, on page 21](#)
- [Install a Rack, on page 21](#)
- [Unpacking and Inspecting a New Switch, on page 22](#)
- [Procure Tools and Equipment, on page 22](#)
- [Switch Accessory Kit, on page 23](#)
- [Planning How to Position the Chassis in the Rack, on page 23](#)
- [Installing the Chassis in a Four-Post Rack, on page 23](#)
- [Grounding the Chassis, on page 27](#)
- [Starting the Switch, on page 28](#)

## Safety

Before you install, operate, or service the switch, see the *Regulatory, Compliance, and Safety Information for the Cisco Nexus 9000 Series* content for important Safety Information.



---

**Warning** **Statement 1071**—Warning Definition

**IMPORTANT SAFETY INSTRUCTIONS**

Before you work on any equipment, be aware of the hazards involved with electrical circuitry and be familiar with standard practices for preventing accidents. Read the installation instructions before using, installing, or connecting the system to the power source. Use the statement number provided at the end of each warning statement to locate its translation in the translated safety warnings for this device.

**SAVE THESE INSTRUCTIONS**

---

**Warning Statement 1089**—Instructed and Skilled Person Definitions

An instructed person is someone who has been instructed and trained by a skilled person and takes the necessary precautions when working with equipment.

A skilled person or qualified personnel is someone who has training or experience in the equipment technology and understands potential hazards when working with equipment.

There are no serviceable parts inside. To avoid risk of electric shock, do not open.

**Warning Statement 1074**—Comply with Local and National Electrical Codes

To reduce risk of electric shock or fire, installation of the equipment must comply with local and national electrical codes.

**Note Statement 407**—Japanese Safety Instruction

You are strongly advised to read the safety instruction before using the product.

<https://www.cisco.com/web/JP/techdoc/pldoc/pldoc.html>

When installing the product, use the provided or designated connection cables/power cables/AC adapters.

〈製品仕様における安全上の注意〉

[www.cisco.com/web/JP/techdoc/index.html](http://www.cisco.com/web/JP/techdoc/index.html)

接続ケーブル、電源コードセット、ACアダプタ、バッテリーなどの部品は、必ず添付品または指定品をご使用ください。添付品・指定品以外をご使用になると故障や動作不良、火災の原因となります。また、電源コードセットは弊社が指定する製品以外の電気機器には使用できないためご注意ください。

**Warning Statement 1017**—Restricted Area

This unit is intended for installation in restricted access areas. Only skilled, instructed, or qualified personnel can access a restricted access area.

**Warning Statement 1091**—Installation by an Instructed Person

Only an instructed person or skilled person should be allowed to install, replace, or service this equipment. See statement 1089 for the definition of an instructed or skilled person.

There are no serviceable parts inside. To avoid risk of electric shock, do not open.



**Warning Statement 1028—More Than One Power Supply**

This unit might have more than one power supply connection. To reduce risk of electric shock, remove all connections to de-energize the unit.

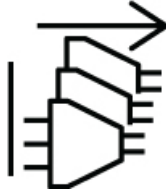
**Warning Statement 1003—Power Disconnection**

To reduce risk of electric shock or personal injury, disconnect power before removing or replacing components or performing upgrades.

**Warning Statement 1046—Installing or Replacing the Unit**

To reduce risk of electric shock, when installing or replacing the unit, the ground connection must always be made first and disconnected last.

If your unit has modules, secure them with the provided screws.

**Warning Statement 1022—Disconnect Device**

To reduce the risk of electric shock and fire, a readily accessible disconnect device must be incorporated in the fixed wiring.

**Warning Statement 1033—Safety Extra-Low Voltage (SELV)—IEC 60950/ES1—IEC 62368 DC Power Supply**

To reduce the risk of electric shock, connect the unit *only* to a DC power source that complies with the SELV requirements in the IEC 60950-based safety standards or the ES1 requirements in the IEC 62368-based safety standards.

**Warning Statement 1024—Ground Conductor**

This equipment must be grounded. To reduce the risk of electric shock, never defeat the ground conductor or operate the equipment in the absence of a suitably installed ground conductor. Contact the appropriate electrical inspection authority or an electrician if you are uncertain that suitable grounding is available.



---

**Warning** **Statement 1032**—Lifting the Chassis

To prevent personal injury or damage to the chassis, never attempt to lift or tilt the chassis using the handles on modules, such as power supplies, fans, or cards. These types of handles are not designed to support the weight of the unit.

---



---

**Warning** **Statement 1006**—Chassis Warning for Rack-Mounting and Servicing

To prevent bodily injury when mounting or servicing this unit in a rack, you must take special precautions to ensure that the system remains stable. The following guidelines are provided to ensure your safety:

- This unit should be mounted at the bottom of the rack if it is the only unit in the rack.
  - When mounting this unit in a partially filled rack, load the rack from the bottom to the top with the heaviest component at the bottom of the rack.
  - If the rack is provided with stabilizing devices, install the stabilizers before mounting or servicing the unit in the rack.
- 



---

**Caution** To prevent loss of input power, ensure the total maximum loads on the circuits supplying power to the switch are within the current ratings for the wiring and breakers.

---



---

**Note** For AC input application, please refer to the statement below:

---



---

**Warning** **Statement 1005**—Circuit Breaker

This product relies on the building's installation for short-circuit (overcurrent) protection. Ensure that the protective devices is rated not greater than 20A (North America), 16A (Europe), and 13A (UK).

---



---

**Warning** **Statement 1055**—Class 1/1M Laser

Invisible laser radiation is present. Do not expose to users of telescopic optics. This applies to Class 1/1M laser products.



## Installation Options with Rack-Mount Kits

The rack-mount kit enables you to install the switch into racks of varying depths. Position the switch with easy access to either the port connections or the fan and power supply modules.

Install the switch using these rack-mount options.

For four-post racks:

- 8K-2RU-KIT-SB

The rack or cabinet that you use must meet the requirements listed in [General Requirements for Cabinets and Racks, on page 47](#) section.



---

**Note** You are responsible for verifying that your rack and rack-mount hardware comply with the guidelines that are described in this document.

---

## Install a Rack

Before you install the switch, you must install a standard four-post, 19-inch EIA data center rack (or a cabinet that contains such a rack) that meets the requirements listed in [Overview of Racks, on page 47](#).

### Procedure

---

**Step 1** Bolt the rack to the concrete subfloor before moving the chassis onto it.

**Warning**

**Statement 1048**—Rack Stabilization

The rack stabilizing mechanism must be in place, or the rack must be bolted to the floor before installation or servicing. Failure to stabilize the rack can cause bodily injury.

**Step 2** If the rack has bonded construction, connect it to the earth ground. This action enables you to easily ground the switch and its components and to ground your electrostatic discharge (ESD) wrist strap to prevent damaging discharges when you handle ungrounded components before installing them.

**Step 3** Include one or two power sources at the rack. For AC power, provide a power receptacle.

**Step 4** Include one or two power sources at the rack. For DC power, provide a circuit breaker with terminals for connecting power cables.

**Warning**

**Statement 1018**—Supply Circuit

To reduce risk of electric shock and fire, take care when connecting units to the supply circuit so that wiring is not overloaded.

**Note**

If you are not using power redundancy or are using  $n+1$  redundancy, you need only one power source. If you are using  $n+n$  redundancy, you need two power sources.

---

## Unpacking and Inspecting a New Switch

Before you install a new chassis, unpack and inspect it to be sure that you have all the items that you ordered. Verify that the switch was not damaged during shipment. If anything is damaged or missing, contact your customer representative immediately.



---

**Caution** When you handle the chassis or its components, follow ESD protocol at all times to prevent ESD damage. This protocol includes but is not limited to wearing an ESD wrist strap that you connect to the earth ground.

---



---

**Tip** Do not discard the shipping container when you unpack the switch. Flatten the shipping cartons and store them. If you need to move or ship the system in the future, you will need this container.

---

### Procedure

---

**Step 1** Compare the shipment to the equipment list that is provided by your customer service representative. Verify that you have received all of the ordered items.

The shipment should include:

- Switch chassis
- Switch accessory kit

**Step 2** Check the contents of the shipping box for damage.

**Step 3** If you notice any discrepancies or damage, send this information to your customer service representative by email:

- Invoice number of the shipper (see packing slip)
  - Model and serial number of the missing or damaged unit
  - Description of the problem and how it affects the installation
- 

## Procure Tools and Equipment

Obtain these necessary tools and equipment for installing the chassis:

- Number 1 and number 2 Phillips screwdrivers with torque capability to rack-mount the chassis.

- 3/16-inch flat-blade screwdriver.
- Tape measure and level.
- ESD wrist strap or other grounding device.
- Antistatic mat or antistatic foam.
- Crimping tool for lug.
- Wire-stripping tool.
- M4 screws to fix brackets (16).
- M4 screws to fix a ground lug (2).

## Switch Accessory Kit

This table contains the switch accessory kit product identifications (PIDs). The switch accessory kit contains the rack mount kit and the ground lug kit. The rack mount kit present in the accessory kit contains the screws and brackets required for installation.

Switch	Accessory Kit	Items in Accessory Kit and Rack Depth Range
Cisco Nexus N9364E-SG2-O	8K-2RU-KIT-SB	2RU chassis rail kit

## Planning How to Position the Chassis in the Rack

The switch is designed so that you can have coolant air flow through the switch in one direction: port-side intake airflow. Enter the port side and exhaust out the power supply side (port-side intake airflow).

For port-side intake airflow, the switch must have port-side intake fan and AC power supply modules with one or more of these colorings:

- Red coloring on fan modules and AC power supplies

Plan the positioning of the switch so that its ports are located close to ports on connected devices or so that the fan and power supply modules are conveniently located in a maintenance aisle. Order the modules that move coolant air in the appropriate direction from the cold aisle to the hot aisle.



**Note** All fan and power supply modules in the same switch must operate with the same direction of airflow. The air intake portion of the switch must be located in a cold aisle.

## Installing the Chassis in a Four-Post Rack

Before you install the chassis, be sure that the rack is fully secured to the data center floor.

The table lists the items contained in the rack-mount kit.

Quantity	Part Description
2	Rack-mount brackets
12	M4 x 6 mm Phillips flat-head screws
2	M4 x 6 mm Phillips pan-head screws
2	Rack-mount guides
2	Rack-mount guide rails,
1	Grounding lug and screws
19	M3 x 6 mm Phillips flat-head screws



**Note** This switch does not support port-side exhaust configuration.

## Rack-Mount the Chassis in a 4-Post Rack

Slide the chassis onto the bottom-support rails so that the power supply end locks onto the chassis stops at the end of the rails and so that the front-mount brackets on the chassis come into contact with the front-mount rails on the rack.



**Warning Statement 1074**—Comply with Local and National Electrical Codes

To reduce risk of electric shock or fire, installation of the equipment must comply with local and national electrical codes.



**Warning Statement 1032**—Lifting the Chassis

To prevent personal injury or damage to the chassis, never attempt to lift or tilt the chassis using the handles on modules (such as power supplies, fans, or cards); these types of handles are not designed to support the weight of the unit.

### Before you begin



---

**Warning** **Statement 1006**—Chassis Warning for Rack-Mounting and Servicing

To prevent bodily injury when mounting or servicing this unit in a rack, take special precautions to ensure that the system remains stable. Follow these guidelines to ensure your safety:

- Mount this unit at the bottom of the rack if it is the only unit in the rack.
  - Load the rack from the bottom to the top, with the heaviest component at the bottom of the rack.
  - If the rack is provided with stabilizing devices, install the stabilizers before mounting or servicing the unit in the rack.
- 

### Procedure

---

**Step 1** Install the rack-mount brackets to the switch.

- a) Determine which end of the chassis is to be located in the cold aisle.
  - If the switch has port-side intake modules (fan modules and power modules with burgundy coloring), position the switch so that the ports are in the cold aisle.
- b) Position a rack-mount bracket on the side of the chassis with its four holes that are aligned to four of the screw holes on the side of the chassis. Use four M4 flat-head screws with 13.25 in lbs (1.5 N m) torque value to attach the bracket to the chassis.

**Note**

Align four holes in the rack-mount bracket to four screw holes on the front side of chassis or four screw holes on the rear side of the chassis. The holes that you use depend on which end of your chassis is located in the cold aisle.

Figure 4: Rack Mount Brackets on Cisco Nexus N9364E-SG2-0 Switch—Port Side

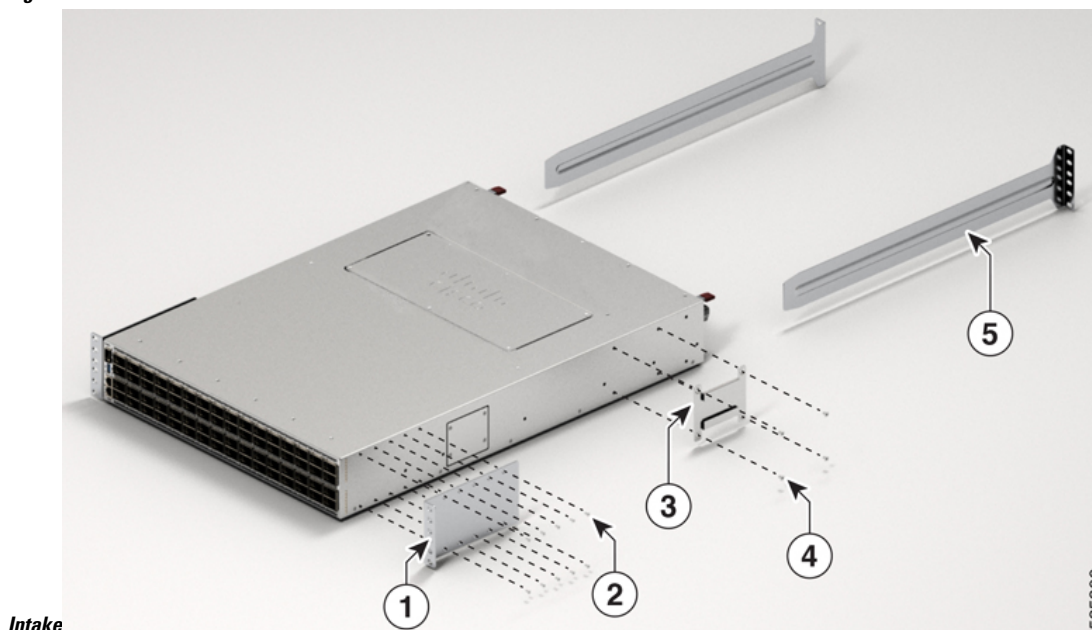

1	Rack-mount brackets	3	Rack-mount guide	5	Rack-mount guide rails
2	M4 x 6 mm Phillips flat-head screw	4	M3 x 6 mm Phillips flat-head screw		

- c) Repeat Step 1b with the other rack-mount bracket on the other side of the switch.

**Step 2** Install the two rack-mount guides on the chassis.

- a) Position a rack-mount guides on the side of the chassis with its two holes aligned to the two screw holes on the side of the chassis, and use two M4 flat-head screws to attach the guides to the chassis. Tighten the screws to a torque of 13.25 in-lb (1.5 N m).
- b) Repeat with the other rack-mount guides on the other side of the switch.

**Step 3** Install the guide rails to the rack.

- a) Position the guide rails at the desired levels on the back side of the rack. Use four 12-24 screws or four 10-32 screws, depending on the rack thread type, to attach the rails to the rack.

**Note**

For racks with square holes, you may need to position a 12-24 or 10-32 cage nut behind each mounting hole in a guide rail before using a 12-24 or 10-32 screw.

- b) Repeat with the other guide rail on the other side of the rack.
- c) Use a tape measure and level to verify that the rails are at the same height and horizontal.

**Step 4** Insert the switch into the rack and attach.

- a) Use both hands to position the back of the switch between the front posts of the rack.
- b) Align the two rack-mount guides on either side of the switch with the guide rails installed in the rack. Slide the rack-mount guides onto the guide rails. Gently slide the switch all the way into the rack.

**Note**

If the switch does not slide easily, try realigning the rack-mount guides on the guide rails.



- c) Holding the chassis level, insert two screws (12-24 or 10-32, depending on the rack type) through the holes in each of the rack-mount brackets and into the cage nuts or threaded holes in the rack-mounting rail.
- d) Tighten the 10-32 screws to 20 in-lb (2.26 N m) or tighten the 12-24 screws to 30 in-lb (3.39 N m).

---

## Grounding the Chassis

The switch chassis is automatically grounded when you properly install the switch in a grounded rack with metal-to-metal connections between the switch and rack.



---

**Note** Provide an electrical conducting path between the product chassis and the metal surface of the enclosure or rack in which it is mounted or to a grounding conductor. To ensure electrical continuity, use thread-forming type mounting screws that remove any paint or non-conductive coatings and establish a metal-to-metal contact. Remove any paint or other non-conductive coatings on the surfaces between the mounting hardware and the enclosure or rack. Clean the surfaces and apply an antioxidant before installation.

---

Ground the rack if using LVDC power supplies. If using AC or HVDC power supplies, the power cord for the AC power supplies provides grounding for the chassis. For supplemental grounding or bonding, attach a customer-supplied grounding cable to the chassis ground pad.

Ground the chassis. If you are using a 2-post rack, attach a customer-supplied grounding cable. Attach the cable to the chassis grounding pad and the facility ground. If you are using a 4-post rack, ensure that your chassis is grounded through the rack mount system or the power cable (AC or HVDC).



---

**Warning Statement 1024—Ground Conductor**

This equipment must be grounded. To reduce the risk of electric shock, never defeat the ground conductor or operate the equipment in the absence of a suitably installed ground conductor. Contact the appropriate electrical inspection authority or an electrician if you are uncertain that suitable grounding is available.

---



---

**Warning Statement 1046—Installing or Replacing the Unit**

To reduce risk of electric shock, when installing or replacing the unit, the ground connection must always be made first and disconnected last.

---

### Before you begin

Before you can ground the chassis, verify the earth ground contact has a solid connection to the data center building.

## Procedure

- Step 1** Use a wire-stripping tool to remove approximately 0.75 inch (19 mm) of the covering from the end of the grounding wire. We recommend 6-AWG wire for the U.S. installations.
- Step 2** Insert the stripped end of the grounding wire into the open end of the grounding lug. Use a crimping tool to crimp the lug to the wire. See the figure. Verify that the ground wire is securely attached to the grounding lug by attempting to pull the wire out of the crimped lug (tug test).

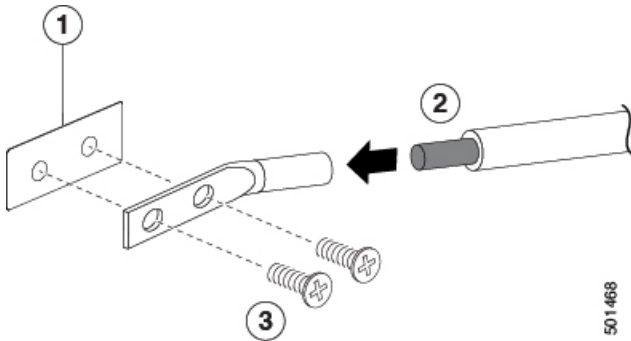

1	Chassis grounding pad	3	2 M4 screws are used to secure the grounding lug to the chassis
2	Grounding cable, with 0.75 in. (19 mm) of insulation that is stripped from one end, which is inserted into the grounding lug and crimped in place		

- Step 3** Secure the grounding lug to the chassis grounding pad with two M4 screws, see figure 1. Tighten the screws to 11 to 15 in-lb (1.24 to 1.69 N m) of torque.
- Step 4** Prepare the other end of the grounding wire and connect it to the facility ground.

## Starting the Switch

Start the switch by connecting it to its dedicated power source. If you need  $n+n$  redundancy, connect each power supply in a switch to a different power source.



**Note** This equipment is designed to boot up in less than 30 minutes, dependent on its neighboring devices being fully up and running.

Table 1: Electrical Ratings

AC Power Supply Unit PIDs	Supported Switches	Input Voltage	Input Current (Max)	Input Frequency	Output Power
PSU3KW-HVPI	Cisco Nexus 9364E-SG2-O	200-277V	16A	50-60Hz	3000W

**Before you begin**

- The switch must be installed and secured to a rack or cabinet.
- The switch must be adequately grounded.
- The rack must be close enough to the dedicated power source so that you can connect the switch to the power source by using the designated power cables.
- You have the designated power cables for the power supplies that you are connecting to the dedicated power sources.



**Note** Depending on the outlet receptacle on your AC power distribution unit, you might need an optional jumper power cord to connect the switch to your outlet receptacle.

- The switch is not connected to the network (this includes any management or interface connections).
- The fan and power supply modules are fully secured in their chassis slots.

**Procedure**

- Step 1** For the AC power supply, do this:
- Using the recommended AC power cable for your country or region, connect one end to the AC power supply.
  - Connect the other end of the power cable to the AC power source.

- Step 2** Verify that the power supply LED is on and green.

**Note**

When one PSU is connected, the STATUS LED color is amber. With two PSUs connected, the STATUS LED color is green.

- Step 3** Listen for the fans; they should begin operating when the power supply is powered.

- Step 4** After the switch boots, verify that these LEDs are lit:

- On the fan modules, the Status (STA or STS) LED is green.  
If a fan module Status LED is not green, try reinstalling the fan module.
- After initialization, the switch chassis Status (labeled as STA or STS) LED is green.

- Step 5** Verify that the system software has booted and the switch has initialized without error messages.

A setup utility automatically launches the first time that you access the switch and guides you through the basic configuration. For instructions on how to configure the switch and check module connectivity, see the appropriate [Cisco Nexus 9000 Series Configuration Guides](#).

---



## CHAPTER 4

# Connecting the Switch to the Network

---

- [Overview of Network Connections, on page 31](#)
- [Connecting a Console to the Switch, on page 32](#)
- [Creating the Initial Switch Configuration, on page 33](#)
- [Setting Up the Management Interface, on page 34](#)
- [Connecting Interface Ports to Other Devices, on page 35](#)
- [Maintaining Transceivers and Optical Cables, on page 35](#)

## Overview of Network Connections

After you install the switch in a rack and power it up, make these network connections:

- **Console connection**—This is a direct local management connection that you use to initially configure the switch. Make this connection **first** to initially configure the switch and determine its IP address, which is needed for the other connections.
- **Management connection**—After you complete the initial configuration using a console, make this connection to manage all future switch configurations.
- **Uplink and downlink interface connections**—These are connections to hosts and servers in the network.

Each of these connection types is explained in one of these sections.



---

**Note** When running cables in overhead or subfloor cable trays, we strongly recommend that you locate power cables and other potential noise sources as far away as practical from network cabling that terminates on Cisco equipment. In situations where long parallel cable runs cannot be separated by at least 3.3 feet (1 meter), we recommend that you shield any potential noise sources by housing them in a grounded metallic conduit.

---



---

**Note** When using SFP+ or SFP transceivers in a QSFP+ or QSFP28 uplink port, install a QSFP-to-SFP adapter, such as the CVR-QSFP-SFP10G adapter, in the QSFP port and then install the SFP+ or SFP transceiver. The switch automatically sets the port speed to the speed of the installed transceiver.

---

# Connecting a Console to the Switch

Before you create a network management connection for the switch or connect the switch to the network, create a local management connection through a console terminal. Then configure an IP address for the switch. Use the console to perform these functions, each of which can be performed through the management interface after you make that connection.

- Configure the switch using the command-line interface (CLI).
- Monitor network statistics and errors.
- Configure Simple Network Management Protocol (SNMP) agent parameters.
- Download software updates.

Make this local management connection between the asynchronous serial port on a supervisor module and a console device capable of asynchronous transmission. Typically, you use a computer terminal as the console device. On the supervisor modules, use the console serial port.



---

**Note** Before you can connect the console port to a computer terminal, make sure that the computer terminal supports VT100 terminal emulation. The terminal emulation software makes communication between the switch and the computer possible during setup and configuration.

---

## Before you begin

- The switch must be fully installed in its rack, connected to a power source, and grounded.
- The necessary cabling for the console, management, and network connections must be available.
  - An RJ-45 rollover cable provided in the switch accessory kit.
  - Network cabling is routed to the location of the installed switch.

## Procedure

---

**Step 1** Configure the console device to match these default port characteristics:

- 115200 baud
- 8 data bits
- 1 stop bit
- No parity

**Step 2** Connect an RJ-45 rollover cable to the console port on the switch.  
Find this cable in the accessory kit.

**Step 3** Route the RJ-45 rollover cable to the console or a modem.

**Step 4** Connect the other end of the RJ-45 rollover cable to the console or to a modem.

---

**What to do next**

Create the initial switch configuration. See [Creating the Initial Switch Configuration, on page 33](#).

## Creating the Initial Switch Configuration

**Before you begin**

- A console device must be connected with the switch.
- The switch must be connected to a power source.
- Determine the IP address and the netmask that is needed for the Management (Mgmt0) interface.

**Procedure**

---

**Step 1** Power up the switch by connecting each installed power supply to an AC circuit.

If you are using the input-source ( $n+n$ ) power mode, connect half of the power supplies to one AC circuit. Connect the other half of the power supplies to another AC circuit.

The Input and Output LEDs on each power supply light up (green) when the power supply units are sending power to the switch. The software asks you to specify a password to use with the switch.

**Step 2** Enter a new password for this switch.

The software checks the security strength of your password. It rejects your password if it does not meet these guidelines:

- At least eight characters.
- Minimizes or avoids the use of consecutive characters (such as "abcd").
- Minimizes or avoids repeating characters (such as "aaabbb").
- Does not contain recognizable words from the dictionary.
- Does not contain proper names.
- Contains both uppercase and lowercase characters.
- Contains numbers and letters.

Examples of strong passwords are:

- If2CoM18
- 2004AsdfLkj30
- Cb1955S21

**Note**

Clear text passwords cannot include the dollar sign (\$) special character.

**Tip**

If a password is trivial (such as a short, easy-to-decipher password), the software will reject your password configuration. Configure a strong password as explained in this step. Passwords are case-sensitive.

When you enter a strong password, the software asks you to confirm the password.

- Step 3** Enter the same password again.  
If you enter the same password, the software accepts the password and begins asking a series of configuration questions.
- Step 4** Until you are asked for an IP address, enter the default configuration for each question.  
Repeat this step for each question until you are asked for the Mgmt0 IPv4 address.
- Step 5** Enter the IP address for the management interface.  
The software asks for the Mgmt0 IPv4 netmask.
- Step 6** Enter a network mask for the management interface.  
The software asks if you need to edit the configuration.
- Step 7** Enter **no**, to not edit the configuration.  
The software asks if you need to save the configuration.
- Step 8** Enter **yes** to save the configuration.
- 

**What to do next**

Set up the management interface for each supervisor module on the switch.

## Setting Up the Management Interface

**Before you begin**

The switch must be powered on.

**Procedure**

- 
- Step 1** Connect the management cable into the management port on the switch. For shorter connections, you can use a cable with RJ-45 connectors.
- Step 2** Connect the other end of the cable to a 10/100/1000 Ethernet port on a network device.
-



## Connecting Interface Ports to Other Devices

After you perform the initial configuration for the switch and create a management connection, you are ready to connect the interface ports on the switch to other devices. Depending on the types of interface ports on the switch, use interface cables with QSFP28, QSFP+, SFP+, SFP transceivers, or RJ-45 connectors to connect the switch to other devices.



---

**Note** When using SFP+ or SFP transceivers in a QSFP+ or QSFP28 uplink port, install a QSFP-to-SFP adapter, such as the CVR-QSFP-SFP10G adapter, in the QSFP port and then install the SFP+ or SFP transceiver. The switch automatically sets the port speed to the speed of the installed transceiver.

---

If the transceivers that you are using can be separated from their optical cables, install the transceivers without their cables before inserting the cables into the transceivers. This helps to prolong the life of both the transceiver and cables. When removing transceivers from the switch, remove the optical cable first and then remove the transceiver.

To determine which transceivers, adapters, and cables are supported by this switch, see the [Cisco Transceiver Modules Compatibility](#) Information document.

## Maintaining Transceivers and Optical Cables

Keep transceivers and fiber-optic cables clean and dust free to maintain high signal accuracy and prevent damage to the connectors. Contamination increases attenuation (loss of light) and should be below 0.35 dB.

Consider these maintenance guidelines:

- Transceivers are static sensitive. To prevent ESD damage, wear an ESD-preventative wrist strap that is connected to the grounded chassis.
- Do not remove and insert a transceiver more often than is necessary. Repeated removals and insertions can shorten its useful life.
- Keep all optical connections covered when not in use. Clean them before using to prevent dust from scratching the fiber-optic cable ends.
- Do not touch the ends of connectors. Touching the ends can leave fingerprints and cause other contamination.
- Clean the connectors regularly; the required frequency of cleaning depends upon the environment. In addition, clean connectors if they are exposed to dust or accidentally touched. Both wet and dry cleaning techniques can be effective; refer to the fiber-optic connection cleaning procedures for your site.
- Inspect routinely for dust and damage. If you suspect damage, clean and then inspect fiber ends under a microscope to determine if damage has occurred.



---

**Note** When you need to remove a fiber-optic transceiver, first remove the fiber-optic cable from the transceiver **before** you remove the transceiver from the port.

---





## CHAPTER 5

# Replacing Components

---

- [Replacing a Fan Module During Operations, on page 37](#)
- [Replacing a Power Supply Module, on page 38](#)
- [Installing and Removing Small-Form Pluggable Modules, on page 40](#)
- [Install and Remove OSFP/QSFP Transceiver Modules, on page 41](#)
- [Attaching the Optical Network Cable, on page 44](#)
- [Removing the Transceiver Module, on page 45](#)

## Replacing a Fan Module During Operations

All fan and power supply modules must have the same airflow direction or else an error can occur with the switch overheating and shutting down. You can determine the airflow direction of a fan module by the color of the stripe on the front of the module. If the fan module has a red stripe for port-side intake airflow, the power supplies must have red coloring for the same airflow direction. To avoid over heating the switch, make sure that the fan modules are positioned this way:

- For port-side intake airflow with red coloring, position the ports in a cold aisle.

### Before you begin

Before you can replace a fan module, ensure that these conditions exist:

- There are four functioning fan modules in the other fan slots. To replace a fan module during operations, there must be three fan modules circulating air in the chassis at all times. The other fan module is redundant and can be replaced.
- The replacement fan module must have the same airflow direction as the other modules in the chassis.

If you must replace the fan module during operations and the above conditions are not met, leave the fan module that you need to replace in the chassis to preserve the designed airflow until you have the required module.

### Procedure

---

Use these steps to replace the missing fan module within two minutes to avoid a shutdown.

- a) Remove the replacement fan module from its packing materials and place it on an antistatic surface.

Hold the module by its handle and do not touch the electrical connectors on its backside. Also, to protect the electrical connectors, avoid letting them come in contact with anything other than the electrical connectors inside the chassis.

- b) Verify that you have the right fan module for the chassis. The correct fan module has one of these part numbers:
- FAN-PI-V4 (port-side intake airflow direction and a red stripe)

**Note**

Be sure that the airflow direction of the new fan module matches the airflow direction of the other fan and AC power supply modules already installed in the chassis. Port-side intake airflow is indicated with red coloring. Power supplies with dual-direction airflow (airflow direction is set by the fan modules) have white coloring.

- c) Position the fan module in front of the open fan slot (be sure that the backside of the module with the electrical connectors is positioned to enter the slot first) and slide the module all the way into the chassis until its front side comes in contact with the chassis. For the last 0.2 inches (0.5 cm), carefully mount the module onto the chassis connectors by pushing more firmly, but do not force the module if it does not move further (excessive force can damage the connectors).

**Note**

If you are not able to push the module all the way into the slot, carefully slide the module out of the slot and check its electrical connectors for damage. If damaged, contact Cisco Technical Assistance for help. If undamaged, repeat this step to reinstall the module.

- d) Verify that the STS LED turns on and becomes green.

If the STS LED does not turn on, slide the module out of the chassis, and visually check the electrical connectors on the back side of the chassis for damage. If damaged, contact Cisco Technical Assistance for help. If undamaged, repeat the previous step to reinstall the module.

---

## Replacing a Power Supply Module

The switch requires two power supplies for redundancy. With one power supply providing the necessary power for operations, replace the other power supply during operations as long as the new power supply has the same airflow direction as the other modules in the chassis.

Replace a power supply with another supported power supply that has the same power source type as the other installed power supply. Additionally, the airflow direction of the power supply must match or conform to the airflow direction of the installed fan modules. For the airflow direction used by the switch, see the coloring of the fan modules.

## Removing an AC Power Supply

To disconnect the power supply from its power cables, shut off the power from the power source and disconnect the connector for the power cables.

## Procedure

**Step 1** Remove the power cable from the power supply by pressing the tab of the Anderson Power SAF-D-Grid connector and pull the cable and connector out of the power supply.

Verify that the LEDs turn off on the power supply that you are removing.

**Step 2** Grasp the power supply handle while pressing the release latch towards the power supply handle.

**Step 3** Place your other hand under the power supply to support it while you slide it out of the chassis.

### Caution

Do not touch the electrical connectors on the back side of the module. Prevent anything else from coming into contact with or damaging the connectors.

### What to do next

Install an AC power supply in the open slot.

## Installing an HVAC/HVDC Power Supply

You can replace one power supply while the other one provides power to the switch.



**Note** If the power supply that you are replacing has a different color handle than the replacement power supply, verify that it has or will have the same airflow direction as the other modules in the switch.

### Before you begin

- If you are using  $n+n$  power redundancy, there must be a separate power source for each power supply installed in the chassis. Power sources must be of the same type—do not mix AC and DC power sources for the same switch. Otherwise, only one power source is required.
- There must be an earth-ground connection to the chassis that you are installing the replacement module. Typically, the chassis is grounded by its metal-to-metal connection to a grounded rack. If you need to ground this chassis by another means, see [Grounding the Chassis, on page 27](#).

## Procedure

**Step 1** Holding the replacement power supply with one hand underneath the module and the other hand holding the handle, turn the power supply so that its release latch is on the side. Align the back end of the power supply (the end with the electrical connections) to the open power supply slot. Carefully slide the power supply all the way into the slot until it clicks into place.

### Note

If the power supply does not fit into the open slot, turn the module over. Slide it into the open slot.

- Step 2** Test the installation by trying to pull the power supply out of the slot without using the release latch.  
If the power supply does not move out of place, it is secured in the slot. If the power supply moves, carefully press it all the way into the slot until it clicks into place.
- Step 3** Insert the power supply cord Anderson SAF-D-Grid connector into the power supply inlet. Ensure the connector is locked. Gently tug on the cord near the connector to ensure the locking tab is engaged.
- Step 4** Verify that the other end of the power cable is connected to the appropriate power source for the power supply.
- Step 5** If using an HVDC power source, turn on the circuit breaker for the DC power source connected to the power supply.
- Step 6** Verify that the power supply is operational by making sure that the power supply LED is green.

## Installing and Removing Small-Form Pluggable Modules

### Before you begin

See the Cisco Nexus 9364E-SG2-O switch [datasheet on cisco.com](#) for a list of supported SFP and SFP+ modules. Use only supported SFP/SFP+ modules on the platform.



#### Warning Statement 1008—Class 1 Laser Product

This product is a Class 1 laser product.



**Note** We recommend that you wait 30 seconds between removal and insertion of an SFP on an interface module. This allows the transceiver software to initialize and synchronize with the standby RSP. Changing an SFP more quickly could result in transceiver initialization issues that disable the SFP.

- Do not remove the dust plugs from the SFP and SFP+ modules or the rubber caps from the fiber-optic cable until you are ready to connect the cable. The plugs and caps protect the module ports and cables from contamination and ambient light.
- Removing and installing an SFP and SFP+ module can shorten its useful life. Do not remove and insert any SFP/SFP+ module more often than is necessary.
- To prevent ESD damage, follow your normal board and component handling procedures when connecting cables to the switch and other devices.
- When you insert several SFP and SFP+ modules in multiple ports, wait for 5 seconds between inserting each SFP/SFP+. This will prevent the ports from going into error / disabled mode. Similarly, when you remove an SFP and SFP+ from a port, wait for 5 seconds before reinserting it.

### SUMMARY STEPS

1. Attach an ESD-preventive wrist strap to your wrist and to an earth ground surface.
2. Find the send (TX) and receive (RX) markings that identify the top of the SFP/SFP+ module.
3. If the SFP/SFP+ module has a bale-clasp latch, move it to the open, unlocked position.

4. Align the module in front of the slot opening and push until you feel the connector snap into place.
5. If the module has a bale-clasp latch, close it to lock the SFP/SFP+ module in place.
6. Remove the SFP and SFP+ dust plugs and save.
7. Connect the SFP and SFP+ cables.

## DETAILED STEPS

### Procedure

	Command or Action	Purpose
<b>Step 1</b>	Attach an ESD-preventive wrist strap to your wrist and to an earth ground surface.	
<b>Step 2</b>	Find the send (TX) and receive (RX) markings that identify the top of the SFP/SFP+ module.	On some SFP/SFP+ modules, the send and receive (TX and RX) markings might be shown by arrows that show the direction of the connection.
<b>Step 3</b>	If the SFP/SFP+ module has a bale-clasp latch, move it to the open, unlocked position.	
<b>Step 4</b>	Align the module in front of the slot opening and push until you feel the connector snap into place.	
<b>Step 5</b>	If the module has a bale-clasp latch, close it to lock the SFP/SFP+ module in place.	
<b>Step 6</b>	Remove the SFP and SFP+ dust plugs and save.	
<b>Step 7</b>	Connect the SFP and SFP+ cables.	

## Install and Remove OSFP/QSFP Transceiver Modules

This section provides the installation, cabling, and removal instructions for the Quad Small Form-Factor Pluggable transceiver modules. Refer to the [Cisco Transceiver Modules Compatibility Information](#) for additional details on optical transceivers.

The figure shows a typical 800-Gigabit OSFP (optical small form-factor pluggable) transceiver.

Figure 5: OSFP Transceiver Module

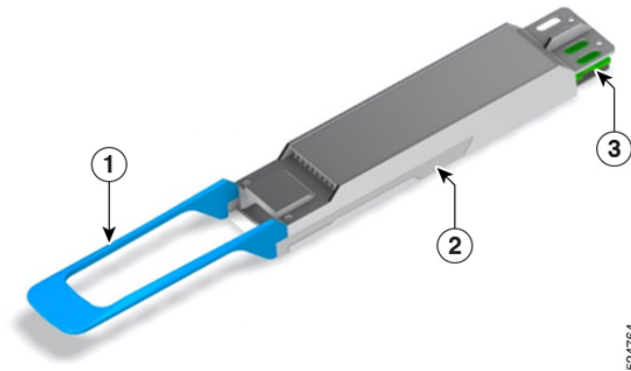

1	Pull tab	2	OSFP transceiver body
3	Electrical connection to the module circuitry		

**Installing the Transceiver Module**



**Warning Statement 1079—Hot Surface**

This icon is a hot surface warning. To avoid personal injury, do not touch without proper protection.



**Caution** The transceiver module is a static-sensitive device. Always use an ESD wrist strap or similar individual grounding device when handling transceiver modules or coming into contact with system modules.



**Caution** Protect the transceiver ports by inserting clean dust caps (8000-QSFP-DCAP) into any ports not in use or that do not have optical modules plugged in. If optical modules are plugged in but not in use, use the dust caps that were supplied with the optical modules to protect the TX and RX surfaces of the optical module.

Clean the optic surfaces of the fiber cables before you plug them back into the optical ports of another module.

The switch ships with dust caps plugged in. We **highly** recommend you keep the dust caps plugged in until you are ready to plug an optic. The dust caps protect the ports from possible EMI interference and also avoid contamination due to dust collection.



**Caution** To meet the EMI interference requirements, use the metal dust caps when the ports are not in use by optical modules.



## Before you begin

### Required Tools and Equipment

- Wrist strap or other personal grounding device to prevent ESD occurrences
- Antistatic mat or antistatic foam to set the transceiver on
- Fiber-optic end-face cleaning tools and inspection equipment

## Procedure

- Step 1** Attach an ESD wrist strap to yourself and a properly grounded point on the chassis or the rack.
- Step 2** Remove the transceiver module from its protective packaging.
- Step 3** Check the label on the transceiver module body to verify that you have the correct model for your network. Do not remove the dust plug until you're ready to attach the network interface cable. The dust plug is not shown in the images.
- Step 4** Hold the transceiver by the pull-tab so that the identifier label is on the top.
- Step 5** Align the transceiver module in front of the module's transceiver socket opening and carefully slide the transceiver into the socket until the transceiver contacts the socket electrical connector.

*Figure 6: Installing the QSFP Transceiver Module*

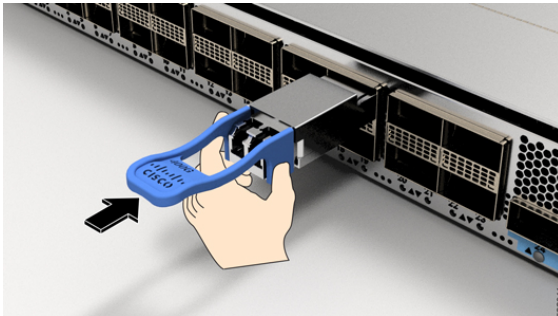

- Step 6** Press firmly on the front of the transceiver module with your thumb to fully seat the transceiver in the module's transceiver socket (see figure Seating the QSFP Transceiver Module).

*Figure 7: Seating the QSFP Transceiver Module*

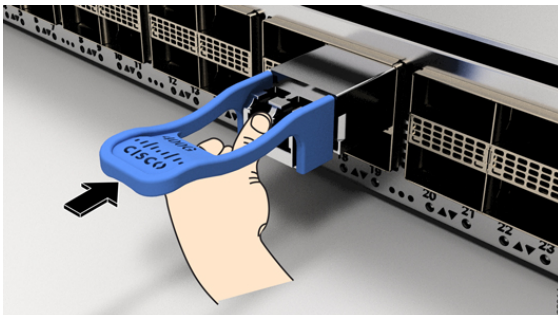

**IMPORTANT:** If the latch isn't fully engaged, you might accidentally disconnect the transceiver module.

# Attaching the Optical Network Cable

## Before you begin

Before you remove the dust plugs and make any optical connections, use these guidelines:

- Keep the protective dust plugs installed in the unplugged fiber-optic cable connectors and in the transceiver optical bores until you are ready to make a connection.
- Inspect and clean the optical connector end faces just before you make any connections.
- Grasp the optical connector only by the housing to plug or unplug a fiber-optic cable.



## Note

- The transceiver modules and fiber connectors are keyed to prevent incorrect insertion.
- The multiple-fiber push-on (MPO) connectors on the optical transceivers support network interface cables with either physical contact (PC) or ultra-physical contact (UPC) flat polished face types. The MPO connectors on the optical transceivers do not support network interface cables with an angle-polished contact (APC) face type.
- Inspect the MPO connector for the correct cable type, cleanliness, and any damage. For complete information on inspecting and cleaning fiber-optic connections, see the [Inspection and Cleaning Procedures for Fiber-Optic Connections](#) document.

## Procedure

**Step 1** Remove the dust plugs from the optical network interface cable MPO connectors and from the transceiver module optical bores. Save the dust plugs for future use.

**Step 2** Attach the network interface cable MPO connectors immediately to the transceiver module.

**Figure 8: Cabling a Transceiver Module**

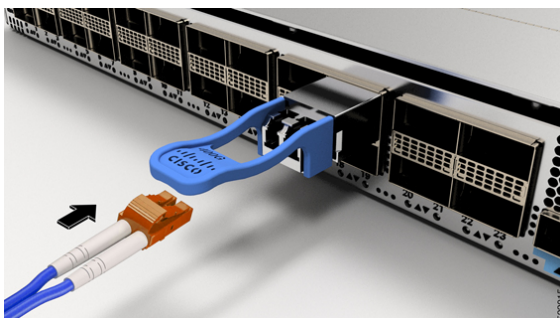

# Removing the Transceiver Module



**Caution** The transceiver module is a static-sensitive device. Always use an ESD wrist strap or similar individual grounding device when handling transceiver modules or coming into contact with modules.

To remove a transceiver module, use these steps:

## Procedure

- Step 1** Disconnect the network interface cable from the transceiver connector.
- Step 2** Install the dust plug immediately into the transceiver's optical bore.
- Step 3** Grasp the pull-tab and gently pull to release the transceiver from the socket.

*Figure 9: Removing the QSFP Transceiver Module*

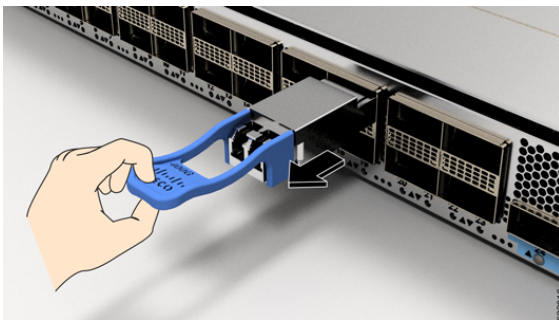

- Step 4** Slide the transceiver out of the socket.
- Step 5** Place the transceiver module into an antistatic bag.





## APPENDIX **A**

# Rack Specifications

---

- [Overview of Racks, on page 47](#)
- [General Requirements for Cabinets and Racks, on page 47](#)
- [Requirements Specific to Standard Open Racks, on page 48](#)
- [Requirements Specific to Perforated Cabinets, on page 48](#)
- [Cable Management Guidelines, on page 49](#)

## Overview of Racks

Install the switch in these types of cabinets and racks, assuming an external ambient air temperature range of 0 to 104°F (0 to 40°C):

- Standard perforated cabinets
- Solid-walled cabinets with a roof fan tray (bottom to top cooling)
- Standard open racks



---

**Note**

- If you are using an enclosed cabinet, we recommend one of the thermally validated types, either standard perforated or solid-walled with a fan tray.
  - We do not recommend using racks that have obstructions (such as power strips). The obstructions could impair access to field-replaceable units (FRUs).
- 

## General Requirements for Cabinets and Racks

The cabinet or rack must meet these requirements:



---

**Note**

This switch rack-mount kit contains the rack mounting brackets for 19-inch rack. To install the chassis in a 23-inch rack or an ETSI rack, you need adapter plates to accommodate the 19-inch rack mount brackets.

---

- Standard 19-inch (48.3 cm) (two- or four-post EIA cabinet or rack, with mounting rails that conform to English universal hole spacing per section 1 of ANSI/EIA-310-D-1992). For more information, see [Requirements Specific to Perforated Cabinets, on page 48](#).

The spacing between the posts of the rack must be (EIA-310-D-1992 19-inch rack compatible) wide enough to accommodate the width of the chassis.

- The minimum vertical rack space requirement per chassis is:
  - For a one RU (rack unit) switch, 1.75 inches (4.4 cm)
  - For a one and a half RU (rack unit) switch, 2.63 (6.68 cm)
  - For a two RU (rack unit) switch, 3.5 inches (8.8 cm)
  - For a three RU (rack unit) switch, 5.25 inches (13.3 cm)
- The width between the rack-mounting rails must be at least 17.75 inches (45.0 cm) if the rear of the device is not attached to the rack. For four-post EIA racks, this measurement is the distance between the two front rails.

Four-post EIA cabinets (perforated or solid-walled) must meet these requirements:

- The minimum spacing for the bend radius for fiber-optic cables should have the front-mounting rails of the cabinet offset from the front door by a minimum of 3 inches (7.6 cm).
- The distance between the outside face of the front mounting rail and the outside face of the back mounting rail should be 23.0 to 30.0 inches (58.4 to 76.2 cm) to allow for rear-bracket installation.

## Requirements Specific to Standard Open Racks

If you are mounting the chassis in an open rack (no side panels or doors), ensure that the rack meets these requirements:

- The minimum vertical rack space per chassis must be equal to the rack unit (RU) of the chassis. One rack unit is equal to 1.75 inches (4.4 cm).
- The distance between the chassis air vents and any walls should be 2.5 inches (6.4 cm).

## Requirements Specific to Perforated Cabinets

A perforated cabinet has perforations in its front and rear doors and side walls. Perforated cabinets must meet these requirements:

- The front and rear doors must have at least a 60 percent open area perforation pattern, with at least 15 square inches (96.8 square cm) of open area per rack unit of door height.
- The roof should be perforated with at least a 20 percent open area.
- The cabinet floor should be open or perforated to enhance cooling.

The Cisco R Series rack conforms to these requirements.

# Cable Management Guidelines

To help with cable management, allow additional space in the rack above and below the chassis to make it easier to route all of the fiber optic or copper cables through the rack.







## APPENDIX **B**

# System Specifications

- [Environmental Specifications, on page 51](#)
- [Switch Dimensions, on page 52](#)
- [Switch and Module Weights and Quantities, on page 52](#)
- [Transceiver and Cable Specifications, on page 52](#)
- [Switch Power Input Requirements, on page 52](#)
- [Power Specifications, on page 53](#)
- [Power Cable Specifications, on page 53](#)
- [Regulatory Standards Compliance Specifications, on page 55](#)

## Environmental Specifications

Environment		Specification
Temperature	Ambient operating temperature	32 to 104°F (0 to 40°C)
	Ambient nonoperating	-40 to 158°F (-40 to 70°C)
Humidity	Ambient operating humidity	8 to 80%
	Ambient nonoperating	5 to 95%
Altitude*	Ambient operating altitude	0 to 10,000 feet (0 to 3,048 meters) For China, 6,562 ft (2000 m)
	Ambient nonoperating	-1000 to 30,000 feet (-304 to 15,150 meters)
<p>* The Cisco Nexus switch functions in operating temperatures of up to 40°C at sea level. For every 300 meters (1000 ft) above sea level, the maximum temperature is reduced by 1°C. For more details on environmental requirements, see the <a href="#">Cisco Datasheet</a>.</p>		

## Switch Dimensions

Switch	Width	Depth	Height
Cisco Nexus 9364E-SG2-O	17.3 inches (43.94 cm)	24.70 inches (62.74 cm) without fan module and power supply module 26.26 inches (66.70 cm) with fan module and power supply module	3.43 inches (8.71 cm)

## Switch and Module Weights and Quantities

Component	Weight per Unit	Quantity
Cisco Nexus 9364E-SG2-O Chassis (N9364E-SG2-O)	34.18 lb (15.50 kg) without Fan module and Power supply module 44.86 lb (20.35kg) with Fan module and Power supply module	1
Fan Module – Port-side intake (burgundy) (FAN-PI-V4)	— 1.16 lb (1.53 kg)	4
Power Supply module – 3000-W AC/HVPI port-side intake (burgundy) (PSU3KW-HVPI)	— 3.02 lb (1.37 kg)	2 (1 for operations and 1 for redundancy)

## Transceiver and Cable Specifications

To see the transceiver specifications and installation information, see <https://www.cisco.com/c/en/us/support/interfaces-modules/transceiver-modules/products-device-support-tables-list.html>.

## Switch Power Input Requirements

This table lists the typical amount of power that the switch consumes. It also lists the maximum amount of power that you must provision for the switch and power supply for peak conditions.



**Note** Some power supplies have capabilities that are greater than the maximum power requirements for a switch. To determine the power consumption characteristics for the switch, use the typical and maximum requirements that are listed here.

Switch	Typical Power Consumption (AC or DC)	Maximum Power Consumption (AC or DC)	Heat Dissipation Requirement
Cisco Nexus 9364E-SG2-O	2029 W	2960 W	10096 BTUs per hour

## Power Specifications

Power specifications include the specifications for each type of power supply module.

### 3000-W AC Power Supply Specifications

These specifications apply to the PSU3KW-HVPI power supplies.

Property	Specification
Power	3000 W
Input Voltage	200-277 VAC
Frequency	50 to 60 Hz
Efficiency	90% or greater (20 to 100% load)
Redundancy Modes	Combined, $n+1$ , and $n+n$
RoHS Compliance	Yes
Hot Swappable	Yes
Airflow Direction	Port-side intake airflow

## Power Cable Specifications

These sections show the power cables that you can order and use with this switch.

### Power Cable Specifications for AC Power Supplies

Location	Part Number	Length	Power Cord Rating
Argentina	CAB-AC-16A-SG-AR	14 feet (4.26 m)	16A, 250 VAC

Location	Part Number	Length	Power Cord Rating
Australia	CAB-AC-16A-SG-AZ	14 feet (4.26 m)	16A, 250 VAC
Brazil	CAB-AC-16A-SG-BR	14 feet (4.26 m)	16A, 250 VAC
China	CAB-AC-16A-SG-CH CAB-AC-16A-CN	14 feet (4.26 m)	16A, 250 VAC
Europe	CAB-AC-16A-SG-EU	14 feet (4.26 m)	16A, 250 VAC
India	CAB-AC-16A-SG-IND	14 feet (4.26 m)	16A, 250 VAC
International / UK	CAB-AC-16A-SG-IN	14 feet (4.26 m)	16A, 250 VAC
Israel	CAB-AC-16A-SG-IS	14 feet (4.26 m)	16A, 250 VAC
Italy	CAB-AC-16A-SG-IT	14 feet (4.26 m)	16A, 250 VAC
Japan	CAB-AC-16A-SG-JP	14 feet (4.26 m)	16A, 250 VAC
South Africa	CAB-AC-16A-SG-SA	14 feet (4.26 m)	16A, 250 VAC
Switzerland	CAB-AC-16A-SG-SW	14 feet (4.26 m)	16A, 250 VAC
South Korea	CAB-AC-16A-SG-SK	14 feet (4.26 m)	16A, 250 VAC
United Kingdom	CAB-AC-16A-SG-UK	14 feet (4.26 m)	16A, 250 VAC
North America (non locking) 200-240 VAC operation	CAB-AC-20A-SG-US2	14 feet (4.26 m)	20A, 250 VAC
North America (locking) 200-240 VAC operation	CAB-AC-20A-SG-US3	14 feet (4.26 m)	20A, 250 VAC
North America 277 VAC operation	CAB-AC-20A-SG-US4	14 feet (4.26 m)	20A, 277 VAC
North America Cabinet Jumper Power Distribution Unit (PDU)	CAB-AC-20A-SG-C20	14 feet (4.26 m)	20A, 250 VAC

## HVAC/HVDC Power Cables

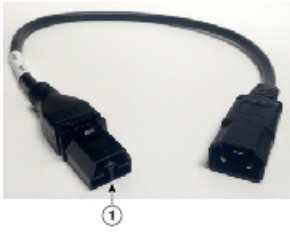
Part Number	Cord Set Description	Photo
CAB-HVAC-SD-0.6M	HVAC 2-foot (0.6 m) cable with Saf-D-Grid and SD connectors  277V AC	



Part Number	Cord Set Description	Photo
CAB-HVAC-C14-2M	HVAC 6.6-foot (2.0 m) cable with Saf-D-Grid and C14 (use for up to 240 V) connector 250V AC	
CAB-HVAC-RT-0.6M	HVAC 2-foot (0.6 m) cable with Saf-D-Grid and RT connector 277V AC	
NO-POWER-CORD	All except Argentina, Brazil, and Japan  No power cord included with switch	Not applicable

Table 2: HVAC/HVDC Power Cables Callout Table

1	Connect this end to the power supply unit.
---	--

## Regulatory Standards Compliance Specifications

This table lists the regulatory standards compliance for the switch.

Table 3: Regulatory Standards Compliance: Safety and EMC

Specification	Description
Regulatory compliance	Products should comply with CE Markings according to directives 2004/108/EC and 2006/95/EC.
Safety	<ul style="list-style-type: none"> <li>• CAN/CSA-C22.2 No. 60950-1 Second Edition</li> <li>• CAN/CSA-C22.2 No. 62368-1-19 Third Edition</li> <li>• ANSI/UL 60950-1 Second edition</li> <li>• IEC 62368-1</li> <li>• EN 62368-1</li> <li>• AS/NZS 62368-1</li> <li>• GB4943</li> <li>• UL 62368-1</li> </ul>

Specification	Description
EMC: Emissions	<ul style="list-style-type: none"> <li>• 47CFR Part 15 (CFR 47) Class A</li> <li>• AS/NZS CISPR22 Class A</li> <li>• CISPR22 Class A</li> <li>• EN55022 Class A</li> <li>• ICES003 Class A</li> <li>• VCCI Class A</li> <li>• EN61000-3-2</li> <li>• EN61000-3-3</li> <li>• KN22 Class A</li> <li>• CNS13438 Class A</li> </ul>
EMC: Immunity	<ul style="list-style-type: none"> <li>• EN55024</li> <li>• CISPR24</li> <li>• EN300386</li> <li>• KN 61000-4 series</li> </ul>
RoHS	The product is RoH-6 compliant with exceptions for leaded-ball grid-array (BGA) balls and lead press-fit connectors.



# APPENDIX C

## LEDs

- [Switch Chassis LEDs, on page 57](#)
- [Uplink Module LEDs, on page 58](#)
- [Fan Module LEDs, on page 58](#)
- [Power Supply LEDs, on page 59](#)

## Switch Chassis LEDs

The BCN, STS, and ENV, LEDs are located on the left side of the front of the switch. The port LEDs appear as triangles pointing up or down to the nearest port.

LED	Color	Status
BCN	Flashing blue	The operator has activated this LED to identify this switch in the chassis.
	Off	This switch is not being identified.
STS	Green	The switch is operational.
	Flashing amber	The switch is booting up.
	Amber	Temperature exceeds the minor alarm threshold.
	Red	Temperature exceeds the major alarm threshold.
	Off	The switch is not receiving power.
ENV	Green	Fans and power supply modules are operational.
	Amber	At least one fan or power supply module is not operating.
(port)	Green	Port admin state is 'Enabled', SFP is present and the interface is connected (that is, cabled, and the link is up).
	Amber	Port admin state is 'Disabled', or the SFP is absent, or both.
	Off	Port admin state is 'Enabled' and SFP is present, but interface is not connected.

LED	Color	Status
(GPS)	Green	GPS interface provisioned and ports are turned on. ToD, 1PPS, 10MHz are all valid.
	Off	Either the interface is not provisioned, or the ports are not turned on. ToD, 1PPS, 10MHz are not valid.

## Uplink Module LEDs

Each port has an LED. This content describes the LED port status.

**Table 4: Port Status LEDs (one per port)**

LED Color	Description
OFF	The port admin state is enabled, SFP is present, but the interface is not up
Amber	The port admin state is disabled, SFP is absent, or both
Green	The port admin state is enabled and the link is up

## Fan Module LEDs

LED	Color	Status
Status	Green	The fan module is operational.
	Red	The fan module is not operational (fan is probably not functional).
	Off	Fan module is not receiving power.

**Table 5: Fan LED**

Fan LED	Color	Status Description
Status	OFF	Fan tray is not receiving power
	Amber	The fan is inserted into the system and pending to come on-line
	Green	Fans are operating normally
	Flashing Amber	This fan tray has failed



## Power Supply LEDs

The power supply LEDs are located on the right portion of the power supply. Combinations of states indicated by the **OK** and **Fault** LEDs signify the status for the module as shown in this table.

Color	Status
Off	Power supply is not receiving power.
Green	Power Supply ON and power being delivered to system.
Flashing green	Power supply is connected to AC power source but not outputting power to the system.
Amber	Power supply failure—possibly one of these conditions: <ul style="list-style-type: none"><li>• Over voltage</li><li>• Over current</li><li>• Over temperature</li><li>• Fan failure</li></ul>
Flashing amber	Power supply is operating but a warning condition has occurred—possibly one of these conditions: <ul style="list-style-type: none"><li>• High temperature</li><li>• High power</li><li>• Slow fan</li></ul>

