



Replacing Modules

- [Replacing a Fan Module During Operations, on page 1](#)
- [Replacing a Power Supply Module, on page 3](#)

Replacing a Fan Module During Operations

There must always be at least two fan modules installed in the chassis to maintain the designed airflow. You can remove one fan module temporarily to replace it with another fan module but if the replacement fan module is not available, leave the original fan module in the chassis.

All fan and power supply modules must have the same airflow direction or else an error can occur with the switch overheating and shutting down. You can determine the airflow direction of a fan module by the color of the stripe on the front of the module. If the fan module has a blue stripe for port-side exhaust airflow, the power supplies must have blue or gray coloring for the same airflow direction. If the fan module has a burgundy stripe for port-side intake airflow, the power supplies must have burgundy or green coloring for the same airflow direction. If a power supply has white coloring, it can be used with fan modules using either port-side intake or port-side exhaust airflow. To avoid over heating the switch, make sure that the fan modules are positioned in one of the following ways:

- For port-side exhaust airflow with blue coloring, position the fan modules in a cold aisle.
- For port-side intake airflow with burgundy coloring, position the ports in a cold aisle.

Before you begin

Before you can replace a fan module, ensure that both of the following conditions exist:

- There is another functioning fan module in the chassis. In order to replace a fan module during operations, there must be another fan module circulating air in the chassis at all times.
- The replacement fan module must have the same airflow direction as the other modules in the chassis.

If you must replace the fan module during operations and both of the above conditions are not met, leave the fan module that you need to replace in the chassis to preserve the designed airflow until you have the required module.

Step 1 Remove the fan module that you need to replace as follows:

- a) Unscrew the captive screw that secures the fan module to the chassis (see the following figure).

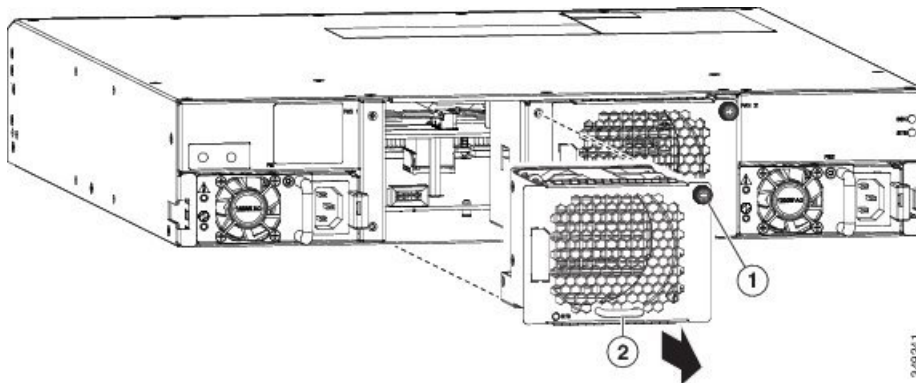

1	Loosen the captive screw so that it is no longer in contact with the chassis.	2	Holding the handle on the fan module, slide it out of the chassis.
---	---	---	--

- b) Pull the fan module handle to slide the module out of the chassis.

Caution To prevent electrostatic discharge (ESD) damage to the module electronics, do not touch the electrical connectors on the back side of the module. Also, to prevent any damage to the electrical connectors, prevent them touching anything that can bend or break them.

- c) Place the removed module on an antistatic surface or in an antistatic bag. If possible, repack the module in its packing materials for safe shipping or storage.

Step 2

Follow these steps to replace the missing fan module within two minutes to avoid a shutdown.

- a) Remove the replacement fan module from its packing materials and place it on an antistatic surface.

Hold the module by its handle and do not touch the electrical connectors on its backside. Also, to protect the electrical connectors, avoid letting them come in contact with anything other than the electrical connectors inside the chassis.

- b) Verify that you have the right fan module for the chassis. The correct fan module has one of the following part numbers:

- N9K-C9300-FAN3-B (port-side exhaust airflow direction and a blue stripe)
- N9K-C9300-FAN3 (port-side intake airflow direction and a burgundy stripe)

Note Be sure that the airflow direction of the new fan module matches the airflow direction of the other fan and AC power supply modules already installed in the chassis. Port-side intake airflow is indicated with burgundy or green coloring, and port-side exhaust airflow is indicated with blue or gray coloring. Power supplies with dual-direction airflow (airflow direction is set by the fan modules) have white coloring.

- c) Position the fan module in front of the open fan slot (be sure that the backside of the module with the electrical connectors is positioned to enter the slot first) and slide the module all the way into the chassis until its front side comes in contact with the chassis. For the last 0.2 inches (0.5 cm), carefully mount the module onto the chassis connectors by pushing more firmly, but do not force the module if it does not move further (excessive force can damage the connectors).

Note If you are not able to push the module all the way into the slot, carefully slide the module out of the slot and check its electrical connectors for damage. If damaged, contact Cisco Technical Assistance for help. If undamaged, repeat this step to reinstall the module.

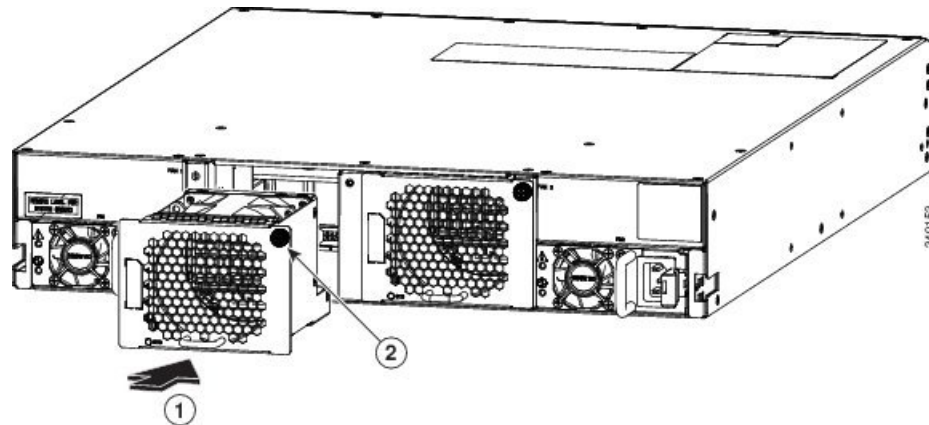

1	<p>Holding the handle on the fan module, slide its connector end into the fan slot until the front of the fan module is touching the chassis.</p>	2	<p>Screw in the captive screw to attach the module to the chassis.</p>
---	---	---	--

- d) Verify that the STS LED turns on and becomes green.

If the STS LED does not turn on, slide the module out of the chassis, and visually check the electrical connectors on the back side of the chassis for damage. If damaged, contact Cisco Technical Assistance for help. If undamaged, repeat the previous step to reinstall the module.

- e) Secure the fan module to the chassis by screwing in the captive screw to the chassis. Tighten the screw to 5 to 7 in-lb (0.56 to 0.79 N·m).

Replacing a Power Supply Module

The switch requires two power supplies for redundancy. With one power supply providing the necessary power for operations, you can replace the other power supply during operations so long as the new power supply has the same airflow direction as the other modules in the chassis.

You can replace a power supply with another supported power supply that has the same power source type (AC, DC, HVAC, or HVDC) and the same wattage rating as the other installed power supply. Additionally, the airflow direction of the power supply must match or conform to the airflow direction of the installed fan modules. For the airflow direction used by the switch, see the coloring of the fan modules. The following list describes the power supplies supported by this switch.



Note The power supplies are installed upside down with the release latch on the left side. If you are unable to slide a power supply into its slot in the chassis, turn the power supply over and try sliding it carefully into the slot again. When oriented correctly for the slot, you should be able to easily move the power supply all the way into its slot.

- NXA-PAC-650W-PE (650-W, port-side exhaust (blue latch) power supply requiring an AC power source)
- NXA-PAC-650W-PI (650-W, port-side intake (burgundy latch) power supply requiring an AC power source)

- N9K-PUV-1200W (1200-W, dual-direction (white latch) high-voltage AC/DC power supply requiring a high-voltage AC or DC power source)
- UCS-PSU-6332-DC (930-W, port-side exhaust (blue latch) power supply requiring DC power source)
- UCSC-PSU-930WDC (930-W, port-side intake (burgundy latch) power supply requiring DC power source)

Removing an AC Power Supply

To remove an AC power supply, you must first disconnect the power cable and then remove the module from the chassis.

Before you begin

- To replace a power supply during operations, you must have a functioning power supply providing power to the switch while you replace the other power supply. If there is only one power supply installed in the switch and you need to replace it, install the new power supply in the open slot and power it up before removing the original power supply.
- Ensure that the chassis is grounded. For grounding instructions, see [Grounding the Chassis](#).

Step 1 Pull the power cord out from the power receptacle on the power supply to be removed and verify that the  LED turns off.

Note The  LED might be on and amber colored to indicate that the input power has been disconnected.

Note If you need to remove an Anderson's Saf-D-Grid power cable connector from a high-voltage power supply, press the tab at the top of the connector and pull the connector out of the power supply.

Step 2 Remove the power supply from the chassis by pushing and holding its thumb latch to the left and pulling the power supply part way out of the chassis.

Step 3 Place your other hand under the power supply to support it while you slide it out of the chassis.
Either place the power supply on an antistatic surface or pack it in its packing materials.

Step 4 If the power supply slot is to remain empty, install a blank power supply filler panel (part number N2200-P-BLNK).

What to do next

You are ready to install the replacement power supply.

Removing an HVAC/HVDC Power Supply

You can remove one power supply while the other one provides power to the switch.

To disconnect the power supply from its power cables, you must shut off the power from the power source and then either disconnect a connector for the power cables or release each of three cables from the power supply (requires a standard screw driver).

-
- Step 1** Turn off the circuit breaker for the power feed to the power supply that you are replacing.
Be sure that the LEDs turn off on the power supply that you are removing.
- Step 2** Remove the power cable from the power supply by pressing the tab on the top of the Anderson Power SAF-D-Grid connector and pull the cable and connector out of the power supply.
- Step 3** Grasp the power supply handle while pressing the release latch towards the power supply handle.
- Step 4** Place your other hand under the power supply to support it while you slide it out of the chassis.
- Caution** Do not touch the electrical connectors on the back side of the module and prevent anything else from coming into contact with and damaging the connectors.
-

What to do next

You are ready to install an HVAC/HVDC power supply in the open slot.

Removing a DC Power Supply

You can remove one power supply while the other one provides power to the switch.

To disconnect the power supply from its power cables, you must shut off the power from the power source and then either disconnect a connector for the power cables or release each of three cables from the power supply (requires a standard screw driver).

-
- Step 1** Turn off the circuit breaker for the power feed to the power supply that you are replacing.
Be sure that the LEDs turn off on the power supply that you are removing.
- Step 2** Remove the power cable from the power supply by doing the following:
- To remove an orange power cable connector from a 48-V DC power supply, do the following:
 1. Push the orange plastic button on the top of the connector block inward toward the power supply.
 2. Pull the connector block out of the power supply.
 - To remove an Anderson Power Products Saf-D-Grid power cable connector from a high-voltage power supply, press on the tab at the top of the Saf-D-Grid connector and pull the connector out of the power supply.
- Step 3** Grasp the power supply handle while pressing the release latch towards the power supply handle.
- Step 4** Pull the power supply out of the bay.
-

What to do next

You are ready to install a DC power supply in the open slot.

Installing an AC Power Supply

You can replace one power supply while the other one provides power to the switch.

Before you begin

- The power supply that you are installing must be capable of using the same airflow direction as the fan trays installed in the same switch and it must use the same type of power source as the other power supply installed in the same switch (do not mix AC and DC power supplies in the same switch).



Note DC power supplies with green coloring have the same port-side intake airflow direction as the power supplies with red coloring, and DC power supplies with gray coloring have the same port-side exhaust airflow direction as the power supplies with blue coloring. HVAC/HVDC power supplies automatically use the same airflow direction as the installed fan modules. If the power supply that you are replacing has a different color handle than the replacement power supply, verify that it has or will have the same airflow direction as the other modules in the switch.

- An AC power source must be within reach of the power cable that will be used with the replacement power supply. If you are using $n+n$ power redundancy, there must be a separate power source for each power supply installed in the chassis. Otherwise, only one power source is required.
- There must be an earth ground connection to the chassis that you are installing the replacement module. Typically, the chassis is grounded by its metal-to-metal connection with a grounded rack. If you need to ground the chassis, see [Grounding the Chassis](#).

Step 1 Holding the replacement power supply with one hand underneath the module and the other hand holding the handle, turn the power supply so that its release latch is on the left side and align the back end of the power supply (the end with the electrical connections) to the open power supply slot before carefully sliding the power supply all the way into the slot until it clicks into place.

Note If the power supply does not fit into the open slot, turn the module over before sliding it carefully into the open slot.

Step 2 Test the installation by trying to pull the power supply out of the slot without using the release latch.

If the power supply does not move out of place, it is secured in the slot. If the power supply moves, carefully press it all the way into the slot until it clicks in place.

Step 3 Attach the power cable to the electrical outlet on the front of the power supply.

Step 4 Make sure that the other end of the power cable is attached to the appropriate power source for the power supply.

Note Depending on the outlet receptacle on your power distribution unit, you might need the optional jumper cable to connect the switch to your outlet receptacle.

- Step 5** Verify that the power supply is operational by making sure that the power supply  LED is green. For information on what the power supply LEDs indicate, see [Power Supply LEDs](#).

Installing an HVAC/HVDC Power Supply

You can replace one power supply while the other one provides power to the switch.



Note DC power supplies with green coloring have the same port-side intake airflow direction as the power supplies with red coloring, and DC power supplies with gray coloring have the same port-side exhaust airflow direction as the power supplies with blue coloring. HVAC/HVDC power supplies automatically use the same airflow direction as the installed fan modules. If the power supply that you are replacing has a different color handle than the replacement power supply, verify that it has or will have the same airflow direction as the other modules in the switch.

Before you begin

- If you are using DC power for the replacement power supply, the circuit breaker for the power feed to the power supply that you are replacing must be turned off.
- If you are using $n+n$ power redundancy, there must be a separate power source for each power supply installed in the chassis (power sources must be of the same type—do not mix AC and DC power sources for the same switch). Otherwise, only one power source is required.
- There must be an earth ground connection to the chassis that you are installing the replacement module. Typically, the chassis is grounded by its metal-to-metal connection to a grounded rack. If you need to ground this chassis by another means, see [Grounding the Chassis](#).

-
- Step 1** Holding the replacement power supply with one hand underneath the module and the other hand holding the handle, turn the power supply so that its release latch is on the left side and align the back end of the power supply (the end with the electrical connections) to the open power supply slot before carefully sliding the power supply all the way into the slot until it clicks into place.

Note If the power supply does not fit into the open slot, turn the module over before sliding it into the open slot.

- Step 2** Test the installation by trying to pull the power supply out of the slot without using the release latch.

If the power supply does not move out of place, it is secured in the slot. If the power supply moves, carefully press it all the way into the slot until it clicks in place.

- Step 3** If the DC power cables and a grounding cable are already connected to an electrical connector block, insert the block into the power receptacle on the power supply.

If the electrical cables have not been connected to the electrical connector block, wire them as described in [Wiring a 48 V DC Electrical Connector Block](#), on page 8.

- Step 4** Make sure that the other end of the power cable is connected to the appropriate power source for the power supply.

- Step 5** If using a DC power source, turn on the circuit breaker for the DC power source connected to the power supply.

- Step 6** Verify that the power supply is operational by making sure that the power supply  LED is green. For information on what the power supply LEDs indicate, see [Power Supply LEDs](#).
-

Installing a DC Power Supply

This topic is for installing the 48-V DC power supply into switch chassis. If you need to install a high voltage (HVAC/HVDC) power supply, see [Installing an HVAC/HVDC Power Supply, on page 7](#).

You can replace one power supply while the other one provides power to the switch.

Before you begin

- The circuit breaker for the DC power source for the power supply must be turned off.
- The power supply that you are installing must be capable of using the same airflow direction as the fan trays installed in the same switch
- A DC power source must be within reach of the power cable that will be used with the replacement power supply. If you are using $n+n$ power redundancy, there must be a separate power source for each power supply installed in the chassis (do not mix AC and DC power sources for the same switch). Otherwise, only one power source is required.
- There must be an earth ground connection to the chassis that you are installing the replacement module. Typically, the chassis is grounded by its metal-to-metal connection to a grounded rack. If you need to ground this chassis by another means, see [Grounding the Chassis](#).

-
- Step 1** Holding the replacement power supply with one hand underneath the module and the other hand holding the handle, turn the power supply so that its release latch is on the left side and align the back end of the power supply (the end with the electrical connections) to the open power supply slot before carefully sliding the power supply all the way into the slot until it clicks into place.

Note If the power supply does not fit into the open slot, turn the module over before carefully sliding it into the open slot.

- Step 2** If the DC power cables and a grounding cable are already connected to an electrical connector block, insert the block into the power receptacle on the power supply.
- If the electrical cables have not been connected to the electrical connector block, wire them as described in [Wiring a 48 V DC Electrical Connector Block, on page 8](#).

- Step 3** Turn on the circuit breaker for the DC power source connected to the power supply.

- Step 4** Verify that the power supply is operational by making sure that the power supply  LED is green. For information on what the power supply LEDs indicate, see [Power Supply LEDs](#).
-

Wiring a 48 V DC Electrical Connector Block

You must connect the ground, negative, and positive DC power cables to a connector block in order to connect the power cables to a 48 V DC power supply.



Note The recommended wire gauge is 8 AWG. The minimum wire gauge is 10 AWG.



Warning Statement 342—Before Connecting to System Power Supply
High leakage current earth connection essential before connecting to system power supply.



Warning Statement 1024—Ground Conductor
This equipment must be grounded. Never defeat the ground conductor or operate the equipment in the absence of a suitably installed ground conductor. Contact the appropriate electrical inspection authority or an electrician if you are uncertain that suitable grounding is available.

Before you begin

You must turn off the circuit breaker for the DC power cables that you are connecting to prevent electrocution.

- Step 1** Verify that the circuit breaker for the power feed to the replacement power supply is turned off.
- Step 2** Remove the DC power connector block from the power supply by doing the following:
 - a) Push the orange plastic button on the top of the connector block inward toward the power supply.
 - b) Pull the connector block out of the power supply.
- Step 3** Strip 0.6 inches (15 mm) of insulation off the DC wires that you are using.
- Step 4** Orient the connector as shown in the following figure with the orange plastic button on top.

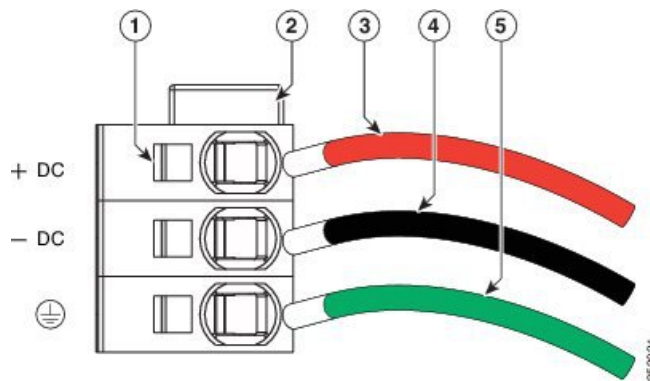

1	Wire retainer lever	4	-48V (-DC) cable
2	Orange plastic button on top of the connector	5	Grounding cable (8 AWG recommended)
3	-48V Return (+DC) cable		

- Step 5** Use a small screwdriver to depress the spring-loaded wire retainer lever on the lower spring-cage wire connector. Insert your green (ground) wire into the aperture and then release the lever.

- Step 6** Use a small screwdriver to depress the spring-loaded wire retainer lever on the middle spring-cage wire connector. Insert your black (DC negative) wire into the aperture and then release the lever.
- Step 7** Use a small screwdriver to depress the spring-loaded wire retainer lever on the upper spring-cage wire connector. Insert your red (DC positive) wire into the aperture and then release the lever.
- Step 8** Insert the connector block back into the power supply. Make sure that your red (DC positive) wire aligns with the power supply label, "+ DC".
- Step 9** Verify that the other ends of the cables are attached to the DC power source and ground. You are then ready to turn on the DC power source.
-