



## **Cisco Nexus 5000 Series NX-OS Layer 2 Switching Configuration Guide, Release 4.2(1)N2(1)**

### **Americas Headquarters**

Cisco Systems, Inc.  
170 West Tasman Drive  
San Jose, CA 95134-1706  
USA  
<http://www.cisco.com>  
Tel: 408 526-4000  
800 553-NETS (6387)  
Fax: 408 527-0883

Text Part Number: OL-20920-03

THE SPECIFICATIONS AND INFORMATION REGARDING THE PRODUCTS IN THIS MANUAL ARE SUBJECT TO CHANGE WITHOUT NOTICE. ALL STATEMENTS, INFORMATION, AND RECOMMENDATIONS IN THIS MANUAL ARE BELIEVED TO BE ACCURATE BUT ARE PRESENTED WITHOUT WARRANTY OF ANY KIND, EXPRESS OR IMPLIED. USERS MUST TAKE FULL RESPONSIBILITY FOR THEIR APPLICATION OF ANY PRODUCTS.

THE SOFTWARE LICENSE AND LIMITED WARRANTY FOR THE ACCOMPANYING PRODUCT ARE SET FORTH IN THE INFORMATION PACKET THAT SHIPPED WITH THE PRODUCT AND ARE INCORPORATED HEREIN BY THIS REFERENCE. IF YOU ARE UNABLE TO LOCATE THE SOFTWARE LICENSE OR LIMITED WARRANTY, CONTACT YOUR CISCO REPRESENTATIVE FOR A COPY.

The Cisco implementation of TCP header compression is an adaptation of a program developed by the University of California, Berkeley (UCB) as part of UCB's public domain version of the UNIX operating system. All rights reserved. Copyright © 1981, Regents of the University of California.

NOTWITHSTANDING ANY OTHER WARRANTY HEREIN, ALL DOCUMENT FILES AND SOFTWARE OF THESE SUPPLIERS ARE PROVIDED "AS IS" WITH ALL FAULTS. CISCO AND THE ABOVE-NAMED SUPPLIERS DISCLAIM ALL WARRANTIES, EXPRESSED OR IMPLIED, INCLUDING, WITHOUT LIMITATION, THOSE OF MERCHANTABILITY, FITNESS FOR A PARTICULAR PURPOSE AND NONINFRINGEMENT OR ARISING FROM A COURSE OF DEALING, USAGE, OR TRADE PRACTICE.

IN NO EVENT SHALL CISCO OR ITS SUPPLIERS BE LIABLE FOR ANY INDIRECT, SPECIAL, CONSEQUENTIAL, OR INCIDENTAL DAMAGES, INCLUDING, WITHOUT LIMITATION, LOST PROFITS OR LOSS OR DAMAGE TO DATA ARISING OUT OF THE USE OR INABILITY TO USE THIS MANUAL, EVEN IF CISCO OR ITS SUPPLIERS HAVE BEEN ADVISED OF THE POSSIBILITY OF SUCH DAMAGES.

Cisco and the Cisco Logo are trademarks of Cisco Systems, Inc. and/or its affiliates in the U.S. and other countries. A listing of Cisco's trademarks can be found at <http://cisco.com/go/trademarks>. Third party trademarks mentioned are the property of their respective owners. The use of the word partner does not imply a partnership relationship between Cisco and any other company. (1005R)

Any Internet Protocol (IP) addresses used in this document are not intended to be actual addresses. Any examples, command display output, and figures included in the document are shown for illustrative purposes only. Any use of actual IP addresses in illustrative content is unintentional and coincidental.

© 2010 Cisco Systems, Inc. All rights reserved.



## CONTENTS

### **Preface** **xiii**

Audience **xiii**

Document Organization **xiii**

Document Conventions **xiv**

Related Documentation for Nexus 5000 Series NX-OS Software **xv**

Obtaining Documentation and Submitting a Service Request **xvi**

### **New and Changed Information** **1**

New and Changed Information **1**

### **Overview** **3**

VLANs **3**

Private VLANs **3**

Spanning Tree **4**

STP Overview **4**

Rapid PVST+ **4**

MST **4**

STP Extensions **5**

### **Configuring Ethernet Interfaces** **7**

Information About Ethernet Interfaces **7**

About the Interface Command **7**

About the Unidirectional Link Detection Parameter **8**

UDLD Overview **8**

Default UDLD Configuration **9**

UDLD Aggressive and Nonaggressive Modes **9**

About Interface Speed **10**

About the Cisco Discovery Protocol **10**

Default CDP Configuration **10**

About the Error-Disabled State **11**

About the Debounce Timer Parameters **11**

About MTU Configuration	11
Configuring Ethernet Interfaces	12
Configuring the UDLD Mode	12
Configuring Interface Speed	13
Configuring the Cisco Discovery Protocol	14
Configuring the CDP Characteristics	14
Enabling or Disabling CDP	15
Enabling the Error-Disabled Detection	16
Enabling the Error-Disabled Recovery	17
Configuring the Error-Disabled Recovery Interval	18
Configuring the Debounce Timer	19
Configuring the Description Parameter	20
Disabling and Restarting Ethernet Interfaces	20
Displaying Interface Information	21
Default Physical Ethernet Settings	23
<b>Configuring VLANs</b>	<b>25</b>
Configuring VLANs	25
Information About VLANs	25
Understanding VLAN Ranges	25
Creating, Deleting, and Modifying VLANs	26
About the VLAN Trunking Protocol	27
Configuring a VLAN	27
Creating and Deleting a VLAN	27
Entering the VLAN Submode and Configuring the VLAN	28
Adding Ports to a VLAN	29
Configuring VTP	30
Verifying VLAN Configuration	31
<b>Configuring Private VLANs</b>	<b>33</b>
Information About Private VLANs	33
Primary and Secondary VLANs in Private VLANs	34
Private VLAN Ports	34
Primary, Isolated, and Community Private VLANs	35
Associating Primary and Secondary VLANs	36
Private VLAN Promiscuous Trunks	37
Private VLAN Isolated Trunks	37

Broadcast Traffic in Private VLANs	38
Private VLAN Port Isolation	38
Guidelines and Limitations for Private VLANs	38
Configuring a Private VLAN	38
Enabling Private VLANs	38
Configuring a VLAN as a Private VLAN	39
Associating Secondary VLANs with a Primary Private VLAN	40
Configuring an Interface as a Private VLAN Host Port	41
Configuring an Interface as a Private VLAN Promiscuous Port	42
Configuring a Promiscuous Trunk Port	43
Configuring an Isolated Trunk Port	44
Configuring the Allowed VLANs for PVLAN Trunking Ports	45
Configuring Native 802.1Q VLANs on Private VLANs	46
Verifying Private VLAN Configuration	47
<b>Configuring Access and Trunk Interfaces</b>	<b>49</b>
Information About Access and Trunk Interfaces	49
Understanding Access and Trunk Interfaces	49
Understanding IEEE 802.1Q Encapsulation	50
Understanding Access VLANs	50
Understanding the Native VLAN ID for Trunk Ports	51
Understanding Allowed VLANs	51
Understanding Native 802.1Q VLANs	51
Configuring Access and Trunk Interfaces	52
Configuring a LAN Interface as an Ethernet Access Port	52
Configuring Access Host Ports	53
Configuring Trunk Ports	54
Configuring the Native VLAN for 802.1Q Trunking Ports	54
Configuring the Allowed VLANs for Trunking Ports	55
Configuring Native 802.1Q VLANs	56
Verifying Interface Configuration	57
<b>Configuring EtherChannels</b>	<b>59</b>
Information About EtherChannels	59
Understanding EtherChannels	59
Compatibility Requirements	60
Load Balancing Using EtherChannels	61

Understanding LACP	63
LACP Overview	63
LACP ID Parameters	64
Channel Modes	65
LACP Marker Responders	66
LACP-Enabled and Static EtherChannels Differences	66
Configuring EtherChannels	66
Creating an EtherChannel	66
Adding a Port to an EtherChannel	67
Configuring Load Balancing Using EtherChannels	68
Configuring Hardware Hashing for Multicast Traffic	69
Enabling LACP	70
Configuring Channel Mode for a Port	71
Configuring the LACP Fast Timer Rate	72
Configuring the LACP System Priority and System ID	72
Configuring the LACP Port Priority	73
Verifying EtherChannel Configuration	74
Verifying the Load-Balancing Outgoing Port ID	75
<b>Configuring Virtual Port Channels</b>	<b>77</b>
Information About vPCs	77
vPC Overview	77
Terminology	79
vPC Terminology	79
Fabric Extender Terminology	79
Supported vPC Topologies	80
Cisco Nexus 5000 Series Switch vPC Topology	80
Single Homed Fabric Extender vPC Topology	80
Dual Homed Fabric Extender vPC Topology	81
vPC Domain	82
Peer-Keepalive Link and Messages	82
Compatibility Parameters for vPC Peer Links	83
Configuration Parameters That Must Be Identical	83
Configuration Parameters That Should Be Identical	84
vPC Peer Links	85
vPC Peer Link Overview	85

vPC Number	86
vPC Interactions with Other Features	87
vPC and LACP	87
vPC Peer Links and STP	87
CFSoSE	88
vPC Guidelines and Limitations	88
Configuring vPCs	89
Enabling vPCs	89
Disabling vPCs	89
Creating a vPC Domain	90
Configuring a vPC Keepalive Link	91
Creating a vPC Peer Link	92
Checking the Configuration Compatibility	93
Disabling the vPC Peer Link Compatibility Check	94
Creating an EtherChannel Host Interface	95
Moving Other EtherChannels into a vPC	96
Manually Configuring a vPC Domain MAC Address	97
Manually Configuring the System Priority	98
Manually Configuring a vPC Peer Switch Role	99
Verifying the vPC Configuration	100
vPC Example Configurations	101
Dual Homed Fabric Extender vPC Configuration Example	101
Single Homed Fabric Extender vPC Configuration Example	103
vPC Default Settings	105
<b>Configuring Rapid PVST+</b>	<b>107</b>
Information About Rapid PVST+	107
Understanding STP	108
STP Overview	108
Understanding How a Topology is Created	108
Understanding the Bridge ID	108
Bridge Priority Value	109
Extended System ID	109
STP MAC Address Allocation	109
Understanding BPDUs	110
Election of the Root Bridge	111

Creating the Spanning Tree Topology	111
Understanding Rapid PVST+	112
Rapid PVST+ Overview	112
Rapid PVST+ BPDUs	114
Proposal and Agreement Handshake	115
Protocol Timers	116
Port Roles	116
Port States	117
Rapid PVST+ Port State Overview	117
Blocking State	118
Learning State	118
Forwarding State	119
Disabled State	119
Summary of Port States	119
Synchronization of Port Roles	120
Processing Superior BPDU Information	120
Processing Inferior BPDU Information	121
Spanning-Tree Dispute Mechanism	121
Port Cost	121
Port Priority	122
Rapid PVST+ and IEEE 802.1Q Trunks	122
Rapid PVST+ Interoperation with Legacy 802.1D STP	122
Rapid PVST+ Interoperation with 802.1s MST	123
Configuring Rapid PVST+	123
Enabling Rapid PVST+	124
Enabling Rapid PVST+ per VLAN	124
Configuring the Root Bridge ID	125
Configuring a Secondary Root Bridge	126
Configuring the Rapid PVST+ Port Priority	127
Configuring the Rapid PVST+ Pathcost Method and Port Cost	128
Configuring the Rapid PVST+ Bridge Priority of a VLAN	129
Configuring the Rapid PVST+ Hello Time for a VLAN	130
Configuring the Rapid PVST+ Forward Delay Time for a VLAN	130
Configuring the Rapid PVST+ Maximum Age Time for a VLAN	131
Specifying the Link Type	131

Restarting the Protocol	132
Verifying Rapid PVST+ Configurations	132
<b>Configuring Multiple Spanning Tree</b>	<b>135</b>
Information About MST	135
MST Overview	135
MST Regions	136
MST BPDUs	136
MST Configuration Information	137
IST, CIST, and CST	137
IST, CIST, and CST Overview	137
Spanning Tree Operation Within an MST Region	138
Spanning Tree Operations Between MST Regions	138
MST Terminology	139
Hop Count	140
Boundary Ports	140
Spanning-Tree Dispute Mechanism	141
Port Cost and Port Priority	142
Interoperability with IEEE 802.1D	142
Interoperability with Rapid PVST+: Understanding PVST Simulation	143
Configuring MST	143
MST Configuration Guidelines	143
Enabling MST	143
Entering MST Configuration Mode	144
Specifying the MST Name	145
Specifying the MST Configuration Revision Number	146
Specifying the Configuration on an MST Region	146
Mapping and Unmapping VLANs to MST Instances	148
Mapping Secondary VLANs to Same MSTI as Primary VLANs for Private VLANs	149
Configuring the Root Bridge	150
Configuring a Secondary Root Bridge	151
Configuring the Port Priority	152
Configuring the Port Cost	152
Configuring the Switch Priority	153
Configuring the Hello Time	154
Configuring the Forwarding-Delay Time	155

Configuring the Maximum-Aging Time	155
Configuring the Maximum-Hop Count	156
Configuring PVST Simulation Globally	157
Configuring PVST Simulation Per Port	157
Specifying the Link Type	158
Restarting the Protocol	159
Verifying MST Configurations	159
<b>Configuring STP Extensions</b>	<b>161</b>
About STP Extensions	161
Information About STP Extensions	161
Understanding STP Port Types	161
Spanning Tree Edge Ports	161
Spanning Tree Network Ports	162
Spanning Tree Normal Ports	162
Understanding Bridge Assurance	162
Understanding BPDU Guard	162
Understanding BPDU Filtering	163
Understanding Loop Guard	164
Understanding Root Guard	164
Configuring STP Extensions	165
STP Extensions Configuration Guidelines	165
Configuring Spanning Tree Port Types Globally	165
Configuring Spanning Tree Edge Ports on Specified Interfaces	166
Configuring Spanning Tree Network Ports on Specified Interfaces	167
Enabling BPDU Guard Globally	168
Enabling BPDU Guard on Specified Interfaces	169
Enabling BPDU Filtering Globally	170
Enabling BPDU Filtering on Specified Interfaces	171
Enabling Loop Guard Globally	172
Enabling Loop Guard or Root Guard on Specified Interfaces	173
Verifying STP Extension Configuration	174
<b>Configuring LLDP</b>	<b>175</b>
Configuring Global LLDP Commands	175
Configuring Interface LLDP Commands	176
<b>Configuring the MAC Address Table</b>	<b>179</b>

Information About MAC Addresses	179
Configuring MAC Addresses	179
Configuring a Static MAC Address	179
Configuring the Aging Time for the MAC Table	180
Clearing Dynamic Addresses from the MAC Table	181
Verifying the MAC Address Configuration	181
<b>Configuring IGMP Snooping</b>	<b>183</b>
Information About IGMP Snooping	183
IGMPv1 and IGMPv2	184
IGMPv3	185
IGMP Snooping Querier	185
IGMP Forwarding	185
Configuring IGMP Snooping Parameters	186
Verifying IGMP Snooping Configuration	188
<b>Configuring Traffic Storm Control</b>	<b>191</b>
Information About Traffic Storm Control	191
Traffic Storm Guidelines and Limitations	192
Configuring Traffic Storm Control	193
Verifying Traffic Storm Control Configuration	193
Traffic Storm Control Example Configuration	194
Default Traffic Storm Settings	194
<b>Configuring the Fabric Extender</b>	<b>195</b>
Information About the Cisco Nexus 2000 Series Fabric Extender	195
Fabric Extender Terminology	196
Fabric Extender Features	197
Host Interfaces	197
Host	197
VLANs and Private VLANs	198
Virtual Port Channels	198
Fibre Channel over Ethernet Support	198
Protocol Offload	198
Quality of Service	198
Access Control Lists	199
IGMP Snooping	199
Switched Port Analyzer	199

Fabric Interface Features	200
Oversubscription	200
Management Model	201
Forwarding Model	202
Connection Model	202
Static Pinning Fabric Interface Connection	203
Fabric Interface Connection	204
Port Numbering Convention	204
Fabric Extender Image Management	205
Fabric Extender Hardware	205
Chassis	205
Ethernet Interfaces	205
Information About Associating a Fabric Extender to a Fabric Interface	206
Associating a Fabric Extender to an Ethernet Interface	206
Associating a Fabric Extender to a	207
Disassociating a Fabric Extender From an Interface	209
Configuring Fabric Extender Global Features	209
Enabling the Fabric Extender Locator LED	211
Redistributing the Links	211
Changing the Number of Links	211
Maintaining the Pinning Order	212
Redistributing Host Interfaces	212
Verifying Fabric Extender Configuration	212
Verifying Chassis Management Information	215



## Preface

---

This preface describes the audience, organization, and conventions of the *Cisco Nexus 5000 Series NX-OS Layer 2 Switching Configuration Guide*. It also provides information on how to obtain related documentation.

- [Audience, page xiii](#)
- [Document Organization, page xiii](#)
- [Document Conventions, page xiv](#)
- [Related Documentation for Nexus 5000 Series NX-OS Software, page xv](#)
- [Obtaining Documentation and Submitting a Service Request, page xvi](#)

## Audience

This preface describes the audience, organization, and conventions of the . It also provides information on how to obtain related documentation.

## Document Organization

This document is organized into the following chapters:

Chapter	Description
<b>New and Changed Information</b>	Describes the new and changed information for the new Cisco NX-OS software releases.
<b>Overview</b>	Describes the layer 2 documented features.
<b>Configuring Ethernet Interfaces</b>	Describes Ethernet interfaces and provides details on how to configure them.
<b>Configuring VLANs</b>	Provides details on configuring VLANs.
<b>Configuring Private VLANs</b>	Provides information on configuring private VLANs.
<b>Configuring Access and Trunk Interfaces</b>	Provides information about access ports or trunk ports and describes configuration procedures.

Chapter	Description
<b>Configuring EtherChannels</b>	Provides information about EtherChannels, compatibility requirements, and configuration information.
<b>Configuring Virtual Port Channels</b>	Provides information about vPCs, domains, guidelines and limitations, peer links, and configuration information.
<b>Configuring Rapid PVST+</b>	Provides information on IEEE 802.1D STP and complete details for configuring Rapid PVST+.
<b>Configuring Multiple Spanning Tree</b>	Provides complete information on configuring MST.
<b>Configuring STP Extensions</b>	Provides details on configuring the Cisco-proprietary STP extensions Bridge Assurance, BPDU Guard, BPDU Filtering, Loop Guard, Root Guard, and PVST Simulation.
<b>Configuring the MAC Address Table</b>	Provides information about MAC addresses, how to configure static MAC addresses, and how to update the MAC address table.
<b>Configuring IGMP Snooping</b>	Provides information about IGMPv1, IGMPv2, and IGMPv3 and describes how to configure IGMP snooping parameters.
<b>Configuring Traffic Storm Control</b>	Provides information about traffic storm control, guidelines and limitations, and how to configure the traffic storm control settings.

## Document Conventions

Command descriptions use the following conventions:

Convention	Description
<b>bold</b>	Bold text indicates the commands and keywords that you enter literally as shown.
<i>Italic</i>	Italic text indicates arguments for which the user supplies the values.
[x]	Square brackets enclose an optional element(keyword or argument).
[x   y]	Square brackets enclosing keywords or arguments separated by a vertical bar indicate an optional choice.
{x   y}	Braces enclosing keywords or arguments separated by a vertical bar indicate a required choice.
[x {y   z}]	Nested set of square brackets or braces indicate optional or required choices within optional or required elements. Braces and a vertical bar within square brackets indicate a required choice within an optional element.
<i>variable</i>	Indicates a variable for which you supply values, in context where italics cannot be used.

Convention	Description
string	A nonquoted set of characters. Do not use quotation marks around the string or the string will include the quotation marks.

Screen examples use the following conventions:

Convention	Description
<code>screen font</code>	Terminal sessions and information the switch displays are in screen font.
<b>boldface screen font</b>	Information you must enter is in boldface screen font.
<i>italic screen font</i>	Arguments for which you supply values are in italic screen font.
<>	Nonprinting characters, such as passwords, are in angle brackets.
[ ]	Default responses to system prompts are in square brackets.
!, #	An exclamation point (!) or a pound sign (#) at the beginning of a line of code indicates a comment line.

This document uses the following conventions:



**Note**

Means *reader take note*. Notes contain helpful suggestions or references to material not covered in the manual.



**Caution**

Means *reader be careful*. In this situation, you might do something that could result in equipment damage or loss of data.

## Related Documentation for Nexus 5000 Series NX-OS Software

Cisco NX-OS documentation is available at the following URL:

[http://www.cisco.com/en/US/products/ps9670/tsd\\_products\\_support\\_series\\_home.html](http://www.cisco.com/en/US/products/ps9670/tsd_products_support_series_home.html)

The documentation set for the Cisco Nexus 5000 Series NX-OS software includes the following documents:

### Release Notes

- *Cisco Nexus 5000 Series and Cisco Nexus 2000 Series Release Notes*
- *Cisco Nexus 5000 Series Switch Release Notes*

### Cisco Nexus 5000 Series NX-OS Configuration Guides

- *Cisco Nexus 5000 Series NX-OS Fibre Channel over Ethernet Configuration Guide*

- *Cisco Nexus 5000 Series NX-OS Layer 2 Switching Configuration Guide*
- *Cisco Nexus 5000 Series NX-OS Quality of Service Configuration Guide*
- *Cisco Nexus 5000 Series NX-OS SAN Switching Configuration Guide*
- *Cisco Nexus 5000 Series NX-OS Security Configuration Guide*
- *Cisco Nexus 5000 Series NX-OS System Management Configuration Guide*
- *Cisco Nexus 5000 Series Switch CLI Software Configuration Guide*
- *Cisco Nexus 5000 Series Fabric Manager Configuration Guide, Release 3.4(1a)*

### **Installation and Upgrade Guides**

- *Cisco Nexus 5000 Series Hardware Installation Guide*
- *Regulatory Compliance and Safety Information for the Cisco Nexus 5000 Series*

### **Cisco NX-OS Command References**

- *Cisco Nexus 5000 Series Command Reference*

### **Cisco NX-OS Technical References**

- *Cisco Nexus 5000 MIBs Reference*

### **Cisco NX-OS Error and System Messages**

- *Cisco NX-OS System Messages Reference*

## **Obtaining Documentation and Submitting a Service Request**

For information on obtaining documentation, submitting a service request, and gathering additional information, see the monthly *What's New in Cisco Product Documentation*, which also lists all new and revised Cisco technical documentation, at:

<http://www.cisco.com/en/US/docs/general/whatsnew/whatsnew.html>

Subscribe to the *What's New in Cisco Product Documentation* as a Really Simple Syndication (RSS) feed and set content to be delivered directly to your desktop using a reader application. The RSS feeds are a free service and Cisco currently supports RSS version 2.0.



# CHAPTER 1

## New and Changed Information

This chapter provides release-specific information for each new and changed feature in the *Cisco Nexus 5000 Series NX-OS Layer 2 Switching Configuration Guide*.

- [New and Changed Information, page 1](#)

## New and Changed Information

This chapter provides release-specific information for each new and changed feature in the *Cisco Nexus 5000 Series NX-OS Layer 2 Switching Configuration Guide*.

The latest version of this document is available at the following Cisco website:

[http://www.cisco.com/en/US/products/ps9670/products\\_installation\\_and\\_configuration\\_guides\\_list.html](http://www.cisco.com/en/US/products/ps9670/products_installation_and_configuration_guides_list.html)

To check for additional information about Cisco NX-OS, see the *Cisco Nexus 5000 Series NX-OS Release Notes* available at the following Cisco website:

[http://www.cisco.com/en/US/products/ps9670/prod\\_release\\_notes\\_list.html](http://www.cisco.com/en/US/products/ps9670/prod_release_notes_list.html)

This table summarizes the new and changed features documented in the *Cisco Nexus 5000 Series NX-OS Layer 2 Switching Configuration Guide, Release 4.2(1)N2(1)*, and tells you where they are documented.

**Table 1: New and Changed Layer 2 Switching Features for Cisco NX-OS Release 4.2(1)N2(1)**

Feature	Description	Changed in Release	Where to find it documented...
LACP Fast Timers	Added configuration information about LACP fast timers.	4.2(1)N2(1)	Configuring EtherChannels
Hardware Hashing for Multicast Traffic	Added configuration information about hardware hashing.	4.2(1)N2(1)	Configuring EtherChannels

This table summarizes the new and changed features documented in the *Cisco Nexus 5000 Series NX-OS Layer 2 Switching Configuration Guide, Release 4.2(1)N1(1)*, and tells you where they are documented.

**Table 2: New and Changed Layer 2 Switching Features for Cisco NX-OS Release 4.2(1)N1(1)**

Feature	Description	Changed in Release	Where to find it documented...
Error-Disabling Detection and Recovery	Added configuration information about the error-disabled state.	4.2(1)N1(1)	Configuring Ethernet Interfaces
VLAN Trunking Protocol	Added information about VTP transparent functionality.	4.2(1)N1(1)	Configuring VLANs

This table summarizes the new and changed features documented in the *Cisco Nexus 5000 Series NX-OS Layer 2 Switching Configuration Guide, Release 4.1(3)N2(1)*, and tells you where they are documented.

**Table 3: New and Changed Layer 2 Switching Features for Cisco NX-OS Release 4.1(3)N2(1)**

Feature	Description	Changed in Release	Where Documented
Disabling the vPC Peer Link Compatibility Check	Allows you to modify the default vPC behavior when a peer link is down.	4.1(3)N2(1)	Configuring vPC

### Documentation Organization

As of Cisco NX-OS Release 4.1(3)N2(1), the Nexus 5000 Series configuration information is available in new feature-specific configuration guides for the following information:

- System Management
- Layer 2 Switching
- SAN Switching
- Fibre Channel over Ethernet
- Security
- Quality of Service

The information in these new guides previously existed in the *Cisco Nexus 5000 Series NX-OS Configuration Guide* which remains available on Cisco.com and should be used for all software releases prior to Cisco Nexus 5000 NX-OS Software Rel 4.1(3). Each new configuration guide addresses the features that are introduced in or are available in a particular release. Select and view the configuration guide that pertains to the software installed in your switch.

The information in the new *Cisco Nexus 5000 Series NX-OS Layer 2 Switching Configuration Guide* previously existed in Part 2: LAN Switching of the *Cisco Nexus 5000 Series CLI Configuration Guide*.

For a complete list of Nexus 5000 Series document titles, see the list of Related Documentation in the "Preface."



## CHAPTER 2

# Overview

---

Cisco Nexus 5000 Series switches support the Layer 2 features that are described in this guide.

- [VLANs, page 3](#)
- [Private VLANs, page 3](#)
- [Spanning Tree, page 4](#)

## VLANs

A VLAN is a switched network that is logically segmented by function, project team, or application, without regard to the physical locations of the users. VLANs have the same attributes as physical LANs, but you can group end stations even if they are not physically located on the same LAN segment.

Any switch port can belong to a VLAN, and unicast, broadcast, and multicast packets are forwarded and flooded only to end stations in that VLAN. Each VLAN is considered as a logical network, and packets destined for stations that do not belong to the VLAN must be forwarded through a bridge or a router.

All ports, including the management port, are assigned to the default VLAN (VLAN1) when the device first comes up. A VLAN interface, or switched virtual interface (SVI), is a Layer 3 interface that is created to provide communication between VLANs.



**Note**

---

Inter-Switch Link (ISL) trunking is not supported on the NX-OS software for the Cisco Nexus 5000 Series devices.

---

## Private VLANs

Private VLANs provide traffic separation and security at the Layer 2 level.

A private VLAN is one or more pairs of a primary VLAN and a secondary VLAN, all with the same primary VLAN. The two types of secondary VLANs are isolated and community VLANs. Hosts on isolated VLANs communicate only with hosts in the primary VLAN. Hosts in a community VLAN can communicate only among themselves and with hosts in the primary VLAN but not with hosts in isolated VLANs or in other community VLANs.

Regardless of the combination of isolated and community secondary VLANs, all interfaces within the primary VLAN comprise one Layer 2 domain, and therefore, require only one IP subnet.

# Spanning Tree

This section discusses the implementation of the Spanning Tree Protocol (STP).

## STP Overview

STP provides a loop-free network at the Layer 2 level. Layer 2 LAN ports send and receive STP frames, which are called Bridge Protocol Data Units (BPDUs), at regular intervals. Network devices do not forward these frames but use the frames to construct a loop-free path.

802.1D is the original standard for STP, and many improvements have enhanced the basic loop-free STP. You can create a separate loop-free path for each VLAN, which is named Per VLAN Spanning Tree (PVST+). Additionally, the entire standard was reworked to make the loop-free convergence process faster to keep up with the faster equipment. This STP standard with faster convergence is the 802.1w standard, which is known as Rapid Spanning Tree (RSTP).

Finally, the 802.1s standard, Multiple Spanning Trees (MST), allows you to map multiple VLANs into a single spanning tree instance. Each instance runs an independent spanning tree topology.

Although the software can interoperate with legacy 802.1D systems, the system runs Rapid PVST+ and MST. You can use either Rapid PVST+ or MST in a given VDC; you cannot mix both in one VDC. Rapid PVST+ is the default STP protocol for Cisco NX-OS for the Nexus 5000 Series devices.

**Note**

---

Cisco NX-OS for the Nexus 5000 Series devices uses the extended system ID and MAC address reduction; you cannot disable these features.

---

In addition, Cisco has created some proprietary features to enhance the spanning tree activities.

## Rapid PVST+

Rapid PVST+ is the default spanning tree mode for the software and is enabled by default on the default VLAN and all newly created VLANs.

A single instance, or topology, of RSTP runs on each configured VLAN, and each Rapid PVST+ instance on a VLAN has a single root device. You can enable and disable STP on a per-VLAN basis when you are running Rapid PVST+.

## MST

The software also supports MST. The multiple independent spanning tree topologies enabled by MST provide multiple forwarding paths for data traffic, enable load balancing, and reduce the number of STP instances required to support a large number of VLANs.

MST incorporates RSTP, so it also allows rapid convergence. MST improves the fault tolerance of the network because a failure in one instance (forwarding path) does not affect other instances (forwarding paths).

**Note**

---

Changing the spanning tree mode disrupts the traffic because all spanning tree instances are stopped for the previous mode and started for the new mode.

---

## STP Extensions

The software supports the following Cisco proprietary features:

- Spanning tree port types—The default spanning tree port type is normal. You can configure interfaces connected to Layer 2 hosts as edge ports and interfaces connected to Layer 2 switches or bridges as network ports.
- Bridge Assurance—Once you configure a port as a network port, Bridge Assurance sends BPDUs on all ports and moves a port into the blocking state if it no longer receives BPDUs. This enhancement is available only when you are running Rapid PVST+ or MST.
- BPDU Guard—BPDU Guard shuts down the port if that port receives a BPDU.
- BPDU Filter—BPDU Filter suppresses sending and receiving BPDUs on the port.
- Loop Guard—Loop Guard prevents the nondesignated ports from transitioning to the STP forwarding state, which prevents loops in the network.
- Root Guard—Root Guard prevents the port from becoming the root in an STP topology.





## CHAPTER 3

# Configuring Ethernet Interfaces

---

This section describes the configuration of the Ethernet interfaces on a Cisco Nexus 5000 Series switch. It contains the following sections:

- [Information About Ethernet Interfaces, page 7](#)
- [Configuring Ethernet Interfaces, page 12](#)
- [Displaying Interface Information, page 21](#)

## Information About Ethernet Interfaces

The Ethernet ports can operate as standard Ethernet interfaces connected to servers or to a LAN.

The Ethernet interfaces also support Fibre Channel over Ethernet (FCoE). FCoE allows the physical Ethernet link to carry both Ethernet and Fibre Channel traffic.

On a Cisco Nexus 5000 Series switch, the Ethernet interfaces are enabled by default.

## About the Interface Command

You can enable the various capabilities of the Ethernet interfaces on a per-interface basis using the **interface** command. When you enter the **interface** command, you specify the following information:

- Interface type—All physical Ethernet interfaces use the **ethernet** keyword.
- Slot number
  - Slot 1 includes all the fixed ports.
  - Slot 2 includes the ports on the upper expansion module (if populated).
  - Slot 3 includes the ports on the lower expansion module (if populated).
- Port number
  - Port number within the group.

The interface numbering convention is extended to support use with a Cisco Nexus 2000 Series Fabric Extender as follows:

```
switch(config)# interface ethernet [chassis]/slot/port
```

- Chassis ID is an optional entry to address the ports of a connected Fabric Extender. The chassis ID is configured on a physical Ethernet or EtherChannel interface on the switch to identify the Fabric Extender discovered via the interface. The chassis ID ranges from 100 to 199.

## About the Unidirectional Link Detection Parameter

### UDLD Overview

The Cisco-proprietary Unidirectional Link Detection (UDLD) protocol allows ports that are connected through fiber optics or copper (for example, Category 5 cabling) Ethernet cables to monitor the physical configuration of the cables and detect when a unidirectional link exists. When the switch detects a unidirectional link, UDLD shuts down the affected LAN port and alerts the user. Unidirectional links can cause a variety of problems, including spanning tree topology loops.

UDLD is a Layer 2 protocol that works with the Layer 1 protocols to determine the physical status of a link. At Layer 1, autonegotiation takes care of physical signaling and fault detection. UDLD performs tasks that autonegotiation cannot perform, such as detecting the identities of neighbors and shutting down misconnected LAN ports. When you enable both autonegotiation and UDLD, Layer 1 and Layer 2 detections work together to prevent physical and logical unidirectional connections and the malfunctioning of other protocols.

A unidirectional link occurs whenever traffic transmitted by the local device over a link is received by the neighbor but traffic transmitted from the neighbor is not received by the local device. If one of the fiber strands in a pair is disconnected, as long as autonegotiation is active, the link does not stay up. In this case, the logical link is undetermined, and UDLD does not take any action. If both fibers are working normally at Layer 1, then UDLD at Layer 2 determines whether those fibers are connected correctly and whether traffic is flowing bidirectionally between the correct neighbors. This check cannot be performed by autonegotiation, because autonegotiation operates at Layer 1.

A Cisco Nexus 5000 Series switch periodically transmits UDLD frames to neighbor devices on LAN ports with UDLD enabled. If the frames are echoed back within a specific time frame and they lack a specific acknowledgment (echo), the link is flagged as unidirectional and the LAN port is shut down. Devices on both ends of the link must support UDLD in order for the protocol to successfully identify and disable unidirectional links.



---

**Note**

By default, UDLD is locally disabled on copper LAN ports to avoid sending unnecessary control traffic on this type of media.

---

The following figure shows an example of a unidirectional link condition. Device B successfully receives traffic from Device A on the port. However, Device A does not receive traffic from Device B on the same port. UDLD detects the problem and disables the port.

**Figure 1: Unidirectional Link**

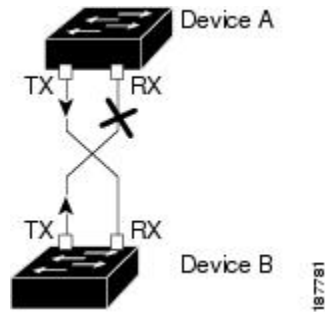

## Default UDLD Configuration

The following table shows the default UDLD configuration.

**Table 4: UDLD Default Configuration**

Feature	Default Value
UDLD global enable state	Globally disabled
UDLD aggressive mode	Disabled
UDLD per-port enable state for fiber-optic media	Enabled on all Ethernet fiber-optic LAN ports
UDLD per-port enable state for twisted-pair (copper) media	Disabled on all Ethernet 10/100 and 1000BASE-TX LAN ports

### Related Topics

- [Configuring the UDLD Mode, page 12](#)

## UDLD Aggressive and Nonaggressive Modes

UDLD aggressive mode is disabled by default. You can configure UDLD aggressive mode only on point-to-point links between network devices that support UDLD aggressive mode. If UDLD aggressive mode is enabled, when a port on a bidirectional link that has a UDLD neighbor relationship established stops receiving UDLD frames, UDLD tries to reestablish the connection with the neighbor. After eight failed retries, the port is disabled.

To prevent spanning tree loops, nonaggressive UDLD with the default interval of 15 seconds is fast enough to shut down a unidirectional link before a blocking port transitions to the forwarding state (with default spanning tree parameters).

When you enable the UDLD aggressive mode, the following occurs:

- One side of a link has a port stuck (both transmission and receive)
- One side of a link remains up while the other side of the link is down

In these cases, the UDLD aggressive mode disables one of the ports on the link, which prevents traffic from being discarded.

## About Interface Speed

A Cisco Nexus 5000 Series switch has a number of fixed 10-Gigabit ports, each equipped with SFP+ interface adapters. The Cisco Nexus 5010 switch has 20 fixed ports, the first 8 of which are switchable 1-Gigabit and 10-Gigabit ports. The Cisco Nexus 5020 switch has 40 fixed ports, the first 16 of which are switchable 1-Gigabit and 10-Gigabit ports.

## About the Cisco Discovery Protocol

The Cisco Discovery Protocol (CDP) is a device discovery protocol that runs over Layer 2 (the data link layer) on all Cisco-manufactured devices (routers, bridges, access servers, and switches) and allows network management applications to discover Cisco devices that are neighbors of already known devices. With CDP, network management applications can learn the device type and the Simple Network Management Protocol (SNMP) agent address of neighboring devices running lower-layer, transparent protocols. This feature enables applications to send SNMP queries to neighboring devices.

CDP runs on all media that support Subnetwork Access Protocol (SNAP). Because CDP runs over the data-link layer only, two systems that support different network-layer protocols can learn about each other.

Each CDP-configured device sends periodic messages to a multicast address, advertising at least one address at which it can receive SNMP messages. The advertisements also contain time-to-live, or holdtime information, which is the length of time a receiving device holds CDP information before discarding it. Each device also listens to the messages sent by other devices to learn about neighboring devices.

The switch supports both CDP Version 1 and Version 2.

## Default CDP Configuration

The following table shows the default CDP configuration.

**Table 5: Default CDP Configuration**

Feature	Default Setting
CDP interface state	Enabled
CDP timer (packet update frequency)	60 seconds
CDP holdtime (before discarding)	180 seconds
CDP Version-2 advertisements	Enabled

## About the Error-Disabled State

An interface is in the error-disabled (err-disabled) state when the interface is enabled administratively (using the **no shutdown** command) but disabled at runtime by any process. For example, if UDLD detects a unidirectional link, the interface is shut down at runtime. However, because the interface is administratively enabled, the interface status displays as err-disabled. Once an interface goes into the err-disabled state, you must manually reenabling it or you can configure an automatic timeout recovery value. The err-disabled detection is enabled by default for all causes. The automatic recovery is not configured by default.

When an interface is in the err-disabled state, use the **errdisable detect cause** command to find information about the error.

You can configure the automatic err-disabled recovery timeout for a particular err-disabled cause by changing the time variable.

The **errdisable recovery cause** command provides automatic recovery after 300 seconds. To change the recovery period, use the **errdisable recovery interval** command to specify the timeout period. You can specify 30 to 65535 seconds.

If you do not enable the err-disabled recovery for the cause, the interface stays in the err-disabled state until you enter the **shutdown** and **no shutdown** commands. If the recovery is enabled for a cause, the interface is brought out of the err-disabled state and allowed to retry operation once all the causes have timed out. Use the **show interface status err-disabled** command to display the reason behind the error.

## About the Debounce Timer Parameters

The port debounce time is the amount of time that an interface waits to notify the supervisor of a link going down. During this time, the interface waits to see if the link comes back up. The wait period is a time when traffic is stopped.

You can enable the debounce timer for each interface and specify the delay time in milliseconds.



### Caution

---

When you enable the port debounce timer the link up and link down detections are delayed, resulting in a loss of traffic during the debounce period. This situation might affect the convergence and reconvergence of some protocols.

---

## About MTU Configuration

The Cisco Nexus 5000 Series switch is a Layer 2 device. This means it does not fragment frames. As a result, the switch cannot have two ports in the same Layer 2 domain with different maximum transmission units (MTUs). A per-physical Ethernet interface MTU is not supported. Instead, the MTU is set according to the QoS classes. You modify the MTU by setting Class and Policy maps.



### Note

---

When you show the interface settings, a default MTU of 1500 is displayed for physical Ethernet interfaces and a receive data field size of 2112 is displayed for Fibre Channel interfaces.

---

# Configuring Ethernet Interfaces

## Configuring the UDLD Mode

You can configure normal or aggressive unidirectional link detection (UDLD) modes for Ethernet interfaces on devices configured to run UDLD. Before you can enable a UDLD mode for an interface, you must make sure that UDLD is already enabled on the device that includes the interface. UDLD must also be enabled on the other linked interface and its device.

To use the normal UDLD mode, you must configure one of the ports for normal mode and configure the other port for the normal or aggressive mode. To use the aggressive UDLD mode, you must configure both ports for the aggressive mode.

**Note**

Before you begin, UDLD must be enabled for the other linked port and its device.

To configure the UDLD mode, perform this task:

### SUMMARY STEPS

1. switch# **configure terminal**
2. switch(config)# **feature udld**
3. switch(config)# **no feature udld**
4. switch(config)# **show udld global**
5. switch(config)# **interface** *type slot/port*
6. switch(config-if)# **udld** {**enable** | **disable** | **aggressive**}
7. switch(config-if)# **show udld interface**

### DETAILED STEPS

	Command or Action	Purpose
<b>Step 1</b>	switch# <b>configure terminal</b>	Enters configuration mode.
<b>Step 2</b>	switch(config)# <b>feature udld</b>	Enables UDLD for the device.
<b>Step 3</b>	switch(config)# <b>no feature udld</b>	Disables UDLD for the device.
<b>Step 4</b>	switch(config)# <b>show udld global</b>	Displays the UDLD status for the device.
<b>Step 5</b>	switch(config)# <b>interface</b> <i>type slot/port</i>	Specifies an interface to configure, and enters interface configuration mode.
<b>Step 6</b>	switch(config-if)# <b>udld</b> { <b>enable</b>   <b>disable</b>   <b>aggressive</b> }	Enables the normal UDLD mode, disables UDLD, or enables the aggressive UDLD mode.
<b>Step 7</b>	switch(config-if)# <b>show udld interface</b>	Displays the UDLD status for the interface.

This example shows how to enable the UDLD for the switch:

```
switch# configure terminal
switch(config)# feature udld
```

This example shows how to enable the normal UDLD mode for an Ethernet port:

```
switch# configure terminal
switch(config)# interface ethernet 1/4
switch(config-if)# udld enable
```

This example shows how to enable the aggressive UDLD mode for an Ethernet port:

```
switch# configure terminal
switch(config)# interface ethernet 1/4
switch(config-if)# udld aggressive
```

This example shows how to disable UDLD for an Ethernet port:

```
switch# configure terminal
switch(config)# interface ethernet 1/4
switch(config-if)# udld disable
```

This example shows how to disable UDLD for the switch:

```
switch# configure terminal
switch(config)# no feature udld
```

## Configuring Interface Speed

The first 8 ports of a Cisco Nexus 5010 switch and the first 16 ports of a Cisco Nexus 5020 switch are switchable 1-Gigabit and 10-Gigabit ports. The default interface speed is 10-Gigabit. To configure these ports for 1-Gigabit Ethernet, insert a 1-Gigabit Ethernet SFP transceiver into the applicable port and then set its speed with the **speed** command.

To configure a 1-Gigabit Ethernet port, perform this task:

### SUMMARY STEPS

1. switch# **configure terminal**
2. switch(config)# **interface** *type slot/port*
3. switch(config-if)# **speed** *speed*

### DETAILED STEPS

	Command or Action	Purpose
<b>Step 1</b>	switch# <b>configure terminal</b>	Enters configuration mode.
<b>Step 2</b>	switch(config)# <b>interface</b> <i>type slot/port</i>	Enters interface configuration mode for the specified interface. This interface must have a 1-Gigabit Ethernet SFP transceiver inserted into it.
<b>Step 3</b>	switch(config-if)# <b>speed</b> <i>speed</i>	Sets the speed on the interface.

The following example shows how to set the speed for a 1-Gigabit Ethernet port:

```
switch# configure terminal
switch(config)# interface ethernet 1/4
switch(config-if)# speed 1000
```

This command can only be applied to a physical Ethernet interface.



**Note**

If the interface and transceiver speed is mismatched, the SFP validation failed message is displayed when you enter the **show interface ethernet slot/port** command. For example, if you insert a 1-Gigabit SFP transceiver into a port without configuring the speed 1000 command, you will get this error. By default, all ports are 10 Gigabits.

## Configuring the Cisco Discovery Protocol

### Configuring the CDP Characteristics

You can configure the frequency of Cisco Discovery Protocol (CDP) updates, the amount of time to hold the information before discarding it, and whether or not to send Version-2 advertisements.

To configure CDP characteristics for an interface, perform this task:

#### SUMMARY STEPS

1. switch# **configure terminal**
2. (Optional) switch(config)# **[no] cdp advertise {v1 | v2 }**
3. (Optional) switch(config)# **[no] cdp format device-id {mac-address | serial-number | system-name}**
4. (Optional) switch(config)# **[no] cdp holdtime seconds**
5. (Optional) switch(config)# **[no] cdp timer seconds**

#### DETAILED STEPS

	Command or Action	Purpose
<b>Step 1</b>	switch# <b>configure terminal</b>	Enters configuration mode.
<b>Step 2</b>	switch(config)# <b>[no] cdp advertise {v1   v2 }</b>	(Optional) Configures the version to use to send CDP advertisements. Version-2 is the default state.  Use the <b>no</b> form of the command to return to its default setting.
<b>Step 3</b>	switch(config)# <b>[no] cdp format device-id {mac-address   serial-number   system-name}</b>	(Optional) Configures the format of the CDP device ID. The default is the system name, which can be expressed as a fully qualified domain name.  Use the <b>no</b> form of the command to return to its default setting.

	Command or Action	Purpose
<b>Step 4</b>	switch(config)# [no] cdp holdtime <i>seconds</i>	(Optional) Specifies the amount of time a receiving device should hold the information sent by your device before discarding it. The range is 10 to 255 seconds; the default is 180 seconds.  Use the <b>no</b> form of the command to return to its default setting.
<b>Step 5</b>	switch(config)# [no] cdp timer <i>seconds</i>	(Optional) Sets the transmission frequency of CDP updates in seconds. The range is 5 to 254; the default is 60 seconds.  Use the <b>no</b> form of the command to return to its default setting.

This example shows how to configure CDP characteristics:

```
switch# configure terminal
switch(config)# cdp timer 50
switch(config)# cdp holdtime 120
switch(config)# cdp advertise v2
```

## Enabling or Disabling CDP

You can enable or disable CDP for Ethernet interfaces. This protocol works only when you have it enabled on both interfaces on the same link.

To enable or disable CDP for an interface, perform this task:

### SUMMARY STEPS

1. switch# **configure terminal**
2. switch(config)# **interface** *type slot/port*
3. switch(config-if)# **cdp enable**
4. switch(config-if)# **no cdp enable**

### DETAILED STEPS

	Command or Action	Purpose
<b>Step 1</b>	switch# <b>configure terminal</b>	Enters configuration mode.
<b>Step 2</b>	switch(config)# <b>interface</b> <i>type slot/port</i>	Enters interface configuration mode for the specified interface.
<b>Step 3</b>	switch(config-if)# <b>cdp enable</b>	Enables CDP for the interface.  To work correctly, this parameter must be enabled for both interfaces on the same link.
<b>Step 4</b>	switch(config-if)# <b>no cdp enable</b>	Disables CDP for the interface.

The following example shows how to enable CDP for an Ethernet port:

```
switch# configure terminal
switch(config)# interface ethernet 1/4
switch(config-if)# cdp enable
```

This command can only be applied to a physical Ethernet interface.

## Enabling the Error-Disabled Detection

You can enable error-disable (err-disabled) detection in an application. As a result, when a cause is detected on an interface, the interface is placed in an err-disabled state, which is an operational state that is similar to the link-down state.

### SUMMARY STEPS

1. **config t**
2. **errdisable detect cause** *{all | link-flap | loopback}*
3. **shutdown**
4. **no shutdown**
5. **show interface status err-disabled**
6. **copy running-config startup-config**

### DETAILED STEPS

	Command or Action	Purpose
<b>Step 1</b>	<b>config t</b>  <b>Example:</b> switch# config t switch(config)#	Enters configuration mode.
<b>Step 2</b>	<b>errdisable detect cause</b> <i>{all   link-flap   loopback}</i>  <b>Example:</b> switch(config)# errdisable detect cause all switch(config)#	Specifies a condition under which to place the interface in an err-disabled state. The default is enabled.
<b>Step 3</b>	<b>shutdown</b>  <b>Example:</b> switch(config)# shutdown switch(config)#	Brings the interface down administratively. To manually recover the interface from the err-disabled state, enter this command first.
<b>Step 4</b>	<b>no shutdown</b>  <b>Example:</b> switch(config)# no shutdown switch(config)#	Brings the interface up administratively and enables the interface to recover manually from the err-disabled state.

	Command or Action	Purpose
<b>Step 5</b>	<b>show interface status err-disabled</b>  <b>Example:</b> switch(config)# show interface status err-disabled	Displays information about err-disabled interfaces.
<b>Step 6</b>	<b>copy running-config startup-config</b>  <b>Example:</b> switch(config)# copy running-config startup-config	(Optional) Copies the running configuration to the startup configuration.

This example shows how to enable the err-disabled detection in all cases:

```
switch(config)#errdisable detect cause all
switch(config)#
```

## Enabling the Error-Disabled Recovery

You can specify the application to bring the interface out of the error-disabled (err-disabled) state and retry coming up. It retries after 300 seconds, unless you configure the recovery timer (see the **errdisable recovery interval** command).

### SUMMARY STEPS

1. **config t**
2. **errdisable recovery cause {all | uddl | bpduguard | link-flap | failed-port-state | pause-rate-limit}**
3. **show interface status err-disabled**
4. **copy running-config startup-config**

### DETAILED STEPS

	Command or Action	Purpose
<b>Step 1</b>	<b>config t</b>  <b>Example:</b> switch#config t switch(config)#	Enters configuration mode.
<b>Step 2</b>	<b>errdisable recovery cause {all   uddl   bpduguard   link-flap   failed-port-state   pause-rate-limit}</b>  <b>Example:</b> switch(config)#errdisable recovery cause all switch(config-if)#	Specifies a condition under which the interface automatically recovers from the err-disabled state, and the device retries bringing the interface up. The device waits 300 seconds to retry. The default is disabled.

	Command or Action	Purpose
<b>Step 3</b>	<b>show interface status err-disabled</b>  <b>Example:</b> switch(config)#show interface status err-disabled	Displays information about err-disabled interfaces.
<b>Step 4</b>	<b>copy running-config startup-config</b>  <b>Example:</b> switch(config)#copy running-config startup-config	(Optional) Copies the running configuration to the startup configuration.

This example shows how to enable err-disabled recovery under all conditions:

```
switch(config)#errdisable recovery cause all
switch(config)#
```

## Configuring the Error-Disabled Recovery Interval

You can use this procedure to configure the err-disabled recovery timer value. The range is from 30 to 65535 seconds. The default is 300 seconds.

### SUMMARY STEPS

1. **config t**
2. **errdisable recovery interval *interval***
3. **show interface status err-disabled**
4. **copy running-config startup-config**

### DETAILED STEPS

	Command or Action	Purpose
<b>Step 1</b>	<b>config t</b>  <b>Example:</b> switch# <b>config t</b> switch(config)#	Enters configuration mode.
<b>Step 2</b>	<b>errdisable recovery interval <i>interval</i></b>  <b>Example:</b> switch(config)# <b>errdisable recovery interval 32</b> switch(config-if)#	Specifies the interval for the interface to recover from the err-disabled state. The range is from 30 to 65535 seconds. The default is 300 seconds.
<b>Step 3</b>	<b>show interface status err-disabled</b>  <b>Example:</b> switch(config)# <b>show interface status err-disabled</b>	Displays information about err-disabled interfaces.

	Command or Action	Purpose
<b>Step 4</b>	<b>copy running-config startup-config</b>  <b>Example:</b> switch(config)# <b>copy running-config startup-config</b>	(Optional) Copies the running configuration to the startup configuration.

This example shows how to enable err-disabled recovery under all conditions:

```
switch(config)#errdisable recovery cause all
switch(config)#
```

## Configuring the Debounce Timer

You can enable the debounce timer for Ethernet ports by specifying a debounce time (in milliseconds) or disable the timer by specifying a debounce time of 0.

You can show the debounce times for all of the Ethernet ports by using the **show interface debounce** command.

To enable or disable the debounce timer, perform this task:

### SUMMARY STEPS

1. switch# **configure terminal**
2. switch(config)# **interface** *type slot/port*
3. switch(config-if)# **link debounce time** *milliseconds*

### DETAILED STEPS

	Command or Action	Purpose
<b>Step 1</b>	switch# <b>configure terminal</b>	Enters configuration mode.
<b>Step 2</b>	switch(config)# <b>interface</b> <i>type slot/port</i>	Enters interface configuration mode for the specified interface.
<b>Step 3</b>	switch(config-if)# <b>link debounce time</b> <i>milliseconds</i>	Enables the debounce timer for the amount of time (1 to 5000 milliseconds) specified.  Disables the debounce timer if you specify 0 milliseconds.

This example shows how to enable the debounce timer and set the debounce time to 1000 milliseconds for an Ethernet interface:

```
switch# configure terminal
switch(config)# interface ethernet 1/4
switch(config-if)# link debounce time 1000
```

This example shows how to disable the debounce timer for an Ethernet interface:

```
switch# configure terminal
switch(config)# interface ethernet 1/4
switch(config-if)# link debounce time 0
```

This command can only be applied to a physical Ethernet interface.

## Configuring the Description Parameter

To provide textual interface descriptions for the Ethernet ports, perform this task:

### SUMMARY STEPS

1. switch# **configure terminal**
2. switch(config)# **interface** *type slot/port*
3. switch(config-if)# **description** *test*

### DETAILED STEPS

	Command or Action	Purpose
<b>Step 1</b>	switch# <b>configure terminal</b>	Enters configuration mode.
<b>Step 2</b>	switch(config)# <b>interface</b> <i>type slot/port</i>	Enters interface configuration mode for the specified interface.
<b>Step 3</b>	switch(config-if)# <b>description</b> <i>test</i>	Specifies the description for the interface.

This example shows how to set the interface description to "Server 3 Interface."

```
switch# configure terminal
switch(config)# interface ethernet 1/3
switch(config-if)# description Server 3 Interface
```

## Disabling and Restarting Ethernet Interfaces

You can shut down and restart an Ethernet interface. This action disables all of the interface functions and marks the interface as being down on all monitoring displays.

To disable an interface, perform this task:

### SUMMARY STEPS

1. switch# **configure terminal**
2. switch(config)# **interface** *type slot/port*
3. switch(config-if)# **shutdown**
4. switch(config-if)# **no shutdown**

### DETAILED STEPS

	Command or Action	Purpose
<b>Step 1</b>	switch# <b>configure terminal</b>	Enters configuration mode.

	Command or Action	Purpose
<b>Step 2</b>	switch(config)# <b>interface</b> <i>type slot/port</i>	Enters interface configuration mode for the specified interface.
<b>Step 3</b>	switch(config-if)# <b>shutdown</b>	Disables the interface.
<b>Step 4</b>	switch(config-if)# <b>no shutdown</b>	Restarts the interface.

The following example shows how to disable an Ethernet port:

```
switch# configure terminal
switch(config)# interface ethernet 1/4
switch(config-if)# shutdown
```

The following example shows how to restart an Ethernet interface:

```
switch# configure terminal
switch(config)# interface ethernet 1/4
switch(config-if)# no shutdown
```

## Displaying Interface Information

To view configuration information about the defined interfaces, perform one of these tasks:

Command	Purpose
switch# <b>show interface</b> <i>type slot/port</i>	Displays the detailed configuration of the specified interface.
switch# <b>show interface</b> <i>type slot/port capabilities</i>	Displays detailed information about the capabilities of the specified interface. This option is only available for physical interfaces
switch# <b>show interface</b> <i>type slot/port transceiver</i>	Displays detailed information about the transceiver connected to the specified interface. This option is only available for physical interfaces.
switch# <b>show interface brief</b>	Displays the status of all interfaces.
switch# <b>show interface debounce</b>	Displays the debounce status of all interfaces.
switch# <b>show interface flowcontrol</b>	Displays the detailed listing of the flow control settings on all interfaces.

The **show interface** command is invoked from EXEC mode and displays the interface configurations. Without any arguments, this command displays the information for all the configured interfaces in the switch.

The following example shows how to display the physical Ethernet interface:

```
switch# show interface ethernet 1/1
Ethernet1/1 is up
  Hardware is 1000/10000 Ethernet, address is 000d.eca3.5f08 (bia 000d.eca3.5f08)
  MTU 1500 bytes, BW 10000000 Kbit, DLY 10 usec,
    reliability 255/255, txload 190/255, rxload 192/255
  Encapsulation ARPA
  Port mode is trunk
  full-duplex, 10 Gb/s, media type is 1/10g
  Input flow-control is off, output flow-control is off
  Auto-mdix is turned on
  Rate mode is dedicated
  Switchport monitor is off
  Last clearing of "show interface" counters never
  5 minute input rate 942201806 bytes/sec, 14721892 packets/sec
  5 minute output rate 935840313 bytes/sec, 14622492 packets/sec
Rx
  129141483840 input packets 0 unicast packets 129141483847 multicast packets
  0 broadcast packets 0 jumbo packets 0 storm suppression packets
  8265054965824 bytes
  0 No buffer 0 runt 0 Overrun
  0 crc 0 Ignored 0 Bad etype drop
  0 Bad proto drop
Tx
  119038487241 output packets 119038487245 multicast packets
  0 broadcast packets 0 jumbo packets
  7618463256471 bytes
  0 output CRC 0 ecc
  0 underrun 0 if down drop      0 output error 0 collision 0 deferred
  0 late collision 0 lost carrier 0 no carrier
  0 babble
  0 Rx pause 8031547972 Tx pause 0 reset
```

The following example shows how to display the physical Ethernet capabilities:

```
switch# show interface ethernet 1/1 capabilities
Ethernet1/1
  Model: 734510033
  Type: 10Gbase-(unknown)
  Speed: 1000,10000
  Duplex: full
  Trunk encap. type: 802.1Q
  Channel: yes
  Broadcast suppression: percentage(0-100)
  Flowcontrol: rx-(off/on),tx-(off/on)
  Rate mode: none
  QOS scheduling: rx-(6q1t),tx-(1p6q0t)
  CoS rewrite: no
  ToS rewrite: no
  SPAN: yes
  UDLD: yes
  Link Debounce: yes
  Link Debounce Time: yes
  MDIX: no
  FEX Fabric: yes
```

The following example shows how to display the physical Ethernet transceiver:

```
switch# show interface ethernet 1/1 transceiver
Ethernet1/1
  sfp is present
  name is CISCO-EXCELIGHT
  part number is SPP5101SR-C1
  revision is A
  serial number is ECL120901AV
  nominal bitrate is 10300 MBits/sec
  Link length supported for 50/125mm fiber is 82 m(s)
  Link length supported for 62.5/125mm fiber is 26 m(s)
  cisco id is --
  cisco extended id number is 4
```

The following example shows how to display a brief interface status (some of the output has been removed for brevity):

```
switch# show interface brief
```

```
-----
Ethernet      VLAN   Type Mode   Status Reason                               Speed   Port
Interface                                           Ch #
-----
Eth1/1        200    eth  trunk up     none                               10G(D) --
Eth1/2        1      eth  trunk up     none                               10G(D) --
Eth1/3        300    eth  access down SFP not inserted                 10G(D) --
Eth1/4        300    eth  access down SFP not inserted                 10G(D) --
Eth1/5        300    eth  access down Link not connected               1000(D) --
Eth1/6        20     eth  access down Link not connected               10G(D) --
Eth1/7        300    eth  access down SFP not inserted                 10G(D) --
...

```

The following example shows how to display the link debounce status (some of the output has been removed for brevity):

```
switch# show interface debounce
```

```
-----
Port          Debounce time  Value(ms)
-----
...
Eth1/1        enable         100
Eth1/2        enable         100
Eth1/3        enable         100
...

```

The following example shows how to display the CDP neighbors:

```
switch# show cdp neighbors
```

```
Capability Codes: R - Router, T - Trans-Bridge, B - Source-Route-Bridge
                  S - Switch, H - Host, I - IGMP, r - Repeater,
                  V - VoIP-Phone, D - Remotely-Managed-Device,
                  s - Supports-STP-Dispute
```

```
Device ID          Local Intrfce  Hldtme  Capability  Platform  Port ID
d13-dist-1        mgmt0         148     S I         WS-C2960-24TC  Fas0/9
n5k (FLC12080012) Eth1/5         8       S I s       N5K-C5020P-BA  Eth1/5
```



**Note**

From Cisco NX-OS Release 4.0(1a)N1(1), the default value of the device ID field for CDP advertisement has been changed from the chassis serial number to the hostname and serial number, as in the example above.

## Default Physical Ethernet Settings

The following table lists the default settings for all physical Ethernet interfaces:

Parameter	Default Setting
Debounce	Enable, 100 milliseconds
Duplex	Auto (full-duplex)
Encapsulation	ARPA

Parameter	Default Setting
MTU <sup>1</sup>	1500 bytes
Port Mode	Access
Speed	Auto (10000)

<sup>1</sup> MTU cannot be changed per-physical Ethernet interface. You modify MTU by selecting maps of QoS classes.



## CHAPTER 4

# Configuring VLANs

This chapter describes how to configure VLANs on the Cisco Nexus 5000 Series switch. It contains the following sections:

- [Configuring VLANs, page 25](#)

## Configuring VLANs

You can use virtual LANs (VLANs) to divide the network into different logical broadcast domains.

Any switch port can belong to a VLAN, and unicast, broadcast, and multicast packets are forwarded and flooded only to end stations in that VLAN. Each VLAN is considered a logical network, and packets destined for stations that do not belong to the VLAN must be forwarded through a router.

## Information About VLANs

### Understanding VLAN Ranges

The Cisco Nexus 5000 Series switch supports VLAN numbers 1 to 4094 in accordance with the IEEE 802.1Q standard. These VLANs are organized into ranges. You use each range slightly differently. The Nexus 5000 Series switch supports 507 VLANs and it shares this available number of VLANs with its VSANs; each VSAN consumes one VLAN.

The following table describes the details of the VLAN ranges.

**Table 6: VLAN Ranges**

VLANs Numbers	Range	Usage
1	Normal	Cisco default. You can use this VLAN, but you cannot modify or delete it.
2—1005	Normal	You can create, use, modify, and delete these VLANs.

VLANs Numbers	Range	Usage
1006—4094	Extended	You can create, name, and use these VLANs. You cannot change the following parameters: <ul style="list-style-type: none"> <li>• State is always active.</li> <li>• VLAN is always enabled. You cannot shut down these VLANs.</li> </ul>
3968—4047 and 4094	Internally allocated	These 80 VLANs, plus VLAN 4094, are allocated for internal use. You cannot create, delete, or modify any VLANs within the block reserved for internal use.

**Note**

VLANs 3968 to 4047 and 4094 are reserved for internal use; these VLANs cannot be changed or used.

Cisco NX-OS allocates a group of 80 VLAN numbers for those features, such as multicast and diagnostics, that need to use internal VLANs for their operation. By default, the system allocates VLANs numbered 3968 to 4047 for internal use. VLAN 4094 is also reserved for internal use by the switch.

You cannot use, modify, or delete any of the VLANs in the reserved group. You can display the VLANs that are allocated internally and their associated use.

## Creating, Deleting, and Modifying VLANs

VLANs are numbered from 1 to 4094. All configured ports belong to the default VLAN when you first bring up the switch. The default VLAN (VLAN1) uses only default values. You cannot create, delete, or suspend activity in the default VLAN.

You create a VLAN by assigning a number to it. You can delete VLANs as well as move them from the active operational state to the suspended operational state. If you attempt to create a VLAN with an existing VLAN ID, the switch goes into the VLAN submode but does not create the same VLAN again.

Newly created VLANs remain unused until ports are assigned to the specific VLAN. All the ports are assigned to VLAN1 by default.

Depending on the range of the VLAN, you can configure the following parameters for VLANs (except the default VLAN):

- VLAN name
- Shutdown or not shutdown

When you delete a specified VLAN, the ports associated to that VLAN are shut down and no traffic flows. However, the system retains all the VLAN-to-port mapping for that VLAN, and when you reenables, or recreates, the specified VLAN, the system automatically reinstates all the original ports to that VLAN.

**Note**

---

Commands entered in the VLAN configuration submode are immediately executed.  
VLANs 3968 to 4047 and 4094 are reserved for internal use; these VLANs cannot be changed or used.

---

## About the VLAN Trunking Protocol

The VLAN Trunking Protocol (VTP) is a Layer 2 messaging protocol that maintains VLAN consistency by managing the addition, deletion, and renaming of VLANs within a VTP domain. A VTP domain includes one or more network switches that share the same VTP domain name and that are connected with trunk interfaces. Each switch can be in only one VTP domain.

Layer 2 trunk interfaces, Layer 2 port channels, and virtual port channels (vPCs) support VTP functionality.

**Note**

---

In the Cisco Nexus 5000 Series switches, VTP works only in transparent mode, allowing you to extend a VTP domain across the switch.

---

When the switch is in the VTP transparent mode, the switch relays all VTP protocol packets that it receives on a trunk port to all other trunk ports. When you create or modify a VLAN that is in VTP transparent mode, those VLAN changes affect only the local switch. A VTP transparent network switch does not advertise its VLAN configuration and does not synchronize its VLAN configuration based on received advertisements.

**Note**

---

VLAN 1 is required on all trunk ports used for switch interconnects if the VTP protocol is to be supported in the network. Removing VLAN 1 from any of these ports prevents VTP from functioning.

---

VTP is disabled by default on the switch. You enable and configure VTP using the command-line interface (CLI). When VTP is disabled, the switch does not relay any VTP packets.

If you enable VTP, you must configure either version 1 or version 2. If you are using VTP in a Token Ring environment, you must use version 2.

## Configuring a VLAN

### Creating and Deleting a VLAN

You can create or delete all VLANs except the default VLAN and those VLANs that are internally allocated for use by the switch. Once a VLAN is created, it is automatically in the active state.

**Note**

---

When you delete a VLAN, ports associated to that VLAN shut down. The traffic does not flow and the packets are dropped.

---

## SUMMARY STEPS

1. switch# **configure terminal**
2. switch(config)# **vlan** {*vlan-id* | *vlan-range*}
3. switch(config-vlan)# **no vlan** {*vlan-id* | *vlan-range*}

## DETAILED STEPS

	Command or Action	Purpose
<b>Step 1</b>	switch# <b>configure terminal</b>	Enters configuration mode.
<b>Step 2</b>	switch(config)# <b>vlan</b> { <i>vlan-id</i>   <i>vlan-range</i> }	Creates a VLAN or a range of VLANs.  If you enter a number that is already assigned to a VLAN, the switch puts you into the VLAN configuration submode for that VLAN. If you enter a number that is assigned to an internally allocated VLAN, the system returns an error message. However, if you enter a range of VLANs and one or more of the specified VLANs is outside the range of internally allocated VLANs, the command takes effect on <i>only</i> those VLANs outside the range. The range is from 2 to 4094; VLAN1 is the default VLAN and cannot be created or deleted. You cannot create or delete those VLANs that are reserved for internal use.
<b>Step 3</b>	switch(config-vlan)# <b>no vlan</b> { <i>vlan-id</i>   <i>vlan-range</i> }	Deletes the specified VLAN or range of VLANs and removes you from the VLAN configuration submode. You cannot delete VLAN1 or the internally allocated VLANs.

This example shows how to create a range of VLANs from 15 to 20:

```
switch# configure terminal
switch(config)# vlan 15-20
```

**Note**

You can also create and delete VLANs in the VLAN configuration submode.

## Entering the VLAN Submode and Configuring the VLAN

To configure or modify the VLAN for the following parameters, you must be in the VLAN configuration submode:

- Name
- Shut down

**Note**

You cannot create, delete, or modify the default VLAN or the internally allocated VLANs. Additionally, some of these parameters cannot be modified on some VLANs.

## SUMMARY STEPS

1. switch# **configure terminal**
2. switch(config)# **vlan** {*vlan-id* | *vlan-range*}
3. switch(config-vlan)# **name** *vlan-name*
4. switch(config-vlan)# **state** {**active** | **suspend**}
5. (Optional) switch(config-vlan)# **no shutdown**

## DETAILED STEPS

	Command or Action	Purpose
<b>Step 1</b>	switch# <b>configure terminal</b>	Enters configuration mode.
<b>Step 2</b>	switch(config)# <b>vlan</b> { <i>vlan-id</i>   <i>vlan-range</i> }	Enters VLAN configuration submenu. If the VLAN does not exist, the system first creates the specified VLAN.
<b>Step 3</b>	switch(config-vlan)# <b>name</b> <i>vlan-name</i>	Names the VLAN. You can enter up to 32 alphanumeric characters to name the VLAN. You cannot change the name of VLAN1 or the internally allocated VLANs. The default value is VLANxxxx where xxxx represent four numeric digits (including leading zeroes) equal to the VLAN ID number.
<b>Step 4</b>	switch(config-vlan)# <b>state</b> { <b>active</b>   <b>suspend</b> }	Sets the state of the VLAN to active or suspend. While the VLAN state is suspended, the ports associated with this VLAN are shut down, and that VLAN does not pass any traffic. The default state is active. You cannot suspend the state for the default VLAN or VLANs 1006 to 4094.
<b>Step 5</b>	switch(config-vlan)# <b>no shutdown</b>	(Optional) Enables the VLAN. The default value is <b>no shutdown</b> (or enabled). You cannot shut down the default VLAN, VLAN1, or VLANs 1006 to 4094.

This example shows how to configure optional parameters for VLAN 5:

```
switch# configure terminal
switch(config)# vlan 5
switch(config-vlan)# name accounting
switch(config-vlan)# state active
switch(config-vlan)# no shutdown
```

## Adding Ports to a VLAN

After you have completed the configuration of a VLAN, assign ports to it. To add ports, perform this task:

## SUMMARY STEPS

1. switch# **configure terminal**
2. switch(config)# **interface** {*ethernet slot/port* | **port-channel number**}
3. switch(config-if)# **switchport access vlan** *vlan-id*

## DETAILED STEPS

	Command or Action	Purpose
<b>Step 1</b>	switch# <b>configure terminal</b>	Enters configuration mode.
<b>Step 2</b>	switch(config)# <b>interface</b> { <i>ethernet slot/port</i>   <b>port-channel</b> <i>number</i> }	Specifies the interface to configure, and enters the interface configuration mode. The interface can be a physical Ethernet port or an EtherChannel.
<b>Step 3</b>	switch(config-if)# <b>switchport access vlan</b> <i>vlan-id</i>	Sets the access mode of the interface to the specified VLAN.

This example shows how to configure an Ethernet interface to join VLAN 5:

```
switch# configure terminal
switch(config)# interface ethernet 1/13
switch(config-if)# switchport access vlan 5
```

## Configuring VTP

You can enable and configure VTP to relay VTP packets. If you enable VTP, you must configure either version 1 or version 2. If you are using VTP in a Token Ring environment, you must use version 2.

**Before You Begin**

Ensure that you are in the correct VDC (or enter the **switchto vdc** command). VLAN names and IDs can be repeated in different VDCs, so you must confirm which VDC that you are working with.

## SUMMARY STEPS

1. **config t**
2. **feature vtp**
3. **vtp domain** *domain-name*
4. **vtp version** {1|2}
5. **vtp mode transparent**
6. **exit**
7. **show vlan**
8. **copy running-config startup-config**

## DETAILED STEPS

	Command or Action	Purpose
<b>Step 1</b>	<b>config t</b>  <b>Example:</b> switch#config t switch(config)#	Enters configuration mode.

	Command or Action	Purpose
<b>Step 2</b>	<b>feature vtp</b>  <b>Example:</b> switch(config)#feature vtp switch(config)#	Enables VTP on the device. The default is disabled.
<b>Step 3</b>	<b>vtp domain domain-name</b>  <b>Example:</b> switch(config)#vtp domain accounting switch(config)#	Enter the name of the VTP domain that you want this switch to join. The default is blank.
<b>Step 4</b>	<b>vtp version {1 2}</b>  <b>Example:</b> switch(config)#vtp version 2 switch(config)#	Sets the VTP version that you want to use. The default is version 1.
<b>Step 5</b>	<b>vtp mode transparent</b>  <b>Example:</b> switch(config)#vtp mode transparent switch(config)#	(Optional) After you enable VTP, the only available mode is transparent.
<b>Step 6</b>	<b>exit</b>  <b>Example:</b> switch(config)#exit switch(config)#	Exits the configuration submenu.
<b>Step 7</b>	<b>show vlan</b>  <b>Example:</b> switch(config)#show vlan	(Optional) Displays information about VTP.
<b>Step 8</b>	<b>copy running-config startup-config</b>  <b>Example:</b> switch(config)#copy running-config startup-config	(Optional) Copies the running configuration to the startup configuration.

This example shows how to configure VTP in transparent mode:

```
switch#config t
switch(config)#feature vtp
switch(config)#vtp domain accounting
switch(config)#vtp version2
switch(config)#exit
switch#
```

## Verifying VLAN Configuration

To display VLAN configuration information, perform one of these tasks:

Command	Purpose
switch# <b>show running-config vlan</b> [ <i>vlan_id</i>   <i>vlan_range</i> ]	Displays VLAN information.
switch# <b>show vlan</b> [ <b>brief</b>   <b>id</b> [ <i>vlan_id</i>   <i>vlan_range</i> ]   <b>name</b> <i>name</i>   <b>summary</b> ]	Displays selected configuration information for the defined VLAN(s).

The following example shows all VLANs defined in the range of 1 to 21.

```
switch# show running-config vlan 1-21
version 4.0(1a)N1(1)
vlan 1
vlan 5
```

The following example shows the VLANs created on the switch and their status:

```
switch# show vlan

VLAN Name                Status    Ports
-----
1    default                active    Eth1/1, Eth1/2, Eth1/3, Eth1/4
                                Eth1/5, Eth1/6, Eth1/7, Eth1/8
                                Eth1/9, Eth1/10, Eth1/11
                                Eth1/12, Eth1/15, Eth1/16
                                Eth1/17, Eth1/18, Eth1/19
                                Eth1/20, Eth1/21, Eth1/22
                                Eth1/23, Eth1/24, Eth1/25
                                Eth1/26, Eth1/27, Eth1/28
                                Eth1/29, Eth1/30, Eth1/31
                                Eth1/32, Eth1/33, Eth1/34
                                Eth1/35, Eth1/36, Eth1/37
                                Eth1/38, Eth1/39, Eth1/40
                                Eth3/1, Eth3/2, Eth3/3, Eth3/4
                                veth1/1
13   VLAN0005              active    Eth1/13, Eth1/14
```

The following example shows the details of VLAN 13 including its member ports:

```
switch# show vlan id 13

VLAN Name                Status    Ports
-----
13   VLAN0005              active    Eth1/13, Eth1/14

VLAN Type    MTU
-----
13   enet    576

Remote SPAN VLAN
-----
Disabled

Primary  Secondary  Type          Ports
-----

```

The following example shows the VLAN settings summary:

```
switch# show vlan summary

Number of existing VLANs           : 2
Number of existing user VLANs      : 2
Number of existing extended VLANs  : 0
```



## CHAPTER 5

# Configuring Private VLANs

---

This chapter describes how to configure private VLANs on the Cisco Nexus 5000 Series switch. It contains the following sections:

- [Information About Private VLANs, page 33](#)
- [Guidelines and Limitations for Private VLANs, page 38](#)
- [Configuring a Private VLAN, page 38](#)
- [Verifying Private VLAN Configuration, page 47](#)

## Information About Private VLANs

A private VLAN partitions the Ethernet broadcast domain of a VLAN into subdomains, allowing you to isolate the ports on the switch from each other. A subdomain consists of a primary VLAN and one or more secondary VLANs (see the following figure). All VLANs in a private VLAN domain share the same primary VLAN. The secondary VLAN ID differentiates one subdomain from another. The secondary VLANs may either be isolated VLANs or community VLANs. A host on an isolated VLAN can only communicate with the associated

promiscuous port in its primary VLAN. Hosts on community VLANs can communicate among themselves and with their associated promiscuous port but not with ports in other community VLANs.

**Figure 2: Private VLAN Domain**

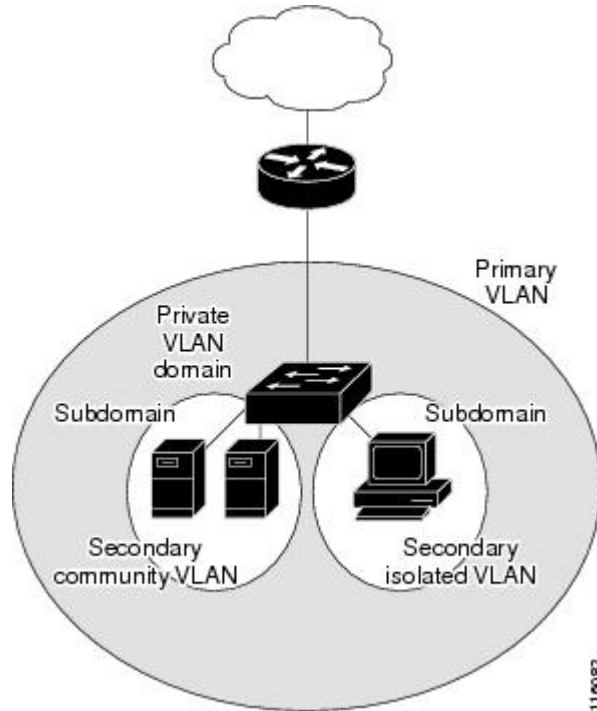

**Note** You must first create the VLAN before you can convert it to a private VLAN, either primary or secondary.

## Primary and Secondary VLANs in Private VLANs

A private VLAN domain has only one primary VLAN. Each port in a private VLAN domain is a member of the primary VLAN; the primary VLAN is the entire private VLAN domain.

Secondary VLANs provide isolation between ports within the same private VLAN domain. The following two types are secondary VLANs within a primary VLAN:

- Isolated VLANs—Ports within an isolated VLAN cannot communicate directly with each other at the Layer 2 level.
- Community VLANs—Ports within a community VLAN can communicate with each other but cannot communicate with ports in other community VLANs or in any isolated VLANs at the Layer 2 level.

## Private VLAN Ports

The three types of private VLAN ports are as follows:

- **Promiscuous**—A promiscuous port belongs to the primary VLAN. The promiscuous port can communicate with all interfaces, including the community and isolated host ports, that belong to those secondary VLANs associated to the promiscuous port and associated with the primary VLAN. You can have several promiscuous ports in a primary VLAN. Each promiscuous port can have several secondary VLANs or no secondary VLANs that are associated to that port. You can associate a secondary VLAN to more than one promiscuous port, as long as the promiscuous port and secondary VLANs are within the same primary VLAN. You can also have secondary VLANs that are not associated to any promiscuous port.

A promiscuous port can be configured either as an access port or as a trunk port.

- **Isolated**—An isolated port is a host port that belongs to an isolated secondary VLAN. This port has complete isolation from other ports within the same private VLAN domain, except that it can communicate with associated promiscuous ports. Private VLANs block all traffic to isolated ports except traffic from promiscuous ports. Traffic received from an isolated port is forwarded only to promiscuous ports. You can have more than one isolated port in a specified isolated VLAN. Each port is completely isolated from all other ports in the isolated VLAN.

An isolated port can be configured as either an access port or a trunk port.

- **Community**—A community port is a host port that belongs to a community secondary VLAN. Community ports communicate with other ports in the same community VLAN and with associated promiscuous ports. These interfaces are isolated from all other interfaces in other communities and from all isolated ports within the private VLAN domain.

A community port must be configured as an access port. A community VLAN must not be enabled on an isolated trunk.

**Note**

---

Because trunks can support the VLANs that carry traffic between promiscuous, isolated, and community ports, the isolated and community port traffic might enter or leave the switch through a trunk interface.

---

## Primary, Isolated, and Community Private VLANs

Primary VLANs and the two types of secondary VLANs (isolated and community) have these characteristics:

- **Primary VLAN**— The primary VLAN carries traffic from the promiscuous ports to the host ports, both isolated and community, and to other promiscuous ports.
- **Isolated VLAN** —An isolated VLAN is a secondary VLAN that carries unidirectional traffic upstream from the hosts toward the promiscuous ports. You can only configure one isolated VLAN in a private VLAN domain. An isolated VLAN can have several isolated ports. The traffic from each isolated port also remains completely separate.
- **Community VLAN**—A community VLAN is a secondary VLAN that carries upstream traffic from the community ports to the promiscuous port and to other host ports in the same community. You can configure multiple community VLANs in a private VLAN domain. The ports within one community can communicate, but these ports cannot communicate with ports in any other community or isolated VLAN in the private VLAN.

The following figure shows the traffic flows within a private VLAN, along with the types of VLANs and types of ports.

**Figure 3: Private VLAN Traffic Flows**

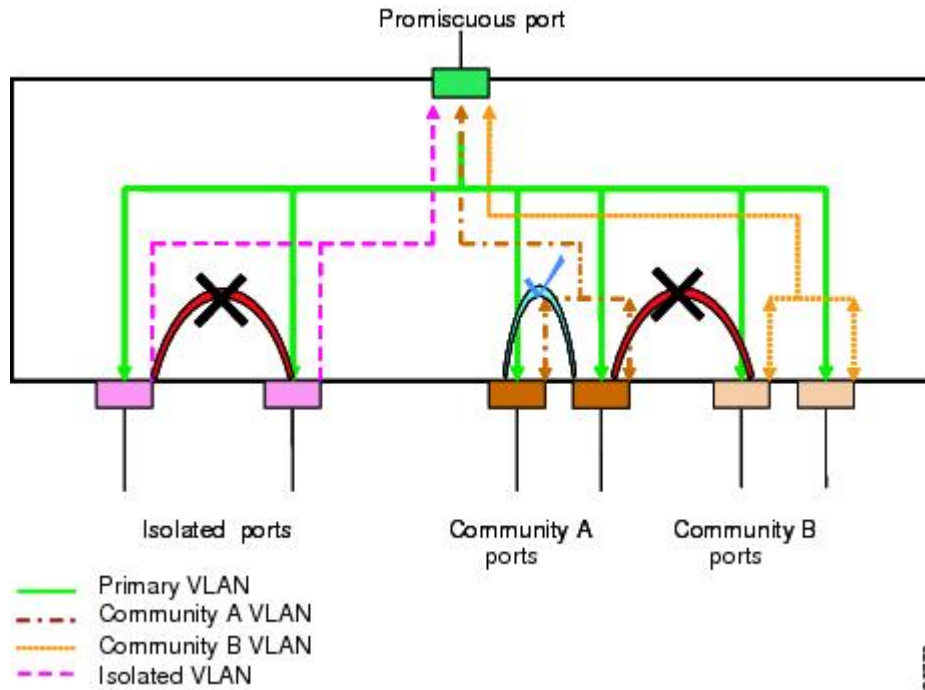

**Note**

The private VLAN traffic flows are unidirectional from the host ports to the promiscuous ports. Traffic received on primary VLAN enforces no separation and forwarding is done as in normal VLAN.

A promiscuous access port can serve only one primary VLAN and multiple secondary VLANs (community and isolated VLANs). A promiscuous trunk port can carry traffic for several primary VLANs. Multiple secondary VLANs under a given primary VLAN can be mapped to promiscuous trunk ports. With a promiscuous port, you can connect a wide range of devices as access points to a private VLAN. For example, you can use a promiscuous port to monitor or back up all the private VLAN servers from an administration workstation.

In a switched environment, you can assign an individual private VLAN and associated IP subnet to each individual or common group of end stations.

## Associating Primary and Secondary VLANs

To allow host ports in secondary VLANs to communicate outside the private VLAN, you associate secondary VLANs to the primary VLAN. If the association is not operational, the host ports (community and isolated ports) in the secondary VLAN are brought down.

**Note**

You can associate a secondary VLAN with only one primary VLAN.

For an association to be operational, the following conditions must be met:

- The primary VLAN must exist and be configured as a primary VLAN.
- The secondary VLAN must exist and be configured as either an isolated or community VLAN.

**Note**

Use the **show vlan private-vlan** command to verify that the association is operational. The switch does not display an error message when the association is nonoperational.

If you delete either the primary or secondary VLAN, the ports that are associated with the VLAN become inactive. Use the **no private-vlan** command to return the VLAN to the normal mode. All primary and secondary associations on that VLAN are suspended, but the interfaces remain in private VLAN mode. When you convert the VLAN back to private VLAN mode, the original associations are reinstated.

If you enter the **no vlan** command for the primary VLAN, all private VLAN associations with that VLAN are deleted. However, if you enter the **no vlan** command for a secondary VLAN, the private VLAN associations with that VLAN are suspended and are restored when you recreate the specified VLAN and configure it as the previous secondary VLAN.

In order to change the association between a secondary and primary VLAN, you must first remove the current association and then add the desired association.

## Private VLAN Promiscuous Trunks

A promiscuous trunk port can carry traffic for several primary VLANs. Multiple secondary VLANs under a given primary VLAN can be mapped to promiscuous trunk port. Traffic on the promiscuous port is received and transmitted with a primary VLAN tag.

## Private VLAN Isolated Trunks

An isolated trunk port can carry traffic for multiple isolated private VLANs. Traffic for a community VLAN is not carried by isolated trunk ports. Traffic on isolated trunk ports is received and transmitted with an isolated VLAN tag. Isolated trunk ports are intended to be connected to host servers.

To support isolated private VLAN ports on a Cisco Nexus 2000 Series Fabric Extender, the Cisco Nexus 5000 Series switch must prevent communication between the isolated ports on the Fabric Extender; all forwarding occurs through the Cisco Nexus 5000 Series switch.

For unicast traffic, it is simple to prevent such a communication without any side effects.

For multicast traffic, the Fabric Extender provides replication of the frames. To prevent communication between isolated private VLAN ports on the Fabric Extender, the Cisco Nexus 5000 Series switch prevents multicast frames from being sent back through the fabric ports. This restriction prevents communication between an isolated VLAN and a promiscuous port on the Fabric Extender. However as its host interfaces are not intended to be connected to another switch or router, you cannot enable a promiscuous port on Fabric Extender.

## Broadcast Traffic in Private VLANs

Broadcast traffic from ports in a private VLAN flows in the following ways:

- The broadcast traffic flows from a promiscuous port to all ports in the primary VLAN (which includes all the ports in the community and isolated VLANs). This broadcast traffic is distributed to all ports within the primary VLAN, including those ports that are not configured with private VLAN parameters.
- The broadcast traffic from an isolated port is distributed only to those promiscuous ports in the primary VLAN that are associated to that isolated port.
- The broadcast traffic from community ports is distributed to all ports within the port's community and to all promiscuous ports that are associated to the community port. The broadcast packets are not distributed to any other communities within the primary VLAN, or to any isolated ports.

## Private VLAN Port Isolation

You can use private VLANs to control access to end stations as follows:

- Configure selected interfaces connected to end stations as isolated ports to prevent any communication. For example, if the end stations are servers, this configuration prevents communication between the servers.
- Configure interfaces connected to default gateways and selected end stations (for example, backup servers) as promiscuous ports to allow all end stations access to a default gateway.

## Guidelines and Limitations for Private VLANs

When configuring private VLANs, follow these guidelines:

- You must have already created the VLAN before you can assign the specified VLAN as a private VLAN.
- You must enable private VLANs before the switch can apply the private VLAN functionality.
- You cannot disable private VLANs if the switch has any operational ports in a private VLAN mode.
- Enter the **private-vlan synchronize** command from within the Multiple Spanning Tree (MST) region definition to map the secondary VLANs to the same MST instance as the primary VLAN.

### Related Topics

- [Mapping Secondary VLANs to Same MSTI as Primary VLANs for Private VLANs](#), page 149

## Configuring a Private VLAN

### Enabling Private VLANs

You must enable private VLANs on the switch to use the private VLAN functionality.

**Note**

The private VLAN commands do not appear until you enable the private VLAN feature.

**SUMMARY STEPS**

1. switch# **configure terminal**
2. switch(config)# **feature private-vlan**
3. (Optional) switch(config)# **no feature private-vlan**

**DETAILED STEPS**

	Command or Action	Purpose
<b>Step 1</b>	switch# <b>configure terminal</b>	Enters configuration mode.
<b>Step 2</b>	switch(config)# <b>feature private-vlan</b>	Enables the private VLAN feature on the switch.
<b>Step 3</b>	switch(config)# <b>no feature private-vlan</b>	(Optional) Disables the private VLAN feature on the switch. <b>Note</b> You cannot disable private VLANs if there are operational ports on the switch that are in private VLAN mode.

This example shows how to enable the private VLAN feature on the switch:

```
switch# configure terminal
switch(config)# feature private-vlan
```

## Configuring a VLAN as a Private VLAN

To create a private VLAN, you first create a VLAN, and then configure that VLAN to be a private VLAN.

**Before You Begin**

Ensure that the private VLAN feature is enabled.

**SUMMARY STEPS**

1. switch# **configure terminal**
2. switch(config)# **vlan** {vlan-id | vlan-range}
3. switch(config-vlan)# **private-vlan** {community | isolated | primary}
4. (Optional) switch(config-vlan)# **no private-vlan** {community | isolated | primary}

## DETAILED STEPS

	Command or Action	Purpose
Step 1	switch# <b>configure terminal</b>	Enters configuration mode.
Step 2	switch(config)# <b>vlan</b> {vlan-id   vlan-range}	Places you into the VLAN configuration submenu.
Step 3	switch(config-vlan)# <b>private-vlan</b> { <b>community</b>   <b>isolated</b>   <b>primary</b> }	Configures the VLAN as either a community, isolated, or primary private VLAN. In a private VLAN, you must have one primary VLAN. You can have multiple community and isolated VLANs.
Step 4	switch(config-vlan)# <b>no private-vlan</b> { <b>community</b>   <b>isolated</b>   <b>primary</b> }	(Optional) Removes the private VLAN configuration from the specified VLAN(s) and returns it to normal VLAN mode. If you delete either the primary or secondary VLAN, the ports that are associated with the VLAN become inactive.

This example shows how to assign VLAN 5 to a private VLAN as the primary VLAN:

```
switch# configure terminal
switch(config)# vlan 5
switch(config-vlan)# private-vlan primary
```

This example shows how to assign VLAN 100 to a private VLAN as a community VLAN:

```
switch# configure terminal
switch(config)# vlan 100
switch(config-vlan)# private-vlan community
```

This example shows how to assign VLAN 200 to a private VLAN as an isolated VLAN:

```
switch# configure terminal
switch(config)# vlan 200
switch(config-vlan)# private-vlan isolated
```

## Associating Secondary VLANs with a Primary Private VLAN

When you associate secondary VLANs with a primary VLAN, follow these guidelines:

- The *secondary-vlan-list* parameter cannot contain spaces. It can contain multiple comma-separated items. Each item can be a single secondary VLAN ID or a hyphenated range of secondary VLAN IDs.
- The *secondary-vlan-list* parameter can contain multiple community VLAN IDs and one isolated VLAN ID.
- Enter a *secondary-vlan-list* or use the add keyword with a *secondary-vlan-list* to associate secondary VLANs with a primary VLAN.
- Use the remove keyword with a *secondary-vlan-list* to clear the association between secondary VLANs and a primary VLAN.
- You change the association between a secondary and primary VLAN by removing the existing association and then adding the desired association.

If you delete either the primary or secondary VLAN, the VLAN becomes inactive on the port where the association is configured. When you enter the **no private-vlan** command, the VLAN returns to the normal

VLAN mode. All primary and secondary associations on that VLAN are suspended, but the interfaces remain in private VLAN mode. If you again convert the specified VLAN to private VLAN mode, the original associations are reinstated.

If you enter the **no vlan** command for the primary VLAN, all private VLAN associations with that VLAN are lost. However, if you enter the **no vlan** command for a secondary VLAN, the private VLAN associations with that VLAN are suspended and are reinstated when you recreate the specified VLAN and configure it as the previous secondary VLAN.

### Before You Begin

Ensure that the private VLAN feature is enabled.

## SUMMARY STEPS

1. switch# **configure terminal**
2. switch(config)# **vlan primary-vlan-id**
3. switch(config-vlan)# **private-vlan association** {[add] secondary-vlan-list | remove secondary-vlan-list}
4. (Optional) switch(config-vlan)# **no private-vlan association**

## DETAILED STEPS

	Command or Action	Purpose
Step 1	switch# <b>configure terminal</b>	Enters configuration mode.
Step 2	switch(config)# <b>vlan primary-vlan-id</b>	Enters the number of the primary VLAN that you are working in for the private VLAN configuration.
Step 3	switch(config-vlan)# <b>private-vlan association</b> {[add] secondary-vlan-list   remove secondary-vlan-list}	Associates the secondary VLANs with the primary VLAN.
Step 4	switch(config-vlan)# <b>no private-vlan association</b>	(Optional) Removes all associations from the primary VLAN and returns it to normal VLAN mode.

This example shows how to associate community VLANs 100 through 110 and isolated VLAN 200 with primary VLAN 5:

```
switch# configure terminal
switch(config)# vlan 5
switch(config-vlan)# private-vlan association 100-110, 200
```

## Configuring an Interface as a Private VLAN Host Port

In private VLANs, host ports are part of the secondary VLANs, which are either community VLANs or isolated VLANs. Configuring a private VLAN host port involves two steps. First, you define the port as a private VLAN host port and then you configure a host association between the primary and secondary VLANs.



### Note

We recommend that you enable BPDU Guard on all interfaces configured as a host ports.

**Before You Begin**

Ensure that the private VLAN feature is enabled.

**SUMMARY STEPS**

1. switch# **configure terminal**
2. switch(config)# **interface** *type* [*chassis*/]*slot*/*port*
3. switch(config-if)# **switchport mode private-vlan host**
4. switch(config-if)# **switchport private-vlan host-association** {*primary-vlan-id*} {*secondary-vlan-id*}
5. (Optional) switch(config-if)# **no switchport private-vlan host-association**

**DETAILED STEPS**

	<b>Command or Action</b>	<b>Purpose</b>
<b>Step 1</b>	switch# <b>configure terminal</b>	Enters configuration mode.
<b>Step 2</b>	switch(config)# <b>interface</b> <i>type</i> [ <i>chassis</i> /] <i>slot</i> / <i>port</i>	Selects the port to configure as a private VLAN host port. This port can be on a Fabric Extender (identified by the chassis option).
<b>Step 3</b>	switch(config-if)# <b>switchport mode private-vlan host</b>	Configures the port as a host port for a private VLAN.
<b>Step 4</b>	switch(config-if)# <b>switchport private-vlan host-association</b> { <i>primary-vlan-id</i> } { <i>secondary-vlan-id</i> }	Associates the port with the primary and secondary VLANs of a private VLAN. The secondary VLAN can be either an isolated or community VLAN.
<b>Step 5</b>	switch(config-if)# <b>no switchport private-vlan host-association</b>	(Optional) Removes the private VLAN association from the port.

This example shows how to configure Ethernet port 1/12 as a host port for a private VLAN and associate it to primary VLAN 5 and secondary VLAN 101:

```
switch# configure terminal
switch(config)# interface ethernet 1/12
switch(config-if)# switchport mode private-vlan host
switch(config-if)# switchport private-vlan host-association 5 101
```

**Configuring an Interface as a Private VLAN Promiscuous Port**

In a private VLAN domain, promiscuous ports are part of the primary VLAN. Configuring a promiscuous port involves two steps. First, you define the port as a promiscuous port and then you configure the mapping between a secondary VLAN and the primary VLAN.

**Before You Begin**

Ensure that the private VLAN feature is enabled.

## SUMMARY STEPS

1. switch# **configure terminal**
2. switch(config)# **interface** *type slot/port*
3. switch(config-if)# **switchport mode private-vlan promiscuous**
4. switch(config-if)# **switchport private-vlan mapping** *{primary-vlan-id}* *{secondary-vlan-list}* | **add** *secondary-vlan-list* | **remove** *secondary-vlan-list*}
5. (Optional) switch(config-if)# **no switchport private-vlan mapping**

## DETAILED STEPS

	Command or Action	Purpose
<b>Step 1</b>	switch# <b>configure terminal</b>	Enters configuration mode.
<b>Step 2</b>	switch(config)# <b>interface</b> <i>type slot/port</i>	Selects the port to configure as a private VLAN promiscuous port. A physical interface is required. This port cannot be on a Fabric Extender.
<b>Step 3</b>	switch(config-if)# <b>switchport mode private-vlan promiscuous</b>	Configures the port as a promiscuous port for a private VLAN. You can only enable a physical Ethernet port as the promiscuous port.
<b>Step 4</b>	switch(config-if)# <b>switchport private-vlan mapping</b> <i>{primary-vlan-id}</i> <i>{secondary-vlan-list}</i>   <b>add</b> <i>secondary-vlan-list</i>   <b>remove</b> <i>secondary-vlan-list</i> }	Configures the port as a promiscuous port and associates the specified port with a primary VLAN and a selected list of secondary VLANs. The secondary VLAN can be either an isolated or community VLAN.
<b>Step 5</b>	switch(config-if)# <b>no switchport private-vlan mapping</b>	(Optional) Clears the mapping from the private VLAN.

This example shows how to configure Ethernet interface 1/4 as a promiscuous port associated with primary VLAN 5 and secondary isolated VLAN 200:

```
switch# configure terminal
switch(config)# interface ethernet 1/4
switch(config-if)# switchport mode private-vlan promiscuous
switch(config-if)# switchport private-vlan mapping 5 200
```

## Configuring a Promiscuous Trunk Port

In a private VLAN domain, promiscuous trunks are part of the primary VLAN. Promiscuous trunk ports can carry multiple primary VLANs. Multiple secondary VLANs under a given primary VLAN can be mapped to a promiscuous trunk port.

Configuring a promiscuous port involves two steps. First, you define the port as a promiscuous port and then you configure the mapping between a secondary VLAN and the primary VLAN. Multiple primary VLANs can be enabled by configuring multiple mappings.

**Before You Begin**

Ensure that the private VLAN feature is enabled.

**SUMMARY STEPS**

1. switch# **configure terminal**
2. switch(config)# **interface** *type slot/port*
3. switch(config-if)# **switchport mode private-vlan trunk promiscuous**
4. switch(config-if)# **switchport private-vlan mapping trunk** *{primary-vlan-id}* *{secondary-vlan-id}*
5. (Optional) switch(config-if)# **no switchport private-vlan mapping trunk** [*primary-vlan-id*]

**DETAILED STEPS**

	<b>Command or Action</b>	<b>Purpose</b>
<b>Step 1</b>	switch# <b>configure terminal</b>	Enters configuration mode.
<b>Step 2</b>	switch(config)# <b>interface</b> <i>type slot/port</i>	Selects the port to configure as a private VLAN promiscuous trunk port.
<b>Step 3</b>	switch(config-if)# <b>switchport mode private-vlan trunk promiscuous</b>	Configures the port as a promiscuous trunk port for a private VLAN. You can only enable a physical Ethernet port as the promiscuous port. This port cannot be on a Fabric Extender.
<b>Step 4</b>	switch(config-if)# <b>switchport private-vlan mapping trunk</b> <i>{primary-vlan-id}</i> <i>{secondary-vlan-id}</i>	Maps the trunk port with the primary and secondary VLANs of a private VLAN. The secondary VLAN can be either an isolated or community VLAN.
<b>Step 5</b>	switch(config-if)# <b>no switchport private-vlan mapping trunk</b> [ <i>primary-vlan-id</i> ]	(Optional) Removes the private VLAN mapping from the port. If the <i>primary-vlan-id</i> is not supplied, all private VLAN mappings are removed from the port.

This example shows how to configure Ethernet interface 1/1 as a promiscuous trunk port for a private VLAN and then map the secondary VLANs to the primary VLAN:

```
switch# configure terminal
switch(config)# interface ethernet 1/1
switch(config-if)# switchport mode private-vlan trunk promiscuous
switch(config-if)# switchport private-vlan mapping trunk 5 100
switch(config-if)# switchport private-vlan mapping trunk 5 200
switch(config-if)# switchport private-vlan mapping trunk 6 300
```

**Configuring an Isolated Trunk Port**

In a private VLAN domain, isolated trunks are part of a secondary VLAN. Isolated trunk ports can carry multiple isolated VLANs. Only one isolated VLAN under a given primary VLAN can be associated to an isolated trunk port. Configuring an isolated trunk port involves two steps. First, you define the port as an isolated trunk port and then you configure the association between the isolated and primary VLANs. Multiple isolated VLANs can be enabled by configuring multiple associations.

**Before You Begin**

Ensure that the private VLAN feature is enabled.

**SUMMARY STEPS**

1. switch# **configure terminal**
2. switch(config)# **interface** *type* [*chassis*]/*slot*/*port*
3. switch(config-if)# **switchport mode private-vlan trunk** [secondary]
4. switch(config-if)# **switchport private-vlan association trunk** {*primary-vlan-id*} {*secondary-vlan-id*}
5. (Optional) switch(config-if)# **no switchport private-vlan association trunk** [*primary-vlan-id*]

**DETAILED STEPS**

	Command or Action	Purpose
<b>Step 1</b>	switch# <b>configure terminal</b>	Enters configuration mode.
<b>Step 2</b>	switch(config)# <b>interface</b> <i>type</i> [ <i>chassis</i> ]/ <i>slot</i> / <i>port</i>	Selects the port to configure as a private VLAN isolated trunk port. This port can be on a Fabric Extender (identified by the <i>chassis</i> option).
<b>Step 3</b>	switch(config-if)# <b>switchport mode private-vlan trunk</b> [secondary]	Configures the port as a secondary trunk port for a private VLAN. <b>Note</b> The secondary keyword is assumed if it is not present.
<b>Step 4</b>	switch(config-if)# <b>switchport private-vlan association trunk</b> { <i>primary-vlan-id</i> } { <i>secondary-vlan-id</i> }	Associates the isolated trunk port with the primary and secondary VLANs of a private VLAN. The secondary VLAN should be an isolated VLAN. Only one isolated VLAN can be mapped under a given primary VLAN.
<b>Step 5</b>	switch(config-if)# <b>no switchport private-vlan association trunk</b> [ <i>primary-vlan-id</i> ]	(Optional) Removes the private VLAN association from the port. If the <i>primary-vlan-id</i> is not supplied, all private VLAN associations are removed from the port.

This example shows how to configure Ethernet interface 1/1 as a promiscuous trunk port for a private VLAN and then map the secondary VLANs to the primary VLAN:

```
switch# configure terminal
switch(config)# interface ethernet 1/1
switch(config-if)# switchport mode private-vlan trunk secondary
switch(config-if)# switchport private-vlan association 5 100
switch(config-if)# switchport private-vlan association 6 200
```

**Configuring the Allowed VLANs for PVLAN Trunking Ports**

Isolated trunk and promiscuous trunk ports can carry traffic from regular VLANs along with private VLANs.

**Before You Begin**

Ensure that the private VLAN feature is enabled.

## SUMMARY STEPS

1. switch# **configure terminal**
2. switch(config)# **interface** *type* [*chassis*]/*slot*/*port*
3. switch(config-if)# **switchport private-vlan trunk allowed vlan** {*vlan-list* | **all** | **none** [**add** | **except** | **none** | **remove** {*vlan-list*}]}

## DETAILED STEPS

	Command or Action	Purpose
<b>Step 1</b>	switch# <b>configure terminal</b>	Enters configuration mode.
<b>Step 2</b>	switch(config)# <b>interface</b> <i>type</i> [ <i>chassis</i> ]/ <i>slot</i> / <i>port</i>	Selects the port to configure as a private VLAN host port. This port can be on a Fabric Extender (identified by the chassis option).
<b>Step 3</b>	switch(config-if)# <b>switchport private-vlan trunk allowed vlan</b> { <i>vlan-list</i>   <b>all</b>   <b>none</b> [ <b>add</b>   <b>except</b>   <b>none</b>   <b>remove</b> { <i>vlan-list</i> }]}	Sets the allowed VLANs for the private trunk interface. The default is to allow only mapped/associated VLANs on the private VLAN trunk interface.  <b>Note</b> The primary VLANs do not need to be explicitly added to the allowed VLAN list. They are added automatically once there is a mapping between primary and secondary VLANs.

This example shows how to add VLANs to the list of allowed VLANs on an Ethernet private VLAN trunk port:

```
switch# configure terminal
switch(config)# interface ethernet 1/3
switch(config-if)# switchport private-vlan trunk allowed vlan 15-20
```

## Configuring Native 802.1Q VLANs on Private VLANs

Typically, you configure 802.1Q trunks with a native VLAN ID, which strips tagging from all packets on that VLAN. This configuration allows untagged traffic and control traffic to transit the Cisco Nexus 5000 Series switch. Secondary VLANs cannot be configured with a native VLAN ID on promiscuous trunk ports. Primary VLANs cannot be configured with a native VLAN ID on isolated trunk ports.

**Note**

A trunk can carry the traffic of multiple VLANs. Traffic belonging to the native VLAN is not encapsulated to transit the trunk. Traffic for other VLANs is encapsulated with tags which identify the VLAN the traffic belongs to.

**Before You Begin**

Ensure that the private VLAN feature is enabled.

## SUMMARY STEPS

1. switch# **configure terminal**
2. switch(config)# **interface** *type* [*chassis/*]*slot/port*
3. switch(config-if)# **switchport private-vlan trunk native** {*vlan vlan-id*}
4. (Optional) switch(config-if)# **no switchport private-vlan trunk native** {*vlan vlan-id*}

## DETAILED STEPS

	Command or Action	Purpose
<b>Step 1</b>	switch# <b>configure terminal</b>	Enters configuration mode.
<b>Step 2</b>	switch(config)# <b>interface</b> <i>type</i> [ <i>chassis/</i> ] <i>slot/port</i>	Selects the port to configure as a private VLAN host port. This port can be on a Fabric Extender (identified by the chassis option).
<b>Step 3</b>	switch(config-if)# <b>switchport private-vlan trunk native</b> { <i>vlan vlan-id</i> }	Sets the native VLAN ID for the private VLAN trunk. The default is VLAN 1.
<b>Step 4</b>	switch(config-if)# <b>no switchport private-vlan trunk native</b> { <i>vlan vlan-id</i> }	(Optional) Removes the native VLAN ID from the private VLAN trunk.

## Verifying Private VLAN Configuration

To display private VLAN configuration information, use the following commands:

Command	Purpose
switch# <b>show feature</b>	Displays the features enabled on the switch.
switch# <b>show interface switchport</b>	Displays information on all interfaces configured as switch ports.
switch# <b>show vlan private-vlan</b> [ <i>type</i> ]	Displays the status of the private VLAN.

The following example shows how to display the private VLAN configuration:

```
switch# show vlan private-vlan
Primary  Secondary  Type           Ports
-----  -
5        100        community
5        101        community      Eth1/12, Eth100/1/1
5        102        community
5        110        community
5        200        isolated       Eth1/2
switch# show vlan private-vlan type
Vlan Type
-----
5      primary
100    community
101    community
102    community
110    community
200    isolated
```

The following example shows how to display enabled features (some of the output has been removed for brevity):

```
switch# show feature
Feature Name      Instance  State
-----
fcsp              1        enabled
...
interface-vlan   1        enabled
private-vlan     1        enabled
udld             1        disabled
...
```



# CHAPTER 6

## Configuring Access and Trunk Interfaces

Ethernet interfaces can be configured either as access ports or trunk ports. Trunks carry the traffic of multiple VLANs over a single link and allow you to extend VLANs across the network.



### Note

Cisco NX-OS supports only IEEE 802.1Q-type VLAN trunk encapsulation.

This chapter describes the configuration of access or trunk ports on Cisco Nexus 5000 Series switches. It includes the following sections:

- [Information About Access and Trunk Interfaces, page 49](#)
- [Configuring Access and Trunk Interfaces, page 52](#)
- [Verifying Interface Configuration, page 57](#)

## Information About Access and Trunk Interfaces

### Understanding Access and Trunk Interfaces

Ethernet interfaces can be configured either as access ports or a trunk ports, as follows:

- An access port can have only one VLAN configured on the interface; it can carry traffic for only one VLAN.
- A trunk port can have two or more VLANs configured on the interface; it can carry traffic for several VLANs simultaneously.

In order to correctly deliver the traffic on a trunk port with several VLANs, the device uses the IEEE 802.1Q encapsulation or tagging method.

To optimize the performance on access ports, you can configure the port as a host port. Once the port is configured as a host port, it is automatically set as an access port.

If an access port receives a packet with an 802.1Q tag in the header other than the access VLAN value, that port drops the packet without learning its MAC source address.

**Related Topics**

- [Understanding IEEE 802.1Q Encapsulation, page 50](#)

## Understanding IEEE 802.1Q Encapsulation

A trunk is a point-to-point link between the device and another networking device. Trunks carry the traffic of multiple VLANs over a single link and allow you to extend VLANs across an entire network.

To correctly deliver the traffic on a trunk port with several VLANs, the device uses the IEEE 802.1Q encapsulation (tagging) method. This tag carries information about the specific VLAN to which the frame and packet belong. This method allows packets that are encapsulated for several different VLANs to traverse the same port and maintain traffic separation between the VLANs.

**Figure 4: Header without and with 802.1Q Tag Included**

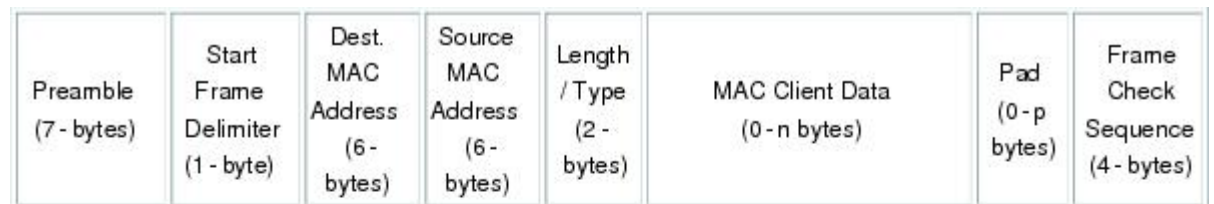

3 bits = User Priority field  
1 bit = Canonical Format Identifier (CFI)  
12 bits = VLAN Identifier (VLAN ID)

183779

## Understanding Access VLANs

When you configure a port in access mode, you can specify which VLAN will carry the traffic for that interface. If you do not configure the VLAN for a port in access mode, or an access port, the interface carries traffic for the default VLAN (VLAN1).

You can change the access port membership in a VLAN by specifying the new VLAN. You must create the VLAN before you can assign it as an access VLAN for an access port. If you change the access VLAN on an access port to a VLAN that is not yet created, the system will shut that access port down.

If an access port receives a packet with an 802.1Q tag in the header other than the access VLAN value, that port drops the packet without learning its MAC source address.

**Note**

If you assign an access VLAN that is also a primary VLAN for a private VLAN, all access ports with that access VLAN will also receive all the broadcast traffic for the primary VLAN in the private VLAN mode.

## Understanding the Native VLAN ID for Trunk Ports

A trunk port can carry untagged packets simultaneously with the 802.1Q tagged packets. When you assign a default port VLAN ID to the trunk port, all untagged traffic travels on the default port VLAN ID for the trunk port, and all untagged traffic is assumed to belong to this VLAN. This VLAN is referred to as the native VLAN ID for a trunk port. The native VLAN ID is the VLAN that carries untagged traffic on trunk ports.

The trunk port sends an egressing packet with a VLAN that is equal to the default port VLAN ID as untagged; all the other egressing packets are tagged by the trunk port. If you do not configure a native VLAN ID, the trunk port uses the default VLAN.

**Note**

Native VLAN ID numbers *must* match on both ends of the trunk.

## Understanding Allowed VLANs

By default, a trunk port sends traffic to and receives traffic from all VLANs. All VLAN IDs are allowed on each trunk. However, you can remove VLANs from this inclusive list to prevent traffic from the specified VLANs from passing over the trunk. You can add any specific VLANs later that you may want the trunk to carry traffic for back to the list.

To partition spanning tree protocol (STP) topology for the default VLAN, you can remove VLAN1 from the list of allowed VLANs. Otherwise, VLAN1, which is enabled on all ports by default, will have a very big STP topology, which can result in problems during STP convergence. When you remove VLAN1, all data traffic for VLAN1 on this port is blocked, but the control traffic continues to move on the port.

## Understanding Native 802.1Q VLANs

To provide additional security for traffic passing through an 802.1Q trunk port, the **vlan dot1q tag native** command was introduced. This feature provides a means to ensure that all packets going out of a 802.1Q trunk port are tagged and to prevent reception of untagged packets on the 802.1Q trunk port.

Without this feature, all tagged ingress frames received on a 802.1Q trunk port are accepted as long as they fall inside the allowed VLAN list and their tags are preserved. Untagged frames are tagged with the native VLAN ID of the trunk port before further processing. If the VLAN tag on a frame happens to match that of the native VLAN on the trunk port, the tag is stripped off and the frame is sent untagged.

This behavior could potentially be exploited to introduce "VLAN hopping" in which a hacker could try and have a frame jump to a different VLAN. It is also possible for traffic to become part of the native VLAN by sending untagged packets into an 802.1Q trunk port.

To address the above issues, the **vlan dot1q tag native** command performs the following functions:

- On the ingress side, all untagged data traffic is dropped.

- On the egress side, all traffic is tagged. If traffic belongs to native VLAN then it is tagged with the native VLAN ID.

This feature is supported on all the directly connected Ethernet and EtherChannel interfaces of the Cisco Nexus 5000 Series switch. It is also supported on all the host interface ports of any attached Cisco Nexus 2000 Series Fabric Extender.



**Note** You can enable the `vlan dot1q tag native` command by issuing the command in the global configuration mode.

## Configuring Access and Trunk Interfaces

### Configuring a LAN Interface as an Ethernet Access Port

You can configure an Ethernet interface as an access port. An access port transmits packets on only one, untagged VLAN. You specify which VLAN traffic that the interface carries. If you do not specify a VLAN for an access port, the interface carries traffic only on the default VLAN. The default VLAN is VLAN1.

The VLAN must exist before you can specify that VLAN as an access VLAN. The system shuts down an access port that is assigned to an access VLAN that does not exist.

#### SUMMARY STEPS

1. switch# **configure terminal**
2. switch(config)# **interface** *{{type slot/port}}* | **{port-channel number}**}
3. switch(config-if)# **switchport mode** *{access | trunk}*}
4. switch(config-if)# **switchport access vlan** *vlan-id*

#### DETAILED STEPS

	Command or Action	Purpose
<b>Step 1</b>	switch# <b>configure terminal</b>	Enters configuration mode.
<b>Step 2</b>	switch(config)# <b>interface</b> <i>{{type slot/port}}</i>   <b>{port-channel number}</b> }	Specifies an interface to configure, and enters interface configuration mode.
<b>Step 3</b>	switch(config-if)# <b>switchport mode</b> <i>{access   trunk}</i> }	Sets the interface as a nontrunking nontagged single-VLAN Ethernet interface. An access port can carry traffic in one VLAN only. By default, an access port carries traffic for VLAN1; to set the access port to carry traffic for a different VLAN, use the <b>switchport access vlan</b> command.
<b>Step 4</b>	switch(config-if)# <b>switchport access vlan</b> <i>vlan-id</i>	Specifies the VLAN for which this access port will carry traffic. If you do not enter this command, the access port carries traffic on VLAN1 only; use this command to change the VLAN for which the access port carries traffic.

	Command or Action	Purpose
--	-------------------	---------

This example shows how to set an interface as an Ethernet access port that carries traffic for a specific VLAN only:

```
switch# configure terminal
switch(config)# interface ethernet 1/10
switch(config-if)# switchport mode access
switch(config-if)# switchport access vlan 5
```

## Configuring Access Host Ports

By using `switchport host`, you can make an access port a spanning-tree edge port, and enable bpdu filtering and bpdu guard at the same time.

### Before You Begin

Ensure that you are configuring the correct interface; it must be an interface that is connected to an end station.

### SUMMARY STEPS

1. `switch# configure terminal`
2. `switch(config)# interface type slot/port`
3. `switch(config-if)# switchport host`

### DETAILED STEPS

	Command or Action	Purpose
<b>Step 1</b>	<code>switch# configure terminal</code>	Enters configuration mode.
<b>Step 2</b>	<code>switch(config)# interface type slot/port</code>	Specifies an interface to configure, and enters interface configuration mode.
<b>Step 3</b>	<code>switch(config-if)# switchport host</code>	Sets the interface to spanning-tree port type edge, turns on bpdu filtering and bpdu guard.  <b>Note</b> Apply this command only to switchports which connect to hosts.

This example shows how to set an interface as an Ethernet access host port with EtherChannel disabled:

```
switch# configure terminal
switch(config)# interface ethernet 1/10
switch(config-if)# switchport host
```

## Configuring Trunk Ports

You can configure an Ethernet port as a trunk port; a trunk port transmits untagged packets for the native VLAN plus encapsulated, tagged, packets for multiple VLANs.



**Note** Cisco NX-OS supports only 802.1Q encapsulation.

To configure a trunk port, perform this task:

### SUMMARY STEPS

1. switch# **configure terminal**
2. switch(config)# **interface** {*type slot/port* | **port-channel number**}
3. switch(config-if)# **switchport mode** {**access** | **trunk**}

### DETAILED STEPS

	Command or Action	Purpose
<b>Step 1</b>	switch# <b>configure terminal</b>	Enters configuration mode.
<b>Step 2</b>	switch(config)# <b>interface</b> { <i>type slot/port</i>   <b>port-channel number</b> }	Specifies an interface to configure, and enters interface configuration mode.
<b>Step 3</b>	switch(config-if)# <b>switchport mode</b> { <b>access</b>   <b>trunk</b> }	Sets the interface as an Ethernet trunk port. A trunk port can carry traffic in one or more VLANs on the same physical link (VLANs are based on the trunk-allowed VLANs list). By default, a trunk interface can carry traffic for all VLANs. To specify that only certain VLANs are allowed on the specified trunk, use the <b>switchport trunk allowed vlan</b> command.

This example shows how to set an interface as an Ethernet trunk port:

```
switch# configure terminal
switch(config)# interface ethernet 1/3
switch(config-if)# switchport mode trunk
```

#### Related Topics

- [Understanding IEEE 802.1Q Encapsulation, page 50](#)

## Configuring the Native VLAN for 802.1Q Trunking Ports

If you do not configure this parameter, the trunk port uses the default VLAN as the native VLAN ID.

## SUMMARY STEPS

1. switch# **configure terminal**
2. switch(config)# **interface** {*type slot/port* | **port-channel number**}
3. switch(config-if)# **switchport trunk native vlan** *vlan-id*

## DETAILED STEPS

	Command or Action	Purpose
<b>Step 1</b>	switch# <b>configure terminal</b>	Enters configuration mode.
<b>Step 2</b>	switch(config)# <b>interface</b> { <i>type slot/port</i>   <b>port-channel number</b> }	Specifies an interface to configure, and enters interface configuration mode.
<b>Step 3</b>	switch(config-if)# <b>switchport trunk native vlan</b> <i>vlan-id</i>	Sets the native VLAN for the 802.1Q trunk. Valid values are from 1 to 4094, except those VLANs reserved for internal use. The default value is VLAN1.

This example shows how to set the native VLAN for an Ethernet trunk port:

```
switch# configure terminal
switch(config)# interface ethernet 1/3
switch(config-if)# switchport trunk native vlan 5
```

## Configuring the Allowed VLANs for Trunking Ports

You can specify the IDs for the VLANs that are allowed on the specific trunk port.

Before you configure the allowed VLANs for the specified trunk ports, ensure that you are configuring the correct interfaces and that the interfaces are trunks.

## SUMMARY STEPS

1. switch# **configure terminal**
2. switch(config)# **interface** {*type slot/port* | **port-channel number**}
3. switch(config-if)# **switchport trunk allowed vlan** {*vlan-list all* | **none** [**add** |*except* | **none** | **remove** {*vlan-list*}]}

## DETAILED STEPS

	Command or Action	Purpose
<b>Step 1</b>	switch# <b>configure terminal</b>	Enters configuration mode.
<b>Step 2</b>	switch(config)# <b>interface</b> { <i>type slot/port</i>   <b>port-channel number</b> }	Specifies an interface to configure, and enters interface configuration mode.

	Command or Action	Purpose
<b>Step 3</b>	switch(config-if)# <b>switchport trunk allowed vlan</b> { <i>vlan-list</i> <b>all</b>   <b>none</b> [ <b>add</b>   <b>except</b>   <b>none</b>   <b>remove</b> { <i>vlan-list</i> }]}	<p>Sets allowed VLANs for the trunk interface. The default is to allow all VLANs on the trunk interface: 1 to 3967 and 4048 to 4094. VLANs 3968 to 4047 are the default VLANs reserved for internal use by default; this group of VLANs is configurable. By default, all VLANs are allowed on all trunk interfaces.</p> <p><b>Note</b> You cannot add internally allocated VLANs as allowed VLANs on trunk ports. The system returns a message if you attempt to list an internally allocated VLAN as an allowed VLAN.</p>

This example shows how to add VLANs to the list of allowed VLANs on an Ethernet trunk port:

```
switch# configure terminal
switch(config)# interface ethernet 1/3
switch(config-if)# switchport trunk allow vlan 15-20
```

## Configuring Native 802.1Q VLANs

Typically, you configure 802.1Q trunks with a native VLAN ID, which strips tagging from all packets on that VLAN. This configuration allows all untagged traffic and control traffic to transit the Cisco Nexus 5000 Series switch. Packets that enter the switch with 802.1Q tags that match the native VLAN ID value are similarly stripped of tagging.

To maintain the tagging on the native VLAN and drop untagged traffic, enter the **vlan dot1q tag native** command. The switch will tag the traffic received on the native VLAN and admit only 802.1Q-tagged frames, dropping any untagged traffic, including untagged traffic in the native VLAN.

Control traffic continues to be accepted untagged on the native VLAN on a trunked port, even when the **vlan dot1q tag native** command is enabled.



**Note** The **vlan dot1q tag native** command is enabled on global basis.

### SUMMARY STEPS

1. switch# **configure terminal**
2. switch(config)# **vlan dot1q tag native**
3. (Optional) switch(config)# **no vlan dot1q tag native**
4. (Optional) switch# **show vlan dot1q tag native**

### DETAILED STEPS

	Command or Action	Purpose
<b>Step 1</b>	switch# <b>configure terminal</b>	Enters configuration mode.

	Command or Action	Purpose
<b>Step 2</b>	switch(config)# <b>vlan dot1q tag native</b>	Enables dot1q (IEEE 802.1Q) tagging for all native VLANs on all trunked ports on the Cisco Nexus 5000 Series switch. By default, this feature is disabled.
<b>Step 3</b>	switch(config)# <b>no vlan dot1q tag native</b>	(Optional) Disables dot1q (IEEE 802.1Q) tagging for all native VLANs on all trunked ports on the switch.
<b>Step 4</b>	switch# <b>show vlan dot1q tag native</b>	(Optional) Displays the status of tagging on the native VLANs.

The following example shows how to enable 802.1Q tagging on the switch:

```
switch# configure terminal
switch(config)# vlan dot1q tag native
switch(config)# exit
switch# show vlan dot1q tag native
vlan dot1q native tag is enabled
```

## Verifying Interface Configuration

To display access and trunk interface configuration information, perform one of these tasks:

Command	Purpose
switch# <b>show interface</b>	Displays the interface configuration
switch# <b>show interface switchport</b>	Displays information for all Ethernet interfaces, including access and trunk interfaces.
switch# <b>show interface brief</b>	Displays interface configuration information.





## CHAPTER 7

# Configuring EtherChannels

---

This chapter describes how to configure EtherChannels and to apply and configure the Link Aggregation Control Protocol (LACP) for more efficient use of EtherChannels in Cisco NX-OS. It contains the following sections:

- [Information About EtherChannels, page 59](#)
- [Configuring EtherChannels, page 66](#)
- [Verifying EtherChannel Configuration, page 74](#)
- [Verifying the Load-Balancing Outgoing Port ID , page 75](#)

## Information About EtherChannels

An EtherChannel bundles up to 16 individual interfaces into a group to provide increased bandwidth and redundancy. Port channeling also load balances traffic across these physical interfaces. The EtherChannel stays operational as long as at least one physical interface within the EtherChannel is operational.

You create an EtherChannel by bundling compatible interfaces. You can configure and run either static EtherChannels or EtherChannels running the Link Aggregation Control Protocol (LACP).

Any configuration changes that you apply to the EtherChannel are applied to each member interface of that EtherChannel. For example, if you configure Spanning Tree Protocol (STP) parameters on the EtherChannel, the Cisco NX-OS applies those parameters to each interface in the EtherChannel.

You can use static EtherChannels, with no associated protocol, for a simplified configuration. For more efficient use of the EtherChannel, you can use the Link Aggregation Control Protocol (LACP), which is defined in IEEE 802.3ad. When you use LACP, the link passes protocol packets.

### Related Topics

- [LACP Overview, page 63](#)

## Understanding EtherChannels

Using EtherChannels, Cisco NX-OS provides wider bandwidth, redundancy, and load balancing across the channels.

An EtherChannel bundles individual links into a channel group to create a single logical link that provides the aggregate bandwidth of up to 16 physical links. If a member port within an EtherChannel fails, traffic previously carried over the failed link switches to the remaining member ports within the EtherChannel.

Each port can be in only one EtherChannel. All the ports in an EtherChannel must be compatible; they must use the same speed and operate in full-duplex mode. When you are running static EtherChannels, without LACP, the individual links are all in the on channel mode.



---

**Note** You cannot change the mode from ON to Active or from ON to Passive.

---

You can create an EtherChannel directly by creating the port-channel interface, or you can create a channel group that acts to aggregate individual ports into a bundle. When you associate an interface with a channel group, Cisco NX-OS creates a matching EtherChannel automatically if the EtherChannel does not already exist. You can also create the EtherChannel first. In this instance, Cisco NX-OS creates an empty channel group with the same channel number as the EtherChannel and takes the default configuration.



---

**Note** An EtherChannel is operationally up when at least one of the member ports is up and that port's status is channeling. The EtherChannel is operationally down when all member ports are operationally down.

---

## Compatibility Requirements

When you add an interface to a channel group, Cisco NX-OS checks certain interface attributes to ensure that the interface is compatible with the channel group. Cisco NX-OS also checks a number of operational attributes for an interface before allowing that interface to participate in the port-channel aggregation.

The compatibility check includes the following operational attributes:

- Port mode
- Access VLAN
- Trunk native VLAN
- Allowed VLAN list
- Speed
- 802.3x flow control setting
- MTU
 

The Cisco Nexus 5000 Series switch only supports system level MTU. This attribute cannot be changed on an individual port basis.
- Broadcast/Unicast/Multicast Storm Control setting
- Priority-Flow-Control
- Untagged CoS

Use the **show port-channel compatibility-parameters** command to see the full list of compatibility checks that Cisco NX-OS uses.

You can only add interfaces configured with the channel mode set to on to static EtherChannels. You can also only add interfaces configured with the channel mode as active or passive to EtherChannels that are running LACP. You can configure these attributes on an individual member port.

When the interface joins an EtherChannel, the following individual parameters are replaced with the values on the EtherChannel:

- Bandwidth
- MAC address
- Spanning Tree Protocol

The following interface parameters remain unaffected when the interface joins an EtherChannel:

- Description
- CDP
- LACP port priority
- Debounce

#### Related Topics

- [Channel Modes, page 65](#)

## Load Balancing Using EtherChannels

Cisco NX-OS load balances traffic across all operational interfaces in an EtherChannel by reducing part of the binary pattern formed from the addresses in the frame to a numerical value that selects one of the links in the channel. EtherChannels provide load balancing by default and the basic configuration uses the following criteria to select the link:

- For a Layer 2 frame, it uses the source and destination MAC addresses.
- For a Layer 3 frame, it uses the source and destination MAC addresses and the source and destination IP addresses.
- For a Layer 4 frame, it uses the source and destination MAC addresses, the source and destination IP addresses, and the source and destination port number.

You can configure the switch to use one of the following methods to load balance across the EtherChannel:

- Destination MAC address
- Source MAC address
- Source and destination MAC address
- Destination IP address
- Source IP address
- Source and destination IP address
- Destination TCP/UDP port number
- Source TCP/UDP port number

- Source and destination TCP/UDP port number

**Table 7: EtherChannel Load-Balancing Criteria for the Cisco Nexus 5000 Series**

Configuration	Layer 2 Criteria	Layer 3 Criteria	Layer 4 Criteria
Destination MAC	Destination MAC	Destination MAC	Destination MAC
Source MAC	Source MAC	Source MAC	Source MAC
Source and destination MAC	Source and destination MAC	Source and destination MAC	Source and destination MAC
Destination IP	Destination MAC	Destination MAC, destination IP	Destination MAC, destination IP
Source IP	Source MAC	Source MAC, source IP	Source MAC, source IP
Source and destination IP	Source and destination MAC	Source and destination MAC, source and destination IP	Source and destination MAC, source and destination IP
Destination TCP/UDP port	Destination MAC	Destination MAC, destination IP	Destination MAC, destination IP, destination port
Source TCP/UDP port	Source MAC	Source MAC, source IP	Source MAC, source IP, source port
Source and destination TCP/UDP port	Source and destination MAC	Source and destination MAC, source and destination IP	Source and destination MAC, source and destination IP, source and destination port

Fabric Extenders are not configurable individually. Fabric extender configurations are defined on the Nexus 5000 Series. In the case of the port-channel load balancing protocol, the table below illustrates which port-channel load balancing option is automatically configured on the fabric extender modules as a result of the configuration performed on the Nexus 5000 Series.

The following table shows the criteria used for each configuration:

**Table 8: EtherChannel Load-Balancing Criteria for the Cisco Nexus 2232 and Cisco Nexus 2248 Fabric Extenders**

Configuration	Layer 2 Criteria	Layer 3 Criteria	Layer 4 Criteria
Destination MAC	Source and destination MAC	Source and destination MAC	Source and destination MAC
Source MAC	Source and destination MAC	Source and destination MAC	Source and destination MAC

Configuration	Layer 2 Criteria	Layer 3 Criteria	Layer 4 Criteria
Source and destination MAC	Source and destination MAC	Source and destination MAC	Source and destination MAC
Destination IP	Source and destination MAC	Source and destination MAC, and source and destination IP	Source and destination MAC, and source and destination IP
Source IP	Source and destination MAC	Source and destination MAC, and source and destination IP	Source and destination MAC, and source and destination IP
Source and destination IP	Source and destination MAC	Source and destination MAC, and source and destination IP	Source and destination MAC, and source and destination IP
Destination TCP/UDP port	Source and destination MAC	Source and destination MAC, and source and destination IP	Source and destination MAC, source and destination IP, and source and destination port
Source TCP/UDP port	Source and destination MAC	Source and destination MAC, and source and destination IP	Source and destination MAC, source and destination IP, and source and destination port
Source and destination TCP/UDP port	Source and destination MAC	Source and destination MAC, source and destination IP	Source and destination MAC, source and destination IP, and source and destination port

Use the option that provides the balance criteria with the greatest variety in your configuration. For example, if the traffic on an EtherChannel is going only to a single MAC address and you use the destination MAC address as the basis of port-channel load balancing, the EtherChannel always chooses the same link in that EtherChannel; using source addresses or IP addresses might result in better load balancing.

## Understanding LACP

### LACP Overview



**Note**

You must enable the LACP feature before you can configure and use LACP functions.

The following figure shows how individual links can be combined into LACP EtherChannels and channel groups as well as function as individual links.

**Figure 5: Individual Links Combined into an EtherChannel**

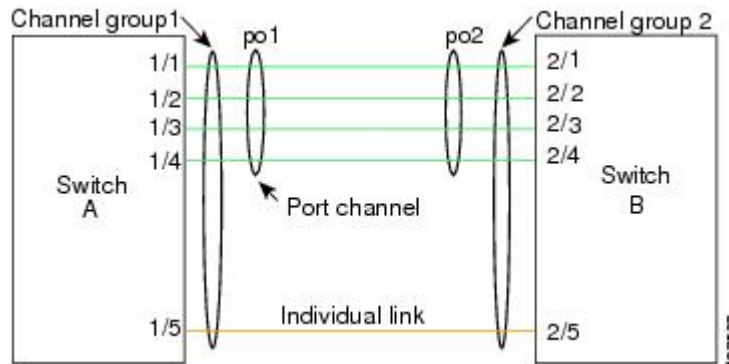

With LACP, just like with static port-channels, you can bundle up to 16 interfaces in a channel group.



**Note**

When you delete the EtherChannel, Cisco NX-OS automatically deletes the associated channel group. All member interfaces revert to their previous configuration.

You cannot disable LACP while any LACP configurations are present.

## LACP ID Parameters

LACP uses the following parameters:

- LACP system priority—Each system that runs LACP has an LACP system priority value. You can accept the default value of 32768 for this parameter, or you can configure a value between 1 and 65535. LACP uses the system priority with the MAC address to form the system ID and also uses the system priority during negotiation with other devices. A higher system priority value means a lower priority.



**Note**

The LACP system ID is the combination of the LACP system priority value and the MAC address.

- LACP port priority—Each port configured to use LACP has an LACP port priority. You can accept the default value of 32768 for the LACP port priority, or you can configure a value between 1 and 65535. LACP uses the port priority with the port number to form the port identifier. LACP uses the port priority to decide which ports should be put in standby mode when there is a limitation that prevents all compatible ports from aggregating and which ports should be put into active mode. A higher port priority value means a lower priority for LACP. You can configure the port priority so that specified ports have a lower priority for LACP and are most likely to be chosen as active links, rather than hot-standby links.
- LACP administrative key—LACP automatically configures an administrative key value equal to the channel-group number on each port configured to use LACP. The administrative key defines the ability of a port to aggregate with other ports. A port's ability to aggregate with other ports is determined by these factors:

- Port physical characteristics, such as the data rate, the duplex capability, and the point-to-point or shared medium state
- Configuration restrictions that you establish

## Channel Modes

Individual interfaces in EtherChannels are configured with channel modes. When you run static EtherChannels, with no protocol, the channel mode is always set to on. After you enable LACP globally on the device, you enable LACP for each channel by setting the channel mode for each interface to active or passive. You can configure either channel mode for individual links in the LACP channel group.



### Note

You must enable LACP globally before you can configure an interface in either the active or passive channel mode.

The following table describes the channel modes.

**Table 9: Channel Modes for Individual Links in an EtherChannel**

Channel Mode	Description
passive	LACP mode that places a port into a passive negotiating state, in which the port responds to LACP packets that it receives but does not initiate LACP negotiation.
active	LACP mode that places a port into an active negotiating state, in which the port initiates negotiations with other ports by sending LACP packets.
on	All static EtherChannels, that is, that are not running LACP, remain in this mode. If you attempt to change the channel mode to active or passive before enabling LACP, the device returns an error message.  You enable LACP on each channel by configuring the interface in that channel for the channel mode as either active or passive. When an LACP attempts to negotiate with an interface in the on state, it does not receive any LACP packets and becomes an individual link with that interface; it does not join the LACP channel group.

Both the passive and active modes allow LACP to negotiate between ports to determine if they can form an EtherChannel, based on criteria such as the port speed and the trunking state. The passive mode is useful when you do not know whether the remote system, or partner, supports LACP.

Ports can form an LACP EtherChannel when they are in different LACP modes as long as the modes are compatible as in the following examples:

- A port in active mode can form an EtherChannel successfully with another port that is in active mode.
- A port in active mode can form an EtherChannel with another port in passive mode.
- A port in passive mode cannot form an EtherChannel with another port that is also in passive mode because neither port will initiate negotiation.
- A port in on mode is not running LACP.

## LACP Marker Responders

Using EtherChannels, data traffic may be dynamically redistributed due to either a link failure or load balancing. LACP uses the Marker Protocol to ensure that frames are not duplicated or reordered because of this redistribution. Cisco NX-OS supports only Marker Responders.

## LACP-Enabled and Static EtherChannels Differences

The following table provides a brief summary of major differences between EtherChannels with LACP enabled and static EtherChannels.

**Table 10: EtherChannels with LACP Enabled and Static EtherChannels**

Configurations	EtherChannels with LACP Enabled	Static EtherChannels
Protocol applied	Enable globally.	Not applicable.
Channel mode of links	Can be either: <ul style="list-style-type: none"> <li>• Active</li> <li>• Passive</li> </ul>	Can only be On.
Maximum number of links in channel	16	16

# Configuring EtherChannels

## Creating an EtherChannel

You can create an EtherChannel before creating a channel group. Cisco NX-OS automatically creates the associated channel group.



**Note**

If you want LACP-based EtherChannels, you need to enable LACP.

**SUMMARY STEPS**

1. switch# **configure terminal**
2. switch(config)# **interface port-channel** *channel-number*
3. switch(config)# **no interface port-channel** *channel-number*

**DETAILED STEPS**

	Command or Action	Purpose
<b>Step 1</b>	switch# <b>configure terminal</b>	Enters configuration mode.
<b>Step 2</b>	switch(config)# <b>interface port-channel</b> <i>channel-number</i>	Specifies the port-channel interface to configure, and enters the interface configuration mode. The range is from 1 to 4096. Cisco NX-OS automatically creates the channel group if it does not already exist.
<b>Step 3</b>	switch(config)# <b>no interface port-channel</b> <i>channel-number</i>	Removes the EtherChannel and deletes the associated channel group.

This example shows how to create an EtherChannel:

```
switch# configure terminal
switch (config)# interface port-channel 1
```

**Adding a Port to an EtherChannel**

You can add a port to a new channel group or to a channel group that already contains ports. Cisco NX-OS creates the EtherChannel associated with this channel group if the EtherChannel does not already exist.

**Note**

If you want LACP-based EtherChannels, you need to enable LACP.

**SUMMARY STEPS**

1. switch# **configure terminal**
2. switch(config)# **interface** *type slot/port*
3. (Optional) switch(config-if)# **switchport mode trunk**
4. (Optional) switch(config-if)# **switchport trunk** {**allowed vlan** *vlan-id* | **native vlan** *vlan-id*}
5. switch(config-if)# **channel-group** *channel-number*
6. (Optional) switch(config-if)# **no channel-group**

## DETAILED STEPS

	Command or Action	Purpose
Step 1	switch# <b>configure terminal</b>	Enters configuration mode.
Step 2	switch(config)# <b>interface</b> <i>type slot/port</i>	Specifies the interface that you want to add to a channel group and enters the interface configuration mode.
Step 3	switch(config-if)# <b>switchport mode trunk</b>	(Optional) Configures the interface as a trunk port.
Step 4	switch(config-if)# <b>switchport trunk</b> { <b>allowed vlan</b> <i>vlan-id</i>   <b>native vlan</b> <i>vlan-id</i> }	(Optional) Configures necessary parameters for a trunk port.
Step 5	switch(config-if)# <b>channel-group</b> <i>channel-number</i>	Configures the port in a channel group and sets the mode. The channel-number range is from 1 to 4096. Cisco NX-OS creates the EtherChannel associated with this channel group if the EtherChannel does not already exist. This is called implicit EtherChannel creation.
Step 6	switch(config-if)# <b>no channel-group</b>	(Optional) Removes the port from the channel group. The port reverts to its original configuration.

This example shows how to add an Ethernet interface 1/4 to channel group 1:

```
switch# configure terminal
switch (config)# interface ethernet 1/4
switch(config-if)# switchport mode trunk
switch(config-if)# channel-group 1
```

## Related Topics

- [Enabling LACP, page 70](#)

## Configuring Load Balancing Using EtherChannels

You can configure the load-balancing algorithm for EtherChannels that applies to the entire device.



## Note

If you want LACP-based EtherChannels, you need to enable LACP.

## SUMMARY STEPS

1. switch# **configure terminal**
2. switch(config)# **port-channel load-balance** ethernet {**destination-ip** | **destination-mac** | **destination-port** | **source-dest-ip** | **source-dest-mac** | **source-dest-port** | **source-ip** | **source-mac** | **source-port**}
3. (Optional) switch(config)# **no port-channel load-balance** ethernet
4. (Optional) switch# **show port-channel load-balance**

## DETAILED STEPS

	Command or Action	Purpose
Step 1	switch# <b>configure terminal</b>	Enters configuration mode.
Step 2	switch(config)# <b>port-channel load-balance ethernet</b> { <b>destination-ip</b>   <b>destination-mac</b>   <b>destination-port</b>   <b>source-dest-ip</b>   <b>source-dest-mac</b>   <b>source-dest-port</b>   <b>source-ip</b>   <b>source-mac</b>   <b>source-port</b> }	Specifies the load-balancing algorithm for the device. The range depends on the device. The default is source-dest-mac.
Step 3	switch(config)# <b>no port-channel load-balance ethernet</b>	(Optional) Restores the default load-balancing algorithm of source-dest-mac.
Step 4	switch# <b>show port-channel load-balance</b>	(Optional) Displays the port-channel load-balancing algorithm.

This example shows how to configure source IP load balancing for EtherChannels:

```
switch# configure terminal
switch (config)# port-channel load-balance ethernet source-ip
```

**Note**

Before Release 4.0(1a)N1 of Cisco NX-OS, the source-dest-ip, source-dest-mac, and source-dest-port keywords were source-destination-ip, source-destination-mac, and source-destination-port, respectively.

**Related Topics**

- [Enabling LACP, page 70](#)

## Configuring Hardware Hashing for Multicast Traffic

By default, ingress multicast traffic on any port in the switch selects a particular EtherChannel member to egress the traffic. You can configure hardware hashing for multicast traffic to reduce potential bandwidth issues and to provide effective load balancing of the ingress multicast traffic. Use the **hardware multicast hw-hash** command to enable hardware hashing. To restore the default, use the **no hardware multicast hw-hash** command.

## SUMMARY STEPS

1. switch# **configure terminal**
2. switch(config)# **interface port-channel** *channel-number*
3. switch(config-if)# **hardware multicast hw-hash**

## DETAILED STEPS

	Command or Action	Purpose
<b>Step 1</b>	switch# <b>configure terminal</b>	Enters configuration mode.
<b>Step 2</b>	switch(config)# <b>interface port-channel</b> <i>channel-number</i>	Selects the EtherChannel and enters the interface configuration mode.
<b>Step 3</b>	switch(config-if)# <b>hardware multicast hw-hash</b>	Configures hardware hashing for the specified EtherChannel.

This example shows how to configure hardware hashing on an EtherChannel:

```
switch# configure terminal
switch (config)# interface port-channel 21
switch(config-if)# hardware multicast hw-hash
```

This example shows how to remove hardware hashing from an EtherChannel:

```
switch# configure terminal
switch (config)# interface port-channel 21
switch(config-if)# no hardware multicast hw-hash
```

## Enabling LACP

LACP is disabled by default; you must enable LACP before you begin LACP configuration. You cannot disable LACP while any LACP configuration is present.

LACP learns the capabilities of LAN port groups dynamically and informs the other LAN ports. Once LACP identifies correctly matched Ethernet links, it facilitates grouping the links into an EtherChannel. The EtherChannel is then added to the spanning tree as a single bridge port.

## SUMMARY STEPS

1. switch# **configure terminal**
2. switch(config)# **feature lacp**
3. (Optional) switch(config)# **show feature**

## DETAILED STEPS

	Command or Action	Purpose
<b>Step 1</b>	switch# <b>configure terminal</b>	Enters configuration mode.
<b>Step 2</b>	switch(config)# <b>feature lacp</b>	Enables LACP on the switch.
<b>Step 3</b>	switch(config)# <b>show feature</b>	(Optional) Displays enabled features.

This example shows how to enable LACP:

```
switch# configure terminal
switch(config)# feature lacp
```

## Configuring Channel Mode for a Port

You can configure the channel mode for each individual link in the LACP EtherChannel as active or passive. This channel configuration mode allows the link to operate with LACP.

When you configure EtherChannels with no associated protocol, all interfaces on both sides of the link remain in the on channel mode.

### Before You Begin

Ensure that you have enabled the LACP feature.

### SUMMARY STEPS

1. switch# **configure terminal**
2. switch(config)# **interface** *type slot/port*
3. switch(config-if)# **channel-group** *number* **mode** {**active** | **on** | **passive**}
4. switch(config-if)# **no channel-group** *number* **mode**

### DETAILED STEPS

	Command or Action	Purpose
<b>Step 1</b>	switch# <b>configure terminal</b>	Enters configuration mode.
<b>Step 2</b>	switch(config)# <b>interface</b> <i>type slot/port</i>	Specifies the interface to configure, and enters the interface configuration mode.
<b>Step 3</b>	switch(config-if)# <b>channel-group</b> <i>number</i> <b>mode</b> { <b>active</b>   <b>on</b>   <b>passive</b> }	Specifies the port mode for the link in an EtherChannel. After LACP is enabled, you configure each link or the entire channel as active or passive.  When you run EtherChannels with no associated protocol, the channel mode is always on.  The default channel mode is on.
<b>Step 4</b>	switch(config-if)# <b>no channel-group</b> <i>number</i> <b>mode</b>	Returns the port mode to on for the specified interface.

This example shows how to set the LACP-enabled interface to active port-channel mode for Ethernet interface 1/4 in channel group 5:

```
switch# configure terminal
switch (config)# interface ethernet 1/4
switch(config-if)# channel-group 5 mode active
```

## Configuring the LACP Fast Timer Rate

You can change the LACP timer rate to modify the duration of the LACP timeout. Use the **lACP rate** command to set the rate at which LACP control packets are sent to an LACP-supported interface. You can change the timeout rate from the default rate (30 seconds) to the fast rate (1 second). This command is supported only on LACP-enabled interfaces.

### Before You Begin

Ensure that you have enabled the LACP feature.

### SUMMARY STEPS

1. switch# **configure terminal**
2. switch(config)# **interface type slot/port**
3. switch(config-if)# **lACP rate fast**

### DETAILED STEPS

	Command or Action	Purpose
<b>Step 1</b>	switch# <b>configure terminal</b>	Enters configuration mode.
<b>Step 2</b>	switch(config)# <b>interface type slot/port</b>	Specifies the interface to configure and enters the interface configuration mode.
<b>Step 3</b>	switch(config-if)# <b>lACP rate fast</b>	Configures the fast rate (one second) at which LACP control packets are sent to an LACP-supported interface.

This example shows how to configure the LACP fast rate on Ethernet interface 1/4:

```
switch# configure terminal
switch (config)# interface ethernet 1/4
switch(config-if)# lACP rate fast
```

This example shows how to restore the LACP default rate (30 seconds) on Ethernet interface 1/4.

```
switch# configure terminal
switch (config)# interface ethernet 1/4
switch(config-if)# no lACP rate fast
```

## Configuring the LACP System Priority and System ID

The LACP system ID is the combination of the LACP system priority value and the MAC address.

### Before You Begin

Ensure that you have enabled the LACP feature.

**SUMMARY STEPS**

1. switch# **configure terminal**
2. switch(config)# **lacp system-priority** *priority*
3. (Optional) switch# **show lacp system-identifier**

**DETAILED STEPS**

	Command or Action	Purpose
<b>Step 1</b>	switch# <b>configure terminal</b>	Enters configuration mode.
<b>Step 2</b>	switch(config)# <b>lacp system-priority</b> <i>priority</i>	Configures the system priority for use with LACP. Valid values are 1 through 65535, and higher numbers have lower priority. The default value is 32768.
<b>Step 3</b>	switch# <b>show lacp system-identifier</b>	(Optional) Displays the LACP system identifier.

This example shows how to set the LACP system priority to 2500:

```
switch# configure terminal
switch(config)# lacp system-priority 2500
```

## Configuring the LACP Port Priority

You can configure each link in the LACP EtherChannel for the port priority.

**Before You Begin**

Ensure that you have enabled the LACP feature.

**SUMMARY STEPS**

1. switch# **configure terminal**
2. switch(config)# **interface** *type slot/port*
3. switch(config-if)# **lacp port-priority** *priority*

**DETAILED STEPS**

	Command or Action	Purpose
<b>Step 1</b>	switch# <b>configure terminal</b>	Enters configuration mode.
<b>Step 2</b>	switch(config)# <b>interface</b> <i>type slot/port</i>	Specifies the interface to configure, and enters the interface configuration mode.

	Command or Action	Purpose
Step 3	switch(config-if)# <b>lACP port-priority</b> <i>priority</i>	Configures the port priority for use with LACP. Valid values are 1 through 65535, and higher numbers have lower priority. The default value is 32768.

This example shows how to set the LACP port priority for Ethernet interface 1/4 to 40000:

```
switch# configure terminal
switch (config)# interface ethernet 1/4
switch(config-if)# lACP port priority 40000
```

## Verifying EtherChannel Configuration

To display EtherChannel configuration information, perform one of the following tasks:

Command	Purpose
switch# <b>show interface port-channel</b> <i>channel-number</i>	Displays the status of a EtherChannel interface.
switch# <b>show feature</b>	Displays enabled features.
switch# <b>show resource</b>	Displays the number of resources currently available in the system.
switch# <b>show lACP</b> { <b>counters</b>   <b>interface type slot/port</b>   <b>neighbor</b>   <b>port-channel</b>   <b>system-identifier</b> }	Displays LACP information.
switch# <b>show port-channel compatibility-parameters</b>	Displays the parameters that must be the same among the member ports in order to join an EtherChannel.
switch# <b>show port-channel database</b> [ <b>interface port-channel</b> <i>channel-number</i> ]	Displays the aggregation state for one or more port-channel interfaces.
switch# <b>show port-channel summary</b>	Displays a summary for the EtherChannel interfaces.
switch# <b>show port-channel traffic</b>	Displays the traffic statistics for EtherChannels.
switch# <b>show port-channel usage</b>	Displays the range of used and unused channel numbers.
switch# <b>show port-channel database</b>	Displays information on current running of the EtherChannel feature.
switch# <b>show port-channel load-balance</b>	Displays information about load-balancing using EtherChannels.

# Verifying the Load-Balancing Outgoing Port ID

## Command Guidelines

The **show port-channel load-balance** command allows you to verify which ports a given frame is hashed to on a port channel. You need to specify the VLAN and the destination MAC in order to get accurate results.



### Note

Certain traffic flows are not subject to hashing, for example when there is a single port in a port-channel.

To display the load-balancing outgoing port ID, perform one of the tasks listed in the table below.

Command	Purpose
switch# <b>show port-channel load-balance forwarding-path interface port-channel <i>port-channel-id</i> vlan <i>vlan-id</i> dst-ip <i>src-ip</i> dst-mac <i>src-mac</i> l4-src-port <i>port-id</i> l4-dst-port <i>port-id</i></b>	Displays the outgoing port ID.

## Example

The following example shows the output of the short **port-channel load-balance** command.

```
switch#show port-channel load-balance forwarding-path interface port-channel 10 vlan 1 dst-ip
1.225.225.225 src-ip 1.1.10.10 src-mac aa:bb:cc:dd:ee:ff l4-src-port 0 l4-dst-port 1
```

```
Missing params will be substituted by 0's.Load-balance Algorithm on switch:
source-dest-portcrc8_hash: 204 Outgoing port id: Ethernet1/1 Param(s) used
to calculate load-balance:
```

```
dst-port: 1
```

```
src-port: 0
```

```
dst-ip: 1.225.225.225
```

```
src-ip: 1.1.10.10
```

```
dst-mac: 0000.0000.0000
```

```
src-mac: aabb.ccdd.eeff
```





## CHAPTER 8

# Configuring Virtual Port Channels

---

This chapter describes how to configure virtual port channels (vPCs) on Cisco Nexus 5000 Series switches. It contains the following sections:

- [Information About vPCs, page 77](#)
- [vPC Guidelines and Limitations, page 88](#)
- [Configuring vPCs, page 89](#)
- [Verifying the vPC Configuration, page 100](#)
- [vPC Example Configurations, page 101](#)
- [vPC Default Settings, page 105](#)

## Information About vPCs

### vPC Overview

A virtual port channel (vPC) allows links that are physically connected to two different Cisco Nexus 5000 Series switches or Cisco Nexus 2000 Series Fabric Extenders to appear as a single port channel by a third device (see the following figure). The third device can be a switch, server, or any other networking device. Beginning with Cisco NX-OS Release 4.1(3)N1(1), you can configure vPCs in topologies that include Cisco Nexus 5000 Series switches connected to the Fabric Extender. A vPC can provide multipathing, which allows

you to create redundancy by enabling multiple parallel paths between nodes and load balancing traffic where alternative paths exist.

**Figure 6: vPC Architecture**

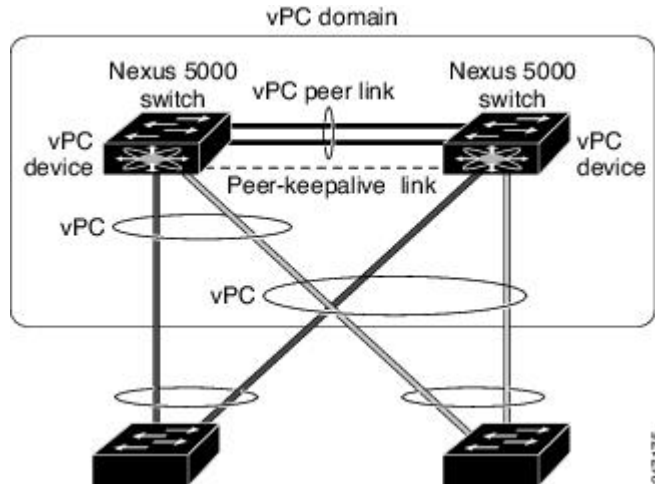

You configure the EtherChannels by using one of the following:

- No protocol
- Link Aggregation Control Protocol (LACP)

When you configure the EtherChannels in a vPC—including the vPC peer link channel—each switch can have up to 16 active links in a single EtherChannel.



**Note**

You must enable the vPC feature before you can configure or run the vPC functionality.

To enable the vPC functionality, you must create a peer-keepalive link and a peer-link under the vPC domain for the two vPC peer switches to provide the vPC functionality.

To create a vPC peer link you configure an EtherChannel on one Cisco Nexus 5000 Series switch by using two or more Ethernet ports. On the other switch, you configure another EtherChannel again using two or more Ethernet ports. Connecting these two EtherChannels together creates a vPC peer link.



**Note**

We recommend that you configure the vPC peer-link EtherChannels as trunks.

The vPC domain includes both vPC peer devices, the vPC peer-keepalive link, the vPC peer link, and all of the EtherChannels in the vPC domain connected to the downstream device. You can have only one vPC domain ID on each vPC peer device.



**Note**

Always attach all vPC devices using EtherChannels to both vPC peer devices.

A vPC provides the following benefits:

- Allows a single device to use an EtherChannel across two upstream devices
- Eliminates Spanning Tree Protocol (STP) blocked ports
- Provides a loop-free topology
- Uses all available uplink bandwidth
- Provides fast convergence if either the link or a switch fails
- Provides link-level resiliency
- Assures high availability

## Terminology

### vPC Terminology

The terminology used in vPCs is as follows:

- vPC—The combined EtherChannel between the vPC peer devices and the downstream device.
- vPC peer device—One of a pair of devices that are connected with the special EtherChannel known as the vPC peer link.
- vPC peer link—The link used to synchronize states between the vPC peer devices.
- vPC member port—Interfaces that belong to the vPCs.
- Host vPC port—Fabric Extender host interfaces that belong to a vPC.
- vPC domain—This domain includes both vPC peer devices, the vPC peer-keepalive link, and all of the port channels in the vPC connected to the downstream devices. It is also associated to the configuration mode that you must use to assign vPC global parameters. The vPC domain ID must be the same on both switches.
- vPC peer-keepalive link—The peer-keepalive link monitors the vitality of a vPC peer Cisco Nexus 5000 Series device. The peer-keepalive link sends configurable, periodic keepalive messages between vPC peer devices.

No data or synchronization traffic moves over the vPC peer-keepalive link; the only traffic on this link is a message that indicates that the originating switch is operating and running vPCs.

### Fabric Extender Terminology

The terminology used for the Cisco Nexus 2000 Series Fabric Extender is as follows:

- Fabric interface—A 10-Gigabit Ethernet uplink port designated for connection from the Fabric Extender to its parent switch. A fabric interface cannot be used for any other purpose. It must be directly connected to the parent switch.
- EtherChannel fabric interface—An EtherChannel uplink connection from the Fabric Extender to its parent switch. This connection consists of fabric interfaces bundled into a single logical channel.
- Host interface—An Ethernet interface for server or host connectivity. These ports are 1-Gigabit Ethernet interfaces or 10-Gigabit Ethernet interfaces, depending on the fabric extender model.

- EtherChannel host interface—An EtherChannel downlink connection from the Fabric Extender host interface to a server port.

For further information about the Fabric Extender, refer to the *Cisco Nexus 2000 Series Fabric Extender Software Configuration Guide*.

## Supported vPC Topologies

### Cisco Nexus 5000 Series Switch vPC Topology

You can connect a pair of Cisco Nexus 5000 Series switches configured in a vPC directly to another switch or to a server. Up to 8 interfaces could be connected to each Cisco Nexus 5000 Series switch providing 16 interfaces bundled for the vPC pair. The topology that is shown in the following figure provides the vPC functionality to dual connected switches or servers with 10-Gigabit or 1-Gigabit Ethernet uplink interfaces.

**Figure 7: Cisco Nexus 5000 Series Switch-to-Switch vPC Topology**

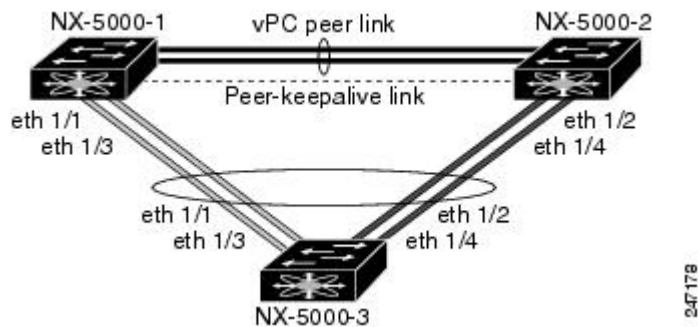

#### Note

The first 8 ports on the Cisco Nexus 5010 switch and the first 16 ports on the Cisco Nexus 5020 switch are switchable 1-Gigabit and 10-Gigabit ports. You can enable vPC functionality on these ports in 1-Gigabit mode.

The switch connected to the pair of Cisco Nexus 5000 Series switches can be any standards-based Ethernet switch. Common environments to use this configuration include Blade Chassis with dual switches connected to the pair of Cisco Nexus 5000 Series switches through vPC or Unified Computing Systems connected to the pair of Cisco Nexus 5000 Series switches.

### Single Homed Fabric Extender vPC Topology

You can connect a server with dual or quad or more network adapters that are configured in a vPC to a pair of Cisco Nexus 2000 Series Fabric Extenders which are connected to the Cisco Nexus 5000 Series switches as depicted. Depending on the FEX model, you may be able to connect one or more network adapter interfaces to each fabric extender. As an example, Figure 10 refers to a topology built with the Cisco Nexus 2148T fabric extender, where a server has one link only to each fabric extender. A topology with Cisco Nexus 2248TP or with Cisco Nexus 2232PP fabric extender could consist of more links from the server to a single fabric extender.

. The topology that is shown in the following figure provides the vPC functionality to dual homed servers with 1-Gigabit Ethernet uplink interfaces.

**Figure 8: Single Homed Fabric Extender vPC Topology**

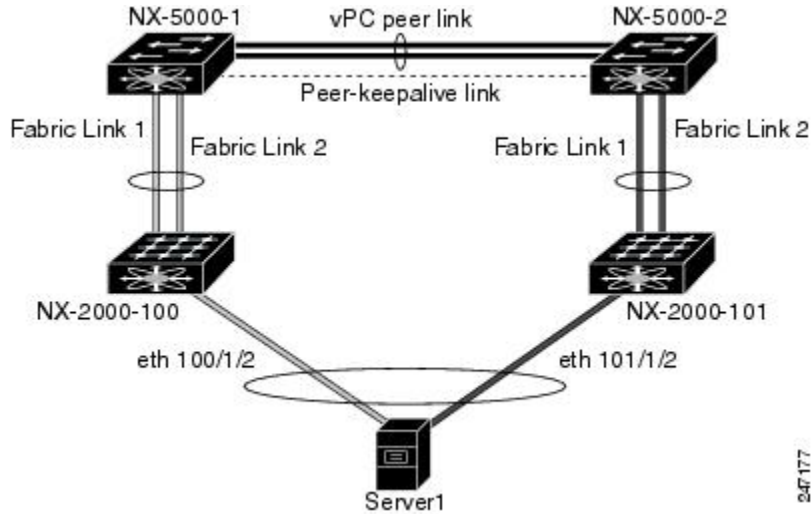

The Cisco Nexus 5000 Series switch can support up to 12 configured single homed Fabric Extenders (576 ports) with this topology however only dual homed host servers can be configured in a vPCs with this configuration.



**Note**

The Cisco Nexus 2148T fabric extender does not support EtherChannels on its host interfaces. Therefore a maximum of two links can be configured in an EtherChannel from the server where each link is connected to a separate Fabric Extender.

## Dual Homed Fabric Extender vPC Topology

You can connect the Cisco Nexus 2000 Series Fabric Extender to two upstream Cisco Nexus 5000 Series switches and downstream to a number of single homed servers. The topology shown in the following figure provides the vPC functionality to singly connected servers with 1-Gigabit Ethernet uplink interfaces.

**Figure 9: Dual Homed Fabric Extender vPC Topology**

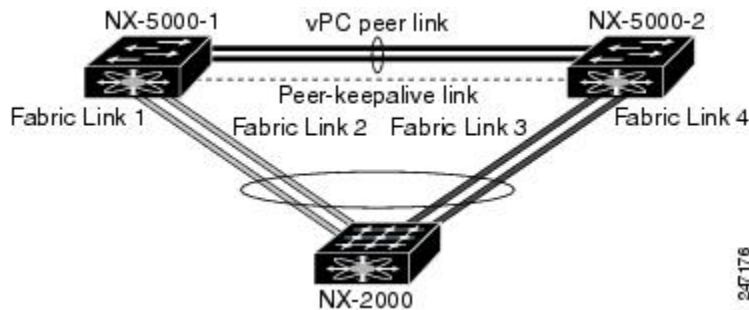

The Cisco Nexus 5000 Series switch can support up to 12 configured dual homed Fabric Extenders with this topology. A maximum of 576 single homed servers can be connected to this configuration.

## vPC Domain

To create a vPC domain, you must first create a vPC domain ID on each vPC peer switch using a number from 1 to 1000. This ID must be the same on a set of vPC peer devices.

You can configure the EtherChannels and vPC peer links by using LACP or no protocol. When possible, we recommend that you use LACP on the peer-link, because LACP provides configuration checks against a configuration mismatch on the etherchannel.

The vPC peer switches use the vPC domain ID that you configure to automatically assign a unique vPC system MAC address. Each vPC domain has a unique MAC address that is used as a unique identifier for the specific vPC-related operations, although the switches use the vPC system MAC addresses only for link-scope operations, such as LACP. We recommend that you create each vPC domain within the contiguous network with a unique domain ID. You can also configure a specific MAC address for the vPC domain, rather than having the Cisco NX-OS software assign the address.

The vPC peer switches use the vPC domain ID that you configure to automatically assign a unique vPC system MAC address. The switches use the vPC system MAC addresses only for link-scope operations, such as LACP or BPDUs. You can also configure a specific MAC address for the vPC domain.

After you create a vPC domain, the Cisco NX-OS software automatically creates a system priority for the vPC domain. You can also manually configure a specific system priority for the vPC domain.



---

**Note**

If you manually configure the system priority, you must ensure that you assign the same priority value on both vPC peer switches. If the vPC peer switches have different system priority values, the vPC will not come up.

---

## Peer-Keepalive Link and Messages

The Cisco NX-OS software uses a peer-keepalive link between the vPC peers to transmit periodic, configurable keepalive messages. You must have Layer 3 connectivity between the peer switches to transmit these messages; the system cannot bring up the vPC peer link unless a peer-keepalive link is already up and running.

If one of the vPC peer switches fails, the vPC peer switch on the other side of the vPC peer link senses the failure when it does not receive any peer-keepalive messages. The default interval time for the vPC peer-keepalive message is 1 second. You can configure the interval between 400 milliseconds and 10 seconds. You can also configure a timeout value with a range of 3 to 20 seconds; the default timeout value is 5 seconds. The peer-keepalive status is checked only when the peer-link goes down.

The vPC peer-keepalive can be carried either in the management or default VRF on the Cisco Nexus 5000 Series switch. When you configure the switches to use the management VRF, the source and destination for the keepalive messages are the mgmt 0 interface IP addresses. When you configure the switches to use the default VRF, an SVI must be created to act as the source and destination addresses for the vPC peer-keepalive messages. Ensure that both the source and destination IP addresses used for the peer-keepalive messages are unique in your network and these IP addresses are reachable from the VRF associated with the vPC peer-keepalive link.

**Note**

We recommend that you configure the vPC peer-keepalive link on the Cisco Nexus 5000 Series switch to run in the management VRF using the mgmt 0 interfaces. If you configure the default VRF, ensure that the vPC peer link is not used to carry the vPC peer-keepalive messages.

## Compatibility Parameters for vPC Peer Links

Many configuration and operational parameters must be identical on all interfaces in the vPC. After you enable the vPC feature and configure the peer link on both vPC peer switches, Cisco Fabric Services (CFS) messages provide a copy of the configuration on the local vPC peer switch configuration to the remote vPC peer switch. The system then determines whether any of the crucial configuration parameters differ on the two switches.

Enter the **show vpc consistency-parameters** command to display the configured values on all interfaces in the vPC. The displayed configurations are only those configurations that would limit the vPC peer link and vPC from coming up.

The compatibility check process for vPCs differs from the compatibility check for regular EtherChannels.

## Configuration Parameters That Must Be Identical

The configuration parameters in this section must be configured identically on both switches at either end of the vPC peer link or the vPC is moved into suspend mode.

**Note**

You must ensure that all interfaces in the vPC have the identical operational and configuration parameters listed in this section.

Enter the **show vpc consistency-parameters** command to display the configured values on all interfaces in the vPC. The displayed configurations are only those configurations that would limit the vPC peer link and vPC from coming up.

The switch automatically check for compatibility of these parameters on the vPC interfaces. The per-interface parameters must be consistent per interface, and the global parameters must be consistent globally.

- Port-channel mode: on, off, or active
- Link speed per channel
- Duplex mode per channel
- Trunk mode per channel:
  - Native VLAN
  - VLANs allowed on trunk
  - Tagging of native VLAN traffic
- Spanning Tree Protocol (STP) mode
- STP region configuration for Multiple Spanning Tree (MST)
- Enable or disable state per VLAN

- STP global settings:
  - Bridge Assurance setting
  - Port type setting—We recommend that you set all vPC interfaces as normal ports
  - Loop Guard settings
- STP interface settings:
  - Port type setting
  - Loop Guard
  - Root Guard
- Maximum Transmission Unit (MTU)
- Quality of Service global settings
  - System QoS policy
  - System Network-QoS policy
  - System Input Queuing policy
  - System Output Queuing policy
- For the Fabric Extender vPC topology, all the interface level parameters mentioned above should be identically configured for host interface from both the switches.
- Fabric Extender FEX number configured on an EtherChannel fabric interface; for the Fabric Extender vPC topology.

If any of these parameters are not enabled or defined on either switch, the vPC consistency check ignores those parameters.

**Note**

---

To ensure that none of the vPC interfaces are in the suspend mode, enter the **show vpc brief** and **show vpc consistency-parameters** commands and check the syslog messages.

---

## Configuration Parameters That Should Be Identical

When any of the following parameters are not configured identically on both vPC peer switches, a misconfiguration may cause undesirable behavior in the traffic flow:

- MAC aging timers
- Static MAC entries
- VLAN interface—Each switch on the end of the vPC peer link must have a VLAN interface configured for the same VLAN on both ends and they must be in the same administrative and operational mode. Those VLANs configured on only one switch of the peer link do not pass traffic using the vPC or peer link. You must create all VLANs on both the primary and secondary vPC switches, or the VLAN will be suspended.
- Private VLAN configuration

- All ACL configurations and parameters
- Quality of service (QoS) configuration and parameters—Local parameters; global parameters must be identical
- STP interface settings:
  - BPDU Filter
  - BPDU Guard
  - Cost
  - Link type
  - Priority
  - VLANs (Rapid PVST+)

To ensure that all the configuration parameters are compatible, we recommend that you display the configurations for each vPC peer switch once you configure the vPC.

## vPC Peer Links

A vPC peer link is the link that is used to synchronize the states between the vPC peer devices.

**Note**

You must configure the peer-keepalive link before you configure the vPC peer link or the peer link will not come up.

## vPC Peer Link Overview

You can have only two switches as vPC peers; each switch can serve as a vPC peer to only one other vPC peer. The vPC peer switches can also have non-vPC links to other switches.

To make a valid configuration, you configure an EtherChannel on each switch and then configure the vPC domain. You assign the EtherChannel on each switch as a peer link. For redundancy, we recommend that you should configure at least two dedicated ports into the EtherChannel; if one of the interfaces in the vPC peer link fails, the switch automatically falls back to use another interface in the peer link.

**Note**

We recommend that you configure the EtherChannels in trunk mode.

Many operational parameters and configuration parameters must be the same in each switch connected by a vPC peer link. Because each switch is completely independent on the management plane, you must ensure that the switches are compatible on the critical parameters. vPC peer switches have separate control planes. After configuring the vPC peer link, you should display the configuration on each vPC peer switch to ensure that the configurations are compatible.

**Note**

---

You must ensure that the two switches connected by the vPC peer link have certain identical operational and configuration parameters.

---

When you configure the vPC peer link, the vPC peer switches negotiate that one of the connected switches is the primary switch and the other connected switch is the secondary switch. By default, the Cisco NX-OS software uses the lowest MAC address to elect the primary switch. The software takes different actions on each switch—that is, the primary and secondary—only in certain failover conditions. If the primary switch fails, the secondary switch becomes the operational primary switch when the system recovers, and the previously primary switch is now the secondary switch.

You can also configure which of the vPC switches is the primary switch. If you want to configure the role priority again to make one vPC switch the primary switch, configure the role priority on both the primary and secondary vPC switches with the appropriate values, shut down the EtherChannel that is the vPC peer link on both switches by entering the **shutdown** command, and reenab the EtherChannel on both switches by entering the **no shutdown** command.

MAC addresses that are learned over vPC links are also synchronized between the peers.

Configuration information flows across the vPC peer links using the Cisco Fabric Services over Ethernet (CFSOE) protocol. All MAC addresses for those VLANs configured on both switches are synchronized between vPC peer switches. The software uses CFSOE for this synchronization.

If the vPC peer link fails, the software checks the status of the remote vPC peer switch using the peer-keepalive link, which is a link between vPC peer switches, to ensure that both switches are up. If the vPC peer switch is up, the secondary vPC switch disables all vPC ports on its switch. The data then forwards down the remaining active links of the EtherChannel.

The software learns of a vPC peer switch failure when the keepalive messages are not returned over the peer-keepalive link.

Use a separate link (vPC peer-keepalive link) to send configurable keepalive messages between the vPC peer switches. The keepalive messages on the vPC peer-keepalive link determines whether a failure is on the vPC peer link only or on the vPC peer switch. The keepalive messages are used only when all the links in the peer link fail.

## vPC Number

Once you have created the vPC domain ID and the vPC peer link, you can create EtherChannels to attach the downstream switch to each vPC peer switch. That is, you create one single EtherChannel on the downstream switch with half of the ports to the primary vPC peer switch and the other half of the ports to the secondary peer switch.

On each vPC peer switch, you assign the same vPC number to the EtherChannel that connects to the downstream switch. You will experience minimal traffic disruption when you are creating vPCs. To simplify the configuration, you can assign the vPC ID number for each EtherChannel to be the same as the EtherChannel itself (that is, vPC ID 10 for EtherChannel 10).

**Note**

---

The vPC number that you assign to the EtherChannel connecting to the downstream switch from the vPC peer switch must be identical on both vPC peer switches.

---

## vPC Interactions with Other Features

### vPC and LACP

The Link Aggregation Control Protocol (LACP) uses the system MAC address of the vPC domain to form the LACP Aggregation Group (LAG) ID for the vPC.

You can use LACP on all the vPC EtherChannels, including those channels from the downstream switch. We recommend that you configure LACP with active mode on the interfaces on each EtherChannel on the vPC peer switches. This configuration allows you to more easily detect compatibility between switches, unidirectional links, and multihop connections, and provides dynamic reaction to run-time changes and link failures.

The vPC peer link supports 16 EtherChannel interfaces.

**Note**

---

When manually configuring the system priority, you must ensure that you assign the same priority value on both vPC peer switches. If the vPC peer switches have different system priority values, vPC will not come up.

---

### vPC Peer Links and STP

When you first bring up the vPC functionality, STP reconverges. STP treats the vPC peer link as a special link and always includes the vPC peer link in the STP active topology.

We recommend that you set all the vPC peer link interfaces to the STP network port type so that Bridge Assurance is automatically enabled on all vPC peer links. We also recommend that you do not enable any of the STP enhancement features on vPC peer links.

You must configure a list of parameters to be identical on the vPC peer switches on both sides of the vPC peer link.

STP is distributed; that is, the protocol continues running on both vPC peer switches. However, the configuration on the vPC peer switch elected as the primary switch controls the STP process for the vPC interfaces on the secondary vPC peer switch.

The primary vPC switch synchronizes the STP state on the vPC secondary peer switch using Cisco Fabric Services over Ethernet (CFS over Ethernet).

The vPC manager performs a proposal/handshake agreement between the vPC peer switches that sets the primary and secondary switches and coordinates the two switches for STP. The primary vPC peer switch then controls the STP protocol for vPC interfaces on both the primary and secondary switches.

The Bridge Protocol Data Units (BPDUs) use the MAC address set for the vPC for the STP bridge ID in the designated bridge ID field. The vPC primary switch sends these BPDUs on the vPC interfaces.

**Note**

---

Display the configuration on both sides of the vPC peer link to ensure that the settings are identical. Use the **show spanning-tree** command to display information about the vPC.

---

## CFSOE

The Cisco Fabric Services over Ethernet (CFSOE) is a reliable state transport mechanism that you can use to synchronize the actions of the vPC peer devices. CFSOE carries messages and packets for many features linked with vPC, such as STP and IGMP. Information is carried in CFS/CFSOE protocol data units (PDUs).

When you enable the vPC feature, the device automatically enables CFSOE, and you do not have to configure anything. CFSOE distributions for vPCs do not need the capabilities to distribute over IP or the CFS regions. You do not need to configure anything for the CFSOE feature to work correctly on vPCs.

You can use the **show mac address-table** command to display the MAC addresses that CFSOE synchronizes for the vPC peer link.



### Note

Do not enter the **no cfs eth distribute** or the **no cfs distribute** command. CFSOE must be enabled for vPC functionality. If you do enter either of these commands when vPC is enabled, the system displays an error message.

When you enter the **show cfs application** command, the output displays "Physical-eth," which shows the applications that are using CFSOE.

## vPC Guidelines and Limitations

vPC has the following configuration guidelines and limitations:

- You must enable the vPC feature before you can configure vPC peer-link and vPC interfaces.
- You must configure the peer-keepalive link before the system can form the vPC peer link.
- Only EtherChannels can be in vPCs. A vPC can be configured on a normal EtherChannel (switch-to-switch vPC topology), on an EtherChannel fabric interface (fabric extender vPC topology), and on an EtherChannel host interface (host interface vPC topology).



### Note

Refer to the Cisco Nexus 2000 Series Fabric Extender Software Configuration Guide for information about Fabric Extender host and fabric interfaces.

- A Fabric Extender can be a member of a Host Interface vPC topology or a Fabric Extender vPC topology but not both simultaneously.
- You must configure both vPC peer switches; the configuration is not automatically synchronized between the vPC peer devices.
- Check that the necessary configuration parameters are compatible on both sides of the vPC peer link.
- You may experience minimal traffic disruption while configuring vPCs.

# Configuring vPCs

## Enabling vPCs

You must enable the vPC feature before you can configure and use vPCs.

### SUMMARY STEPS

1. switch# **configure terminal**
2. switch(config)# **feature vpc**
3. (Optional) switch# **show feature**
4. (Optional) switch# **copy running-config startup-config**

### DETAILED STEPS

	Command or Action	Purpose
<b>Step 1</b>	switch# <b>configure terminal</b>	Enters configuration mode.
<b>Step 2</b>	switch(config)# <b>feature vpc</b>	Enables vPCs on the switch.
<b>Step 3</b>	switch# <b>show feature</b>	(Optional) Displays which features are enabled on the switch.
<b>Step 4</b>	switch# <b>copy running-config startup-config</b>	(Optional) Copies the running configuration to the startup configuration.

This example shows how to enable the vPC feature:

```
switch# configure terminal
switch(config)# feature vpc
```

## Disabling vPCs

You can disable the vPC feature.



### Note

When you disable the vPC feature, the Cisco Nexus 5000 Series switch clears all the vPC configurations.

### SUMMARY STEPS

1. switch# **configure terminal**
2. switch(config)# **no feature vpc**
3. (Optional) switch# **show feature**
4. (Optional) switch# **copy running-config startup-config**

## DETAILED STEPS

	Command or Action	Purpose
Step 1	switch# <b>configure terminal</b>	Enters configuration mode.
Step 2	switch(config)# <b>no feature vpc</b>	Disables vPCs on the switch.
Step 3	switch# <b>show feature</b>	(Optional) Displays which features are enabled on the switch.
Step 4	switch# <b>copy running-config startup-config</b>	(Optional) Copies the running configuration to the startup configuration.

This example shows how to disable the vPC feature:

```
switch# configure terminal
switch(config)# no feature vpc
```

## Creating a vPC Domain

You must create identical vPC domain IDs on both the vPC peer devices. This domain ID is used to automatically form the vPC system MAC address.

### Before You Begin

Ensure that you have enabled the vPC feature.

You must configure both switches on either side of the vPC peer link with the following procedure.

## SUMMARY STEPS

1. switch# **configure terminal**
2. switch(config)# **vpc domain** *domain-id*
3. (Optional) switch# **show vpc brief**
4. (Optional) switch# **copy running-config startup-config**

## DETAILED STEPS

	Command or Action	Purpose
Step 1	switch# <b>configure terminal</b>	Enters configuration mode.
Step 2	switch(config)# <b>vpc domain</b> <i>domain-id</i>	Creates a vPC domain on the switch, and enters the vpc-domain configuration mode. There is no default <i>domain-id</i> ; the range is from 1 to 1000.  <b>Note</b> You can also use the <b>vpc domain</b> command to enter the vpc-domain configuration mode for an existing vPC domain.

	Command or Action	Purpose
Step 3	switch# <b>show vpc brief</b>	(Optional) Displays brief information about each vPC domain.
Step 4	switch# <b>copy running-config startup-config</b>	(Optional) Copies the running configuration to the startup configuration.

This example shows how to create a vPC domain:

```
switch# configure terminal
switch(config)# vpc domain 5
```

## Configuring a vPC Keepalive Link

You can configure the destination IP for the peer-keepalive link that carries the keepalive messages. Optionally, you can configure other parameters for the keepalive messages.

### Before You Begin

Ensure that you have enabled the vPC feature.

You must configure the vPC peer-keepalive link before the system can form the vPC peer link.

You must configure both switches on either side of the vPC peer link with the following procedure.

### SUMMARY STEPS

1. switch# **configure terminal**
2. switch(config)# **vpc domain** *domain-id*
3. switch(config-vpc-domain)# **peer-keepalive destination** *ipaddress* [**hold-timeout** *secs* | **interval** *msecs* {**timeout** *secs*} | **precedence** {*prec-value* | **network** | **internet** | **critical** | **flash-override** | **flash** | **immediate** | **priority** | **routine**} | **tos** {*tos-value* | **max-reliability** | **max-throughput** | **min-delay** | **min-monetary-cost** | **normal**} | **tos-byte** *tos-byte-value*} | **source** *ipaddress* | **vrf** {*name* | **management vpc-keepalive**}]
4. (Optional) switch# **show vpc peer-keepalive**
5. (Optional) switch# **copy running-config startup-config**

### DETAILED STEPS

	Command or Action	Purpose
Step 1	switch# <b>configure terminal</b>	Enters configuration mode.
Step 2	switch(config)# <b>vpc domain</b> <i>domain-id</i>	Creates a vPC domain on the switch if it does not already exist, and enters the vpc-domain configuration mode.
Step 3	switch(config-vpc-domain)# <b>peer-keepalive destination</b> <i>ipaddress</i> [ <b>hold-timeout</b> <i>secs</i>   <b>interval</b> <i>msecs</i> { <b>timeout</b> <i>secs</i> }   <b>precedence</b> { <i>prec-value</i>   <b>network</b>   <b>internet</b>	Configures the IPv4 address for the remote end of the vPC peer-keepalive link.  <b>Note</b> The system does not form the vPC peer link until you configure a vPC peer-keepalive link.

	Command or Action	Purpose
	<b>critical</b>   <b>flash-override</b>   <b>flash</b>   <b>immediate priority</b>   <b>routine</b> }   <b>tos</b> { <i>tos-value</i>   <b>max-reliability</b>   <b>max-throughput</b>   <b>min-delay</b>   <b>min-monetary-cost</b>   <b>normal</b> }   <b>tos-byte</b> <i>tos-byte-value</i> }   <b>source</b> <i>ipaddress</i>   <b>vrf</b> { <i>name</i>   <b>management vpc-keepalive</b> }]	The management ports and VRF are the defaults
<b>Step 4</b>	switch# <b>show vpc peer-keepalive</b>	(Optional) Displays information about the configuration for the keepalive messages.
<b>Step 5</b>	switch# <b>copy running-config startup-config</b>	(Optional) Copies the running configuration to the startup configuration.

This example shows how to configure the destination IP address for the vPC-peer-keepalive link:

```
switch# configure terminal
switch(config)# vpc domain 5
switch(config-vpc-domain)# peer-keepalive destination 10.10.10.42
```

## Creating a vPC Peer Link

You can create a vPC peer link by designating the EtherChannel that you want on each switch as the peer link for the specified vPC domain. We recommend that you configure the EtherChannels that you are designating as the vPC peer link in trunk mode and that you use two ports on separate modules on each vPC peer switch for redundancy.

### Before You Begin

Ensure that you have enabled the vPC feature.

You must configure both switches on either side of the vPC peer link with the following procedures

### SUMMARY STEPS

1. switch# **configure terminal**
2. switch(config)# **interface port-channel** *channel-number*
3. switch(config-if)# **vpc peer-link**
4. (Optional) switch# **show vpc brief**
5. (Optional) switch# **copy running-config startup-config**

### DETAILED STEPS

	Command or Action	Purpose
<b>Step 1</b>	switch# <b>configure terminal</b>	Enters configuration mode.

	Command or Action	Purpose
<b>Step 2</b>	switch(config)# <b>interface port-channel</b> <i>channel-number</i>	Selects the EtherChannel that you want to use as the vPC peer link for this switch, and enters the interface configuration mode.
<b>Step 3</b>	switch(config-if)# <b>vpc peer-link</b>	Configures the selected EtherChannel as the vPC peer link, and enters the vpc-domain configuration mode.
<b>Step 4</b>	switch# <b>show vpc brief</b>	(Optional) Displays information about each vPC, including information about the vPC peer link.
<b>Step 5</b>	switch# <b>copy running-config startup-config</b>	(Optional) Copies the running configuration to the startup configuration.

This example shows how to configure a vPC peer link:

```
switch# configure terminal
switch(config)# interface port-channel 20
switch(config-if)# vpc peer-link
```

## Checking the Configuration Compatibility

After you have configured the vPC peer link on both vPC peer switches, check that the configurations are consistent on all vPC interfaces.

Parameter	Default Setting
switch# <b>show vpc consistency-parameters</b> { <b>global</b>   <b>interface port-channel</b> <i>channel-number</i> }	Displays the status of those parameters that must be consistent across all vPC interfaces.

This example shows how to check that the required configurations are compatible across all the vPC interfaces:

```
switch# show vpc consistency-parameters global
```

Legend:  
Type 1 : vPC will be suspended in case of mismatch

Name	Type	Local Value	Peer Value
QoS	1	([], [3], [0,7], [2], [4], [6])	([], [3], [0,7], [2], [4], [6])
Network QoS (MTU)	1	(1538, 2240, 0, 0, 0, 0)	(1538, 2240, 0, 0, 0, 0)
Network QoS (Pause)	1	(F, T, F, F, F, F)	(F, T, F, F, F, F)
Input Queuing (Bandwidth)	1	(50, 50, 0, 0, 0, 0)	(50, 50, 0, 0, 0, 0)
Input Queuing (Absolute Priority)	1	(F, F, F, F, F, F)	(F, F, F, F, F, F)
Output Queuing (Bandwidth)	1	(50, 50, 0, 0, 0, 0)	(50, 50, 0, 0, 0, 0)
Output Queuing (Absolute Priority)	1	(F, F, F, F, F, F)	(F, F, F, F, F, F)
STP Mode	1	MST	MST
STP Disabled	1	None	None
STP MST Region Name	1	""	""
STP MST Region Revision	1	0	0
STP MST Region Instance to VLAN Mapping	1		
STP Loopguard	1	Disabled	Disabled
STP Bridge Assurance	1	Enabled	Enabled
STP Port Type	1	Normal	Normal
STP MST Simulate PVST	1	Enabled	Enabled
Allowed VLANs	-	-	-

This example shows how to check that the required configurations are compatible for an EtherChannel interface:

```
switch# show vpc consistency-parameters interface port-channel 20
```

Legend:  
Type 1 : vPC will be suspended in case of mismatch

Name	Type	Local Value	Peer Value
Fex id	1	20	20
STP Port Type	1	Default	Default
STP Port Guard	1	None	None
STP MST Simulate PVST	1	Default	Default
mode	1	on	on
Speed	1	10 Gb/s	10 Gb/s
Duplex	1	full	full
Port Mode	1	fex-fabric	fex-fabric
Shut Lan	1	No	No
Allowed VLANs	-	1,3-3967,4048-4093	1-3967,4048-4093

## Disabling the vPC Peer Link Compatibility Check

You can modify the default vPC behavior when a peer link is down on the primary vPC switch. There is no behavior change on the secondary vPC switch. The default behavior on the primary vPC switch, after a peer-link goes down, is to keep the vPCs down once they get flapped and to not bring up newly configured vPCs. This command allows newly configured vPCs and existing vPCs that are flapped to be brought up when a peer link is down.



### Note

The command comes into effect when a peer link is down and the vPC role has been determined to be primary.

### Before You Begin

Ensure that the vPC feature is enabled and the vPC domain has been configured.

**SUMMARY STEPS**

1. switch# **configure terminal**
2. switch(config)# **vpc domain** *domain-id*
3. switch(config-vpc-domain)# **peer-config-check-bypass**
4. switch(config-vpc-domain)# **no peer-config-check-bypass**

**DETAILED STEPS**

	<b>Command or Action</b>	<b>Purpose</b>
<b>Step 1</b>	switch# <b>configure terminal</b>	Enters configuration mode.
<b>Step 2</b>	switch(config)# <b>vpc domain</b> <i>domain-id</i>	Selects an existing vPC domain on the switch, or creates a new vPC domain, and enters the vpc-domain configuration mode. There is no default <i>domain-id</i> ; the range is from 1 to 1000.
<b>Step 3</b>	switch(config-vpc-domain)# <b>peer-config-check-bypass</b>	Disables the default vPC behavior when a peer link is down. This allows newly configured vPCs (and existing vPCs that may get flapped) to be brought up even when a peer link is down and the vPC switch role has been determined to be primary.
<b>Step 4</b>	switch(config-vpc-domain)# <b>no peer-config-check-bypass</b>	Enables the default vPC behavior when a peer link is down. This will not bring up newly configured vPCs (and existing vPCs that may get flapped) when a peer link is down and the vPC switch role has been determined to be primary.

The following message will be displayed after issuing this command when a peer-link is active:  
Warning: This feature is not available if the peer link is active.

The following message will be displayed after issuing this command when a peer link is in-active:  
Warning: On peer-link recovery, any inconsistency between the two systems may cause currently active links to be disabled.

**Creating an EtherChannel Host Interface**

To connect to a downstream server from a Cisco Nexus 2000 Series Fabric Extender you can create a EtherChannel host interface. An EtherChannel host interface can have only one host interface as a member depending on the fabric extender model. The Cisco Nexus 2148T allows only one interface member per fabric extender, newer fabric extenders allow up to 8 members of the same port-channel on a single fabric extender. You need to create an EtherChannel host interface to configure a vPC on it that uses the Fabric Extender topology.

**Note**

See the *Cisco Nexus 2000 Series Fabric Extender Software Configuration Guide* for information on attaching a Fabric Extender to a Cisco Nexus 5000 Series switch.

**Before You Begin**

Ensure that you have enabled the vPC feature.

Ensure that the connected Fabric Extender is online.

You must configure both switches on either side of the vPC peer link with the following procedure.

**SUMMARY STEPS**

1. switch# **configure terminal**
2. switch(config)# **interface ethernet** *chassis/slot/port*
3. switch(config-if)# **channel-group** *channel-number* **mode** {**active** | **passive** | **on**}
4. (Optional) switch# **show port-channel summary**
5. (Optional) switch# **copy running-config startup-config**

**DETAILED STEPS**

	<b>Command or Action</b>	<b>Purpose</b>
<b>Step 1</b>	switch# <b>configure terminal</b>	Enters configuration mode.
<b>Step 2</b>	switch(config)# <b>interface ethernet</b> <i>chassis/slot/port</i>	Specifies an interface to configure, and enters interface configuration mode.
<b>Step 3</b>	switch(config-if)# <b>channel-group</b> <i>channel-number</i> <b>mode</b> { <b>active</b>   <b>passive</b>   <b>on</b> }	Creates an EtherChannel host interface on the selected host interface.
<b>Step 4</b>	switch# <b>show port-channel summary</b>	(Optional) Displays information about each EtherChannel host interface.
<b>Step 5</b>	switch# <b>copy running-config startup-config</b>	(Optional) Copies the running configuration to the startup configuration.

This example shows how to configure an EtherChannel host interface:

```
switch# configure terminal
switch(config)# interface ethernet 101/1/20
switch(config-if)# channel-group 7 mode active
```

**Moving Other EtherChannels into a vPC****Before You Begin**

Ensure that you have enabled the vPC feature.

You must configure both switches on either side of the vPC peer link with the following procedure.

## SUMMARY STEPS

1. switch# **configure terminal**
2. switch(config)# **interface port-channel** *channel-number*
3. switch(config-if)# **vpc** *number*
4. (Optional) switch# **show vpc brief**
5. (Optional) switch# **copy running-config startup-config**

## DETAILED STEPS

	Command or Action	Purpose
<b>Step 1</b>	switch# <b>configure terminal</b>	Enters configuration mode.
<b>Step 2</b>	switch(config)# <b>interface port-channel</b> <i>channel-number</i>	Selects the EtherChannel that you want to put into the vPC to connect to the downstream switch, and enters the interface configuration mode.  <b>Note</b> A vPC can be configured on a normal EtherChannel (physical vPC topology), on an EtherChannel fabric interface (fabric extender vPC topology), and on an EtherChannel host interface (host interface vPC topology)
<b>Step 3</b>	switch(config-if)# <b>vpc</b> <i>number</i>	Configures the selected EtherChannel into the vPC to connect to the downstream switch. The range is from 1 to 4096.  The vPC <i>number</i> that you assign to the EtherChannel connecting to the downstream switch from the vPC peer switch must be identical on both vPC peer switches.
<b>Step 4</b>	switch# <b>show vpc brief</b>	(Optional) Displays information about each vPC.
<b>Step 5</b>	switch# <b>copy running-config startup-config</b>	(Optional) Copies the running configuration to the startup configuration.

This example shows how to configure an EtherChannel that will connect to the downstream device:

```
switch# configure terminal
switch(config)# interface port-channel 20
switch(config-if)# vpc 5
```

## Manually Configuring a vPC Domain MAC Address



**Note** Configuring the system-mac is an optional configuration step. This section explains how to configure it in case you want to.

### Before You Begin

Ensure that you have enabled the vPC feature.

You must configure both switches on either side of the vPC peer link with the following procedure.

## SUMMARY STEPS

1. switch# **configure terminal**
2. switch(config)# **vpc domain** *domain-id*
3. switch(config-vpc-domain)# **system-mac** *mac-address*
4. (Optional) switch# **show vpc role**
5. (Optional) switch# **copy running-config startup-config**

## DETAILED STEPS

	Command or Action	Purpose
<b>Step 1</b>	switch# <b>configure terminal</b>	Enters configuration mode.
<b>Step 2</b>	switch(config)# <b>vpc domain</b> <i>domain-id</i>	Selects an existing vPC domain on the switch, or creates a new vPC domain, and enters the vpc-domain configuration mode. There is no default <i>domain-id</i> ; the range is from 1 to 1000.
<b>Step 3</b>	switch(config-vpc-domain)# <b>system-mac</b> <i>mac-address</i>	Enters the MAC address that you want for the specified vPC domain in the following format: <i>aaaa.bbbb.cccc</i> .
<b>Step 4</b>	switch# <b>show vpc role</b>	(Optional) Displays the vPC system MAC address.
<b>Step 5</b>	switch# <b>copy running-config startup-config</b>	(Optional) Copies the running configuration to the startup configuration.

This example shows how to configure a vPC domain MAC address:

```
switch# configure terminal
switch(config)# vpc domain 5
switch(config-if)# system-mac 23fb.4ab5.4c4e
```

## Manually Configuring the System Priority

When you create a vPC domain, the system automatically creates a vPC system priority. However, you can also manually configure a system priority for the vPC domain.

### Before You Begin

Ensure that you have enabled the vPC feature.

You must configure both switches on either side of the vPC peer link with the following procedure.

## SUMMARY STEPS

1. switch# **configure terminal**
2. switch(config)# **vpc domain** *domain-id*
3. switch(config-vpc-domain)# **system-priority** *priority*
4. (Optional) switch# **show vpc brief**
5. (Optional) switch# **copy running-config startup-config**

## DETAILED STEPS

	Command or Action	Purpose
<b>Step 1</b>	switch# <b>configure terminal</b>	Enters configuration mode.
<b>Step 2</b>	switch(config)# <b>vpc domain</b> <i>domain-id</i>	Selects an existing vPC domain on the switch, or creates a new vPC domain, and enters the vpc-domain configuration mode. There is no default <i>domain-id</i> ; the range is from 1 to 1000.
<b>Step 3</b>	switch(config-vpc-domain)# <b>system-priority</b> <i>priority</i>	Enters the system priority that you want for the specified vPC domain. The range of values is from 1 to 65535. The default value is 32667.
<b>Step 4</b>	switch# <b>show vpc brief</b>	(Optional) Displays information about each vPC, including information about the vPC peer link.
<b>Step 5</b>	switch# <b>copy running-config startup-config</b>	(Optional) Copies the running configuration to the startup configuration.

This example shows how to configure a vPC peer link:

```
switch# configure terminal
switch(config)# vpc domain 5
switch(config-if)# system-priority 4000
```

## Manually Configuring a vPC Peer Switch Role

By default, the Cisco NX-OS software elects a primary and secondary vPC peer switch after you configure the vPC domain and both sides of the vPC peer link. However, you may want to elect a specific vPC peer switch as the primary switch for the vPC. Then, you would manually configure the role value for the vPC peer switch that you want as the primary switch to be lower than the other vPC peer switch.

vPC does not support role preemption. If the primary vPC peer switch fails, the secondary vPC peer switch takes over to become operationally the vPC primary switch. However, the original operational roles are not restored when the formerly primary vPC comes up again.

### Before You Begin

Ensure that you have enabled the vPC feature.

You must configure both switches on either side of the vPC peer link with the following procedure.

## SUMMARY STEPS

1. switch# **configure terminal**
2. switch(config)# **vpc domain** *domain-id*
3. switch(config-vpc-domain)# **role priority** *priority*
4. (Optional) switch# **show vpc brief**
5. (Optional) switch# **copy running-config startup-config**

## DETAILED STEPS

	Command or Action	Purpose
<b>Step 1</b>	switch# <b>configure terminal</b>	Enters configuration mode.
<b>Step 2</b>	switch(config)# <b>vpc domain</b> <i>domain-id</i>	Selects an existing vPC domain on the switch, or creates a new vPC domain, and enters the vpc-domain configuration mode. There is no default <i>domain-id</i> ; the range is from 1 to 1000.
<b>Step 3</b>	switch(config-vpc-domain)# <b>role priority</b> <i>priority</i>	Enters the role priority that you want for the vPC system priority. The range of values is from 1 to 65535. The default value is 32667.
<b>Step 4</b>	switch# <b>show vpc brief</b>	(Optional) Displays information about each vPC, including information about the vPC peer link.
<b>Step 5</b>	switch# <b>copy running-config startup-config</b>	(Optional) Copies the running configuration to the startup configuration.

This example shows how to configure a vPC peer link:

```
switch# configure terminal
switch(config)# vpc domain 5
switch(config-if)# role priority 4000
```

## Verifying the vPC Configuration

Use the following commands to display vPC configuration information:

Command	Purpose
switch# <b>show feature</b>	Displays whether vPC is enabled or not.
switch# <b>show port-channel capacity</b>	Displays how many EtherChannels are configured and how many are still available on the switch.
switch# <b>show running-config vpc</b>	Displays running configuration information for vPCs.
switch# <b>show vpc brief</b>	Displays brief information on the vPCs.

Command	Purpose
switch# <b>show vpc consistency-parameters</b>	Displays the status of those parameters that must be consistent across all vPC interfaces.
switch# <b>show vpc peer-keepalive</b>	Displays information on the peer-keepalive messages.
switch# <b>show vpc role</b>	Displays the peer status, the role of the local switch, the vPC system MAC address and system priority, and the MAC address and priority for the local vPC switch.
switch# <b>show vpc statistics</b>	Displays statistics on the vPCs.  <b>Note</b> This command displays the vPC statistics only for the vPC peer device that you are working on.

For detailed information about the fields in the output from these commands, see the *Cisco Nexus 5000 Series Command Reference*.

## vPC Example Configurations

### Dual Homed Fabric Extender vPC Configuration Example

The following example shows how to configure the dual homed Fabric Extender vPC topology using the management VRF to carry the peer-keepalive messages on switch NX-5000-1 as shown in following figure:

**Figure 10: vPC Configuration Example**

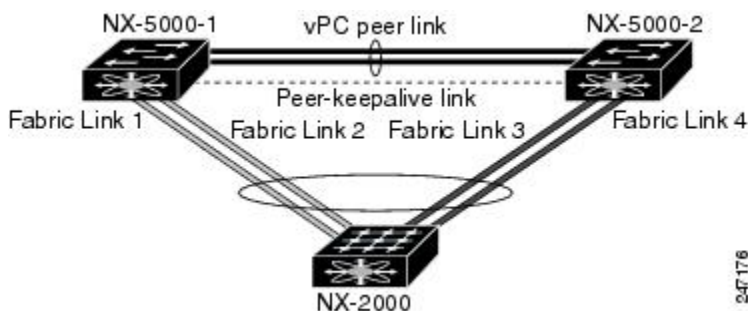

#### Before You Begin

Ensure that the Cisco Nexus 2000 Series Fabric Extender NX-2000-100 is attached and online.

## SUMMARY STEPS

1. Enable vPC and LACP.
2. Create the vPC domain and add the vPC peer-keepalive link.
3. Configure the vPC peer link as a two port Etherchannel.
4. Create a Fabric Extender identifier (for example, "100").
5. Configure the fabric EtherChannel links for the Fabric Extender 100.
6. Configure each host interface port on the Fabric Extender 100 on both Nexus 5000 Series switch as for all the other steps.
7. Save the configuration.

## DETAILED STEPS

- 
- Step 1** Enable vPC and LACP.
- ```
NX-5000-1# configure terminal
NX-5000-1 (config)# feature lacp
NX-5000-1 (config)# feature vpc
```
- Step 2** Create the vPC domain and add the vPC peer-keepalive link.
- ```
NX-5000-1 (config)# vpc domain 1
NX-5000-1 (config-vpc-domain)# peer-keepalive destination 10.10.10.237
NX-5000-1 (config-vpc-domain)# exit
```
- Step 3** Configure the vPC peer link as a two port Etherchannel.
- ```
NX-5000-1 (config)# interface ethernet 1/1-2
NX-5000-1 (config-if-range)# switchport mode trunk
NX-5000-1 (config-if-range)# switchport trunk allowed vlan 20-50
NX-5000-1 (config-if-range)# switchport trunk native vlan 20
NX-5000-1 (config-if-range)# channel-group 20 mode active
NX-5000-1 (config-if-range)# exit
NX-5000-1 (config)# interface port-channel 20
NX-5000-1 (config-if)# vpc peer-link
NX-5000-1 (config-if)# exit
```
- Step 4** Create a Fabric Extender identifier (for example, "100").
- ```
NX-5000-1 (config)# fex 100
NX-5000-1 (config-fex)# pinning max-links 1
NX-5000-1 (fex)# exit
```
- Step 5** Configure the fabric EtherChannel links for the Fabric Extender 100.
- ```
NX-5000-1 (config)# interface ethernet 1/20
NX-5000-1 (config-if)# channel-group 100
NX-5000-1 (config-if)# exit
NX-5000-1 (config)# interface port-channel 100
NX-5000-1 (config-if)# switchport mode fex-fabric
NX-5000-1 (config-if)# vpc 100
NX-5000-1 (config-if)# fex associate 100
NX-5000-1 (config-if)# exit
```

**Step 6** Configure each host interface port on the Fabric Extender 100 on both Nexus 5000 Series switch as for all the other steps.

```
NX-5000-1(config)# interface ethernet 100/1/1-48
NX-5000-1(config-if)# switchport mode access
NX-5000-1(config-if)# switchport access vlan 50
NX-5000-1(config-if)# no shutdown
NX-5000-1(config-if)# exit
```

**Step 7** Save the configuration.

```
NX-5000-1(config)# copy running-config startup-config
```

Repeat all the above steps for the NX-5000-2 switch.

## Single Homed Fabric Extender vPC Configuration Example

The following example shows how to configure the single homed Fabric Extender vPC topology using the default VRF to carry the peer-keepalive messages on switch NX-5000-1 as shown in following figure:

**Figure 11: vPC Configuration Example**

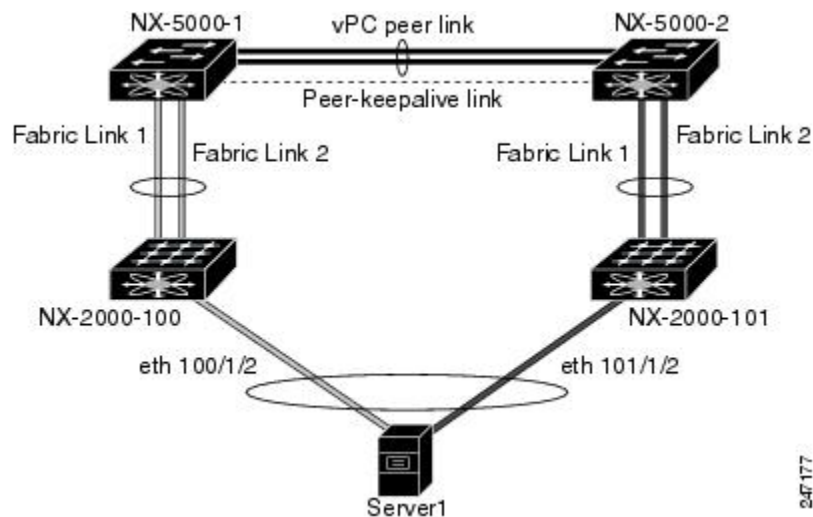

**Note**

The following example only shows the configuration of NX-5000-1 which is connected to the Fabric Extender NX-2000-100. You must repeat these steps on its vPC peer, NX-5000-2, which is connected to the Fabric Extender NX-2000-101.

### Before You Begin

Ensure that the Cisco Nexus 2000 Series Fabric Extenders NX-2000-100 and NX-2000-101 are attached and online.

## SUMMARY STEPS

1. Enable vPC and LACP.
2. Enable SVI interfaces, create the VLAN and SVI to be used by the vPC peer-keepalive link.
3. Create the vPC domain and add the vPC peer-keepalive link in the default VRF.
4. Configure the vPC peer link as a two port Etherchannel.
5. Configure the Fabric Extender NX-2000-100.
6. Configure the fabric EtherChannel links for the Fabric Extender NX-2000-100.
7. Configure a vPC server port on on the Fabric Extender NX-2000-100.
8. Save the configuration.

## DETAILED STEPS

- 
- Step 1** Enable vPC and LACP.
- ```
NX-5000-1# configure terminal
NX-5000-1 (config)# feature lacp
NX-5000-1 (config)# feature vpc
```
- Step 2** Enable SVI interfaces, create the VLAN and SVI to be used by the vPC peer-keepalive link.
- ```
NX-5000-1 (config)# feature interface-vlan
NX-5000-1 (config)# vlan 900
NX-5000-1 (config-vlan)# int vlan 900
NX-5000-1 (config-if)# ip address 10.10.10.236 255.255.255.0
NX-5000-1 (config-if)# no shutdown
NX-5000-1 (config-if)# exit
```
- Step 3** Create the vPC domain and add the vPC peer-keepalive link in the default VRF.
- ```
NX-5000-1 (config)# vpc domain 30
NX-5000-1 (config-vpc-domain)# peer-keepalive destination 10.10.10.237 source 10.10.10.236 vrf default
NX-5000-1 (config-vpc-domain)# exit
```
- Note** VLAN 900 must **not** be trunked across the vPC peer-link because it carries the vPC peer-keepalive messages. There must be an alternative path between switches NX-5000-1 and NX-5000-2 for the vPC peer-keepalive messages.
- Step 4** Configure the vPC peer link as a two port Etherchannel.
- ```
NX-5000-1 (config)# interface ethernet 1/1-2
NX-5000-1 (config-if-range)# switchport mode trunk
NX-5000-1 (config-if-range)# switchport trunk allowed vlan 20-50
NX-5000-1 (config-if-range)# switchport trunk native vlan 20
NX-5000-1 (config-if-range)# channel-group 30 mode active
NX-5000-1 (config-if-range)# exit
NX-5000-1 (config)# interface port-channel 30
NX-5000-1 (config-if)# vpc peer-link
NX-5000-1 (config-if)# exit
```

**Step 5** Configure the Fabric Extender NX-2000-100.

```
NX-5000-1(config)# fex 100
NX-5000-1(config-fex)# pinning max-links 1
NX-5000-1(fex)# exit
```

**Step 6** Configure the fabric EtherChannel links for the Fabric Extender NX-2000-100.

```
NX-5000-1(config)# interface ethernet 1/20-21
NX-5000-1(config-if)# channel-group 100
NX-5000-1(config-if)# exit
NX-5000-1(config)# interface port-channel 100
NX-5000-1(config-if)# switchport mode fex-fabric
NX-5000-1(config-if)# fex associate 100
NX-5000-1(config-if)# exit
```

**Step 7** Configure a vPC server port on on the Fabric Extender NX-2000-100.

```
NX-5000-1(config-if)# interface ethernet 100/1/1
NX-5000-1(config-if)# switchport mode trunk
NX-5000-1(config-if)# switchport trunk native vlan 100
NX-5000-1(config-if)# switchport trunk allowed vlan 100-105
NX-5000-1(config-if)# channel-group 600
NX-5000-1(config-if)# no shutdown
NX-5000-1(config-if)# exit
NX-5000-1(config)# interface port-channel 600
NX-5000-1(config-if)# vpc 600
NX-5000-1(config-if)# no shutdown
NX-5000-1(config-if)# exit
```

**Step 8** Save the configuration.

```
NX-5000-1(config)# copy running-config startup-config
```

## vPC Default Settings

The following table lists the default settings for vPC parameters.

**Table 11: Default vPC Parameters**

| Parameters                  | Default   |
|-----------------------------|-----------|
| vPC system priority         | 32667     |
| vPC peer-keepalive message  | Disabled  |
| vPC peer-keepalive interval | 1 second  |
| vPC peer-keepalive timeout  | 5 seconds |
| vPC peer-keepalive UDP port | 3200      |





## CHAPTER 9

# Configuring Rapid PVST+

Rapid per VLAN Spanning Tree (Rapid PVST+) is an updated implementation of STP that allows you to create one spanning tree topology for each VLAN. Rapid PVST+ is the default Spanning Tree Protocol (STP) mode on the switch.



### Note

Spanning tree is used to refer to IEEE 802.1w and IEEE 802.1s. If the text is discussing the IEEE 802.1D Spanning Tree Protocol, 802.1D is stated specifically.

This chapter describes the configuration of Rapid PVST+ on Cisco Nexus 5000 Series switches. It includes the following sections:

- [Information About Rapid PVST+, page 107](#)
- [Configuring Rapid PVST+, page 123](#)
- [Verifying Rapid PVST+ Configurations, page 132](#)

## Information About Rapid PVST+

The Rapid PVST+ protocol is the IEEE 802.1w standard, Rapid Spanning Tree Protocol (RSTP), implemented on a per VLAN basis. Rapid PVST+ interoperates with the IEEE 802.1D standard, which mandates a single STP instance for all VLANs, rather than per VLAN.

Rapid PVST+ is enabled by default on the default VLAN (VLAN1) and on all newly created VLANs in software. Rapid PVST+ interoperates with switches that run legacy IEEE 802.1D STP.

RSTP is an improvement on the original STP standard, 802.1D, which allows faster convergence.

### Related Topics

- [Rapid PVST+ and IEEE 802.1Q Trunks, page 122](#)
- [Rapid PVST+ Interoperation with Legacy 802.1D STP, page 122](#)

# Understanding STP

## STP Overview

For an Ethernet network to function properly, only one active path can exist between any two stations.

When you create fault-tolerant internetworks, you must have a loop-free path between all nodes in a network. The STP algorithm calculates the best loop-free path throughout a switched network. LAN ports send and receive STP frames, which are called Bridge Protocol Data Units (BPDUs), at regular intervals. Switches do not forward these frames, but use the frames to construct a loop-free path.

Multiple active paths between end stations cause loops in the network. If a loop exists in the network, end stations might receive duplicate messages and switches might learn end station MAC addresses on multiple LAN ports. These conditions result in a broadcast storm, which creates an unstable network.

STP defines a tree with a root bridge and a loop-free path from the root to all switches in the network. STP forces redundant data paths into a blocked state. If a network segment in the spanning tree fails and a redundant path exists, the STP algorithm recalculates the spanning tree topology and activates the blocked path.

When two LAN ports on a switch are part of a loop, the STP port priority and port path cost setting determine which port on the switch is put in the forwarding state and which port is put in the blocking state.

## Understanding How a Topology is Created

All switches in an extended LAN that participate in a spanning tree gather information about other switches in the network by exchanging of BPDUs. This exchange of BPDUs results in the following actions:

- The system elects a unique root switch for the spanning tree network topology.
- The system elects a designated switch for each LAN segment.
- The system eliminates any loops in the switched network by placing redundant interfaces in a backup state; all paths that are not needed to reach the root switch from anywhere in the switched network are placed in an STP-blocked state.

The topology on an active switched network is determined by the following:

- The unique switch identifier Media Access Control (MAC) address of the switch that is associated with each switch
- The path cost to the root that is associated with each interface
- The port identifier that is associated with each interface

In a switched network, the root switch is the logical center of the spanning tree topology. STP uses BPDUs to elect the root switch and root port for the switched network, as well as the root port and designated port for each switched segment.

## Understanding the Bridge ID

Each VLAN on each switch has a unique 64-bit bridge ID consisting of a bridge priority value, an extended system ID (IEEE 802.1t), and an STP MAC address allocation.

### Bridge Priority Value

The bridge priority is a 4-bit value when the extended system ID is enabled.



**Note**

In Cisco NX-OS, the extended system ID is always enabled; you cannot be disable the extended system ID.

#### Related Topics

- [Configuring the Rapid PVST+ Bridge Priority of a VLAN, page 129](#)

### Extended System ID

A 12-bit extended system ID field is part of the bridge ID.

**Figure 12: Bridge ID with Extended System ID**



The switches always use the 12-bit extended system ID.

Combined with the bridge ID, the system ID extension functions as the unique identifier for a VLAN.

**Table 12: Bridge Priority Value and Extended System ID with the Extended System ID Enabled**

| Bridge Priority Value |        |        |        | Extended System ID (Set Equal to the VLAN ID) |        |        |       |       |       |       |       |       |       |       |       |
|-----------------------|--------|--------|--------|-----------------------------------------------|--------|--------|-------|-------|-------|-------|-------|-------|-------|-------|-------|
| Bit 16                | Bit 15 | Bit 14 | Bit 13 | Bit 12                                        | Bit 11 | Bit 10 | Bit 9 | Bit 8 | Bit 7 | Bit 6 | Bit 5 | Bit 4 | Bit 3 | Bit 2 | Bit 1 |
| 32768                 | 16384  | 8192   | 4096   | 2048                                          | 1024   | 512    | 256   | 128   | 64    | 32    | 16    | 8     | 4     | 2     | 1     |

### STP MAC Address Allocation



**Note**

Extended system ID and MAC address reduction is always enabled on the software.

With MAC address reduction enabled on any switch, you should also enable MAC address reduction on all other connected switches to avoid undesirable root bridge election and spanning tree topology issues.

When MAC address reduction is enabled, the root bridge priority becomes a multiple of 4096 plus the VLAN ID. You can only specify a switch bridge ID (used by the spanning tree algorithm to determine the identity of the root bridge, the lowest being preferred) as a multiple of 4096. Only the following values are possible:

- 0

- 4096
- 8192
- 12288
- 16384
- 20480
- 24576
- 28672
- 32768
- 36864
- 40960
- 45056
- 49152
- 53248
- 57344
- 61440

STP uses the extended system ID plus a MAC address to make the bridge ID unique for each VLAN.

**Note**

---

If another bridge in the same spanning tree domain does not run the MAC address reduction feature, it could achieve root bridge ownership because its bridge ID may fall between the values specified by the MAC address reduction feature.

---

## Understanding BPDUs

Switches transmit bridge protocol data units (BPDUs) throughout the STP instance. Each switch sends configuration BPDUs to communicate and compute the spanning tree topology. Each configuration BPDU contains the following minimal information:

- The unique bridge ID of the switch that the transmitting switch determines is the root bridge
- The STP path cost to the root
- The bridge ID of the transmitting bridge
- Message age
- The identifier of the transmitting port
- Values for the hello, forward delay, and max-age protocol timer
- Additional information for STP extension protocols

When a switch transmits a Rapid PVST+ BPDU frame, all switches connected to the VLAN on which the frame is transmitted receive the BPDU. When a switch receives a BPDU, it does not forward the frame but

instead uses the information in the frame to calculate a BPDU, and, if the topology changes, initiate a BPDU transmission.

A BPDU exchange results in the following:

- One switch is elected as the root bridge.
- The shortest distance to the root bridge is calculated for each switch based on the path cost.
- A designated bridge for each LAN segment is selected. This is the switch closest to the root bridge through which frames are forwarded to the root.
- A root port is selected. This is the port providing the best path from the bridge to the root bridge.
- Ports included in the spanning tree are selected.

#### Related Topics

- [Rapid PVST+ BPDUs, page 114](#)

## Election of the Root Bridge

For each VLAN, the switch with the lowest numerical value of the bridge ID is elected as the root bridge. If all switches are configured with the default priority (32768), the switch with the lowest MAC address in the VLAN becomes the root bridge. The bridge priority value occupies the most significant bits of the bridge ID.

When you change the bridge priority value, you change the probability that the switch will be elected as the root bridge. Configuring a lower value increases the probability; a higher value decreases the probability.

The STP root bridge is the logical center of each spanning tree topology in a network. All paths that are not needed to reach the root bridge from anywhere in the network are placed in STP blocking mode.

BPDUs contain information about the transmitting bridge and its ports, including bridge and MAC addresses, bridge priority, port priority, and path cost. STP uses this information to elect the root bridge for the STP instance, to elect the root port leading to the root bridge, and to determine the designated port for each segment.

## Creating the Spanning Tree Topology

In the following figure, Switch A is elected as the root bridge because the bridge priority of all the switches is set to the default (32768) and Switch A has the lowest MAC address. However, due to traffic patterns, number of forwarding ports, or link types, Switch A might not be the ideal root bridge. By increasing the

priority (lowering the numerical value) of the ideal switch so that it becomes the root bridge, you force an STP recalculation to form a new spanning tree topology with the ideal switch as the root.

**Figure 13: Spanning Tree Topology**

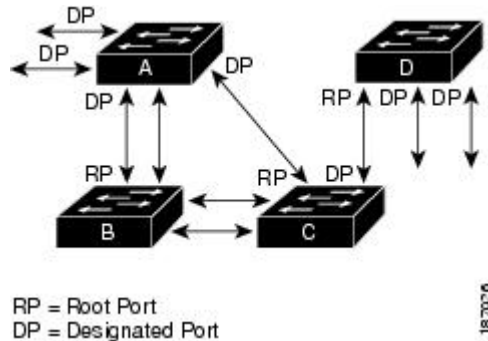

When the spanning tree topology is calculated based on default parameters, the path between source and destination end stations in a switched network might not be ideal. For instance, connecting higher-speed links to a port that has a higher number than the current root port can cause a root-port change. The goal is to make the fastest link the root port.

For example, assume that one port on Switch B is a fiber-optic link, and another port on Switch B (an unshielded twisted-pair [UTP] link) is the root port. Network traffic might be more efficient over the high-speed fiber-optic link. By changing the STP port priority on the fiber-optic port to a higher priority (lower numerical value) than the root port, the fiber-optic port becomes the new root port.

## Understanding Rapid PVST+

### Rapid PVST+ Overview

Rapid PVST+ is the IEEE 802.1w (RSTP) standard implemented per VLAN. A single instance of STP runs on each configured VLAN (if you do not manually disable STP). Each Rapid PVST+ instance on a VLAN has a single root switch. You can enable and disable STP on a per-VLAN basis when you are running Rapid PVST+.



**Note** Rapid PVST+ is the default STP mode for the switch.

Rapid PVST+ uses point-to-point wiring to provide rapid convergence of the spanning tree. The spanning tree reconfiguration can occur in less than 1 second with Rapid PVST+ (in contrast to 50 seconds with the default settings in the 802.1D STP).



**Note** Rapid PVST+ supports one STP instance for each VLAN.

Using Rapid PVST+, STP convergence occurs rapidly. Each designated or root port in the STP sends out a BPDU every 2 seconds by default. On a designated or root port in the topology, if hello messages are missed three consecutive times, or if the maximum age expires, the port immediately flushes all protocol information in the table. A port considers that it loses connectivity to its direct neighbor root or designated port if it misses

three BPDUs or if the maximum age expires. This rapid aging of the protocol information allows quick failure detection. The switch automatically checks the PVID.

Rapid PVST+ provides for rapid recovery of connectivity following the failure of a network device, a switch port, or a LAN. It provides rapid convergence for edge ports, new root ports, and ports connected through point-to-point links as follows:

- **Edge ports**—When you configure a port as an edge port on an RSTP switch, the edge port immediately transitions to the forwarding state. (This immediate transition was previously a Cisco-proprietary feature named PortFast.) You should only configure on ports that connect to a single end station as edge ports. Edge ports do not generate topology changes when the link changes.

Enter the **spanning-tree port type** interface configuration command to configure a port as an STP edge port.



---

**Note** We recommend that you configure all ports connected to a host as edge ports.

---

- **Root ports**—If Rapid PVST+ selects a new root port, it blocks the old root port and immediately transitions the new root port to the forwarding state.
- **Point-to-point links**—If you connect a port to another port through a point-to-point link and the local port becomes a designated port, it negotiates a rapid transition with the other port by using the proposal-agreement handshake to ensure a loop-free topology.

Rapid PVST+ achieves rapid transition to the forwarding state only on edge ports and point-to-point links. Although the link type is configurable, the system automatically derives the link type information from the duplex setting of the port. Full-duplex ports are assumed to be point-to-point ports, while half-duplex ports are assumed to be shared ports.

Edge ports do not generate topology changes, but all other designated and root ports generate a topology change (TC) BPDU when they either fail to receive three consecutive BPDUs from the directly connected neighbor or the maximum age times out. At this point, the designated or root port sends out a BPDU with the TC flag set. The BPDUs continue to set the TC flag as long as the TC While timer runs on that port. The value of the TC While timer is the value set for the hello time plus 1 second. The initial detector of the topology change immediately floods this information throughout the entire topology.

When Rapid PVST+ detects a topology change, the protocol does the following:

- Starts the TC While timer with a value equal to twice the hello time for all the non-edge root and designated ports, if necessary.
- Flushes the MAC addresses associated with all these ports.

The topology change notification floods quickly across the entire topology. The system flushes dynamic entries immediately on a per-port basis when it receives a topology change.



---

**Note** The TCA flag is used only when the switch is interacting with switches that are running legacy 802.1D STP.

---

The proposal and agreement sequence then quickly propagates toward the edge of the network and quickly restores connectivity after a topology change.

## Rapid PVST+ BPDUs

Rapid PVST+ and 802.1w use all six bits of the flag byte to add the role and state of the port that originates the BPDU, and the proposal and agreement handshake. The following figure shows the use of the BPDU flags in Rapid PVST+.

**Figure 14: Rapid PVST+ Flag Byte in BPDU**

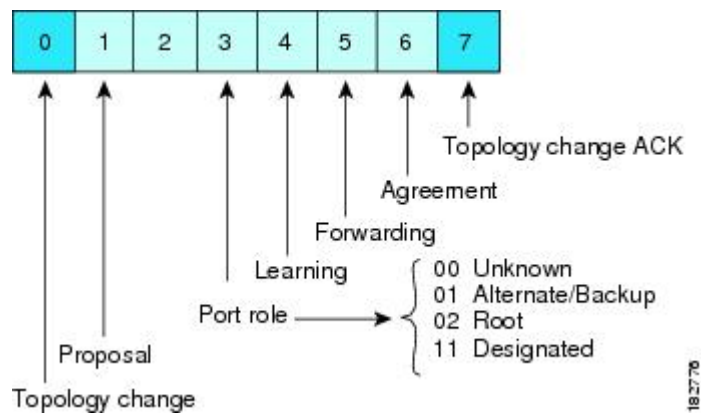

Another important change is that the Rapid PVST+ BPDU is type 2, version 2, which makes it possible for the switch to detect connected legacy (802.1D) bridges. The BPDU for 802.1D is version 0.

## Proposal and Agreement Handshake

As shown in the following figure, switch A is connected to switch B through a point-to-point link, and all of the ports are in the blocking state. Assume that the priority of switch A is a smaller numerical value than the priority of switch B.

**Figure 15: Proposal and Agreement Handshaking for Rapid Convergence**

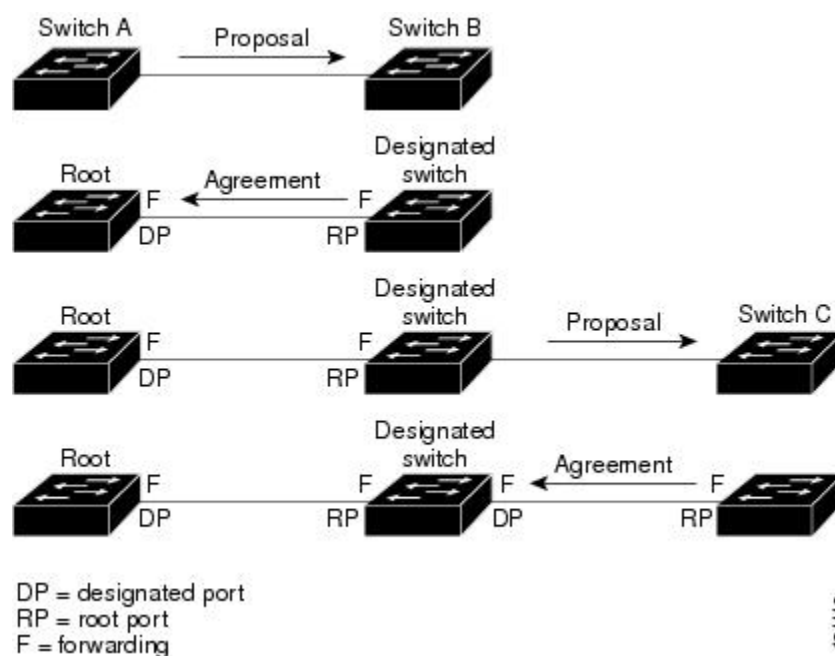

Switch A sends a proposal message (a configuration BPDU with the proposal flag set) to switch B, proposing itself as the designated switch.

After receiving the proposal message, switch B selects as its new root port the port from which the proposal message was received, forces all non-edge ports to the blocking state, and sends an agreement message (a BPDU with the agreement flag set) through its new root port.

After receiving the agreement message from switch B, switch A also immediately transitions its designated port to the forwarding state. No loops in the network can form because switch B blocked all of its non-edge ports and because there is a point-to-point link between switches A and B.

When switch C connects to switch B, a similar set of handshaking messages are exchanged. Switch C selects the port connected to switch B as its root port, and both ends of the link immediately transition to the forwarding state. With each iteration of this handshaking process, one more network device joins the active topology. As the network converges, this proposal-agreement handshaking progresses from the root toward the leaves of the spanning tree.

The switch learns the link type from the port duplex mode: a full-duplex port is considered to have a point-to-point connection and a half-duplex port is considered to have a shared connection. You can override the default setting that is controlled by the duplex setting by entering the **spanning-tree link-type** interface configuration command.

This proposal/agreement handshake is initiated only when a non-edge port moves from the blocking to the forwarding state. The handshaking process then proliferates step-by-step throughout the topology.

**Related Topics**

- [Summary of Port States, page 119](#)

**Protocol Timers**

The following table describes the protocol timers that affect the Rapid PVST+ performance.

**Table 13: Rapid PVST+ Protocol Timers**

| Variable            | Description                                                                                                                                                                                                                                                                   |
|---------------------|-------------------------------------------------------------------------------------------------------------------------------------------------------------------------------------------------------------------------------------------------------------------------------|
| Hello timer         | Determines how often each switch broadcasts BPDUs to other switches. The default is 2 seconds, and the range is from 1 to 10.                                                                                                                                                 |
| Forward delay timer | Determines how long each of the listening and learning states last before the port begins forwarding. This timer is generally not used by the protocol but is used as a backup. The default is 15 seconds, and the range is from 4 to 30 seconds.                             |
| Maximum age timer   | Determines the amount of time protocol information received on an port is stored by the switch. This timer is generally not used by the protocol, but it is used when interoperating with 802.1D spanning tree. The default is 20 seconds; the range is from 6 to 40 seconds. |

**Port Roles**

Rapid PVST+ provides rapid convergence of the spanning tree by assigning port roles and learning the active topology. Rapid PVST+ builds upon the 802.1D STP to select the switch with the highest priority (lowest numerical priority value) as the root bridge. Rapid PVST+ then assigns one of these port roles to individual ports:

- Root port—Provides the best path (lowest cost) when the switch forwards packets to the root bridge.
- Designated port—Connects to the designated switch, which incurs the lowest path cost when forwarding packets from that LAN to the root bridge. The port through which the designated switch is attached to the LAN is called the designated port.
- Alternate port—Offers an alternate path toward the root bridge to the path provided by the current root port. An alternate port provides a path to another switch in the topology.
- Backup port—Acts as a backup for the path provided by a designated port toward the leaves of the spanning tree. A backup port can exist only when two ports are connected in a loopback by a point-to-point link or when a switch has two or more connections to a shared LAN segment. A backup port provides another path in the topology to the switch.
- Disabled port—Has no role within the operation of the spanning tree.

In a stable topology with consistent port roles throughout the network, Rapid PVST+ ensures that every root port and designated port immediately transition to the forwarding state while all alternate and backup ports are always in the blocking state. Designated ports start in the blocking state. The port state controls the operation of the forwarding and learning processes.

A port with the root or a designated port role is included in the active topology. A port with the alternate or backup port role is excluded from the active topology (see the following figure).

**Figure 16: Sample Topology Demonstrating Port Roles**

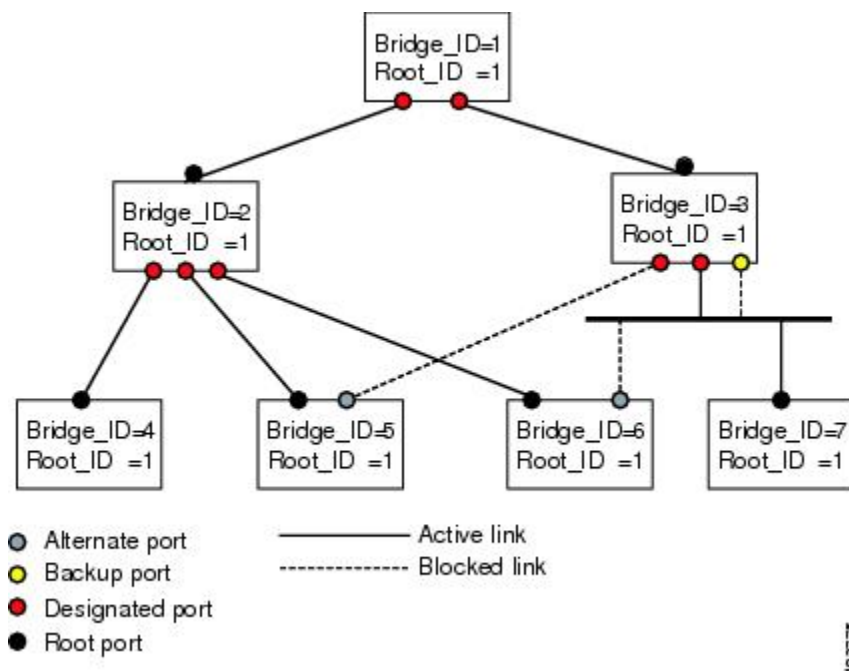

### Related Topics

- [Election of the Root Bridge, page 111](#)

## Port States

### Rapid PVST+ Port State Overview

Propagation delays can occur when protocol information passes through a switched LAN. As a result, topology changes can take place at different times and at different places in a switched network. When a LAN port transitions directly from nonparticipation in the spanning tree topology to the forwarding state, it can create temporary data loops. Ports must wait for new topology information to propagate through the switched LAN before starting to forward frames.

Each LAN port on a software using Rapid PVST+ or MST exists in one of the following four states:

- Blocking—The LAN port does not participate in frame forwarding.
- Learning—The LAN port prepares to participate in frame forwarding.
- Forwarding—The LAN port forwards frames.

- Disabled—The LAN port does not participate in STP and is not forwarding frames.

When you enable Rapid PVST+, every port in the software, VLAN, and network goes through the blocking state and the transitory states of learning at power up. If properly configured, each LAN port stabilizes to the forwarding or blocking state.

When the STP algorithm places a LAN port in the forwarding state, the following process occurs:

- The LAN port is put into the blocking state while it waits for protocol information that suggests it should go to the learning state.
- The LAN port waits for the forward delay timer to expire, moves the LAN port to the learning state, and restarts the forward delay timer.
- In the learning state, the LAN port continues to block frame forwarding as it learns the end station location information for the forwarding database.
- The LAN port waits for the forward delay timer to expire and then moves the LAN port to the forwarding state, where both learning and frame forwarding are enabled.

## Blocking State

A LAN port in the blocking state does not participate in frame forwarding.

A LAN port in the blocking state performs as follows:

- Discards frames received from the attached segment.
- Discards frames switched from another port for forwarding.
- Does not incorporate the end station location into its address database. (There is no learning on a blocking LAN port, so there is no address database update.)
- Receives BPDUs and directs them to the system module.
- Receives, processes, and transmits BPDUs received from the system module.
- Receives and responds to network management messages.

## Learning State

A LAN port in the learning state prepares to participate in frame forwarding by learning the MAC addresses for the frames. The LAN port enters the learning state from the blocking state.

A LAN port in the learning state performs as follows:

- Discards frames received from the attached segment.
- Discards frames switched from another port for forwarding.
- Incorporates the end station location into its address database.
- Receives BPDUs and directs them to the system module.
- Receives, processes, and transmits BPDUs received from the system module.
- Receives and responds to network management messages.

## Forwarding State

A LAN port in the forwarding state forwards frames. The LAN port enters the forwarding state from the learning state.

A LAN port in the forwarding state performs as follows:

- Forwards frames received from the attached segment.
- Forwards frames switched from another port for forwarding.
- Incorporates the end station location information into its address database.
- Receives BPDUs and directs them to the system module.
- Processes BPDUs received from the system module.
- Receives and responds to network management messages.

## Disabled State

A LAN port in the disabled state does not participate in frame forwarding or STP. A LAN port in the disabled state is virtually nonoperational.

A disabled LAN port performs as follows:

- Discards frames received from the attached segment.
- Discards frames switched from another port for forwarding.
- Does not incorporate the end station location into its address database. (There is no learning, so there is no address database update.)
- Does not receive BPDUs from neighbors.
- Does not receive BPDUs for transmission from the system module.

## Summary of Port States

The following table lists the possible operational and Rapid PVST+ states for ports and the corresponding inclusion in the active topology.

**Table 14: Port State Active Topology**

| Operational Status | Port State | Is Port Included in the Active Topology? |
|--------------------|------------|------------------------------------------|
| Enabled            | Blocking   | No                                       |
| Enabled            | Learning   | Yes                                      |
| Enabled            | Forwarding | Yes                                      |
| Disabled           | Disabled   | No                                       |

## Synchronization of Port Roles

When the switch receives a proposal message on one of its ports and that port is selected as the new root port, Rapid PVST+ forces all other ports to synchronize with the new root information.

The switch is synchronized with superior root information received on the root port if all other ports are synchronized. An individual port on the switch is synchronized if either of the following applies:

- That port is in the blocking state.
- It is an edge port (a port configured to be at the edge of the network).

If a designated port is in the forwarding state and is not configured as an edge port, it transitions to the blocking state when the Rapid PVST+ forces it to synchronize with new root information. In general, when the Rapid PVST+ forces a port to synchronize with root information and the port does not satisfy any of the above conditions, its port state is set to blocking.

After ensuring that all of the ports are synchronized, the switch sends an agreement message to the designated switch that corresponds to its root port. When the switches connected by a point-to-point link are in agreement about their port roles, Rapid PVST+ immediately transitions the port states to the forwarding state. The sequence of events is shown in the following figure.

**Figure 17: Sequence of Events During Rapid Convergence**

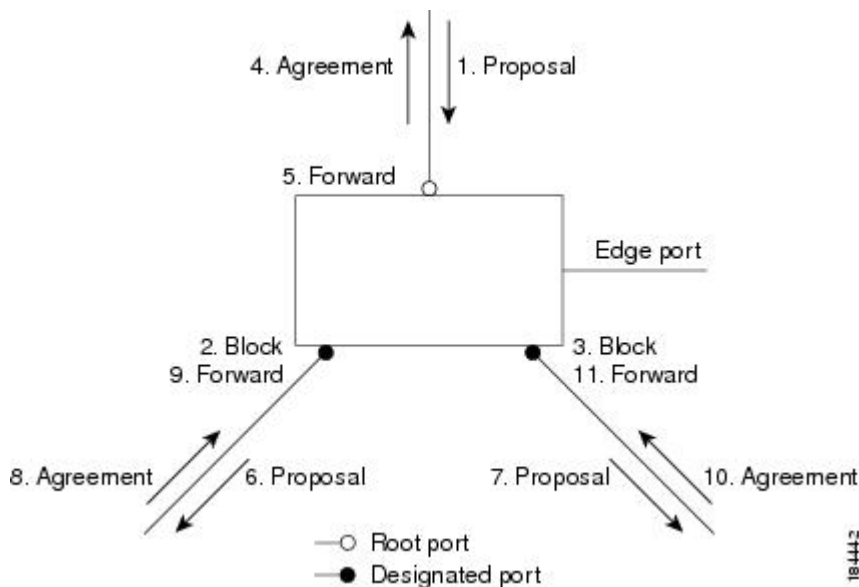

## Processing Superior BPDU Information

A superior BPDU is a BPDU with root information (such as a lower switch ID or lower path cost) that is superior to what is currently stored for the port.

If a port receives a superior BPDU, Rapid PVST+ triggers a reconfiguration. If the port is proposed and is selected as the new root port, Rapid PVST+ forces all the other ports to synchronize.

If the received BPDU is a Rapid PVST+ BPDU with the proposal flag set, the switch sends an agreement message after all of the other ports are synchronized. The new root port transitions to the forwarding state as soon as the previous port reaches the blocking state.

If the superior information received on the port causes the port to become a backup port or an alternate port, Rapid PVST+ sets the port to the blocking state and sends an agreement message. The designated port continues sending BPDUs with the proposal flag set until the forward-delay timer expires. At that time, the port transitions to the forwarding state.

## Processing Inferior BPDU Information

An inferior BPDU is a BPDU with root information (such as a higher switch ID or higher path cost) that is inferior to what is currently stored for the port.

If a designated port receives an inferior BPDU, it immediately replies with its own information.

## Spanning-Tree Dispute Mechanism

The software checks the consistency of the port role and state in the received BPDUs to detect unidirectional link failures that could cause bridging loops.

When a designated port detects a conflict, it keeps its role, but reverts to a discarding state because disrupting connectivity in case of inconsistency is preferable to opening a bridging loop.

The following figure illustrates a unidirectional link failure that typically creates a bridging loop. Switch A is the root bridge, and its BPDUs are lost on the link leading to switch B. The 802.1w-standard BPDUs include the role and state of the sending port. With this information, switch A can detect that switch B does not react to the superior BPDUs it sends and that switch B is the designated, not root port. As a result, switch A blocks (or keeps blocking) its port, thus preventing the bridging loop. The block is shown as an STP dispute.

**Figure 18: Detecting Unidirectional Link Failure**

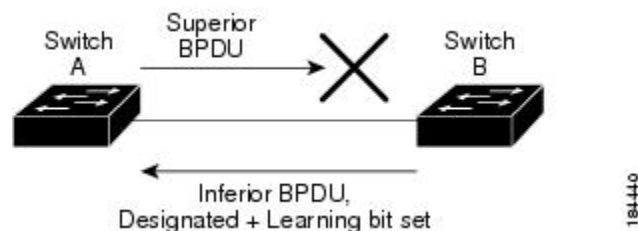

## Port Cost



### Note

Rapid PVST+ uses the short (16-bit) pathcost method to calculate the cost by default. With the short pathcost method, you can assign any value in the range of 1 to 65535. However, you can configure the switch to use the long (32-bit) pathcost method, which allows you to assign any value in the range of 1 to 200,000,000. You configure the pathcost calculation method globally.

The STP port path-cost default value is determined from the media speed and path-cost calculation method of a LAN interface. If a loop occurs, STP considers the port cost when selecting a LAN interface to put into the forwarding state.

**Table 15: Default Port Cost**

| Bandwidth           | Short Path-cost Method of Port Cost | Long Path-cost Method of Port Cost |
|---------------------|-------------------------------------|------------------------------------|
| 10 Mbps             | 100                                 | 2,000,000                          |
| 100 Mbps            | 19                                  | 200,000                            |
| 1 Gigabit Ethernet  | 4                                   | 20,000                             |
| 10 Gigabit Ethernet | 2                                   | 2,000                              |

You can assign lower cost values to LAN interfaces that you want STP to select first and higher cost values to LAN interfaces that you want STP to select last. If all LAN interfaces have the same cost value, STP puts the LAN interface with the lowest LAN interface number in the forwarding state and blocks other LAN interfaces.

On access ports, you assign port cost by the port. On trunk ports, you assign the port cost by the VLAN; you can configure the same port cost to all the VLANs on a trunk port.

## Port Priority

If a loop occurs and multiple ports have the same path cost, Rapid PVST+ considers the port priority when selecting which LAN port to put into the forwarding state. You can assign lower priority values to LAN ports that you want Rapid PVST+ to select first and higher priority values to LAN ports that you want Rapid PVST+ to select last.

If all LAN ports have the same priority value, Rapid PVST+ puts the LAN port with the lowest LAN port number in the forwarding state and blocks other LAN ports. The possible priority range is from 0 through 224 (the default is 128), configurable in increments of 32. software uses the port priority value when the LAN port is configured as an access port and uses VLAN port priority values when the LAN port is configured as a trunk port.

## Rapid PVST+ and IEEE 802.1Q Trunks

In a network of Cisco switches connected through 802.1Q trunks, the switches maintain one instance of STP for each VLAN allowed on the trunks. However, non-Cisco 802.1Q switches maintain only one instance of STP for all VLANs allowed on the trunks.

When you connect a Cisco switch to a non-Cisco switch through an 802.1Q trunk, the Cisco switch combines the STP instance of the 802.1Q VLAN of the trunk with the STP instance of the non-Cisco 802.1Q switch. However, all per-VLAN STP information that is maintained by Cisco switches is separated by a cloud of non-Cisco 802.1Q switches. The non-Cisco 802.1Q cloud that separates the Cisco switches is treated as a single trunk link between the switches.

## Rapid PVST+ Interoperation with Legacy 802.1D STP

Rapid PVST+ can interoperate with switches that are running the legacy 802.1D protocol. The switch knows that it is interoperating with equipment running 802.1D when it receives a BPDU version 0. The BPDUs for Rapid PVST+ are version 2. If the BPDU received is an 802.1w BPDU version 2 with the proposal flag set,

the switch sends an agreement message after all of the other ports are synchronized. If the BPDU is an 802.1D BPDU version 0, the switch does not set the proposal flag and starts the forward-delay timer for the port. The new root port requires twice the forward-delay time to transition to the forwarding state.

The switch interoperates with legacy 802.1D switches as follows:

- **Notification**—Unlike 802.1D BPDUs, 802.1w does not use TCN BPDUs. However, for interoperability with 802.1D switches, Cisco NX-OS processes and generates TCN BPDUs.
- **Acknowledgement**—When an 802.1w switch receives a TCN message on a designated port from an 802.1D switch, it replies with an 802.1D configuration BPDU with the TCA bit set. However, if the TC-while timer (the same as the TC timer in 802.1D) is active on a root port connected to an 802.1D switch and a configuration BPDU with the TCA set is received, the TC-while timer is reset.

This method of operation is required only for 802.1D switches. The 802.1w BPDUs do not have the TCA bit set.

- **Protocol migration**—For backward compatibility with 802.1D switches, 802.1w selectively sends 802.1D configuration BPDUs and TCN BPDUs on a per-port basis.

When a port is initialized, the migrate-delay timer is started (specifies the minimum time during which 802.1w BPDUs are sent), and 802.1w BPDUs are sent. While this timer is active, the switch processes all BPDUs received on that port and ignores the protocol type.

If the switch receives an 802.1D BPDU after the port migration-delay timer has expired, it assumes that it is connected to an 802.1D switch and starts using only 802.1D BPDUs. However, if the 802.1w switch is using 802.1D BPDUs on a port and receives an 802.1w BPDU after the timer has expired, it restarts the timer and starts using 802.1w BPDUs on that port.

**Note**

---

If you want all switches to renegotiate the protocol, you must restart Rapid PVST+.

---

**Related Topics**

- [Restarting the Protocol](#), page 159

## Rapid PVST+ Interoperation with 802.1s MST

Rapid PVST+ interoperates seamlessly with the IEEE 802.1s Multiple Spanning Tree (MST) standard. No user configuration is needed.

## Configuring Rapid PVST+

Rapid PVST+, which has the 802.1w standard applied to the Rapid PVST+ protocol, is the default STP setting in the software.

You enable Rapid PVST+ on a per-VLAN basis. The software maintains a separate instance of STP for each VLAN (except on those VLANS on which you disable STP). By default, Rapid PVST+ is enabled on the default VLAN and on each VLAN that you create.

## Enabling Rapid PVST+

Once you enable Rapid PVST+ on the switch, you must enable Rapid PVST+ on the specified VLANs. Rapid PVST+ is the default STP mode. You cannot simultaneously run MST and Rapid PVST+.



**Note** Changing the spanning tree mode disrupts traffic because all spanning tree instances are stopped for the previous mode and started for the new mode.

### SUMMARY STEPS

1. switch# **configure terminal**
2. switch(config)# **spanning-tree mode rapid-pvst**

### DETAILED STEPS

|               | Command or Action                                    | Purpose                                                                                                                                                                                                                                               |
|---------------|------------------------------------------------------|-------------------------------------------------------------------------------------------------------------------------------------------------------------------------------------------------------------------------------------------------------|
| <b>Step 1</b> | switch# <b>configure terminal</b>                    | Enters configuration mode.                                                                                                                                                                                                                            |
| <b>Step 2</b> | switch(config)# <b>spanning-tree mode rapid-pvst</b> | Enables Rapid PVST+ on the switch. Rapid PVST+ is the default spanning tree mode.<br><b>Note</b> Changing the spanning tree mode disrupts traffic because all spanning tree instances are stopped for the previous mode and started for the new mode. |

This example shows how to enable Rapid PVST+ on the switch:

```
switch# configure terminal
switch(config)# spanning-tree mode rapid-pvst
```



**Note** Because STP is enabled by default, entering the **show running-config** command to view the resulting configuration does not display the command that you entered to enable Rapid PVST+.

## Enabling Rapid PVST+ per VLAN

You can enable or disable Rapid PVST+ on each VLAN.



**Note** Rapid PVST+ is enabled by default on the default VLAN and on all VLANs that you create.

## SUMMARY STEPS

1. switch# **configure terminal**
2. switch(config)# **spanning-tree** *vlan-range*
3. (Optional) switch(config)# **no spanning-tree** *vlan-range*

## DETAILED STEPS

|               | Command or Action                                         | Purpose                                                                                                                                                                                                                                                                                                                                                                                                                                                                                                                                                                                                                                                                                                                    |
|---------------|-----------------------------------------------------------|----------------------------------------------------------------------------------------------------------------------------------------------------------------------------------------------------------------------------------------------------------------------------------------------------------------------------------------------------------------------------------------------------------------------------------------------------------------------------------------------------------------------------------------------------------------------------------------------------------------------------------------------------------------------------------------------------------------------------|
| <b>Step 1</b> | switch# <b>configure terminal</b>                         | Enters configuration mode.                                                                                                                                                                                                                                                                                                                                                                                                                                                                                                                                                                                                                                                                                                 |
| <b>Step 2</b> | switch(config)# <b>spanning-tree</b> <i>vlan-range</i>    | Enables Rapid PVST+ (default STP) on a per VLAN basis. The <i>vlan-range</i> value can be 2 through 4094 (except reserved VLAN values).                                                                                                                                                                                                                                                                                                                                                                                                                                                                                                                                                                                    |
| <b>Step 3</b> | switch(config)# <b>no spanning-tree</b> <i>vlan-range</i> | (Optional)<br>Disables Rapid PVST+ on the specified VLAN.<br><br><b>Caution</b> Do not disable spanning tree on a VLAN unless all switches and bridges in the VLAN have spanning tree disabled. You cannot disable spanning tree on some of the switches and bridges in a VLAN and leave it enabled on other switches and bridges. This action can have unexpected results because switches and bridges with spanning tree enabled will have incomplete information regarding the physical topology of the network.<br><br>Do not disable spanning tree in a VLAN without ensuring that there are no physical loops present in the VLAN. Spanning tree serves as a safeguard against misconfigurations and cabling errors. |

This example shows how to enable STP on a VLAN:

```
switch# configure terminal
switch(config)# spanning-tree vlan 5
```

## Configuring the Root Bridge ID

The software maintains a separate instance of STP for each active VLAN in Rapid PVST+. For each VLAN, the switch with the lowest bridge ID becomes the root bridge for that VLAN.

To configure a VLAN instance to become the root bridge, modify the bridge priority from the default value (32768) to a significantly lower value.

When you enter the **spanning-tree vlan** *vlan\_ID* **root** command, the switch checks the bridge priority of the current root bridges for each VLAN. The switch sets the bridge priority for the specified VLANs to 24576 if this value will cause the switch to become the root for the specified VLANs. If any root bridge for the specified VLANs has a bridge priority lower than 24576, the switch sets the bridge priority for the specified VLANs to 4096 less than the lowest bridge priority.

**Note**

The **spanning-tree vlan** *vlan\_ID* **root** command fails if the value required to be the root bridge is less than 1.

**Caution**

The root bridge for each instance of STP should be a backbone or distribution switch. Do not configure an access switch as the STP primary root.

Enter the **diameter** keyword to specify the network diameter (that is, the maximum number of bridge hops between any two end stations in the network). When you specify the network diameter, the software automatically selects an optimal hello time, forward delay time, and maximum age time for a network of that diameter, which can significantly reduce the STP convergence time. You can enter the **hello-time** keyword to override the automatically calculated hello time.

**Note**

With the switch configured as the root bridge, do not manually configure the hello time, forward-delay time, and maximum-age time using the **spanning-tree mst hello-time**, **spanning-tree mst forward-time**, and **spanning-tree mst max-age** configuration commands.

**SUMMARY STEPS**

1. switch# **configure terminal**
2. switch(config)# **spanning-tree vlan** *vlan-range* **root primary** [**diameter** *dia* [**hello-time** *hello-time*]]

**DETAILED STEPS**

|               | Command or Action                                                                                                                                     | Purpose                                                                                                                                                                                                                                                       |
|---------------|-------------------------------------------------------------------------------------------------------------------------------------------------------|---------------------------------------------------------------------------------------------------------------------------------------------------------------------------------------------------------------------------------------------------------------|
| <b>Step 1</b> | switch# <b>configure terminal</b>                                                                                                                     | Enters configuration mode.                                                                                                                                                                                                                                    |
| <b>Step 2</b> | switch(config)# <b>spanning-tree vlan</b> <i>vlan-range</i> <b>root primary</b> [ <b>diameter</b> <i>dia</i> [ <b>hello-time</b> <i>hello-time</i> ]] | Configures a software switch as the primary root bridge. The <i>vlan-range</i> value can be 2 through 4094 (except reserved VLAN values.) The <i>dia</i> default is 7. The <i>hello-time</i> can be from 1 to 10 seconds, and the default value is 2 seconds. |

This example shows how to configure the switch as the root bridge for a VLAN:

```
switch# configure terminal
switch(config)# spanning-tree vlan 5 root primary diameter 4
```

## Configuring a Secondary Root Bridge

When you configure a software switch as the secondary root, the STP bridge priority is modified from the default value (32768) so that the switch is likely to become the root bridge for the specified VLANs if the primary root bridge fails (assuming the other switches in the network use the default bridge priority of 32768). STP sets the bridge priority to 28672.

Enter the **diameter** keyword to specify the network diameter (that is, the maximum number of bridge hops between any two end stations in the network). When you specify the network diameter, the software automatically selects an optimal hello time, forward delay time, and maximum age time for a network of that diameter, which can significantly reduce the STP convergence time. You can enter the **hello-time** keyword to override the automatically calculated hello time.

You configure more than one switch in this manner to have multiple backup root bridges. Enter the same network diameter and hello time values that you used when configuring the primary root bridge.



**Note** With the switch configured as the root bridge, do not manually configure the hello time, forward-delay time, and maximum-age time using the **spanning-tree mst hello-time**, **spanning-tree mst forward-time**, and **spanning-tree mst max-age** global configuration commands.

## SUMMARY STEPS

1. switch# **configure terminal**
2. switch(config)# **spanning-tree vlan *vlan-range* root secondary [diameter *dia* [hello-time *hello-time*]]**

## DETAILED STEPS

|               | Command or Action                                                                                                               | Purpose                                                                                                                                                                                                                                                         |
|---------------|---------------------------------------------------------------------------------------------------------------------------------|-----------------------------------------------------------------------------------------------------------------------------------------------------------------------------------------------------------------------------------------------------------------|
| <b>Step 1</b> | switch# <b>configure terminal</b>                                                                                               | Enters configuration mode.                                                                                                                                                                                                                                      |
| <b>Step 2</b> | switch(config)# <b>spanning-tree vlan <i>vlan-range</i> root secondary [diameter <i>dia</i> [hello-time <i>hello-time</i>]]</b> | Configures a software switch as the secondary root bridge. The <i>vlan-range</i> value can be 2 through 4094 (except reserved VLAN values.) The <i>dia</i> default is 7. The <i>hello-time</i> can be from 1 to 10 seconds, and the default value is 2 seconds. |

This example shows how to configure the switch as the secondary root bridge for a VLAN:

```
switch# configure terminal
switch(config)# spanning-tree vlan 5 root secondary diameter 4
```

## Configuring the Rapid PVST+ Port Priority

You can assign lower priority values to LAN ports that you want Rapid PVST+ to select first and higher priority values to LAN ports that you want Rapid PVST+ to select last. If all LAN ports have the same priority value, Rapid PVST+ puts the LAN port with the lowest LAN port number in the forwarding state and blocks other LAN ports.

The software uses the port priority value when the LAN port is configured as an access port and uses VLAN port priority values when the LAN port is configured as a trunk port.

## SUMMARY STEPS

1. switch# **configure terminal**
2. switch(config)# **interface *type slot/port***
3. switch(config-if)# **spanning-tree [vlan *vlan-list*] port-priority *priority***

## DETAILED STEPS

|        | Command or Action                                                                                             | Purpose                                                                                                                                                                                                                                                                   |
|--------|---------------------------------------------------------------------------------------------------------------|---------------------------------------------------------------------------------------------------------------------------------------------------------------------------------------------------------------------------------------------------------------------------|
| Step 1 | switch# <b>configure terminal</b>                                                                             | Enters configuration mode.                                                                                                                                                                                                                                                |
| Step 2 | switch(config)# <b>interface</b> <i>type slot/port</i>                                                        | Specifies the interface to configure, and enters interface configuration mode.                                                                                                                                                                                            |
| Step 3 | switch(config-if)# <b>spanning-tree</b> [ <b>vlan</b> <i>vlan-list</i> ] <b>port-priority</b> <i>priority</i> | Configures the port priority for the LAN interface. The <i>priority</i> value can be from 0 to 224. The lower the value, the higher the priority. The priority values are 0, 32, 64, 96, 128, 160, 192, and 224. All other values are rejected. The default value is 128. |

This example shows how to configure the access port priority of an Ethernet interface:

```
switch# configure terminal
switch(config)# interface ethernet 1/4
switch(config-if)# spanning-tree port-priority 160
```

You can only apply this command to a physical Ethernet interface.

## Configuring the Rapid PVST+ Pathcost Method and Port Cost

On access ports, you assign port cost by the port. On trunk ports, you assign the port cost by VLAN; you can configure the same port cost on all the VLANs on a trunk.

**Note**

In Rapid PVST+ mode, you can use either the short or long pathcost method, and you can configure the method in either the interface or configuration submenu. The default pathcost method is short.

## SUMMARY STEPS

1. switch# **configure terminal**
2. switch(config)# **spanning-tree pathcost method** {**long** | **short**}
3. switch(config)# **interface** *type slot/port*
4. switch(config-if)# **spanning-tree** [**vlan** *vlan-id*] **cost** [*value* | **auto**]

## DETAILED STEPS

|        | Command or Action                                                                   | Purpose                                                                                                |
|--------|-------------------------------------------------------------------------------------|--------------------------------------------------------------------------------------------------------|
| Step 1 | switch# <b>configure terminal</b>                                                   | Enters configuration mode.                                                                             |
| Step 2 | switch(config)# <b>spanning-tree pathcost method</b> { <b>long</b>   <b>short</b> } | Selects the method used for Rapid PVST+ pathcost calculations. The default method is the short method. |

|        | Command or Action                                                                                                 | Purpose                                                                                                                                                                                                                                                                                                                                                                                                                                                           |
|--------|-------------------------------------------------------------------------------------------------------------------|-------------------------------------------------------------------------------------------------------------------------------------------------------------------------------------------------------------------------------------------------------------------------------------------------------------------------------------------------------------------------------------------------------------------------------------------------------------------|
| Step 3 | switch(config)# <b>interface</b> <i>type slot/port</i>                                                            | Specifies the interface to configure, and enters interface configuration mode.                                                                                                                                                                                                                                                                                                                                                                                    |
| Step 4 | switch(config-if)# <b>spanning-tree</b> [ <b>vlan</b> <i>vlan-id</i> ] <b>cost</b> [ <i>value</i>   <b>auto</b> ] | Configures the port cost for the LAN interface. The cost value, depending on the pathcost calculation method, can be as follows: <ul style="list-style-type: none"> <li>• short—1 to 65535</li> <li>• long—1 to 200000000</li> </ul> <p><b>Note</b> You configure this parameter per interface on access ports and per VLAN on trunk ports. The default is <b>auto</b>, which sets the port cost on both the pathcost calculation method and the media speed.</p> |

This example shows how to configure the access port cost of an Ethernet interface:

```
switch# configure terminal
switch (config)# spanning-tree pathcost method long
switch (config)# interface ethernet 1/4
switch(config-if)# spanning-tree cost 1000
```

You can only apply this command to a physical Ethernet interface.

## Configuring the Rapid PVST+ Bridge Priority of a VLAN

You can configure the Rapid PVST+ bridge priority of a VLAN.



### Note

Be careful when using this configuration. For most situations, we recommend that you configure the primary root and secondary root to modify the bridge priority.

### SUMMARY STEPS

1. switch# **configure terminal**
2. switch(config)# **spanning-tree vlan** *vlan-range* **priority** *value*

### DETAILED STEPS

|        | Command or Action                                                                        | Purpose                                                                                                                                                                                                                             |
|--------|------------------------------------------------------------------------------------------|-------------------------------------------------------------------------------------------------------------------------------------------------------------------------------------------------------------------------------------|
| Step 1 | switch# <b>configure terminal</b>                                                        | Enters configuration mode.                                                                                                                                                                                                          |
| Step 2 | switch(config)# <b>spanning-tree vlan</b> <i>vlan-range</i> <b>priority</b> <i>value</i> | Configures the bridge priority of a VLAN. Valid values are 0, 4096, 8192, 12288, 16384, 20480, 24576, 28672, 32768, 36864, 40960, 45056, 49152, 53248, 57344, and 61440. All other values are rejected. The default value is 32768. |

This example shows how to configure the bridge priority of a VLAN:

```
switch# configure terminal
switch(config)# spanning-tree vlan 5 priority 8192
```

## Configuring the Rapid PVST+ Hello Time for a VLAN

You can configure the Rapid PVST+ hello time for a VLAN.



### Note

Be careful when using this configuration. For most situations, we recommend that you configure the primary root and secondary root to modify the hello time.

### SUMMARY STEPS

1. switch# **configure terminal**
2. switch(config)# **spanning-tree vlan *vlan-range* hello-time *hello-time***

### DETAILED STEPS

|               | Command or Action                                                                        | Purpose                                                                                                          |
|---------------|------------------------------------------------------------------------------------------|------------------------------------------------------------------------------------------------------------------|
| <b>Step 1</b> | switch# <b>configure terminal</b>                                                        | Enters configuration mode.                                                                                       |
| <b>Step 2</b> | switch(config)# <b>spanning-tree vlan <i>vlan-range</i> hello-time <i>hello-time</i></b> | Configures the hello time of a VLAN. The hello time value can be from 1 to 10 seconds. The default is 2 seconds. |

This example shows how to configure the hello time for a VLAN:

```
switch# configure terminal
switch(config)# spanning-tree vlan 5 hello-time 7
```

## Configuring the Rapid PVST+ Forward Delay Time for a VLAN

You can configure the forward delay time per VLAN when using Rapid PVST+.

### SUMMARY STEPS

1. switch# **configure terminal**
2. switch(config)# **spanning-tree vlan *vlan-range* forward-time *forward-time***

### DETAILED STEPS

|               | Command or Action                 | Purpose                    |
|---------------|-----------------------------------|----------------------------|
| <b>Step 1</b> | switch# <b>configure terminal</b> | Enters configuration mode. |

|        | Command or Action                                                                                      | Purpose                                                                                                                               |
|--------|--------------------------------------------------------------------------------------------------------|---------------------------------------------------------------------------------------------------------------------------------------|
| Step 2 | switch(config)# <b>spanning-tree vlan</b> <i>vlan-range</i><br><b>forward-time</b> <i>forward-time</i> | Configures the forward delay time of a VLAN. The forward delay time value can be from 4 to 30 seconds, and the default is 15 seconds. |

This example shows how to configure the forward delay time for a VLAN:

```
switch# configure terminal
switch(config)# spanning-tree vlan 5 forward-time 21
```

## Configuring the Rapid PVST+ Maximum Age Time for a VLAN

You can configure the maximum age time per VLAN when using Rapid PVST+.

### SUMMARY STEPS

1. switch# **configure terminal**
2. switch(config)# **spanning-tree vlan** *vlan-range* **max-age** *max-age*

### DETAILED STEPS

|        | Command or Action                                                                            | Purpose                                                                                                                               |
|--------|----------------------------------------------------------------------------------------------|---------------------------------------------------------------------------------------------------------------------------------------|
| Step 1 | switch# <b>configure terminal</b>                                                            | Enters configuration mode.                                                                                                            |
| Step 2 | switch(config)# <b>spanning-tree vlan</b> <i>vlan-range</i><br><b>max-age</b> <i>max-age</i> | Configures the maximum aging time of a VLAN. The maximum aging time value can be from 6 to 40 seconds, and the default is 20 seconds. |

This example shows how to configure the maximum aging time for a VLAN:

```
switch# configure terminal
switch(config)# spanning-tree vlan 5 max-age 36
```

## Specifying the Link Type

Rapid connectivity (802.1w standard) is established only on point-to-point links. By default, the link type is controlled from the duplex mode of the interface. A full-duplex port is considered to have a point-to-point connection; a half-duplex port is considered to have a shared connection.

If you have a half-duplex link physically connected point-to-point to a single port on a remote switch, you can override the default setting on the link type and enable rapid transitions.

If you set the link to shared, STP moves back to 802.1D.

## SUMMARY STEPS

1. switch# **configure terminal**
2. switch(config)# **interface** *type slot/port*
3. switch(config-if)# **spanning-tree link-type** {**auto** | **point-to-point** | **shared**}

## DETAILED STEPS

|               | Command or Action                                                                                         | Purpose                                                                                                                                                                                                                                                                                                                                                                          |
|---------------|-----------------------------------------------------------------------------------------------------------|----------------------------------------------------------------------------------------------------------------------------------------------------------------------------------------------------------------------------------------------------------------------------------------------------------------------------------------------------------------------------------|
| <b>Step 1</b> | switch# <b>configure terminal</b>                                                                         | Enters configuration mode.                                                                                                                                                                                                                                                                                                                                                       |
| <b>Step 2</b> | switch(config)# <b>interface</b> <i>type slot/port</i>                                                    | Specifies the interface to configure, and enters the interface configuration mode.                                                                                                                                                                                                                                                                                               |
| <b>Step 3</b> | switch(config-if)# <b>spanning-tree link-type</b> { <b>auto</b>   <b>point-to-point</b>   <b>shared</b> } | Configures the link type to be either a point-to-point link or shared link. The system reads the default value from the switch connection, as follows: half duplex links are shared and full-duplex links are point-to-point. If the link type is shared, the STP reverts to 802.1D. The default is auto, which sets the link type based on the duplex setting of the interface. |

This example shows how to configure the link type as a point-to-point link:

```
switch# configure terminal
switch (config)# interface ethernet 1/4
switch(config-if)# spanning-tree link-type point-to-point
```

You can only apply this command to a physical Ethernet interface.

## Restarting the Protocol

A bridge running Rapid PVST+ can send 802.1D BPDUs on one of its ports when it is connected to a legacy bridge. However, the STP protocol migration cannot determine whether the legacy switch has been removed from the link unless the legacy switch is the designated switch. You can restart the protocol negotiation (force the renegotiation with neighboring switches) on the entire switch or on specified interfaces.

| Command                                                                                                                                  | Purpose                                                                       |
|------------------------------------------------------------------------------------------------------------------------------------------|-------------------------------------------------------------------------------|
| switch# <b>clear spanning-tree detected-protocol</b> [ <b>interface</b> <i>interface</i> [ <i>interface-num</i>   <i>port-channel</i> ]] | Restarts Rapid PVST+ on all interfaces on the switch or specified interfaces. |

The following example shows how to restart Rapid PVST+ on an Ethernet interface:

```
switch# clear spanning-tree detected-protocol interface ethernet 1/8
```

## Verifying Rapid PVST+ Configurations

To display Rapid PVST+ configuration information, perform one of these tasks:

| Command                                                | Purpose                                                                             |
|--------------------------------------------------------|-------------------------------------------------------------------------------------|
| switch# <b>show running-config spanning-tree [all]</b> | Displays the current spanning tree configuration.                                   |
| switch# <b>show spanning-tree [options]</b>            | Displays selected detailed information for the current spanning tree configuration. |

This example shows how to display spanning tree status:

```
switch# show spanning-tree brief

VLAN0001
  Spanning tree enabled protocol rstp
  Root ID    Priority    32768
            Address    001c.b05a.5447
            Cost      2
            Port      131 (Ethernet1/3)
            Hello Time 2 sec  Max Age 20 sec  Forward Delay 15 sec
  Bridge ID  Priority    32769 (priority 32768 sys-id-ext 1)
            Address    000d.ec6d.7841
            Hello Time 2 sec  Max Age 20 sec  Forward Delay 15 sec

Interface    Role Sts Cost      Prio.Nbr Type
-----
Eth1/3      Root FWD 2         128.131 P2p Peer (STP)
veth1/1     Desg FWD 2         128.129 Edge P2p
```





# CHAPTER 10

## Configuring Multiple Spanning Tree

Multiple Spanning Tree (MST), which is the IEEE 802.1s standard, allows you to assign two or more VLANs to a spanning tree instance. MST is not the default spanning tree mode; Rapid per VLAN Spanning Tree (Rapid PVST+) is the default mode. MST instances with the same name, revision number, and VLAN-to-instance mapping combine to form an MST region. The MST region appears as a single bridge to spanning tree configurations outside the region. MST fails over to IEEE 802.1D Spanning Tree Protocol (STP) when it receives an 802.1D message from a neighboring switch.



### Note

Spanning tree is used to refer to IEEE 802.1w and IEEE 802.1s. If the text is discussing the IEEE 802.1D Spanning Tree Protocol, 802.1D is stated specifically.

This chapter describes how to configure MST on Cisco Nexus 5000 Series switches. It contains the following sections:

- [Information About MST, page 135](#)
- [Configuring MST, page 143](#)
- [Verifying MST Configurations, page 159](#)

## Information About MST

### MST Overview



### Note

You must enable MST; Rapid PVST+ is the default spanning tree mode.

MST maps multiple VLANs into a spanning tree instance, with each instance having a spanning tree topology independent of other spanning tree instances. This architecture provides multiple forwarding paths for data traffic, enables load balancing, and reduces the number of STP instances required to support a large number of VLANs.

MST provides rapid convergence through explicit handshaking as each MST instance uses the IEEE 802.1w standard, which eliminates the 802.1D forwarding delay and quickly transitions root bridge ports and designated ports to the forwarding state.

MAC address reduction is always enabled while you are using MST. You cannot disable this feature.

MST improves spanning tree operation and maintains backward compatibility with these STP versions:

- Original 802.1D spanning tree
- Rapid per-VLAN spanning tree (Rapid PVST+)  
IEEE 802.1w defined the Rapid Spanning Tree Protocol (RSTP) and was incorporated into IEEE 802.1D.
- IEEE 802.1s defined MST and was incorporated into IEEE 802.1Q.

## MST Regions

To allow switches to participate in MST instances, you must consistently configure the switches with the same MST configuration information.

A collection of interconnected switches that have the same MST configuration is an MST region. An MST region is a linked group of MST bridges with the same MST configuration.

The MST configuration controls the MST region to which each switch belongs. The configuration includes the name of the region, the revision number, and the MST VLAN-to-instance assignment map.

A region can have one or multiple members with the same MST configuration. Each member must be capable of processing 802.1w bridge protocol data units (BPDUs). There is no limit to the number of MST regions in a network.

Each region can support up to 65 MST instances (MSTIs). Instances are identified by any number in the range from 1 to 4094. The system reserves Instance 0 for a special instance, which is the IST. You can assign a VLAN to only one MST instance at a time.

The MST region appears as a single bridge to adjacent MST regions and to other Rapid PVST+ regions and 802.1D spanning tree protocols.

**Note**

---

We recommend that you do not partition the network into a large number of regions.

---

## MST BPDUs

Each region has only one MST BPDU, and that BPDU carries an M-record for each MSTI within the region (see the following figure). Only the IST sends BPDUs for the MST region; all M-records are encapsulated in

that one BPDU that the IST sends. Because the MST BPDU carries information for all instances, the number of BPDUs that need to be processed to support MSTIs is significantly reduced.

**Figure 19: MST BPDU with M-Records for MSTIs**

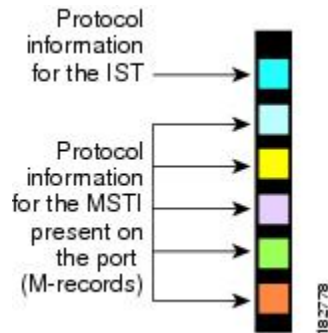

## MST Configuration Information

The MST configuration that must be identical on all switches within a single MST region is configured by the user.

You can configure the following three parameters of the MST configuration:

- Name—32-character string, null padded and null terminated, identifying the MST region
- Revision number—Unsigned 16-bit number that identifies the revision of the current MST configuration



### Note

You must set the revision number when required as part of the MST configuration. The revision number is *not* incremented automatically each time that the MST configuration is committed.

- MST configuration table—4096-element table that associates each of the potential 4094 VLANs supported to a given instance with the first (0) and last element (4095) set to 0. The value of element number X represents the instance to which VLAN X is mapped.



### Caution

When you change the VLAN-to-MSTI mapping, the system restarts MST.

MST BPDUs contain these three configuration parameters. An MST bridge accepts an MST BPDU into its own region only if these three configuration parameters match exactly. If one configuration attribute differs, the MST bridge considers the BPDU to be from another MST region.

## IST, CIST, and CST

### IST, CIST, and CST Overview

Unlike Rapid PVST+, in which all the STP instances are independent, MST establishes and maintains IST, CIST, and CST spanning trees, as follows:

- An IST is the spanning tree that runs in an MST region.

MST establishes and maintains additional spanning trees within each MST region; these spanning trees are called, multiple spanning tree instances (MSTIs).

Instance 0 is a special instance for a region, known as the IST. The IST always exists on all ports; you cannot delete the IST, or Instance 0. By default, all VLANs are assigned to the IST. All other MST instances are numbered from 1 to 4094.

The IST is the only STP instance that sends and receives BPDUs. All of the other MSTI information is contained in MST records (M-records), which are encapsulated within MST BPDUs.

All MSTIs within the same region share the same protocol timers, but each MSTI has its own topology parameters, such as the root bridge ID, the root path cost, and so forth.

An MSTI is local to the region; for example, MSTI 9 in region A is independent of MSTI 9 in region B, even if regions A and B are interconnected.

- The CST interconnects the MST regions and any instance of 802.1D and 802.1w STP that may be running on the network. The CST is the one STP instance for the entire bridged network and encompasses all MST regions and 802.1w and 802.1D instances.
- A CIST is a collection of the ISTs in each MST region. The CIST is the same as an IST inside an MST region, and the same as a CST outside an MST region.

The spanning tree computed in an MST region appears as a subtree in the CST that encompasses the entire switched domain. The CIST is formed by the spanning tree algorithm running among switches that support the 802.1w, 802.1s, and 802.1D standards. The CIST inside an MST region is the same as the CST outside a region.

## Spanning Tree Operation Within an MST Region

The IST connects all the MST switches in a region. When the IST converges, the root of the IST becomes the CIST regional root. The CIST regional root is also the CIST root if there is only one region in the network. If the CIST root is outside the region, the protocol selects one of the MST switches at the boundary of the region as the CIST regional root.

When an MST switch initializes, it sends BPDUs that identify itself as the root of the CIST and the CIST regional root, with both the path costs to the CIST root and to the CIST regional root set to zero. The switch also initializes all of its MSTIs and claims to be the root for all of them. If the switch receives superior MST root information (lower switch ID, lower path cost, and so forth) than the information that is currently stored for the port, it relinquishes its claim as the CIST regional root.

During initialization, an MST region might have many subregions, each with its own CIST regional root. As switches receive superior IST information from a neighbor in the same region, they leave their old subregions and join the new subregion that contains the true CIST regional root. This action causes all subregions to shrink except for the subregion that contains the true CIST regional root.

All switches in the MST region must agree on the same CIST regional root. Any two switches in the region will only synchronize their port roles for an MSTI if they converge to a common CIST regional root.

## Spanning Tree Operations Between MST Regions

If you have multiple regions or 802.1w or 802.1D STP instances within a network, MST establishes and maintains the CST, which includes all MST regions and all 802.1w and 802.1D STP switches in the network. The MSTIs combine with the IST at the boundary of the region to become the CST.

The IST connects all the MST switches in the region and appears as a subtree in the CIST that encompasses the entire switched domain. The root of the subtree is the CIST regional root. The MST region appears as a virtual switch to adjacent STP switches and MST regions.

The following figure shows a network with three MST regions and an 802.1D switch (D). The CIST regional root for region 1 (A) is also the CIST root. The CIST regional root for region 2 (B) and the CIST regional root for region 3 (C) are the roots for their respective subtrees within the CIST.

**Figure 20: MST Regions, CIST Regional Roots, and CST Root**

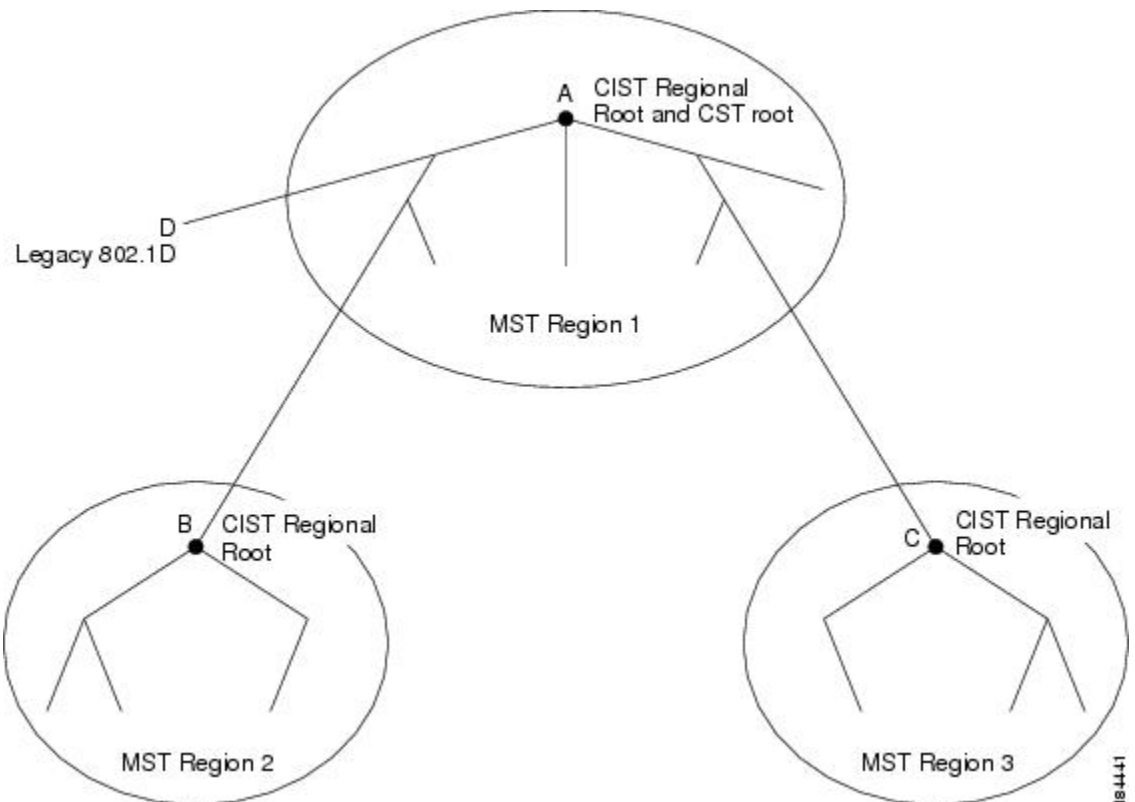

Only the CST instance sends and receives BPDUs. MSTIs add their spanning tree information into the BPDUs (as M-records) to interact with neighboring switches and compute the final spanning tree topology. Because of this, the spanning tree parameters related to the BPDU transmission (for example, hello time, forward time, max-age, and max-hops) are configured only on the CST instance but affect all MSTIs. You can configure the parameters related to the spanning tree topology (for example, the switch priority, the port VLAN cost, and the port VLAN priority) on both the CST instance and the MSTI.

MST switches use Version 3 BPDUs or 802.1D STP BPDUs to communicate with 802.1D-only switches. MST switches use MST BPDUs to communicate with MST switches.

## MST Terminology

MST naming conventions include identification of some internal or regional parameters. These parameters are used only within an MST region, compared to external parameters that are used throughout the whole network. Because the CIST is the only spanning tree instance that spans the whole network, only the CIST

parameters require the external qualifiers and not the internal or regional qualifiers. The MST terminology is as follows:

- The CIST root is the root bridge for the CIST, which is the unique instance that spans the whole network.
- The CIST external root path cost is the cost to the CIST root. This cost is left unchanged within an MST region. An MST region looks like a single switch to the CIST. The CIST external root path cost is the root path cost calculated between these virtual switches and switches that do not belong to any region.
- If the CIST root is in the region, the CIST regional root is the CIST root. Otherwise, the CIST regional root is the closest switch to the CIST root in the region. The CIST regional root acts as a root bridge for the IST.
- The CIST internal root path cost is the cost to the CIST regional root in a region. This cost is only relevant to the IST, instance 0.

## Hop Count

MST does not use the message-age and maximum-age information in the configuration BPDU to compute the STP topology inside the MST region. Instead, the protocol uses the path cost to the root and a hop-count mechanism similar to the IP time-to-live (TTL) mechanism.

By using the **spanning-tree mst max-hops** global configuration command, you can configure the maximum hops inside the region and apply it to the IST and all MST instances in that region.

The hop count achieves the same result as the message-age information (triggers a reconfiguration). The root bridge of the instance always sends a BPDU (or M-record) with a cost of 0 and the hop count set to the maximum value. When a switch receives this BPDU, it decrements the received remaining hop count by one and propagates this value as the remaining hop count in the BPDUs that it generates. When the count reaches zero, the switch discards the BPDU and ages the information held for the port.

The message-age and maximum-age information in the 802.1w portion of the BPDU remain the same throughout the region (only on the IST), and the same values are propagated by the region-designated ports at the boundary.

You configure a maximum aging time as the number of seconds that a switch waits without receiving spanning tree configuration messages before attempting a reconfiguration.

## Boundary Ports

A boundary port is a port that connects one region to another. A designated port knows that it is on the boundary if it detects an STP bridge or receives an agreement proposal from an MST bridge with a different configuration or a Rapid PVST+ bridge. This definition allows two ports that are internal to a region to share a segment

with a port that belongs to a different region, creating the possibility of receiving both internal and external messages on a port (see the following figure).

**Figure 21: MST Boundary Ports**

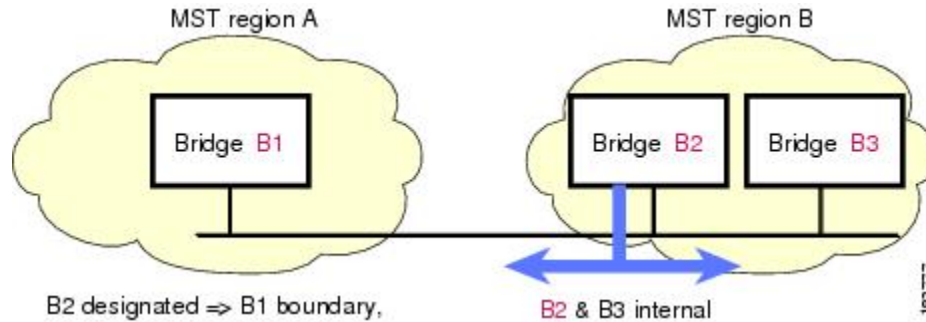

At the boundary, the roles of MST ports do not matter; the system forces their state to be the same as the IST port state. If the boundary flag is set for the port, the MST port-role selection process assigns a port role to the boundary and assigns the same state as the state of the IST port. The IST port at the boundary can take up any port role except a backup port role.

## Spanning-Tree Dispute Mechanism

Currently, this feature is not present in the IEEE MST standard, but it is included in the standard-compliant implementation. The software checks the consistency of the port role and state in the received BPDUs to detect unidirectional link failures that could cause bridging loops.

When a designated port detects a conflict, it keeps its role, but reverts to a discarding state because disrupting connectivity in case of inconsistency is preferable to opening a bridging loop.

The following figure shows a unidirectional link failure that typically creates a bridging loop. Switch A is the root bridge, and its BPDUs are lost on the link leading to switch B. Rapid PVST+ (802.1w) and MST BPDUs include the role and state of the sending port. With this information, switch A can detect that switch B does not react to the superior BPDUs that it sends and that switch B is the designated, not root port. As a result, switch A blocks (or keeps blocking) its port, which prevents the bridging loop. The block is shown as an STP dispute.

**Figure 22: Detecting a Unidirectional Link Failure**

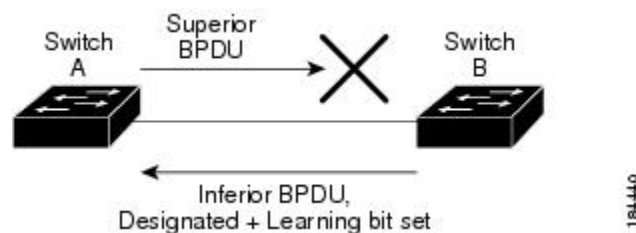

## Port Cost and Port Priority

Spanning tree uses port costs to break a tie for the designated port. Lower values indicate lower port costs, and spanning tree chooses the least costly path. Default port costs are taken from the bandwidth of the interface, as follows:

- 10 Mbps—2,000,000
- 100 Mbps—200,000
- 1 Gigabit Ethernet—20,000
- 10 Gigabit Ethernet—2,000

You can configure the port costs in order to influence which port is chosen.

**Note**

---

MST always uses the long path cost calculation method, so the range of valid values is between 1 and 200,000,000.

---

The system uses port priorities to break ties among ports with the same cost. A lower number indicates a higher priority. The default port priority is 128. You can configure the priority to values between 0 and 224, in increments of 32.

## Interoperability with IEEE 802.1D

A switch that runs MST supports a built-in protocol migration feature that enables it to interoperate with 802.1D STP switches. If this switch receives an 802.1D configuration BPDU (a BPDU with the protocol version set to 0), it sends only 802.1D BPDUs on that port. In addition, an MST switch can detect that a port is at the boundary of a region when it receives an 802.1D BPDU, an MST BPDU (Version 3) associated with a different region, or an 802.1w BPDU (Version 2).

However, the switch does not automatically revert to the MST mode if it no longer receives 802.1D BPDUs because it cannot detect whether the 802.1D switch has been removed from the link unless the 802.1D switch is the designated switch. A switch might also continue to assign a boundary role to a port when the switch to which this switch is connected has joined the region.

To restart the protocol migration process (force the renegotiation with neighboring switches), enter the **clear spanning-tree detected-protocols** command.

All Rapid PVST+ switches (and all 802.1D STP switches) on the link can process MST BPDUs as if they are 802.1w BPDUs. MST switches can send either Version 0 configuration and topology change notification (TCN) BPDUs or Version 3 MST BPDUs on a boundary port. A boundary port connects to a LAN, the designated switch of which is either a single spanning tree switch or a switch with a different MST configuration.

**Note**

---

MST interoperates with the Cisco prestandard MSTP whenever it receives prestandard MSTP on an MST port; no explicit configuration is necessary.

---

## Interoperability with Rapid PVST+: Understanding PVST Simulation

MST interoperates with Rapid PVST+ with no need for user configuration. The PVST simulation feature enables this seamless interoperability.

**Note**

PVST simulation is enabled by default. That is, by default, all interfaces on the switch interoperate between MST and Rapid PVST+.

However, you may want to control the connection between MST and Rapid PVST+ to protect against accidentally connecting an MST-enabled port to a Rapid PVST+-enabled port. Because Rapid PVST+ is the default STP mode, you may encounter many Rapid PVST+-enabled connections.

Disabling Rapid PVST+ simulation, which can be done per port or globally for the entire switch, moves the MST-enabled port to the blocking state once it detects it is connected to a Rapid PVST+-enabled port. This port remains in the inconsistent state until the port stops receiving Rapid PVST+/SSTP BPDUs, and then the port resumes the normal STP transition process.

## Configuring MST

### MST Configuration Guidelines

When configuring MST, follow these guidelines:

- When you work with private VLANs, enter the **private-vlan synchronize** command to map the secondary VLANs to the same MST instance as the primary VLAN.
- When you are in the MST configuration mode, the following guidelines apply:
  - Each command reference line creates its pending regional configuration.
  - The pending region configuration starts with the current region configuration.
  - To leave the MST configuration mode without committing any changes, enter the **abort** command.
  - To leave the MST configuration mode and commit all the changes that you made before you left the mode, enter the **exit** command.

### Enabling MST

You must enable MST; Rapid PVST+ is the default.

**Caution**

Changing the spanning tree mode disrupts traffic because all spanning tree instances are stopped for the previous mode and started for the new mode. Also, having two different spanning-tree modes on vPC peer switches is an inconsistency, hence this operation is disruptive.

## SUMMARY STEPS

1. switch# **configure terminal**
2. switch(config)# **spanning-tree mode mst**
3. (Optional) switch(config)# **no spanning-tree mode mst**

## DETAILED STEPS

|        | Command or Action                                | Purpose                                                                  |
|--------|--------------------------------------------------|--------------------------------------------------------------------------|
| Step 1 | switch# <b>configure terminal</b>                | Enters configuration mode.                                               |
| Step 2 | switch(config)# <b>spanning-tree mode mst</b>    | Enables MST on the switch.                                               |
| Step 3 | switch(config)# <b>no spanning-tree mode mst</b> | (Optional)<br>Disables MST on the switch and returns you to Rapid PVST+. |

This example shows how to enable MST on the switch:

```
switch# configure terminal
switch(config)# spanning-tree mode mst
```



### Note

Because STP is enabled by default, entering a **show running-config** command to view the resulting configuration does not display the command that you entered to enable STP.

## Entering MST Configuration Mode

You enter MST configuration mode to configure the MST name, VLAN-to-instance mapping, and MST revision number on the switch.

For two or more switches to be in the same MST region, they must have the identical MST name, VLAN-to-instance mapping, and MST revision number.



### Note

Each command reference line creates its pending regional configuration in MST configuration mode. In addition, the pending region configuration starts with the current region configuration.

When you are working in MST configuration mode, note the difference between the **exit** and **abort** commands.

## SUMMARY STEPS

1. switch# **configure terminal**
2. switch(config)# **spanning-tree mst configuration**
3. switch(config-mst)# **exit** or switch(config-mst)# **abort**
4. (Optional) switch(config)# **no spanning-tree mst configuration**

## DETAILED STEPS

|        | Command or Action                                                      | Purpose                                                                                                                                                                                                                                                                                                                                            |
|--------|------------------------------------------------------------------------|----------------------------------------------------------------------------------------------------------------------------------------------------------------------------------------------------------------------------------------------------------------------------------------------------------------------------------------------------|
| Step 1 | switch# <b>configure terminal</b>                                      | Enters configuration mode.                                                                                                                                                                                                                                                                                                                         |
| Step 2 | switch(config)# <b>spanning-tree mst configuration</b>                 | Enters MST configuration mode on the system. You must be in the MST configuration mode to assign the MST configuration parameters, as follows: <ul style="list-style-type: none"> <li>• MST name</li> <li>• Instance-to-VLAN mapping</li> <li>• MST revision number</li> <li>• Synchronize primary and secondary VLANs in private VLANs</li> </ul> |
| Step 3 | switch(config-mst)# <b>exit</b> or<br>switch(config-mst)# <b>abort</b> | <ul style="list-style-type: none"> <li>• The first form commits all the changes and exits MST configuration mode.</li> <li>• The second form exits the MST configuration mode without committing any of the changes.</li> </ul>                                                                                                                    |
| Step 4 | switch(config)# <b>no spanning-tree mst configuration</b>              | (Optional)<br>Returns the MST region configuration to the following default values: <ul style="list-style-type: none"> <li>• The region name is an empty string.</li> <li>• No VLANs are mapped to any MST instance (all VLANs are mapped to the CIST instance).</li> <li>• The revision number is 0.</li> </ul>                                   |

## Specifying the MST Name

You configure a region name on the bridge. For two or more bridges to be in the same MST region, they must have the identical MST name, VLAN-to-instance mapping, and MST revision number.

## SUMMARY STEPS

1. switch# **configure terminal**
2. switch(config)# **spanning-tree mst configuration**
3. switch(config-mst)# **name name**

## DETAILED STEPS

|        | Command or Action                 | Purpose                    |
|--------|-----------------------------------|----------------------------|
| Step 1 | switch# <b>configure terminal</b> | Enters configuration mode. |

|        | Command or Action                                      | Purpose                                                                                                                                                |
|--------|--------------------------------------------------------|--------------------------------------------------------------------------------------------------------------------------------------------------------|
| Step 2 | switch(config)# <b>spanning-tree mst configuration</b> | Enters MST configuration submode.                                                                                                                      |
| Step 3 | switch(config-mst)# <b>name name</b>                   | Specifies the name for MST region. The <i>name</i> string has a maximum length of 32 characters and is case-sensitive. The default is an empty string. |

This example shows how to set the name of the MST region:

```
switch# configure terminal
switch(config)# spanning-tree mst configuration
switch(config-mst)# name accounting
```

## Specifying the MST Configuration Revision Number

You configure the revision number on the bridge. For two or more bridges to be in the same MST region, they must have the identical MST name, VLAN-to-instance mapping, and MST revision number.

### SUMMARY STEPS

1. switch# **configure terminal**
2. switch(config)# **spanning-tree mst configuration**
3. switch(config-mst)# **revision version**

### DETAILED STEPS

|        | Command or Action                                      | Purpose                                                                                                     |
|--------|--------------------------------------------------------|-------------------------------------------------------------------------------------------------------------|
| Step 1 | switch# <b>configure terminal</b>                      | Enters configuration mode.                                                                                  |
| Step 2 | switch(config)# <b>spanning-tree mst configuration</b> | Enters MST configuration submode.                                                                           |
| Step 3 | switch(config-mst)# <b>revision version</b>            | Specifies the revision number for the MST region. The range is from 0 to 65535, and the default value is 0. |

This example shows how to configure the revision number of the MSTI region for 5:

```
switch# configure terminal
switch(config)# spanning-tree mst configuration
switch(config-mst)# revision 5
```

## Specifying the Configuration on an MST Region

For two or more switches to be in the same MST region, they must have the same VLAN-to-instance mapping, the same configuration revision number, and the same MST name.

A region can have one member or multiple members with the same MST configuration; each member must be capable of processing IEEE 802.1w RSTP BPDUs. There is no limit to the number of MST regions in a

network, but each region can support only up to 65 MST instances. You can assign a VLAN to only one MST instance at a time.

## SUMMARY STEPS

1. switch# **configure terminal**
2. switch(config)# **spanning-tree mst configuration**
3. switch(config-mst)# **instance** *instance-id* **vlan** *vlan-range*
4. switch(config-mst)# **name** *name*
5. switch(config-mst)# **revision** *version*

## DETAILED STEPS

|               | Command or Action                                                                    | Purpose                                                                                                                                                                                                                                                                                                                                                                                                                                                                                                                                                                                                                                                                                                                                             |
|---------------|--------------------------------------------------------------------------------------|-----------------------------------------------------------------------------------------------------------------------------------------------------------------------------------------------------------------------------------------------------------------------------------------------------------------------------------------------------------------------------------------------------------------------------------------------------------------------------------------------------------------------------------------------------------------------------------------------------------------------------------------------------------------------------------------------------------------------------------------------------|
| <b>Step 1</b> | switch# <b>configure terminal</b>                                                    | Enters configuration mode.                                                                                                                                                                                                                                                                                                                                                                                                                                                                                                                                                                                                                                                                                                                          |
| <b>Step 2</b> | switch(config)# <b>spanning-tree mst configuration</b>                               | Enters MST configuration submode.                                                                                                                                                                                                                                                                                                                                                                                                                                                                                                                                                                                                                                                                                                                   |
| <b>Step 3</b> | switch(config-mst)# <b>instance</b> <i>instance-id</i> <b>vlan</b> <i>vlan-range</i> | <p>Maps VLANs to an MST instance as follows:</p> <ul style="list-style-type: none"> <li>• For <i>instance-id</i> , the range is from 1 to 4094.</li> <li>• For <b>vlan</b> <i>vlan-range</i> , the range is from 1 to 4094.</li> </ul> <p>When you map VLANs to an MST instance, the mapping is incremental, and the VLANs specified in the command are added to or removed from the VLANs that were previously mapped.</p> <p>To specify a VLAN range, enter a hyphen; for example, enter the <b>instance 1 vlan 1-63</b> command to map VLANs 1 through 63 to MST instance 1.</p> <p>To specify a VLAN series, enter a comma; for example, enter the <b>instance 1 vlan 10, 20, 30</b> command to map VLANs 10, 20, and 30 to MST instance 1.</p> |
| <b>Step 4</b> | switch(config-mst)# <b>name</b> <i>name</i>                                          | Specifies the instance name. The <i>name</i> string has a maximum length of 32 characters and is case sensitive.                                                                                                                                                                                                                                                                                                                                                                                                                                                                                                                                                                                                                                    |
| <b>Step 5</b> | switch(config-mst)# <b>revision</b> <i>version</i>                                   | Specifies the configuration revision number. The range is from 0 to 65535.                                                                                                                                                                                                                                                                                                                                                                                                                                                                                                                                                                                                                                                                          |

To return to defaults, do the following:

- To return to the default MST region configuration settings, enter the **no spanning-tree mst configuration** configuration command.
- To return to the default VLAN-to-instance map, enter the **no instance** *instance-id* **vlan** *vlan-range* MST configuration command.
- To return to the default name, enter the **no name** MST configuration command.
- To return to the default revision number, enter the **no revision** MST configuration command.

- To reenable Rapid PVST+, enter the **no spanning-tree mode** or the **spanning-tree mode rapid-pvst** global configuration command.

This example shows how to enter MST configuration mode, map VLANs 10 to 20 to MST instance 1, name the region region1, set the configuration revision to 1, display the pending configuration, apply the changes, and return to global configuration mode:

```
switch(config)# spanning-tree mst configuration
switch(config-mst)# instance 1 vlan 10-20
switch(config-mst)# name region1
switch(config-mst)# revision 1
switch(config-mst)# show pending
Pending MST configuration
Name      [region1]
Revision  1
Instances configured 2
Instance  Vlans Mapped
-----
0         1-9,21-4094
1         10-20
-----
```

## Mapping and Unmapping VLANs to MST Instances



### Caution

When you change the VLAN-to-MSTI mapping, the system restarts MST.



### Note

You cannot disable an MSTI.

For two or more bridges to be in the same MST region, they must have the identical MST name, VLAN-to-instance mapping, and MST revision number.

## SUMMARY STEPS

1. switch# **configure terminal**
2. switch(config)# **spanning-tree mst configuration**
3. switch(config-mst)# **instance** *instance-id* **vlan** *vlan-range*
4. switch(config-mst)# **no instance** *instance-id* **vlan** *vlan-range*

## DETAILED STEPS

|               | Command or Action                                                                    | Purpose                                                                                                                                            |
|---------------|--------------------------------------------------------------------------------------|----------------------------------------------------------------------------------------------------------------------------------------------------|
| <b>Step 1</b> | switch# <b>configure terminal</b>                                                    | Enters configuration mode.                                                                                                                         |
| <b>Step 2</b> | switch(config)# <b>spanning-tree mst configuration</b>                               | Enters MST configuration submenu.                                                                                                                  |
| <b>Step 3</b> | switch(config-mst)# <b>instance</b> <i>instance-id</i> <b>vlan</b> <i>vlan-range</i> | Maps VLANs to an MST instance, as follows: <ul style="list-style-type: none"> <li>• For <i>instance-id</i> the range is from 1 to 4094.</li> </ul> |

|               | Command or Action                                                                          | Purpose                                                                                                                                                                                                                                                                                                                                          |
|---------------|--------------------------------------------------------------------------------------------|--------------------------------------------------------------------------------------------------------------------------------------------------------------------------------------------------------------------------------------------------------------------------------------------------------------------------------------------------|
|               |                                                                                            | <p>Instance 0 is reserved for the IST for each MST region.</p> <ul style="list-style-type: none"> <li>For <i>vlan-range</i> the range is from 1 to 4094.</li> </ul> <p>When you map VLANs to an MSTI, the mapping is incremental, and the VLANs specified in the command are added to or removed from the VLANs that were previously mapped.</p> |
| <b>Step 4</b> | <code>switch(config-mst)# no instance <i>instance-id</i><br/>vlan <i>vlan-range</i></code> | Deletes the specified instance and returns the VLANs to the default MSTI, which is the CIST.                                                                                                                                                                                                                                                     |

This example shows how to map VLAN 200 to MSTI 3:

```
switch# configure terminal
switch(config)# spanning-tree mst configuration
switch(config-mst)# instance 3 vlan 200
```

## Mapping Secondary VLANs to Same MSTI as Primary VLANs for Private VLANs

When you are working with private VLANs on the system, all secondary VLANs must be in the same MSTI and their associated primary VLAN.

### SUMMARY STEPS

1. `switch# configure terminal`
2. `switch(config)# spanning-tree mst configuration`
3. `switch(config-mst)# private-vlan synchronize`

### DETAILED STEPS

|               | Command or Action                                            | Purpose                                                                                                          |
|---------------|--------------------------------------------------------------|------------------------------------------------------------------------------------------------------------------|
| <b>Step 1</b> | <code>switch# configure terminal</code>                      | Enters configuration mode.                                                                                       |
| <b>Step 2</b> | <code>switch(config)# spanning-tree mst configuration</code> | Enters MST configuration submode.                                                                                |
| <b>Step 3</b> | <code>switch(config-mst)# private-vlan synchronize</code>    | Automatically maps all secondary VLANs to the same MSTI and their associated primary VLAN for all private VLANs. |

This example shows how to automatically map all the secondary VLANs to the same MSTI as their associated primary VLANs in all private VLANs:

```
switch# configure terminal
switch(config)# spanning-tree mst configuration
switch(config-mst)# private-vlan synchronize
```

## Configuring the Root Bridge

You can configure the switch to become the root bridge.



### Note

The root bridge for each MSTI should be a backbone or distribution switch. Do not configure an access switch as the spanning tree primary root bridge.

Enter the `diameter` keyword, which is available only for MSTI 0 (or the IST), to specify the network diameter (that is, the maximum number of hops between any two end stations in the network). When you specify the network diameter, the switch automatically sets an optimal hello time, forward-delay time, and maximum-age time for a network of that diameter, which can significantly reduce the convergence time. You can enter the `hello` keyword to override the automatically calculated hello time.



### Note

With the switch configured as the root bridge, do not manually configure the hello time, forward-delay time, and maximum-age time using the `spanning-tree mst hello-time`, `spanning-tree mst forward-time`, and `spanning-tree mst max-age` global configuration commands.

## SUMMARY STEPS

1. `switch# configure terminal`
2. `switch(config)# spanning-tree mst instance-id root {primary | secondary} [diameter dia [hello-time hello-time]]`
3. (Optional) `switch(config)# no spanning-tree mst instance-id root`

## DETAILED STEPS

|               | Command or Action                                                                                                            | Purpose                                                                                                                                                                                                                                                                                                                                                                                                                                                                                                                                                                                                                                                                                  |
|---------------|------------------------------------------------------------------------------------------------------------------------------|------------------------------------------------------------------------------------------------------------------------------------------------------------------------------------------------------------------------------------------------------------------------------------------------------------------------------------------------------------------------------------------------------------------------------------------------------------------------------------------------------------------------------------------------------------------------------------------------------------------------------------------------------------------------------------------|
| <b>Step 1</b> | <code>switch# configure terminal</code>                                                                                      | Enters configuration mode.                                                                                                                                                                                                                                                                                                                                                                                                                                                                                                                                                                                                                                                               |
| <b>Step 2</b> | <code>switch(config)# spanning-tree mst instance-id root {primary   secondary} [diameter dia [hello-time hello-time]]</code> | Configures a switch as the root bridge as follows: <ul style="list-style-type: none"> <li>• For <i>instance-id</i>, you can specify a single instance, a range of instances separated by a hyphen, or a series of instances separated by a comma. The range is from 1 to 4094.</li> <li>• For diameter <i>net-diameter</i>, specify the maximum number of hops between any two end stations. The default is 7. This keyword is available only for MST instance 0.</li> <li>• For hello-time <i>seconds</i>, specify the interval in seconds between the generation of configuration messages by the root bridge. The range is from 1 to 10 seconds; the default is 2 seconds.</li> </ul> |

|        | Command or Action                                            | Purpose                                                                                |
|--------|--------------------------------------------------------------|----------------------------------------------------------------------------------------|
| Step 3 | switch(config)# <b>no spanning-tree mst instance-id root</b> | (Optional)<br>Returns the switch priority, diameter, and hello time to default values. |

This example shows how to configure the switch as the root switch for MSTI 5:

```
switch# configure terminal
switch(config)# spanning-tree mst 5 root primary
```

## Configuring a Secondary Root Bridge

You can execute this command on more than one switch to configure multiple backup root bridges. Enter the same network diameter and hello-time values that you used when you configured the primary root bridge with the **spanning-tree mst root primary** configuration command.

### SUMMARY STEPS

1. switch# **configure terminal**
2. switch(config)# **spanning-tree mst instance-id root {primary | secondary} [diameter dia [hello-time hello-time]]**
3. (Optional) switch(config)# **no spanning-tree mst instance-id root**

### DETAILED STEPS

|        | Command or Action                                                                                                      | Purpose                                                                                                                                                                                                                                                                                                                                                                                                                                                                                                                                                                                                                                                                                            |
|--------|------------------------------------------------------------------------------------------------------------------------|----------------------------------------------------------------------------------------------------------------------------------------------------------------------------------------------------------------------------------------------------------------------------------------------------------------------------------------------------------------------------------------------------------------------------------------------------------------------------------------------------------------------------------------------------------------------------------------------------------------------------------------------------------------------------------------------------|
| Step 1 | switch# <b>configure terminal</b>                                                                                      | Enters configuration mode.                                                                                                                                                                                                                                                                                                                                                                                                                                                                                                                                                                                                                                                                         |
| Step 2 | switch(config)# <b>spanning-tree mst instance-id root {primary   secondary} [diameter dia [hello-time hello-time]]</b> | Configures a switch as the secondary root bridge as follows: <ul style="list-style-type: none"> <li>• For <i>instance-id</i>, you can specify a single instance, a range of instances separated by a hyphen, or a series of instances separated by a comma. The range is from 1 to 4094.</li> <li>• For diameter <i>net-diameter</i>, specify the maximum number of hops between any two end stations. The default is 7. This keyword is available only for MST instance 0.</li> <li>• For hello-time <i>seconds</i>, specify the interval in seconds between the generation of configuration messages by the root bridge. The range is from 1 to 10 seconds; the default is 2 seconds.</li> </ul> |
| Step 3 | switch(config)# <b>no spanning-tree mst instance-id root</b>                                                           | (Optional)<br>Returns the switch priority, diameter, and hello-time to default values.                                                                                                                                                                                                                                                                                                                                                                                                                                                                                                                                                                                                             |

This example shows how to configure the switch as the secondary root switch for MSTI 5:

```
switch# configure terminal
switch(config)# spanning-tree mst 5 root secondary
```

## Configuring the Port Priority

If a loop occurs, MST uses the port priority when selecting an interface to put into the forwarding state. You can assign lower priority values to interfaces that you want selected first and higher priority values to the interface that you want selected last. If all interfaces have the same priority value, MST puts the interface with the lowest interface number in the forwarding state and blocks the other interfaces.

### SUMMARY STEPS

1. switch# **configure terminal**
2. switch(config)# **interface** *{{type slot/port}}* | **{port-channel number}}**
3. switch(config-if)# **spanning-tree mst instance-id port-priority priority**

### DETAILED STEPS

|               | Command or Action                                                                          | Purpose                                                                                                                                                                                                                                                                                                                                                                                                                                                                                                                          |
|---------------|--------------------------------------------------------------------------------------------|----------------------------------------------------------------------------------------------------------------------------------------------------------------------------------------------------------------------------------------------------------------------------------------------------------------------------------------------------------------------------------------------------------------------------------------------------------------------------------------------------------------------------------|
| <b>Step 1</b> | switch# <b>configure terminal</b>                                                          | Enters configuration mode.                                                                                                                                                                                                                                                                                                                                                                                                                                                                                                       |
| <b>Step 2</b> | switch(config)# <b>interface</b> <i>{{type slot/port}}</i>   <b>{port-channel number}}</b> | Specifies an interface to configure, and enters interface configuration mode.                                                                                                                                                                                                                                                                                                                                                                                                                                                    |
| <b>Step 3</b> | switch(config-if)# <b>spanning-tree mst instance-id port-priority priority</b>             | <p>Configures the port priority as follows:</p> <ul style="list-style-type: none"> <li>• For <i>instance-id</i>, you can specify a single MSTI, a range of MSTIs separated by a hyphen, or a series of MSTIs separated by a comma. The range is from 1 to 4094.</li> <li>• For <i>priority</i>, the range is 0 to 224 in increments of 32. The default is 128. A lower number indicates a higher priority.</li> </ul> <p>The priority values are 0, 32, 64, 96, 128, 160, 192, and 224. The system rejects all other values.</p> |

This example shows how to set the MST interface port priority for MSTI 3 on Ethernet port 3/1 to 64:

```
switch# configure terminal
switch(config)# interface ethernet 3/1
switch(config-if)# spanning-tree mst 3 port-priority 64
```

You can only apply this command to a physical Ethernet interface.

## Configuring the Port Cost

The MST path cost default value is derived from the media speed of an interface. If a loop occurs, MST uses the cost when selecting an interface to put in the forwarding state. You can assign lower cost values to interfaces that you want selected first and higher cost to interfaces values that you want selected last. If all interfaces have the same cost value, MST puts the interface with the lowest interface number in the forwarding state and blocks the other interfaces.



**Note** MST uses the long pathcost calculation method.

## SUMMARY STEPS

1. switch# **configure terminal**
2. switch(config)# **interface** *{{type slot/port} | {port-channel number}}*
3. switch(config-if)# **spanning-tree mst instance-id cost** [*cost* | **auto**]

## DETAILED STEPS

|               | Command or Action                                                                          | Purpose                                                                                                                                                                                                                                                                                                                                                                                                                                                                                                                                                                                                |
|---------------|--------------------------------------------------------------------------------------------|--------------------------------------------------------------------------------------------------------------------------------------------------------------------------------------------------------------------------------------------------------------------------------------------------------------------------------------------------------------------------------------------------------------------------------------------------------------------------------------------------------------------------------------------------------------------------------------------------------|
| <b>Step 1</b> | switch# <b>configure terminal</b>                                                          | Enters configuration mode.                                                                                                                                                                                                                                                                                                                                                                                                                                                                                                                                                                             |
| <b>Step 2</b> | switch(config)# <b>interface</b> <i>{{type slot/port}   {port-channel number}}</i>         | Specifies an interface to configure, and enters interface configuration mode.                                                                                                                                                                                                                                                                                                                                                                                                                                                                                                                          |
| <b>Step 3</b> | switch(config-if)# <b>spanning-tree mst instance-id cost</b> [ <i>cost</i>   <b>auto</b> ] | <p>Configures the cost.</p> <p>If a loop occurs, MST uses the path cost when selecting an interface to place into the forwarding state. A lower path cost represents higher-speed transmission as follows:</p> <ul style="list-style-type: none"> <li>• For <i>instance-id</i>, you can specify a single instance, a range of instances separated by a hyphen, or a series of instances separated by a comma. The range is from 1 to 4094.</li> <li>• For <i>cost</i>, the range is from 1 to 200000000. The default value is auto, which is derived from the media speed of the interface.</li> </ul> |

This example shows how to set the MST interface port cost on Ethernet 3/1 for MSTI 4:

```
switch# configure terminal
switch(config)# interface ethernet 3/1
switch(config-if)# spanning-tree mst 4 cost 17031970
```

## Configuring the Switch Priority

You can configure the switch priority for an MST instance so that it is more likely that the specified switch is chosen as the root bridge.



**Note** Exercise care when using this command. For most situations, we recommend that you enter the **spanning-tree mst root primary** and the **spanning-tree mst root secondary** global configuration commands to modify the switch priority.

## SUMMARY STEPS

1. switch# **configure terminal**
2. switch(config)# **spanning-tree mst *instance-id* priority *priority-value***

## DETAILED STEPS

|        | Command or Action                                                                          | Purpose                                                                                                                                                                                                                                                                                                                                                                                                                                                                                                                                                                                                                                                                |
|--------|--------------------------------------------------------------------------------------------|------------------------------------------------------------------------------------------------------------------------------------------------------------------------------------------------------------------------------------------------------------------------------------------------------------------------------------------------------------------------------------------------------------------------------------------------------------------------------------------------------------------------------------------------------------------------------------------------------------------------------------------------------------------------|
| Step 1 | switch# <b>configure terminal</b>                                                          | Enters configuration mode.                                                                                                                                                                                                                                                                                                                                                                                                                                                                                                                                                                                                                                             |
| Step 2 | switch(config)# <b>spanning-tree mst <i>instance-id</i> priority <i>priority-value</i></b> | <p>Configures a switch priority as follows:</p> <ul style="list-style-type: none"> <li>• For <i>instance-id</i>, you can specify a single instance, a range of instances separated by a hyphen, or a series of instances separated by a comma. The range is from 1 to 4094.</li> <li>• For <i>priority</i>, the range is from 0 to 61440 in increments of 4096; the default is 32768. A lower number indicates that the switch will most likely be chosen as the root bridge.</li> </ul> <p>Priority values are 0, 4096, 8192, 12288, 16384, 20480, 24576, 28672, 32768, 36864, 40960, 45056, 49152, 53248, 57344, and 61440. The system rejects all other values.</p> |

This example shows how to configure the priority of the bridge to 4096 for MSTI 5:

```
switch# configure terminal
switch(config)# spanning-tree mst 5 priority 4096
```

## Configuring the Hello Time

You can configure the interval between the generation of configuration messages by the root bridge for all instances on the switch by changing the hello time.

**Note**

Exercise care when using this command. For most situations, we recommend that you enter the **spanning-tree mst *instance-id* root primary** and the **spanning-tree mst *instance-id* root secondary** configuration commands to modify the hello time.

## SUMMARY STEPS

1. switch# **configure terminal**
2. switch(config)# **spanning-tree mst hello-time *seconds***

## DETAILED STEPS

|        | Command or Action                                           | Purpose                                                                                                                                                                                                                                                                          |
|--------|-------------------------------------------------------------|----------------------------------------------------------------------------------------------------------------------------------------------------------------------------------------------------------------------------------------------------------------------------------|
| Step 1 | switch# <b>configure terminal</b>                           | Enters configuration mode.                                                                                                                                                                                                                                                       |
| Step 2 | switch(config)# <b>spanning-tree mst hello-time seconds</b> | Configures the hello time for all MST instances. The hello time is the interval between the generation of configuration messages by the root bridge. These messages mean that the switch is alive. For <i>seconds</i> , the range is from 1 to 10, and the default is 2 seconds. |

This example shows how to configure the hello time of the switch to 1 second:

```
switch# configure terminal
switch(config)# spanning-tree mst hello-time 1
```

## Configuring the Forwarding-Delay Time

You can set the forward delay timer for all MST instances on the switch with one command.

## SUMMARY STEPS

1. switch# **configure terminal**
2. switch(config)# **spanning-tree mst forward-time seconds**

## DETAILED STEPS

|        | Command or Action                                             | Purpose                                                                                                                                                                                                                                                                                     |
|--------|---------------------------------------------------------------|---------------------------------------------------------------------------------------------------------------------------------------------------------------------------------------------------------------------------------------------------------------------------------------------|
| Step 1 | switch# <b>configure terminal</b>                             | Enters configuration mode.                                                                                                                                                                                                                                                                  |
| Step 2 | switch(config)# <b>spanning-tree mst forward-time seconds</b> | Configures the forward time for all MST instances. The forward delay is the number of seconds that a port waits before changing from its spanning tree blocking and learning states to the forwarding state. For <i>seconds</i> , the range is from 4 to 30, and the default is 15 seconds. |

This example shows how to configure the forward-delay time of the switch to 10 seconds:

```
switch# configure terminal
switch(config)# spanning-tree mst forward-time 10
```

## Configuring the Maximum-Aging Time

The maximum-aging timer is the number of seconds that a switch waits without receiving spanning tree configuration messages before attempting a reconfiguration.

You set the maximum-aging timer for all MST instances on the switch with one command (the maximum age time only applies to the IST).

**SUMMARY STEPS**

1. switch# **configure terminal**
2. switch(config)# **spanning-tree mst max-age** *seconds*

**DETAILED STEPS**

|               | Command or Action                                               | Purpose                                                                                                                                                                                                                                                                                                 |
|---------------|-----------------------------------------------------------------|---------------------------------------------------------------------------------------------------------------------------------------------------------------------------------------------------------------------------------------------------------------------------------------------------------|
| <b>Step 1</b> | switch# <b>configure terminal</b>                               | Enters configuration mode.                                                                                                                                                                                                                                                                              |
| <b>Step 2</b> | switch(config)# <b>spanning-tree mst max-age</b> <i>seconds</i> | Configures the maximum-aging time for all MST instances. The maximum-aging time is the number of seconds that a switch waits without receiving spanning tree configuration messages before attempting a reconfiguration. For <i>seconds</i> , the range is from 6 to 40, and the default is 20 seconds. |

This example shows how to configure the maximum-aging timer of the switch to 40 seconds:

```
switch# configure terminal
switch(config)# spanning-tree mst max-age 40
```

**Configuring the Maximum-Hop Count**

MST uses the path cost to the IST regional root and a hop-count mechanism similar to the IP time-to-live (TTL) mechanism. You configure the maximum hops inside the region and apply it to the IST and all MST instances in that region. The hop count achieves the same result as the message-age information (triggers a reconfiguration).

**SUMMARY STEPS**

1. switch# **configure terminal**
2. switch(config)# **spanning-tree mst max-hops** *hop-count*

**DETAILED STEPS**

|               | Command or Action                                                  | Purpose                                                                                                                                                                                                  |
|---------------|--------------------------------------------------------------------|----------------------------------------------------------------------------------------------------------------------------------------------------------------------------------------------------------|
| <b>Step 1</b> | switch# <b>configure terminal</b>                                  | Enters configuration mode.                                                                                                                                                                               |
| <b>Step 2</b> | switch(config)# <b>spanning-tree mst max-hops</b> <i>hop-count</i> | Specifies the number of hops in a region before the BPDU is discarded, and the information held for a port is aged. For <i>hop-count</i> , the range is from 1 to 255, and the default value is 20 hops. |

This example shows how to set the maximum hops to 40:

```
switch# configure terminal
switch(config)# spanning-tree mst max-hops 40
```

## Configuring PVST Simulation Globally

You can block this automatic feature either globally or per port. You can enter the global command, and change the PVST simulation setting for the entire switch while you are in interface command mode.

### SUMMARY STEPS

1. switch# **configure terminal**
2. switch(config)# **no spanning-tree mst simulate pvst global**

### DETAILED STEPS

|        | Command or Action                                                | Purpose                                                                                                                                                                                                                                                               |
|--------|------------------------------------------------------------------|-----------------------------------------------------------------------------------------------------------------------------------------------------------------------------------------------------------------------------------------------------------------------|
| Step 1 | switch# <b>configure terminal</b>                                | Enters configuration mode.                                                                                                                                                                                                                                            |
| Step 2 | switch(config)# <b>no spanning-tree mst simulate pvst global</b> | Disables all interfaces on the switch from automatically interoperating with connected switch that is running in Rapid PVST+ mode. The default for this is enabled; that is, by default, all interfaces on the switch operate seamlessly between Rapid PVST+ and MST. |

This example shows how to prevent the switch from automatically interoperating with a connecting switch that is running Rapid PVST+:

```
switch# configure terminal
switch(config)# no spanning-tree mst simulate pvst global
```

## Configuring PVST Simulation Per Port

MST interoperates seamlessly with Rapid PVST+. However, to prevent an accidental connection to a switch that does not run MST as the default STP mode, you may want to disable this automatic feature. If you disable PVST simulation, the MST-enabled port moves to the blocking state once it detects it is connected to a Rapid PVST+-enabled port. This port remains in the inconsistent state until the port stops receiving BPDUs, and then the port resumes the normal STP transition process.

You can block this automatic feature either globally or per port.

### SUMMARY STEPS

1. switch# **configure terminal**
2. switch(config)# **interface** *{{type slot/port} | {port-channel number}}*
3. switch(config-if)# **spanning-tree mst simulate pvst disable**
4. switch(config-if)# **spanning-tree mst simulate pvst**
5. switch(config-if)# **no spanning-tree mst simulate pvst**

## DETAILED STEPS

|               | Command or Action                                                                 | Purpose                                                                                                                                                                                                                    |
|---------------|-----------------------------------------------------------------------------------|----------------------------------------------------------------------------------------------------------------------------------------------------------------------------------------------------------------------------|
| <b>Step 1</b> | <code>switch# configure terminal</code>                                           | Enters configuration mode.                                                                                                                                                                                                 |
| <b>Step 2</b> | <code>switch(config)# interface {{type slot/port}   {port-channel number}}</code> | Specifies an interface to configure, and enters interface configuration mode.                                                                                                                                              |
| <b>Step 3</b> | <code>switch(config-if)# spanning-tree mst simulate pvst disable</code>           | Disables specified interfaces from automatically interoperating with connected switch that is running in Rapid PVST+ mode.<br><br>By default, all interfaces on the switch operate seamlessly between Rapid PVST+ and MST. |
| <b>Step 4</b> | <code>switch(config-if)# spanning-tree mst simulate pvst</code>                   | Re-enables seamless operation between MST and Rapid PVST+ on specified interfaces.                                                                                                                                         |
| <b>Step 5</b> | <code>switch(config-if)# no spanning-tree mst simulate pvst</code>                | Sets the interface to the switch-wide MST and Rapid PVST+ interoperation that you configured using the <b>spanning-tree mst simulate pvst global</b> command.                                                              |

This example shows how to prevent the specified interfaces from automatically interoperating with a connecting switch that is not running MST:

```
switch# configure terminal
switch(config)# interface ethernet 1/4
switch(config-if)# spanning-tree mst simulate pvst disable
```

## Specifying the Link Type

Rapid connectivity (802.1w standard) is established only on point-to-point links. By default, the link type is controlled from the duplex mode of the interface. A full-duplex port is considered to have a point-to-point connection; a half-duplex port is considered to have a shared connection.

If you have a half-duplex link physically connected point-to-point to a single port on a remote switch, you can override the default setting on the link type and enable rapid transitions.

If you set the link to shared, STP reverts to 802.1D.

## SUMMARY STEPS

1. `switch# configure terminal`
2. `switch(config)# interface type slot/port`
3. `switch(config-if)# spanning-tree link-type {auto | point-to-point | shared}`

## DETAILED STEPS

|        | Command or Action                                                                                         | Purpose                                                                                                                                                                                                                                                                                                                                                  |
|--------|-----------------------------------------------------------------------------------------------------------|----------------------------------------------------------------------------------------------------------------------------------------------------------------------------------------------------------------------------------------------------------------------------------------------------------------------------------------------------------|
| Step 1 | switch# <b>configure terminal</b>                                                                         | Enters configuration mode.                                                                                                                                                                                                                                                                                                                               |
| Step 2 | switch(config)# <b>interface</b> <i>type slot/port</i>                                                    | Specifies the interface to configure, and enters interface configuration mode.                                                                                                                                                                                                                                                                           |
| Step 3 | switch(config-if)# <b>spanning-tree link-type</b> { <b>auto</b>   <b>point-to-point</b>   <b>shared</b> } | Configures the link type to be either point to point or shared. The system reads the default value from the switch connection. Half-duplex links are shared and full-duplex links are point to point. If the link type is shared, the STP reverts to 802.1D. The default is auto, which sets the link type based on the duplex setting of the interface. |

This example shows how to configure the link type as point to point:

```
switch# configure terminal
switch (config)# interface ethernet 1/4
switch(config-if)# spanning-tree link-type point-to-point
```

## Restarting the Protocol

An MST bridge can detect that a port is at the boundary of a region when it receives a legacy BPDU or an MST BPDU that is associated with a different region. However, the STP protocol migration cannot determine whether the legacy switch, which is a switch that runs only IEEE 802.1D, has been removed from the link unless the legacy switch is the designated switch. Enter this command to restart the protocol negotiation (force the renegotiation with neighboring switches) on the entire switch or on specified interfaces.

### SUMMARY STEPS

1. switch# **clear spanning-tree detected-protocol** [**interface** *interface* [*interface-num* | *port-channel*]]

### DETAILED STEPS

|        | Command or Action                                                                                                                        | Purpose                                                |
|--------|------------------------------------------------------------------------------------------------------------------------------------------|--------------------------------------------------------|
| Step 1 | switch# <b>clear spanning-tree detected-protocol</b> [ <b>interface</b> <i>interface</i> [ <i>interface-num</i>   <i>port-channel</i> ]] | Restarts MST on entire switch or specified interfaces. |

This example shows how to restart MST on the Ethernet interface on slot 2, port 8:

```
switch# clear spanning-tree detected-protocol interface ethernet 2/8
```

## Verifying MST Configurations

To display MST configuration information, perform one of the following tasks:

| Command                                                | Purpose                                                          |
|--------------------------------------------------------|------------------------------------------------------------------|
| switch# <b>show running-config spanning-tree [all]</b> | Displays the current spanning tree configuration.                |
| switch# <b>show spanning-tree mst [options]</b>        | Displays detailed information for the current MST configuration. |

The following example shows how to display current MST configuration:

```
switch# show spanning-tree mst configuration
% Switch is not in mst mode
Name      [mist-attempt]
Revision  1      Instances configured 2
Instance  Vlans mapped
-----
0         1-12,14-41,43-4094
1         13,42
```



# CHAPTER 11

## Configuring STP Extensions

This chapter describes the configuration of extensions to the Spanning Tree Protocol (STP) on Cisco Nexus 5000 Series switches. It includes the following sections:

- [About STP Extensions, page 161](#)

### About STP Extensions

Cisco has added extensions to STP that make convergence more efficient. In some cases, even though similar functionality may be incorporated into the IEEE 802.1w Rapid Spanning Tree Protocol (RSTP) standard, we recommend using these extensions. All of these extensions can be used with both RPVST+ and MST.

The available extensions are spanning tree port types, Bridge Assurance, BPDU Guard, BPDU Filtering, Loop Guard, and Root Guard. Many of these features can be applied either globally or on specified interfaces.



**Note**

Spanning tree is used to refer to IEEE 802.1w and IEEE 802.1s. If the text is discussing the IEEE 802.1D Spanning Tree Protocol, 802.1D is stated specifically.

### Information About STP Extensions

#### Understanding STP Port Types

You can configure a spanning tree port as an edge port, a network port, or a normal port. A port can be in only one of these states at a given time. The default spanning tree port type is normal. Depending on the type of device to which the interface is connected, you can configure a spanning tree port as one of these port types.

#### Spanning Tree Edge Ports

Edge ports, which are connected to hosts, can be either an access port or a trunk port. The edge port interface immediately transitions to the forwarding state, without moving through the blocking or learning states. (This immediate transition was previously configured as the Cisco-proprietary feature PortFast.)

Interfaces that are connected to hosts should not receive STP Bridge Protocol Data Units (BPDUs).

**Note**

---

If you configure a port connected to another switch as an edge port, you might create a bridging loop.

---

## Spanning Tree Network Ports

Network ports are connected only to switches or bridges. Configuring a port as "network" while Bridge Assurance is enabled globally, enables Bridge Assurance on that port.

**Note**

---

If you mistakenly configure ports that are connected to hosts or other edge devices, as spanning tree network ports, those ports will automatically move into the blocking state.

---

## Spanning Tree Normal Ports

Normal ports can be connected to either hosts, switches, or bridges. These ports function as normal spanning tree ports.

The default spanning tree interface is a normal port.

## Understanding Bridge Assurance

You can use Bridge Assurance to protect against certain problems that can cause bridging loops in the network. Specifically, you use Bridge Assurance to protect against a unidirectional link failure and a device that continues to forward data traffic when it is no longer running the spanning tree algorithm.

**Note**

---

Bridge Assurance is supported only by Rapid PVST+ and MST. Legacy 802.1D spanning tree does not support Bridge Assurance.

---

Bridge Assurance is enabled by default and can only be disabled globally. Also, Bridge Assurance can be enabled only on spanning tree network ports that are point-to-point links. Finally, both ends of the link must have Bridge Assurance enabled.

With Bridge Assurance enabled, BPDUs are sent out on all operational network ports, including alternate and backup ports, for each hello time period. If the port does not receive a BPDU for a specified period, the port moves into the blocking state and is not used in the root port calculation. Once that port receives a BPDU, it resumes the normal spanning tree transitions.

## Understanding BPDU Guard

Enabling BPDU Guard shuts down that interface if a BPDU is received.

You can configure BPDU Guard at the interface level. When configured at the interface level, BPDU Guard shuts the port down as soon as the port receives a BPDU, regardless of the port type configuration.

When you configure BPDU Guard globally, it is effective only on operational spanning tree edge ports. In a valid configuration, LAN edge interfaces do not receive BPDUs. A BPDU that is received by an edge LAN interface signals an invalid configuration, such as the connection of an unauthorized host or switch. BPDU Guard, when enabled globally, shuts down all spanning tree edge ports when they receive a BPDU.

BPDU Guard provides a secure response to invalid configurations, because you must manually put the LAN interface back in service after an invalid configuration.



**Note** When enabled globally, BPDU Guard applies to all operational spanning tree edge interfaces.

## Understanding BPDU Filtering

You can use BPDU Filtering to prevent the switch from sending or even receiving BPDUs on specified ports.

When configured globally, BPDU Filtering applies to all operational spanning tree edge ports. You should connect edge ports only to hosts, which typically drop BPDUs. If an operational spanning tree edge port receives a BPDU, it immediately returns to a normal spanning tree port type and moves through the regular transitions. In that case, BPDU Filtering is disabled on this port, and spanning tree resumes sending BPDUs on this port.

In addition, you can configure BPDU Filtering by the individual interface. When you explicitly configure BPDU Filtering on a port, that port does not send any BPDUs and drops all BPDUs that it receives. You can effectively override the global BPDU Filtering setting on individual ports by configuring the specific interface. This BPDU Filtering command on the interface applies to the entire interface, whether the interface is trunking or not.



**Caution** Use care when configuring BPDU Filtering per interface. If you explicitly configuring BPDU Filtering on a port that is not connected to a host, it can result in bridging loops because the port will ignore any BPDU that it receives and go to forwarding.

If the port configuration is not set to default BPDU Filtering, then the edge configuration will not affect BPDU Filtering. The following table lists all the BPDU Filtering combinations.

**Table 16: BPDU Filtering Configurations**

| BPDU Filtering Per Port Configuration | BPDU Filtering Global Configuration | STP Edge Port Configuration | BPDU Filtering State                                                                                                                                                     |
|---------------------------------------|-------------------------------------|-----------------------------|--------------------------------------------------------------------------------------------------------------------------------------------------------------------------|
| Default                               | Enable                              | Enable                      | Enable<br>The port transmits at least 10 BPDUs. If this port receives any BPDUs, the port returns to the spanning tree normal port state and BPDU Filtering is disabled. |
| Default                               | Enable                              | Disable                     | Disable                                                                                                                                                                  |
| Default                               | Disable                             | Enabled/Disabled            | Disable                                                                                                                                                                  |
| Disable                               | Enabled/Disabled                    | Enabled/Disabled            | Disable                                                                                                                                                                  |

| BPDU Filtering Per Port Configuration | BPDU Filtering Global Configuration | STP Edge Port Configuration | BPDU Filtering State                                                                                                            |
|---------------------------------------|-------------------------------------|-----------------------------|---------------------------------------------------------------------------------------------------------------------------------|
| Enable                                | Enabled/Disabled                    | Enabled/Disabled            | Enable<br><b>Caution</b> BPDUs are never sent and if received, they do not trigger the regular STP behavior - use with caution. |

## Understanding Loop Guard

Loop Guard protects networks from loops that are caused by the following:

- Network interfaces that malfunction
- Busy CPUs
- Anything that prevents the normal forwarding of BPDUs

An STP loop occurs when a blocking port in a redundant topology erroneously transitions to the forwarding state. This transition usually happens because one of the ports in a physically redundant topology (not necessarily the blocking port) stops receiving BPDUs.

Loop Guard is only useful in switched networks where devices are connected by point-to-point links. On a point-to-point link, a designated bridge cannot disappear unless it sends an inferior BPDU or brings the link down.



### Note

Loop Guard can be enabled only on network and normal spanning tree port types.

You can use Loop Guard to determine if a root port or an alternate/backup root port receives BPDUs. If the port does not receive BPDUs, Loop Guard puts the port into an inconsistent state (blocking) until the port starts to receive BPDUs again. A port in the inconsistent state does not transmit BPDUs. If the port receives BPDUs again, the protocol removes its loop-inconsistent condition, and the STP determines the port state because such recovery is automatic.

Loop Guard isolates the failure and allows STP to converge to a stable topology without the failed link or bridge. Disabling Loop Guard moves all loop-inconsistent ports to the listening state.

You can enable Loop Guard on a per-port basis. When you enable Loop Guard on a port, it is automatically applied to all of the active instances or VLANs to which that port belongs. When you disable Loop Guard, it is disabled for the specified ports.

## Understanding Root Guard

When you enable Root Guard on a port, Root Guard does not allow that port to become a root port. If a received BPDU triggers an STP convergence that makes that designated port become a root port, that port is put into a root-inconsistent (blocked) state. After the port stops send superior BPDUs, the port is unblocked again. Through STP, the port moves to the forwarding state. Recovery is automatic.

Root Guard enabled on an interface applies this functionality to all VLANs to which that interface belongs.

You can use Root Guard to enforce the root bridge placement in the network. Root Guard ensures that the port on which Root Guard is enabled is the designated port. Normally, root bridge ports are all designated ports, unless two or more of the ports of the root bridge are connected. If the bridge receives superior BPDUs on a Root Guard-enabled port, the bridge moves this port to a root-inconsistent STP state. In this way, Root Guard enforces the position of the root bridge.

You cannot configure Root Guard globally.

**Note**

---

You can enable Root Guard on all spanning tree port types: normal, edge, and network ports.

---

## Configuring STP Extensions

### STP Extensions Configuration Guidelines

When configuring STP extensions, follow these guidelines:

- Configure all access and trunk ports connected to hosts as edge ports.
- Bridge Assurance runs only on point-to-point spanning tree network ports. You must configure each side of the link for this feature.
- Loop Guard does not run on spanning tree edge ports.
- Enabling Loop Guard on ports that are not connected to a point-to-point link will not work.
- You cannot enable Loop Guard if Root Guard is enabled.

### Configuring Spanning Tree Port Types Globally

The spanning tree port type designation depends on the type of device the port is connected to, as follows:

- Edge—Edge ports are connected to hosts and can be either an access port or a trunk port.
- Network—Network ports are connected only to switches or bridges.
- Normal—Normal ports are neither edge ports nor network ports; they are normal spanning tree ports. These ports can be connected to any type of device.

You can configure the port type either globally or per interface. By default, the spanning tree port type is normal.

#### Before You Begin

Ensure that STP is configured.

Ensure that you are configuring the ports correctly for the type of device to which the interface is connected.

**SUMMARY STEPS**

1. switch# **configure terminal**
2. switch(config)# **spanning-tree port type edge default**
3. switch(config)# **spanning-tree port type network default**

**DETAILED STEPS**

|               | Command or Action                                              | Purpose                                                                                                                                                                                                                                                                                                                                                                                            |
|---------------|----------------------------------------------------------------|----------------------------------------------------------------------------------------------------------------------------------------------------------------------------------------------------------------------------------------------------------------------------------------------------------------------------------------------------------------------------------------------------|
| <b>Step 1</b> | switch# <b>configure terminal</b>                              | Enters configuration mode.                                                                                                                                                                                                                                                                                                                                                                         |
| <b>Step 2</b> | switch(config)# <b>spanning-tree port type edge default</b>    | Configures all interfaces as edge ports. This assumes all ports are connected to hosts/servers. Edge ports immediately transition to the forwarding state without passing through the blocking or learning state at linkup. By default, spanning tree ports are normal port types.                                                                                                                 |
| <b>Step 3</b> | switch(config)# <b>spanning-tree port type network default</b> | Configures all interfaces as spanning tree network ports. This assumes all ports are connected to switches and bridges. If you enable Bridge Assurance, it automatically runs on network ports. By default, spanning tree ports are normal port types.<br><br><b>Note</b> If you configure interfaces connected to hosts as network ports, those ports automatically move into the blocking state. |

This example shows how to configure all access and trunk ports connected to hosts as spanning tree edge ports:

```
switch# configure terminal
switch(config)# spanning-tree port type edge default
```

This example shows how to configure all ports connected to switches or bridges as spanning tree network ports:

```
switch# configure terminal
switch(config)# spanning-tree port type network default
```

**Configuring Spanning Tree Edge Ports on Specified Interfaces**

You can configure spanning tree edge ports on specified interfaces. Interfaces configured as spanning tree edge ports immediately transition to the forwarding state, without passing through the blocking or learning states, on linkup.

This command has four states:

- **spanning-tree port type edge**—This command explicitly enables edge behavior on the access port.
- **spanning-tree port type edge trunk**—This command explicitly enables edge behavior on the trunk port.



**Note** If you enter the **spanning-tree port type edge trunk** command, the port is configured as an edge port even in the access mode.

- **spanning-tree port type normal**—This command explicitly configures the port as a normal spanning tree port and the immediate transition to the forwarding state is not enabled.
- **no spanning-tree port type**—This command implicitly enables edge behavior if you define the **spanning-tree port type edge default** command in global configuration mode. If you do not configure the edge ports globally, the **no spanning-tree port type** command is equivalent to the **spanning-tree port type disable** command.

### Before You Begin

Ensure that STP is configured.

Ensure that the interface is connected to hosts.

### SUMMARY STEPS

1. switch# **configure terminal**
2. switch(config)# **interface** *type slot/port*
3. switch(config-if)# **spanning-tree port type edge**

### DETAILED STEPS

|               | Command or Action                                      | Purpose                                                                                                                                                                                                                                                  |
|---------------|--------------------------------------------------------|----------------------------------------------------------------------------------------------------------------------------------------------------------------------------------------------------------------------------------------------------------|
| <b>Step 1</b> | switch# <b>configure terminal</b>                      | Enters configuration mode.                                                                                                                                                                                                                               |
| <b>Step 2</b> | switch(config)# <b>interface</b> <i>type slot/port</i> | Specifies the interface to configure, and enters the interface configuration mode.                                                                                                                                                                       |
| <b>Step 3</b> | switch(config-if)# <b>spanning-tree port type edge</b> | Configures the specified access interfaces to be spanning edge ports. Edge ports immediately transition to the forwarding state without passing through the blocking or learning state at linkup. By default, spanning tree ports are normal port types. |

This example shows how to configure the Ethernet access interface 1/4 to be a spanning tree edge port:

```
switch# configure terminal
switch(config)# interface ethernet 1/4
switch(config-if)# spanning-tree port type edge
```

## Configuring Spanning Tree Network Ports on Specified Interfaces

You can configure spanning tree network ports on specified interfaces.

Bridge Assurance runs only on spanning tree network ports.

This command has three states:

- **spanning-tree port type network**—This command explicitly configures the port as a network port. If you enable Bridge Assurance globally, it automatically runs on a spanning tree network port.
- **spanning-tree port type normal**—This command explicitly configures the port as a normal spanning tree port and Bridge Assurance cannot run on this interface.
- **no spanning-tree port type**—This command implicitly enables the port as a spanning tree network port if you define the **spanning-tree port type network default** command in global configuration mode. If you enable Bridge Assurance globally, it automatically runs on this port.



**Note** A port connected to a host that is configured as a network port automatically moves into the blocking state.

### Before You Begin

Ensure that STP is configured.

Ensure that the interface is connected to switches or routers.

## SUMMARY STEPS

1. switch# **configure terminal**
2. switch(config)# **interface** type slot/port
3. switch(config-if)# **spanning-tree port type network**

## DETAILED STEPS

|               | Command or Action                                         | Purpose                                                                                                                                                                                          |
|---------------|-----------------------------------------------------------|--------------------------------------------------------------------------------------------------------------------------------------------------------------------------------------------------|
| <b>Step 1</b> | switch# <b>configure terminal</b>                         | Enters configuration mode.                                                                                                                                                                       |
| <b>Step 2</b> | switch(config)# <b>interface</b> type slot/port           | Specifies the interface to configure, and enters the interface configuration mode. The interface can be a physical Ethernet port.                                                                |
| <b>Step 3</b> | switch(config-if)# <b>spanning-tree port type network</b> | Configures the specified interfaces to be spanning network ports. If you enable Bridge Assurance, it automatically runs on network ports. By default, spanning tree ports are normal port types. |

This example shows how to configure the Ethernet interface 1/4 to be a spanning tree network port:

```
switch# configure terminal
switch(config)# interface ethernet 1/4
switch(config-if)# spanning-tree port type network
```

## Enabling BPDU Guard Globally

You can enable BPDU Guard globally by default. In this condition, the system shuts down an edge port that receives a BPDU.



**Note** We recommend that you enable BPDU Guard on all edge ports.

### Before You Begin

Ensure that STP is configured.

Ensure that you have configured some spanning tree edge ports.

## SUMMARY STEPS

1. switch# **configure terminal**
2. switch(config)# **spanning-tree port type edge bpduguard default**

## DETAILED STEPS

|               | Command or Action                                                     | Purpose                                                                                                   |
|---------------|-----------------------------------------------------------------------|-----------------------------------------------------------------------------------------------------------|
| <b>Step 1</b> | switch# <b>configure terminal</b>                                     | Enters configuration mode.                                                                                |
| <b>Step 2</b> | switch(config)# <b>spanning-tree port type edge bpduguard default</b> | Enables BPDU Guard by default on all spanning tree edge ports. By default, global BPDU Guard is disabled. |

This example shows how to enable BPDU Guard on all spanning tree edge ports:

```
switch# configure terminal
switch(config)# spanning-tree port type edge bpduguard default
```

## Enabling BPDU Guard on Specified Interfaces

You can enable BPDU Guard on specified interfaces. Enabling BPDU Guard shuts down the port if it receives a BPDU.

You can configure BPDU Guard on specified interfaces as follows:

- **spanning-tree bpduguard enable**—Unconditionally enables BPDU Guard on the interface.
- **spanning-tree bpduguard disable**—Unconditionally disables BPDU Guard on the interface.
- **no spanning-tree bpduguard**—Enables BPDU Guard on the interface if it is an operational edge port and if the **spanning-tree port type edge bpduguard default** command is configured.

### Before You Begin

Ensure that STP is configured.

## SUMMARY STEPS

1. switch# **configure terminal**
2. switch(config)# **interface** *type slot/port*
3. switch(config-if)# **spanning-tree bpduguard** {enable | disable}
4. (Optional) switch(config-if)# **no spanning-tree bpduguard**

## DETAILED STEPS

|        | Command or Action                                                    | Purpose                                                                                                                                                                                                                      |
|--------|----------------------------------------------------------------------|------------------------------------------------------------------------------------------------------------------------------------------------------------------------------------------------------------------------------|
| Step 1 | switch# <b>configure terminal</b>                                    | Enters configuration mode.                                                                                                                                                                                                   |
| Step 2 | switch(config)# <b>interface</b> <i>type slot/port</i>               | Specifies the interface to configure, and enters the interface configuration mode.                                                                                                                                           |
| Step 3 | switch(config-if)# <b>spanning-tree bpduguard</b> {enable   disable} | Enables or disables BPDU Guard for the specified spanning tree edge interface. By default, BPDU Guard is disabled on physical Ethernet interfaces.                                                                           |
| Step 4 | switch(config-if)# <b>no spanning-tree bpduguard</b>                 | (Optional)<br>Disables BPDU Guard on the interface.<br><b>Note</b> Enables BPDU Guard on the interface if it is an operational edge port and if you enter the <b>spanning-tree port type edge bpduguard default</b> command. |

This example shows how to explicitly enable BPDU Guard on the Ethernet edge port 1/4:

```
switch# configure terminal
switch (config)# interface ethernet 1/4
switch(config-if)# spanning-tree bpduguard enable
```

```
switch(config-if)# no spanning-tree bpduguard
```

## Enabling BPDU Filtering Globally

You can enable BPDU Filtering globally by default on spanning tree edge ports.

If an edge port with BPDU Filtering enabled receives a BPDU, it loses its operation status and as edge port and resumes the regular STP transitions. However, this port maintains its configuration as an edge port.

**Caution**

Be careful when using this command: using it incorrectly can cause bridging loops.

**Note**

When enabled globally, BPDU Filtering is applied *only* on ports that are operational edge ports. Ports send a few BPDUs at linkup before they effectively filter outbound BPDUs. If a BPDU is received on an edge port, it immediately loses its operational edge port status and BPDU Filtering is disabled.

**Before You Begin**

Ensure that STP is configured.

Ensure that you have configured some spanning tree edge ports.

**SUMMARY STEPS**

1. switch# **configure terminal**
2. switch(config)# **spanning-tree port type edge bpdufilter default**

**DETAILED STEPS**

|               | Command or Action                                                      | Purpose                                                                                                                      |
|---------------|------------------------------------------------------------------------|------------------------------------------------------------------------------------------------------------------------------|
| <b>Step 1</b> | switch# <b>configure terminal</b>                                      | Enters configuration mode.                                                                                                   |
| <b>Step 2</b> | switch(config)# <b>spanning-tree port type edge bpdufilter default</b> | Enables BPDU Filtering by default on all operational spanning tree edge ports. Global BPDU Filtering is disabled by default. |

This example shows how to enable BPDU Filtering on all operational spanning tree edge ports:

```
switch# configure terminal
switch(config)# spanning-tree port type edge bpdufilter default
```

**Enabling BPDU Filtering on Specified Interfaces**

You can apply BPDU Filtering to specified interfaces. When enabled on an interface, that interface does not send any BPDUs and drops all BPDUs that it receives. This BPDU Filtering functionality applies to the entire interface, whether trunking or not.

**Caution**

Be careful when you enter the **spanning-tree bpdufilter enable** command on specified interfaces. Explicitly configuring BPDU Filtering on a port that is not connected to a host can result in bridging loops as the port will ignore any BPDU it receives and go to forwarding.

You can enter this command to override the port configuration on specified interfaces.

This command has three states:

- **spanning-tree bpdufilter enable**—Unconditionally enables BPDU Filtering on the interface.
- **spanning-tree bpdufilter disable**—Unconditionally disables BPDU Filtering on the interface.
- **no spanning-tree bpdufilter**—Enables BPDU Filtering on the interface if the interface is in operational edge port and if you configure the **spanning-tree port type edge bpdufilter default** command.

**Note**

When you enable BPDU Filtering locally on a port, this feature prevents the device from receiving or sending BPDUs on this port.

**Before You Begin**

Ensure that STP is configured.

**SUMMARY STEPS**

1. switch# **configure terminal**
2. switch(config)# **interface** *type slot/port*
3. switch(config-if)# **spanning-tree bpdudfilter** {enable | disable}
4. (Optional) switch(config-if)# **no spanning-tree bpdudfilter**

**DETAILED STEPS**

|               | Command or Action                                                      | Purpose                                                                                                                                                                                                                                                  |
|---------------|------------------------------------------------------------------------|----------------------------------------------------------------------------------------------------------------------------------------------------------------------------------------------------------------------------------------------------------|
| <b>Step 1</b> | switch# <b>configure terminal</b>                                      | Enters configuration mode.                                                                                                                                                                                                                               |
| <b>Step 2</b> | switch(config)# <b>interface</b> <i>type slot/port</i>                 | Specifies the interface to configure, and enters the interface configuration mode.                                                                                                                                                                       |
| <b>Step 3</b> | switch(config-if)# <b>spanning-tree bpdudfilter</b> {enable   disable} | Enables or disables BPDU Filtering for the specified spanning tree edge interface. By default, BPDU Filtering is disabled.                                                                                                                               |
| <b>Step 4</b> | switch(config-if)# <b>no spanning-tree bpdudfilter</b>                 | (Optional)<br>Disables BPDU Filtering on the interface.<br><b>Note</b> Enables BPDU Filtering on the interface if the interface is an operational spanning tree edge port and if you enter the spanning-tree port type edge bpdudfilter default command. |

This example shows how to explicitly enable BPDU Filtering on the Ethernet spanning tree edge port 1/4:

```
switch# configure terminal
switch (config)# interface ethernet 1/4
switch(config-if)# spanning-tree bpdudfilter enable
```

**Enabling Loop Guard Globally**

You can enable Loop Guard globally by default on all point-to-point spanning tree normal and network ports. Loop Guard does not run on edge ports.

Loop Guard provides additional security in the bridge network. Loop Guard prevents alternate or root ports from becoming the designated port because of a failure that could lead to a unidirectional link.



**Note** Entering the Loop Guard command for the specified interface overrides the global Loop Guard command.

**Before You Begin**

Ensure that STP is configured.

Ensure that you have spanning tree normal ports or have configured some network ports.

**SUMMARY STEPS**

1. switch# **configure terminal**
2. switch(config)# **spanning-tree loopguard default**

**DETAILED STEPS**

|               | Command or Action                                      | Purpose                                                                                                                 |
|---------------|--------------------------------------------------------|-------------------------------------------------------------------------------------------------------------------------|
| <b>Step 1</b> | switch# <b>configure terminal</b>                      | Enters configuration mode.                                                                                              |
| <b>Step 2</b> | switch(config)# <b>spanning-tree loopguard default</b> | Enables Loop Guard by default on all spanning tree normal and network ports. By default, global Loop Guard is disabled. |

This example shows how to enable Loop Guard on all spanning tree normal or network ports:

```
switch# configure terminal
switch(config)# spanning-tree loopguard default
```

**Enabling Loop Guard or Root Guard on Specified Interfaces**

You can enable either Loop Guard or Root Guard on specified interfaces.

Enabling Root Guard on a port means that port cannot become a root port, and LoopGuard prevents alternate or root ports from becoming the designated port because of a failure that could lead to a unidirectional link.

Both Loop Guard and Root Guard enabled on an interface apply to all VLANs to which that interface belongs.

**Note**

Entering the Loop Guard command for the specified interface overrides the global Loop Guard command.

**Before You Begin**

Ensure that STP is configured.

Ensure that you are configuring Loop Guard on spanning tree normal or network ports.

**SUMMARY STEPS**

1. switch# **configure terminal**
2. switch(config)# **interface type slot/port**
3. switch(config-if)# **spanning-tree guard {loop | root | none}**

**DETAILED STEPS**

|               | Command or Action                 | Purpose                    |
|---------------|-----------------------------------|----------------------------|
| <b>Step 1</b> | switch# <b>configure terminal</b> | Enters configuration mode. |

|               | Command or Action                                                                            | Purpose                                                                                                                                                                                                                                                                     |
|---------------|----------------------------------------------------------------------------------------------|-----------------------------------------------------------------------------------------------------------------------------------------------------------------------------------------------------------------------------------------------------------------------------|
| <b>Step 2</b> | switch(config)# <b>interface</b> <i>type slot/port</i>                                       | Specifies the interface to configure, and enters the interface configuration mode.                                                                                                                                                                                          |
| <b>Step 3</b> | switch(config-if)# <b>spanning-tree guard</b><br>{ <b>loop</b>   <b>root</b>   <b>none</b> } | Enables or disables either Loop Guard or Root Guard for the specified interface. By default, Root Guard is disabled by default, and Loop Guard on specified ports is also disabled.<br><br><b>Note</b> Loop Guard runs only on spanning tree normal and network interfaces. |

This example shows how to enable Root Guard on Ethernet port 1/4:

```
switch# configure terminal
switch (config)# interface ethernet 1/4
switch (config-if)# spanning-tree guard root
```

## Verifying STP Extension Configuration

To display the configuration information for the STP extensions, perform one of the following tasks:

| Command                                                         | Purpose                                                                             |
|-----------------------------------------------------------------|-------------------------------------------------------------------------------------|
| switch# <b>show running-config spanning-tree</b> [ <b>all</b> ] | Displays the current status of spanning tree on the switch                          |
| switch# <b>show spanning-tree</b> [ <i>options</i> ]            | Displays selected detailed information for the current spanning tree configuration. |



# CHAPTER 12

## Configuring LLDP

This chapter describes the LLDP feature on the Cisco Nexus 5000 Series switches. It includes the following sections:

- [Configuring Global LLDP Commands, page 175](#)
- [Configuring Interface LLDP Commands, page 176](#)

### Configuring Global LLDP Commands

You can set global LLDP settings. These settings include the length of time before discarding LLDP information received from peers, the length of time to wait before performing LLDP initialization on any interface, and the rate at which LLDP packets are sent.

To configure LLDP settings, perform this task:

#### SUMMARY STEPS

1. `switch# configure terminal`
2. `switch(config)# lldp {holdtime seconds | reinit seconds | timer seconds}`
3. `switch(config)# no lldp {holdtime | reinit | timer}`
4. (Optional)`switch#show lldp`

#### DETAILED STEPS

|        | Command or Action                                                                                          | Purpose                                                                                                                                                                                                                                                                                                                                                                        |
|--------|------------------------------------------------------------------------------------------------------------|--------------------------------------------------------------------------------------------------------------------------------------------------------------------------------------------------------------------------------------------------------------------------------------------------------------------------------------------------------------------------------|
| Step 1 | <code>switch# configure terminal</code>                                                                    | Enters configuration mode.                                                                                                                                                                                                                                                                                                                                                     |
| Step 2 | <code>switch(config)# lldp {holdtime <i>seconds</i>   reinit <i>seconds</i>   timer <i>seconds</i>}</code> | Configures LLDP options.<br><br>Use the <b>holdtime</b> option to set the length of time (10 to 255 seconds, default 120 seconds) that a device should save LLDP information received before discarding it.<br><br>Use the <b>reinit</b> option to set the length of time (1 to 10 seconds, default 2 seconds) to wait before performing LLDP initialization on any interface. |

|               | Command or Action                                          | Purpose                                                                                                            |
|---------------|------------------------------------------------------------|--------------------------------------------------------------------------------------------------------------------|
|               |                                                            | Use the <b>timer</b> option to set the rate (5 to 254 seconds, default 30 seconds) at which LLDP packets are sent. |
| <b>Step 3</b> | switch(config)# <b>no lldp</b> {holdtime   reinit   timer} | Reset the LLDP values to their defaults.                                                                           |
| <b>Step 4</b> | (Optional)switch# <b>show lldp</b>                         | Displays LLDP configurations.                                                                                      |

This example shows how to set LLDP timer option to 15 seconds:

```
switch# configure terminal
switch(config)# lldp timer 15
```

## Configuring Interface LLDP Commands

To configure the LLDP feature for a physical Ethernet interface, perform this task:

### SUMMARY STEPS

1. switch# **configure terminal**
2. switch(config)# **interface** *type slot/port*
3. switch(config-if)# [**no**] **lldp** {receive | transmit}
4. (Optional)switch#**show lldp**

### DETAILED STEPS

|               | Command or Action                                                 | Purpose                                                                                                                                    |
|---------------|-------------------------------------------------------------------|--------------------------------------------------------------------------------------------------------------------------------------------|
| <b>Step 1</b> | switch# <b>configure terminal</b>                                 | Enters configuration mode.                                                                                                                 |
| <b>Step 2</b> | switch(config)# <b>interface</b> <i>type slot/port</i>            | Selects the interface to change.                                                                                                           |
| <b>Step 3</b> | switch(config-if)# [ <b>no</b> ] <b>lldp</b> {receive   transmit} | Sets the selected interface to either receive or transmit.<br><br>The <b>no</b> form of the command disables the LLDP transmit or receive. |
| <b>Step 4</b> | (Optional)switch# <b>show lldp</b>                                | Displays LLDP configurations.                                                                                                              |

This example shows how to set an interface to transmit LLDP packets:

```
switch# configure terminal
switch(config)# interface ethernet 1/2
switch(config-if)# lldp transmit
```

This example shows how to configure an interface to disable LLDP:

```
switch# configure terminal
switch(config)# interface ethernet 1/2
switch(config-if)# no lldp transmit
switch(config-if)# no lldp receive
```

This example shows how to display LLDP interface information:

```
switch# show lldp interface ethernet 1/2
tx_enabled: TRUE
rx_enabled: TRUE
dcbx_enabled: TRUE
Port MAC address: 00:0d:ec:a3:5f:48
Remote Peers Information
No remote peers exist
```

This example shows how to display LLDP neighbor information:

```
switch# show lldp neighbors
LLDP Neighbors

Remote Peers Information on interface Eth1/40
Remote peer's MSAP: length 12 Bytes:
00 c0 dd 0e 5f 3a 00 c0 dd 0e 5f 3a

LLDP TLV's
LLDP TLV type:Chassis ID LLDP TLV Length: 7
LLDP TLV type:Port ID LLDP TLV Length: 7
LLDP TLV type:Time to Live LLDP TLV Length: 2
LLDP TLV type:LLDP Organizationally Specific LLDP TLV Length: 55
LLDP TLV type:LLDP Organizationally Specific LLDP TLV Length: 5
LLDP TLV type:END of LLDPDU LLDP TLV Length: 0

Remote Peers Information on interface Eth1/34
Remote peer's MSAP: length 12 Bytes:
00 0d ec a3 27 40 00 0d ec a3 27 69

LLDP TLV's
LLDP TLV type:Chassis ID LLDP TLV Length: 7
LLDP TLV type:Port ID LLDP TLV Length: 7
LLDP TLV type:Time to Live LLDP TLV Length: 2
LLDP TLV type:LLDP Organizationally Specific LLDP TLV Length: 55
LLDP TLV type:LLDP Organizationally Specific LLDP TLV Length: 5
LLDP TLV type:END of LLDPDU LLDP TLV Length: 0

Remote Peers Information on interface Eth1/33
Remote peer's MSAP: length 12 Bytes:
00 0d ec a3 27 40 00 0d ec a3 27 68

LLDP TLV's
LLDP TLV type:Chassis ID LLDP TLV Length: 7
LLDP TLV type:Port ID LLDP TLV Length: 7
LLDP TLV type:Time to Live LLDP TLV Length: 2
LLDP TLV type:LLDP Organizationally Specific LLDP TLV Length: 55
LLDP TLV type:LLDP Organizationally Specific LLDP TLV Length: 5
LLDP TLV type:END of LLDPDU LLDP TLV Length: 0
```

This example shows how to display LLDP timer information:

```
switch# show lldp timers
LLDP Timers
holdtime 120 seconds
reinit 2 seconds
msg_tx_interval 30 seconds
```

This example shows how to display LLDP counters:

```
switch# show lldp traffic
LLDP traffic statistics:

Total frames out: 8464
Total Entries aged: 6
Total frames in: 6342
Total frames received in error: 2
Total frames discarded: 2
Total TLVs unrecognized: 0
```





# CHAPTER 13

## Configuring the MAC Address Table

---

All Ethernet interfaces on Cisco Nexus 5000 Series switches maintain media access control (MAC) address tables. This chapter describes the configuration of the MAC address tables. It includes the following sections:

- [Information About MAC Addresses, page 179](#)
- [Configuring MAC Addresses, page 179](#)
- [Verifying the MAC Address Configuration, page 181](#)

### Information About MAC Addresses

To switch frames between LAN ports, the switch maintains an address table. When the switch receives a frame, it associates the media access control (MAC) address of the sending network device with the LAN port on which it was received.

The switch dynamically builds the address table by using the MAC source address of the frames received. When the switch receives a frame for a MAC destination address not listed in its address table, it floods the frame to all LAN ports of the same VLAN except the port that received the frame. When the destination station replies, the switch adds its relevant MAC source address and port ID to the address table. The switch then forwards subsequent frames to a single LAN port without flooding all LAN ports.

You can also enter a MAC address, which is termed a static MAC address, into the table. These static MAC entries are retained across a reboot of the switch.

In addition, you can enter a multicast address as a statically configured MAC address. A multicast address can accept more than one interface as its destination.

The address table can store a number of unicast and multicast address entries without flooding any frames. The switch uses an aging mechanism, defined by a configurable aging timer, so if an address remains inactive for a specified number of seconds, it is removed from the address table.

### Configuring MAC Addresses

#### Configuring a Static MAC Address

You can configure MAC addresses for the switch. These addresses are static MAC addresses.

**Note**

You can also configure a static MAC address in interface configuration mode or VLAN configuration mode.

**SUMMARY STEPS**

1. switch# **configure terminal**
2. switch(config)# **mac-address-table static** *mac\_address* **vlan** *vlan-id* {**drop** | **interface** {*type slot/port*} | **port-channel** *number*} [**auto-learn**]
3. (Optional) switch(config)# **no mac-address-table static** *mac\_address* **vlan** *vlan-id*

**DETAILED STEPS**

|               | Command or Action                                                                                                                                                                                                    | Purpose                                                                                                                                                                                   |
|---------------|----------------------------------------------------------------------------------------------------------------------------------------------------------------------------------------------------------------------|-------------------------------------------------------------------------------------------------------------------------------------------------------------------------------------------|
| <b>Step 1</b> | switch# <b>configure terminal</b>                                                                                                                                                                                    | Enters configuration mode.                                                                                                                                                                |
| <b>Step 2</b> | switch(config)# <b>mac-address-table static</b> <i>mac_address</i> <b>vlan</b> <i>vlan-id</i> { <b>drop</b>   <b>interface</b> { <i>type slot/port</i> }   <b>port-channel</b> <i>number</i> } [ <b>auto-learn</b> ] | Specifies a static address to add to the MAC address table.<br>If you enable the auto-learn option, the switch will update the entry if the same MAC address is seen on a different port. |
| <b>Step 3</b> | switch(config)# <b>no mac-address-table static</b> <i>mac_address</i> <b>vlan</b> <i>vlan-id</i>                                                                                                                     | (Optional)<br>Deletes the static entry from the MAC address table.                                                                                                                        |

This example shows how to put a static entry in the MAC address table:

```
switch# configure terminal
switch(config)# mac-address-table static 12ab.47dd.ff89 vlan 3 interface ethernet 2/1
```

You can use the **mac-address-table static** command to assign a static MAC address to a virtual interface.

## Configuring the Aging Time for the MAC Table

You can configure the amount of time that an entry (the packet source MAC address and port that packet ingresses) remain in the MAC table.

**Note**

You can also configure MAC aging time in interface configuration mode or VLAN configuration mode.

**SUMMARY STEPS**

1. switch# **configure terminal**
2. switch(config)# **mac-address-table aging-time** *seconds* [**vlan** *vlan\_id*]

## DETAILED STEPS

|        | Command or Action                                                          | Purpose                                                                                                                                                                                                                                                                     |
|--------|----------------------------------------------------------------------------|-----------------------------------------------------------------------------------------------------------------------------------------------------------------------------------------------------------------------------------------------------------------------------|
| Step 1 | switch# <b>configure terminal</b>                                          | Enters configuration mode.                                                                                                                                                                                                                                                  |
| Step 2 | switch(config)# <b>mac-address-table aging-time seconds [vlan vlan_id]</b> | Specifies the time before an entry ages out and is discarded from the MAC address table. The range is from 0 to 1000000; the default is 300 seconds. Entering the value 0 disables the MAC aging. If a VLAN is not specified, the aging specification applies to all VLANs. |

This example shows how to set the aging time for entries in the MAC address table to 600 seconds (10 minutes):

```
switch# configure terminal
switch(config)# mac-address-table aging-time 600
```

## Clearing Dynamic Addresses from the MAC Table

You can clear all dynamic entries in the MAC address table.

| Command                                                                                                                                           | Purpose                                                        |
|---------------------------------------------------------------------------------------------------------------------------------------------------|----------------------------------------------------------------|
| switch(config)# <b>clear mac-address-table dynamic</b><br>{address mac-addr} {interface [type slot/port  <br>port-channel number]} {vlan vlan-id} | Clears the dynamic address entries from the MAC address table. |

This example shows how to clear the dynamic entries in the MAC address table:

```
switch# clear mac-address-table dynamic
```

## Verifying the MAC Address Configuration

To display MAC address configuration information, perform one of these tasks:

| Command                                          | Purpose                                                                  |
|--------------------------------------------------|--------------------------------------------------------------------------|
| switch# <b>show mac-address-table aging-time</b> | Displays the MAC address aging time for all VLANs defined in the switch. |
| switch# <b>show mac-address-table</b>            | Displays the contents of the MAC address table.                          |

This example shows how to display the MAC address table:

```
switch# show mac-address-table
VLAN      MAC Address      Type      Age      Port
-----+-----+-----+-----+-----
1         0018.b967.3cd0   dynamic   10       Eth1/3
1         001c.b05a.5380   dynamic   200      Eth1/3
Total MAC Addresses: 2
```

This example shows how to display the current aging time:

```
switch# show mac-address-table aging-time
Vlan      Aging Time
-----
1         300
13        300
42        300
```



# CHAPTER 14

## Configuring IGMP Snooping

By examining (snooping), Internet Group Management Protocol (IGMP) membership report messages from interested hosts, multicast traffic is limited to the subset of VLAN interfaces on which the hosts reside.

This chapter describes the configuration of IGMP snooping on Cisco Nexus 5000 Series switches. It includes the following sections:

- [Information About IGMP Snooping, page 183](#)
- [Configuring IGMP Snooping Parameters, page 186](#)
- [Verifying IGMP Snooping Configuration, page 188](#)

## Information About IGMP Snooping

The IGMP snooping software examines IGMP protocol messages within a VLAN to discover which interfaces are connected to hosts or other devices interested in receiving this traffic. Using the interface information, IGMP snooping can reduce bandwidth consumption in a multi-access LAN environment to avoid flooding the entire VLAN. The IGMP snooping feature tracks which ports are attached to multicast-capable routers to help it manage the forwarding of IGMP membership reports. The IGMP snooping software responds to topology change notifications.



### Note

IGMP snooping is supported on all Ethernet interfaces. The term *snooping* is used because Layer 3 control plane packets are intercepted and influence Layer 2 forwarding decisions.

Cisco NX-OS supports IGMPv2 and IGMPv3. IGMPv2 supports IGMPv1, and IGMPv3 supports IGMPv2. Although not all features of an earlier version of IGMP are supported, the features related to membership query and membership report messages are supported for all IGMP versions.

The following figure shows an IGMP snooping switch that is located between the host and the IGMP router. The IGMP snooping switch snoops the IGMP membership reports and leave messages and forwards them only when necessary to the connected IGMP routers.

**Figure 23: IGMP Snooping Switch**

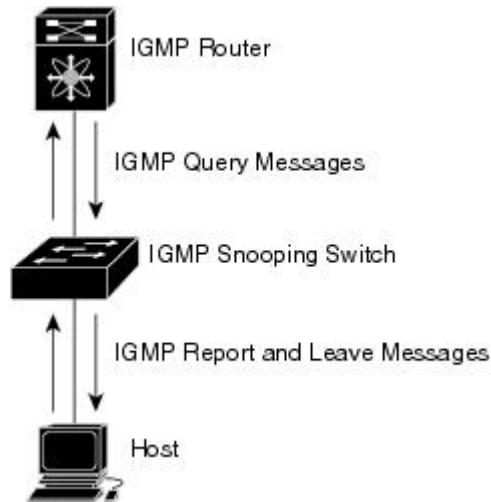

**Note** The switch supports IGMPv3 snooping based only on the destination multicast MAC address. It does not support snooping based on the source MAC address or on proxy reports.

The Cisco NX-OS IGMP snooping software supports optimized multicast flooding (OMF) that forwards unknown traffic to routers only and performs no data driven state creation. For more information about IGMP snooping, see <http://tools.ietf.org/wg/magma/draft-ietf-magma-snoop/rfc4541.txt>.

## IGMPv1 and IGMPv2

Both IGMPv1 and IGMPv2 support membership report suppression, which means that if two hosts on the same subnet want to receive multicast data for the same group, then the host that receives a member report from the other host suppresses sending its report. Membership report suppression occurs for hosts that share a port.

If no more than one host is attached to each VLAN switch port, then you can configure the fast leave feature in IGMPv2. The fast leave feature does not send last member query messages to hosts. As soon as the software receives an IGMP leave message, the software stops forwarding multicast data to that port.

IGMPv1 does not provide an explicit IGMP leave message, so the software must rely on the membership message timeout to indicate that no hosts remain that want to receive multicast data for a particular group.



**Note** Cisco NX-OS ignores the configuration of last member query interval when you enable the fast leave feature because it does not check for remaining hosts.

## IGMPv3

The IGMPv3 snooping implementation on the switch forwards IGMPv3 reports to allow the upstream multicast router do source-based filtering.

By default, the software tracks hosts on each VLAN port. The explicit tracking feature provides a fast leave mechanism. Because every IGMPv3 host sends membership reports, a report suppression feature limits the amount of traffic the switch sends to other multicast capable routers. When report suppression is enabled, and no IGMPv1 or IGMPv2 hosts requested the same group, the software provides proxy reporting. The proxy feature builds group state from membership reports from the downstream hosts and generates membership reports in response to queries from upstream queriers.

Even though the IGMPv3 membership reports provide a full accounting of group members on a LAN segment, when the last host leaves, the software sends a membership query. You can configure the parameter last member query interval. If no host responds before the timeout, the software removes the group state.

## IGMP Snooping Querier

When there is no multicast router in the VLAN to originate the queries, you must configure an IGMP snooping querier to send membership queries.

When an IGMP snooping querier is enabled, it sends out periodic IGMP queries that trigger IGMP report messages from hosts that want to receive IP multicast traffic. IGMP snooping listens to these IGMP reports to establish appropriate forwarding.

## IGMP Forwarding

The control plane of the Cisco Nexus 5000 Series switch is able to detect IP addresses but forwarding occurs using the MAC address only.

When a host connected to the switch wants to join an IP multicast group, it sends an unsolicited IGMP join message, specifying the IP multicast group to join. Alternatively, when the switch receives a general query from a connected router, it forwards the query to all interfaces, physical and virtual, in the VLAN. Hosts wanting to join the multicast group respond by sending a join message to the switch. The switch CPU creates a multicast forwarding table entry for the group if it is not already present. The CPU also adds the interface where the join message was received to the forwarding table entry. The host associated with that interface receives multicast traffic for that multicast group.

The router sends periodic multicast general queries and the switch forwards these queries through all ports in the VLAN. Interested hosts respond to the queries. If at least one host in the VLAN wants to receive multicast traffic, the router continues forwarding the multicast traffic to the VLAN. The switch forwards multicast group traffic to only those hosts listed in the forwarding table for that multicast group.

When hosts want to leave a multicast group, they can either silently leave, or they can send a leave message. When the switch receives a leave message from a host, it sends a group-specific query to determine if any other devices connected to that interface are interested in traffic for the specific multicast group. The switch then updates the forwarding table for that MAC group so that only those hosts interested in receiving multicast traffic for the group are listed in the forwarding table. If the router receives no reports from a VLAN, it removes the group for the VLAN from its IGMP cache.

## Configuring IGMP Snooping Parameters

To manage the operation of the IGMP snooping process, you can configure the optional IGMP snooping parameters described in the following table.

**Table 17: IGMP Snooping Parameters**

| Parameter                  | Description                                                                                                                                                                                                                                                                                                                                                               |
|----------------------------|---------------------------------------------------------------------------------------------------------------------------------------------------------------------------------------------------------------------------------------------------------------------------------------------------------------------------------------------------------------------------|
| IGMP snooping              | Enables IGMP snooping on a per-VLAN basis. The default is enabled.<br><br><b>Note</b> If the global setting is disabled, then all VLANs are treated as disabled, whether they are enabled or not.                                                                                                                                                                         |
| Explicit tracking          | Tracks IGMPv3 membership reports from individual hosts for each port on a per-VLAN basis. The default is enabled.                                                                                                                                                                                                                                                         |
| Fast leave                 | Enables the software to remove the group state when it receives an IGMP Leave report without sending an IGMP query message. This parameter is used for IGMPv2 hosts when no more than one host is present on each VLAN port. The default is disabled.                                                                                                                     |
| Last member query interval | Sets the interval that the software waits after sending an IGMP query to verify that no hosts that want to receive a particular multicast group remain on a network segment. If no hosts respond before the last member query interval expires, the software removes the group from the associated VLAN port. Values range from 1 to 25 seconds. The default is 1 second. |
| Snooping querier           | Configures a snooping querier on an interface when there is no multicast router in the VLAN to generate queries. The default is disabled.                                                                                                                                                                                                                                 |
| Report suppression         | Limits the membership report traffic sent to multicast-capable routers. When you disable report suppression, all IGMP reports are sent as is to multicast-capable routers. The default is enabled.                                                                                                                                                                        |
| Multicast router           | Configures a static connection to a multicast router. The interface to the router must be in the selected VLAN.                                                                                                                                                                                                                                                           |
| Static group               | Configures an interface belonging to a VLAN as a static member of a multicast group.                                                                                                                                                                                                                                                                                      |

You can disable IGMP snooping either globally or for a specific VLAN.

## SUMMARY STEPS

1. switch# **configure terminal**
2. switch(config)# **ip igmp snooping**
3. switch(config)# **vlan *vlan-id***
4. switch(config-vlan)# **ip igmp snooping**
5. switch(config-vlan)# **ip igmp snooping explicit-tracking**
6. switch(config-vlan)# **ip igmp snooping fast-leave**
7. switch(config-vlan)# **ip igmp snooping last-member-query-interval *seconds***
8. switch(config-vlan)# **ip igmp snooping querier *IP-address***
9. switch(config-vlan)# **ip igmp snooping report-suppression**
10. switch(config-vlan)# **ip igmp snooping mrouter interface *interface***
11. switch(config-vlan)# **ip igmp snooping static-group *group-ip-addr* [*source source-ip-addr*] interface *interface***

## DETAILED STEPS

|               | Command or Action                                                                      | Purpose                                                                                                                                                                                                                                                                                |
|---------------|----------------------------------------------------------------------------------------|----------------------------------------------------------------------------------------------------------------------------------------------------------------------------------------------------------------------------------------------------------------------------------------|
| <b>Step 1</b> | switch# <b>configure terminal</b>                                                      | Enters configuration mode.                                                                                                                                                                                                                                                             |
| <b>Step 2</b> | switch(config)# <b>ip igmp snooping</b>                                                | Globally enables IGMP snooping. The default is enabled.<br><b>Note</b> If the global setting is disabled, then all VLANs are treated as disabled, whether they are enabled or not.                                                                                                     |
| <b>Step 3</b> | switch(config)# <b>vlan <i>vlan-id</i></b>                                             | Enters VLAN configuration mode.                                                                                                                                                                                                                                                        |
| <b>Step 4</b> | switch(config-vlan)# <b>ip igmp snooping</b>                                           | Enables IGMP snooping for the current VLAN. The default is enabled.<br><b>Note</b> If IGMP snooping is enabled globally, this command is not required.                                                                                                                                 |
| <b>Step 5</b> | switch(config-vlan)# <b>ip igmp snooping explicit-tracking</b>                         | Tracks IGMPv3 membership reports from individual hosts for each port on a per-VLAN basis. The default is enabled on all VLANs.                                                                                                                                                         |
| <b>Step 6</b> | switch(config-vlan)# <b>ip igmp snooping fast-leave</b>                                | Supports IGMPv2 hosts that cannot be explicitly tracked because of the host report suppression mechanism of the IGMPv2 protocol. When you enable fast leave, the IGMP software assumes that no more than one host is present on each VLAN port. The default is disabled for all VLANs. |
| <b>Step 7</b> | switch(config-vlan)# <b>ip igmp snooping last-member-query-interval <i>seconds</i></b> | Removes the group from the associated VLAN port if no hosts respond to an IGMP query message before the last member query interval expires. Values range from 1 to 25 seconds. The default is 1 second.                                                                                |
| <b>Step 8</b> | switch(config-vlan)# <b>ip igmp snooping querier <i>IP-address</i></b>                 | Configures a snooping querier when you do not enable PIM because multicast traffic does not need to be routed. The IP address is used as the source in messages. The default is disabled.                                                                                              |

|                | Command or Action                                                                                                                                 | Purpose                                                                                                                                                                                            |
|----------------|---------------------------------------------------------------------------------------------------------------------------------------------------|----------------------------------------------------------------------------------------------------------------------------------------------------------------------------------------------------|
| <b>Step 9</b>  | switch(config-vlan)# <b>ip igmp snooping report-suppression</b>                                                                                   | Limits the membership report traffic sent to multicast-capable routers. When you disable report suppression, all IGMP reports are sent as is to multicast-capable routers. The default is enabled. |
| <b>Step 10</b> | switch(config-vlan)# <b>ip igmp snooping mrouter interface</b> <i>interface</i>                                                                   | Configures a static connection to a multicast router. The interface to the router must be in the selected VLAN. You can specify the interface by type and number.                                  |
| <b>Step 11</b> | switch(config-vlan)# <b>ip igmp snooping static-group</b> <i>group-ip-addr</i> [ <i>source source-ip-addr</i> ] <b>interface</b> <i>interface</i> | Configures an interface belonging to a VLAN as a static member of a multicast group. You can specify the interface by type and number.                                                             |

The following example shows configuring IGMP snooping parameters for a VLAN:

```
switch# configure terminal
switch(config)# vlan 5
switch(config-vlan)# ip igmp snooping last-member-query-interval 3
switch(config-vlan)# ip igmp snooping querier 172.20.52.106
switch(config-vlan)# ip igmp snooping explicit-tracking
switch(config-vlan)# ip igmp snooping fast-leave
switch(config-vlan)# ip igmp snooping report-suppression
switch(config-vlan)# ip igmp snooping mrouter interface ethernet 1/10
switch(config-vlan)# ip igmp snooping static-group 230.0.0.1 interface ethernet 1/10
switch(config-vlan)# end
```

## Verifying IGMP Snooping Configuration

To verify the IGMP snooping configuration, perform one of these tasks:

| Command                                                                                | Description                                          |
|----------------------------------------------------------------------------------------|------------------------------------------------------|
| switch# <b>show ip igmp snooping</b> [[vlan] <i>vlan-id</i> ]                          | IGMP snooping configuration by VLAN.                 |
| switch# <b>show ip igmp snooping groups</b> [[vlan] <i>vlan-id</i> ] [ <b>detail</b> ] | IGMP snooping information about groups by VLAN.      |
| switch# <b>show ip igmp snooping querier</b> [[vlan] <i>vlan-id</i> ]                  | IGMP snooping queriers by VLAN.                      |
| switch# <b>show ip igmp snooping mrouter</b> [[vlan] <i>vlan-id</i> ]                  | Multicast router ports by VLAN.                      |
| switch# <b>show ip igmp snooping explicit-tracking</b> <i>vlan</i> <i>vlan-id</i>      | IGMP snooping explicit tracking information by VLAN. |

The following example shows how to verify the IGMP snooping parameters:

```
switch# show ip igmp snooping
Global IGMP Snooping Information:
  IGMP Snooping enabled
```

```
IGMP Snooping information for vlan 1
  IGMP snooping enabled
  IGMP querier none
  Switch-querier disabled
  Explicit tracking enabled
  Fast leave disabled
  Report suppression enabled
  Router port detection using PIM Hellos, IGMP Queries
  Number of router-ports: 0
  Number of groups: 0
IGMP Snooping information for vlan 5
IGMP snooping enabled
  IGMP querier present, address: 172.16.24.1, version: 3
  Querier interval: 125 secs
  Querier last member query interval: 10 secs
  Querier robustness: 2
  Switch-querier enabled, address 172.16.24.1, currently running
  Explicit tracking enabled
  Fast leave enabled
  Report suppression enabled
  Router port detection using PIM Hellos, IGMP Queries
  Number of router-ports: 1
  Number of groups: 1
```





## CHAPTER **15**

# Configuring Traffic Storm Control

---

This chapter describes how to configure traffic storm control on Cisco Nexus 5000 Series switches. It contains the following sections:

- [Information About Traffic Storm Control, page 191](#)
- [Traffic Storm Guidelines and Limitations, page 192](#)
- [Configuring Traffic Storm Control, page 193](#)
- [Traffic Storm Control Example Configuration, page 194](#)
- [Default Traffic Storm Settings, page 194](#)

## Information About Traffic Storm Control

A traffic storm occurs when packets flood the LAN, creating excessive traffic and degrading network performance. You can use the traffic storm control feature to prevent disruptions on Ethernet interfaces by a broadcast, multicast, or unknown unicast traffic storm.

Traffic storm control (also called traffic suppression) allows you to monitor the levels of the incoming broadcast, multicast, and unicast traffic over a 10-microsecond interval. During this interval, the traffic level, which is a percentage of the total available bandwidth of the port, is compared with the traffic storm control level that you configured. When the ingress traffic reaches the traffic storm control level that is configured on the port, traffic storm control drops the traffic until the interval ends.

The following figure shows the broadcast traffic patterns on an Ethernet interface during a specified time interval. In this example, traffic storm control occurs between times T1 and T2 and between T4 and T5. During those intervals, the amount of broadcast traffic exceeded the configured threshold.

**Figure 24: Broadcast Suppression**

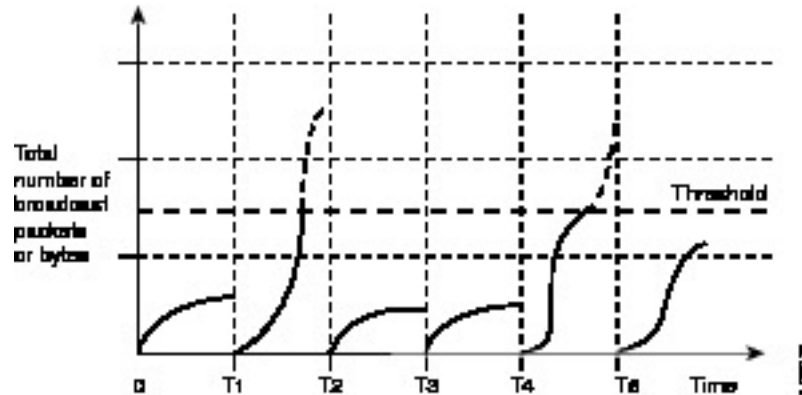

The traffic storm control threshold numbers and the time interval allow the traffic storm control algorithm to work with different levels of packet granularity. For example, a higher threshold allows more packets to pass through.

Traffic storm control on the Cisco Nexus 5000 Series switch is implemented in the hardware. The traffic storm control circuitry monitors packets that pass from an Ethernet interface to the switching bus. Using the Individual/Group bit in the packet destination address, the circuitry determines if the packet is unicast or broadcast, tracks the current count of packets within the 10-microsecond interval, and filters out subsequent packets when a threshold is reached.

Traffic storm control uses a bandwidth-based method to measure traffic. You set the percentage of total available bandwidth that the controlled traffic can use. Because packets do not arrive at uniform intervals, the 10-microsecond interval can affect the operation of traffic storm control.

The following are examples of how traffic storm control operation is affected:

- If you enable broadcast traffic storm control, and broadcast traffic exceeds the level within the 10-microsecond interval, traffic storm control drops all broadcast traffic until the end of the interval.
- If you enable multicast traffic storm control, and the multicast traffic exceeds the level within the 10-microsecond interval, traffic storm control drops all multicast traffic until the end of the interval.
- If you enable broadcast and multicast traffic storm control, and broadcast traffic exceeds the level within the 10-microsecond interval, traffic storm control drops all broadcast traffic until the end of the interval.
- If you enable broadcast and multicast traffic storm control, and multicast traffic exceeds the level within the 10-microsecond interval, traffic storm control drops all multicast traffic until the end of the interval.

By default, Cisco NX-OS takes no corrective action when the traffic exceeds the configured level.

## Traffic Storm Guidelines and Limitations

When configuring the traffic storm control level, follow these guidelines and limitations:

- You can configure traffic storm control on a port-channel interface.

- Specify the level as a percentage of the total interface bandwidth:
  - The level can be from 0 to 100.
  - The optional fraction of a level can be from 0 to 99.
  - 100 percent means no traffic storm control.
  - 0.0 percent suppresses all traffic.

Because of hardware limitations and the method by which packets of different sizes are counted, the level percentage is an approximation. Depending on the sizes of the frames that make up the incoming traffic, the actual enforced level might differ from the configured level by several percentage points.

## Configuring Traffic Storm Control

You can set the percentage of total available bandwidth that the controlled traffic can use.



### Note

Traffic storm control uses a 10-microsecond interval that can affect the operation of traffic storm control.

### SUMMARY STEPS

1. switch# **configure terminal**
2. switch(config)# **interface** {*ethernet slot/port* | **port-channel number**}
3. switch(config-if)# **storm-control** {**broadcast** | **multicast** | **unicast**} **level** *percentage*[*fraction*]

### DETAILED STEPS

|               | Command or Action                                                                                                                                   | Purpose                                                                                       |
|---------------|-----------------------------------------------------------------------------------------------------------------------------------------------------|-----------------------------------------------------------------------------------------------|
| <b>Step 1</b> | switch# <b>configure terminal</b>                                                                                                                   | Enters configuration mode.                                                                    |
| <b>Step 2</b> | switch(config)# <b>interface</b> { <i>ethernet slot/port</i>   <b>port-channel number</b> }                                                         | Enters interface configuration mode.                                                          |
| <b>Step 3</b> | switch(config-if)# <b>storm-control</b> { <b>broadcast</b>   <b>multicast</b>   <b>unicast</b> } <b>level</b> <i>percentage</i> [ <i>fraction</i> ] | Configures traffic storm control for traffic on the interface. The default state is disabled. |

This example shows how to configure unicast traffic storm control for Ethernet interface 1/4:

```
switch# configure terminal
switch(config)# interface ethernet 1/4
switch(config-if)# storm-control unicast level 40
```

## Verifying Traffic Storm Control Configuration

To display traffic storm control configuration information, perform one of these tasks:

| Command                                                                                                               | Purpose                                                                                                                                                                                              |
|-----------------------------------------------------------------------------------------------------------------------|------------------------------------------------------------------------------------------------------------------------------------------------------------------------------------------------------|
| switch# <b>show interface</b> [ethernet <i>slot/port</i>   port-channel <i>number</i> ] <b>counters storm-control</b> | Displays the traffic storm control configuration for the interfaces.<br><br><b>Note</b> Traffic storm control uses a 10-microsecond interval that can affect the operation of traffic storm control. |
| switch# <b>show running-config interface</b>                                                                          | Displays the traffic storm control configuration.                                                                                                                                                    |

## Traffic Storm Control Example Configuration

The following example shows how to configure traffic storm control:

```
switch# configure terminal
switch(config)# interface ethernet 1/4
switch(config-if)# storm-control broadcast level 40
switch(config-if)# storm-control multicast level 40
switch(config-if)# storm-control unicast level 40
```

## Default Traffic Storm Settings

The following table lists the default settings for traffic storm control parameters.

**Table 18: Default Traffic Storm Control Parameters**

| Parameters            | Default  |
|-----------------------|----------|
| Traffic storm control | Disabled |
| Threshold percentage  | 100      |



# CHAPTER 16

## Configuring the Fabric Extender

---

This chapter describes how to configure a Cisco Nexus 2000 Series Fabric Extender using the device and includes the following sections:

- [Information About the Cisco Nexus 2000 Series Fabric Extender](#), page 195
- [Fabric Extender Terminology](#), page 196
- [Fabric Extender Features](#), page 197
- [Oversubscription](#), page 200
- [Management Model](#), page 201
- [Forwarding Model](#), page 202
- [Connection Model](#), page 202
- [Port Numbering Convention](#), page 204
- [Fabric Extender Image Management](#), page 205
- [Fabric Extender Hardware](#), page 205
- [Information About Associating a Fabric Extender to a Fabric Interface](#), page 206
- [Configuring Fabric Extender Global Features](#), page 209
- [Enabling the Fabric Extender Locator LED](#), page 211
- [Redistributing the Links](#), page 211
- [Verifying Fabric Extender Configuration](#), page 212
- [Verifying Chassis Management Information](#), page 215

## Information About the Cisco Nexus 2000 Series Fabric Extender

The Cisco Nexus 2000 Series Fabric Extender is a highly scalable and flexible server networking solution that works with devices to provide high-density, low-cost connectivity for server aggregation. Scaling across 1-Gigabit Ethernet, 10-Gigabit Ethernet, unified fabric, rack, and blade server environments, the Fabric Extender is designed to simplify data center architecture and operations.

The Fabric Extender integrates with its parent switch, a device, to allow automatic provisioning and configuration taken from the settings on the parent switch. This integration allows large numbers of servers and hosts to be supported using the same feature set as the parent switch, including security and quality of service (QoS) configuration parameters, with a single management domain as shown in the following figure. The Fabric Extender and its parent switch enable a large multi-path, loop-free, active-active data center topology without the use of Spanning Tree Protocol (STP).

**Figure 25: Single Management Domain**

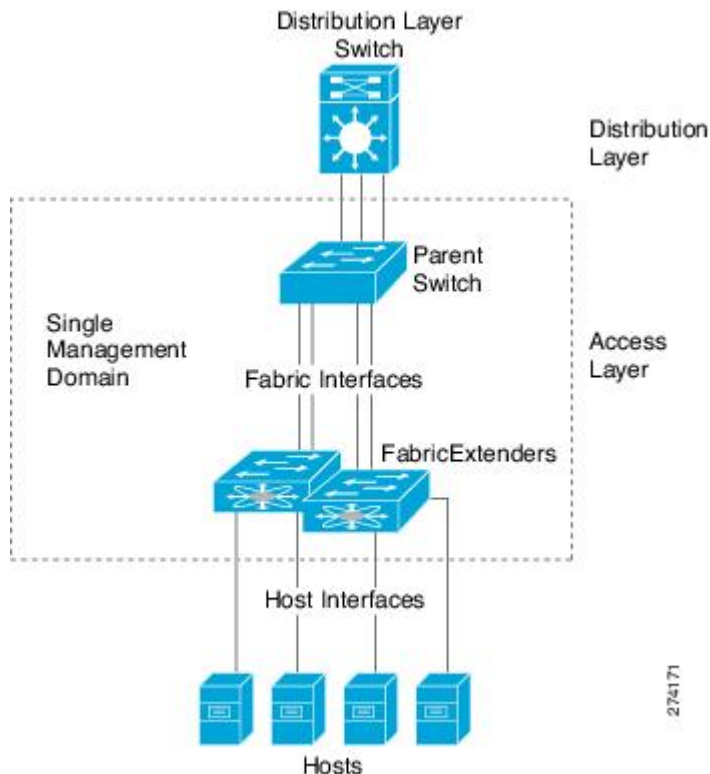

The Cisco Nexus 2000 Series Fabric Extender forwards all traffic to its parent device over 10-Gigabit Ethernet fabric uplinks, allowing all traffic to be inspected by policies established on the device.

No software is included with the Fabric Extender. Software is automatically downloaded and upgraded from its parent switch.

## Fabric Extender Terminology

Some terms used in this document are as follows:

- Fabric interface—A 10-Gigabit Ethernet uplink port designated for connection from the Fabric Extender to its parent switch. A fabric interface cannot be used for any other purpose. It must be directly connected to the parent switch.

**Note**

A fabric interface includes the corresponding interface on the parent switch. This interface is enabled when you enter the **switchport mode fex-fabric** command.

- fabric interface— uplink connection from the Fabric Extender to its parent switch. This connection consists of fabric interfaces bundled into a single logical channel.
- Host interface—An Ethernet host interface for connection to a server or host system.

**Note**

Do not connect a bridge or switch to a host interface. These interfaces are designed to provide end host or server connectivity.

- host interface— host interface for connection to a server or host system.

## Fabric Extender Features

The Cisco Nexus 2000 Series Fabric Extender allows a single switch—and a single consistent set of switch features—to be supported across a large number of hosts and servers. By supporting a large server-domain under a single management entity, policies can be enforced more efficiently.

Some of the features of the parent switch cannot be extended onto the Fabric Extender.

## Host Interfaces

Host interfaces are for host or server connectivity only; host interfaces cannot connect to another network. These interfaces are always enabled as edge ports; as they come up, these ports immediately transition to the forwarding state. Host interfaces are always enabled with BPDU Guard. If a BPDU is received, the port is immediately placed in an error-disabled state which keeps the link down.

You can enable host interfaces to accept Cisco Discovery Protocol (CDP) packets. This protocol only works when it is enabled for both ends of a link.

**Note**

CDP is not supported on fabric interfaces when the Fabric Extender is configured in a virtual port channel (vPC) topology.

Ingress and egress packet counters are provided on each host interface.

For more information about BPDU Guard and CDP see the .

## Host

The Cisco Nexus 2248TP and Cisco Nexus 2232PP support host interface configurations. Up to 8 interfaces can be combined in . The can be configured with or without LACP.

For more information about see the .

## VLANs and Private VLANs

The Fabric Extender supports Layer 2 VLAN trunks and IEEE 802.1Q VLAN encapsulation. Host interfaces can be members of private VLANs with the following restrictions:

- You can configure a host interface as an isolated or community access port only.
- You cannot configure a host interface as a promiscuous port.
- You cannot configure a host interface as a private VLAN trunk port.

For more information about promiscuous, community, and isolated ports in private VLANs see the .

## Virtual Port Channels

Using a virtual port channel (vPC) you can configure topologies where a Cisco Nexus 2000 Series Fabric Extender is connected to a pair of parent switches or a pair of Fabric Extenders are connected to a single parent switch. The vPC can provide multipath connections, which allow you to create redundancy between the nodes on your network.

See the for vPC configuration details.

## Fibre Channel over Ethernet Support

The Cisco Nexus 2232PP supports Fibre Channel over Ethernet (FCoE) with the following restrictions:

- Only FCoE Initialization Protocol (FIP) enabled converged network adapters (CNAs) are supported on the Fabric Extender.
- Binding to is limited to only one member .

See the for configuration details.

## Protocol Offload

To reduce the load on the control plane of the device, Cisco NX-OS provides the ability to offload link-level protocol processing to the Fabric Extender CPU. The following protocols are supported:

- Link Layer Discovery Protocol (LLDP) and Data Center Bridging Exchange (DCBX)
- Cisco Discovery Protocol (CDP)
- Link Aggregation Control Protocol (LACP)

## Quality of Service

The Fabric Extender provides two user queues for its quality of service (QoS) support, one for all no-drop classes and one for all drop classes. The classes configured on its parent switch are mapped to one of these two queues; traffic for no-drop classes is mapped to one queue and traffic for all drop classes is mapped to the other. Egress policies are also restricted to these two classes.

The parent switch provides two predefined type qos class maps for matching broadcast or multicast traffic; class-all-flood and class-ip-multicast. These classes are ignored on the Fabric Extender.

The Fabric Extender uses IEEE 802.1p class of service (CoS) values to associate traffic with the appropriate class. Per-port QoS configuration and CoS-based egress queuing is also supported.

Host interfaces support pause frames, which is implemented using IEEE 802.3x link-level flow control (LLC). By default, flow control send is on and flow control receive is off on all host interfaces. Autonegotiation is enabled on the host interfaces. Per-class flow control is set according to the QoS classes.

Host interfaces support jumbo frames (up to 9216 bytes); however a per-host interface maximum transmission unit (MTU) is not supported. Instead, MTU is set according to the QoS classes. You modify MTU by setting policy and class maps on the parent switch. Because the Fabric Extender has only two user queues, the MTU for the drop-queue is set to the maximum MTU of all drop classes and the MTU on the no-drop queue is set to the maximum MTU of all no-drop classes.

For more information about LLC and quality of service, see the .

## Access Control Lists

The Fabric Extender supports the full range of ingress access control lists (ACLs) that are available on its parent switch.

For more information about ACLs see the .

### Related Topics

- [Static Pinning Fabric Interface Connection, page 203](#)

## IGMP Snooping

IGMP snooping is supported on all host interfaces of the Fabric Extender.

The Fabric Extender and its parent switch support IGMPv3 snooping based only on the destination multicast MAC address. It does not support snooping based on the source MAC address or on proxy reports.



### Note

For more information about IGMP snooping, see <http://tools.ietf.org/wg/magma/draft-ietf-magma-snoop/rfc4541.txt>. Also see the .

## Switched Port Analyzer

You can configure the host interfaces on the Fabric Extender as Switched Port Analyzer (SPAN) source ports. Fabric Extender ports cannot be configured as a SPAN destination. Only one SPAN session is supported for all the host interfaces on the same Fabric Extender. Ingress source (Rx), egress source (Tx), or both ingress and egress monitoring is supported.

**Note**

---

All IP multicast traffic on the set of VLANs that a Fabric Extender host interface belongs to is captured in the SPAN session. It is not possible to separate the traffic by IP multicast group membership.

If ingress and egress monitoring is configured for host interfaces on the same Fabric Extender, you may see a packet twice: once as the packet ingresses on an interface with Rx configured, and again as the packet egresses on an interface with Tx configured.

---

For more information about SPAN see the

## Fabric Interface Features

The Fabric Extender fabric interfaces support static EtherChannel and priority flow control (PFC). PFC allows you to apply pause functionality to specific classes of traffic on an interface (instead of all the traffic on the interface). During the initial discovery and association process, SFP+ validation and digital optical monitoring (DOM) are performed as follows:

- The Fabric Extender performs a local check on the uplink SFP+ transceiver. If it fails the security check, the LED flashes but the link is still allowed to come up.
- The Fabric Extender local check is bypassed if it is running its backup image.
- The parent switch performs SFP validation again when the fabric interface is brought up. It keeps the fabric interface down if SFP validation fails.

Once an interface on the parent switch is configured in fex-fabric mode, all other features that were configured on that port and are not relevant to this mode are deactivated. If the interface is reconfigured to remove fex-fabric mode, the previous configurations are reactivated.

**Note**

---

Per class flow control mode is enabled by default on the fabric interfaces. When a fabric interface is configured on the parent switch, PFC mode is enabled by default and cannot be changed.

---

For more information about PFC see the

## Oversubscription

In a switching environment, oversubscription is the practice of connecting multiple devices to the same interface to optimize port usage. An interface can support a connection that runs at its maximum speed but because most interfaces do not run at their maximum speeds, you can take advantage of unused bandwidth by sharing ports. In the case of the Cisco Nexus 2000 Series Fabric Extender, oversubscription, which is a function of the available fabric interfaces to active host interfaces, provides cost-effective scalability and flexibility for Ethernet environments.

The Cisco Nexus 2248TP Fabric Extender has four 10-Gigabit Ethernet fabric interfaces and 48 100/1000BASE-T (100-Megabit/1-Gigabit) Ethernet host interfaces. It offers configurations when its host interfaces are running in Gigabit Ethernet mode

The Cisco Nexus 2248TP can easily be run with no oversubscription when its host interfaces are running in 100-Megabit mode.

The Cisco Nexus 2232PP Fabric Extender has eight 10-Gigabit Ethernet fabric interfaces and 32 10-Gigabit Ethernet host interfaces. With this system, you can configure a 4 to 1 oversubscription (4 host interfaces for one fabric interface) or higher.

## Management Model

The Cisco Nexus 2000 Series Fabric Extender is managed by its parent switch over the fabric interfaces through a zero-touch configuration model. The Fabric Extender is discovered by the switch by detecting the fabric interfaces of the Fabric Extender.

After discovery, if the Fabric Extender has been correctly associated with the parent switch, the following operations are performed:

- 1 The switch checks the software image compatibility and upgrades the Fabric Extender if necessary.
- 2 The switch and Fabric Extender establish in-band IP connectivity with each other. The switch assigns an IP address in the range of loopback addresses (127.15.1.0/24) to the Fabric Extender to avoid conflicts with IP addresses that may be in use on the network.
- 3 The switch pushes the configuration data to the Fabric Extender. The Fabric Extender does not store any configuration locally.
- 4 The Fabric Extender updates the switch with its operational status. All Fabric Extender information is displayed using the switch commands for monitoring and troubleshooting.



---

**Note**

Prior to Cisco NX-OS Release 4.1(3)N1(1), a Cisco Nexus 2000 Series Fabric Extender could be managed by one parent switch only.

---

## Forwarding Model

The Cisco Nexus 2000 Series Fabric Extender does not perform any local switching. All traffic is sent to the parent switch that provides central forwarding and policy enforcement, including host-to-host communications between two systems connected to the same Fabric Extender as shown in the following figure.

**Figure 26: Forwarding Model**

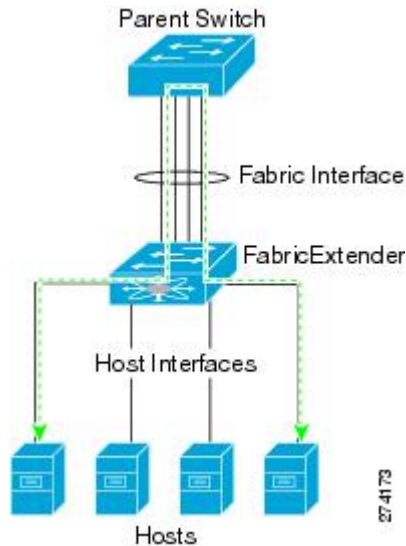

The forwarding model facilitates feature consistency between the Fabric Extender and its parent switch.



### Note

The Fabric Extender provides end-host connectivity into the network fabric. As a result, Bridge Protocol Data Unit (BPDU) Guard is enabled on all its host interfaces. If you connect a bridge or switch to a host interface, that interface is placed in an error-disabled state when a BPDU is received.

You cannot disable BPDU Guard on the host interfaces of the Fabric Extender.

The Fabric Extender supports egress multicast replication from the network to the host. Packets sent from the parent switch for multicast addresses attached to the Fabric Extender are replicated by the Fabric Extender ASICs and then sent to corresponding hosts.

## Connection Model

Two methods (the static pinning fabric interface connection and the fabric interface connection) allow the traffic from an end host to the parent switch to be distributed when going through the Cisco Nexus 2000 Series Fabric Extender.

## Static Pinning Fabric Interface Connection

To provide a deterministic relationship between the host interfaces and the parent switch, you can configure the Fabric Extender to use individual fabric interface connections. This configuration connects the 10-Gigabit Ethernet fabric interfaces as shown in the following figure. You can use any number of fabric interfaces up to the maximum available on the model of the Fabric Extender.

**Figure 27: Static Pinning Fabric Interface Connections**

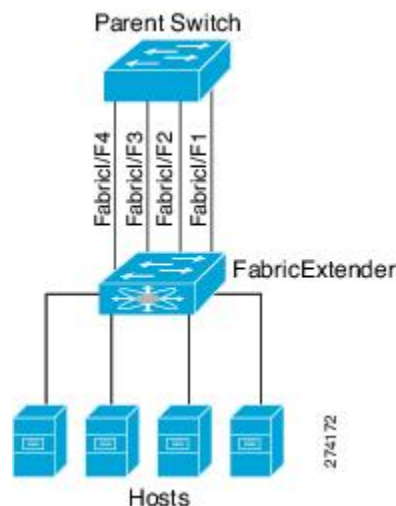

When the Fabric Extender is brought up, its host interfaces are distributed equally among the available fabric interfaces. As a result, the bandwidth that is dedicated to each end host toward the parent switch is never changed by the switch but instead is always specified by you.



### Note

If a fabric interface fails, all its associated host interfaces are brought down and remain down until the fabric interface is restored.

You must use the **pinning max-links** command to create a number of pinned fabric interface connections so that the parent switch can determine a distribution of host interfaces. The host interfaces are divided by the number of the max-links and distributed accordingly. The default value is max-links 1.



### Caution

Changing the value of the **max-links** is disruptive; all the host interfaces on the Fabric Extender are brought down and back up as the parent switch reassigns its static pinning.

The pinning order of the host interfaces is initially determined by the order in which the fabric interfaces were configured. When the parent switch is restarted, the configured fabric interfaces are pinned to the host interfaces in an ascending order by the port number of the fabric interface.

To guarantee a deterministic and sticky association across a reboot, you can manually redistribute the pinning.

**Note**

The redistribution of the host interfaces will always be in an ascending order by the port number of the fabric interface.

## Fabric Interface Connection

To provide load balancing between the host interfaces and the parent switch, you can configure the Fabric Extender to use fabric interface connection. This connection bundles 10-Gigabit Ethernet fabric interfaces into a single logical channel as shown in the following figure.

**Figure 28: Fabric Interface Connection**

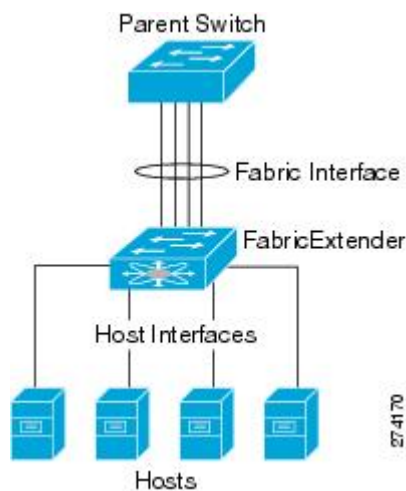

When you configure the Fabric Extender to use fabric interface connection to its parent switch, the switch load balances the traffic from the hosts that are connected to the host interface ports by using the following load-balancing criteria to select the link:

- For a Layer 2 frame, the switch uses the source and destination MAC addresses.
- For a Layer 3 frame, the switch uses the source and destination MAC addresses and the source and destination IP addresses.

**Note**

A fabric interface that fails in the will not trigger a change to the host interfaces. Traffic is automatically redistributed across the remaining links in the fabric interface.

## Port Numbering Convention

The following port numbering convention is used for the Fabric Extender:

**interface ethernet** *chassis/slot/port*

where

- *chassis* is configured by the administrator. A Fabric Extender must be directly connected to its parent switch via individual fabric interfaces or an EtherChannel fabric interface. You configure a chassis ID on a physical Ethernet interface or EtherChannel on the switch to identify the Fabric Extender discovered through those interfaces.

The chassis ID ranges from 100 to 199.



---

**Note** The chassis ID is required only to access a host interface on the Fabric Extender. A value of less than 100 indicates a slot on the parent switch. The following port numbering convention is used for the interfaces on the switch:

**interface ethernet** *slot/port*

---

- *slot* identifies the slot number on the Fabric Extender.
- *port* identifies the port number on a specific slot and chassis ID.

## Fabric Extender Image Management

No software ships with the Cisco Nexus 2000 Series Fabric Extender. The Fabric Extender image is bundled into the system image of the parent device. The image is automatically verified and updated (if required) during the association process between the parent device and the Fabric Extender.

When you enter the **install all** command, it upgrade the software on the parent device and also upgrades the software on any attached Fabric Extender. To minimize downtime as much as possible, the Fabric Extender remains online while the installation process loads its new software image. Once the software image has successfully loaded, the parent device and the Fabric Extender both automatically reboot. This process is required to maintain version compatibility between the parent device and the Fabric Extender.

## Fabric Extender Hardware

The Cisco Nexus 2000 Series Fabric Extender architecture allows hardware configurations with various host interface counts and speeds.

## Chassis

The Cisco Nexus 2000 Series Fabric Extender is a 1 RU chassis that is designed for rack mounting. The chassis supports redundant hot-swappable fans and power supplies.

## Ethernet Interfaces

There are models of the Cisco Nexus 2000 Series Fabric Extender:

- The Cisco Nexus 2248TP has 48 100BASE-T/1000Base-T Ethernet host interfaces for its downlink connection to servers or hosts and 4 10-Gigabit Ethernet fabric interfaces with SFP+ interface adapters for its uplink connection to the parent switch.

- The Cisco Nexus 2232PP has 32 10-Gigabit Ethernet host interfaces with SFP+ interface adapters and 8 10-Gigabit Ethernet fabric interfaces with SFP+ interface adapters for its uplink connection to the parent switch.

## Information About Associating a Fabric Extender to a Fabric Interface

A Cisco Nexus 2000 Series Fabric Extender is connected to its parent device through physical Ethernet interfaces or a. By default, the parent device does not allow the attached Fabric Extender to connect until it has been assigned a FEX-number and is associated with the connected interface.



### Note

You must enable the Fabric Extender feature with the **feature fex** comand before you can configure and use a Fabric Extender connected to the parent switch.

## Associating a Fabric Extender to an Ethernet Interface

You can associate the Fabric Extender to an Ethernet interface.

### Before You Begin

Ensure that you have enabled the Fabric Extender feature.

### SUMMARY STEPS

1. switch# **configure terminal**
2. switch(config)# **interface ethernet slot/port**
3. switch(config-if)# **switchport mode fex-fabric**
4. switch(config-if)# **fex associate FEX-number**
5. (Optional) switch# **show interface ethernet port/slot fex-intf**

### DETAILED STEPS

|               | Command or Action                                    | Purpose                                                                                                                          |
|---------------|------------------------------------------------------|----------------------------------------------------------------------------------------------------------------------------------|
| <b>Step 1</b> | switch# <b>configure terminal</b>                    | Enters configuration mode.                                                                                                       |
| <b>Step 2</b> | switch(config)# <b>interface ethernet slot/port</b>  | Specifies an Ethernet interface to configure.                                                                                    |
| <b>Step 3</b> | switch(config-if)# <b>switchport mode fex-fabric</b> | Sets the interface to support an external Fabric Extender.                                                                       |
| <b>Step 4</b> | switch(config-if)# <b>fex associate FEX-number</b>   | Associates the FEX-number to the Fabric Extender unit attached to the interface. The range of the FEX-number is from 100 to 199. |

|        | Command or Action                                                | Purpose                                                                               |
|--------|------------------------------------------------------------------|---------------------------------------------------------------------------------------|
| Step 5 | switch# <b>show interface ethernet <i>port/slot</i> fex-intf</b> | (Optional)<br>Displays the association of a Fabric Extender to an Ethernet interface. |

This example shows how to associate the Fabric Extender to an Ethernet interface on the parent device:

```
switch# configure terminal
switch(config)# interface ethernet 1/40
switch(config-if)# switchport mode fex-fabric
switch(config-if)# fex associate 100
```

This example shows how to display the association of the Fabric Extender and the parent device:

```
switch# show interface ethernet 1/40 fex-intf
Fabric          FEX
Interface       Interfaces
-----
Eth1/40         Eth100/1/48  Eth100/1/47  Eth100/1/46  Eth100/1/45
                Eth100/1/44  Eth100/1/43  Eth100/1/42  Eth100/1/41
                Eth100/1/40  Eth100/1/39  Eth100/1/38  Eth100/1/37
                Eth100/1/36  Eth100/1/35  Eth100/1/34  Eth100/1/33
                Eth100/1/32  Eth100/1/31  Eth100/1/30  Eth100/1/29
                Eth100/1/28  Eth100/1/27  Eth100/1/26  Eth100/1/25
                Eth100/1/24  Eth100/1/23  Eth100/1/22  Eth100/1/21
                Eth100/1/20  Eth100/1/19  Eth100/1/18  Eth100/1/17
                Eth100/1/16  Eth100/1/15  Eth100/1/14  Eth100/1/13
                Eth100/1/12  Eth100/1/11  Eth100/1/10  Eth100/1/9
                Eth100/1/8   Eth100/1/7   Eth100/1/6   Eth100/1/5
                Eth100/1/4   Eth100/1/3   Eth100/1/2   Eth100/1/1
```

## Associating a Fabric Extender to a

You can associate the Fabric Extender to an EtherChannel.

### Before You Begin

Ensure that you have enabled the Fabric Extender feature.

### SUMMARY STEPS

1. switch# **configure terminal**
2. switch(config)# **interface port-channel *channel***
3. switch(config-if)# **switchport mode fex-fabric**
4. switch(config-if)# **fex associate *FEX-number***
5. (Optional) switch# **show interface port-channel *channel* fex-intf**

### DETAILED STEPS

|        | Command or Action                 | Purpose                    |
|--------|-----------------------------------|----------------------------|
| Step 1 | switch# <b>configure terminal</b> | Enters configuration mode. |

|               | Command or Action                                                            | Purpose                                                                                                                          |
|---------------|------------------------------------------------------------------------------|----------------------------------------------------------------------------------------------------------------------------------|
| <b>Step 2</b> | switch(config)# <b>interface port-channel</b> <i>channel</i>                 | Specifies a to configure.                                                                                                        |
| <b>Step 3</b> | switch(config-if)# <b>switchport mode fex-fabric</b>                         | Sets the to support an external Fabric Extender.                                                                                 |
| <b>Step 4</b> | switch(config-if)# <b>fex associate</b> <i>FEX-number</i>                    | Associates the FEX-number to the Fabric Extender unit attached to the interface. The range of the FEX-number is from 100 to 199. |
| <b>Step 5</b> | switch# <b>show interface port-channel</b> <i>channel</i><br><b>fex-intf</b> | (Optional)<br>Displays the association of a Fabric Extender to a interface.                                                      |

This example shows how to associate the Fabric Extender to a interface on the parent device:

```
switch# configure terminal
switch(config)# interface port-channel 4
switch(config-if)# switchport mode fex-fabric
switch(config-if)# fex associate 100
switch(config-if)# exit
switch(config)# interface ethernet 1/37
switch(config-if)# switchport mode fex-fabric
switch(config-if)# fex associate 100
switch(config-if)# channel-group 4
switch(config-if)# exit
switch(config)# interface ethernet 1/38
switch(config-if)# switchport mode fex-fabric
switch(config-if)# fex associate 100
switch(config-if)# channel-group 4
switch(config-if)# exit
switch(config)# interface ethernet 1/39
switch(config-if)# switchport mode fex-fabric
switch(config-if)# fex associate 100
switch(config-if)# channel-group 4
switch(config-if)# exit
switch(config)# interface ethernet 1/40
switch(config-if)# switchport mode fex-fabric
switch(config-if)# fex associate 100
switch(config-if)# channel-group 4
```

**Note**

You have to associate each Ethernet interface that is a member of the as a fabric interface as shown in the above example.

This example shows how to display the association of the Fabric Extender and the parent device:

```
switch# show interface port-channel 4 fex-intf
Fabric          FEX
Interface      Interfaces
-----
Po4            Eth100/1/48  Eth100/1/47  Eth100/1/46  Eth100/1/45
                Eth100/1/44  Eth100/1/43  Eth100/1/42  Eth100/1/41
                Eth100/1/40  Eth100/1/39  Eth100/1/38  Eth100/1/37
                Eth100/1/36  Eth100/1/35  Eth100/1/34  Eth100/1/33
                Eth100/1/32  Eth100/1/31  Eth100/1/30  Eth100/1/29
                Eth100/1/28  Eth100/1/27  Eth100/1/26  Eth100/1/25
                Eth100/1/24  Eth100/1/23  Eth100/1/22  Eth100/1/21
                Eth100/1/20  Eth100/1/19  Eth100/1/18  Eth100/1/17
                Eth100/1/16  Eth100/1/15  Eth100/1/14  Eth100/1/13
                Eth100/1/12  Eth100/1/11  Eth100/1/10  Eth100/1/9
                Eth100/1/8   Eth100/1/7   Eth100/1/6   Eth100/1/5
                Eth100/1/4   Eth100/1/3   Eth100/1/2   Eth100/1/1
```

## Disassociating a Fabric Extender From an Interface

You can disassociate the Fabric Extender from an interface.

### Before You Begin

Ensure that you have enabled the Fabric Extender feature.

### SUMMARY STEPS

1. switch# **configure terminal**
2. switch(config)# **interface** {*ethernet slot/port* | **port-channel channel**}
3. switch(config-if)# **no fex associate**

### DETAILED STEPS

|               | Command or Action                                                                            | Purpose                                                                                |
|---------------|----------------------------------------------------------------------------------------------|----------------------------------------------------------------------------------------|
| <b>Step 1</b> | switch# <b>configure terminal</b>                                                            | Enters configuration mode.                                                             |
| <b>Step 2</b> | switch(config)# <b>interface</b> { <i>ethernet slot/port</i>   <b>port-channel channel</b> } | Specifies the interface to configure. The interface can be an Ethernet interface or a. |
| <b>Step 3</b> | switch(config-if)# <b>no fex associate</b>                                                   | Disassociates the Fabric Extender unit attached to the interface.                      |

## Configuring Fabric Extender Global Features

You can configure global features for a Fabric Extender.

### Before You Begin

Ensure that you have enabled the Fabric Extender feature.

### SUMMARY STEPS

1. switch# **configure terminal**
2. switch(config)# **fex** *FEX-number*
3. (Optional) switch(config-fex)# **description** *desc*
4. (Optional) switch(config-fex)# **no description**
5. (Optional) switch(config-fex)# **type** *FEX-type*
6. (Optional) switch(config-fex)# **no type**
7. (Optional) switch(config-fex)# **pinning max-links** *uplinks*
8. (Optional) switch(config-fex)# **no pinning max-links**
9. (Optional) switch(config-fex)# **serial** *serial*
10. (Optional) switch(config-fex)# **no serial**

## DETAILED STEPS

|               | Command or Action                                    | Purpose                                                                                                                                                                                                                                                                                                                                                                                                                                                                                                                                                                                                                                                                     |
|---------------|------------------------------------------------------|-----------------------------------------------------------------------------------------------------------------------------------------------------------------------------------------------------------------------------------------------------------------------------------------------------------------------------------------------------------------------------------------------------------------------------------------------------------------------------------------------------------------------------------------------------------------------------------------------------------------------------------------------------------------------------|
| <b>Step 1</b> | switch# <b>configure terminal</b>                    | Enters configuration mode.                                                                                                                                                                                                                                                                                                                                                                                                                                                                                                                                                                                                                                                  |
| <b>Step 2</b> | switch(config)# <b>fex FEX-number</b>                | Enters configuration mode for the specified Fabric Extender. The range of the FEX-number is from 100 to 199.                                                                                                                                                                                                                                                                                                                                                                                                                                                                                                                                                                |
| <b>Step 3</b> | switch(config-fex)# <b>description desc</b>          | (Optional)<br>Specifies the description. The default is the string FEXxxxx where xxxx is the FEX-number. If the FEX-number is 123, the description is FEX0123.                                                                                                                                                                                                                                                                                                                                                                                                                                                                                                              |
| <b>Step 4</b> | switch(config-fex)# <b>no description</b>            | (Optional)<br>Deletes the description.                                                                                                                                                                                                                                                                                                                                                                                                                                                                                                                                                                                                                                      |
| <b>Step 5</b> | switch(config-fex)# <b>type FEX-type</b>             | (Optional)<br>Specifies the type of Fabric Extender. The FEX-type is one of <b>N2148T</b> for the 48 1000BASE-T Ethernet host interfaces and 4 10-Gigabit Ethernet fabric interfaces module, <b>N2232P</b> for the 32 10-Gigabit Ethernet host interfaces and 4 10-Gigabit Ethernet fabric interfaces module, or <b>N2248T</b> for the 48 100Base-T/1000BASE-T Ethernet host interfaces and 4 10-Gigabit Ethernet fabric interfaces module<br><br>The parent device remembers the type of the Fabric Extender in its binary configuration. When this feature is configured, the Fabric Extender is only allowed to come online if its type matches the configured FEX-type. |
| <b>Step 6</b> | switch(config-fex)# <b>no type</b>                   | (Optional)<br>Deletes the FEX-type. In this case, when a Fabric Extender is connected to the fabric interfaces and does not match the configured type previously saved in the binary configuration on the parent device, all configurations for all interfaces on the Fabric Extender are deleted.                                                                                                                                                                                                                                                                                                                                                                          |
| <b>Step 7</b> | switch(config-fex)# <b>pinning max-links uplinks</b> | (Optional)<br>Defines the number of uplinks. The default is 1. The range is from 1 to 4.<br><br>This command is only applicable if the Fabric Extender is connected to its parent switch using one or more statically pinned fabric interfaces. There can only be one EtherChannel connection.<br><br><b>Caution</b> Changing the number of uplinks with the <b>pinning max-links</b> command disrupts all the host interface ports of the Fabric Extender.                                                                                                                                                                                                                 |
| <b>Step 8</b> | switch(config-fex)# <b>no pinning max-links</b>      | (Optional)<br>Resets the number of uplinks to the default.<br><br><b>Caution</b> Changing the number of uplinks with the <b>no pinning max-links</b> command disrupts all the host interface ports of the Fabric Extender.                                                                                                                                                                                                                                                                                                                                                                                                                                                  |
| <b>Step 9</b> | switch(config-fex)# <b>serial serial</b>             | (Optional)<br>Defines a serial number string. If this command is configured, then a switch will only allow the corresponding chassis ID to associate (using the <b>fex associate</b> command) if the Fabric Extender reports a matching serial number string.<br><br><b>Caution</b> Configuring a serial number other than that of the given Fabric Extender will force the Fabric Extender offline.                                                                                                                                                                                                                                                                        |

|         | Command or Action                    | Purpose                                         |
|---------|--------------------------------------|-------------------------------------------------|
| Step 10 | switch(config-fex)# <b>no serial</b> | (Optional)<br>Deletes the serial number string. |

## Enabling the Fabric Extender Locator LED

You can toggle on the locator beacon LED. It allows you to locate a specific Fabric Extender in a rack.

### SUMMARY STEPS

1. switch# **locator-led fex** *FEX-number*
2. (Optional) switch# **no locator-led fex** *FEX-number*

### DETAILED STEPS

|        | Command or Action                                   | Purpose                                                                        |
|--------|-----------------------------------------------------|--------------------------------------------------------------------------------|
| Step 1 | switch# <b>locator-led fex</b> <i>FEX-number</i>    | Turns on the locator beacon LED for a specific Fabric Extender.                |
| Step 2 | switch# <b>no locator-led fex</b> <i>FEX-number</i> | (Optional)<br>Turns off the locator beacon LED for a specific Fabric Extender. |

## Redistributing the Links

When you provision the Fabric Extender with statically pinned interfaces, the downlink host interfaces on the Fabric Extender are pinned to the fabric interfaces in the order they were initially configured. If you want to maintain a specific relationship of host interfaces to fabric interface across reboots, you should repin the links.

You may want to perform this function in these two situations:

- A change in the max-links configuration.
- If you need to maintain the pinning order of host interfaces to fabric interfaces.

## Changing the Number of Links

If you initially configured a specific port on the parent switch, for example port 33, as your only fabric interface, all 48 host interfaces are pinned to this port. If you provision another port, for example 35, then you must enter the **pinning max-links 2** command to redistribute the host interfaces. All host interfaces are brought down and host interfaces 1 to 24 are pinned to fabric interface 33 and host interfaces 25 to 48 are pinned to fabric interface 35.

## Maintaining the Pinning Order

The pinning order of the host interfaces is initially determined by the order in which the fabric interfaces were configured. In this example, four fabric interfaces were configured in the following order:

```
switch# show interface ethernet 1/35 fex-intf
Fabric          FEX
Interface       Interfaces
-----
Eth1/35         Eth100/1/12  Eth100/1/11  Eth100/1/10  Eth100/1/9
                  Eth100/1/8   Eth100/1/7   Eth100/1/6   Eth100/1/5
                  Eth100/1/4   Eth100/1/3   Eth100/1/2   Eth100/1/1

switch# show interface ethernet 1/33 fex-intf
Fabric          FEX
Interface       Interfaces
-----
Eth1/33         Eth100/1/24  Eth100/1/23  Eth100/1/22  Eth100/1/21
                  Eth100/1/20  Eth100/1/19  Eth100/1/18  Eth100/1/17
                  Eth100/1/16  Eth100/1/15  Eth100/1/14  Eth100/1/13

switch# show interface ethernet 1/38 fex-intf
Fabric          FEX
Interface       Interfaces
-----
Eth1/38         Eth100/1/36  Eth100/1/35  Eth100/1/34  Eth100/1/33
                  Eth100/1/32  Eth100/1/31  Eth100/1/30  Eth100/1/29
                  Eth100/1/28  Eth100/1/27  Eth100/1/26  Eth100/1/25

switch# show interface ethernet 1/40 fex-intf
Fabric          FEX
Interface       Interfaces
-----
Eth1/40         Eth100/1/48  Eth100/1/47  Eth100/1/46  Eth100/1/45
                  Eth100/1/44  Eth100/1/43  Eth100/1/42  Eth100/1/41
                  Eth100/1/40  Eth100/1/39  Eth100/1/38  Eth100/1/37
```

The next time that you reboot the Fabric Extender, the configured fabric interfaces are pinned to the host interfaces in an ascending order by port number of the fabric interface. If you want to configure the same fixed distribution of host interfaces without restarting the Fabric Extender, enter the **fex pinning redistribute** command.

## Redistributing Host Interfaces

You can redistribute the host interfaces on the Fabric Extender. Enter the **fex pinning redistribute** *FEX-number* command to redistribute the host connections. The range of the FEX-number is from 100 to 199.

This example shows how to redistribute the host interfaces on a Fabric Extender:

```
switch# fex pinning redistribute 100
```



### Caution

The **fex pinning redistribute** command disrupts all the host interface ports of the Fabric Extender.

## Verifying Fabric Extender Configuration

Use the following commands to display configuration information about the defined interfaces on a Fabric Extender:

| Command or Action                                                      | Purpose                                                                                                            |
|------------------------------------------------------------------------|--------------------------------------------------------------------------------------------------------------------|
| switch# <b>show fex</b> [ <i>FEX-number</i> [ <b>detail</b> ]]         | Displays information about a specific Fabric Extender or all attached units.                                       |
| switch# <b>show interface type number fex-intf</b>                     | Displays the Fabric Extender ports that are pinned to a specific switch interface.                                 |
| switch# <b>show interface fex-fabric</b>                               | Displays the switch interfaces that have detected a Fabric Extender uplink.                                        |
| switch# <b>show interface ethernet number transceiver [fex-fabric]</b> | Displays the SFP+ transceiver and diagnostic optical monitoring (DOM) information for the Fabric Extender uplinks. |

This example shows how to display all the attached Fabric Extender units:

```
switch# show fex
      FEX      FEX      FEX      FEX
      Number  Description  State      Model      Serial
-----
100    FEX0100      Online    N2K-C2248TP-1GE  JAF1339BDSK
101    FEX0101      Online    N2K-C2232P-10GE  JAF1333ADDD
102    FEX0102      Online    N2K-C2232P-10GE  JAS12334ABC
```

This example shows how to display the detailed status of a specific Fabric Extender:

```
switch# show fex 100 detail
FEX: 100 Description: FEX0100 state: Online
FEX version: 4.2(1)N1(1) [Switch version: 4.2(1)N1(1)]
FEX Interim version: 4.2(1)N1(0.243)
Switch Interim version: 4.2(1)N1(0.243)
Extender Model: N2K-C2248TP-1GE, Extender Serial: JAF1339BDSK
Part No: 73-12748-01
Card Id: 83, Mac Addr: 00:0d:ec:e3:28:02, Num Macs: 64
Module Sw Gen: 21 [Switch Sw Gen: 21]
post level: bypass
pinning-mode: static Max-links: 1
Fabric port for control traffic: Eth1/29
Fabric interface state:
  Po100 - Interface Up. State: Active
  Eth1/29 - Interface Up. State: Active
  Eth1/30 - Interface Up. State: Active
Fex Port      State  Fabric Port  Primary Fabric
Eth100/1/1    Up     Po100        Po100
Eth100/1/2    Up     Po100        Po100
Eth100/1/3    Up     Po100        Po100
Eth100/1/4    Up     Po100        Po100
Eth100/1/5    Up     Po100        Po100
Eth100/1/6    Up     Po100        Po100
Eth100/1/7    Up     Po100        Po100
Eth100/1/8    Up     Po100        Po100
Eth100/1/9    Up     Po100        Po100
Eth100/1/10   Up     Po100        Po100
Eth100/1/11   Up     Po100        Po100
Eth100/1/12   Up     Po100        Po100
Eth100/1/13   Up     Po100        Po100
Eth100/1/14   Up     Po100        Po100
Eth100/1/15   Up     Po100        Po100
Eth100/1/16   Up     Po100        Po100
Eth100/1/17   Up     Po100        Po100
Eth100/1/18   Up     Po100        Po100
Eth100/1/19   Up     Po100        Po100
Eth100/1/20   Up     Po100        Po100
Eth100/1/21   Up     Po100        Po100
```

```

Eth100/1/22    Up        Po100    Po100
Eth100/1/23    Up        Po100    Po100
Eth100/1/24    Up        Po100    Po100
Eth100/1/25    Up        Po100    Po100
Eth100/1/26    Up        Po100    Po100
Eth100/1/27    Up        Po100    Po100
Eth100/1/28    Up        Po100    Po100
Eth100/1/29    Up        Po100    Po100
Eth100/1/30    Up        Po100    Po100
Eth100/1/31    Up        Po100    Po100
Eth100/1/32    Up        Po100    Po100
Eth100/1/33    Up        Po100    Po100
Eth100/1/34    Up        Po100    Po100
Eth100/1/35    Up        Po100    Po100
Eth100/1/36    Up        Po100    Po100
Eth100/1/37    Up        Po100    Po100
Eth100/1/38    Up        Po100    Po100
Eth100/1/39    Up        Po100    Po100
Eth100/1/40    Down      Po100    Po100
Eth100/1/41    Up        Po100    Po100
Eth100/1/42    Up        Po100    Po100
Eth100/1/43    Up        Po100    Po100
Eth100/1/44    Up        Po100    Po100
Eth100/1/45    Up        Po100    Po100
Eth100/1/46    Up        Po100    Po100
Eth100/1/47    Up        Po100    Po100
Eth100/1/48    Up        Po100    Po100

```

## Logs:

```

02/05/2010 20:12:17.764153: Module register received
02/05/2010 20:12:17.765408: Registration response sent
02/05/2010 20:12:17.845853: Module Online Sequence
02/05/2010 20:12:23.447218: Module Online

```

This example shows how to display the Fabric Extender interfaces pinned to a specific switch interface:

```

switch# show interface port-channel 100 fex-intf
Fabric                               FEX
Interface                             Interfaces
-----
Po100                                Eth100/1/48  Eth100/1/47  Eth100/1/46  Eth100/1/45
                                       Eth100/1/44  Eth100/1/43  Eth100/1/42  Eth100/1/41
                                       Eth100/1/40  Eth100/1/39  Eth100/1/38  Eth100/1/37
                                       Eth100/1/36  Eth100/1/35  Eth100/1/34  Eth100/1/33
                                       Eth100/1/32  Eth100/1/31  Eth100/1/30  Eth100/1/29
                                       Eth100/1/28  Eth100/1/27  Eth100/1/26  Eth100/1/25
                                       Eth100/1/24  Eth100/1/22  Eth100/1/20  Eth100/1/19
                                       Eth100/1/18  Eth100/1/17  Eth100/1/16  Eth100/1/15
                                       Eth100/1/14  Eth100/1/13  Eth100/1/12  Eth100/1/11
                                       Eth100/1/10  Eth100/1/9   Eth100/1/8   Eth100/1/7
                                       Eth100/1/6   Eth100/1/5   Eth100/1/4   Eth100/1/3
                                       Eth100/1/2   Eth100/1/1

```

This example shows how to display the switch interfaces that are connected to a Fabric Extender uplink:

```

switch# show interface fex-fabric
Fabric Fabric Fex FEX
Fex Port Port State Uplink Model Serial
-----
100 Eth1/29 Active 3 N2K-C2248TP-1GE JAF1339BDSK
100 Eth1/30 Active 4 N2K-C2248TP-1GE JAF1339BDSK
102 Eth1/33 Active 1 N2K-C2232P-10GE JAS12334ABC
102 Eth1/34 Active 2 N2K-C2232P-10GE JAS12334ABC
102 Eth1/35 Active 3 N2K-C2232P-10GE JAS12334ABC
102 Eth1/36 Active 4 N2K-C2232P-10GE JAS12334ABC
101 Eth1/37 Active 5 N2K-C2232P-10GE JAF1333ADDD
101 Eth1/38 Active 6 N2K-C2232P-10GE JAF1333ADDD
101 Eth1/39 Active 7 N2K-C2232P-10GE JAF1333ADDD
101 Eth1/40 Active 8 N2K-C2232P-10GE JAF1333ADDD

```



**Note**

The above example shows a Fabric Extender with four uplink connections, only one of which is currently active.

This example shows how to display the SFP+ transceiver and diagnostic optical monitoring (DOM) information for Fabric Extender uplinks for an SFP+ transceiver that is plugged into the parent switch interface:

```
switch# show interface ethernet 1/40 transceiver
Ethernet1/40
  sfp is present
  name is CISCO-MOLEX INC
  part number is 74752-9026
  revision is A0
  serial number is MOC13321057
  nominal bitrate is 12000 Mbits/sec
  Link length supported for copper is 3 m(s)
  cisco id is --
  cisco extended id number is 4
```

This example shows how to display the SFP+ transceiver and DOM information for Fabric Extender uplinks for an SFP+ transceiver that is plugged into the uplink port on the Fabric Extender:

```
switch# show interface ethernet 1/40 transceiver fex-fabric
Ethernet1/40
  sfp is present
  name is CISCO-MOLEX INC
  part number is 74752-9026
  revision is A0
  serial number is MOC13321057
  nominal bitrate is 12000 Mbits/sec
  Link length supported for 50/125mm fiber is 0 m(s)
  Link length supported for 62.5/125mm fiber is 0 m(s)
  cisco id is --
  cisco extended id number is 4
```

## Verifying Chassis Management Information

Use the following commands to display configuration information used on the switch supervisor to manage the Fabric Extender:

| Command or Action                                                                                                    | Purpose                                                                  |
|----------------------------------------------------------------------------------------------------------------------|--------------------------------------------------------------------------|
| switch# <b>show diagnostic result fex</b> <i>FEX-number</i>                                                          | Displays results from the diagnostic test for a Fabric Extender.         |
| switch# <b>show environment fex</b> {all   <i>FEX-number</i> }<br>[ <b>temperature</b>   <b>power</b>   <b>fan</b> ] | Displays the environmental sensor status.                                |
| switch# <b>show inventory fex</b> <i>FEX-number</i>                                                                  | Displays inventory information for a Fabric Extender.                    |
| switch# <b>show module fex</b> [ <i>FEX-number</i> ]                                                                 | Displays module information about a Fabric Extender.                     |
| switch# <b>show sprom fex</b> <i>FEX-number</i> {all   <b>backplane</b>   <b>powersupply</b> <i>ps-num</i> }   all   | Displays the contents of the serial PROM (SPROM) on the Fabric Extender. |

This example shows how to display the module information about all connected Fabric Extender units:

```
switch# show module fex
FEX Mod Ports Card Type Model Status.
-----
100 1 48 Fabric Extender 48x1GE + 4x10G Mod N2K-C2248TP-1GE present
101 1 32 Fabric Extender 32x10GE + 8x10G Mo N2K-C2232P-10GE present
102 1 32 Fabric Extender 32x10GE + 8x10G Mo N2K-C2232P-10GE present

FEX Mod Sw Hw World-Wide-Name(s) (WWN)
-----
100 1 4.2(1)N1(1) 0.103 --
101 1 4.2(1)N1(1) 1.0 --
102 1 4.2(1)N1(1) 1.0 --

FEX Mod MAC-Address(es) Serial-Num
-----
100 1 000d.ece3.2800 to 000d.ece3.282f JAF1339BDSK
101 1 000d.ecca.73c0 to 000d.ecca.73df JAF1333ADDD
102 1 000d.ecd6.bec0 to 000d.ecd6.bedf JAS12334ABC
```

This example shows how to display the module information about a specific Fabric Extender:

```
switch# show module fex 100
FEX Mod Ports Card Type Model Status.
-----
110 1 48 Fabric Extender 48x1GE + 4x10G Mod N2K-C2248TP-1GE present

FEX Mod Sw Hw World-Wide-Name(s) (WWN)
-----
110 1 4.2(1)N1(1) 0.103 --

FEX Mod MAC-Address(es) Serial-Num
-----
110 1 000d.ece3.2800 to 000d.ece3.282f JAF1339BDSK
```

This example shows how to display the inventory information about a specific Fabric Extender:

```
switch# show inventory fex 100
NAME: "FEX 100 CHASSIS", DESCR: "N2K-C2248TP-1GE CHASSIS"
PID: N2K-C2248TP-1GE , VID: V00 , SN: SSI13380FSM

NAME: "FEX 100 Module 1", DESCR: "Fabric Extender Module: 48x1GE, 4x10GE Supervisor"
PID: N2K-C2248TP-1GE , VID: V00 , SN: JAF1339BDSK

NAME: "FEX 100 Fan 1", DESCR: "Fabric Extender Fan module"
PID: N2K-C2248-FAN , VID: N/A , SN: N/A

NAME: "FEX 100 Power Supply 2", DESCR: "Fabric Extender AC power supply"
PID: NXK-PAC-400W , VID: 000, SN: LIT13370QD6
```

This example shows how to display diagnostic test results for a specific Fabric Extender:

```
switch# show diagnostic result fex 100
FEX-100: 48x1GE/Supervisor SerialNo : JAF1339BDSK
Overall Diagnostic Result for FEX-100 : OK

Test results: (. = Pass, F = Fail, U = Untested)
TestPlatform:
0) SPROM: -----> .
1) Inband interface: -----> .
2) Fan: -----> .
3) Power Supply: -----> .
4) Temperature Sensor: -----> .

TestForwardingPorts:
Eth 1 2 3 4 5 6 7 8 9 10 11 12 13 14 15 16 17 18 19 20 21 22 23 24
Port -----
. . . . .

Eth 25 26 27 28 29 30 31 32 33 34 35 36 37 38 39 40 41 42 43 44 45 46 47 48
Port -----
```

```

TestFabricPorts:
Fabric 1 2 3 4
Port -----
. . . . .
    
```

This example shows how to display the environment status for a specific Fabric Extender:

```
switch# show environment fex 100
```

```
Temperature Fex 100:
```

| Module | Sensor   | MajorThresh<br>(Celsius) | MinorThres<br>(Celsius) | CurTemp<br>(Celsius) | Status |
|--------|----------|--------------------------|-------------------------|----------------------|--------|
| 1      | Outlet-1 | 60                       | 50                      | 33                   | ok     |
| 1      | Outlet-2 | 60                       | 50                      | 38                   | ok     |
| 1      | Inlet-1  | 50                       | 40                      | 35                   | ok     |
| 1      | Die-1    | 100                      | 90                      | 44                   | ok     |

```
Fan Fex: 100:
```

| Fan     | Model         | Hw | Status  |
|---------|---------------|----|---------|
| Chassis | N2K-C2148-FAN | -- | failure |
| PS-1    | --            | -- | absent  |
| PS-2    | NXK-PAC-400W  | -- | ok      |

```
Power Supply Fex 100:
```

```
Voltage: 12 Volts
```

| PS | Model        | Power<br>(Watts) | Power<br>(Amp) | Status |
|----|--------------|------------------|----------------|--------|
| 1  | --           | --               | --             | --     |
| 2  | NXK-PAC-400W | 4.32             | 0.36           | ok     |

| Mod | Model           | Power<br>Requested<br>(Watts) | Power<br>Requested<br>(Amp) | Power<br>Allocated<br>(Watts) | Power<br>Allocated<br>(Amp) | Status     |
|-----|-----------------|-------------------------------|-----------------------------|-------------------------------|-----------------------------|------------|
| 1   | N2K-C2248TP-1GE | 0.00                          | 0.00                        | 0.00                          | 0.00                        | powered-up |

```
Power Usage Summary:
```

```

Power Supply redundancy mode:                redundant

Total Power Capacity                          4.32 W

Power reserved for Supervisor(s)              0.00 W
Power currently used by Modules                0.00 W

Total Power Available                          4.32 W
    
```

This example shows how to display the SPROM for a specific Fabric Extender:

```

switch# show sprom fex 100 all
DISPLAY FEX 100 SUP sprom contents
Common block:
Block Signature : 0xabab
Block Version   : 3
Block Length    : 160
Block Checksum  : 0x1a1e
    
```

```

EEPROM Size      : 65535
Block Count      : 3
FRU Major Type   : 0x6002
FRU Minor Type   : 0x0
OEM String       : Cisco Systems, Inc.
Product Number   : N2K-C2248TP-1GE
Serial Number    : JAF1339BDSK
Part Number      : 73-12748-01
Part Revision    : 11
Mfg Deviation    : 0
H/W Version      : 0.103
Mfg Bits         : 0
Engineer Use     : 0
snmpOID          : 9.12.3.1.9.78.3.0
Power Consump    : 1666
RMA Code         : 0-0-0-0
CLEI Code        : XXXXXXXXXXXTBDV00
VID              : V00
Supervisor Module specific block:
Block Signature  : 0x6002
Block Version    : 2
Block Length     : 103
Block Checksum   : 0x2686
Feature Bits     : 0x0
HW Changes Bits  : 0x0
Card Index       : 11016
MAC Addresses    : 00-00-00-00-00-00
Number of MACs   : 0
Number of EPLD   : 0
Port Type-Num    : 1-48;2-4
Sensor #1        : 60,50
Sensor #2        : 60,50
Sensor #3        : -128,-128
Sensor #4        : -128,-128
Sensor #5        : 50,40
Sensor #6        : -128,-128
Sensor #7        : -128,-128
Sensor #8        : -128,-128
Max Connector Power: 4000
Cooling Requirement: 65
Ambient Temperature: 40

```

## DISPLAY FEX 100 backplane srom contents:

```

Common block:
Block Signature  : 0xabab
Block Version    : 3
Block Length     : 160
Block Checksum   : 0x1947
EEPROM Size      : 65535
Block Count      : 5
FRU Major Type   : 0x6001
FRU Minor Type   : 0x0
OEM String       : Cisco Systems, Inc.
Product Number   : N2K-C2248TP-1GE
Serial Number    : SSI13380FSM
Part Number      : 68-3601-01
Part Revision    : 03
Mfg Deviation    : 0
H/W Version      : 1.0
Mfg Bits         : 0
Engineer Use     : 0
snmpOID          : 9.12.3.1.3.914.0.0
Power Consump    : 0
RMA Code         : 0-0-0-0
CLEI Code        : XXXXXXXXXXXTDBV00
VID              : V00
Chassis specific block:
Block Signature  : 0x6001
Block Version    : 3
Block Length     : 39
Block Checksum   : 0x2cf
Feature Bits     : 0x0
HW Changes Bits  : 0x0

```



```
Power supply specific block:  
Block Signature : 0x0  
Block Version   : 0  
Block Length    : 0  
Block Checksum  : 0x0  
Feature Bits    : 0x0  
Current 110v   : 36  
Current 220v   : 36  
Stackmib OID   : 0
```



## INDEX

10-Gigabit Ethernet interface [205](#)  
1000BASE-T Ethernet interface [205](#)  
100BASE-T Ethernet interface [205](#)

### A

associating fabric extender [206](#)

### B

blocking state, STP [118](#)  
BPDU guard [162](#)  
BPDU Guard [197, 202](#)  
bridge ID [108](#)  
broadcast storms [191](#)

### C

CDP [197](#)  
changed information  
  description [1](#)  
changing max-links [211](#)  
chassis [205](#)  
chassis configuration mode [209](#)  
chassis ID [204](#)  
Cisco Discovery Protocol [197](#)  
Cisco Nexus 2232PP [205](#)  
Cisco Nexus 2248TP [205](#)  
CIST regional root [138](#)  
CIST root [139](#)  
class of service [198](#)  
community ports [34](#)  
community VLANs [34, 35](#)  
configuration data [201](#)  
configuring LACP [70](#)  
CoS [198](#)

### D

debounce timer [11](#)  
description [209](#)  
digital optical monitoring [200](#)  
DOM [200](#)  
drop queue [198](#)

### E

edge port (PortFast) [197](#)  
EtherChannel  
  STP [59](#)  
EtherChannel fabric interface [200](#)  
Ethernet fabric interface [196](#)  
Ethernet interface [205](#)  
extended range VLANs [25](#)

### F

fabric extender [195](#)  
fabric interface [196](#)  
fail-over load balancing [204](#)  
FEX-number [204](#)

### H

host interface [196](#)  
host interface autonegotiation [198](#)  
host interface flow control defaults [198](#)  
host interface link-level flow control [198](#)  
host ports  
  kinds of [34](#)

### I

ICMPv2 [184](#)

IEEE 802.1p **198**  
 IEEE 802.1w **135**  
 IEEE 802.3x **198**  
 IGMP forwarding  
   MAC address **185**  
 IGMP snooping **185, 199**  
   queries **185**  
 IGMPv1 **184**  
 IGMPv3 **185**  
 image management **205**  
 ingress ACL **199**  
 interface speed **10**  
 interfaces  
   chassis ID **7**  
   options **7**  
   UDLD **8**  
 isolated port **34**  
 isolated VLANs **34, 35**

## J

jumbo frame **198**

## L

LACP **59, 64, 70**  
   system ID **64**  
 LED beacon **211**  
 Link Aggregation Control Protocol **59**  
 Link Failure  
   detecting unidirectional **121**  
 local switching **202**  
 locator-led **211**  
 loopback address assignment **201**  
 loopback address range **201**

## M

manual redistribution **203**  
 max-links disruption **203**  
 maximum transmission unit **198**  
 MST  
   CIST regional root **138**  
   setting to default values **146**  
 MSTP  
   boundary ports  
     described **140**  
   CIST regional root **138**  
   CIST root **139**  
   CIST, described **137**

MSTP (*continued*)  
   CST  
     defined **137**  
     operations between regions **138**  
   IEEE 802.1s  
     terminology **138**  
   IST **137, 138**  
     operations within a region **137**  
   mapping VLANs to MST instance **146**  
   MST region  
     CIST **137**  
     described **135**  
     hop-count mechanism **139**  
     supported spanning-tree instances **136**  
 MTU **198**  
 multicast replication **202**  
 multicast storms **191**

## N

new information  
   description **1**  
 no-drop queue **198**

## O

oversubscription **200**  
 oversubscription ratio **200**

## P

packet counter **197**  
 per class flow control **198**  
 PFC **200**  
 pinning max-links **209**  
 port channel **204**  
 port channeling **59**  
 port numbering **204**  
 PortFast BPDU filtering **163**  
 primary VLANs **34**  
 priority flow control **200**  
 private VLAN **198**  
 private VLANs  
   community VLANs **34, 35**  
   end station access to **38**  
   isolated trunk **37**  
   isolated VLANs **34, 35**  
   ports  
     community **34**  
     isolated **34**

private VLANs (*continued*)  
 ports (*continued*)  
   promiscuous 34  
   primary VLANs 34  
   promiscuous trunk 37  
   secondary VLANs 34  
 promiscuous ports 34

## Q

QoS 198  
 QoS broadcast class 198  
 QoS egress policies 198  
 QoS multicast class 198  
 Quality of Service 198

## R

Rapid Spanning Tree Protocol 135  
 redistributing links 212  
 reduced MAC address 108  
 reserved-range VLANs 25  
 root guard 164  
 RSTP 112, 116, 120, 135  
   active topology 116  
   BPDU  
     processing 120  
   designated port, defined 116  
   designated switch, defined 116  
   proposal-agreement handshake process 112  
   rapid convergence 112  
     point-to-point links 112  
     root ports 112  
   root port, defined 116

## S

secondary VLANs 34  
 serial number 209  
 SFP+ 205  
 SFP+ interface adapter 205  
 SFP+ transceiver 10  
 SFP+ validation 200  
 show diagnostics 215  
 show environment 215  
 show Fabric Extender units 212

show fabric interface 212  
 show inventory 215  
 show modules 215  
 show SPROM 215  
 show transceiver status 212  
 single management domain 195  
 Small form-factor pluggable (plus) transceiver 10  
 small form-factor pluggable transceiver 205  
 software installation 195  
 software upgrade 195  
 SPAN restrictions 199  
 SPAN source ports 199  
 static pinning 203  
 STP  
   edge ports 112, 161  
   EtherChannel 59  
   network ports 162  
   normal ports 162  
   port types 161  
   PortFast 112, 161  
   understanding  
     Blocking State 118  
     disabled state 119  
     forwarding state 119  
     learning state 118  
 STP bridge ID 108  
 STP root guard 164  
 switchport fex-fabric mode 200  
 switchport saved configuration 200

## U

UDLD  
   aggressive mode 9  
   defined 8  
   nonaggressive mode 9  
 unicast storms 191  
 Unidirectional Link Detection 8

## V

version compatibility 205  
 VLANs  
   extended range 25  
   reserved range 25  
 vPC topology 198

