



## **Cisco MDS 9000 Series IP Services Configuration Guide, Release 8.x**

First Published: May 03, 2017

Revised: February 18, 2020

**Cisco Systems, Inc.**  
[www.cisco.com](http://www.cisco.com)

Cisco has more than 200 offices worldwide.  
Addresses, phone numbers, and fax numbers  
are listed on the Cisco website at  
[www.cisco.com/go/offices](http://www.cisco.com/go/offices).

THE SPECIFICATIONS AND INFORMATION REGARDING THE PRODUCTS IN THIS MANUAL ARE SUBJECT TO CHANGE WITHOUT NOTICE. ALL STATEMENTS, INFORMATION, AND RECOMMENDATIONS IN THIS MANUAL ARE BELIEVED TO BE ACCURATE BUT ARE PRESENTED WITHOUT WARRANTY OF ANY KIND, EXPRESS OR IMPLIED. USERS MUST TAKE FULL RESPONSIBILITY FOR THEIR APPLICATION OF ANY PRODUCTS.

THE SOFTWARE LICENSE AND LIMITED WARRANTY FOR THE ACCOMPANYING PRODUCT ARE SET FORTH IN THE INFORMATION PACKET THAT SHIPPED WITH THE PRODUCT AND ARE INCORPORATED HEREIN BY THIS REFERENCE. IF YOU ARE UNABLE TO LOCATE THE SOFTWARE LICENSE OR LIMITED WARRANTY, CONTACT YOUR CISCO REPRESENTATIVE FOR A COPY.

The Cisco implementation of TCP header compression is an adaptation of a program developed by the University of California, Berkeley (UCB) as part of UCB's public domain version of the UNIX operating system. All rights reserved. Copyright © 1981, Regents of the University of California.

NOTWITHSTANDING ANY OTHER WARRANTY HEREIN, ALL DOCUMENT FILES AND SOFTWARE OF THESE SUPPLIERS ARE PROVIDED "AS IS" WITH ALL FAULTS. CISCO AND THE ABOVE-NAMED SUPPLIERS DISCLAIM ALL WARRANTIES, EXPRESSED OR IMPLIED, INCLUDING, WITHOUT LIMITATION, THOSE OF MERCHANTABILITY, FITNESS FOR A PARTICULAR PURPOSE AND NONINFRINGEMENT OR ARISING FROM A COURSE OF DEALING, USAGE, OR TRADE PRACTICE.

IN NO EVENT SHALL CISCO OR ITS SUPPLIERS BE LIABLE FOR ANY INDIRECT, SPECIAL, CONSEQUENTIAL, OR INCIDENTAL DAMAGES, INCLUDING, WITHOUT LIMITATION, LOST PROFITS OR LOSS OR DAMAGE TO DATA ARISING OUT OF THE USE OR INABILITY TO USE THIS MANUAL, EVEN IF CISCO OR ITS SUPPLIERS HAVE BEEN ADVISED OF THE POSSIBILITY OF SUCH DAMAGES.

Cisco and the Cisco logo are trademarks or registered trademarks of Cisco and/or its affiliates in the U.S. and other countries. To view a list of Cisco trademarks, go to this URL: [www.cisco.com/go/trademarks](http://www.cisco.com/go/trademarks). Third-party trademarks mentioned are the property of their respective owners. The use of the word partner does not imply a partnership relationship between Cisco and any other company. (1721R)

Any Internet Protocol (IP) addresses and phone numbers used in this document are not intended to be actual addresses and phone numbers. Any examples, command display output, network topology diagrams, and other figures included in the document are shown for illustrative purposes only. Any use of actual IP addresses or phone numbers in illustrative content is unintentional and coincidental.

*Cisco MDS 9000 Family NX-OS IP Services Configuration Guide*  
© 2020 Cisco Systems, Inc. All rights reserved.



## New and Changed Information

---

Table lists the new features in the Cisco MDS 9000 Series IP Services Configuration Guide for Cisco MDS NX-OS Release 8.x.

**Table 1**      ***New and Changed Features***

<b>Feature</b>	<b>Release</b>	<b>Where Documented</b>
Fibre Channel over IP	8.4(2)	<a href="#">Configuring Fibre Channel over IP</a>
Maximum Retransmission Threshold for OBFL Logging	8.2(1)	<a href="#">Maximum Retransmission Threshold for OBFL Logging</a>

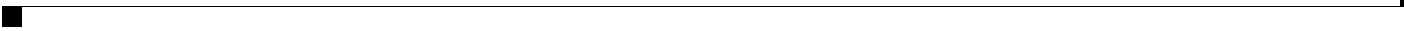



# Preface

---

This preface describes the audience, organization, and conventions of the *Cisco MDS 9000 Series NX-OS IP Services Configuration Guide*. It also provides information on how to obtain related documentation.

## Audience

This guide is for experienced network administrators who are responsible for configuring and maintaining the Cisco MDS 9000 Series of multilayer directors and fabric switches.

## Organization

This guide is organized as follows:

Chapter	Title	Description
<a href="#">Chapter 2</a>	<a href="#">IP Services Overview</a>	Provides an overview of the Intelligent Storage Services supported by the Cisco MDS 9000 NX-OS software.
<a href="#">Chapter 2</a>	<a href="#">Configuring Fibre Channel over IP</a>	Describes how the switch allows IP hosts to access Fibre Channel storage using the iSCSI protocol.
<a href="#">Chapter 3</a>	<a href="#">Configuring the SAN Extension Tuner</a>	Explains the SAN extension tuner (SET) feature that optimizes FCIP performance.
<a href="#">Chapter 4</a>	<a href="#">Configuring Internet Small Computer Systems Interface</a>	Describes the iSCSI feature that is specific to the Fibre Channel module with IPS ports and is available in the Cisco MDS 9200 Switches or Cisco MDS 9500 Directors.
<a href="#">Chapter 5</a>	<a href="#">Configuring IP Services</a>	Provides details on IP over Fibre Channel (IPFC) services and provides configuring IPFC, virtual router, and DNS server configuration information.
<a href="#">Chapter 6</a>	<a href="#">Configuring IP Storage Services</a>	Provides details on extending the reach of Fibre Channel SANs by connecting separated SAN islands together through IP networks using FCIP, and allowing IP hosts to access FC storage using the iSCSI protocol.

Chapter	Title	Description
Chapter 7	<a href="#">Configuring IPv4 for Gigabit Ethernet Interfaces</a>	Describes the IPv4 protocol support provided by Cisco MDS 9000 Family switches.
Chapter 8	<a href="#">Configuring IPv6 for Gigabit Ethernet Interfaces</a>	Describes the IPv6 protocol support provided by Cisco MDS 9000 Family switches.

This guide is organized as follows:

Chapter	Title	Description
Chapter 2	<a href="#">IP Services Overview</a>	Provides an overview of the Intelligent Storage Services supported by the Cisco MDS 9000 NX-OS software.
Chapter 2	<a href="#">Configuring Fibre Channel over IP</a>	Describes how the switch allows IP hosts to access Fibre Channel storage using the iSCSI protocol.
Chapter 3	<a href="#">Configuring the SAN Extension Tuner</a>	Explains the SAN extension tuner (SET) feature that optimizes FCIP performance.
Chapter 4	<a href="#">Configuring Internet Small Computer Systems Interface</a>	Describes the iSCSI feature that is specific to the Fibre Channel module with IPS ports and is available in the Cisco MDS 9200 Switches or Cisco MDS 9500 Directors.
Chapter 5	<a href="#">Configuring IP Services</a>	Provides details on IP over Fibre Channel (IPFC) services and provides configuring IPFC, virtual router, and DNS server configuration information.
Chapter 6	<a href="#">Configuring IP Storage Services</a>	Provides details on extending the reach of Fibre Channel SANs by connecting separated SAN islands together through IP networks using FCIP, and allowing IP hosts to access FC storage using the iSCSI protocol.
Chapter 7	<a href="#">Configuring IPv4 for Gigabit Ethernet Interfaces</a>	Describes the IPv4 protocol support provided by Cisco MDS 9000 Family switches.
Chapter 8	<a href="#">Configuring IPv6 for Gigabit Ethernet Interfaces</a>	Describes the IPv6 protocol support provided by Cisco MDS 9000 Family switches.

## Document Conventions

Command descriptions use these conventions:

<b>boldface font</b>	Commands and keywords are in boldface.
<i>italic font</i>	Arguments for which you supply values are in italics.
[ ]	Elements in square brackets are optional.
[ x   y   z ]	Optional alternative keywords are grouped in brackets and separated by vertical bars.

Screen examples use these conventions:

screen font	Terminal sessions and information the switch displays are in screen font.
<b>boldface screen font</b>	Information you must enter is in boldface screen font.
<i>italic screen font</i>	Arguments for which you supply values are in italic screen font.
< >	Nonprinting characters, such as passwords, are in angle brackets.
[ ]	Default responses to system prompts are in square brackets.
!, #	An exclamation point (!) or a pound sign (#) at the beginning of a line of code indicates a comment line.

This document uses the following conventions:



**Note**

Means reader *take note*. Notes contain helpful suggestions or references to material not covered in the manual.



**Caution**

Means *reader be careful*. In this situation, you might do something that could result in equipment damage or loss of data.

## Related Documentation

The documentation set for the Cisco MDS 9000 Family includes the following documents. To find a document online, use the Cisco MDS NX-OS Documentation Locator at:

[http://www.cisco.com/en/US/docs/storage/san\\_switches/mds9000/roadmaps/doclocator.htm](http://www.cisco.com/en/US/docs/storage/san_switches/mds9000/roadmaps/doclocator.htm)

## Release Notes

- *Cisco MDS 9000 Family Release Notes for Cisco MDS NX-OS Releases*
- *Cisco MDS 9000 Family Release Notes for MDS SAN-OS Releases*
- *Cisco MDS 9000 Family Release Notes for Storage Services Interface Images*
- *Cisco MDS 9000 Family Release Notes for Cisco MDS 9000 EPLD Images*

## Regulatory Compliance and Safety Information

- *Regulatory Compliance and Safety Information for the Cisco MDS 9000 Family*

## Compatibility Information

- *Cisco Data Center Interoperability Support Matrix*
- *Cisco MDS 9000 NX-OS Hardware and Software Compatibility Information and Feature Lists*
- *Cisco MDS NX-OS Release Compatibility Matrix for Storage Service Interface Images*
- *Cisco MDS 9000 Family Switch-to-Switch Interoperability Configuration Guide*

- *Cisco MDS NX-OS Release Compatibility Matrix for IBM SAN Volume Controller Software for Cisco MDS 9000*
- *Cisco MDS SAN-OS Release Compatibility Matrix for VERITAS Storage Foundation for Networks Software*

## Hardware Installation

- *Cisco MDS 9500 Series Hardware Installation Guide*
- *Cisco MDS 9200 Series Hardware Installation Guide*
- *Cisco MDS 9100 Series Hardware Installation Guide*
- *Cisco MDS 9124 and Cisco MDS 9134 Multilayer Fabric Switch Quick Start Guide*

## Software Installation and Upgrade

- *Cisco MDS 9000 NX-OS Release 4.1(x) and SAN-OS 3(x) Software Upgrade and Downgrade Guide*
- *Cisco MDS 9000 Family Storage Services Interface Image Install and Upgrade Guide*
- *Cisco MDS 9000 Family Storage Services Module Software Installation and Upgrade Guide*

## Cisco MDS 9000 NX-OS

- *Cisco MDS 9000 Family NX-OS Licensing Guide*
- *Cisco MDS 9000 Family NX-OS Fundamentals Configuration Guide*
- *Cisco MDS 9000 Family NX-OS System Management Configuration Guide*
- *Cisco MDS 9000 Family NX-OS Interfaces Configuration Guide*
- *Cisco MDS 9000 Family NX-OS Fabric Configuration Guide*
- *Cisco MDS 9000 Family NX-OS Quality of Service Configuration Guide*
- *Cisco MDS 9000 Family NX-OS Security Configuration Guide*
- *Cisco MDS 9000 Family NX-OS IP Services Configuration Guide*
- *Cisco MDS 9000 Family NX-OS Intelligent Storage Services Configuration Guide*
- *Cisco MDS 9000 Family NX-OS High Availability and Redundancy Configuration Guide*
- *Cisco MDS 9000 Family NX-OS Inter-VSAN Routing Configuration Guide*

## Command Reference

- *Cisco MDS 9000 Family Command Reference*

## Intelligent Storage Networking Services Configuration Guides

- *Cisco MDS 9000 I/O Acceleration Configuration Guide*
- *Cisco MDS 9000 Family SANTap Deployment Guide*
- *Cisco MDS 9000 Family Data Mobility Manager Configuration Guide*
- *Cisco MDS 9000 Family Storage Media Encryption Configuration Guide*

- *Cisco MDS 9000 Family Secure Erase Configuration Guide*
- *Cisco MDS 9000 Family Cookbook for Cisco MDS SAN-OS*

## Troubleshooting and Reference

- *Cisco NX-OS System Messages Reference*
- *Cisco MDS 9000 Family NX-OS Troubleshooting Guide*
- *Cisco MDS 9000 Family NX-OS MIB Quick Reference*
- *Cisco MDS 9000 Family NX-OS SMI-S Programming Reference*

## Obtaining Documentation and Submitting a Service Request

For information on obtaining documentation, submitting a service request, and gathering additional information, see *What's New in Cisco Product Documentation* at:  
<http://www.cisco.com/en/US/docs/general/whatsnew/whatsnew.html>.

Subscribe to *What's New in Cisco Product Documentation*, which lists all new and revised Cisco technical documentation, as an RSS feed and deliver content directly to your desktop using a reader application. The RSS feeds are a free service.

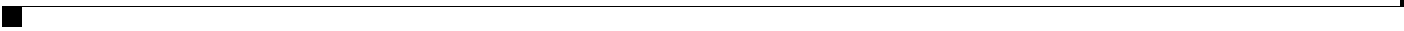



## IP Services Overview

---

The Cisco MDS 9000 NX-OS software provides features such as FCIP, SAN Extension Tuner, iSCSI, IP storage, IPv4, and IPv6 in a single platform. These IP services simplify SAN provisioning by automatically distributing configuration information to all the switches in a storage network. The Virtual Routing Redundancy Protocol (VRRP) increases the IP network availability for iSCSI and FCIP connections by allowing failover of connections from one port to another. The increased IP network availability facilitates the failover of an iSCSI volume from one IP services port to any other IP services port, either locally or on another Cisco MDS 9000 switch.

This chapter includes the following sections:

- [Fibre Channel over IP Protocol, page 2-17](#)
- [SAN Extension Tuner, page 2-17](#)
- [Internet Small Computer Systems Interface, page 2-18](#)
- [IP Services, page 2-18](#)
- [IP Storage, page 2-18](#)
- [IPv4 and IPv6, page 2-18](#)

### Fibre Channel over IP Protocol

Fibre Channel over IP Protocol (FCIP) transparently connects a remote Fibre Channel storage area network (SAN island) by transporting Fibre Channel data from a local SAN to a remote SAN using IP networks. IP network availability for the FCIP connections can be increased by using features such as Virtual Routing Redundancy Protocol (VRRP) and quality of service (QoS). FCIP can be optimized for wire performance through enhancements that address out-of-order delivery issues, support jumbo frames, provide traffic shaping, and perform TCP optimization.

For more information on configuring FCIP, see [Chapter 2, “Configuring Fibre Channel over IP.”](#)

### SAN Extension Tuner

The SAN Extension Tuner (SET) feature helps you optimize FCIP performance by generating Small Computer System Interface (SCSI) I/O commands and directing the traffic to a specific virtual target. SET reports the I/Os per second and I/O latency results, which helps you to determine the number of concurrent I/Os needed to maximize the FCIP throughput.

For information on configuring the SAN Extension Tuner, see [Chapter 3, “Configuring the SAN Extension Tuner.”](#)

## Internet Small Computer Systems Interface

The Internet Small Computer Systems Interface (iSCSI) feature allows an IP host to access Fibre Channel storage. This feature enables routing iSCSI requests and responses between iSCSI hosts in an IP network and Fibre Channel storage devices in the Fibre Channel SAN. The Fibre Channel storage devices are accessible from any Fibre Channel interface of the Cisco MDS 9000 Family switch.

For information on configuring iSCSI, see [Chapter 4, “Configuring iSCSI.”](#)

## IP Services

The IP Services modules allow you to extend storage networks using the Ethernet infrastructure. The Cisco MDS 9000 Family switches route IP traffic between Ethernet and Fibre Channel interfaces. The IP static routing feature is used to route the traffic between VSANs. An IP route using Fabric Manager and Device Manager. From NX-OS release 4.2(1) and later, CPP interfaces are also available for selection while creating a new IP route.

For information on configuring IP services, see [Chapter 5, “Configuring IP Services.”](#)

## IP Storage

The IP Storage (IPS) Service module allows you to use the open-standard FCIP protocol to enable interconnection of SAN islands over extended distances. The Fibre Channel module with IPS ports and the MSM-18/4 module allow you to use FCIP and iSCSI features. Both modules integrate seamlessly into the Cisco MDS 9000 Family, and support the full range of features that are available on other switching modules, including VSANs, security, and traffic management.

For information on configuring IP Storage, see [Chapter 6, “Configuring IP Storage Services.”](#)

## IPv4 and IPv6

The Cisco MDS 9000 NX-OS software supports the IP version 4 (IPv4) and version 6 (IPv6) protocols on Gigabit Ethernet interfaces. The architecture of IPv6 has been designed to allow existing IPv4 users to transition easily to IPv6, while providing services such as end-to-end security, quality of service (QoS), and globally unique addresses. The dual stack approach for IPv4 and IPv6 allows Cisco MDS 9000 Family switches to connect to older IP networks, transitional networks of both versions, and IPv6 data networks.

For more information on configuring IPv4 for Gigabit Ethernet interfaces, see [Chapter 7, “Configuring IPv4 for Gigabit Ethernet Interfaces.”](#)

For more information on configuring IPv6 for Gigabit Ethernet interfaces, see [Chapter 8, “Configuring IPv6 for Gigabit Ethernet Interfaces.”](#)

The following table lists the Cisco MDS 9250i Multiservice Fabric Switch IPS features with the previous platforms (SSN16 and 18+4).

<b>Line Card</b>	<b>Physical Port Speed</b>	<b>Number of Physical Ports</b>	<b>Number of FCIP Tunnels</b>	<b>Number of FCIP Tunnels Bound to Each IPS/Gigabit Ethernet Interface</b>	<b>Number of iSCSI Ports</b>
Cisco MDS 24/10 port SAN Extension Module	1/10 Gbps	8	24	3	NA
Cisco MDS 9250i Multiservice Fabric Switch	1/10 Gbps	2	12	6	2
SSN-16	1 Gbps	16	48	3	16
18+4	1 Gbps	4	12	3	4





## Configuring Fibre Channel over IP

Cisco MDS 9000 Family IP Storage (IPS) services extend the reach of Fibre Channel SANs by using open-standard, IP-based technology. The switch can connect separated SAN islands using Fibre Channel over IP (FCIP).



### Note

FCIP is supported on Fibre Channel module with IPS ports on Cisco 24/10 port SAN Extension Module on Cisco MDS 9700 Series switches, MDS 9250i Multiservice Fabric Switch, and MDS 9220i Fabric Switch.

This chapter includes the following sections:

- [Feature Information, page 2-17](#)
- [Configuring FCIP, page 2-23](#)
- [Default Settings for FCIP Parameters, page 2-63](#)

## Feature Information

This section briefly describes the new and updated features for releases.

**Table 2-1**      **Feature Information Table**

Feature	Release	Description
FCIP	8.5(1)	Added support for Cisco MDS 9220i Fabric Switch.
<code>show interface fcip fcip-id</code>	8.4(2)	The <code>show interface fcip fcip-id</code> command output was modified to support the RTT statistics for each TCP connection.

Table 2-1 Feature Information Table

Feature	Release	Description
<a href="#">Maximum Retransmission Threshold for OBFL Logging, page 2-30</a>	8.4(1)	The following command was introduced to configure the threshold for logging the TCP retransmission rate to OBFL:  <pre>tcp logging onboard tcp-retransmission-threshold</pre> <p>The following command is deprecated:  <pre>tcp obfl max-retransmissions_pkt_thresh value</pre></p>
<a href="#">Maximum Retransmission Threshold for OBFL Logging, page 2-30</a>	8.2(1)	This feature enables users to configure the threshold for logging the TCP retransmission rate to OBFL.  <p>The following new command was introduced: <b>tcp obfl</b>  <b>max-retransmissions_pkt_thresh</b>  <b>value</b></p>

## Overview of FCIP

The Fibre Channel over IP Protocol (FCIP) is a tunneling protocol that connects geographically distributed Fibre Channel storage area networks (SAN islands) transparently over IP local area networks (LANs), metropolitan area networks (MANs), and wide area networks (WANs). The switch can connect separated SAN islands using Fibre Channel over IP (FCIP). (See [Figure 2-1](#)).

Figure 2-1 Fibre Channel SANs Connected by FCIP

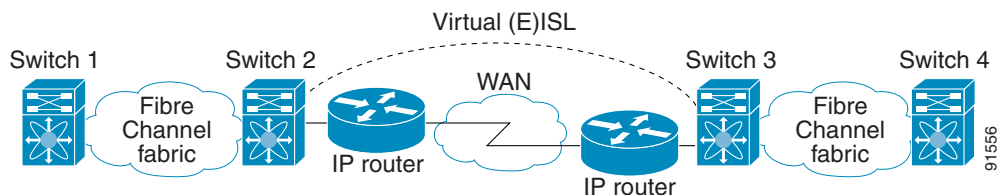

FCIP uses TCP as a network layer transport. The DF bit is set in the TCP header.



### Note

For more information about FCIP protocols, refer to the IETF standards for IPStorage at <http://www.ietf.org>. Also refer to the Fibre Channel standards for switch backbone connection at <http://www.t11.org> (see FC-BB-2).

This section includes the following topics:

- [FCIP Concepts, page 2-19](#)
- [FCIP High-Availability Solutions, page 2-21](#)

- [Configuring FCIP, page 2-23](#)

## FCIP Concepts

To configure Fibre Channel module with IPS ports for FCIP, you should have a basic understanding of the following concepts:

- [FCIP and VE Ports, page 2-19](#)
- [FCIP Links, page 2-20](#)
- [FCIP Profiles, page 2-20](#)
- [FCIP Interfaces, page 2-21](#)

## FCIP and VE Ports

[Figure 2-2](#) shows the internal model of FCIP in relation to Fibre Channel Inter-Switch Links (ISLs) and Cisco's extended ISLs (EISLs).

FCIP virtual E (VE) ports operate exactly like standard Fibre Channel E ports, except that the transport in this case is FCIP instead of Fibre Channel. The only requirement is for the other end of the VE port to be another VE port.

A virtual ISL is established over an FCIP link and transports Fibre Channel traffic. Each associated virtual ISL looks like a Fibre Channel ISL with either an E port or a TE port at each end (see [Figure 2-2](#)).

**Figure 2-2** FCIP Links and Virtual ISLs

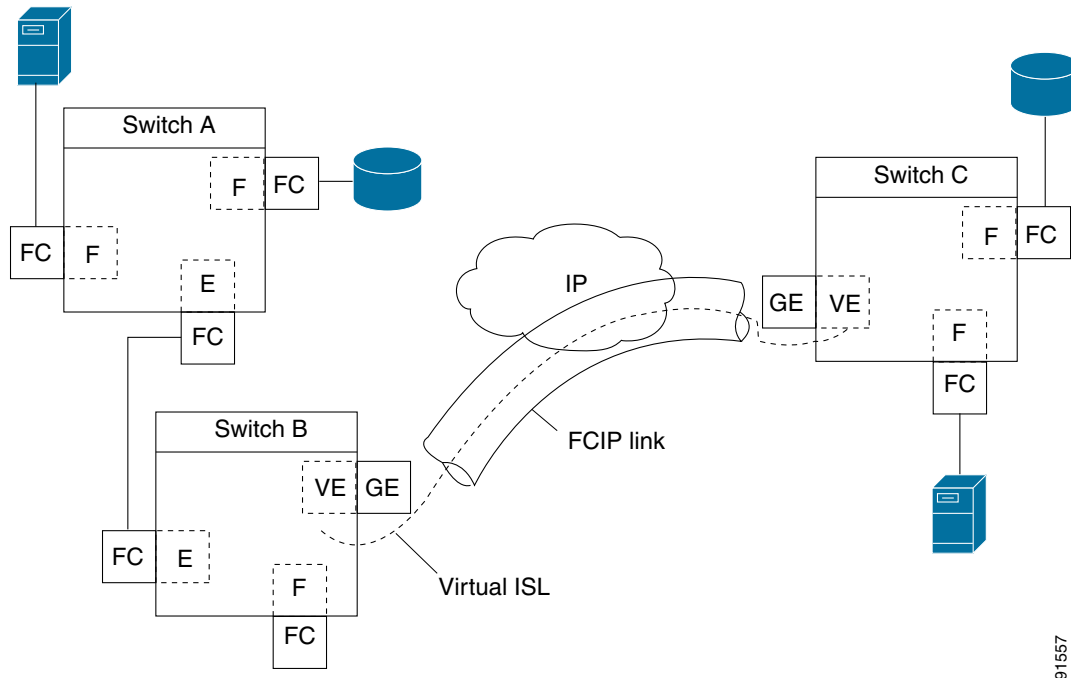

See the “[Configuring E Ports](#)” section on [page 2-37](#) for more information.

## FCIP Links



### Note

In-order delivery (IOD) is not supported on FCIP ISLs where WA and TA are enabled.

FCIP links consist of one or more TCP connections between two FCIP link endpoints. Each link carries encapsulated Fibre Channel frames.

When the FCIP link comes up, the VE ports at both ends of the FCIP link create a virtual Fibre Channel (E)ISL and initiate the E port protocol to bring up the (E)ISL.

By default, the FCIP feature on any Cisco MDS 9000 Family switch creates two TCP connections for each FCIP link:

- One connection is used for data frames.
- The other connection is used only for Fibre Channel control frames, that is, switch-to-switch protocol frames (all Class F). This arrangement provides low latency for all control frames.

To enable FCIP on the Fibre Channel module with IPS ports, an FCIP profile and FCIP interface (interface FCIP) must be configured.

The FCIP link is established between two peers, the VE port initialization operation is identical to a normal E port. This operation is independent of the link being FCIP or pure Fibre Channel, and is based on the E port discovery process (ELP, ESC).

Once the FCIP link is established, the VE port operation is identical to E port operation for all inter-switch communication (including domain management, zones, and VSANs). At the Fibre Channel layer, all VE and E port operations are identical.

## FCIP Profiles

The FCIP profile contains information about the local IP address and TCP parameters. The profile defines the following information:

- The local connection points (IP address and TCP port number)
- The operation of the underlying TCP connections for all FCIP links that use this profile

The FCIP profile's local IP address determines the IPStorage port where the FCIP links terminate (see [Figure 2-3](#)).

**Figure 2-3** FCIP Profile and FCIP Link

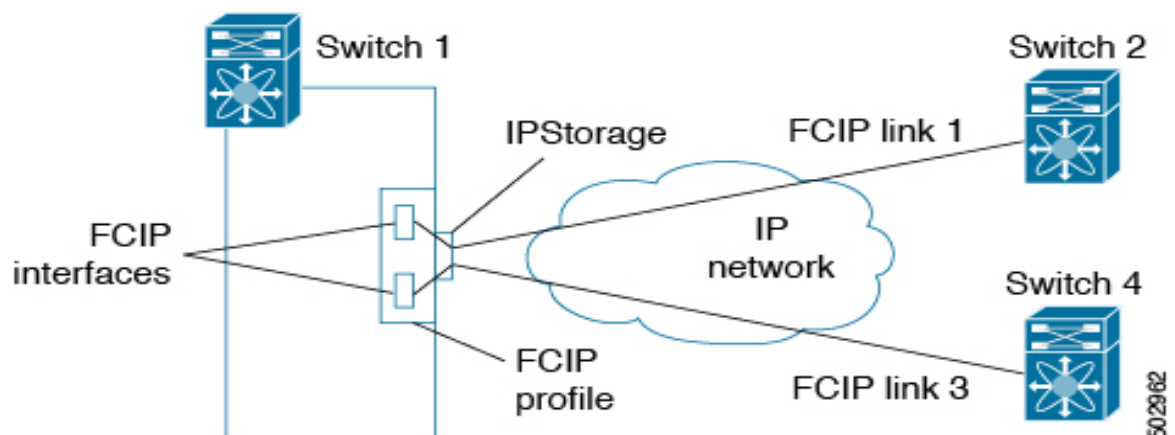

## FCIP Interfaces

The FCIP interface is the local endpoint of the FCIP link and a VE port interface. All the FCIP and E port parameters are configured in context to the FCIP interface.

The FCIP parameters consist of the following:

- The FCIP profile determines which IPStorage port initiates the FCIP links and defines the TCP connection operation.
- Peer information.
- Number of TCP connections for the FCIP link.
- E port parameters—trunking mode and trunk-allowed VSAN list.

## FCIP High-Availability Solutions

The following high-availability solutions are available for FCIP configurations:

- [Fibre Channel Port Channels, page 2-21](#)
- [FSPF, page 2-22](#)
- [VRRP, page 2-23](#)

## Fibre Channel Port Channels

Port channels comprised of FCIP interfaces behave the same way as Fibre Channel port channels. They offer the same benefits of link redundancy between Fibre Channel switches as native FC port channels. Beneath the FCIP level, an FCIP link can run on top of a IPStorage port. This link is totally transparent to the Fibre Channel layer.

The Fibre Channel Port Channel (to which FCIP link can be a part of) does not have a restriction on which (E)ISL links can be combined in a Fibre Channel Port Channel as long as it passes the compatibility check.

For information, see the *Cisco Fabric Manager Interfaces Configuration Guide and Cisco MDS 9000 Family NX-OS Interfaces Configuration Guide*.

The maximum number of Fibre Channel ports that can be put into a Fibre Channel Port Channel is 16.

To configure Fibre Channel Port Channels, see the *Cisco MDS 9000 Family NX-OS Interfaces Configuration Guide and Cisco Fabric Manager Interfaces Configuration Guide*.

[Figure 2-4](#) provides an example of a port channel-based load-balancing configuration. To perform this configuration, you need two IP addresses on each SAN island. This solution addresses link failures.

Figure 2-4 Port Channel-Based Load Balancing

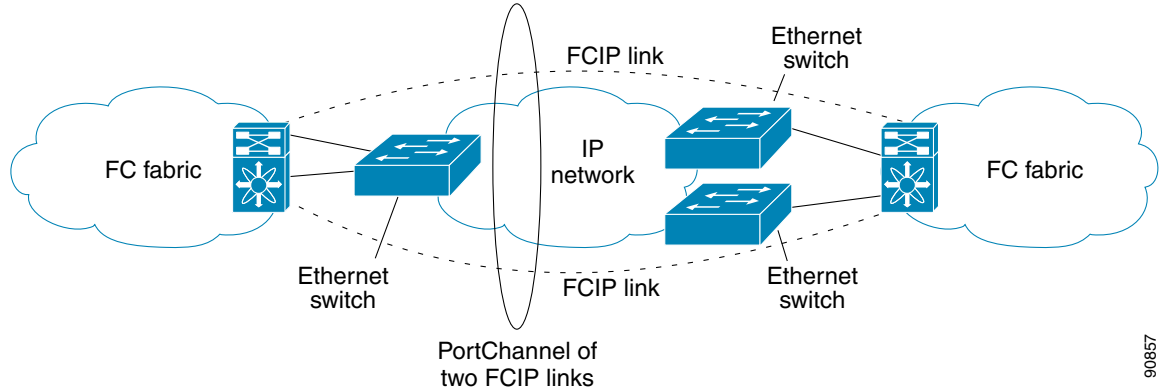

90857

The following characteristics set Fibre Channel port channel solutions apart from other solutions:

- The entire bundle is one logical (E)ISL link.
- All FCIP links in the port channel should terminate on the same two switches.
- The Fibre Channel traffic is load balanced across the FCIP links in the port channel.

## FSPF

Figure 2-5 displays a FSPF-based load balancing configuration example. This configuration requires two IP addresses on each SAN island, and addresses IP and FCIP link failures.

Figure 2-5 FSPF-Based Load Balancing

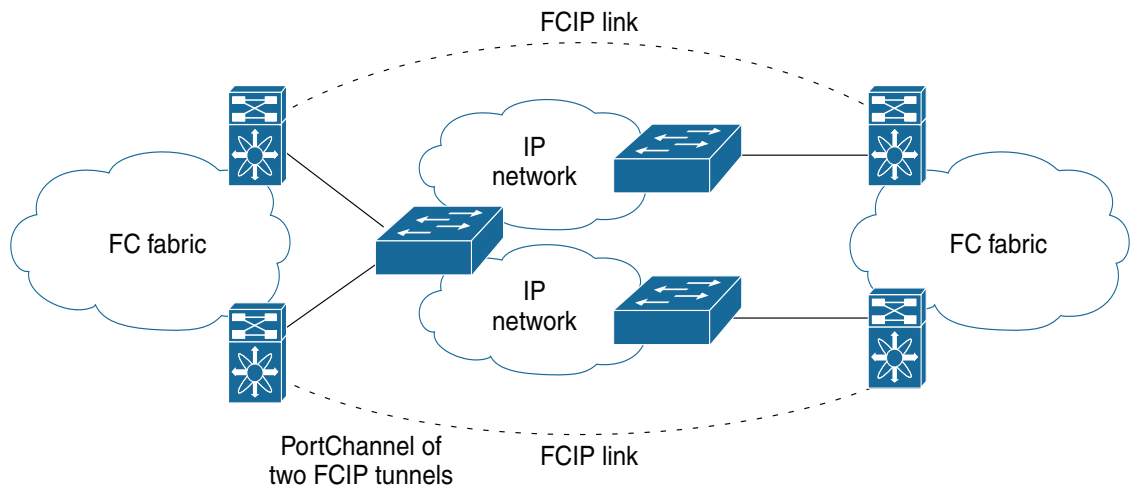

90858

The following characteristics set FSPF solutions apart from other solutions:

- Each FCIP link is a separate (E)ISL.
- The FCIP links can connect to different switches across two SAN islands.
- The Fibre Channel traffic is load balanced across the FCIP links.

## VRRP

Figure 2-6 displays a Virtual Router Redundancy Protocol (VRRP)-based high availability FCIP configuration example. This configuration requires at least two physical IPStorage ports connected to the Ethernet switch on the island where you need to implement high availability using VRRP.

**Figure 2-6 VRRP-Based High Availability**

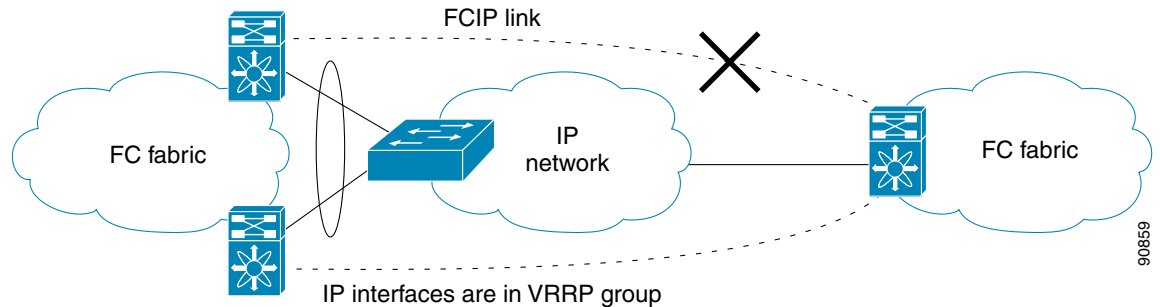

The following characteristics set VRRP solutions apart from other solutions:

- If the active VRRP port fails, the standby VRRP port takes over the VRRP IP address.
- When the VRRP switchover happens, the FCIP link automatically disconnects and reconnects.
- This configuration has only one FCIP (E)ISL link.



**Note**

Port-fast needs to be enabled in the Cisco catalyst 6500 series and Cisco Nexus 7000 series switches where the IPStorage ports or Management port is connected.



**Note**

VRRP IPv6 is not supported for MDS 9250i switch.



**Note**

From Cisco MDS NX-OS Release 8.3(1) and later, the VRRP feature is not supported on Cisco MDS 9000 Series Switches.

## Configuring FCIP

This section describes how to configure FCIP and includes the following topics:

- [Enabling FCIP, page 2-24](#)
- [Basic FCIP Configuration, page 2-24](#)
- [Creating FCIP Profiles, page 2-25](#)
- [Displaying FCIP Profile Information, page 2-33](#)
- [Advanced FCIP Profile Configuration, page 2-28](#)
- [Advanced FCIP Interface Configuration, page 2-33](#)
- [Configuring Peers, page 2-34](#)

- [Configuring E Ports, page 2-37](#)
- [Displaying FCIP Interface Information, page 2-38](#)
- [Advanced FCIP Features, page 2-44](#)

## Enabling FCIP

The Fibre Channel over IP Protocol (FCIP) is a tunneling protocol that connects geographically distributed Fibre Channel storage area networks (SAN islands) transparently over IP local area networks (LANs), metropolitan area networks (MANs), and wide area networks (WANs).

To begin configuring the FCIP feature, you must explicitly enable FCIP on the required switches in the fabric. By default, this feature is disabled in all switches in the Cisco MDS 9000 Family.

The configuration and verification operations commands for the FCIP feature are only available when FCIP is enabled on a switch. When you disable this feature, all related configurations are automatically discarded.

By default, the Cisco MDS 9700 series switches, MDS 9250i switches, and MDS 9220i switches are shipped with the SAN extension over IP package license.

To enable FCIP on any participating switch, follow these steps:

	Command	Purpose
Step 1	switch# <b>configure terminal</b>	Enters configuration mode.
Step 2	switch(config)# <b>feature fcip</b>	Enables FCIP on that switch.
Step 3	switch(config)# <b>no feature fcip</b>	(Optional) Disables (default) FCIP on that switch.

To create and manage FCIP links with DCNM-SAN, use the FCIP Wizard. For more information on the FCIP Wizard, see the *Configuring FCIP* chapter, in the *Cisco DCNM SAN Client Online Help* document.

## Basic FCIP Configuration

Once you have created FCIP links using the FCIP wizard, you may need to modify parameters for these links. This includes modifying the FCIP profiles as well as the FCIP link parameters.

- For Cisco MDS 9220i Switch, each 1 Gbps or 10 Gbps IPStorage interface can have three FCIP links configured at a time and the 40 Gbps IPStorage interface can have four FCIP links configured at a time.
- For Cisco MDS 9250i Switch, each IPStorage interface can have six FCIP links configured at a time.
- For Cisco MDS 24/10-Port SAN Extension Module, each 1 Gbps or 10 Gbps IPStorage interface can have three FCIP links configured at a time and the 40 Gbps IPStorage interface can have four FCIP links configured at a time.



### Note

When using IPsec and IKE, each IPStorage interface on the Fibre Channel module with IPS ports must be configured in its own IP subnet. If there are multiple IPStorage interfaces configured with IP address or network-mask in the same IP subnet, IKE packets might not be sent out to the correct IPS port and the IPsec link will not come up.



**Note** You can configure FCIP with IPsec and NAT on Cisco MDS 9220i switches.

To configure an FCIP link, follow these steps on both switches:

- Step 1** Configure the IPStorage interface.  
See the *Cisco MDS 9000 Family NX-OS IP Services Configuration Guide*.
- Step 2** Create an FCIP profile and then assign the IPStorage interface's IP address to the profile.
- Step 3** Create an FCIP interface and then assign the profile to the interface.
- Step 4** Configure the peer IP address for the FCIP interface.
- Step 5** Enable the interface.

## Creating FCIP Profiles

You must assign a local IP address of an IPStorage interface or subinterface to the FCIP profile to create an FCIP profile. You can assign IPv4 or IPv6 addresses to the interfaces. [Figure 2-7](#) shows an example configuration.

**Figure 2-7** Assigning Profiles to Each IPStorage Interface



To create an FCIP profile in switch 1 in [Figure 2-7](#), follow these steps:

	Command	Purpose
<b>Step 1</b>	switch1# <b>configure terminal</b>	Enters configuration mode.
<b>Step 2</b>	switch1(config)# <b>fcip profile 10</b>	Creates a profile for the FCIP connection. The valid range is from 1 to 255.
<b>Step 3</b>	switch1(config-profile)# <b>ip address 10.100.1.25</b>	Associates the profile (10) with the local IPv4 address of the IPStorage interface (3/1).
<b>Step 4</b>	switch1# <b>show fcip profile</b>	(Optional) Displays FCIP profile information.

To assign an FCIP profile in switch 2 in [Figure 2-7](#), follow these steps:

	Command	Purpose
<b>Step 1</b>	switch2# <b>configure terminal</b>	Enters configuration mode.
<b>Step 2</b>	switch2(config)# <b>fcip profile 20</b>	Creates a profile for the FCIP connection.

	Command	Purpose
Step 3	switch2(config-profile)# <b>ip address 10.1.1.1</b>	Associates the profile (20) with the local IPv4 address of the IPStorage interface.
Step 4	switch2# <b>show fcip profile</b>	(Optional) Displays FCIP profile information.

## Displaying FCIP Profile Information

### Example 2-1 Displaying Summary of FCIP Profiles

```
switch# show fcip profile
```

```
-----
ProfileId      Ipaddr                TcpPort
-----
1              20.1.1.1              3225
2              20.1.1.1              2000
3              20.1.1.1              3000
4              20.1.1.1              4000
5              20.1.1.1              5000
6              20.1.1.1              6000
7              30.1.1.1              3225
8              31.1.1.1              3225
9              32.1.1.1              3225
10             33.1.1.1              3225
11             34.1.1.1              3225
12             35.1.1.1              3225
```

### Example 2-2 Displaying Detailed FCIP Profile Information

```
switch# show fcip profile 1
FCIP Profile 1
  Internet Address is 20.1.1.1 (interface IPStorage1/1)
  Tunnels Using this Profile: fcip1
  Listen Port is 3225
  TCP parameters
    SACK is enabled
    PMTU discovery is enabled, reset timeout is 3600 sec
    Keep alive is 60 sec
    Minimum retransmission timeout is 200 ms
    Maximum number of re-transmissions is 4
    Send buffer size is 16384 KB
    Maximum allowed bandwidth is 5000000 kbps
    Minimum available bandwidth is 4000000 kbps
    Configured round trip time is 1000 usec
    Congestion window monitoring is enabled, burst size is 50 KB
    Auto jitter detection is enabled
```

## Creating FCIP Links

When two FCIP link endpoints are created, an FCIP link is established between the two IPS ports. The peer IP address specifies the address of the remote FCIP endpoint. This allows the creation of an FCIP link to that peer switch once the FCIP interface is enabled.

Figure 2-8 shows an example configuration of an FCIP link.

**Figure 2-8 Assigning Profiles to Each IPStorage Interface**

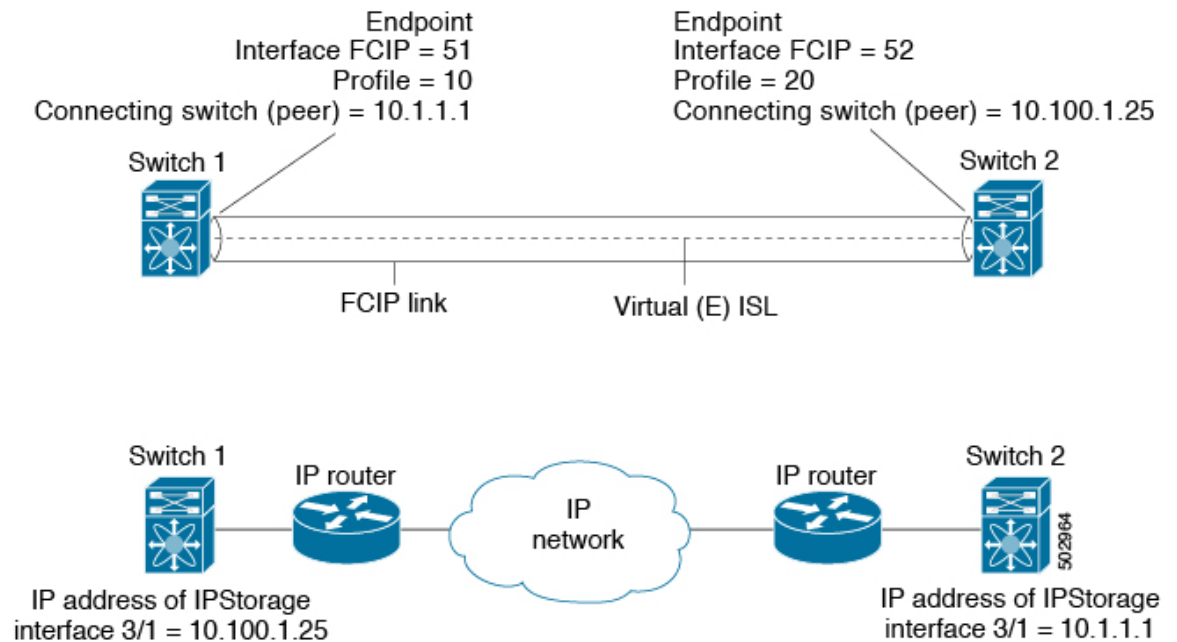

To create an FCIP link endpoint in switch 1, follow these steps:

	Command	Purpose
Step 1	switch1# <b>configure terminal</b>	Enters configuration mode.
Step 2	switch1(config)# <b>interface fcip 51</b>	Creates an FCIP interface (51).
Step 3	switch1(config-if)# <b>use-profile 10</b>	Assigns the profile (10) to the FCIP interface.
Step 4	switch1(config-if)# <b>peer-info ipaddr 10.1.1.1</b>	Assigns the peer IPv4 address information (10.1.1.1 for switch 2) to the FCIP interface.
Step 5	switch1(config-if)# <b>no shutdown</b>	Enables the interface.

To create an FCIP link endpoint in switch 2, follow these steps:

	Command	Purpose
Step 1	switch2# <b>configure terminal</b>	Enters configuration mode.
Step 2	switch2(config)# <b>interface fcip 52</b>	Creates an FCIP interface (52).
Step 3	switch2(config-if)# <b>use-profile 20</b>	Binds the profile (20) to the FCIP interface.
Step 4	switch2(config-if)# <b>peer-info ip address 10.100.1.25</b>	Assigns the peer IPv4 address information (10.100.1.25 for switch 1) to the FCIP interface.
Step 5	switch1(config-if)# <b>no shutdown</b>	Enables the interface.

## Advanced FCIP Profile Configuration

A basic FCIP configuration uses the local IP address to configure the FCIP profile. In addition to the local IP address and the local port, you can specify other TCP parameters as part of the FCIP profile configuration.

This sections includes the following topics:

- [Configuring TCP Listener Ports, page 2-28](#)
- [Configuring TCP Parameters, page 2-28](#)

FCIP configuration options can be accessed from the switch (config-profile)# submode prompt.

### Configuring TCP Listener Ports

To configure TCP listener ports, follow these steps:

	Command	Purpose
Step 1	switch# <b>configure terminal</b>	Enters configuration mode.
Step 2	switch(config)# <b>fcip profile 20</b>	Creates the profile (if it does not already exist) and enters profile configuration submode. The valid range is from 1 to 255.

The default TCP port for FCIP is 3225. You can change this port by using the **port** command.

To change the default FCIP port number (3225), follow these steps:

	Command	Purpose
Step 1	switch(config-profile)# <b>port 5000</b>	Associates the profile with the local port number (5000).
Step 2	switch(config-profile)# <b>no port</b>	Reverts to the default 3225 port.

### Configuring TCP Parameters

You can control TCP behavior in a switch by configuring the TCP parameters that are described in this section.



#### Note

When FCIP is sent over a WAN link, the default TCP settings may not be appropriate. In such cases, we recommend that you tune the FCIP WAN link by modifying the TCP parameters (specifically bandwidth, round-trip times, and CWM burst size).

This section includes the following topics:

- [Minimum Retransmit Timeout, page 2-29](#)
- [Keepalive Timeout, page 2-29](#)
- [Maximum Retransmissions, page 2-29](#)
- [Path MTUs, page 2-30](#)
- [Selective Acknowledgments, page 2-31](#)
- [Window Management, page 2-31](#)
- [Monitoring Congestion, page 2-32](#)
- [Displaying FCIP Profile Information, page 2-33](#)

- [Displaying FCIP Profile Information, page 2-33](#)

### Minimum Retransmit Timeout

You can control the minimum amount of time TCP waits before retransmitting. By default, this value is 200 milliseconds.

To configure the minimum retransmit time, follow these steps:

	Command	Purpose
Step 1	<code>switch(config-profile)# tcp min-retransmit-time 500</code>	Specifies the minimum TCP retransmit time for the TCP connection to be 500 milliseconds. The default is 200 milliseconds and the range is from 200 to 5000 milliseconds.
Step 2	<code>switch(config-profile)# no tcp min-retransmit-time 500</code>	(Optional) Reverts the minimum TCP retransmit time to the factory default of 200 milliseconds.

### Keepalive Timeout

You can configure the interval that the TCP connection uses to verify that the FCIP link is functioning. This ensures that an FCIP link failure is detected quickly even when there is no traffic.

If the TCP connection is idle for more than the specified time, then keepalive timeout packets are sent to ensure that the connection is active. The keepalive timeout feature can be used to tune the time taken to detect FCIP link failures.

You can configure the first interval during which the connection is idle (the default is 60 seconds). When the connection is idle for the configured interval, eight keepalive probes are sent at 1-second interval. If no response is received for these eight probes and the connection remains idle throughout, then the FCIP link is automatically closed.



#### Note

Only the first interval (during which the connection is idle) can be changed.

To configure the first keepalive timeout interval, follow these steps:

	Command	Purpose
Step 1	<code>switch(config-profile)# tcp keepalive-timeout 120</code>	Specifies the keepalive timeout interval for the TCP connection in seconds (120). The range is from 1 to 7200 seconds.
Step 2	<code>switch(config-profile)# no tcp keepalive-timeout 120</code>	(Optional) Reverts the keepalive timeout interval to the default 60 seconds.

### Maximum Retransmissions

You can specify the maximum number of times a packet is retransmitted before TCP decides to close the connection.

To configure maximum retransmissions, follow these steps:

	Command	Purpose
Step 1	<code>switch(config-profile)# tcp max-retransmissions 6</code>	Specifies the maximum number of retransmissions (6). The range is from 1 to 8 retransmissions.
Step 2	<code>switch(config-profile)# no tcp max-retransmissions 6</code>	(Optional) Reverts to the default of 4 retransmissions.

## Maximum Retransmission Threshold for OBFL Logging

FCIP links utilize peer to peer TCP sessions. The intermediate network is often Ethernet which is not lossless and may drop frames. These are automatically retransmitted by the TCP sender. End applications should be able to tolerate some degree of delay caused by retransmissions. However, some applications may have a lower tolerance for retransmissions than others. Excessive TCP retransmission events are logged to OBFL to assist in troubleshooting. The threshold retransmission rate that will trigger logging can be configured. This retransmission rate is measured per FCIP profile.

To configure the OBFL retransmission rate per FCIP profile, follow these steps:

	Command	Purpose
Step 1	switch# <b>configure terminal</b>	Enters the global configuration mode.
Step 2	switch(config)# <b>fcip profile profile_id</b>	Creates a profile (if it does not already exist) and enters profile configuration submode. The range is from 1 to 255.
Step 3	switch(config-profile)# <b>tcp obfl max-retransmissions_pkt_thresh value</b>  or  switch(config-profile)# <b>tcp logging onboard tcp-retransmission-threshold value</b>	Specifies the threshold for logging the TCP retransmission rate to OBFL, that is, the number of packets retransmitted per 10000 packets measured every minute. The range is from 5 to 10. The default value is 5.  Starting from Cisco MDS Release 8.4(1), the <b>tcp obfl max-retransmissions_pkt_thresh value</b> command is deprecated. Use the <b>tcp logging onboard tcp-retransmission-threshold value</b> command to configure the TCP retransmission rate to OBFL. The range is from 0.01 to 0.10. The default value is 0.05%.
Step 4	switch# <b>show logging onboard error-stats</b>	Displays the excessive FCIP retransmission logs.

## Path MTUs

Path MTU (PMTU) is the minimum MTU on the IP network between the two endpoints of the FCIP link. PMTU discovery is a mechanism by which TCP learns of the PMTU dynamically and adjusts the maximum TCP segment accordingly (RFC 1191).

By default, PMTU discovery is enabled on all switches with a timeout of 3600 seconds. If TCP reduces the size of the maximum segment because of PMTU change, the reset-timeout specifies the time after which TCP tries the original MTU.

To configure PMTU, follow these steps:

	Command	Purpose
Step 1	switch(config-profile)# <b>no tcp pmtu-enable</b>	Disables PMTU discovery.
Step 2	switch(config-profile)# <b>tcp pmtu-enable</b>	Enables (default) PMTU discovery with the default value of 3600 seconds.
Step 3	switch(config-profile)# <b>tcp pmtu-enable reset-timeout 90</b>	Specifies the PMTU reset timeout to 90 seconds. The range is 60 to 3600 seconds.
Step 4	switch(config-profile)# <b>no tcp pmtu-enable reset-timeout 600</b>	Leaves PMTU discovery enabled but reverts the timeout to the default of 3600 seconds.

## Selective Acknowledgments

TCP may experience poor performance when multiple packets are lost within one window. With the limited information available from cumulative acknowledgments, a TCP sender can only learn about a single lost packet per round trip. A selective acknowledgment (SACK) mechanism helps overcome the limitations of multiple lost packets during a TCP transmission.

The receiving TCP sends back SACK advertisements to the sender. The sender can then retransmit only the missing data segments. By default, SACK is enabled on Cisco MDS 9000 Family switches.

To configure SACK, follow these steps:

	Command	Purpose
Step 1	switch(config-profile)# <b>no tcp sack-enable</b>	Disables SACK.
Step 2	switch(config-profile)# <b>tcp sack-enable</b>	Enables SACK (default).

## Window Management

The optimal TCP window size is automatically calculated using the maximum bandwidth parameter, the minimum available bandwidth parameter, and the dynamically measured round-trip time (RTT).



### Note

The configured **round-trip-time** parameter determines the window scaling factor of the TCP connection. This parameter is only an approximation. The measured RTT value overrides the **round trip** time parameter for window management. If the configured **round-trip-time** is too small compared to the measured RTT, then the link may not be fully utilized due to the window scaling factor being too small.

The **min-available-bandwidth** parameter and the measured RTT together determine the threshold below which TCP aggressively maintains a window size sufficient to transmit at minimum available bandwidth.

The **max-bandwidth-mbps** parameter and the measured RTT together determine the maximum window size.



### Note

Set the maximum bandwidth to match the worst-case bandwidth available on the physical link, considering other traffic that might be going across this link (for example, other FCIP links, WAN limitations). Maximum bandwidth should be the total bandwidth minus all other traffic going across that link.



### Note

In Cisco MDS 9250i Multiservice Fabric Switch, you can configure the TCP maximum bandwidth up to 5 Gbps. We recommend that the minimum available bandwidth is 80% of the maximum bandwidth.

To configure window management, follow these steps:

	Command	Purpose
Step 1	<code>switch(config-profile)# tcp max-bandwidth-mbps 900 min-available-bandwidth-mbps 300 round-trip-time-ms 10</code>	Configures the maximum available bandwidth at 900 Mbps, the minimum slow start threshold at 300 Mbps, and the RTT at 10 milliseconds.
Step 2	<code>switch(config-profile)# no tcp max-bandwidth-mbps 900 min-available-bandwidth-mbps 300 round-trip-time-ms 10</code>	(Optional) Reverts to the factory defaults. The FCIP defaults are maximum bandwidth at 1 Gbps, minimum available bandwidth at 500 Mbps, and RTT at 1 milliseconds.
Step 3	<code>switch(config-profile)# tcp max-bandwidth-kbps 2000 min-available-bandwidth-kbps 2000 round-trip-time-us 200</code>	Configures the maximum available bandwidth at 2000 Kbps, the minimum available bandwidth at 2000 Kbps, and the RTT at 200 milliseconds.

## Monitoring Congestion

By enabling the congestion window monitoring (CWM) parameter, you allow TCP to monitor congestion after each idle period. The CWM parameter also determines the maximum burst size allowed after an idle period. By default, this parameter is enabled and the default burst size is 50 KB.

The interaction of bandwidth parameters and CWM and the resulting TCP behavior is outlined as follows:

- If the average rate of the Fibre Channel traffic over the preceding RTT is less than the min-available-bandwidth multiplied by the RTT, the entire burst is sent immediately at the min-available-bandwidth rate, provided no TCP drops occur.
- If the average rate of the Fibre Channel traffic is greater than min-available-bandwidth multiplied by the RTT, but less than max-bandwidth multiplied by the RTT, then if the Fibre Channel traffic is transmitted in burst sizes smaller than the configured CWM value the entire burst is sent immediately by FCIP at the max-bandwidth rate.
- If the average rate of the Fibre Channel traffic is larger than the min-available-bandwidth multiplied by the RTT and the burst size is greater than the CWM value, then only a part of the burst is sent immediately. The remainder is sent with the next RTT.

The software uses standard TCP rules to increase the window beyond the one required to maintain the min-available-bandwidth to reach the max-bandwidth.



### Tip

We recommend that this feature remains enabled to realize optimal performance. Increasing the CWM burst size can result in more packet drops in the IP network, impacting TCP performance. Only if the IP network has sufficient buffering, try increasing the CWM burst size beyond the default to achieve lower transmit latency.

To change the CWM defaults, follow these steps:

	Command	Purpose
Step 1	<code>switch(config-profile)# no tcp cwm</code>	Disables congestion monitoring.
Step 2	<code>switch(config-profile)# tcp cwm</code>	Enables congestion monitoring and sets the burst size to its default size. The default burst size is 50 KB.

	Command	Purpose
Step 3	switch(config-profile)# <b>tcp cwm burstsize 30</b>	Changes the burst size to 30 KB. The valid range is from 10 to 100 KB.
Step 4	switch(config-profile)# <b>no tcp cwm burstsize 25</b>	(Optional) Leaves the CWM feature in an enabled state but changes the burst size to its factory default.

## Displaying FCIP Profile Information

Use the **show fcip profile** command to display FCIP profile information for the Cisco MDS 9250i Multiservice Fabric Switch:

```
switch# show fcip profile 1
Internet address is 209.165.200.226 (interface IPStorage5/4.101)
Listen Port is 3225
TCP parameters
  SACK is enabled
  PMTU discovery is enabled, reset timeout is 3600 sec
  Keep alive is 60 sec
  Minimum retransmission timeout is 200 ms
  Maximum number of re-transmissions is 4
  Maximum number of obfl re-transmission Thresh is 5
  Maximum allowed bandwidth is 5000000 kbps
  Minimum available bandwidth is 4000000 kbps
  Configured round trip time is 1000 usec
  Congestion window monitoring is enabled, burst size is 50 KB
  Auto jitter detection is enabled
```

Use the **show fcip profile** command to display FCIP profile information for the 24/10 port SAN Extension module:

```
switch# show fcip profile 41
FCIP Profile 41
Internet Address is 209.165.200.225 (interface IPStorage5/4.101)
Listen Port is 3225
TCP parameters
  SACK is enabled
  PMTU discovery is enabled, reset timeout is 3600 sec
  Keep alive is 60 sec
  Minimum retransmission timeout is 200 ms
  Maximum number of re-transmissions is 4
  Maximum number of obfl re-transmission Thresh is 6
  Maximum allowed bandwidth is 10000000 kbps
  Minimum available bandwidth is 8000000 kbps
  Configured round trip time is 1000 usec
  Congestion window monitoring is enabled, burst size is 50 KB
  Auto jitter detection is enabled
```

## Advanced FCIP Interface Configuration

This section describes the options you can configure on an FCIP interface to establish connection to a peer and includes the following topics:

- [Assigning a Peer IP Address, page 2-34](#)
- [Configuring Number of TCP Connections, page 2-35](#)

- [Configuring Active Connections, page 2-36](#)
- [Enabling Time Stamp Control, page 2-36](#)
- [Configuring Active Connections, page 2-36](#)

To establish a peer connection, you must first create the FCIP interface and enter the config-if submode.

To enter the config-if submode, follow these steps:

	Command	Purpose
Step 1	switch# <b>configure terminal</b>	Enters configuration mode.
Step 2	switch(config)# <b>interface fcip 100</b>	Creates an FCIP interface (100).

Each IPStorage interface can have three FCIP links configured at a time. For Cisco MDS 9250i, each IPStorage port can have six FCIP links configured at a time. For Cisco MDS 24/10-Port SAN Extension Module, each IPStorage port can have three FCIP links configured at a time.

## Configuring Peers

All the FCIP and E port parameters are configured in context to the FCIP interface. To create an FCIP link, assign a profile to the FCIP interface and configure the peer information on the two switches at the ends of the FCIP link. The peer IP switch information causes the switch to initiate an FCIP link to that peer switch. The basic FCIP configuration uses the peer's IP address to configure the peer information. You can establish an FCIP link with the peer using the Peer IP address option. This option configures both ends of the FCIP link. Optionally, you can also use the peer TCP port along with the IP address.

## Configuring Peer Information

### Assigning a Peer IP Address

The basic FCIP configuration uses the peer's IP address to configure the peer information. You can also specify the peer's port number to configure the peer information. If you do not specify a port, the default 3225 port number is used to establish a connection. You can specify an IPv4 address or an IPv6 address.

To assign the peer information based on the IPv4 address and port number, follow these steps:

	Command	Purpose
Step 1	switch(config-if)# <b>peer-info ipaddr 10.1.1.1</b>	Assigns an IPv4 address to configure the peer information. Because no port is specified, the default port number (3225) is used.
Step 2	switch(config-if)# <b>peer-info ipaddr 10.1.1.1 port 3000</b>	Assigns the IPv4 address and sets the peer TCP port to 3000. The valid port number range is 0 to 65535.
Step 3	switch(config-if)# <b>no shutdown</b>	Enables the interface.

To assign the peer information based on the IPv6 address and port number, follow these steps:

	Command	Purpose
Step 1	<code>switch(config-if)# peer-info ipaddr</code>	Assigns an IPv6 address to configure the peer information. Because no port is specified, the default port number (3225) is used.
	<code>switch(config-if)# no peer-info ipaddr 2001:0db8:800:200c::417a</code>	Deletes the assigned peer port information.
Step 2	<code>switch(config-if)# peer-info ipaddr 2001:0db8:800:200c::417a port 3000</code>	Assigns the IPv6 address and sets the peer TCP port to 3000. The valid port number range is 0 to 65535.
	<code>switch(config-if)# no peer-info ipaddr 2001:0db8:800:200c::417a port 3000</code>	Deletes the assigned peer port information.
Step 3	<code>switch(config-if)# no shutdown</code>	Enables the interface.
Step 4	<code>switch(config-if)# interface IPStorage slot-number/plot-number</code>	Enters IPStorage interface configuration mode.
Step 5	<code>switch(config-if)# shutdown</code>	Disable the interface.
Step 6	<code>switch(config-if)# ipv6 enable</code>	Enables IPv6 processing on the interface.
Step 7	<code>switch(config-if)# no shutdown</code>	Enables the interface.

## Configuring Number of TCP Connections

You can specify the number of TCP connections used for an FCIP link to be either two or five connections. By default, FCIP uses two connections for each link. Connection 0 is the FCIP control connection. The remaining one or four TCP connections are used for data.



### Note

Make sure that the peer switch FCIP link is also configured with the same number of TCP connections, otherwise FCIP link will not come up.



### Note

On the Cisco MDS platform, 10 Gb IPStorage ports have different performance characteristics than 1 Gb Ethernet ports. To achieve maximum throughput on FCIP links utilizing MDS 10 Gb IPStorage ports, set the number of TCP connections to 5 on these links.

To specify the TCP connection attempts, follow these steps:

	Command	Purpose
Step 1	<code>switch# configure terminal</code>	Enters global configuration mode.
Step 2	<code>switch(config)# interface fcip 4</code>	Enters FCIP interface configuration mode.
Step 3	<code>switch(config-if)# shutdown</code>	Disables the interface.
Step 4	<code>switch(config-if)# tcp-connection 5</code>	Specifies the number of TCP connections. Valid values are 2 or 5.

	Command	Purpose
Step 5	<code>switch(config-if)# no tcp-connection</code>	(Optional) Reverts to the factory set default of two TCP sessions per FCIP interface.
Step 6	<code>switch(config-if)# no shutdown</code>	Enables the interface.

**Note**

To change the number of TCP connections ensure that the FCIP interface is shut down first.

## Configuring Active Connections

You can configure the mode for initiating a TCP connection. By default, the active mode is enabled to actively attempt an IP connection. If you enable the passive mode, the switch does not initiate a TCP connection but waits for the peer to connect to it. By default, the switch tries two TCP connections for each FCIP link.

**Note**

Ensure that both ends of the FCIP link are not configured as passive mode. If both ends are configured as passive, the connection is not initiated.

To configure the passive mode, follow these steps:

	Command	Purpose
Step 1	<code>switch(config-if)# passive-mode</code>	Enables passive mode while attempting a TCP connection.
Step 2	<code>switch(config-if)# no passive-mode</code>	Reverts to the factory set default of using the active mode while attempting the TCP connection.
Step 3	<code>switch(config-if)# no shutdown</code>	Enables the interface.

## Enabling Time Stamp Control

You can configure the switch to discard packets that are outside a specified time range. When enabled, this feature specifies the time range within which packets can be accepted. If the packet arrived within the range specified by this option, the packet is accepted. Otherwise, it is dropped.

By default, time stamp control is disabled in all switches in the Cisco MDS 9000 Family. When enabled, if a packet arrives within a 2000 millisecond interval (+ or -2000 milliseconds) from the network time that packet is accepted.

**Note**

If the **time-stamp** option is enabled, ensure to configure NTP on both switches (see the *Cisco NX-OS Fundamentals Configuration Guide* for more information).

**Tip**

Do not enable time stamp control on an FCIP interface that has tape acceleration or Write Acceleration configured.

To enable or disable the time stamp control, follow these steps:

	Command	Purpose
Step 1	switch(config-if)# <b>time-stamp</b> Please enable NTP with a common time source on both MDS Switches that are on either side of the FCIP link	Enables time stamp checking for received packets with a default acceptable time difference of 2000 milliseconds.
Step 2	switch(config-if)# <b>no time-stamp</b>	(Optional) Disables (default) time stamps.
Step 3	switch(config-if)# <b>time-stamp acceptable-diff 4000</b>	Configures the packet acceptance time. The valid range is from 500 to 10,000 millisecond.
Step 4	switch(config-if)# <b>no time-stamp acceptable-diff 500</b>	(Optional) Deletes the configured time difference and reverts the difference to factory defaults. The default difference is a 2000-millisecond interval from the network time.
Step 5	switch(config-if)# <b>no shutdown</b>	Enables the interface.

## Quality of Service

The quality of service (QoS) parameter specifies the differentiated services code point (DSCP) value to mark all IP packets (type of service—TOS field in the IP header).

- The control DSCP value applies to all FCIP frames in the control TCP connection.
- The data DSCP value applies to all FCIP frames in the data connection.

If the FCIP link has only one TCP connection, that data DSCP value is applied to all packets in that connection.

To set the QoS values on FCIP interfaces, follow these steps:

	Command	Purpose
Step 1	switch(config-if)# <b>qos control 24 data 26</b>	Configures the control TCP connection and data connection to mark all packets on that DSCP value. The control and data value ranges from 0 to 63.
	switch(config-if)# <b>no qos control 24 data 26</b>	Reverts the switch to its factory default (marks all control and data packets with DCSP value 0).

## Configuring E Ports

You configure FCIP interfaces in the same way as you configure FC (T)E interfaces. Specifically, the following features are available for FCIP interfaces:

- An FCIP interface can be a member of any VSAN  
See the *Cisco Fabric Configuration Guide* and *Cisco MDS 9000 Family NX-OS Fabric Configuration Guide*.
- Trunk mode and trunk allowed VSANs  
See the *Cisco Fabric Manager Interfaces Configuration Guide* and *Cisco MDS 9000 Family NX-OS Interfaces Configuration Guide*.
- Port Channels
  - Multiple FCIP links can be bundled into a Fibre Channel Port Channel.

- FCIP links and Fibre Channel links cannot be combined in one Port Channel.

See the *Cisco Fabric Manager Security Configuration Guide* and *Cisco MDS 9000 Family NX-OS Security Configuration Guide*.

- FSPF

See the *Cisco Fabric Manager Fabric Configuration Guide* and *Cisco MDS 9000 Family NX-OS Fabric Configuration Guide*.

- Importing and exporting the zone database from the adjacent switch

See the *Cisco Fabric Manager System Management Configuration Guide* and *Cisco MDS 9000 Family NX-OS System Management Configuration Guide*.

## Displaying FCIP Interface Information

Use the **show interface** commands to view the summary, counter, description, and status of the FCIP link. Use the output of these commands to verify the administration mode, the interface status, the operational mode, the related VSAN ID, and the profile used. See [Example 2-3](#) through [Example 2-7](#).

### Example 2-3 Displaying the FCIP Summary

```
switch# show fcip summary
```

Tun	prof	IPS-if	peer-ip	Status	T	W	T	Enc	Comp	Bandwidth	rtt
					E	A	A			max/min	(us)
1	1	IPS1/1	20.1.1.2	TRNK	Y	N	N	N	A	5000M/4000M	1000
2	2	IPS1/1	20.1.1.2	TRNK	Y	N	N	N	A	1000M/800M	1000
3	3	IPS1/1	20.1.1.2	DOWN	N	N	N	N	N	1000M/800M	1000
4	4	IPS1/1	20.1.1.2	DOWN	N	N	N	N	N	1000M/800M	1000
5	5	IPS1/1	20.1.1.2	DOWN	N	N	N	N	N	1000M/800M	1000
6	6	IPS1/1	20.1.1.2	DOWN	N	N	N	N	N	1000M/800M	1000
7	7	IPS1/2.1	30.1.1.2	TRNK	Y	N	N	N	M2	1000M/800M	1000
8	8	IPS1/2.2	31.1.1.2	TRNK	Y	N	N	N	M2	1000M/800M	1000
9	9	IPS1/2.3	32.1.1.2	DOWN	N	N	N	N	N	1000M/800M	1000
10	10	IPS1/2.4	33.1.1.2	DOWN	N	N	N	N	N	1000M/800M	1000
11	11	IPS1/2.5	34.1.1.2	DOWN	N	N	N	N	N	1000M/800M	1000
12	12	IPS1/2.6	35.1.1.2	DOWN	N	N	N	N	N	1000M/800M	1000

### Example 2-4 Displaying the FCIP Interface Summary of Counters for a Specified Interface

```
switch# show interface fcip 1
```

```
fcip1 is trunking
  Hardware is IPStorage
  Port WWN is 20:2b:00:2a:6a:1b:60:70
  Peer port WWN is 20:62:8c:60:4f:73:d7:80
  Admin port mode is auto, trunk mode is on
  snmp link state traps are enabled
  Port mode is TE
  Port vsan is 1
  Operating Speed is 5 Gbps
  Trunk vsans (admin allowed and active) (1)
  Trunk vsans (up) (1)
  Trunk vsans (isolated) ()
  Trunk vsans (initializing) ()
```

Interface last changed at Wed Nov 27 15:12:25 2019

Using Profile id 1 (interface IPStorage1/1)

Peer Information

Peer Internet address is 10.1.1.6 and port is 3225  
 Write acceleration mode is configured off  
 Tape acceleration mode is configured off  
 Tape Accelerator flow control buffer size is automatic  
 FICON XRC Accelerator is configured off  
 Ficon Load Balancer configured off for all vsans  
 Ficon Tape acceleration configured off for all vsans  
 IP Compression is enabled and set for mode2  
 Maximum number of TCP connections is 5  
 QOS control code point is 0  
 QOS data code point is 0  
 TCP Connection Information  
 5 Active TCP connections  
 27 Attempts for active connections, 2 close of connections  
 Path MTU 1500 bytes  
 Current retransmission timeout is 6400 ms  
 Current Send Buffer Size: 87080 KB, Requested Send Buffer Size: 62500 KB  
 CWM Burst Size: 50 KB

CONN<0>

Data connection: Local 10.1.1.12:65489, Remote 10.1.1.6:3225

TCP Parameters

Advertized window: Current: 24580 KB, Maximum: 24580 KB, Scale: 6  
 Peer receive window: Current: 8191 KB, Maximum: 8191 KB, Scale: 7  
 Congestion window: Current: 7372 KB, Slow start threshold: 8094 KB  
 Measured RTT : 500000 us Min RTT: 500000 us Max RTT: 0 us  
 Round trip time: Smoothed 0 ms, Variance: 100 Jitter: 150 us

TCP Connection Rate

Input Bytes: 0.00 MB/sec, Output Bytes: 0.00 MB/sec  
 Input Frames: 0/sec, Output Frames: 0/sec

CONN<1>

Data connection: Local 10.1.1.12:65487, Remote 10.1.1.6:3225

TCP Parameters

Advertized window: Current: 487 KB, Maximum: 24580 KB, Scale: 6  
 Peer receive window: Current: 8191 KB, Maximum: 8191 KB, Scale: 7  
 Congestion window: Current: 870 KB, Slow start threshold: 8094 KB  
 Measured RTT : 500000 us Min RTT: 7573 us Max RTT: 0 us  
 Round trip time: Smoothed 8 ms, Variance: 4 Jitter: 150 us

TCP Connection Rate

Input Bytes: 0.00 MB/sec, Output Bytes: 0.00 MB/sec  
 Input Frames: 0/sec, Output Frames: 0/sec

CONN<2>

Data connection: Local 10.1.1.12:65485, Remote 10.1.1.6:3225

TCP Parameters

Advertized window: Current: 477 KB, Maximum: 24580 KB, Scale: 6  
 Peer receive window: Current: 8191 KB, Maximum: 8191 KB, Scale: 7  
 Congestion window: Current: 853 KB, Slow start threshold: 8094 KB  
 Measured RTT : 500000 us Min RTT: 7419 us Max RTT: 0 us  
 Round trip time: Smoothed 8 ms, Variance: 4 Jitter: 150 us

TCP Connection Rate

Input Bytes: 0.00 MB/sec, Output Bytes: 0.00 MB/sec  
 Input Frames: 0/sec, Output Frames: 0/sec

CONN<3>

Data connection: Local 10.1.1.12:65483, Remote 10.1.1.6:3225

TCP Parameters

Advertized window: Current: 488 KB, Maximum: 24580 KB, Scale: 6  
 Peer receive window: Current: 8191 KB, Maximum: 8191 KB, Scale: 7  
 Congestion window: Current: 872 KB, Slow start threshold: 8094 KB  
 Measured RTT : 500000 us Min RTT: 7590 us Max RTT: 0 us  
 Round trip time: Smoothed 8 ms, Variance: 4 Jitter: 150 us

TCP Connection Rate

```

Input Bytes: 0.00 MB/sec, Output Bytes: 0.00 MB/sec
Input Frames: 0/sec, Output Frames: 0/sec
CONN<4>
Control connection: Local 10.1.1.12:65481, Remote 10.1.1.6:3225
TCP Parameters
  Advertized window: Current: 335 KB, Maximum: 24580 KB, Scale: 6
  Peer receive window: Current: 8125 KB, Maximum: 8125 KB, Scale: 7
  Congestion window: Current: 50 KB, Slow start threshold: 8069 KB
  Measured RTT : 18 us Min RTT: 18 us Max RTT: 23 us
  Round trip time: Smoothed 1 ms, Variance: 1 Jitter: 150 us
TCP Connection Rate
  Input Bytes: 0.00 MB/sec, Output Bytes: 0.00 MB/sec
  Input Frames: 0/sec, Output Frames: 0/sec
  5 minutes input rate 208 bits/sec, 26 bytes/sec, 0 frames/sec
  5 minutes output rate 272 bits/sec, 34 bytes/sec, 0 frames/sec
  1658 frames input, 174756 bytes
    1658 Class F frames input, 174756 bytes
    0 Class 2/3 frames input, 0 bytes
    0 Reass frames
    0 Error frames timestamp error 0
  1663 frames output, 202836 bytes
    1663 Class F frames output, 202836 bytes
    0 Class 2/3 frames output, 0 bytes
    0 Error frames

```

### Example 2-5 Displaying the FCIP Interface Summary of Counters for a Specified Interface

```

switch# show interface fcip 1

fcip1 is trunking
  Hardware is IPStorage
  Port WWN is 20:62:8c:60:4f:73:d7:80
  Peer port WWN is 20:2b:00:2a:6a:1b:60:70
  Admin port mode is auto, trunk mode is on
  snmp link state traps are enabled
  Port mode is TE
  Port vsan is 1
  Operating Speed is 10000 Mbps
  Trunk vsans (admin allowed and active) (1)
  Trunk vsans (up) (1)
  Trunk vsans (isolated) ()
  Trunk vsans (initializing) ()
  Interface last changed at Tue Nov 26 15:16:55 2019

Using Profile id 1 (interface IPStorage2/3)
Peer Information
  Peer Internet address is 10.1.1.12 and port is 3225
  Write acceleration mode is configured off
  Tape acceleration mode is configured off
  Tape Accelerator flow control buffer size is automatic
  FICON XRC Accelerator is configured off
  Ficon Load Balancer configured off for all vsans
  Ficon Tape acceleration configured off for all vsans
  IP Compression is enabled and set for mode2
  Maximum number of TCP connections is 5
  QOS control code point is 0
  QOS data code point is 0
TCP Connection Information
  5 Active TCP connections
  23 Attempts for active connections, 5 close of connections
  Path MTU 1500 bytes
  Current retransmission timeout is 200 ms
  Current Send Buffer Size: 149580 KB, Requested Send Buffer Size: 125000 KB

```

```

CWM Burst Size: 50 KB
CONN<0>
Data connection: Local 10.1.1.6:3225, Remote 10.1.1.12:65489
TCP Parameters
  Advertized window: Current: 24580 KB, Maximum: 24580 KB, Scale: 7
  Peer receive window: Current: 4095 KB, Maximum: 4095 KB, Scale: 6
  Congestion window: Current: 3686 KB, Slow start threshold: 3998 KB
  Measured RTT : 500000 us Min RTT: 500000 us Max RTT: 0 us
  Round trip time: Smoothed 24 ms, Variance: 12 Jitter: 150 us
TCP Connection Rate
  Input Bytes: 0.00 MB/sec, Output Bytes: 0.00 MB/sec
  Input Frames: 0/sec, Output Frames: 0/sec
CONN<1>
Data connection: Local 10.1.1.6:3225, Remote 10.1.1.12:65487
TCP Parameters
  Advertized window: Current: 24580 KB, Maximum: 24580 KB, Scale: 7
  Peer receive window: Current: 487 KB, Maximum: 487 KB, Scale: 6
  Congestion window: Current: 438 KB, Slow start threshold: 462 KB
  Measured RTT : 500000 us Min RTT: 500000 us Max RTT: 0 us
  Round trip time: Smoothed 24 ms, Variance: 12 Jitter: 150 us
TCP Connection Rate
  Input Bytes: 0.00 MB/sec, Output Bytes: 0.00 MB/sec
  Input Frames: 0/sec, Output Frames: 0/sec
CONN<2>
Data connection: Local 10.1.1.6:3225, Remote 10.1.1.12:65485
TCP Parameters
  Advertized window: Current: 24580 KB, Maximum: 24580 KB, Scale: 7
  Peer receive window: Current: 477 KB, Maximum: 477 KB, Scale: 6
  Congestion window: Current: 429 KB, Slow start threshold: 453 KB
  Measured RTT : 500000 us Min RTT: 500000 us Max RTT: 0 us
  Round trip time: Smoothed 24 ms, Variance: 12 Jitter: 150 us
TCP Connection Rate
  Input Bytes: 0.00 MB/sec, Output Bytes: 0.00 MB/sec
  Input Frames: 0/sec, Output Frames: 0/sec
CONN<3>
Data connection: Local 10.1.1.6:3225, Remote 10.1.1.12:65483
TCP Parameters
  Advertized window: Current: 24580 KB, Maximum: 24580 KB, Scale: 7
  Peer receive window: Current: 488 KB, Maximum: 488 KB, Scale: 6
  Congestion window: Current: 439 KB, Slow start threshold: 463 KB
  Measured RTT : 500000 us Min RTT: 500000 us Max RTT: 0 us
  Round trip time: Smoothed 24 ms, Variance: 12 Jitter: 150 us
TCP Connection Rate
  Input Bytes: 0.00 MB/sec, Output Bytes: 0.00 MB/sec
  Input Frames: 0/sec, Output Frames: 0/sec
CONN<4>
Control connection: Local 10.1.1.6:3225, Remote 10.1.1.12:65481
TCP Parameters
  Advertized window: Current: 8123 KB, Maximum: 24580 KB, Scale: 7
  Peer receive window: Current: 334 KB, Maximum: 334 KB, Scale: 6
  Congestion window: Current: 50 KB, Slow start threshold: 373 KB
  Measured RTT : 19 us Min RTT: 20 us Max RTT: 25 us
  Round trip time: Smoothed 1 ms, Variance: 1 Jitter: 150 us
TCP Connection Rate
  Input Bytes: 0.00 MB/sec, Output Bytes: 0.00 MB/sec
  Input Frames: 0/sec, Output Frames: 0/sec
5 minutes input rate 288 bits/sec, 36 bytes/sec, 0 frames/sec
5 minutes output rate 224 bits/sec, 28 bytes/sec, 0 frames/sec
1130 frames input, 137324 bytes
  1130 Class F frames input, 137324 bytes
  0 Class 2/3 frames input, 0 bytes
  0 Reass frames
  0 Error frames timestamp error 0
1132 frames output, 119060 bytes

```

```

1132 Class F frames output, 119060 bytes
0 Class 2/3 frames output, 0 bytes
0 Error frames

```

### Example 2-6 Displaying Detailed FCIP Interface Standard Counter Information

```

switch# show interface fcip 1 counters
fcip1
  TCP Connection Information
    5 Active TCP connections
    27 Attempts for active connections, 2 close of connections
    Path MTU 1500 bytes
    Current retransmission timeout is 6400 ms
    Current Send Buffer Size: 87080 KB, Requested Send Buffer Size: 62500 KB
    CWM Burst Size: 50 KB
CONN<0>
  Data connection: Local 10.1.1.12:65489, Remote 10.1.1.6:3225
  TCP Parameters
    Advertized window: Current: 24580 KB, Maximum: 24580 KB, Scale: 6
    Peer receive window: Current: 8191 KB, Maximum: 8191 KB, Scale: 7
    Congestion window: Current: 7372 KB, Slow start threshold: 8094 KB
    Measured RTT : 500000 us Min RTT: 500000 us Max RTT: 0 us
    Round trip time: Smoothed 0 ms, Variance: 100 Jitter: 150 us
  TCP Connection Rate
    Input Bytes: 0.00 MB/sec, Output Bytes: 0.00 MB/sec
    Input Frames: 0/sec, Output Frames: 0/sec
CONN<1>
  Data connection: Local 10.1.1.12:65487, Remote 10.1.1.6:3225
  TCP Parameters
    Advertized window: Current: 487 KB, Maximum: 24580 KB, Scale: 6
    Peer receive window: Current: 8191 KB, Maximum: 8191 KB, Scale: 7
    Congestion window: Current: 870 KB, Slow start threshold: 8094 KB
    Measured RTT : 500000 us Min RTT: 7573 us Max RTT: 0 us
    Round trip time: Smoothed 8 ms, Variance: 4 Jitter: 150 us
  TCP Connection Rate
    Input Bytes: 0.00 MB/sec, Output Bytes: 0.00 MB/sec
    Input Frames: 0/sec, Output Frames: 0/sec
CONN<2>
  Data connection: Local 10.1.1.12:65485, Remote 10.1.1.6:3225
  TCP Parameters
    Advertized window: Current: 477 KB, Maximum: 24580 KB, Scale: 6
    Peer receive window: Current: 8191 KB, Maximum: 8191 KB, Scale: 7
    Congestion window: Current: 853 KB, Slow start threshold: 8094 KB
    Measured RTT : 500000 us Min RTT: 7419 us Max RTT: 0 us
    Round trip time: Smoothed 8 ms, Variance: 4 Jitter: 150 us
  TCP Connection Rate
    Input Bytes: 0.00 MB/sec, Output Bytes: 0.00 MB/sec
    Input Frames: 0/sec, Output Frames: 0/sec
CONN<3>
  Data connection: Local 10.1.1.12:65483, Remote 10.1.1.6:3225
  TCP Parameters
    Advertized window: Current: 488 KB, Maximum: 24580 KB, Scale: 6
    Peer receive window: Current: 8191 KB, Maximum: 8191 KB, Scale: 7
    Congestion window: Current: 872 KB, Slow start threshold: 8094 KB
    Measured RTT : 500000 us Min RTT: 7590 us Max RTT: 0 us
    Round trip time: Smoothed 8 ms, Variance: 4 Jitter: 150 us
  TCP Connection Rate
    Input Bytes: 0.00 MB/sec, Output Bytes: 0.00 MB/sec
    Input Frames: 0/sec, Output Frames: 0/sec
CONN<4>
  Control connection: Local 10.1.1.12:65481, Remote 10.1.1.6:3225
  TCP Parameters
    Advertized window: Current: 333 KB, Maximum: 24580 KB, Scale: 6

```

```

Peer receive window: Current: 8122 KB, Maximum: 8122 KB, Scale: 7
Congestion window: Current: 50 KB, Slow start threshold: 8069 KB
Measured RTT : 500000 us Min RTT: 18 us Max RTT: 0 us
Round trip time: Smoothed 1 ms, Variance: 1 Jitter: 150 us
TCP Connection Rate
Input Bytes: 0.00 MB/sec, Output Bytes: 0.00 MB/sec
Input Frames: 0/sec, Output Frames: 0/sec
5 minutes input rate 224 bits/sec, 28 bytes/sec, 0 frames/sec
5 minutes output rate 288 bits/sec, 36 bytes/sec, 0 frames/sec
1686 frames input, 177260 bytes
  1686 Class F frames input, 177260 bytes
  0 Class 2/3 frames input, 0 bytes
  0 Reass frames
  0 Error frames timestamp error 0
1691 frames output, 206072 bytes
  1691 Class F frames output, 206072 bytes
  0 Class 2/3 frames output, 0 bytes
  0 Error frames
IP compression statistics
83360 rxbytes
  55942 rxbytes compressed, 0 rxbytes non-compressed
  1.49 rx compression ratio
99132 txbytes
  64015 txbytes compressed, 1152 txbytes non-compressed
  1.52 tx compression ratio
IP compression flow control statistics
0 bytes queued for hw compression
0 queued for hardware compression
0 queued for hardware decompression
0 slowed tcp flow control
0 accelerated tcp flow control
0 side band flow control ON
2346 side band flow control OFF
IP compression hung statistics
0 times compression engine hung detected
0 jobs replayed for hardware compression
0 jobs replayed for hardware decompression
0 compression jobs not processed during compression engine reset
0 compression response job not processed during compression engine reset
0 decompression jobs not processed during decompression engine reset
0 decompression response job not processed during decompression engine reset

```

### Example 2-7 Displaying the FCIP Interface Description

```

switch# show interface fcip 51 description
FCIP51
Sample FCIP interface

```

The transmitted bytes shown in the total *txbytes* counter is the amount of data before compression. After compression, the compressed *txbytes* bytes are transmitted with compression and the uncompressed *txbytes* bytes are transmitted without compression. A packet may be transmitted without compression, if it becomes bigger after compression (see [Example 2-4](#) and [Example 2-5](#)).

### Example 2-8 Displaying Brief FCIP Interface Counter Information (Cisco MDS 9250i Multiservice Fabric Switch)

```

switch# show interface fcip 1-12 counters brief
-----
Interface          Input (rate is 5 min avg)      Output (rate is 5 min avg)
-----
Rate      Total          Rate      Total

```

	MB/s	Frames	MB/s	Frames
fcip1	191	1155974124	225	1363537690
fcip2	173	1046686124	227	1372311228
fcip3	0	0	0	0
fcip4	0	0	0	0
fcip5	0	0	0	0
fcip6	0	0	0	0
fcip7	189	1143612956	221	1339130294
fcip8	194	1167499884	218	1317700800
fcip9	0	0	0	0
fcip10	0	0	0	0
fcip11	0	0	0	0
fcip12	0	0	0	0

**Example 2-9 Displaying Brief FCIP Interface Counter Information (24/10 port SAN Extension Module)**

```
switch# show interface fcip 41 counters brief
```

Interface	Input (rate is 5 min avg)		Output (rate is 5 min avg)	
	Rate	Total	Rate	Total
	MB/s	Frames	MB/s	Frames
fcip41	191	1155974124	225	1363537690

## Advanced FCIP Features

You can significantly improve application performance by configuring one or more of the following options for the FCIP interface:

- [FCIP Write Acceleration, page 2-44](#)
- [Configuring FCIP Write Acceleration, page 2-47](#)
- [Displaying Write Acceleration Activity Information, page 2-47](#)
- [FCIP Tape Acceleration, page 2-48](#)
- [Configuring FCIP Tape Acceleration, page 2-53](#)
- [Displaying Tape Acceleration Activity Information, page 2-53](#)
- [FCIP Compression, page 2-55](#)
- [Configuring FCIP Compression, page 2-56](#)
- [Displaying FCIP Compression Information, page 2-56](#)
- [Configuring FCIP Links for Maximum Performance, page 2-57](#)
- [Enabling Sequential Upgrade of Data Path Processors, page 2-61](#)

## FCIP Write Acceleration

The FCIP Write Acceleration feature enables you to significantly improve the application write performance when storage traffic is routed over wide area networks using FCIP. When FCIP Write Acceleration is enabled, WAN throughput is maximized by acknowledging the write frames from the sender at the closer FCIP switch, thereby eliminating the impact of WAN latency for write operations. The Write Acceleration feature is disabled by default and must be enabled on both sides of the FCIP link.

**Note**

FCIP links using Write Acceleration (WA) must be ensured that all accelerated flows go through a single FCIP link (or port channel). This applies to both commands and responses in both directions. If that does not occur, then FCIP WA will fail. Consequently, FCIP WA cannot be used across FSPF equal cost paths because commands and responses could take different paths.

**Note**

Ensure that all FCIP links in a port channel have the same attributes such as 2 or 5 connections, WA, TA, and so on. Otherwise, you will encounter undesirable results during an upgrade.

**Note**

The FCIP Write Acceleration feature accelerates FC standard compliant SCSI WRITE commands only.

**Note**

IBM Peer-to-Peer Remote Copy (PPRC) is not supported by FCIP Write Acceleration.

In [Figure 2-9](#), the SCSI WRITE command without Write Acceleration requires two round-trip transfers (RTT), while the SCSI WRITE command with Write Acceleration only requires one RTT. The maximum sized Transfer Ready is sent from the host side of the FCIP link back to the host before the SCSI WRITE command reaches the target. This enables the host to start sending the write data without waiting for the long latency over the FCIP link of the SCSI WRITE command and Transfer Ready. It also eliminates the delay caused by multiple Transfer Readys needed for the exchange going over the FCIP link.

Figure 2-9 FCIP Link Write Acceleration

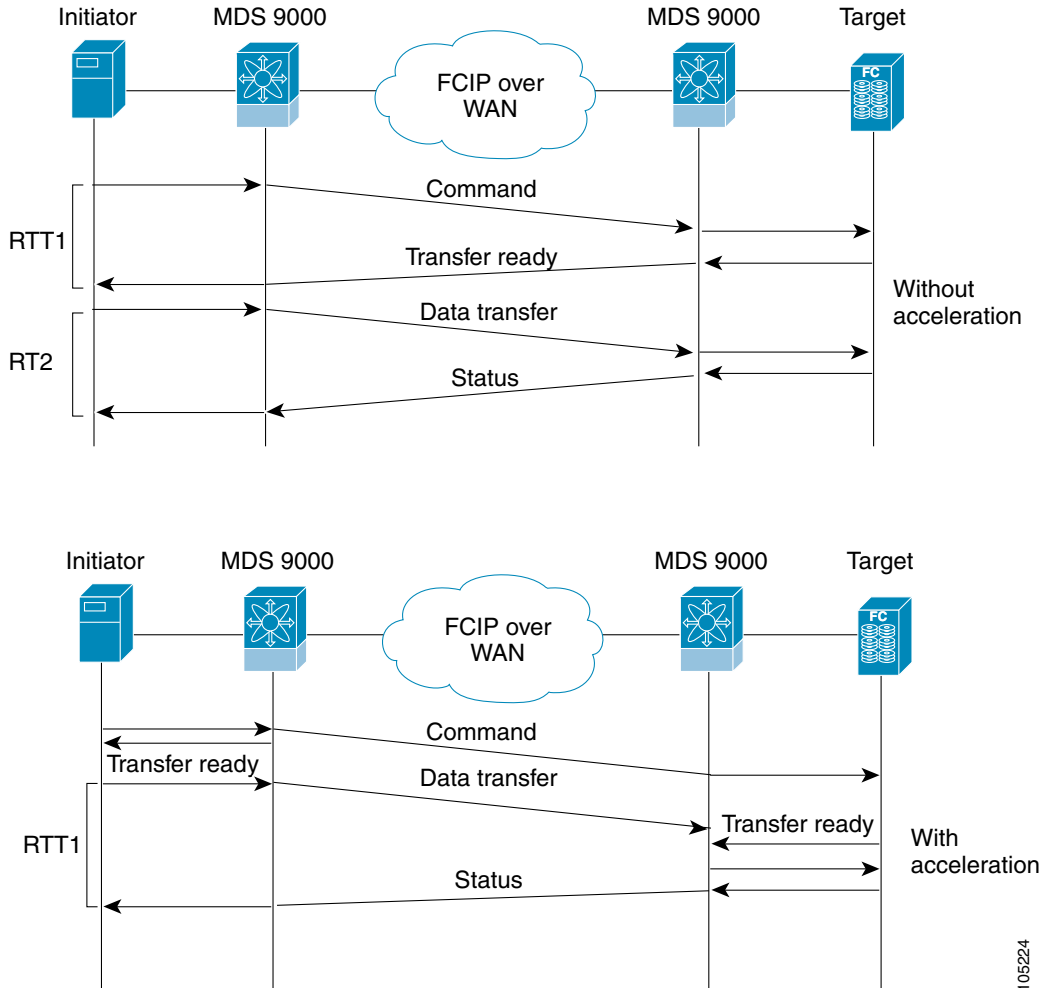
**Tip**

FCIP Write Acceleration (WA) can be enabled for multiple FCIP links if the links are part of a port channel configured with "channel mode active". These are port channels constructed with Port Channel Protocol (PCP). Write Acceleration cannot be used across FSPF equal cost paths in FCIP deployments. Native Fibre Channel Write Acceleration can be used with port channels. Also, FCIP Write Acceleration can be used in port channels configured with channel mode active or constructed with Port Channel Protocol (PCP). FCIP WA does not work if multiple non-port channel FCIP links exist with equal cost between the initiator and the target ports. This configuration might cause either SCSI discovery failure or failed WRITE or READ operations. When FCIP WA is used the FSPF routing should ensure that a single FCIP Port-Channel or ISL is always in the path between the initiator and the target ports.

Only one FCIP port channel is supported per VSAN on FCIPs configured on Cisco MDS 9700 Series switches with Write Acceleration configured.

**Tip**

Do not enable time stamp control on an FCIP interface with Write Acceleration configured.

105224

**Note**

From Cisco MDS NX-OS Release 7.3(1)DY(1) and later, FCIP Write Acceleration can be enabled when FCIP port channels are configured between a Cisco MDS 9250i switch and a Cisco MDS 24/10 port SAN Extension Module in a Cisco MDS 9700 Director.

Ensure that the following prerequisites are met before enabling Write Acceleration:

- Use the **fcip-enhanced** command on the Cisco MDS 9220i and MDS 9250i switches while creating new port channels for FCIP ports. For more information on creating port channels, see the [Configuring Port Channels](#) chapter in the Cisco MDS 9000 Series Interfaces Configuration Guide. For more information on the **fcip-enhanced** command, see the [Cisco MDS 9000 Series Command Reference](#).
- When you configure FCIP port channels between Cisco MDS 9250i and MDS 9700 switches and if write acceleration is enabled on the FCIP ports, then ensure that you enable write acceleration on the FCIP port-channels using the **fcip-enhanced** command on the Cisco MDS 9250i switch. For more information on creating port channels, see the [Configuring Port Channels](#) chapter in the Cisco MDS 9000 Series Interfaces Configuration Guide. For more information on the **fcip-enhanced** command, see the [Cisco MDS 9000 Series Command Reference](#).
- Use the **show port-channel database** command to ensure that only FCIP interfaces are members of port channels.
- Enable **passive-mode** on FCIP interfaces created on a Cisco MDS 24/10 port SAN Extension Module in a Cisco MDS 9700 Director. For more information on enabling passive mode, see the [Configuring Active Connections](#) section.

**Note**

In Cisco MDS NX-OS Release 8.1(1) and later, Write Acceleration on FCIP port channels should not be configured between two MDS 9700 Series switches with Cisco MDS 24/10 port SAN Extension Module under the following conditions:

- If traffic flows between an FCoE port and an FC port through an FCIP port channel.
- If traffic flows through two successive FCIP port channels, one after another.

## Configuring FCIP Write Acceleration

To enable Write Acceleration, follow these steps:

	Command	Purpose
Step 1	switch1# <b>configure terminal</b>	Enters configuration mode.
Step 2	switch1(config)# <b>interface fcip 51</b>	Creates an FCIP interface (51).
Step 3	switch1(config-if)# <b>write-accelerator</b>	Enables Write Acceleration.

## Displaying Write Acceleration Activity Information

[Example 2-10](#) through [Example 2-12](#) show how to display information about Write Acceleration activity.

**Example 2-10 Displaying the Exchanges Processed by Write Acceleration at the Specified Host-End FCIP Link**

```
switch# show fcip host-map 100

MAP TABLE (5 entries TOTAL entries 5)

OXID | RXID | HOST FCID| TARG FCID| VSAN | Index
-----+-----+-----+-----+-----+-----
0xd490|0xffff|0x00690400|0x00620426|0x0005|0x0000321f
0xd4a8|0xffff|0x00690400|0x00620426|0x0005|0x00003220
0xd4c0|0xffff|0x00690400|0x00620426|0x0005|0x00003221
0xd4d8|0xffff|0x00690400|0x00620426|0x0005|0x00003222
0xd4f0|0xffff|0x00690400|0x00620426|0x0005|0x00003223
```

**Example 2-11 Displaying Exchanges Processed by Write Acceleration at the Specified Target End FCIP Link**

```
switch# show fcip target-map 100

MAP TABLE (3 entries TOTAL entries 3)

OXID | RXID | HOST FCID| TARG FCID| VSAN | Index
-----+-----+-----+-----+-----+-----
0xc308|0xffff|0x00690400|0x00620426|0x0005|0x00003364
0xc320|0xffff|0x00690400|0x00620426|0x0005|0x00003365
0xc338|0xffff|0x00690400|0x00620426|0x0005|0x00003366
```

**Example 2-12 Displaying Detailed FCIP Interface Write Acceleration Counter Information**

```
switch# show interface fcip 4 counters
fcip4
  TCP Connection Information
  ...
  Write Accelerator statistics
    6091 packets in      5994 packets out
    0 frames dropped  0 CRC errors
    0 rejected due to table full
    0 ABTS sent      0 ABTS received
    0 tunnel synchronization errors
    37 writes recd      37 XFER_RDY sent (host)
    0 XFER_RDY rcvd (target)
    37 XFER_RDY rcvd (host)
    0 XFER_RDY not proxied due to flow control (host)
    0 bytes queued for sending
    0 estimated bytes queued on the other side for sending
    0 times TCP flow ctrl(target)
    0 bytes current TCP flow ctrl(target)
```

## FCIP Tape Acceleration

The FCIP Tape Acceleration feature enables you to significantly improve application write performance when storage traffic is routed over wide area networks using FCIP. When FCIP Tape Acceleration is enabled, WAN throughput is maximized by acknowledging the frames from the sender at the closer FCIP switch, thereby eliminating the impact of WAN latency for write operations. The FCIP TAPE Acceleration feature is disabled by default and must be enabled on both sides of the FCIP link.

Tapes are storage devices that store and retrieve user data sequentially. Cisco MDS NX-OS provides both tape write and read acceleration.

Applications that access tape drives normally have only one SCSI WRITE or READ operation outstanding to it. This single command process limits the benefit of the tape acceleration feature when using an FCIP link over a long-distance WAN link. It impacts backup and performance because each SCSI WRITE or READ operation does not complete until the host receives a good status response from the tape drive. The FCIP tape acceleration feature helps solve this problem. It improves tape backup, archive, and restore operations by allowing faster data streaming between the host and tape drive over the WAN link.

In an example of tape acceleration for write operations, the backup server in [Figure 2-10](#) issues write operations to a drive in the tape library. Acting as a proxy for the remote tape drives, the local Cisco MDS switch proxies a transfer ready to signal the host to start sending data. After receiving all the data, the local Cisco MDS switch proxies the successful completion of the SCSI WRITE operation. This response allows the host to start the next SCSI WRITE operation. This proxy method results in more data being sent over the FCIP link in the same time period compared to the time taken to send data without proxying. The proxy method improves the performance on WAN links.

**Figure 2-10** FCIP Link Tape Acceleration for Write Operations

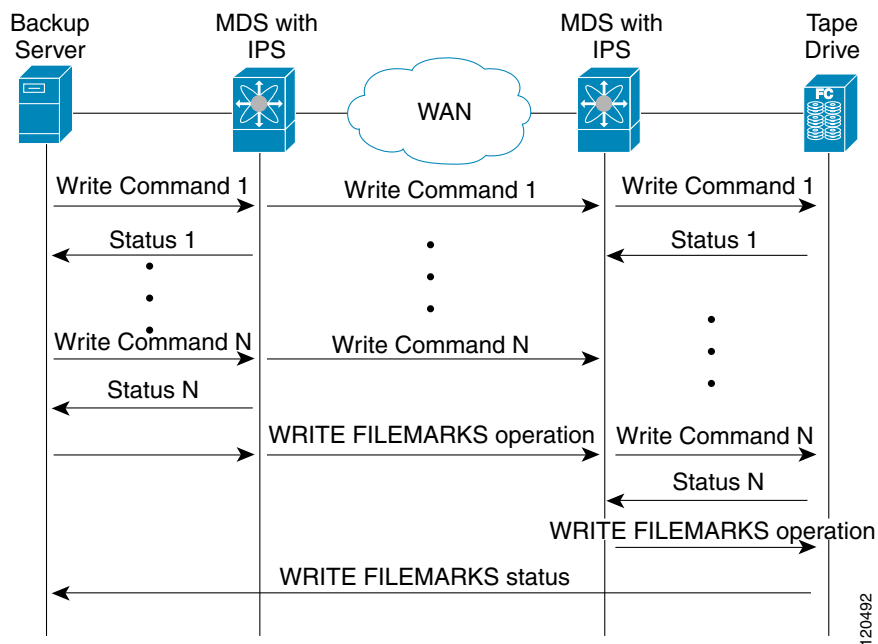

At the tape end of the FCIP link, another Cisco MDS switch buffers the command and data it has received. It then acts as a backup server to the tape drive by listening to a transfer ready from the tape drive before forwarding the data.



**Note**

In some cases such as a quick link up/down event (FCIP link, Server/Tape Port link) in a tape library environment that exports Control LUN or a Medium Changer as LUN 0 and tape drives as other LUNs, tape acceleration may not detect the tape sessions and may not accelerate these sessions. You need to keep the FCIP link disabled for a couple of minutes before enabling the link. This does not apply to tape environments where the tape drives are either direct FC attached or exported as LUN 0.

The Cisco NX-OS provides reliable data delivery to the remote tape drives using TCP/IP over the WAN. It maintains write data integrity by allowing the WRITE FILEMARKS operation to complete end-to-end without proxying. The WRITE FILEMARKS operation signals the synchronization of the buffer data with the tape library data. While tape media errors are returned to backup servers for error handling, tape busy errors are retried automatically by the Cisco NX-OS software.

In an example of tape acceleration for read operations, the restore server in Figure 2-11 issues read operations to a drive in the tape library. During the restore process, the remote Cisco MDS switch at the tape end, in anticipation of more SCSI read operations from the host, sends out SCSI read operations on its own to the tape drive. The prefetched read data is cached at the local Cisco MDS switch. The local Cisco MDS switch on receiving SCSI read operations from the host, sends out the cached data. This method results in more data being sent over the FCIP link in the same time period compared to the time taken to send data without read acceleration for tapes. This improves the performance for tape reads on WAN links.

**Figure 2-11 FCIP Link Tape Acceleration for Read Operations**

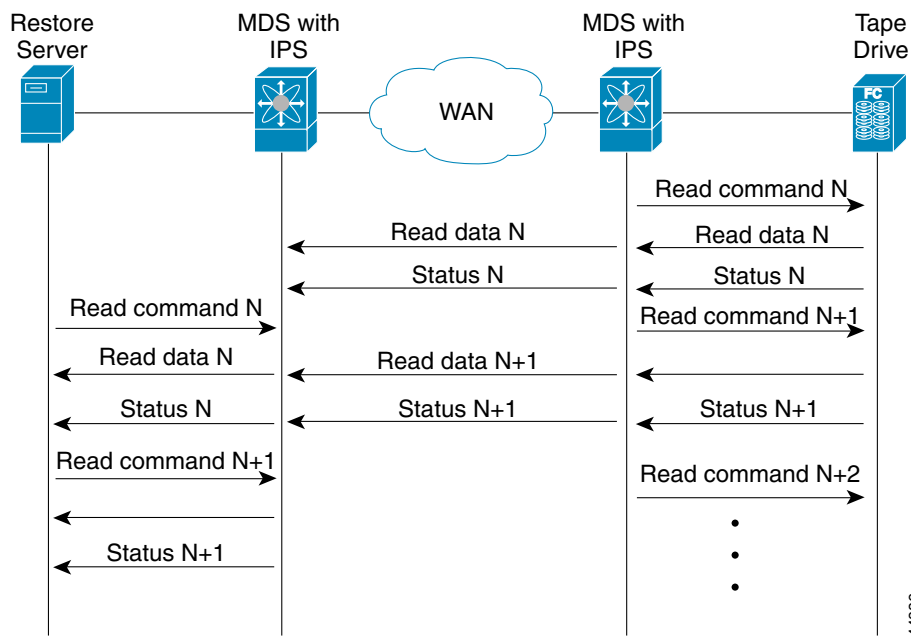

The Cisco NX-OS provides reliable data delivery to the restore application using TCP/IP over the WAN. While tape media errors during the read operation are returned to the restore server for error handling, the Cisco NX-OS software recovers from any other errors.



**Note**

The FCIP tape acceleration feature is disabled by default and must be enabled on both sides of the FCIP link. If it is only enabled on one side of the FCIP link, the tape acceleration feature is operationally off.



**Tip**

FCIP tape acceleration does not work if the FCIP port is part of a port channel or if there are multiple paths between the initiator and the target port. Such a configuration might cause either SCSI discovery failure or broken write or read operations.

When tape acceleration is enabled in an FCIP interface, a FICON VSAN cannot be enabled in that interface. Likewise, if an FCIP interface is up in a FICON VSAN, tape acceleration cannot be enabled on that interface.

**Note**

When you enable the tape acceleration feature for an FCIP link, the link is reinitialized and the write and read acceleration feature is also automatically enabled.

In tape acceleration for writes, after a certain amount of data has been buffered at the remote Cisco MDS switch, the write operations from the host are flow controlled by the local Cisco MDS switch by not proxying the Transfer Ready. On completion of a write operation when some data buffers are freed, the local Cisco MDS switch resumes the proxying. Likewise, in tape acceleration for reads, after a certain amount of data has been buffered at the local Cisco MDS switch, the read operations to the tape drive are flow controlled by the remote Cisco MDS switch by not issuing any further reads. On completion of a read operation, when some data buffers are freed, the remote Cisco MDS switch resumes issuing reads.

The default flow control buffering uses the **automatic** option. This option takes the WAN latencies and the speed of the tape into account to provide optimum performance. You can also specify a flow control buffer size (the maximum buffer size is 12 MB).

We recommend that you use the default option for flow-control buffering.

**Note**

Starting from Cisco MDS NX-OS Release 7.3(0)DY(1), FCIP tape acceleration will work with five TCP connections.

**Tip**

Do not enable time-stamp control on an FCIP interface with tape acceleration configured.

### Tape Library LUN Mapping for FCIP Tape Acceleration

If a tape library provides logical unit (LU) mapping and FCIP tape acceleration is enabled, you must assign a unique LU number (LUN) to each physical tape drive accessible through a target port.

[Figure 2-12](#) shows tape drives connected to Switch 2 through a single target port. If the tape library provides LUN mapping, then all the four tape drives should be assign unique LUNs.

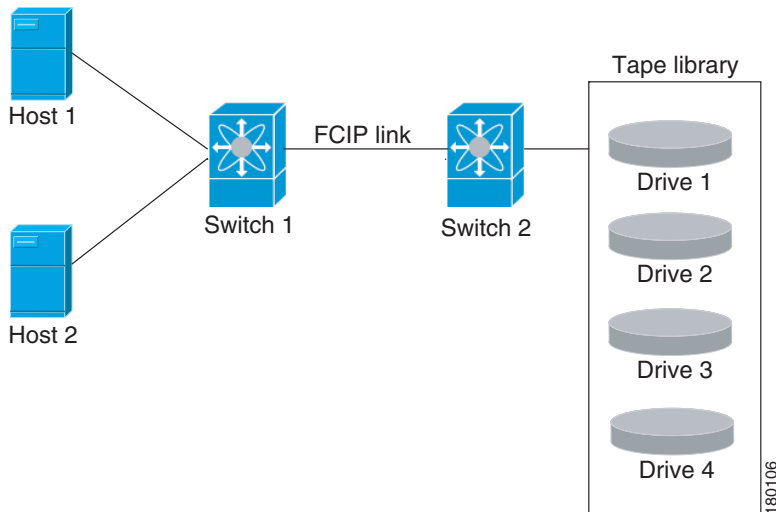
**Figure 2-12 FCIP LUN Mapping Example**

For the mappings described in [Table 2-2](#) and [Table 2-3](#), Host 1 has access to Drive 1 and Drive 2, and Host 2 has access to Drive 3 and Drive 4.

[Table 2-2](#) describes correct tape library LUN mapping.

**Table 2-2 Correct LUN Mapping Example with Single Host Access**

Host	LUN Mapping	Drive
Host 1	LUN 1	Drive 1
	LUN 2	Drive 2
Host 2	LUN 3	Drive 3
	LUN 4	Drive 4

[Table 2-3](#) describes incorrect tape library LUN mapping.

**Table 2-3 Incorrect LUN Mapping Example with Single Hosts Access**

Host	LUN Mapping	Drive
Host 1	LUN 1	Drive 1
	LUN 2	Drive 2
Host 2	LUN 1	Drive 3
	LUN 2	Drive 4

Another example setup is when a tape drive is shared by multiple hosts through a single tape port. For instance, Host 1 has access to Drive 1 and Drive 2, and Host 2 has access to Drive 2, Drive 3, and Drive 4. A correct LUN mapping configuration for such a setup is shown in [Table 2-4](#).

**Table 2-4 Correct LUN Mapping Example with Multiple Host Access**

Host	LUN Mapping	Drive
Host 1	LUN 1	Drive 1
	LUN 2	Drive 2

**Table 2-4 Correct LUN Mapping Example with Multiple Host Access**

Host	LUN Mapping	Drive
Host 2	LUN 2	Drive 2
	LUN 3	Drive 3
	LUN 4	Drive 4

## Configuring FCIP Tape Acceleration



**Note** In an FCIP tape acceleration link, if the trunk mode is **on** for TA enabled links, then the trunk mode allowed VSAN should be configured such that each VSAN's traffic passes through only one link. If the traffic passes through multiple links, it may cause traffic failures.

To enable FCIP tape acceleration, follow these steps:

	Command	Purpose
<b>Step 1</b>	<code>switch1# configure terminal</code>	Enters configuration mode.
<b>Step 2</b>	<code>switch1(config)# interface fcip 5</code>	Creates an FCIP interface (5).
<b>Step 3</b>	<code>switch1(config-if)# write-accelerator tape-accelerator</code>	Enables tape acceleration (and Write Acceleration—if not already enabled).
<b>Step 4</b>	<code>switch1(config-if)# write-accelerator tape-accelerator flow-control-buffer-size auto</code>	Enables tape acceleration with automatic flow control (default).
<b>Step 5</b>	<code>switch1(config-if)# write-accelerator tape-accelerator flow-control-buffer-size 2048</code>	Sets tape acceleration flow control buffer size to 2 MB.
<b>Step 6</b>	<code>switch1(config-if)# no write-accelerator tape-accelerator</code>	(Optional) Disables tape acceleration (default) and resets the FCIP link.  <b>Note</b> The Write Acceleration feature remains enabled.
<b>Step 7</b>	<code>switch1(config-if)# no write-accelerator tape-accelerator flow-control-buffer-size 2048</code>	(Optional) Changes the flow control buffer size to the default value of automatic. The tape acceleration and Write Acceleration features remain enabled. This command does not reset the FCIP link.
<b>Step 8</b>	<code>switch1(config-if)# no write-accelerator</code>	(Optional) Disables both the Write Acceleration and tape acceleration features and resets the FCIP link.

## Displaying Tape Acceleration Activity Information

[Example 2-13](#) through [Example 2-16](#) show how to display information about tape acceleration activity.

### **Example 2-13 Displaying Information About Tapes for Which Exchanges are Tape Accelerated**

```
switch# show fcip tape-session summary
```

-----

Tunnel	Tunnel End	host-fcid	tape-fcid	lun	vsan	TCP Connection
16	host-end	0x7c0006	0x390006	0x0000	3000	0
16	host-end	0x7c0004	0x390004	0x0000	3000	0
16	host-end	0x7c0003	0x390003	0x0000	3000	0
16	host-end	0x7c0007	0x390007	0x0000	3000	0
16	host-end	0x7c0005	0x390005	0x0000	3000	0
16	host-end	0x7c0000	0x390000	0x0000	3000	0
16	host-end	0x7c0002	0x390002	0x0000	3000	0

**Example 2-14 Displaying Information About Tapes for Which Exchanges are Tape Accelerated at the Host-End FCIP Link**

```
switch# show fcip tape-session tunnel 1 host-end

HOST TAPE SESSIONS (1 entries TOTAL entries 1)

Host Tape Session #1
  FCID 0xEF0001, VSAN 1, LUN 0x0002
  Outstanding Exchanges 0, Outstanding Writes 0
  Target End Write Buffering 0 Bytes, Auto Max Writes 3
  Flags 0x0, FSM state Non TA Mode
  Cached Reads 0
  First index 0xffffffff7, Last index 0xffffffff7, RA index 0x0000f99a
  Current index=0xffffffffe, Els Oxid 0xfff7
  Hosts 1
    FCID 0x770100
```

**Example 2-15 Displaying Information About Tapes for Which Exchanges are Tape Accelerated at the Target-End FCIP Link**

```
switch# show fcip tape-session tunnel 1 targ-end

TARGET TAPE SESSIONS (1 entries TOTAL entries 1)

Target Tape Session #1
  FCID 0xEF0001, VSAN 1, LUN 0x0002
  Outstanding Exchanges 0, Outstanding Writes 0
  Host End Read Buffering 0 Bytes, Auto Max Read Blocks 3
  Flags 0x800, Timer Flags 0x0
  FSM State Default, Prev FSM State Bypass
  Relative Block offset 0
  First index 0xffffffff7, Last index 0xffffffff7, RA index 0x0000f99a
  Current index=0xffffffffe, Els Oxid 0xfff7
  Hosts 1
    FCID 0x770100
```

**Example 2-16 Displays Detailed FCIP Interface Tape Acceleration Counter Information, if Enabled**

```
switch# show interface fcip 1 counters
fcip1
  TCP Connection Information
  ....
  Tape Accelerator statistics
    1 Host Tape Sessions
    0 Target Tape Sessions
  Host End statistics
    Received 31521 writes, 31521 good status, 0 bad status
```

```

Sent 31517 proxy status, 4 not proxied
Estimated Write buffer 0 writes 0 bytes
Received 31526 reads, 10 status
Sent 31516 cached reads
Read buffer 0 reads, 0 bytes
Host End error recovery statistics
Sent REC 0, received 0 ACCs, 0 Rejects
Sent ABTS 0, received 0 ACCs
Received 31 RECs, sent 2 ACCs, 0 Rejects
Received 0 SRRs, sent 0 ACCs, 0 Rejects
Received 0 TMF commands
Target End statistics
Received 0 writes, 0 good status, 0 bad status
Write Buffer 0 writes, 0 bytes
Received 0 reads, 0 good status, 0 bad status
Sent 0 reads, received 0 good status, 0 bad status
Sent 0 rewinds, received 0 good status, 0 bad status
Estimated Read buffer 0 reads, 0 bytes
Target End error recovery statistics
Sent REC 0, received 0 ACCs, 0 Rejects
Sent SRR 0, received 0 ACCs
Sent ABTS 0, received 0 ACCs
Received 0 TMF commands

```

## FCIP Compression

The FCIP compression option allows IP packets to be compressed on an FCIP link. This option is enabled per FCIP link. The FCIP maximum bandwidth configuration is calculated on the size of the FC frames. Since compression is done at the IP layer and FC is above the IP layer, enabling compression will not cause FCIP interfaces to transmit more than without it (that is, not increase FC throughput). Rather, it helps in reducing the amount of IP traffic sent over the IP network (that is, reduces the IP load). By default, FCIP compression is disabled. When enabled without specifying a compression mode, a compression algorithm appropriate for the FCIP service engine and link speed (as configured in the TCP parameters of the FCIP profile) is automatically used.



### Note

The main purpose of the FCIP compression feature is to increase throughput on low bandwidth IP connections which are hitting maximum bandwidth usage. Depending on the IP Services switch or module used, the performance of the built-in IP compression engine can be significantly lower than the maximum line rate of IPStorage ports. Therefore, configuring FCIP compression on high bandwidth links can be detrimental to the overall application level performance.

The Cisco MDS 9250i switch and Cisco 24/10 port SAN Extension Module supports Auto, Mode1 and Mode2 compression modes. All of these modes internally use the hardware compression engine in the module. Auto mode is enabled by default. Mode2 uses a larger batch size for compression than Auto-mode, which results in higher compression throughput. However, Mode2 incurs a small latency due to the compression throughput. For those deployments where aggressive throughput is most important, Mode2 can be used. Mode1 gives the best compression ratio when compared to all other modes. For those deployments where compression ratio is most important, Mode1 can be used.



### Note

If both ends of an FCIP link are running Cisco MDS NX-OS Release 8.1(1) or later, and you enable compression at one end of the FCIP link, be sure to enable it at the other end of the link also.

**Note**

When using FCIP compression, the rates specified in **tcp max-bandwidth-xxxx** and **min-available-bandwidth-xxxx** in the FCIP profile are in compressed bites.

## Configuring FCIP Compression

To enable FCIP compression, follow these steps:

	Command	Purpose
<b>Step 1</b>	switch# <b>configure terminal</b>	Enters configuration mode.
<b>Step 2</b>	switch(config)# <b>interface fcip 51</b>	Creates an FCIP interface (51).
<b>Step 3</b>	switch(config-if)# <b>ip-compression mode2</b>	Enables high compression.
<b>Step 4</b>	switch(config-if)# <b>ip-compression auto</b>	(Optional) Defaults to using the <b>auto</b> mode.
<b>Step 5</b>	switch(config-if)# <b>no ip-compression</b>	(Optional) Disables (default) the FCIP compression feature.

## Displaying FCIP Compression Information

[Example 2-17](#) and [Example 2-19](#) show how to display FCIP compression information.

### **Example 2-17 Displaying Detailed FCIP Interface Compression Information, if Enabled**

```
switch# show interface fcip 4 counters
fcip4
  TCP Connection Information
  ...
  IP compression statistics
    208752 rxbytes, 208752 rxbytes compressed
    5143584 txbytes
      0 txbytes compressed, 5143584 txbytes non-compressed
      1.00 tx compression ratio
```

### **Example 2-18 Displaying the Compression Engine Statistics for the 9250i**

```
switch# (config-vsan-db)# show ips stats hw-comp interface IPStorage 1/1
HW Compression statistics for port IPStorage1/1
  Compression stats
    10444189094728 input bytes, 2822607905236 output compressed bytes
    85952406 input pkts, 85952065 output compressed pkts
  Decompression stats
    8596899248 input compressed bytes, 27669956608 output bytes
    45879853 input compressed pkts, 45879669 output pkts
  Passthru stats
    0 input bytes, 0 output bytes
    0 input pkts, 0 output pkts
  Miscellaneous stats
    0 min input pktlen, 638570 max input pktlen
    0 min output pktlen, 185641 max output pktlen
    0 len mismatch, 0 incomplete processing
    0 invalid result, 0 invalid session drop
    0 comp expanded
  Errors stats
```

```

0 decomp tx error, 0 post comp error
0 post decomp error, 0 comp packets expanded

```

### Example 2-19 Displaying the Compression Engine Statistics for 24/10 port SAN Extension Module

```

switch# show ips stats hw-comp interface ipStorage 5/1

HW Compression statistics for port IPStorage5/1
  Compression stats
    53280732 input bytes, 44561835 output compressed bytes
    544700 input pkts, 544700 output compressed pkts
  Decompression stats
    41760802 input compressed bytes, 49574684 output bytes
    511886 input compressed pkts, 511886 output pkts
  Passthru stats
    0 input bytes, 0 output bytes
    0 input pkts, 0 output pkts
  Miscellaneous stats
    0 min input pktlen, 3816 max input pktlen
    0 min output pktlen, 1485 max output pktlen
    0 len mismatch, 0 incomplete processing
    0 invalid result, 0 invalid session drop
    0 comp expanded
  Errors stats
    0 decomp tx error, 0 post comp error
    0 post decomp error, 0 comp packets expanded

```

## Configuring FCIP Links for Maximum Performance

This section describes how to configure FCIP links for optimum performance between two Cisco MDS 9250i switches, or two 24/10 port SAN Extension Modules. We recommend that the maximum and minimum bandwidth parameters in an FCIP profile be the same on both the sides.



### Note

- FCIP links with a **tcp max-bandwidth-mbps** of 33 Mbps or less will result in FSPF cost of 30000. This makes the interface unusable. Starting from Cisco MDS NX-OS Releases 8.2(1), the FSPF cost for low bandwidth FCIP links is set to 28999. Because this value is less than the FSPF maximum cost of 30000, and it will allow the traffic to be routed across the interface. It also allows additional FC or FCoE hops (including the FCIP hop) in the end-to-end path. The total FSPF cost of these additional hops should not exceed 1000, because the path will not be usable. If the FSPF cost of 28999 is not applicable for a specific topology, it should be manually configured using the **fspf cost interface** configuration command. To check the FSPF cost of an interface, use the **show fspf interface** command.  
For more information on FSPF Cost, see the [Cisco MDS Fabric Configuration Guide](#).
- FSPF equal cost multipath (ECMP) cannot be used to load balance the traffic across different types of ISLs. In other words, two or more equal cost ISLs of a different type between two switches (e.g. FCIP + FC, or FCIP + FCoE) is not supported.
- On Cisco MDS 24/10 Port SAN Extension Module, configuring multiple ECMP port channels with FCIP members in the same VSAN is not a valid configuration. If this is configured, then traffic will flow through only one of the port channels.

## Configuring FCIP Links for Maximum Performance on a Cisco MDS 9250i Switch

To achieve maximum FCIP performance in 10 Gbps mode, the following configuration is recommended:

- 
- Step 1** Create an FCIP link on the IPStorage port.  
If more than two FCIP links are bound to an IPStorage interface at 10 Gbps, the combined maximum bandwidth of all links bound to that interface must not exceed 10 Gbps.
  - Step 2** Set the TCP maximum and minimum bandwidth to 5000 Mbps and 4000 Mbps respectively (default value).
  - Step 3** Configure five TCP connections on each FCIP link.
  - Step 4** Set the MTU size to 2500 on the IPStorage port.
- 

To achieve maximum FCIP performance in 10 Gbps mode, follow these configuration steps:

	<b>Command</b>	<b>Purpose</b>
<b>Step 1</b>	<code>switch# configure terminal</code>	Enters global configuration mode.
<b>Step 2</b>	<code>switch(config)# fcip profile profile-id</code>	Configures an FCIP profile and enters FCIP profile configuration mode.
<b>Step 3</b>	<code>switch(config-profile)# ip address ip-address</code>	Assigns an IP address to the FCIP profile. The assigned IP address can be an IPv4 or an IPv6 address.
<b>Step 4</b>	<code>switch(config-profile)# tcp max-bandwidth-mbps 5000 min-available-bandwidth-mbps 4000 round-trip-time-ms milliseconds</code>	Sets the maximum and minimum available bandwidth of the FCIP link to 5000 Mbps and 4000 Mbps respectively, and configures the round-trip time in milliseconds.
<b>Step 5</b>	<code>switch(config-profile)# exit</code>	Exits FCIP profile configuration mode and returns to global configuration mode.
<b>Step 6</b>	<code>switch(config)# interface fcip interface-number</code>	Enters FCIP interface configuration mode.
<b>Step 7</b>	<code>switch(config-if)# use-profile profile-id</code>	Binds the specified profile to the FCIP link.
<b>Step 8</b>	<code>switch(config-if)# peer-info ipaddr ip-address</code>	Configures the peer IP address (IPv4 or IPv6).
<b>Step 9</b>	<code>switch(config-if)# tcp-connections 5</code>	Sets the number of TCP connections to 5. This value must be the same at the peer end.
<b>Step 10</b>	<code>switch(config-if)# no shutdown</code>	Enables the FCIP interface.
<b>Step 11</b>	<code>switch(config-if)# exit</code>	Exits FCIP interface configuration mode and returns to global configuration mode.
<b>Step 12</b>	<code>switch(config)# interface IPStorage slot-number/port-number</code>	Enters IPStorage interface configuration mode.
<b>Step 13</b>	<code>switch(config-if)# ip address ip-address subnet-mask</code>	Assigns an IP address to the interface.
<b>Step 14</b>	<code>switch(config-if)# switchport mtu 2500</code>	Sets the MTU size to 2500 for the interface. The valid range for MTU is from 576 to 9216.

	Command	Purpose
Step 15	switch(config-if)# <b>no shutdown</b>	Enables the interface.
Step 16	switch(config-if)# <b>end</b>	Exits interface configuration mode and returns to privileged EXEC mode.

To achieve maximum FCIP performance in 1 Gbps mode, the following configuration is recommended:

**Step 1** Create an FCIP link on the IPStorage port.



**Note** If more than one FCIP link is bound to an IPStorage interface at 1 Gbps, the combined maximum bandwidth of all links bound to that interface must not exceed 1 Gbps.

**Step 2** Set the TCP maximum and minimum bandwidth as 1000 Mbps and 800 Mbps respectively.



**Note** If the TCP maximum bandwidth is set to any value more than 1000 Mbps, we recommend that you set the number of TCP connections to five.

**Step 3** Configure two TCP connections on each FCIP link.

**Step 4** Set the MTU size to 2500 for the IPStorage port.

**Step 5** Enable compression on each FCIP link.

To achieve maximum FCIP performance in 1 Gbps mode, follow these configuration steps:

	Command	Purpose
Step 1	switch# <b>configure terminal</b>	Enters global configuration mode.
Step 2	switch(config)# <b>fcip profile</b> <i>profile-id</i>	Configures an FCIP profile and enters FCIP profile configuration mode.
Step 3	switch(config-profile)# <b>ip address</b> <i>ip-address</i>	Assigns an IP address to the FCIP profile. The assigned IP address can be an IPv4 or an IPv6 address.
Step 4	switch(config-profile)# <b>tcp</b> <b>max-bandwidth-mbps</b> 1000 <b>min-available-bandwidth-mbps</b> 800 <b>round-trip-time-ms</b> <i>milliseconds</i>	Sets the maximum and minimum available bandwidth of the FCIP link to 1000 Mbps and 800 Mbps respectively, and configures the round-trip time in milliseconds.
Step 5	switch(config-profile)# <b>exit</b>	Exits FCIP profile configuration mode and returns to global configuration mode.
Step 6	switch(config)# <b>interface fcip</b> <i>interface-number</i>	Enters FCIP interface configuration mode.
Step 7	switch(config-if)# <b>use-profile</b> <i>profile-id</i>	Binds the specified profile to the FCIP link.
Step 8	switch(config-if)# <b>peer-info ipaddr</b> <i>ip-address</i>	Configures the peer IP address (IPv4 or IPv6).

	Command	Purpose
Step 9	switch(config-if)# <b>tcp-connections</b> 2	Sets the number of TCP connections to 2. This value must be the same at the peer end.
Step 10	switch(config-if)# <b>ip-compression mode2</b>	Sets the compression algorithm to <b>mode2</b> for the interface. The other modes that can be set are <b>auto</b> and <b>mode1</b> .
Step 11	switch(config-if)# <b>no shutdown</b>	Enables the FCIP interface.
Step 12	switch (config-if)# <b>exit</b>	Exits FCIP interface configuration mode and returns to global configuration mode.
Step 13	switch(config)# <b>interface IPStorage slot-number/port-number</b>	Enters IPStorage interface configuration mode.
Step 14	switch(config-if)# <b>ip address ip-address subnet-mask</b>	Assigns an IP address to the interface.
Step 15	switch(config-if)# <b>switchport mtu 2500</b>	Sets the MTU size to 2500 for the interface. The valid range for MTU is from 576 to 9216.
Step 16	switch(config-if)# <b>no shutdown</b>	Enables the interface.
Step 17	switch(config-if)# <b>end</b>	Exits interface configuration mode and returns to privileged EXEC mode.

### Configuring FCIP Links for Maximum Performance on Cisco MDS 24/10 port SAN Extension Module

To achieve maximum FCIP performance in 10 Gbps mode, the following configuration is recommended:

- 
- Step 1** Create an FCIP link on the IPStorage port.
- If more than two FCIP links are bound to an IPStorage interface at 10 Gbps, the combined maximum bandwidth of all links bound to that interface must not exceed 10 Gbps.
- Step 2** Set the TCP maximum and minimum bandwidth to 10000 Mbps and 8000 Mbps respectively (default value).
- Step 3** Configure five TCP connections on each FCIP link.
- Step 4** Set the MTU size to 2500 on the IPStorage port.
- 

To achieve maximum FCIP performance in 10 Gbps mode, follow these configuration steps:

	Command	Purpose
Step 1	switch# <b>configure terminal</b>	Enters global configuration mode.
Step 2	switch(config)# <b>fcip profile profile-id</b>	Configures an FCIP profile and enters FCIP profile configuration mode.
Step 3	switch(config-profile)# <b>ip address ip-address</b>	Assigns an IP address to the FCIP profile. The assigned IP address can be an IPv4 or an IPv6 address.
Step 4	switch(config-profile)# <b>tcp max-bandwidth-mbps 10000 min-available-bandwidth-mbps 8000 round-trip-time-ms milliseconds</b>	Sets the maximum and minimum available bandwidth of the FCIP link to 10000 Mbps and 8000 Mbps respectively, and configures the round-trip time in milliseconds.

	Command	Purpose
Step 5	switch(config-profile)# <b>exit</b>	Exits FCIP profile configuration mode and returns to global configuration mode.
Step 6	switch(config)# <b>interface fcip</b> <i>interface-number</i>	Enters FCIP interface configuration mode.
Step 7	switch(config-if)# <b>use-profile</b> <i>profile-id</i>	Binds the specified profile to the FCIP link.
Step 8	switch(config-if)# <b>peer-info ipaddr</b> <i>ip-address</i>	Configures the peer IP address (IPv4 or IPv6).
Step 9	switch(config-if)# <b>tcp-connections</b> 5	Sets the number of TCP connections to 5. This value must be the same at the peer end.
Step 10	switch(config-if)# <b>no shutdown</b>	Enables the FCIP interface.
Step 11	switch(config-if)# <b>exit</b>	Exits FCIP interface configuration mode and returns to global configuration mode.
Step 12	switch(config)# <b>interface IPStorage</b> <i>slot-number/port-number</i>	Enters IPStorage interface configuration mode.
Step 13	switch(config-if)# <b>ip address</b> <i>ip-address</i> <i>subnet-mask</i>	Assigns an IP address to the interface.
Step 14	switch(config-if)# <b>switchport mtu</b> 2500	Sets the MTU size to 2500 for the interface. The valid range for MTU is from 576 to 9216.
Step 15	switch(config-if)# <b>no shutdown</b>	Enables the interface.
Step 16	switch(config-if)# <b>end</b>	Exits interface configuration mode and returns to privileged EXEC mode.

To achieve maximum FCIP performance in 1 Gbps mode, the following configuration is recommended:

**Step 1** Create an FCIP link on the IPStorage port.



**Note** If more than one FCIP link is bound to an IPStorage interface at 1 Gbps, the combined maximum bandwidth of all links bound to that interface must not exceed 1 Gbps.

**Step 2** Set the TCP maximum and minimum bandwidth as 1000 Mbps and 800 Mbps respectively.



**Note** If the TCP maximum bandwidth is set to a value that is more than 1000 Mbps, we recommend that you set the number of TCP connections to five.

**Step 3** Configure two TCP connections on each FCIP link.

**Step 4** Set the MTU size to 2500 for the IPStorage port.

To achieve maximum FCIP performance in 1 Gbps mode, follow these configuration steps:

	<b>Command</b>	<b>Purpose</b>
<b>Step 1</b>	switch# <b>configure terminal</b>	Enters global configuration mode.
<b>Step 2</b>	switch(config)# <b>fcip profile</b> <i>profile-id</i>	Configures an FCIP profile and enters FCIP profile configuration mode.
<b>Step 3</b>	switch(config-profile)# <b>ip address</b> <i>ip-address</i>	Assigns an IP address to the FCIP profile. The assigned IP address can be an IPv4 or an IPv6 address.
<b>Step 4</b>	switch(config-profile)# <b>tcp</b> <b>max-bandwidth-mbps</b> 1000 <b>min-available-bandwidth-mbps</b> 800 <b>round-trip-time-ms</b> <i>milliseconds</i>	Sets the maximum and minimum available bandwidth of the FCIP link to 1000 Mbps and 800 Mbps respectively, and configures the round-trip time in milliseconds.
<b>Step 5</b>	switch(config-profile)# <b>exit</b>	Exits FCIP profile configuration mode and returns to global configuration mode.
<b>Step 6</b>	switch(config)# <b>interface fcip</b> <i>interface-number</i>	Enters FCIP interface configuration mode.
<b>Step 7</b>	switch(config-if)# <b>use-profile</b> <i>profile-id</i>	Binds the specified profile to the FCIP link.
<b>Step 8</b>	switch(config-if)# <b>peer-info ipaddr</b> <i>ip-address</i>	Configures the peer IP address (IPv4 or IPv6).
<b>Step 9</b>	switch(config-if)# <b>tcp-connections</b> 2	Sets the number of TCP connections to 2. This value must be the same at the peer end.
<b>Step 10</b>	switch(config-if)# <b>ip-compression mode2</b>	Sets the compression algorithm to <b>mode2</b> for the interface. The other modes that can be set are <b>auto</b> and <b>mode1</b> .
<b>Step 11</b>	switch (config-if)# <b>no shutdown</b>	Enables the FCIP interface.
<b>Step 12</b>	switch (config-if)# <b>exit</b>	Exits FCIP interface configuration mode and returns to global configuration mode.
<b>Step 13</b>	switch(config)# <b>interface IPStorage</b> <i>slot-number/port-number</i>	Enters IPStorage interface configuration mode.
<b>Step 14</b>	switch(config-if)# <b>ip address</b> <i>ip-address</i> <i>subnet-mask</i>	Assigns an IP address to the interface.
<b>Step 15</b>	switch(config-if)# <b>switchport mtu</b> 2500	Sets the MTU size to 2500 for the interface. The valid range for MTU is from 576 to 9216.
<b>Step 16</b>	switch(config-if)# <b>no shutdown</b>	Enables the interface.
<b>Step 17</b>	switch(config-if)# <b>end</b>	Exits interface configuration mode and returns to privileged EXEC mode.

## Verifying FCIP Configuration

To verify FCIP configurations, use the following commands:

Command	Purpose
<b>show fcip host-map</b> <i>fcip-id</i>	Displays the information for a specified map.
<b>show fcip profile</b> <i>profile-id</i>	Displays the information for a profile.
<b>show fcip summary</b>	Displays summary information.
<b>show interface fcip</b>	Displays the status of an interface.
<b>show interface fcip</b> <i>fcip-id</i> <b>counters</b>	Displays the interface counter information.
<b>show interface fcip</b> <i>fcip-id</i> <b>counters brief</b>	Displays brief information of interface counters.
<b>show interface fcip</b> <i>fcip-id</i> <b>description</b>	Displays the interface description.
<b>show fcip target-map</b>	Displays information for a specified target map.
<b>show fcip tape-session summary</b>	Displays tape session information.
<b>show fcip tape-session tunnel 1 host-end</b>	Displays information for a specified FCIP link ID.
<b>show fcip tape-session tunnel 1 targ-end</b>	Displays information for the target end.
<b>show ips stats hw-comp all</b>	Displays hardware compression statistics.
<b>show port-channel database</b>	Displays port channel database information.

## Default Settings for FCIP Parameters

Table 2-5 lists the default settings for FCIP parameters.

**Table 2-5** Default FCIP Parameters

Parameters	Default
TCP default port for FCIP	3225
Base port for TCP connections to peer	2
Minimum retransmit time	200 milliseconds
Keepalive timeout	60 sec
Maximum retransmissions	4 retransmissions
PMTU discovery	Enabled
PMTU enable reset timeout	3600 seconds
SACK	Enabled
Maximum bandwidth (Cisco MDS 24/10 port SAN Extension Module)	10 Gbps

**Table 2-5** *Default FCIP Parameters (continued)*

<b>Parameters</b>	<b>Default</b>
Maximum bandwidth (Cisco MDS 9220i Fabric Switch)	10 Gbps
Maximum bandwidth (Cisco MDS 9250i Multiservice Fabric Switch)	5 Gbps
Minimum available bandwidth (Cisco MDS 24/10 port SAN Extension Module)	8 Gbps
Minimum available bandwidth (Cisco MDS 9220i Fabric Switch)	8 Gbps
Minimum available bandwidth (Cisco MDS 9250i Multiservice Fabric Switch)	4 Gbps
Round trip time	1 millisecond
Buffer size	0 KB
Control TCP and data connection	No packets are transmitted
TCP congestion window monitoring	Enabled
Burst size	50 KB
TCP connection mode	Active mode
FCIP timestamp	Disabled
Acceptable difference range to accept packets	+/- 2000 milliseconds
B port keepalive responses	Disabled
Write Acceleration	Disabled
Tape Acceleration	Disabled



## Configuring the SAN Extension Tuner

---

The SAN Extension Tuner (SET) feature is unique to the Cisco MDS 9000 Family of switches. This feature helps you optimize FCIP performance by generating either direct access (magnetic disk) or sequential access (magnetic tape) SCSI I/O commands and directing such traffic to a specific virtual target. You can specify the size of the test I/O transfers and how many concurrent or serial I/Os to generate while testing. The SET reports the resulting I/Os per second (IOPS) and I/O latency, which helps you determine the number of concurrent I/Os needed to maximize FCIP throughput.

This chapter includes the following sections:

- [Overview of SAN Extension Tuner, page 3-81](#)
- [License Prerequisites, page 3-84](#)
- [Configuring the SAN Extension Tuner, page 3-84](#)
- [Using the SAN Extension Tuner Wizard, page 3-84](#)
- [Verifying the SAN Extension Tuner Configuration, page 3-92](#)
- [Default Settings for Tuning Parameters, page 3-93](#)

### Overview of SAN Extension Tuner

The SAN extension tuner (SET) feature is unique to the Cisco MDS 9000 Family of switches. This feature helps you optimize FCIP performance by generating either direct access (magnetic disk) or sequential access (magnetic tape) SCSI I/O commands and directing such traffic to a specific virtual target. Applications such as remote copy and data backup use FCIP over an IP network to connect across geographically distributed SANs. SET is implemented in IPS ports. When enabled, this feature can be used to generate SCSI I/O commands (read and write) to the virtual target based on your configured options.



**Note**

---

SAN Extension Tuner is not supported on the Cisco Fabric Switch for HP c-Class BladeSystem, the Cisco Fabric Switch for IBM BladeCenter, and 16-Port Storage Services Node (SSN-16).

---



**Note**

---

As of Cisco MDS SAN-OS Release 3.3(1a), SAN Extension Tuner is supported on the Multiservice Module (MSM) and the Multiservice Modular Switch.

---

Applications such as remote copy and data backup use FCIP over an IP network to connect across geographically distributed SANs. To achieve maximum throughput performance across the fabric, you can tune the following configuration parameters:

- The TCP parameters for the FCIP profile (see [“Window Management” section on page 2-31](#) for more information).
- The number of concurrent SCSI I/Os generated by the application.
- The transfer size used by the application over an FCIP link.

SET is implemented in IPS ports. When enabled, this feature can be used to generate SCSI I/O commands (read and write) to the virtual target based on your configured options (see [Figure 3-1](#)).

**Figure 3-1 SCSI Command Generation to the Virtual Target**

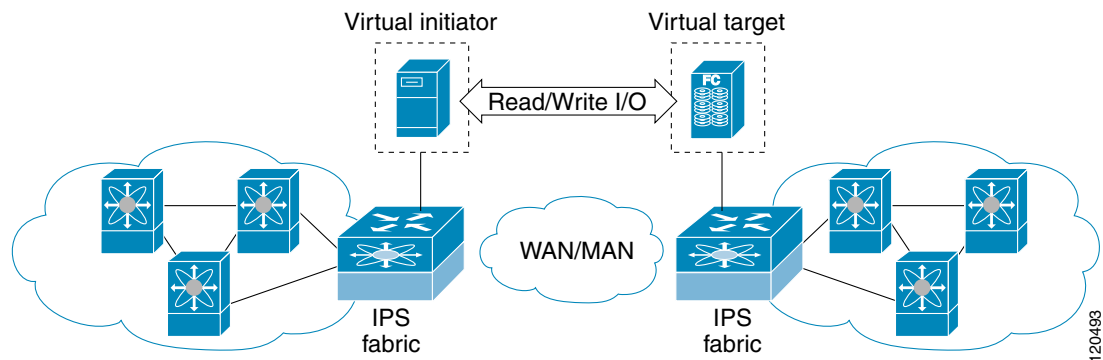

The SET feature assists with tuning by generating varying SCSI traffic workloads. It also measures throughput and response time per I/O over an FCIP link.

Before tuning the SAN fabric, be aware of the following guidelines:

- Following these implementation details:
  - The tuned configuration is not persistent.
  - The virtual N ports created do not register FC4 features supported with the name server. This is to avoid the hosts in the SAN from discovering these N ports as regular initiators or targets.
  - Login requests from other initiators in the SAN are rejected.
  - The virtual N ports do not implement the entire SCSI suite; it only implements the SCSI read and write commands.
  - Tuner initiators can only communicate with tuner targets.
- Verify that the Gigabit Ethernet interface is up at the physical layer (GBIC and Cable connected—an IP address is not required).
- Enable iSCSI on the switch (no other iSCSI configuration is required).
- Enable the interface (no other iSCSI interface configuration is required)
  - see [“Creating iSCSI Interfaces” section on page 4-100](#) for more information.
- Create an iSCSI interface on the Gigabit Ethernet interface and enable the interface (no other iSCSI interface configuration is required)
  - See [“Creating iSCSI Interfaces” section on page 4-100](#) for more information.
- Configure the virtual N ports in a separate VSAN or zone as required by your network.

- Be aware that a separate VSAN with only virtual N ports is not required, but is recommended as some legacy HBAs may fail if logins to targets are rejected.
- Do not use same Gigabit Ethernet interface to configure virtual N ports and FCIP links—use different Gigabit Ethernet interfaces. While this is not a requirement, it is recommended as the traffic generated by the virtual N ports may interfere with the performance of the FCIP link.

## SAN Extension Tuner Setup

Figure 3-2 provides a sample physical setup in which the virtual N ports are created on ports that are not a part of the FCIP link for which the throughput and latency is measured.

**Figure 3-2** N Port Tuning Configuration Physical Example

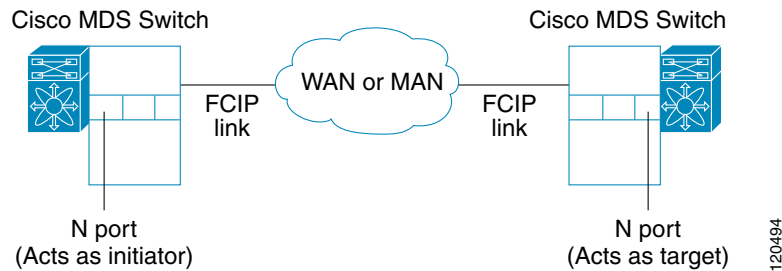
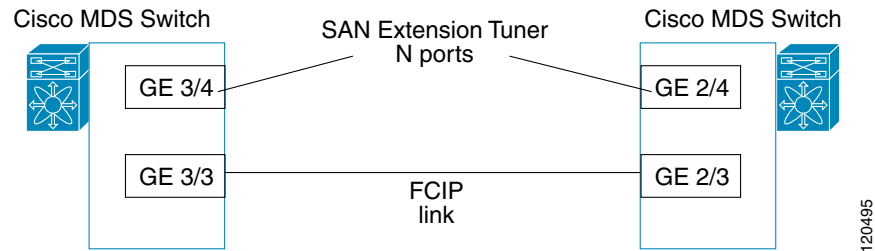

Figure 3-3 provides a sample logical setup in which the virtual N ports are created on ports that are not a part of the FCIP link for which the throughput and latency is measured.

**Figure 3-3** Logical Example of N Port Tuning for an FCIP Link



## Data Pattern

By default, an all-zero pattern is used as the pattern for data generated by the virtual N ports. You can optionally specify a file as the data pattern to be generated by selecting a data pattern file from one of three locations: the bootflash: directory, the volatile: directory, or the slot0: directory. This option is especially useful when testing compression over FCIP links. You can also use Canterbury corpus or artificial corpus files for benchmarking purposes.

## License Prerequisites

To use the SET, you need to obtain the SAN\_EXTN\_OVER\_IP license (see the *Cisco Family NX-OS Licensing Guide*).

## Configuring the SAN Extension Tuner

This section includes the following topics:

- [Tuning the FCIP Link, page 3-84](#)
- [Enabling the Tuner, page 3-87](#)
- [Configuring nWWN, page 3-87](#)
- [Configuring the Virtual N Port, page 3-88](#)
- [Generating SCSI Disk Read/Write IO, page 3-88](#)
- [Generating SCSI Tape Read/Write IO, page 3-90](#)
- [Configuring a Data Pattern, page 3-91](#)

## Tuning the FCIP Link

To tune the required FCIP link, follow these steps:

- 
- Step 1** Configure the nWWN for the virtual N ports on the switch.
- Step 2** Enable iSCSI on the interfaces on which you want to create the N ports.
- Step 3** Configure the virtual N ports on either side of the FCIP link.
- Step 4** Ensure that the virtual N ports are not visible to real initiators in the SAN. You can use zoning (see the *Cisco Fabric Manager Fabric Configuration Guide* *Cisco MDS 9000 Family NX-OS Fabric Configuration Guide*) to segregate the real initiators. Ensure that the zoning configuration is set up to allow the virtual N ports to communicate with each other.
- Step 5** Start the SCSI read and write I/Os.
- Step 6** Add more N ports (as required) to other Gigabit Ethernet ports in the switch to obtain maximum throughput. One scenario that may require additional N ports is if you use FCIP PortChannels.
- 

## Using the SAN Extension Tuner Wizard

### Using the SAN Extension Tuner Wizard

Use the SAN Extension Tuner wizard to perform the these tasks:

- Configuring nWWN ports
- Enabling iSCSI
- Configuring Virtual N ports
- Assigning SCSI read and write CLI commands
- Assigning SCSI tape read and write CLI commands

- Configuring a data pattern for SCSI commands

To tune the required FCIP link using the SAN Extension Tuner Wizard in Fabric Manager, follow these steps:

- Step 1** Right-click a valid FCIP link in the Fabric pane, and then select **SAN Extension Tuner** from the drop-down list. You can also highlight the link and choose **Tools > Other > SAN Extension Tuner**. You see the Select Ethernet Port Pair dialog box (see [Figure 3-4](#)).

**Figure 3-4** Select Ethernet Port Pair Dialog Box

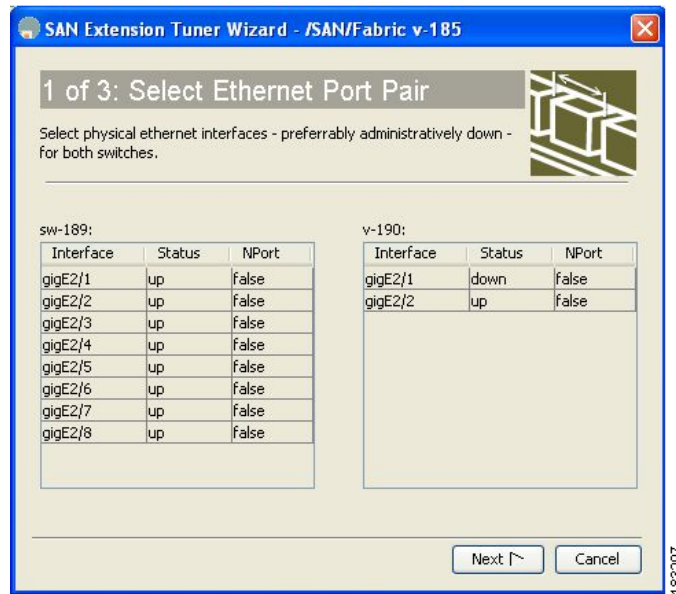

- Step 2** Select the Ethernet port pairs that correspond to the FCIP link you want to tune and click **Next**.



**Note** The Ethernet ports you select should be listed as down.

You see the Specify Parameters dialog box (see [Figure 3-5](#)).

- Step 3** Create and activate a new zone to ensure that the virtual N ports are not visible to real initiators in the SAN by clicking **Yes** to the zone creation dialog box.

**Figure 3-5 Specify Parameters Dialog Box**

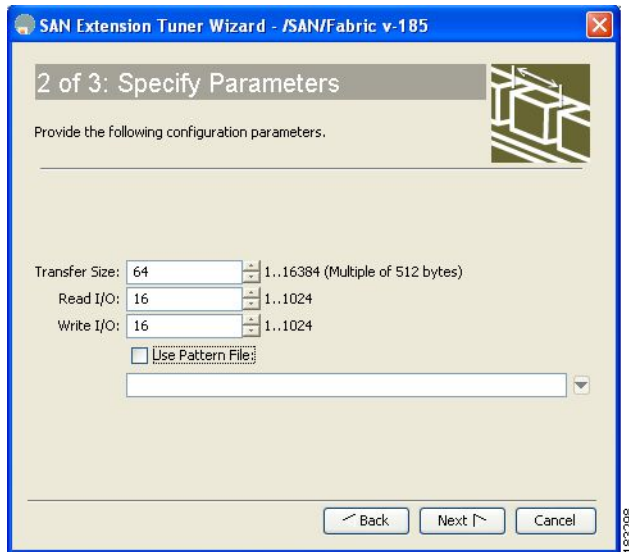

- Step 4** (Optional) Change the default settings for the transfer data size and the number of concurrent SCSI read and write commands as follows:
- Set Transfer Size to the number of bytes that you expect your applications to use over the FCIP link.
  - Set Read I/O to the number of concurrent SCSI read commands you expect your applications to generate over the FCIP link.
  - Set Write I/O to the number of concurrent outstanding SCSI write commands you expect your applications to generate over the FCIP link.



**Note** There is only one outstanding I/O at a time to the virtual N port that emulates the tape behavior.

- Check the **Use Pattern File** check box and select a file that you want to use to set the data pattern that is generated by the SAN extension tuner. See the [“Data Pattern” section on page 3-83](#).

- Step 5** Click **Next**.

You see the Results dialog box (see [Figure 3-6](#)).

Figure 3-6 Results Dialog Box

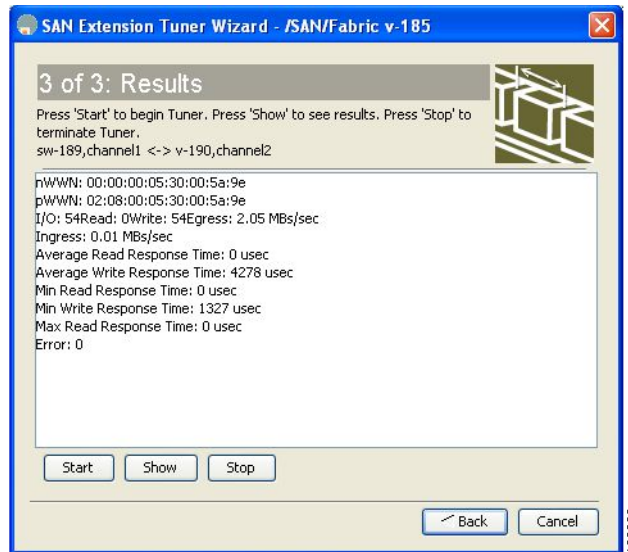

- Step 6** Click **Start** to start the tuner. The tuner sends a continuous stream of traffic until you click **Stop**.
- Step 7** Click **Show** to see the latest tuning statistics. You can select this while the tuner is running or after you stop it.
- Step 8** Click **Stop** to stop the SAN extension tuner.

## Enabling the Tuner

The tuning feature is disabled by default in all switches in the Cisco 9000 Family. When you enable this feature, tuning is globally enabled for the entire switch.

To enable the tuning feature, follow these steps:

	Command	Purpose
<b>Step 1</b>	switch# <b>confi g t</b>	Enters configuration mode.
<b>Step 2</b>	switch(config)# <b>feature san-ext-tuner</b>	Enables tuning.
	switch(config)# <b>no feature san-ext-tuner</b>	Removes the currently applied tuning configuration and disables tuning (default).

## Configuring nWWN

To configure the nWWNs for the tuner in this switch, follow these steps:

	Command	Purpose
<b>Step 1</b>	switch# <b>san-ext-tuner</b> switch(san-ext)#	Enters the SET configuration submode.
<b>Step 2</b>	switch(san-ext)# <b>nWWN 10:00:00:00:00:00:00:00</b>	Configures the nWWN for the SAN extension tuner.

## Configuring the Virtual N Port

To configure the virtual N port for tuning, follow these steps:

	Command	Purpose
Step 1	switch# <b>config t</b> switch(config)#	Enters configuration mode.
Step 2	switch(config)# <b>feature iscsi</b> switch(config)# <b>iscsi enable module 1</b>	Enables iSCSI globally and then on module 1.
Step 3	switch(config)# <b>interface iscsi 1/1</b> switch(config-if)#	Creates an iSCSI interface and enters interface configuration submode.
Step 4	switch(config-if)# <b>no shutdown</b>	Enables the iSCSI interface.
Step 5	switch(config-if)# <b>end</b> switch#	Returns to EXEC mode.
Step 6	switch# <b>san-ext-tuner</b> switch(san-ext)#	Enters the SET configuration submode.
Step 7	switch(san-ext)# <b>nport pwwn 12:00:00:00:00:00:56 vsan 200 interface gigabitethernet 1/1</b> switch(san-ext-nport)#	Creates a virtual N port on the specified Gigabit Ethernet port and VSAN. This N port can act as an initiator or a target.
	switch(san-ext)# <b>no nport pwwn 22:34:56:78:90:12:34:56 vsan 200 interface gigabitethernet 1/1</b>	Removes a virtual N port on the specified Gigabit Ethernet port and VSAN.

## Generating SCSI Disk Read/Write IO

You can assign SCSI read and write commands on a one-time basis or on a continuous basis.

To generate SCSI read or write commands on a one-time basis, follow these steps:

	Command	Purpose
Step 1	switch# <b>san-ext-tuner</b> switch(san-ext)#	Enters the SET configuration submode.
Step 2	switch(san-ext)# <b>nport pwwn 12:00:00:00:00:00:56 vsan 200 interface gigabitethernet 1/1</b> switch(san-ext-nport)#	Creates a virtual N port on the specified Gigabit Ethernet port and VSAN. This N port can act as an initiator or a target.
Step 3	switch(san-ext-nport)# <b>read command-id 100 target 22:22:22:22:22:22:22:22 transfer-size 512000 outstanding-ios 2 num-transactions 5000000</b>	Specifies a transfer size of 512,000 bytes with two outstanding I/Os in the <b>read</b> command. The total number of I/Os is 5,000,000 bytes.
Step 4	switch(san-ext-nport)# <b>write command-id 101 target 22:22:22:22:22:22:22:22 transfer-size 512000 outstanding-ios 2 num-transactions 5000000</b>	Specifies a transfer size of 512,000 bytes with two outstanding I/Os in the <b>write</b> command received by the target. The total number of I/Os is 5,000,000 bytes.
Step 5	switch(san-ext-nport)# <b>stop command-id 100</b>	Stops the command with the specified ID.
	switch(san-ext-nport)# <b>stop all</b>	(Optional) Stops all outstanding commands.
Step 6	switch(san-ext-nport)# <b>clear counters</b>	Clears the counters associated with this N port.
Step 7	switch(san-ext-nport)# <b>end</b> switch#	Exits the SAN extension tuner submode.

To generate SCSI read or write commands continuously, follow these steps:

	Command	Purpose
Step 1	switch# <b>san-ext-tuner</b> switch(san-ext)#	Enters the SET configuration submode.
Step 2	switch(san-ext)# <b>nport pWWN</b> <b>12:00:00:00:00:00:56 vsan 200 interface</b> <b>gigabitethernet 1/1</b> switch(san-ext-nport)#	Creates a virtual N port on the specified Gigabit Ethernet port and VSAN. This N port can act as an initiator or a target.
Step 3	switch(san-ext-nport)# <b>read command-id 100</b> <b>target 22:22:22:22:22:22:22:22 transfer-size</b> <b>512000 outstanding-ios 2 continuous</b>	Configures SCSI commands to be read continuously. <b>Tip</b> Use the <b>stop command-id</b> command to stop the outstanding configuration.
Step 4	switch(san-ext-nport)# <b>write command-id 100</b> <b>target 22:22:22:22:22:22:22:22 transfer-size</b> <b>512000 outstanding-ios 2 continuous</b>	Configures SCSI commands to be written continuously.
Step 5	switch(san-ext-nport)# <b>stop command-id 100</b> switch(san-ext-nport)# <b>stop command-id all</b>	Stops the command with the specified ID. (Optional) Stops all outstanding commands.
Step 6	switch(san-ext-nport)# <b>clear counters</b>	Clears the counters associated with this N port.
Step 7	switch(san-ext-nport)# <b>end</b> switch#	Exits the SAN extension tuner submode.

To specify a transfer ready size for a SCSI write command, follow these steps:

	Command	Purpose
Step 1	switch# <b>san-ext-tuner</b> switch(san-ext)#	Enters the SET configuration submode.
Step 2	switch(san-ext)# <b>nport pWWN</b> <b>12:00:00:00:00:00:56 vsan 200 interface</b> <b>gigabitethernet 1/1</b> switch(san-ext-nport)#	Creates a virtual N port on the specified Gigabit Ethernet port and VSAN. This N port can act as an initiator or a target.
Step 3	switch(san-ext-nport)# <b>write command-id 100</b> <b>target 22:22:22:22:22:22:22:22 transfer-size</b> <b>512000 outstanding-ios 2 num-transactions</b> <b>5000000</b>	Specifies a transfer size of 512,000 bytes with two outstanding I/Os in the <b>write</b> command received by the target. The total number of I/Os is 5,000,000 bytes.
Step 4	switch(san-ext-nport)# <b>transfer-ready-size</b> <b>512000</b> switch(san-ext-nport)# <b>no transfer-ready-size</b> <b>512000</b>	Specifies the maximum transfer ready size of 512,000 bytes as a target for SCSI write commands. For a SCSI <b>write</b> command with a larger size, the target performs multiple transfers based on the specified transfer size. Removes the specified transfer ready size configuration for SCSI write commands.
Step 5	switch(san-ext-nport)# <b>stop command-id 100</b>	Stops the command with the specified ID.
Step 6	switch(san-ext-nport)# <b>end</b> switch#	Exits the SAN extension tuner submode.

## Generating SCSI Tape Read/Write IO



**Note** Ensure that the zoning configuration is set up to allow the virtual N-ports to communicate with each other.

You can assign SCSI tape read and write commands on a one-time basis or on a continuous basis.



**Note** There is only one outstanding I/O at a time to the virtual N-port that emulates the tape behavior.

To generate SCSI tape read and or write commands on a one-time basis, follow these steps:

	Command	Purpose
<b>Step 1</b>	switch# <b>san-ext-tuner</b> switch(san-ext)#	Enters the SET configuration submode.
<b>Step 2</b>	switch(san-ext)# <b>nport pwwn</b> <b>12:00:00:00:00:00:56 vsan 200 interface</b> <b>gigabitethernet 1/1</b> switch(san-ext-nport)#	Creates a virtual N port on the specified Gigabit Ethernet port and VSAN. This N port can act as an initiator or a target.
<b>Step 3</b>	switch(san-ext-nport)# <b>tape-read command-id 100</b> <b>target 22:22:22:22:22:22:22:22 transfer-size</b> <b>512000 num-transactions 5000000</b> <b>filemark-frequency 32</b>	Specifies a transfer size of 512,000 bytes with space over the filemark every 32 SCSI read commands. The total number of I/Os is 5,000,000 bytes.
<b>Step 4</b>	switch(san-ext-nport)# <b>tape-write command-id 101</b> <b>target 22:22:22:22:22:22:22:22 transfer-size</b> <b>512000 num-transactions 5000000</b> <b>filemark-frequency 32</b>	Specifies a transfer size of 512,000 bytes with filemarks written every 32 SCSI write commands. The total number of I/Os is 5,000,000 bytes.
<b>Step 5</b>	switch(san-ext-nport)# <b>stop command-id 100</b>	Stops the command with the specified ID.
	switch(san-ext-nport)# <b>stop all</b>	(Optional) Stops all outstanding commands.
<b>Step 6</b>	switch(san-ext-nport)# <b>clear counters</b>	Clears the counters associated with this N port.
<b>Step 7</b>	switch(san-ext-nport)# <b>end</b> switch#	Exits the SAN extension tuner submode.

To generate SCSI tape read or write commands continuously, follow these steps:

	Command	Purpose
<b>Step 1</b>	switch# <b>san-ext-tuner</b> switch(san-ext)#	Enters the SET configuration submode.
<b>Step 2</b>	switch(san-ext)# <b>nport pwwn</b> <b>12:00:00:00:00:00:56 vsan 200 interface</b> <b>gigabitethernet 1/1</b> switch(san-ext-nport)#	Creates a virtual N port on the specified Gigabit Ethernet port and VSAN. This N port can act as an initiator or a target.
<b>Step 3</b>	switch(san-ext-nport)# <b>tape-read command-id 100</b> <b>target 22:22:22:22:22:22:22:22 transfer-size</b> <b>512000 continuous filemark-frequency 32</b>	Configures SCSI tape read commands to be issued continuously.  <b>Tip</b> Use the <b>stop command-id</b> command to stop the outstanding configuration.

	Command	Purpose
Step 4	switch(san-ext-nport)# <b>tape-write command-id 100 target 22:22:22:22:22:22:22:22 transfer-size 512000 continuous filemark-frequency 32</b>	Configures SCSI tape write commands to be issued continuously.
Step 5	switch(san-ext-nport)# <b>stop command-id 100</b>	Stops the command with the specified ID.
	switch(san-ext-nport)# <b>stop command-id all</b>	(Optional) Stops all outstanding commands.
Step 6	switch(san-ext-nport)# <b>clear counters</b>	Clears the counters associated with this N port.
Step 7	switch(san-ext-nport)# <b>end</b> switch#	Exits the SAN extension tuner submode.

## Configuring a Data Pattern

To optionally configure a data pattern for SCSI commands, follow these steps:

	Command	Purpose
Step 1	switch# <b>san-ext-tuner</b> switch(san-ext)#	Enters the SET configuration submode.
Step 2	switch(san-ext)# <b>nport pWWN 12:00:00:00:00:00:56 vsan 200 interface gigabitethernet 1/1</b> switch(san-ext-nport)#	Creates a virtual N port on the specified Gigabit Ethernet port and VSAN. This N port can act as an initiator or a target.
Step 3	switch(san-ext-nport)# <b>data-pattern-file bootflash://DataPatternFile</b>	Specifies the data pattern sent by the virtual N port when it is a target for <b>read</b> commands and an initiator for <b>write</b> commands..
	switch(san-ext-nport)# <b>no data-pattern-file</b>	<b>Tip</b> This command should be configured on the target to change the data returned by read commands and on the initiator for write commands. This command is useful to define data sets which contain certain bit patterns or have certain compression ratios. The default data set of all zeros is very homogenous and very compressible. Removes the specified data pattern configuration for SCSI read and write commands. The default is to send an all zero data pattern.
Step 4	switch(san-ext-nport)# <b>write command-id 100 target 22:22:22:22:22:22:22:22 transfer-size 512000 outstanding-ios 2 num-transactions 5000000</b>	Specifies a transfer size of 512,000 bytes with two outstanding I/Os. The total number of I/Os is 5,000,000 bytes.
Step 5	switch(san-ext-nport)# <b>stop command-id 100</b>	Stops the command with the specified ID.
Step 6	switch(san-ext-nport)# <b>clear counters</b>	Clears the counters associated with this N port.
Step 7	switch(san-ext-nport)# <b>end</b> switch#	Exits the SAN extension tuner submode.

## Verifying the SAN Extension Tuner Configuration

The **show** commands display the current SAN extension tuner settings for the Cisco MDS switch (see Examples 3-1 to 3-6).

### Example 3-1 Displaying Entries in the FLOGI Database

```
switch# show flogi database
-----
INTERFACE    VSAN    FCID          PORT NAME          NODE NAME
-----
iscsil/1 200      0x050000      12:00:00:00:00:00:56  10:00:00:00:00:00:00:00
```

### Example 3-2 Displaying Details for a VSAN Entry in the FLOGI Database

```
switch# show fcns database vsan 200
VSAN 200
-----
FCID          TYPE    PWWN (VENDOR)          FC4-TYPE:FEATURE
-----
0x020000      N       22:22:22:22:22:22:22   scsi-fcp
0x050000      N       12:00:00:00:00:00:56   scsi-fcp
```

### Example 3-3 Displaying All Virtual N Ports Configured on the Specified Interface

```
switch# show san-ext-tuner interface gigabitethernet 3/4 nport pwwn
12:00:00:00:00:00:56 vsan 200 counters
Statistics for nport
Node name 10:00:00:00:00:00:00 Port name 12:00:00:00:00:00:56
I/Os per second          : 148
  Read                    : 0%
  Write                   : 100%
Ingress MB per second    : 0.02 MBs/sec (Max -0.02 MBs/sec)
Egress MB per second     : 73.97 MBs/sec (Max -75.47 MBs/sec)
Average Response time per I/O : Read - 0 us, Write - 13432 us
Maximum Response time per I/O : Read - 0 us, Write - 6953 us
Minimum Response time per I/O : Read - 0 us, Write - 19752 us
Errors                    : 0
```

### Example 3-4 Displaying N Ports Configured on a Specified Gigabit Ethernet Interface

```
switch# show san-ext-tuner interface gigabitethernet 3/1
-----
Interface          NODE NAME          PORT NAME          VSAN
-----
GigabitEthernet3/1 10:00:00:00:00:00:00 10:00:00:00:00:00:01 91
```

### Example 3-5 Displaying the Transfer Ready Size Configured for a Specified N Port

```
switch# show san-ext-tuner interface gigabitethernet 3/1 nport pwwn 10:0:0:0:0:0:1 vsan
91
Node name          : 10:00:00:00:00:00:00
Port name          : 10:00:00:00:00:00:01
Transfer ready size : all
```

**Example 3-6** *Displaying All Virtual N Ports Configured in a Switch*

```
switch# show san-ext-tuner nports
-----
Interface          NODE NAME          PORT NAME          VSAN
-----
GigabitEthernet3/1  10:00:00:00:00:00:00  10:00:00:00:00:00:01  91
```

## Default Settings for Tuning Parameters

Table 3-1 lists the default settings for tuning parameters.

**Table 3-1** *Default Tuning Parameters*

Parameters	Default
Tuning	Disabled
Transfer ready size	Same as the transfer size in the SCSI <b>write</b> command
Outstanding I/Os	1
Number of transactions	1
Data generation format	All-zero format
File mark frequency	0





# Configuring Internet Small Computer Systems Interface

Cisco MDS 9000 Family IP storage (IPS) services extend the reach of Fibre Channel SANs by using open-standard, IP-based technology. The switch allows IP hosts to access Fibre Channel storage using the Internet Small Computer Systems Interface (iSCSI) protocol.



**Note**

The iSCSI feature is specific to the Fibre Channel module with IPS ports and is available in Cisco MDS 9200 Switches or Cisco MDS 9500 Directors. In Cisco MDS NX-OS Release 7.3(0)DY(1) and later, iSCSI is not supported on Cisco MDS 9700 Directors with 24/10 port SAN Extension modules.

The Cisco MDS 9216i switch and the 14/2 Multiprotocol Services (MPS-14/2) module also allow you to use Fibre Channel, FCIP, and iSCSI features. The MPS-14/2 module is available for use in any switch in the Cisco MDS 9200 Series or Cisco MDS 9500 Series.



**Note**

For information on configuring Gigabit Ethernet interfaces, see [“Basic Gigabit Ethernet Configuration for IPv4”](#) section on page 7-276.

This chapter includes the following sections:

- [Overview of iSCSI, page 4-95](#)
- [Configuring iSCSI, page 4-98](#)
- [Configuring iSLB, page 4-147](#)
- [iSCSI High Availability, page 4-173](#)
- [iSCSI Authentication Setup Guidelines and Scenarios, page 4-180](#)
- [iSNS Cloud Discovery, page 4-217](#)
- [Default Settings, page 4-221](#)

## Overview of iSCSI

Cisco MDS 9000 Family IP Storage (IPS) services extend the reach of Fibre Channel SANs by using open-standard, IP-based technology. The iSCSI feature consists of routing iSCSI requests and responses between iSCSI hosts in an IP network and Fibre Channel storage devices in the Fibre Channel SAN that are accessible from any Fibre Channel interface of the Cisco MDS 9000 Family switch. Using the iSCSI protocol, the iSCSI driver allows an iSCSI host to transport SCSI requests and responses over an IP network. To use the iSCSI feature, you must explicitly enable iSCSI on the required switches in the fabric.

**Note**

The iSCSI feature is not supported on the Cisco Fabric Switch for HP c-Class Bladesystem and Cisco Fabric Switch for IBM BladeCenter.

The iSCSI feature consists of routing iSCSI requests and responses between iSCSI hosts in an IP network and Fibre Channel storage devices in the Fibre Channel SAN that are accessible from any Fibre Channel interface of the Cisco MDS 9000 Family switch (see [Figure 4-1](#)).

**Figure 4-1** Transporting iSCSI Requests and Responses for Transparent iSCSI Routing

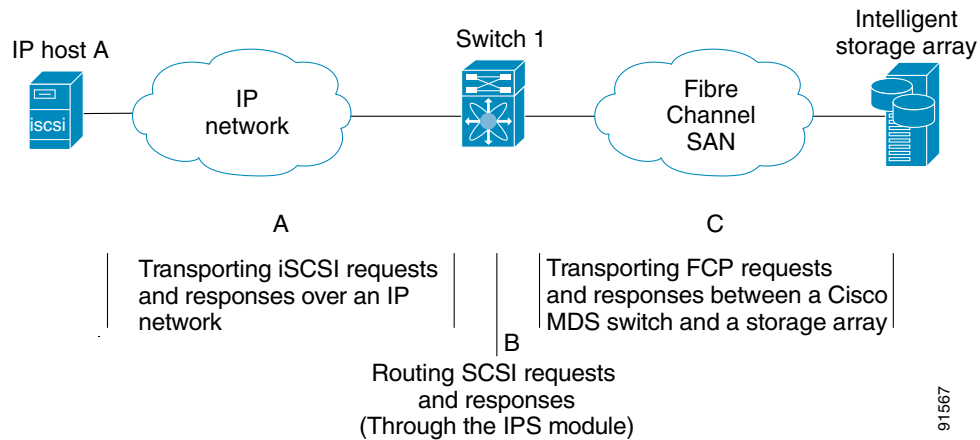

Each iSCSI host that requires access to storage through the Fibre Channel module with IPS ports or MPS-14/2 module needs to have a compatible iSCSI driver installed. Using the iSCSI protocol, the iSCSI driver allows an iSCSI host to transport SCSI requests and responses over an IP network. From the host operating system perspective, the iSCSI driver appears to be an SCSI transport driver similar to a Fibre Channel driver in the host.

The Fibre Channel module with IPS ports or MPS-14/2 module provides transparent SCSI routing. IP hosts using the iSCSI protocol can transparently access targets on the Fibre Channel network. It (see [Figure 4-1](#)) provides an example of a typical configuration of iSCSI hosts connected to an Fibre Channel module with IPS ports or MPS-14/2 module through the IP network access Fibre Channel storage on the Fibre Channel SAN.

The Fibre Channel module with IPS ports or MPS-14/2 module create a separate iSCSI SAN view and Fibre Channel SAN view. For the iSCSI SAN view, the Fibre Channel module with IPS ports or MPS-14/2 module creates iSCSI virtual targets and then maps them to physical Fibre Channel targets available in the Fibre Channel SAN. They present the Fibre Channel targets to IP hosts as if the physical iSCSI targets were attached to the IP network (see [Figure 4-2](#)).

**Figure 4-2** *iSCSI SAN View—iSCSI Virtual Targets*

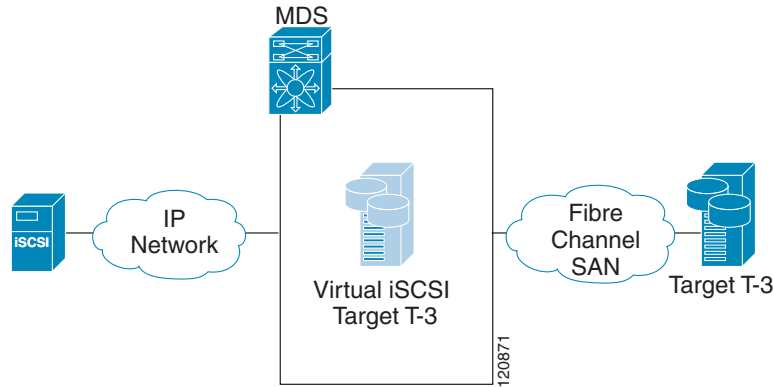

For the Fibre Channel SAN view, the Fibre Channel module with IPS ports or MPS-14/2 module presents iSCSI hosts as a virtual Fibre Channel host. The storage devices communicate with the virtual Fibre Channel host similar to communications performed with real Fibre Channel hosts (see [Figure 4-3](#)).

**Figure 4-3** *Fibre Channel SAN View—iSCSI Host as an HBA*

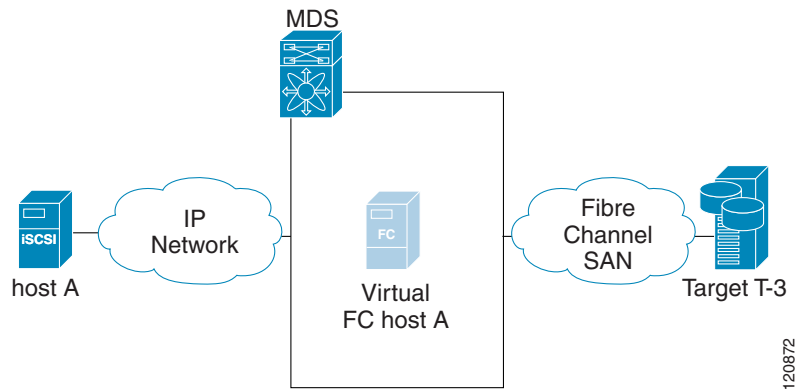

The Fibre Channel module with IPS ports or MPS-14/2 modules transparently map the command between the iSCSI virtual target and the virtual Fibre Channel host (see [Figure 4-4](#)).

**Figure 4-4** *iSCSI to FCP (Fibre Channel) Routing*

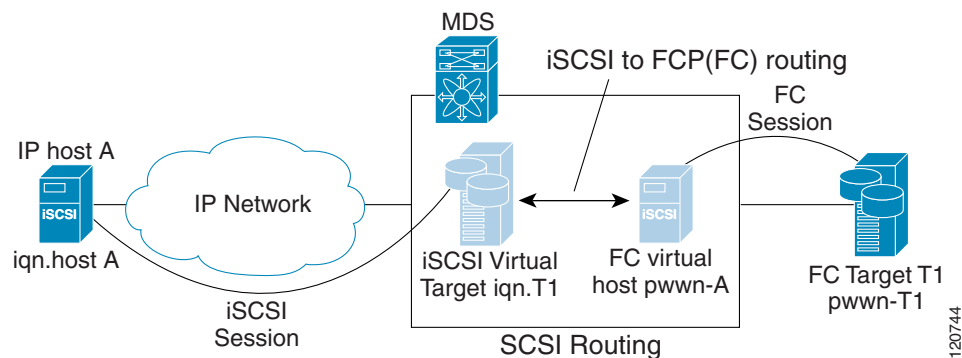

Routing SCSI from the IP host to the Fibre Channel storage device consists of the following main actions:

- The iSCSI requests and responses are transported over an IP network between the hosts and the Fibre Channel module with IPS ports or MPS-14/2 module.
- The SCSI requests and responses are routed between the hosts on an IP network and the Fibre Channel storage device (converting iSCSI to FCP and vice versa). The Fibre Channel module with IPS ports or MPS-14/2 module performs this conversion and routing.
- The FCP requests or responses are transported between the Fibre Channel module with IPS ports or MPS-14/2 module and the Fibre Channel storage devices.



**Note**

FCP (the Fibre Channel equivalent of iSCSI) carries SCSI commands over a Fibre Channel SAN. Refer to the IETF standards for IP storage at <http://www.ietf.org> for information on the iSCSI protocol.

## iSCSI Configuration Limits

iSCSI configuration has the following limits:

- The maximum number of iSCSI and iSLB initiators supported in a fabric is 2000.
- The maximum number of iSCSI and iSLB initiators supported is 200 per port.
- The maximum number of iSCSI and iSLB sessions supported by an IPS port in either transparent or proxy initiator mode is 500.
- The maximum number of iSCSI and iSLB session support by switch is 5000.
- The maximum number of iSCSI and iSLB targets supported in a fabric is 6000.

## Configuring iSCSI

This section describes how to configure iSCSI on the Cisco MDS 9000 Family switches.

This section includes the following sections:

- [Enabling iSCSI, page 4-98](#)
- [Creating iSCSI Interfaces, page 4-100](#)
- [Using the iSCSI Wizard, page 4-101](#)
- [Presenting Fibre Channel Targets as iSCSI Targets, page 4-103](#)
- [Presenting iSCSI Hosts as Virtual Fibre Channel Hosts, page 4-110](#)
- [iSCSI Access Control, page 4-123](#)
- [iSCSI Session Authentication, page 4-128](#)
- [iSCSI Immediate Data and Unsolicited Data Features, page 4-134](#)
- [iSCSI Interface Advanced Features, page 4-134](#)

## Enabling iSCSI

To use the iSCSI feature, you must explicitly enable iSCSI on the required switches in the fabric. Alternatively, you can enable or disable the iSCSI feature directly on the required modules using Fabric Manager or Device Manager. By default, this feature is disabled in all switches in the Cisco MDS 9000 Family.

To enable iSCSI on any participating switch, follow these steps:

	Command	Purpose
<b>Step 1</b>	switch# <b>config terminal</b> terminal	Enters the configuration commands, one per line. End with CNTL/Z.
<b>Step 2</b>	switch(config)# <b>feature iscsi</b>	Enables iSCSI on that switch.
	switch(config)# <b>no feature iscsi</b>	Disables (default) iSCSI on that switch.
	switch(config)# <b>iscsi enable module &lt;x&gt;</b>	Enables iSCSI modules on the switch.  <b>Note</b> New command added so that SME and iSCSI are available on the same switch.
	switch(config)# <b>no iscsi enable module &lt;x&gt;</b>	Disables the iSCSI module on the switch.

**Caution**

When you disable this feature, all related configurations are automatically discarded.

To enable iSCSI on any switch using Fabric Manager, follow these steps:

**Step 1** Choose **End Devices > iSCSI** in the Physical Attributes pane.

You see the iSCSI tables in the Information pane (see [Figure 4-5](#)).

**Figure 4-5** *iSCSI Tables in Fabric Manager*

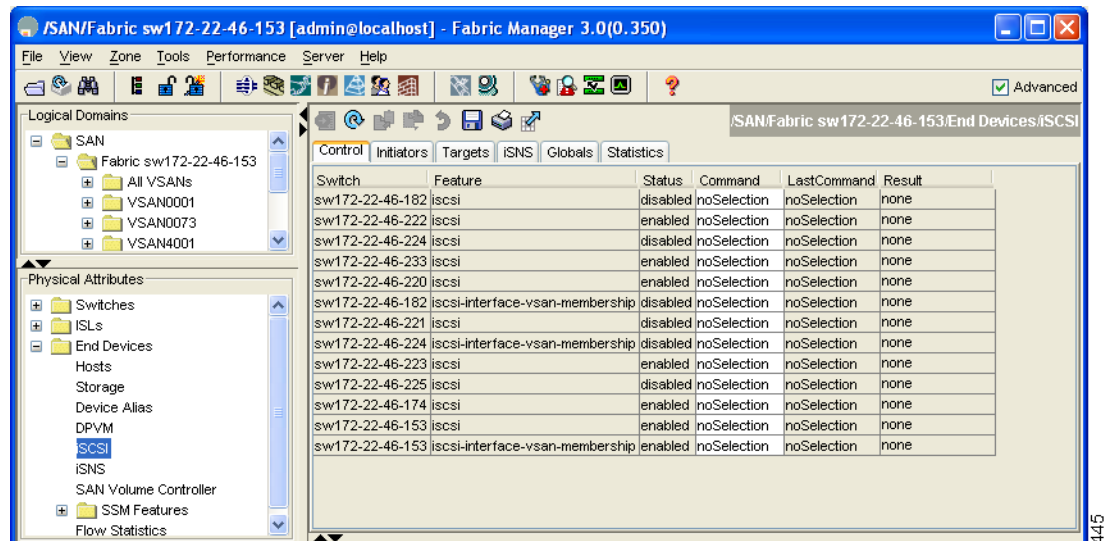

The **Control** tab is the default tab. You see the iSCSI enable status for all switches in the fabric that contain IPS ports.

**Step 2** Choose **enable** from the Command column for each switch that you want to enable iSCSI on.

**Step 3** Click the **Apply Changes** icon to save these changes.

To enable iSCSI on a module using Fabric Manager, follow these steps:

**Step 1** Choose **End Devices > iSCSI** in the Physical Attributes pane.

You see the iSCSI tables in the Information pane.

**Step 2** Click the **Module Control** tab.

You see the Module Control dialog box in the information pane (see [Figure 4-6](#)).

**Figure 4-6** Module Control Dialog Box

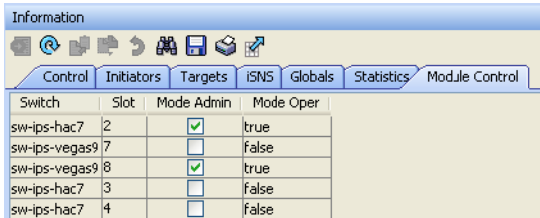

Switch	Slot	Mode Admin	Mode Oper
sw-ips-hac7	2	<input checked="" type="checkbox"/>	true
sw-ips-vegas9	7	<input type="checkbox"/>	false
sw-ips-vegas9	8	<input checked="" type="checkbox"/>	true
sw-ips-hac7	3	<input type="checkbox"/>	false
sw-ips-hac7	4	<input type="checkbox"/>	false

**Step 3** Check the **Mode Admin** check box to enable iSCSI for a specified port on the selected module.

**Step 4** Click the **Apply Changes** icon to save these changes.

To enable iSCSI on a module using Device Manager, follow these steps:

**Step 1** Choose **IP > iSCSI**

You see the iSCSI table (see [Figure 4-7](#)).

**Figure 4-7** iSCSI Table

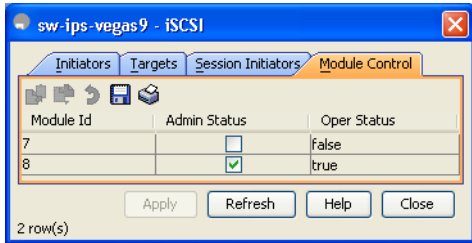

Module Id	Admin Status	Oper Status
7	<input type="checkbox"/>	false
8	<input checked="" type="checkbox"/>	true

**Step 2** Check the **Mode Admin** check box to enable iSCSI for the specified port on the selected module.

**Step 3** Click **Apply** to save these changes.

## Creating iSCSI Interfaces

Each physical Gigabit Ethernet interface on an Fibre Channel module with IPS ports, MPS-14/2 module or 1/10Gbps IPStorage port on a Cisco MDS 9250i Multiservice Fabric Switch can be used to translate and route iSCSI requests to Fibre Channel targets and responses in the opposite direction. To enable this capability, the corresponding iSCSI interface must be in an enabled state.

To enable iSCSI interfaces, follow these steps:

---

**Step 1** Enable the required Gigabit Ethernet interface.

```
switch# config terminal
switch(config)# interface gigabitethernet 2/1
switch(config-if)# no shutdown
switch(config-if)# exit
switch(config)#
```

**Step 2** Create the required iSCSI interface and enable the interface.

```
switch(config)# interface iscsi 2/1
switch(config-if)# no shutdown
```

**Note**

---

Use the **tcp maximum-bandwidth-kbps** and **tcp maximum-bandwidth-mbps** commands to configure the iSCSI speed and the **switchport speed** command to set the Physical IPStorage ports to 1Gbps or 10Gbps speed. The Cisco MDS switches do not limit the configuration of the iSCSI **tcp maximum-bandwidth-kbps** and **maximum-bandwidth-mbps** based on the speed of the underlying physical Gigabit Ethernet or IPStorage ports. Consequently, it is possible to configure iSCSI **tcp maximum-bandwidth-kbps** and **tcp maximum-bandwidth-mbps** commands to the equivalent of 10Gbps on a physical IPStorage port that is running at a 1Gbps speed. When configuring the **tcp maximum bandwidth**, ensure that it does not exceed the maximum speed of the physical IPStorage port.

---

## Using the iSCSI Wizard

To use the iSCSI wizard in Fabric Manager, follow these steps:

---

**Step 1** Click the **iSCSI Setup Wizard** icon.

You see the iSCSI Wizard Configure Initiator dialog box (see [Figure 4-8](#)).

Figure 4-8 iSCSI Wizard Configure Initiator Dialog Box

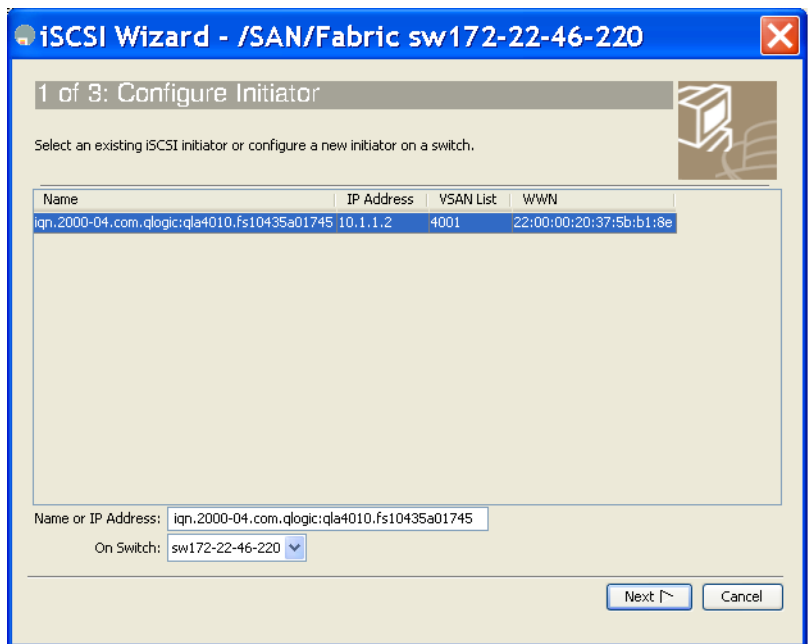

**Step 2** Select an existing iSCSI initiator or add the iSCSI node name or IP address for a new iSCSI initiator.

**Step 3** Select the switch for this iSCSI initiator if you are adding a new iSCSI initiator and click **Next**.

You see the iSCSI Wizard Select Targets dialog box (see Figure 4-9).

Figure 4-9 iSCSI Wizard Select Targets Dialog Box

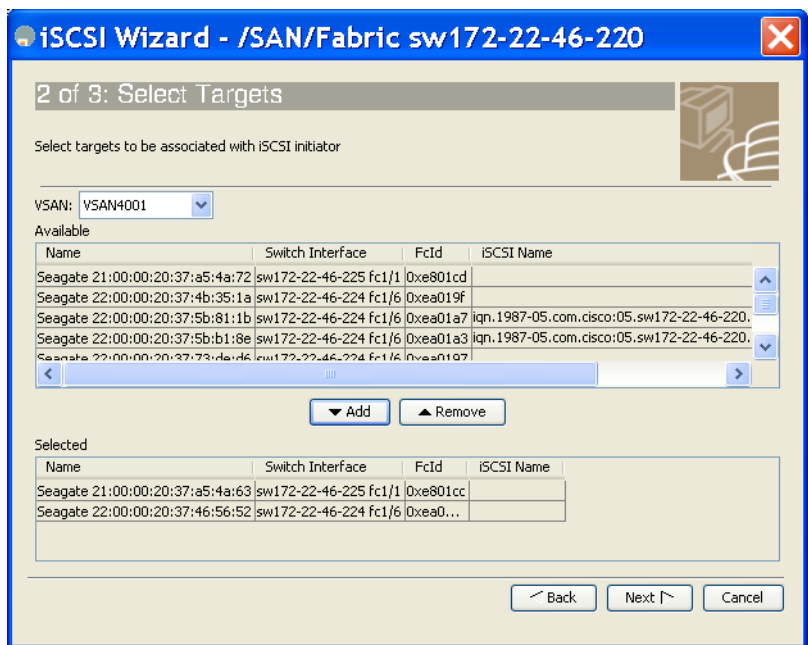

**Step 4** Select the VSAN and targets to associate with this iSCSI initiator and click **Next**.



**Note** The iSCSI wizard turns on the Dynamic Import FC Targets feature.

You see the iSCSI Wizard Select Zone dialog box (see [Figure 4-10](#)).

**Figure 4-10** iSCSI Wizard Select Zone Dialog Box



**Step 5** Set the zone name for this new iSCSI zone and check the **ReadOnly** check box if needed.

**Step 6** Click **Finish** to create this iSCSI initiator.

If created, the target VSAN is added to the iSCSI host VSAN list.



**Note** iSCSI wizard automatically turns on the Dynamic FC target import.

## Presenting Fibre Channel Targets as iSCSI Targets

The Fibre Channel module with IPS ports or MPS-14/2 module presents physical Fibre Channel targets as iSCSI virtual targets, allowing them to be accessed by iSCSI hosts. The module presents these targets in one of the two ways:

- Dynamic mapping—Automatically maps all the Fibre Channel target devices/ports as iSCSI devices. Use this mapping to create automatic iSCSI target names.
- Static mapping—Manually creates iSCSI target devices and maps them to the whole Fibre Channel target port or a subset of Fibre Channel LUNs. With this mapping, you must specify unique iSCSI target names.

Static mapping should be used when iSCSI hosts should be restricted to subsets of LUs in the Fibre Channel targets and/or iSCSI access control is needed (see the [“iSCSI Access Control”](#) section on page 4-123). Also, static mapping allows the configuration of transparent failover if the LUs of the Fibre Channel targets are reachable by redundant Fibre Channel ports (see the [“Transparent Target Failover”](#) section on page 4-173).

**Note**

The Fibre Channel module with IPS ports or MPS-14/2 module does not import Fibre Channel targets to iSCSI by default. Either dynamic or static mapping must be configured before the Fibre Channel module with IPS ports or MPS-14/2 module makes Fibre Channel targets available to iSCSI initiators.

**Dynamic Mapping**

When you configure dynamic mapping the Fibre Channel module with IPS ports or MPS-14/2 module imports all Fibre Channel targets to the iSCSI domain and maps each physical Fibre Channel target port as one iSCSI target. That is, all LUs accessible through the physical storage target port are available as iSCSI LUs with the same LU number (LUN) as in the physical Fibre Channel target port.

The iSCSI target node name is created automatically using the iSCSI qualified name (IQN) format. The iSCSI qualified name is restricted to a maximum name length of 223 alphanumeric characters and a minimum length of 16 characters.

The Fibre Channel module with IPS ports or MPS-14/2 module creates an IQN formatted iSCSI target node name using the following conventions because the name must be unique in the SAN:

- IPS Gigabit Ethernet ports that are not part of a Virtual Router Redundancy Protocol (VRRP) group or port channel use this format:

```
iqn.1987-05.com.cisco:05.<mgmt-ip-address>.<slot#>-<port#>-<sub-intf#>.<Target-pWWN>
```

- IPS ports that are part of a VRRP group use this format:

```
iqn.1987-05.com.cisco:05.vrrp-<vrrp-ID#>-<vrrp-IP-addr>.<Target-pWWN>
```

- Ports that are part of a port channel use this format:

```
iqn.1987-02.com.cisco:02.<mgmt-ip-address>.pc-<port-ch-sub-intf#>.<Target-pWWN>
```

**Note**

If you have configured a switch name, then the switch name is used instead of the management IP address. If you have not configured a switch name, the management IP address is used.

With this convention, each IPS port in a Cisco MDS 9000 Family switch creates a unique iSCSI target node name for the same Fibre Channel target port in the SAN.

For example, if an iSCSI target was created for a Fibre Channel target port with pWWN 31:00:11:22:33:44:55:66 and that pWWN contains LUN 0, LUN 1, and LUN 2, those LUNs would become available to an IP host through the iSCSI target node name `iqn.1987-05.com.cisco:05.MDS_switch_management_IP_address.01-01.3100112233445566` (see [Figure 4-11](#)).

**Figure 4-11 Dynamic Target Mapping**

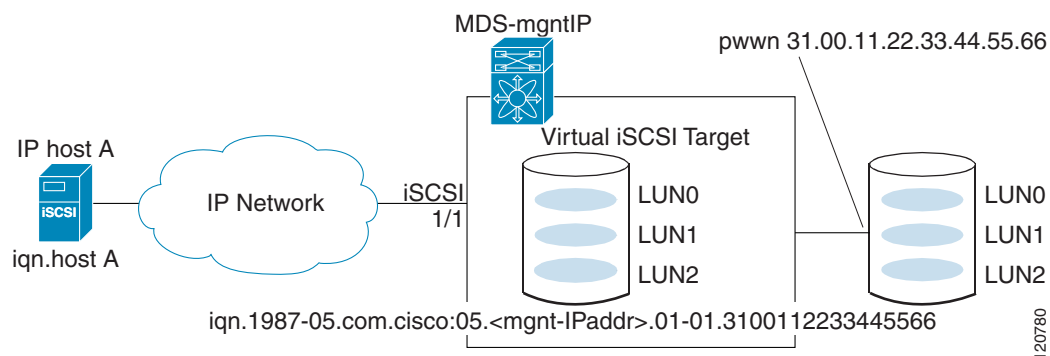

120780

**Note**

Each iSCSI initiator may not have access to all targets depending on the configured access control mechanisms (see the “iSCSI Access Control” section on page 4-123).

To enable dynamic mapping of Fibre Channel targets into iSCSI, follow these steps:

	Command	Purpose
<b>Step 1</b>	switch# <b>config terminal</b> switch(config)#	Enters configuration mode.
<b>Step 2</b>	switch(config)# <b>iscsi import target fc</b>	Fibre Channel module with IPS ports and MPS-14/2 modules dynamically import all Fibre Channel targets in the Fibre Channel SAN into the IP network.

To enable dynamic mapping of Fibre Channel targets into iSCSI using Device Manager, follow these steps:

**Step 1** Choose **IP > iSCSI**.

You see the iSCSI configuration (see Figure 4-12).

**Figure 4-12** iSCSI Configuration in Device Manager

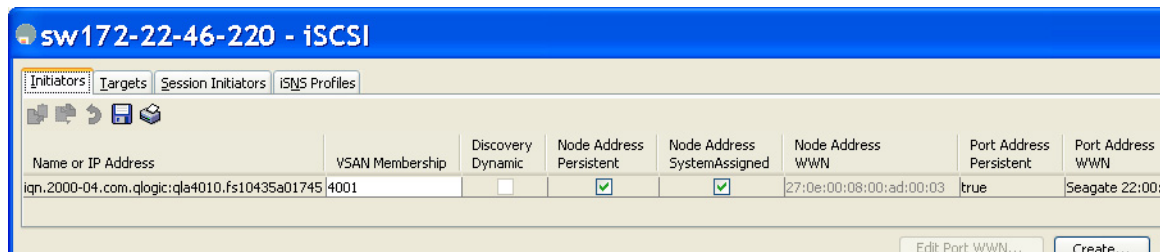

**Step 2** Click the Target tab to display a list of existing iSCSI targets (see Figure 4-13).

**Figure 4-13** iSCSI Targets Tab

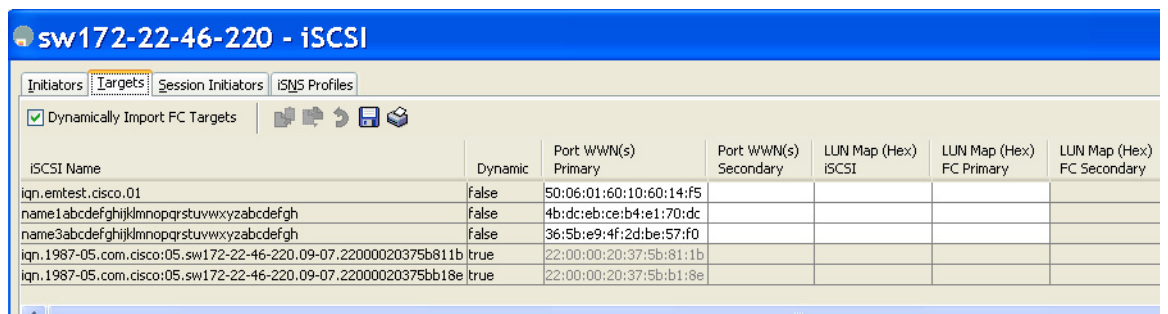

**Step 3** Check the **Dynamically Import FC Targets** check box.

**Step 4** Click **Apply** to save this change.

## Static Mapping

You can manually (statically) create an iSCSI target by assigning a user-defined unique iSCSI node name to it. The iSCSI qualified name is restricted to a minimum length of 16 characters and a maximum of 223 characters. A statically mapped iSCSI target can either map the whole Fibre Channel target port (all LUNs in the target port mapped to the iSCSI target), or it can contain one or more LUs from a Fibre Channel target port (see [Figure 4-14](#)).

**Figure 4-14** Statically Mapped iSCSI Targets

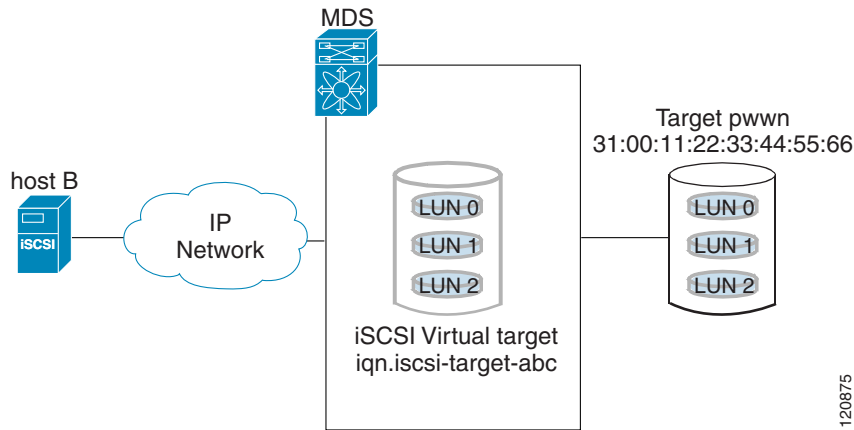

To create a static iSCSI virtual target for the entire Fibre Channel target port using Device Manager, follow these steps:

**Step 1** Click **IP > iSCSI**.

You see the iSCSI configuration (see [Figure 4-12](#)).

**Step 2** Click the **Targets** tab to display a list of existing iSCSI targets (see [Figure 4-13](#)).

**Step 3** Click **Create** to create an iSCSI target.

You see the Create iSCSI Targets dialog box (See [Figure 4-15](#)).

Figure 4-15 Create iSCSI Targets Dialog Box

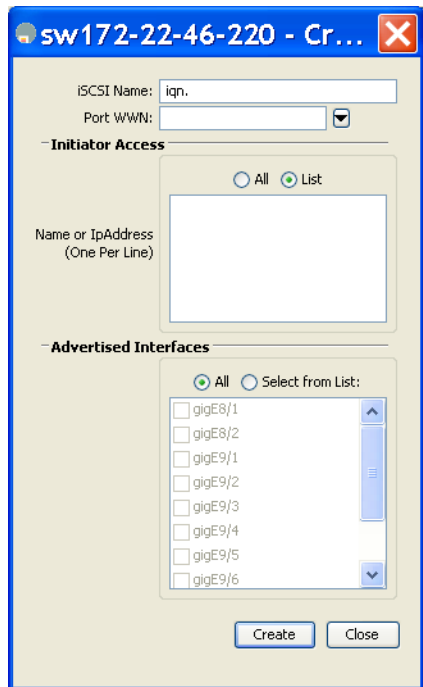

- Step 4** Set the iSCSI target node name in the iSCSI Name field, in IQN format.
- Step 5** Set the Port WWN field for the Fibre Channel target port you are mapping.
- Step 6** Click the **Select from List** radio button and set the iSCSI initiator node names or IP addresses that you want this virtual iSCSI target to access, or click the **All** radio button to let the iSCSI target access all iSCSI initiators. Also see the “[iSCSI Access Control](#)” section on page 4-123.
- Step 7** Click the **Select from List** radio button and check each interface you want to advertise the iSCSI targets on or click the **All** radio button to advertise all interfaces.
- Step 8** Click **Apply** to save this change.

**Tip**

An iSCSI target cannot contain more than one Fibre Channel target port. If you have already mapped the whole Fibre Channel target port, you cannot use the LUN mapping option.

**Note**

See the “[iSCSI-Based Access Control](#)” section on page 4-126 for more information on controlling access to statically mapped targets.

### Advertising Static iSCSI Targets

You can limit the Gigabit Ethernet interfaces through which static iSCSI targets are advertised. By default iSCSI targets are advertised on all Gigabit Ethernet interfaces, subinterfaces, port channel interfaces, and port channel subinterfaces.

To configure a specific interface that should advertise the iSCSI virtual target using Device Manager, follow these steps:

**Step 1** Select **IP > iSCSI**.

You see the iSCSI configuration (see [Figure 4-12](#)).

**Step 2** Click the **Targets** tab to display a list of existing iSCSI targets (see [Figure 4-13](#)).

**Step 3** Right-click the iSCSI target that you want to modify and click **Edit Advertised**.

You see the Advertised Interfaces dialog box.

**Step 4** (Optional) Right-click an interface that you want to delete and click **Delete**.

**Step 5** (Optional) Click **Create** to advertise on more interfaces.

You see the Create Advertised Interfaces dialog box.

To configure a specific interface that should advertise the iSCSI virtual target, follow these steps:

	Command	Purpose
<b>Step 1</b>	<code>switch(config-iscsi-tgt)# advertise interface GigabitEthernet 2/5</code>	Advertises the virtual target only on the specified interface. By default, it is advertised on all interfaces in all Fibre Channel module with IPS ports or MPS-14/2 modules.  <b>Note</b> To advertise the virtual target on multiple interfaces, issue the command for each interface.
	<code>switch(config-iscsi-tgt)# no advertise interface GigabitEthernet 2/5</code>	Removes this interface from the list of interfaces from which this target is advertised.

## iSCSI Virtual Target Configuration Examples

This section provides three examples of iSCSI virtual target configurations.

### Example 1

This example assigns the whole Fibre Channel target as an iSCSI virtual target. All LUNs that are part of the Fibre Channel target are available as part of the iSCSI target (see [Figure 4-16](#)).

**Figure 4-16** Assigning iSCSI Node Names

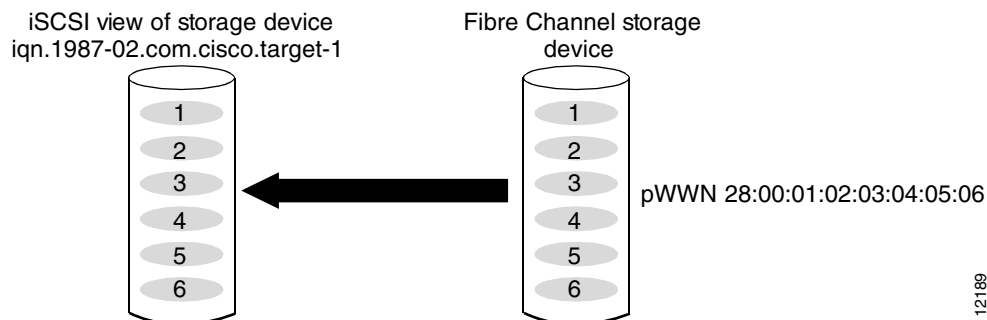

```
iscsi virtual-target name iqn.1987-02.com.cisco.target-1
```

pWWN 28:00:01:02:03:04:05:06

### Example 2

This example maps a subset of LUNs of a Fibre Channel target to three iSCSI virtual targets. Each iSCSI target only has one LUN (see Figure 4-17).

**Figure 4-17 Mapping LUNs to an iSCSI Node Name**

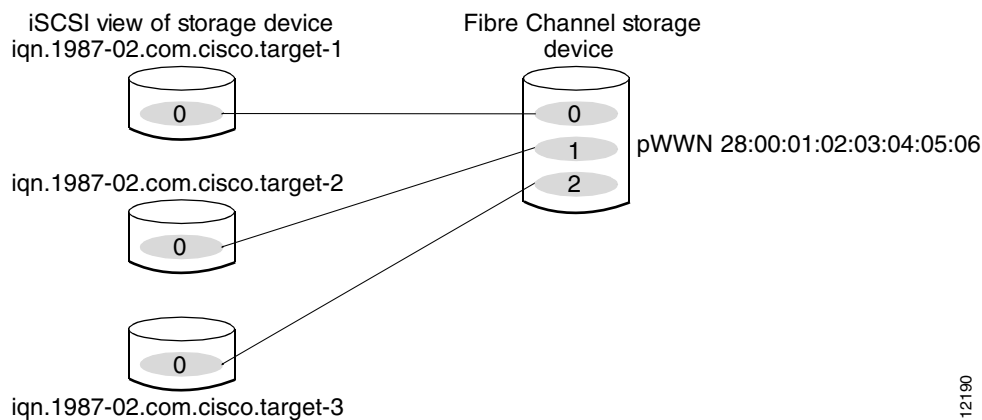

112190

```
iscsi virtual-target name iqn.1987-02.com.cisco.target-1
  pWWN 28:00:01:02:03:04:05:06 fc-lun 0 iscsi-lun 0
iscsi virtual-target name iqn.1987-02.com.cisco.target-2
  pWWN 28:00:01:02:03:04:05:06 fc-lun 1 iscsi-lun 0
iscsi virtual-target name iqn.1987-02.com.cisco.target-3
  pWWN 28:00:01:02:03:04:05:06 fc-lun 2 iscsi-lun 0
```

### Example 3

This example maps three subsets of Fibre Channel LUN targets to three iSCSI virtual targets. Two iSCSI targets have one LUN and the third iSCSI target has two LUNs (see Figure 4-18).

**Figure 4-18 Mapping LUNs to Multiple iSCSI Node Names**

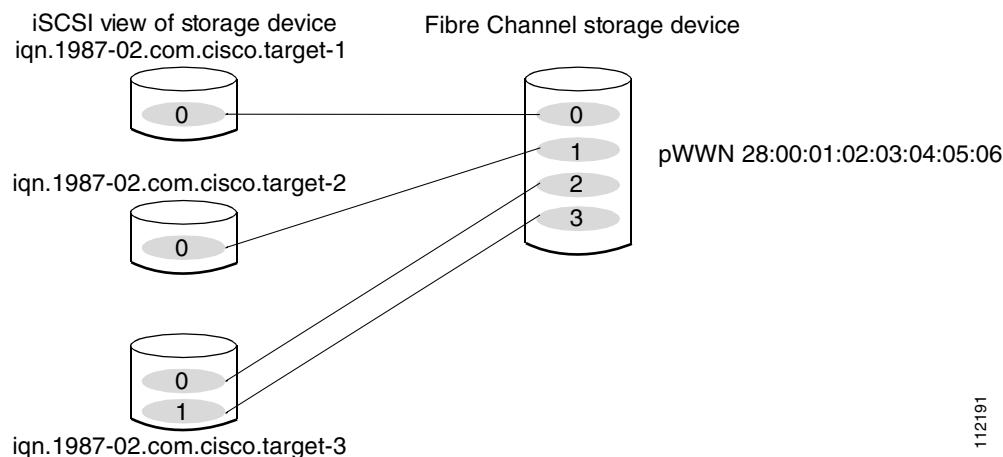

112191

```
iscsi virtual-target name iqn.1987-02.com.cisco.target-1
```

```

pWWN 28:00:01:02:03:04:05:06 fc-lun 0 iscsi-lun 0
iscsi virtual-target name iqn.1987-02.com.cisco.target-2
pWWN 28:00:01:02:03:04:05:06 fc-lun 1 iscsi-lun 0
iscsi virtual-target name iqn.1987-02.com.cisco.target-3
pWWN 28:00:01:02:03:04:05:06 fc-lun 2 iscsi-lun 0
pWWN 28:00:01:02:03:04:05:06 fc-lun 3 iscsi-lun 1

```

## Presenting iSCSI Hosts as Virtual Fibre Channel Hosts

The Fibre Channel module with IPS ports or MPS-14/2 module connects to the Fibre Channel storage devices on behalf of the iSCSI host to send commands and transfer data to and from the storage devices. These modules use a virtual Fibre Channel N port to access the Fibre Channel storage devices on behalf of the iSCSI host. iSCSI hosts are identified by either iSCSI qualified name (IQN) or IP address.

### Initiator Identification

iSCSI hosts can be identified by the Fibre Channel module with IPS ports or MPS-14/2 module using the following:

- iSCSI qualified name (IQN)

An iSCSI initiator is identified based on the iSCSI node name it provides in the iSCSI login. This mode can be useful if an iSCSI host has multiple IP addresses and you want to provide the same service independent of the IP address used by the host. An initiator with multiple IP addresses (multiple network interface cards—NICs) has one virtual N port on each IPS port to which it logs in.

- IP address

An iSCSI initiator is identified based on the IP address of the iSCSI host. This mode is useful if an iSCSI host has multiple IP addresses and you want to provide different service-based on the IP address used by the host. It is also easier to get the IP address of a host compared to getting the iSCSI node name. A virtual N port is created for each IP address it uses to log in to iSCSI targets. If the host using one IP address logs in to multiple IPS ports, each IPS port will create one virtual N port for that IP address.

You can configure the iSCSI initiator identification mode on each IPS port and all the iSCSI hosts terminating on the IPS port will be identified according to that configuration. The default mode is to identify the initiator by name.

To specify the initiator identification mode, follow these steps:

	Command	Purpose
<b>Step 1</b>	switch# <b>config terminal</b> switch(config)#	Enters the configuration mode.
<b>Step 2</b>	switch(config)# <b>interface iscsi 4/1</b> switch(config-if)#	Selects the iSCSI interface on the switch that identifies all the initiators.
<b>Step 3</b>	switch(config-if)# <b>switchport initiator id ip-address</b>	Identifies the iSCSI initiator based on the IP address.
	switch(config-if)# <b>switchport initiator id name</b>	Identifies the iSCSI initiator based on the initiator node name. This is the default behavior.

To specify the initiator identification mode using Fabric Manager, follow these steps:

- 
- Step 1** Choose **Interfaces > FC Logical** from the Physical Attributes pane.

You see the interfaces configuration in the Information pane.

- Step 2** Click the **iSCSI** tab.

You see the iSCSI interfaces configuration.

- Step 3** Right-click the Initiator ID Mode field for the iSCSI interface that you want to modify and select **name** or **ipaddress** from the drop-down menu.
- Step 4** Click **Apply Changes** to save this change.

## Initiator Presentation Modes

Two modes are available to present iSCSI hosts in the Fibre Channel fabric: transparent initiator mode and proxy initiator mode.

- In transparent initiator mode, each iSCSI host is presented as one virtual Fibre Channel host. The benefit of transparent mode is it allows a finer level of Fibre Channel access control configuration (similar to managing a “real” Fibre Channel host). Because of the one-to-one mapping from iSCSI to Fibre Channel, each host can have different zoning or LUN access control on the Fibre Channel storage device.
- In proxy initiator mode, there is only one virtual Fibre Channel host per one IPS port and all iSCSI hosts use that to access Fibre Channel targets. In a scenario where the Fibre Channel storage device requires explicit LUN access control for every host, the static configuration for each iSCSI initiator can be overwhelming. In this case, using the proxy initiator mode simplifies the configuration.



### Caution

Enabling proxy initiator mode of an iSCSI interface that is part of an iSLB VRRP group impacts load balancing on the interface. See the [“Changing iSCSI Interface Parameters and the Impact on Load Balancing”](#) section on page 4-163.

The Cisco MDS switches support the following iSCSI session limits:

- The maximum number of iSCSI sessions on a switch is 5000.
- The maximum number of iSCSI sessions per IPS port in transparent initiator mode is 500.
- The maximum number of iSCSI sessions per IPS port in proxy initiator mode is 500.
- The maximum number of concurrent sessions an IPS port can create is five (but the total number of sessions that can be supported is 500).



### Note

If more than five iSCSI sessions try to come up simultaneously on a port, the initiator receives a temporary error and later retries to create a session.

## Transparent Initiator Mode

Each iSCSI host is presented as one virtual Fibre Channel host (that is, one Fibre Channel N port). The benefit of transparent mode is it allows a finer-level of Fibre Channel access control configuration. Because of the one-to-one mapping from iSCSI to Fibre Channel, each host can have different zoning or LUN access control on the Fibre Channel storage device.

When an iSCSI host connects to the Fibre Channel module with IPS ports or MPS-14/2 module, a virtual host N port (HBA port) is created for the host (see [Figure 4-19](#)). Every Fibre Channel N port requires a unique Node WWN and Port WWN.

Figure 4-19 Virtual Host HBA Port

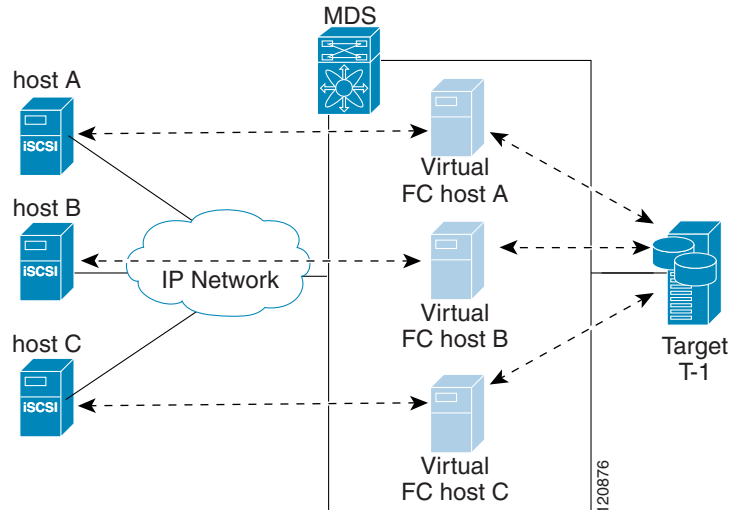

After the virtual N port is created with the WWNs, a fabric login (FLOGI) is done through the virtual iSCSI interface of the IPS port. After the FLOGI is completed, the virtual N port is online in the Fibre Channel SAN and virtual N port is registered in the Fibre Channel name server. The Fibre Channel module with IPS ports or MPS-14/2 module registers the following entries in the Fibre Channel name server:

- IP address of the iSCSI host in the IP-address field on the name server
- IQN of the iSCSI host in the symbolic-node-name field of the name server
- SCSI\_FCP in the FC-4 type field of the name server
- Initiator flag in the FC-4 feature of the name server
- Vendor-specific iSCSI GW flag in the FC-4 type field to identify the N-port device as an iSCSI gateway device in the name server.

When all the iSCSI sessions from the iSCSI host are terminated, the Fibre Channel module with IPS ports or MPS-14/2 modules perform an explicit Fabric logout (FLOGO) to remove the virtual N-port device from the Fibre Channel SAN (this indirectly de-registers the device from the Fibre Channel name server).

For every iSCSI session from the host to the iSCSI virtual target there is a corresponding Fibre Channel session to the real Fibre Channel target. There are three iSCSI hosts (see Figure 4-19), and all three of them connect to the same Fibre Channel target. There is one Fibre Channel session from each of the three virtual Fibre Channel hosts to the target.

## iSCSI Initiator Idle Timeout

iSCSI initiator idle timeout specifies the time for which the virtual Fibre Channel N port is kept idle after the initiator logs out from its last iSCSI session. The default value for this timer is 300 seconds. This is useful to avoid N ports logging in to and logging off of the Fibre Channel SAN as transient failure occurs in the IP network. This helps reduce unnecessary RSCNs being generated in the Fibre Channel SAN.

To configure the initiator idle timeout, follow these steps:

	Command	Purpose
<b>Step 1</b>	switch# <b>config terminal</b> switch(config)#	Enters the configuration mode.
<b>Step 2</b>	switch(config)# <b>iscsi initiator</b> <b>idle-timeout 10</b>	Configures the iSCSI initiators to have an idle timeout value of 10 seconds.

To configure the initiator idle timeout using Fabric Manager, follow these steps:

**Step 1** Choose **End Devices > iSCSI** in the Physical Attributes pane.

You see the iSCSI tables in the Information pane (see [Figure 4-5](#)).

**Step 2** Click the **Globals** tab.

You see the iSCSI global configuration.

**Step 3** Right-click on the InitiatorIdle Timeout field that you want to modify and enter the new timeout value.

**Step 4** Click the **Apply Changes** icon to save these changes.

### WWN Assignment for iSCSI Initiators

An iSCSI host is mapped to an N port's WWNs by one of the following mechanisms:

- Dynamic mapping (default)
- Static mapping

#### Dynamic Mapping

With dynamic mapping, an iSCSI host is mapped to a dynamically generated port WWN (pWWN) and node WWN (nWWN). Each time the iSCSI host connects it might be mapped to a different WWN. Use this option if no access control is required on the Fibre Channel target device (because the target device access control is usually configured using the host WWN).

The WWNs are allocated from the MDS switch's WWN pool. The WWN mapping to the iSCSI host is maintained as long as the iSCSI host has at least one iSCSI session to the IPS port. When all iSCSI sessions from the host are terminated and the Fibre Channel module with IPS ports or MPS-14/2 module performs an FLOGO for the virtual N port of the host, the WWNs are released back to the switch's Fibre Channel WWN pool. These addresses are then available for assignment to other iSCSI hosts requiring access to the Fibre Channel Fabric.

The following are three dynamic initiator modes are supported:

- iSCSI—Dynamic initiators are treated as iSCSI initiators and can access dynamic virtual targets and configured iSCSI virtual targets.
- iSLB—Dynamic initiators are treated as iSLB initiators.
- Deny—Dynamic initiators are not allowed to log in to the MDS switch.

iSCSI dynamic mapping is the default mode of operation. This configuration is distributed using CFS.



**Note** Configuring dynamic initiator modes is supported only through the CLI, not through Device Manager or Fabric Manager.

To configure dynamic mapping (using the **name** option) for an iSCSI initiator, follow these steps:

	Command	Purpose
Step 1	switch# <b>config terminal</b> switch(config)#	Enters configuration mode.
Step 2	switch(config)# <b>iscsi dynamic initiator islb</b>	Specifies iSLB dynamic initiator mode.
	switch(config)# <b>iscsi dynamic initiator deny</b>	Disallows dynamic initiators from logging on to the MDS switch.
	switch(config)# <b>no iscsi dynamic initiator islb</b>	Reverts to iSCSI mode (default).

### Static Mapping

With static mapping, an iSCSI host is mapped to a specific pWWN and nWWN. This mapping is maintained in persistent storage and each time the iSCSI host connects, the same WWN mapping is used. This mode is required if you use access control on the target device.

You can implement static mapping in one of two ways:

- User assignment—You can specify your own unique WWN by providing them during the configuration process.
- System assignment—You can request that the switch provide a WWN from the switch's Fibre Channel WWN pool and keep the mapping in its configuration.



**Tip** We recommend using the **system-assign** option. If you manually assign a WWN, you must ensure its uniqueness (see the *Cisco Fabric Manager Fabric Configuration Guide* and *Cisco MDS 9000 Family NX-OS Fabric Configuration Guide* for more information). You should not use any previously assigned WWNs.

To configure static mapping (using the **name** option) for an iSCSI initiator, follow these steps:

	Command	Purpose
Step 1	switch# <b>config terminal</b> switch(config)#	Enters configuration mode.
Step 2	switch(config)# <b>iscsi initiator name iqn.1987-02.com.cisco.initiator</b> switch(config-iscsi-init)#	Configures an iSCSI initiator using the iSCSI name of the initiator node. The maximum name length is restricted to 223 alphanumeric characters. The minimum length is 16.
	switch(config)# <b>no iscsi initiator name iqn.1987-02.com.cisco.initiator</b>	Deletes the configured iSCSI initiator.

To configure static mapping for an iSCSI initiator using Device Manager, follow these steps:

**Step 1** Select **IP > iSCSI**.

You see the iSCSI configuration (see [Figure 4-12](#)). The Initiators tab is the default.

**Step 2** Click **Create** to create an iSCSI initiator.

You see the Create iSCSI Initiators dialog box (see [Figure 4-20](#)).

Figure 4-20 Create iSCSI Initiators Dialog Box

The dialog box is titled "sw172-22-46-220 - Cre...". It contains the following fields and options:

- Name or IP Address: [Text Field]
- VSAN Membership: 1 [Text Field]
- Node WWN Mapping**
  - Persistent
  - SystemAssigned
  - Static WWN: [Text Field]
- Port WWN Mapping**
  - Persistent
  - System Assigned 1 [Spin Box] 1..64
- Or Static WWN(s):  
(One Per Line) [Text Area]
- AuthUser: [Text Field]
- Target Authentication**
  - UserName: [Text Field]
  - Password: [Text Field]

Buttons: Create, Close

183997

- Step 3** Set the iSCSI node name or IP address and VSAN membership.
- Step 4** In the Node WWN section, check the **Persistent** check box.
- Step 5** Check the **System Assigned** check box if you want the switch to assign the nWWN or leave this unchecked and set the Static WWN field.
- Step 6** In the Port WWN section, check the **Persistent** check box if you want to statically map pWWNs to the iSCSI initiator.
- Step 7** If persistent, check the **System Assigned** check box and set the number of pWWNs to reserve for this iSCSI initiator if you want the switch to assign pWWNs. Alternately, you can leave this unchecked and set one or more pWWNs for this iSCSI initiator.
- Step 8** (Optional) Set the AuthUser field if authentication is enabled. Also see the [“iSCSI Session Authentication”](#) section on page 4-128.
- Step 9** Click **Create** to create this iSCSI initiator.

To configure static mapping (using the **ip-address** option) for an iSCSI initiator, follow these steps:

	Command	Purpose
Step 1	switch# <b>config terminal</b> switch(config)#	Enters configuration mode.
Step 2	switch(config)# <b>iscsi initiator</b> <b>ip-address 10.50.0.0</b> switch(config-iscsi-init)#	Configures an iSCSI initiator using the IPv4 address of the initiator node.
	switch(config)# <b>iscsi initiator</b> <b>ip-address 2001:0DB8:800:200C::417A</b> switch(config-iscsi-init)#	Configures an iSCSI initiator using the IPv6 unicast address of the initiator node.
	switch(config)# <b>no iscsi initiator</b> <b>ip-address 2001:0DB8:800:200C::417A</b>	(Optional) Deletes the configured iSCSI initiator.

To assign the WWN for an iSCSI initiator, follow these steps:

	Command	Purpose
Step 1	switch(config-iscsi-init)# <b>static nwwn</b> <b>system-assign</b>	Uses the switch's WWN pool to allocate the nWWN for this iSCSI initiator and keeps it persistent.
	switch(config-iscsi-init)# <b>static nwwn</b> <b>20:00:00:05:30:00:59:11</b>	Assigns the user provided WWN as the nWWN for the iSCSI initiator. You can only specify one nWWN for each iSCSI node.
Step 2	switch(config-iscsi-init)# <b>static pwwn</b> <b>system-assign 2</b>	Uses the switch's WWN pool to allocate two pWWNs for this iSCSI initiator and keeps them persistent. The range is from 1 to 64.
	switch(config-iscsi-init)# <b>static pwwn</b> <b>21:00:00:20:37:73:3b:20</b>	Assigns the user provided WWN as the pWWN for the iSCSI initiator.



#### Note

If the system-assign option is used to configure WWNs for an iSCSI initiator, when the configuration is saved to an ASCII file the system-assigned WWNs are also saved. Subsequently if you perform a write erase, you must manually delete the WWN configuration from the ASCII file. Failing to do so can cause duplicate WWN assignments if the ASCII configuration file is reapplied on the switch.

### Making the Dynamic iSCSI Initiator WWN Mapping Static

After a dynamic iSCSI initiator has already logged in, you may decide to permanently keep the automatically assigned nWWN/pWWN mapping so this initiator uses the same mapping the next time it logs in.

You can convert a dynamic iSCSI initiator to static iSCSI initiator and make its WWNs persistent (see the [“Dynamic Mapping” section on page 4-113](#)).



#### Note

You cannot convert a dynamic iSCSI initiator to a static iSLB initiator or a dynamic iSLB initiator to a static iSCSI initiator.



#### Note

Making the dynamic pWWNs static after the initiator is created is supported only through the CLI, not through Device Manager or Fabric Manager. In Fabric Manager or Device Manager, you must delete and then recreate this initiator to have the pWWNs static.

To permanently keep the automatically assigned nWWN/pWWN mapping, follow these steps:

	Command	Purpose
Step 1	switch# <b>config terminal</b> switch(config)#	Enters configuration mode.
Step 2	switch(config)# <b>iscsi save-initiator name iqn.1987-02.com.cisco.initiator</b>	Saves the nWWN and pWWNs that have automatically been assigned to the iSCSI initiator whose name is specified.
	switch(config)# <b>iscsi save-initiator ip-address 10.10.100.11</b>	Saves the nWWN and pWWNs that have automatically been assigned to the iSCSI initiator whose IPv4 address is specified.
	switch(config)# <b>iscsi save-initiator ip-address 2001:0DB8:800:200C::417A</b>	Saves the nWWN and pWWNs that have automatically been assigned to the iSCSI initiator whose IPv6 unicast address is specified.
	switch(config)# <b>iscsi save-initiator</b>	Saves the nWWN and pWWNs that have automatically been assigned to all the initiators.
Step 3	switch(config)# <b>exit</b> switch#	Returns to EXEC mode.
Step 4	switch# <b>copy running-config startup-config</b>	Saves the nWWN/pWWN mapping configuration across system reboots.

### Checking for WWN Conflicts

WWNs assigned to static iSCSI initiators by the system can be inadvertently returned to the system when an upgrade fails or you downgrade the system software (manually booting up an older Cisco MDS SAN-OS release without using the **install all** command). In these instances, the system can later assign those WWNs to other iSCSI initiators (dynamic or static) and cause conflicts.

You can address this problem by checking for and removing any configured WWNs that belong to the system whenever such scenarios occur.

To check for and remove WWN conflicts, follow these steps:

	Command	Purpose
Step 1	switch# <b>config terminal</b> switch(config)#	Enters configuration mode.
Step 2	switch(config)# <b>iscsi duplicate-wwn-check</b> List of Potential WWN Conflicts: ----- Node : iqn.test-local-nwwn:1-local-pwwn:1 nWWN : 22:03:00:0d:ec:02:cb:02 pWWN : 22:04:00:0d:ec:02:cb:02	Checks for WWN conflicts.
Step 3	switch(config)# <b>iscsi initiator name iqn.test-local-nwwn:1-local-pwwn:1</b>	Enters iSCSI initiator configuration mode for the initiator named iqn.test-local-nwwn:1-local-pwwn:1.
Step 4	switch(config-iscsi-init)# <b>no static nwwn 22:03:00:0d:ec:02:cb:02</b>	Removes a conflicting nWWN.
Step 5	switch(config-iscsi-init)# <b>no static pwwn 22:04:00:0d:ec:02:cb:02</b>	Removes a conflicting pWWN.

To permanently keep the automatically assigned nWWN mapping using Fabric Manager, follow these steps:

**Step 1** Choose **End Devices > iSCSI** in the Physical Attributes pane.

You see the iSCSI tables in the Information pane (see [Figure 4-5](#)).

**Step 2** Click the **Initiators** tab.

You see the iSCSI initiators configured.

**Step 3** Check the **Persistent Node WWN** check box for the iSCSI initiators that you want to make static.

**Step 4** Click the **Apply Changes** icon to save these changes.

## Proxy Initiator Mode

In the event that the Fibre Channel storage device requires explicit LUN access control for every host use the transparent initiator mode (presenting one iSCSI host as one Fibre Channel host). Every iSCSI host has to be configured statically. This can mean several configuration tasks for each iSCSI host. If you do not need explicit LUN access control, using the proxy initiator mode simplifies the configuration.

In this mode, only one virtual host N port (HBA port) is created per IPS port. All the iSCSI hosts connecting to that IPS port will be multiplexed using the same virtual host N port (see [Figure 4-21](#)). This mode simplifies the task of statically binding WWNs. LUN mapping and assignment on the Fibre Channel storage array must be configured to allow access from the proxy virtual N port's pWWN for all LUNs used by each iSCSI initiator that connects through this IPS port. The LUN is then assigned to each iSCSI initiator by configuring iSCSI virtual targets (see the [“Static Mapping”](#) section on page 4-106) with LUN mapping and iSCSI access control (see the [“iSCSI Access Control”](#) section on page 4-123).

**Figure 4-21** Multiplexing IPS Ports

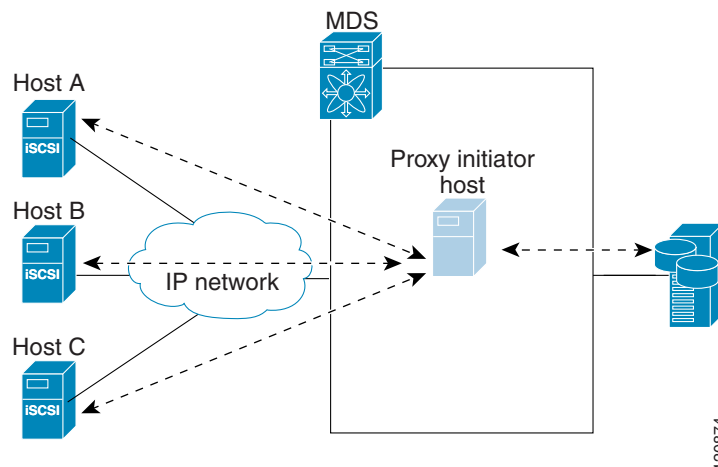

Proxy initiator mode can be configured on a per IPS port basis, in which case only iSCSI initiators terminating on that IPS port will be in this mode.

When an IPS port is configured in proxy-initiator mode, fabric login (FLOGI) is done through the virtual iSCSI interface of the IPS port. After the FLOGI is completed, the proxy-initiator virtual N port is online in the Fibre Channel fabric and virtual N port is registered in the Fibre Channel name server. The Fibre Channel module with IPS ports or MPS-14/2 module registers the following entries in the Fibre Channel name server:

- iSCSI interface name iSCSI slot /port is registered in the symbolic-node-name field of the name server
- SCSI\_FCP in the FC-4 type field of the name server

- Initiator flag in the FC-4 feature of the name server
- Vendor specific flag (iscsi-gw) in the FC-4 type field to identify the N-port device as an iSCSI gateway device in the name server

Similar to transparent initiator mode, the user can provide a pWWN and nWWN or request a system assigned WWN for the proxy initiator N port.

**Caution**

Enabling the proxy initiator mode of an iSCSI interface that is part of an iSLB VRRP group impacts load balancing on the interface. See the “[Changing iSCSI Interface Parameters and the Impact on Load Balancing](#)” section on page 4-163.

To configure the proxy initiator, follow these steps:

	Command	Purpose
<b>Step 1</b>	switch# <b>config terminal</b> switch(config)#	Enters configuration mode.
<b>Step 2</b>	switch(config)# <b>interface iscsi 4/1</b> switch(config-if)#	Selects the iSCSI interface on the switch that initiators will connect to.
<b>Step 3</b>	switch(config-if)# <b>switchport proxy-initiator</b>	Configures the proxy initiator mode with system-assignment nWWN and pWWN.
	switch(config-if)# <b>no switchport proxy-initiator</b>	(Optional) Disables the proxy initiator mode.
<b>Step 4</b>	switch(config-if)# <b>switchport proxy-initiator nWWN 11:11:11:11:11:11:11:11</b> <b>pwwn 22:22:22:22:22:22:22:22</b>	(Optional) Configures the proxy initiator mode using the specified WWNs.
	switch(config-if)# <b>no switchport proxy-initiator nWWN 11:11:11:11:11:11:11:11</b> <b>pwwn 22:22:22:22:22:22:22:22</b>	(Optional) Disables the proxy initiator mode.

To configure the proxy initiator using Fabric Manager, follow these steps:

- Step 1** Expand **Switches**, expand **Interfaces**, and then select **FC Logical** in the Physical Attributes pane.

You see the Interface tables in the Information pane (see [Figure 4-22](#)).

**Figure 4-22** FC Logical Interface Tables

Switch	Interface	Mode Admin	Mode Oper	Port VSAN	Dynamic VSAN	Description	Speed Admin	Speed Oper	Rate Mode	Status Service	Status Admin	Status Oper	FailureCause	Was Enabled	LastC
sw172-22-46-233	fcip2	auto	E		1 n/a		auto	1 Gb	shared	in	up	up	none	true	2007/1
sw172-22-46-221	channel1	E	TE		1 n/a	To sw172-22-46-220	auto	2 Gb	shared	in	up	up	none	false	2007/1
sw172-22-47-20	channel1	E	TE		1 n/a	To sw172-22-46-174	auto	10 Gb	shared	in	up	up	none	false	2007/1
sw172-22-47-133	channel1	E	TE		1 n/a	To sw172-22-47-132	auto	8 Gb	shared	in	up	up	none	false	2007/1
sw172-22-46-223	channel2	E	TE		1 n/a	To sw172-22-46-220	auto	1 Gb	shared	in	up	up	trunkNotFullyActive	false	2007/1
sw172-22-46-223	fcip6	auto	E		1 n/a		auto	1 Gb	shared	in	up	up	none	true	2007/1
sw172-22-46-223	channel1	E	TE		1 n/a	To sw172-22-46-220	auto	2 Gb	shared	in	up	up	trunkNotFullyActive	false	2007/1
sw172-22-47-132	channel1	E	TE		1 n/a	To sw172-22-47-133	auto	8 Gb	shared	in	up	up	trunkNotFullyActive	false	2007/1
sw172-22-46-220	channelH	E	TE		1 n/a	To sw172-22-46-221	auto	2 Gb	shared	in	up	up	trunkNotFullyActive	false	2007/1

- Step 2** In Device Manager, select **Interface > Ethernet and iSCSI**.

You see the Ethernet Interfaces and iSCSI dialog box (See in [Figure 4-23](#)).

Figure 4-23 Ethernet Interfaces and iSCSI Dialog Box

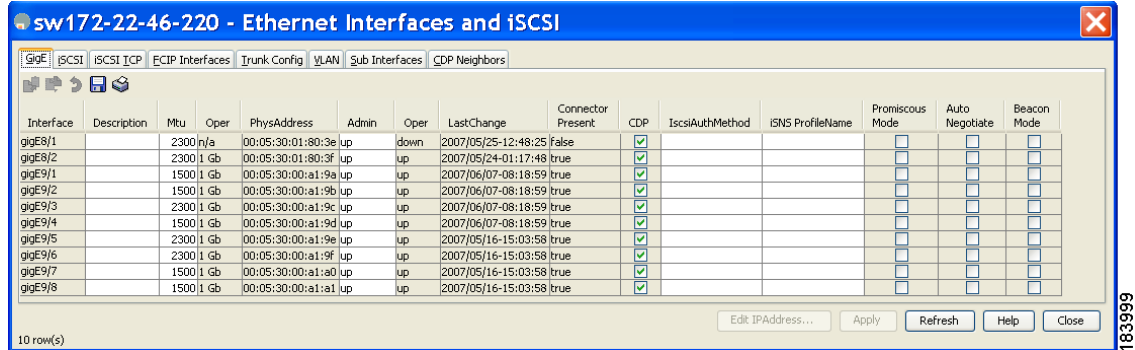

**Step 3** Click the **iSCSI** tab in either FM or DM.

You see the iSCSI interface configuration table (see Figure 4-24).

Figure 4-24 iSCSI Tab in Device Manager

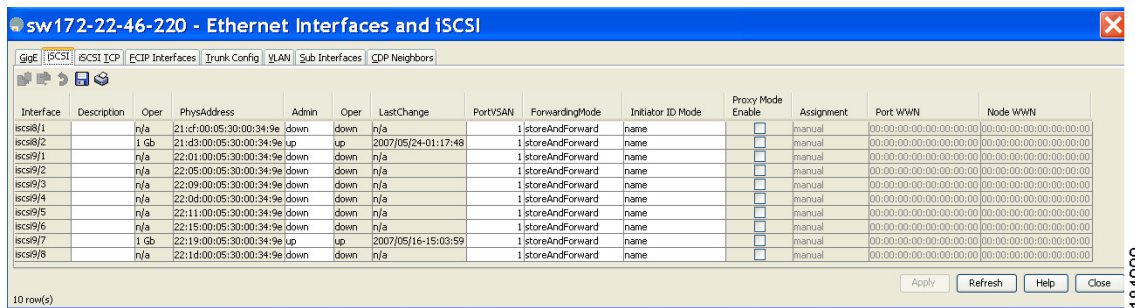

**Step 4** Check the **Proxy Mode Enable** check box.

**Step 5** Click the **Apply Changes** icon in Fabric Manager or click **Apply** in Device Manager to save these changes.



#### Note

When an interface is in proxy initiator mode, you can only configure Fibre Channel access control (zoning) based on the iSCSI interface's proxy N port attributes—the WWN pairs or the FC ID. You cannot configure zoning using iSCSI attributes such as IP address or IQN of the iSCSI initiator. To enforce initiator-based access control, use iSCSI based access control (see the [“iSCSI Access Control”](#) section on page 4-123).

## VSAN Membership for iSCSI

VSAN membership can be configured for an iSCSI interface, called the port VSAN. All the iSCSI devices that connect to this interface automatically become members of this VSAN, if it is not explicitly configured in a VSAN. The default port VSAN of an iSCSI interface is VSAN 1. Similar to Fibre Channel devices, iSCSI devices have two mechanisms by which VSAN membership can be defined.

- iSCSI host—VSAN membership to iSCSI host. (This method takes precedent over the iSCSI interface).

- iSCSI interface—VSAN membership to iSCSI interface. (All iSCSI hosts connecting to this iSCSI interface inherit the interface VSAN membership if the host is not configured in any VSAN by the iSCSI host method).

## Configuring VSAN Membership for iSCSI Hosts

Individual iSCSI hosts can be configured to be in a specific VSAN. The specified VSAN overrides the iSCSI interface VSAN membership.

To assign VSAN membership for iSCSI hosts, follow these steps:

	Command	Purpose
<b>Step 1</b>	switch# <b>config terminal</b> switch(config)#	Enters configuration mode.
<b>Step 2</b>	switch(config)# <b>iscsi initiator name</b> <b>iqn.1987-02.com.cisco.initiator</b> switch(config-iscsi-init)#	Configures an iSCSI initiator.
<b>Step 3</b>	switch(config-iscsi-init)# <b>vsan 3</b>	Assigns the iSCSI initiator node to a specified VSAN. <b>Note</b> You can assign this host to one or more VSANs.
	switch(config-iscsi-init)# <b>no vsan 5</b>	Removes the iSCSI node from the specified VSAN.

To assign VSAN membership for iSCSI hosts using Fabric Manager, follow these steps:

**Step 1** Choose **End Devices > iSCSI** in the Physical Attributes pane.

You see the iSCSI tables in the Information pane (see [Figure 4-5](#)).

**Step 2** Click the **Initiators** tab.

You see the iSCSI initiators configured.

**Step 3** Fill in the VSAN Membership field to assign a VSAN to the iSCSI hosts.

**Step 4** Click the **Apply Changes** icon to save these changes.



### Note

When an initiator is configured in any other VSAN (other than VSAN 1), for example VSAN 2, the initiator is automatically removed from VSAN 1. If you also want it to be present in VSAN 1, you must explicitly configure the initiator in VSAN 1.

## Configuring Default Port VSAN for iSCSI Interfaces

VSAN membership can be configured for an iSCSI interface, called the *port VSAN*. All the iSCSI devices that connect to this interface automatically become members of this VSAN, if it is not explicitly configured in a VSAN. In other words, the port VSAN of an iSCSI interface is the default VSAN for all dynamic iSCSI initiators. The default port VSAN of an iSCSI interface is VSAN 1.



### Caution

Changing the VSAN membership of an iSCSI interface that is part of an iSLB VRRP group impacts load balancing on the interface. See the [“Changing iSCSI Interface Parameters and the Impact on Load Balancing”](#) section on page 4-163.

To change the default port VSAN for an iSCSI interface, follow these steps:

	Command	Purpose
<b>Step 1</b>	switch# <b>config terminal</b> switch(config)#	Enters configuration mode.
<b>Step 2</b>	switch(config)# <b>iscsi interface</b> <b>vsan-membership</b>	Enables you to configure VSAN membership for iSCSI interfaces.
<b>Step 3</b>	switch(config)# <b>vsan database</b> switch(config-vsan-db)#	Configures the database for a VSAN. Application specific VSAN parameters cannot be configured from this prompt.
<b>Step 4</b>	switch(config-vsan-db)# <b>vsan 2</b> <b>interface iscsi 2/1</b>	Assigns the membership of the iscsi 2/1 interface to the specified VSAN (VSAN 2).
	switch(config-vsan-db)# <b>no vsan 2</b> <b>interface iscsi 2/1</b>	Reverts to using the default VSAN as the port VSAN of the iSCSI interface.

To change the default port VSAN for an iSCSI interface using Device Manager, follow these steps:

**Step 1** Choose **Interface > Ethernet and iSCSI**.

You see the Ethernet Interfaces and iSCSI dialog box (see [Figure 4-23](#)).

**Step 2** Click the **iSCSI** tab.

You see the iSCSI interface configuration table (see [Figure 4-24](#)).

**Step 3** Double-click the PortVSAN column and modify the default port VSAN.

**Step 4** Click **Apply** to save these changes.

### Example of VSAN Membership for iSCSI Devices

[Figure 4-25](#) provides an example of VSAN membership for iSCSI devices:

- iSCSI interface 1/1 is a member of VSAN Y.
- iSCSI initiator host A has explicit VSAN membership to VSAN X.
- Three iSCSI initiators (host A, host B, and host C) connect to iSCSI interface 1/1.

Figure 4-25 VSAN Membership for iSCSI Interfaces

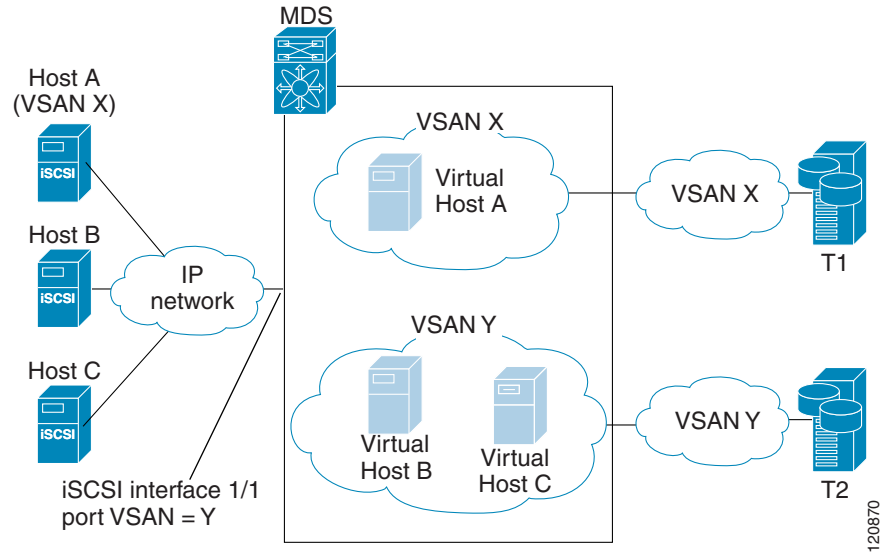

Host A's virtual Fibre Channel N port will be added to VSAN X because of explicit membership for the initiator. The virtual host-B and host-C N ports do not have any explicit membership configuration so they will inherit the iSCSI interface VSAN membership and be part of VSAN Y.

### Advanced VSAN Membership for iSCSI Hosts

An iSCSI host can be a member of multiple VSANs. In this case, multiple virtual Fibre Channel hosts are created, one in each VSAN in which the iSCSI host is a member. This configuration is useful when certain resources such as Fibre Channel tape devices need to be shared among different VSANs.

### iSCSI Access Control

Two methods of access control are available for iSCSI devices. Depending on the initiator mode used to present the iSCSI hosts in the Fibre Channel fabric, either or both of the access control methods can be used.

- Fiber Channel zoning-based access control—Fibre Channel zoning has been extended to support iSCSI devices, and this extension has the advantage of having a uniform, flexible access control mechanism across the whole SAN. In the case of iSCSI, multiple iSCSI devices may be connected behind an iSCSI interface. Interface-based zoning may not be useful because all iSCSI devices behind the interface will automatically be within the same zone.
- iSCSI ACL-based access control—iSCSI-based access control is applicable only if static iSCSI virtual targets are created. For a static iSCSI target, you can configure a list of iSCSI initiators that are allowed to access the targets. By default, static iSCSI virtual targets are not accessible to any iSCSI host.

Depending on the initiator mode used to present the iSCSI hosts in the Fibre Channel fabric, either or both the access control mechanisms can be used.

The following topics are included in this section:

- [Fibre Channel Zoning-Based Access Control, page 4-124](#)
- [iSCSI-Based Access Control, page 4-126](#)
- [Enforcing Access Control, page 4-128](#)

## Fibre Channel Zoning-Based Access Control

Cisco SAN-OS Release 3.x and NX-OS Release 4.1(1b) VSAN and zoning concepts have been extended to cover both Fibre Channel devices and iSCSI devices. Zoning is the standard access control mechanism for Fibre Channel devices, which is applied within the context of a VSAN. Fibre Channel zoning has been extended to support iSCSI devices, and this extension has the advantage of having a uniform, flexible access control mechanism across the whole SAN.

Common mechanisms for identifying members of a Fibre Channel zone are the following:

- Fibre Channel device pWWN.
- Interface and switch WWN. Device connecting via that interface is within the zone.

See the *Cisco Fabric Manager Fabric Configuration Guide* and *Cisco MDS 9000 Family NX-OS Fabric Configuration Guide* for details on Fibre Channel zoning.

In the case of iSCSI, multiple iSCSI devices may be connected behind an iSCSI interface. Interface-based zoning may not be useful because all the iSCSI devices behind the interface will automatically be within the same zone.

In transparent initiator mode (where one Fibre Channel virtual N port is created for each iSCSI host as described in the [“Transparent Initiator Mode” section on page 4-111](#)), if an iSCSI host has static WWN mapping then the standard Fibre Channel device pWWN-based zoning membership mechanism can be used.

Zoning membership mechanism has been enhanced to add iSCSI devices to zones based on the following:

- IPv4 address/subnet mask
- IPv6 address/prefix length
- iSCSI qualified name (IQN)
- Symbolic-node-name (IQN)

For iSCSI hosts that do not have a static WWN mapping, the feature allows the IP address or iSCSI node name to be specified as zone members. Note that iSCSI hosts that have static WWN mapping can also use these features. IP address based zone membership allows multiple devices to be specified in one command by providing the subnet mask.



### Note

In proxy initiator mode, all iSCSI devices connecting to an IPS port gain access to the Fibre Channel fabric through a single virtual Fibre Channel N port. Zoning based on the iSCSI node name or IP address will not have any effect. If zoning based on pWWN is used, then all iSCSI devices connecting to that IPS port will be put in the same zone. To implement individual initiator access control in proxy initiator mode, configure an iSCSI ACL on the virtual target (see the [“iSCSI-Based Access Control” section on page 4-126](#)).

To add an iSCSI initiator to the zone database, follow these steps:

	Command	Purpose
<b>Step 1</b>	switch# <b>config terminal</b> switch(config)#	Enters configuration mode.
<b>Step 2</b>	switch(config)# <b>zone name iSCSIzone vsan 1</b> switch(config-zone)	Creates a zone name for the iSCSI devices in the Fibre Channel module with IPS ports or MPS-14/2 module to be included.
<b>Step 3</b>	switch(config-zone)# <b>member symbolic-nodename iqn.1987-02.com.cisco.initiator1</b>	Assigns an iSCSI node name-based membership into a zone.
	switch(config-zone)# <b>no member symbolic-nodename iqn.1987-02.com.cisco.init1</b>	(Optional) Deletes the specified device from a zone.
	switch(config-zone)# <b>member ip-address 10.50.1.1</b>	Assigns an iSCSI IPv4 address-based membership into a zone.
	switch(config-zone)# <b>no member ip-address 10.50.1.1</b>	(Optional) Deletes the specified device from a zone.
	switch(config-zone)# <b>member ipv6-address 2001:0DB8:800:200C::417A</b>	Assigns an iSCSI IPv6 address-based membership into a zone.
	switch(config-zone)# <b>no member ipv6-address 2001:0DB8:800:200C::417A</b>	Deletes the specified device from a zone.
	switch(config-zone)# <b>member pwwn 20:00:00:05:30:00:59:11</b>	Assigns an iSCSI port WWN-based membership into a zone.
	switch(config-zone)# <b>no member pwwn 20:00:00:05:30:00:59:11</b>	Deletes the device identified by the port WWN from a zone.

To add an iSCSI initiator to the zone database using Fabric Manager, follow these steps:

**Step 1** Choose **Zone > Edit Local Full Zone Database**.

You see the Edit Local Zone Database dialog box (see [Figure 4-26](#)).

**Figure 4-26** Edit Local Zone Database Dialog Box in Fabric Manager

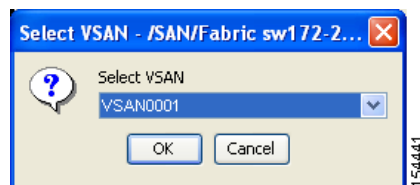

**Step 2** Select the VSAN you want to add the iSCSI host initiator to and click **OK**.

You see the available zones and zone sets for that VSAN (see [Figure 4-27](#)).

Figure 4-27 Available Zones and Zone Sets

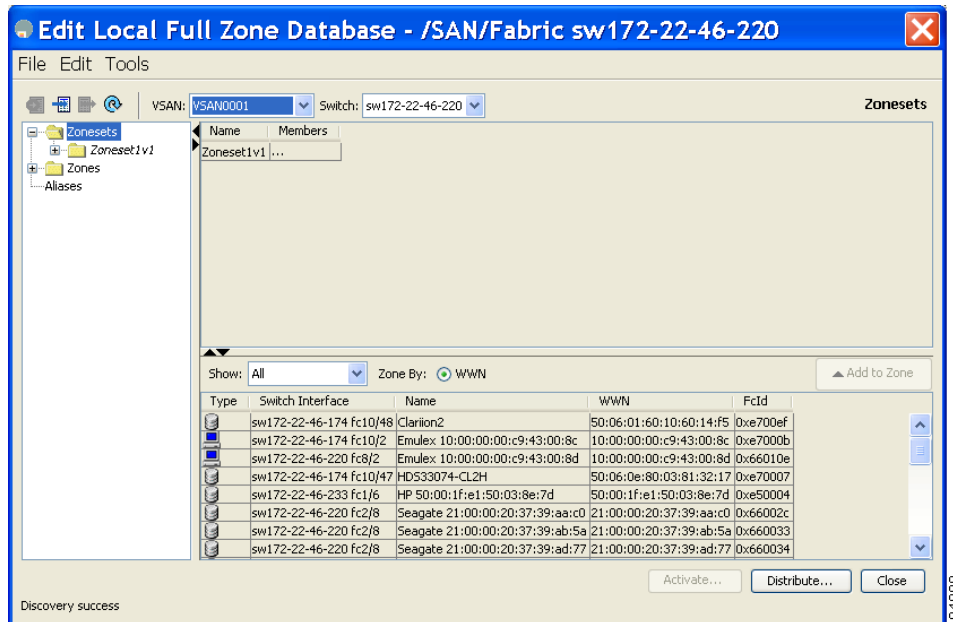

- Step 3** From the list of available devices with iSCSI host initiators, drag the initiators to add into the zone.
- Step 4** Click **Distribute** to distribute the change.

## iSCSI-Based Access Control

iSCSI-based access control is applicable only if static iSCSI virtual targets are created (see the “Static Mapping” section on page 4-106). For a static iSCSI target, you can configure a list of iSCSI initiators that are allowed to access the targets.

By default, static iSCSI virtual targets are not accessible to any iSCSI host. You must explicitly configure accessibility to allow an iSCSI virtual target to be accessed by all hosts. The initiator access list can contain one or more initiators. The iSCSI initiator can be identified by one of the following mechanisms:

- iSCSI node name
- IPv4 address and subnet
- IPv6 address



### Note

For a transparent mode iSCSI initiator, if both Fibre Channel zoning and iSCSI ACLs are used, then for every static iSCSI target that is accessible to the iSCSI host, the initiator’s virtual N port should be in the same Fibre Channel zone as the Fibre Channel target.

To configure access control in iSCSI follow these steps:

	Command	Purpose
<b>Step 1</b>	switch# <b>config terminal</b> switch(config)#	Enters configuration mode.
<b>Step 2</b>	switch(config)# <b>iscsi virtual-target name</b> <b>iqn.1987-02.com.cisco.initiator</b> switch(config-iscsi-tgt)#	Creates the iSCSI target name iqn.1987-02.com.cisco.initiator.
<b>Step 3</b>	switch(config-iscsi-tgt)# <b>pwwn</b> <b>26:00:01:02:03:04:05:06</b> switch(config-iscsi-tgt)#	Maps a virtual target node to a Fibre Channel target.
<b>Step 4</b>	switch(config-iscsi-tgt)# <b>initiator</b> <b>iqn.1987-02.com.cisco.initiator1 permit</b>	Allows the specified iSCSI initiator node to access this virtual target. You can issue this command multiple times to allow multiple initiators.
	switch(config-iscsi-tgt)# <b>no initiator</b> <b>iqn.1987-02.com.cisco.initiator1 permit</b>	(Optional) Prevents the specified initiator node from accessing virtual targets.
	switch(config-iscsi-tgt)# <b>no initiator ip</b> <b>address 10.50.1.1 permit</b>	Prevents the specified IPv4 address from accessing virtual targets.
	switch(config-iscsi-tgt)# <b>initiator ip</b> <b>address 10.50.1.0 255.255.255.0 permit</b>	Allows all initiators in this IPv4 subnetwork (10.50.1/24) to access this virtual target.
	switch(config-iscsi-tgt)# <b>no initiator ip</b> <b>address 10.50.1.0 255.255.255.0 permit</b>	Prevents all initiators in this IPv4 subnetwork from accessing virtual targets.
	switch(config-iscsi-tgt)# <b>initiator ip</b> <b>address 2001:0DB8:800:200C::/64 permit</b>	Allows all initiators in this IPv6 subnetwork (2001:0DB8:800:200C::/64) to access this virtual target.
	switch(config-iscsi-tgt)# <b>no initiator ip</b> <b>address 2001:0DB8:800:200C::/64 permit</b>	Prevents all initiators in this IPv6 subnetwork from accessing virtual targets.
	switch(config-iscsi-tgt)# <b>all-initiator-permit</b>	Allows all initiator nodes to access this virtual target.
	switch(config-iscsi-tgt)# <b>no</b> <b>all-initiator-permit</b>	Prevents any initiator from accessing virtual targets (default).

To configure access control in iSCSI using Device Manager, follow these steps:

**Step 1** Select **IP > iSCSI**.

You see the iSCSI configuration (see [Figure 4-12](#)).

**Step 2** Click the **Targets** tab.

You see the iSCSI virtual targets.

**Step 3** Uncheck the **Initiators Access All** check box if checked.

**Step 4** Click **Edit Access**.

You see the Initiators Access dialog box.

**Step 5** Click **Create** to add more initiators to the Initiator Access list.

You see the Create Initiators Access dialog box.

**Step 6** Add the name or IP address for the initiator that you want to permit for this virtual target.

**Step 7** Click **Create** to add this initiator to the Initiator Access List.

---

## Enforcing Access Control

Fibre Channel module with IPS ports and MPS-14/2 modules use both iSCSI and Fibre Channel zoning-based access control lists to enforce access control. Access control is enforced both during the iSCSI discovery phase and the iSCSI session creation phase. Access control enforcement is not required during the I/O phase because the Fibre Channel module with IPS ports or MPS-14/2 module is responsible for the routing of iSCSI traffic to Fibre Channel.

- iSCSI discovery phase—When an iSCSI host creates an iSCSI discovery session and queries for all iSCSI targets, the Fibre Channel module with IPS ports or MPS-14/2 module returns only the list of iSCSI targets this iSCSI host is allowed to access based on the access control policies discussed in the previous section. The Fibre Channel module with IPS ports or MPS-14/2 module does this by querying the Fibre Channel name server for all the devices in the same zone as the initiator in all VSANs. It then filters out the devices that are initiators by looking at the FC4-feature field of the FCNS entry. (If a device does not register as either initiator or target in the FC4-feature field, the Fibre Channel module with IPS ports or MPS-14/2 module will advertise it). It then responds to the iSCSI host with the list of targets. Each will have either a static iSCSI target name that you configure or a dynamic iSCSI target name that the Fibre Channel module with IPS ports or MPS-14/2 module creates for it (see the [“Dynamic Mapping”](#) section on page 4-104).
- iSCSI session creation—When an IP host initiates an iSCSI session, the Fibre Channel module with IPS ports or MPS-14/2 module verifies if the specified iSCSI target (in the session login request) is allowed by both the access control mechanisms described in the [“iSCSI-Based Access Control”](#) section on page 4-126.

If the iSCSI target is a static mapped target, the Fibre Channel module with IPS ports or MPS-14/2 module verifies if the iSCSI host is allowed within the access list of the iSCSI target. If the IP host does not have access, its login is rejected. If the iSCSI host is allowed, it validates if the virtual Fibre Channel N port used by the iSCSI host and the Fibre Channel target mapped to the static iSCSI virtual target are in the same Fibre Channel zone.

If the iSCSI target is an autogenerated iSCSI target, then the Fibre Channel module with IPS ports or MPS-14/2 module extracts the WWN of the Fibre Channel target from the iSCSI target name and verifies if the initiator and the Fibre Channel target is in the same Fibre Channel zone or not. If they are, then access is allowed.

The Fibre Channel module with IPS ports or MPS-14/2 module uses the Fibre Channel virtual N port of the iSCSI host and does a zone-enforced name server query for the Fibre Channel target WWN. If the FC ID is returned by the name server, then the iSCSI session is accepted. Otherwise, the login request is rejected.

## iSCSI Session Authentication

The Fibre Channel module with IPS ports or MPS-14/2 module supports the iSCSI authentication mechanism to authenticate the iSCSI hosts that request access to the storage devices. By default, the Fibre Channel module with IPS ports or MPS-14/2 modules allow CHAP or None authentication of iSCSI initiators. If authentication is always used, you must configure the switch to allow only CHAP authentication.

For CHAP user name or secret validation, you can use any method supported and allowed by the Cisco MDS AAA infrastructure. AAA authentication supports a RADIUS, TACACS+, or local authentication device. See the *Cisco Fabric Manager Security Configuration Guide*.

The **aaa authentication iscsi** command enables AAA authentication for the iSCSI host and specifies the method to use. See *Cisco MDS 9000 Family NX-OS Security Configuration Guide*

To configure AAA authentication for an iSCSI user, follow these steps:

	Command	Purpose
<b>Step 1</b>	switch# <b>config terminal</b> switch(config)#	Enters configuration mode.
<b>Step 2</b>	switch(config)# <b>aaa authentication iscsi default group RadServerGrp</b>	Uses RADIUS servers that are added in the group called RadServerGrp for the iSCSI CHAP authentication.
	switch(config)# <b>aaa authentication iscsi default group TacServerGrp</b>	Uses TACACS+ servers that are added in the group called TacServerGrp for the iSCSI CHAP authentication.
	switch(config)# <b>aaa authentication iscsi default local</b>	Uses the local password database for iSCSI CHAP authentication.

To configure AAA authentication for an iSCSI user using Fabric Manager, follow these steps:

**Step 1** Choose **Switches > Security > AAA** in the Physical Attributes pane.

You see the AAA configuration in the Information pane.

**Step 2** Click the **Applications** tab.

You see the AAA configuration per application (see [Figure 4-28](#)).

**Figure 4-28 AAA per Application Configuration**

Switch	Type, SubType, Function	Server Group IdList	Local	Trivial
sw172-22-46-233	default, all, accounting		<input checked="" type="checkbox"/>	<input type="checkbox"/>
sw172-22-46-220	default, all, accounting		<input checked="" type="checkbox"/>	<input type="checkbox"/>
sw172-22-46-224	default, all, accounting		<input checked="" type="checkbox"/>	<input type="checkbox"/>
sw172-22-46-223	default, all, accounting		<input checked="" type="checkbox"/>	<input checked="" type="checkbox"/>
sw172-22-46-182	default, all, accounting		<input checked="" type="checkbox"/>	<input type="checkbox"/>
sw172-22-46-222	default, all, accounting		<input checked="" type="checkbox"/>	<input type="checkbox"/>
sw172-22-46-225	default, all, accounting		<input checked="" type="checkbox"/>	<input type="checkbox"/>
sw172-22-47-20	default, all, accounting		<input checked="" type="checkbox"/>	<input type="checkbox"/>
sw172-22-46-221	default, all, accounting		<input checked="" type="checkbox"/>	<input type="checkbox"/>
sw172-22-47-167	default, all, accounting		<input checked="" type="checkbox"/>	<input type="checkbox"/>
sw172-22-46-224	login, all, authentication		<input checked="" type="checkbox"/>	<input type="checkbox"/>
sw172-22-46-224	login, all, authentication		<input checked="" type="checkbox"/>	<input type="checkbox"/>

**Step 3** Right-click the ServerGroup Id List field for the iSCSI application and enter the server group that you want iSCSI to use.



**Note** You should use an existing server group or create a new server group before configuring it for iSCSI session authentication.

**Step 4** Click the **Apply Changes** icon to save these changes.

The following topics are included in this section:

- [Configuring Authentication Mechanism, page 4-130](#)
- [Configuring Local Authentication, page 4-131](#)
- [Restricting iSCSI Initiator Authentication, page 4-132](#)
- [Configuring Mutual CHAP Authentication, page 4-132](#)
- [Configuring an iSCSI RADIUS Server, page 4-134](#)

## Configuring Authentication Mechanism

You can configure iSCSI CHAP or None authentication at both the global level and at each interface level.

The authentication for a Gigabit Ethernet interface or subinterface overrides the authentication method configured at the global level.

If CHAP authentication is used, issue the **iscsi authentication chap** command at either the global level or at a per-interface level. If authentication should not be used at all, issue the **iscsi authentication none** command.

To configure the authentication mechanism for iSCSI, follow these steps:

	Command	Purpose
<b>Step 1</b>	switch# <b>config terminal</b> switch(config)#	Enters configuration mode.
<b>Step 2</b>	switch(config)# <b>iscsi authentication chap</b>	Configures CHAP as the default authentication mechanism globally for the Cisco MDS switch. CHAP authentication is required for all iSCSI sessions.

To configure AAA authentication for an iSCSI user using Fabric Manager, follow these steps:

**Step 1** Choose **End Devices > iSCSI** in the Physical Attributes pane.

You see the iSCSI tables in the Information pane (see [Figure 4-5](#)).

**Step 2** Click the **Globals** tab.

You see the iSCSI authentication configuration table.

**Step 3** Select **chap** or **none** from the authMethod column.

**Step 4** Click the **Apply Changes** icon in Fabric Manager to save these changes.

To configure the authentication mechanism for iSCSI sessions to a particular interface, follow these steps:

	Command	Purpose
<b>Step 1</b>	switch# <b>config terminal</b> switch(config)#	Enters configuration mode.
<b>Step 2</b>	switch(config)# <b>interface GigabitEthernet 2/1.100</b> switch(config-if)#	Selects the Gigabit Ethernet interface.
<b>Step 3</b>	switch(config-if)# <b>iscsi authentication none</b>	Specifies that no authentication is required for iSCSI sessions to the selected interface.

To configure the authentication mechanism for iSCSI sessions to a particular interface using Fabric Manager, follow these steps:

**Step 1** Choose **Switches > Interfaces > Gigabit Ethernet** in the Physical Attributes pane.

You see the Gigabit Ethernet configuration in the Information pane.

**Step 2** Click the **iSNS** tab.

You see the iSCSI and iSNS configuration (see [Figure 4-29](#)).

Figure 4-29 Configuring iSCSI Authentication on an Interface

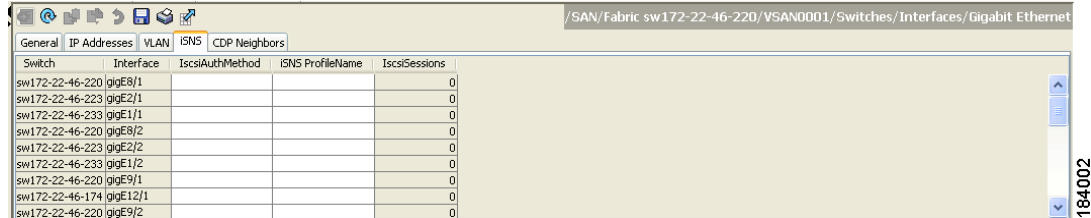

- Step 3** Right-click on the **IscsiAuthMethod** field and select none or chap.
- Step 4** Click the **Apply Changes** icon to save these changes.

## Configuring Local Authentication

See the *Cisco Fabric Manager Security Configuration Guide* and *Cisco MDS 9000 Family NX-OS Security Guide* to create the local password database. To create users in the local password database for the iSCSI initiator, the iSCSI keyword is mandatory.

To configure iSCSI users for local authentication, follow these steps:

	Command	Purpose
<b>Step 1</b>	switch# <b>config terminal</b> switch(config)#	Enters configuration mode.
<b>Step 2</b>	switch(config)# <b>username iscsiuser</b> <b>password ffsffsffs345353554535</b> <b>iscsi</b>	Configures a user name (iscsiuser) and password (ffsffsffs345353554535) in the local database for iSCSI login authentication.

To configure iSCSI users for local authentication using Device Manager, follow these steps:

- Step 1** Choose **Security > iSCSI**.

You see the iSCSI Security dialog box (see [Figure 4-30](#)).

Figure 4-30 iSCSI Security Dialog Box

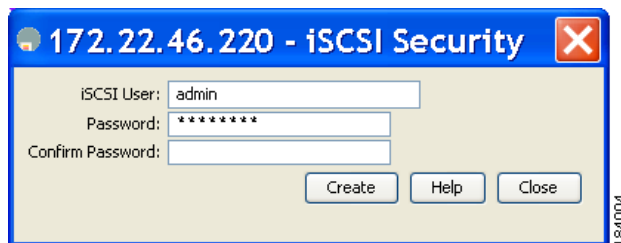

- Step 2** Complete the iSCSI User, Password, and Password Confirmation fields.
- Step 3** Click **Create** to save this new user.

## Restricting iSCSI Initiator Authentication

By default, the iSCSI initiator can use any user name in the RADIUS server or in the local database in authenticating itself to the Fibre Channel module with IPS ports or MPS-14/2 module (the CHAP user name is independent of the iSCSI initiator name). The Fibre Channel module with IPS ports or MPS-14/2 module allows the initiator to log in as long as it provides a correct response to the CHAP challenge sent by the switch. This can be a problem if one CHAP user name and password has been compromised.

To restrict an initiator to use a specific user name for CHAP authentication, follow these steps:

	Command	Purpose
<b>Step 1</b>	switch# <b>config terminal</b> switch(config)#	Enters configuration mode.
<b>Step 2</b>	switch(config)# <b>iscsi initiator</b> <b>name iqn.1987-02.com.cisco.init</b> switch(config-iscsi-init)#	Enters the configuration submode for the initiator iqn.1987-02.com.cisco.init.
<b>Step 3</b>	switch(config-iscsi-init)# <b>username user1</b>	Restricts the initiator iqn.1987-02.com.cisco.init to only authenticate using user1 as its CHAP user name.  <b>Note</b> Be sure to define user1 as an iSCSI user in the local AAA database or the RADIUS server.

To restrict an initiator to use a specific user name for CHAP authentication using Fabric Manager, follow these steps:

---

**Step 1** Choose **End Devices > iSCSI** in the Physical Attributes pane.

You see the iSCSI tables in the Information pane (see [Figure 4-5](#)).

**Step 2** Right-click the AuthUser field and enter the user name to which you want to restrict the iSCSI initiator.

**Step 3** Click the **Apply Changes** icon to save these changes.

---

## Configuring Mutual CHAP Authentication

The Fibre Channel module with IPS ports or MPS-14/2 module supports a mechanism by which the iSCSI initiator can authenticate the Cisco MDS switch's iSCSI target during the iSCSI login phase. This authentication is available in addition to the Fibre Channel module with IPS ports or MPS-14/2 module authentication of the iSCSI initiator.

In addition to the Fibre Channel module with IPS ports or MPS-14/2 module authentication of the iSCSI initiator, the Fibre Channel module with IPS ports or MPS-14/2 module also supports a mechanism for the iSCSI initiator to authenticate the Cisco MDS switch's iSCSI target during the iSCSI login phase. This authentication requires the user to configure a user name and password for the switch to present to the iSCSI initiator. The provided password is used to calculate a CHAP response to a CHAP challenge sent to the IPS port by the initiator.

To configure a global iSCSI target user name and password to be used by the switch to authenticate itself to an initiator, follow these steps:

	Command	Purpose
<b>Step 1</b>	switch# <b>config terminal</b> switch(config)#	Enters configuration mode.

	Command	Purpose
<b>Step 2</b>	<code>switch(config)# iscsi authentication username testuser password abc123</code>	Configures the switch user account (testuser) along with a password (abc123) specified in clear text (default) for all initiators. The password is limited to 128 characters.
	<code>switch(config)# iscsi authentication username user1 password 7!*asdfsdfjh!@df</code>	Configures the switch user account (user1) along with the encrypted password specified by 7 (!@*asdfsdfjh!@df) for all initiators.
	<code>switch(config)# iscsi authentication username user1 password 0 abcd12AAA</code>	Configures the switch user account (user1) along with a password (abcd12AAA) specified in clear text (indicated by 0—default) for all initiators. The password is limited to 128 characters.
	<code>switch(config)# no iscsi authentication username testuser</code>	Removes the global configuration for all initiators.

To configure a global iSCSI target user name and password to be used by the switch to authenticate itself to an initiator using Fabric Manager, follow these steps:

**Step 1** Choose **End Devices > iSCSI** in the Physical Attributes pane.

You see the iSCSI tables in the Information pane (see [Figure 4-5](#)).

**Step 2** Select the **Globals** tab.

You see the global iSCSI configuration.

**Step 3** Fill in the Target UserName and Target Password fields.

**Step 4** Click the **Apply Changes** icon to save these changes.

To configure a per-initiator iSCSI target's user name and password used by the switch to authenticate itself to an initiator, follow these steps:

	Command	Purpose
<b>Step 1</b>	<code>switch# config terminal switch(config)#</code>	Enters configuration mode.
<b>Step 2</b>	<code>switch(config)# iscsi initiator name iqn.1987-02.com.cisco.initiator switch(config-iscsi-init)#</code>	Configures an iSCSI initiator using the iSCSI name of the initiator node.
<b>Step 3</b>	<code>switch(config-iscsi-init)# mutual-chap username testuser password abcd12AAA</code>	Configures the switch user account (testuser) along with a password (abcd12AAA) specified in clear text (default). The password is limited to 128 characters.
	<code>switch(config-iscsi-init)# mutual-chap username user1 password 7!*asdfsdfjh!@df</code>	Configures the switch user account (user1) along with the encrypted password specified by 7 (!@*asdfsdfjh!@df).
	<code>switch(config-iscsi-init)# no mutual-chap username testuser</code>	Removes the switch authentication configuration.

Use the **show running-config** and the **show iscsi global** commands to display the global configuration. Use the **show running-config** and the **show iscsi initiator configured** commands to display the initiator specific configuration. (See the “[Displaying iSCSI Information](#)” section on page 4-138 for command output examples).

To configure a per-initiator iSCSI target's user name and password used by the switch to authenticate itself to an initiator using Device Manager, follow these steps:

---

**Step 1** Choose **IP > iSCSI**.

You see the iSCSI configuration (see [Figure 4-12](#)).

**Step 2** Complete the Target UserName and Target Password fields for the initiator that you want to configure.

**Step 3** Click **Create** to add this initiator to the Initiator Access List.

---

## Configuring an iSCSI RADIUS Server

To configure an iSCSI RADIUS server, follow these steps:

---

**Step 1** Configure the RADIUS server to allow access from the Cisco MDS switch's management Ethernet IP address.

**Step 2** Configure the shared secret for the RADIUS server to authenticate the Cisco MDS switch.

**Step 3** Configure the iSCSI users and passwords on the RADIUS server.

---

## iSCSI Immediate Data and Unsolicited Data Features

Cisco MDS switches support the iSCSI immediate data and unsolicited data features if requested by the initiator during the login negotiation phase. Immediate data is iSCSI write data contained in the data segment of an iSCSI command protocol data unit (PDU), such as combining the write command and write data together in one PDU. Unsolicited data is iSCSI write data that an initiator sends to the iSCSI target, such as an MDS switch, in an iSCSI data-out PDU without having to receive an explicit ready to transfer (R2T) PDU from the target.

These two features help reduce I/O time for small write commands because it removes one round-trip between the initiator and the target for the R2T PDU. As an iSCSI target, the MDS switch allows up to 64 KB of unsolicited data per command. This is controlled by the FirstBurstLength parameter during iSCSI login negotiation phase.

If an iSCSI initiator supports immediate data and unsolicited data features, these features are automatically enabled on the MDS switch with no configuration required.

## iSCSI Interface Advanced Features

Advanced configuration options are available for iSCSI interfaces on a per-IPS port basis. These configurations are similar to the advanced FCIP configurations and are already explained in that section (see [Advanced FCIP Profile Configuration, page 2-28](#) for more information).

To access these commands from the iSCSI interface, follow these steps:

	Command	Purpose
<b>Step 1</b>	switch# <b>config terminal</b> switch(config)#	Enters configuration mode.
<b>Step 2</b>	switch(config)# <b>interface iscsi 4/1</b> switch(config-if)#	Selects the iSCSI interface on the switch.

Cisco MDS switches support the following advanced features for iSCSI interfaces:

- [iSCSI Listener Port, page 4-135](#)
- [TCP Tuning Parameters, page 4-135](#)
- [Setting QoS Values, page 4-135](#)
- [iSCSI Routing Modes, page 4-136](#)

## iSCSI Listener Port

You can configure the TCP port number for the iSCSI interface that listens for new TCP connections. The default port number is 3260. Once you change the TCP port number, the iSCSI port only accepts TCP connections on the newly configured port.

## TCP Tuning Parameters

You can configure the following TCP parameters:

- Minimum retransmit timeout (See the [“Minimum Retransmit Timeout”](#) section on page 2-29 for more information).
- Keepalive timeout (See the [“Keepalive Timeout”](#) section on page 2-29 for more information).
- Maximum retransmissions (See the [“Maximum Retransmissions”](#) section on page 2-29 for more information).
- Path MTU (See the [“Path MTUs”](#) section on page 2-30 for more information).
- SACK (SACK is enabled by default for iSCSI TCP configurations).
- Window management (The iSCSI defaults are max-bandwidth is 1 Gbps, min-available-bandwidth is 70 Mbps, and round-trip-time is 1 msec). (See the [“Window Management”](#) section on page 2-31 for more information).
- Buffer size (The iSCSI default send buffer size is 4096 KB) (See the [“Displaying FCIP Profile Information”](#) section on page 2-33 for more information).
- Window congestion monitoring (enabled by default and the default burst size is 50 KB) (See the [“Monitoring Congestion”](#) section on page 2-32 for more information).
- Maximum delay jitter (enabled by default and the default time is 500 microseconds).

## Setting QoS Values

To set the QoS values, follow these steps:

	Command	Purpose
<b>Step 1</b>	<code>switch(config-if)# qos 3</code>	Configures the differentiated services code point (DSCP) value of 3 to be applied to all outgoing IP packets in this iSCSI interface. The valid range for the iSCSI DSCP value is from 0 to 63.
<b>Step 2</b>	<code>switch(config-if)# no qos 5</code>	Reverts the switch to its factory default (marks all packets with DSCP value 0).

To set the QoS values using Fabric Manager, follow these steps:

- Step 1** Expand **Switches**, expand **Interfaces** and then select **FC Logical** in the Physical Attributes pane.

You see the Interface tables in the Information pane (see [Figure 4-22](#)).

- Step 2** In Device Manager, choose **Interface > Ethernet and iSCSI**.

You see the Ethernet Interfaces and iSCSI dialog box (see [Figure 4-23](#)).

**Step 3** Click the **iSCSI TCP** tab in either Fabric Manager or Device Manager.

You see the iSCSI TCP configuration table.

**Step 4** Set the QoS field from 1 to 6.

**Step 5** Click the **Apply Changes** icon in Fabric Manager or click **Apply** in Device Manager to save these changes.

## iSCSI Routing Modes

Cisco MDS 9000 Family switches support multiple iSCSI routing modes. Each mode negotiates different operational parameters, has different advantages and disadvantages, and is suitable for different usages.

- Pass-thru mode

In pass-thru mode, the port on the Fibre Channel module with IPS ports or MPS 14/2 module converts and forwards read data frames from the Fibre Channel target to the iSCSI host frame-by-frame without buffering. This means that one data-in frame received is immediately sent out as one iSCSI data-in PDU.

In the opposite direction, the port on the Fibre Channel module with IPS ports or MPS 14/2 module limits the maximum size of iSCSI write data-out PDU that the iSCSI host can send to the maximum data size that the Fibre Channel target specifies that it can receive. The result is one iSCSI data-out PDU received sent out as one Fibre Channel data frame to the Fibre Channel target.

The absence of buffering in both directions leads to an advantage of lower forwarding latency. However, a small maximum data segment length usually results in lower data transfer performance from the host because of a higher processing overhead by the host system. Another benefit of this mode is iSCSI data digest can be enabled. This helps protect the integrity of iSCSI data carried in the PDU over what TCP checksum offers.

- Store-and-forward mode (default)

In store-and-forward mode, the port on the Fibre Channel module with IPS ports or MPS 14/2 module assembles all the Fibre Channel data frames of an exchange to build one large iSCSI data-in PDU before forwarding it to the iSCSI client.

In the opposite direction, the port on the Fibre Channel module with IPS ports or MPS 14/2 module does not impose a small data segment size on the host so the iSCSI host can send an iSCSI data-out PDU of any size (up to 256 KB). The port then waits until the whole iSCSI data-out PDU is received before it converts, or splits, the PDU, and forwards Fibre Channel frames to the Fibre Channel target.

The advantage of this mode is higher data transfer performance from the host. The disadvantages are higher transfer latency and that the iSCSI data digest (CRC) cannot be used.



---

**Note** The store-and-forward mode is the default forwarding mode.

---

- Cut-through mode

Cut-through mode improves the read operation performance over store-and-forward mode. The port on the Fibre Channel module with IPS ports or MPS 14/2 module achieves this by forwarding each Fibre Channel data-in frame to the iSCSI host as it is received without waiting for the whole exchange complete. There is no difference for write data-out operations from store-and-forward mode.

Figure 4-31 compares the messages exchanged by the iSCSI routing modes.

Figure 4-31 iSCSI Routing Modes

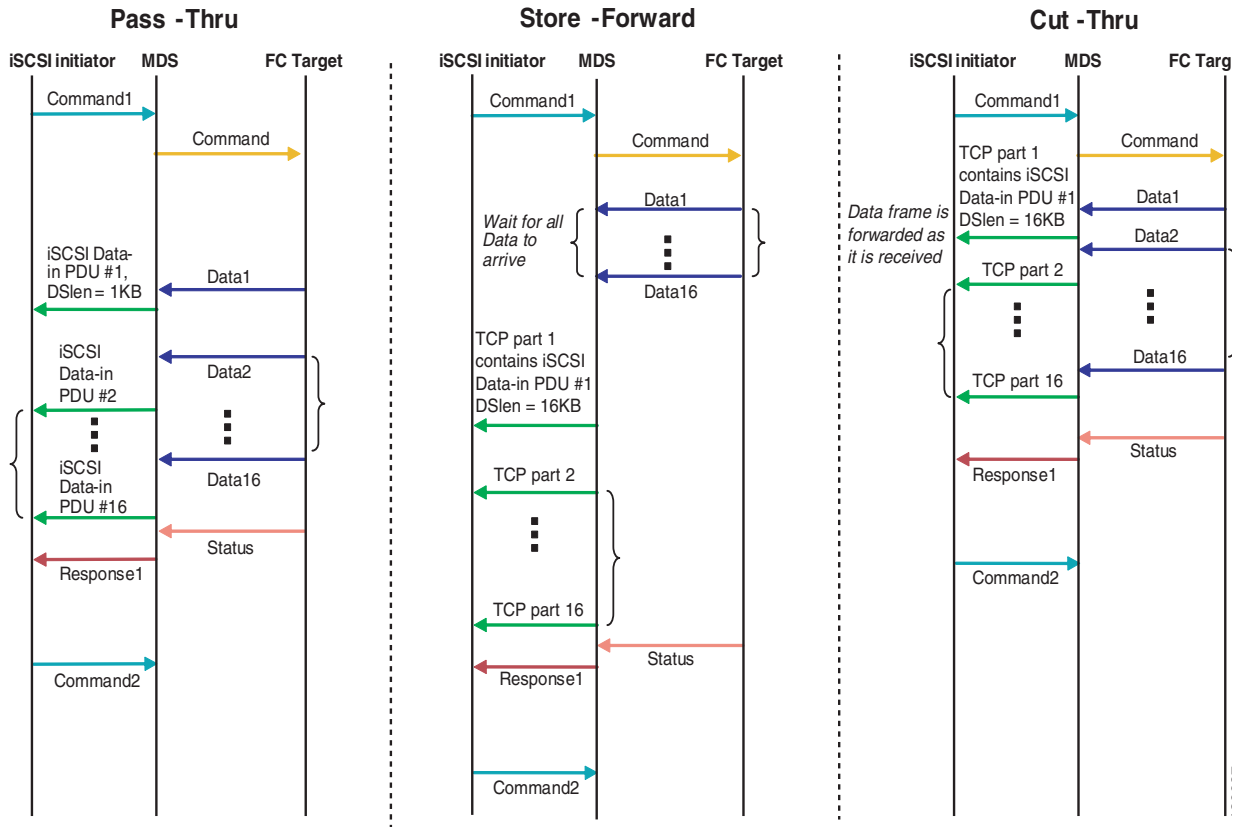

Table 4-1 compares the advantages and disadvantages of the different iSCSI routing modes.

Table 4-1 Comparison of iSCSI Routing Modes

Mode	Advantages	Disadvantages
Pass-thru	Low-latency Data digest can be used	Lower data transfer performance.
Store-and-forward	Higher data transfer performance	Data digest cannot be used.
Cut-thru	Improved read performance over store-and-forward	If the Fibre Channel target sent read data for different commands interchangeably, data of the first command is forwarded in cut-thru mode but the data of subsequent commands is buffered and the behavior is the same as store-and-forward mode. Data digest cannot be used.

**Caution**

Changing the forwarding mode of an iSCSI interface that is part of an iSLB VRRP group impacts load balancing on the interface. See the [“Changing iSCSI Interface Parameters and the Impact on Load Balancing”](#) section on page 4-163.

## Displaying iSCSI Information

Use the **show iscsi** command to obtain detailed information about iSCSI configurations.

This section includes the following topics:

- [Displaying iSCSI Interfaces, page 4-138](#)
- [Displaying iSCSI Statistics, page 4-139](#)
- [Displaying Proxy Initiator Information, page 4-140](#)
- [Displaying Global iSCSI Information, page 4-142](#)
- [Displaying iSCSI Sessions, page 4-142](#)
- [Displaying iSCSI Initiators, page 4-143](#)
- [Displaying iSCSI Virtual Targets, page 4-146](#)
- [Displaying iSCSI User Information, page 4-147](#)

## Displaying iSCSI Interfaces

Use the **show iscsi interface** command to view the summary, counter, description, and status of the iSCSI interface. Use the output to verify the administrative mode, the interface status, TCP parameters currently used, and brief statistics.

### Example 4-1 Displaying the iSCSI Interface Information

```
switch# show interface iscsi 4/1
iscsi4/1 is up
  Hardware is GigabitEthernet
  Port WWN is 20:cf:00:0c:85:90:3e:80
  Admin port mode is ISCSI
  Port mode is ISCSI
  Speed is 1 Gbps
  iSCSI initiator is identified by name
  Number of iSCSI session: 0 (discovery session: 0)
  Number of TCP connection: 0
  Configured TCP parameters
    Local Port is 3260
    PMTU discover is enabled, reset timeout is 3600 sec
    Keepalive-timeout is 60 sec
    Minimum-retransmit-time is 300 ms
    Max-retransmissions 4
    Sack is enabled
    QOS code point is 0
    Maximum allowed bandwidth is 1000000 kbps
    Minimum available bandwidth is 70000 kbps
    Estimated round trip time is 1000 usec
    Send buffer size is 4096 KB
    Congestion window monitoring is enabled, burst size is 50 KB
    Configured maximum jitter is 500 us
  Forwarding mode: store-and-forward
  TMF Queueing Mode : disabled
```

```

Proxy Initiator Mode : disabled
5 minutes input rate 0 bits/sec, 0 bytes/sec, 0 frames/sec
5 minutes output rate 0 bits/sec, 0 bytes/sec, 0 frames/sec
iSCSI statistics
  Input 0 packets, 0 bytes
    Command 0 pdus, Data-out 0 pdus, 0 bytes
  Output 0 packets, 0 bytes
    Response 0 pdus (with sense 0), R2T 0 pdus
    Data-in 0 pdus, 0 bytes

```

## Displaying iSCSI Statistics

Use the **show iscsi stats** command to view brief or detailed iSCSI statistics per iSCSI interface. See [Example 4-2](#) and [Example 4-3](#).

[Example 4-2](#) displays iSCSI throughput on an IPS port in both inbound and outbound directions. It also displays the number of different types of iSCSI PDU received and transmitted by this IPS port.

### Example 4-2 Displaying Brief iSCSI Statistics for an iSCSI Interface

```

switch# show iscsi stats iscsi 2/1
iscsi2/1
  5 minutes input rate 704 bits/sec, 88 bytes/sec, 1 frames/sec
  5 minutes output rate 704 bits/sec, 88 bytes/sec, 1 frames/sec
iSCSI statistics
  974756 packets input, 142671620 bytes
    Command 2352 pdus, Data-out 44198 pdus, 92364800 bytes, 0 fragments, unsolicited 0 bytes
  output 1022920 packets, 143446248 bytes
    Response 2352 pdus (with sense 266), R2T 1804 pdus
    Data-in 90453 pdus, 92458248 bytes

```

[Example 4-3](#) displays detailed iSCSI statistics for an IPS port. Along with the traffic rate and the number of each iSCSI PDU type, it shows the number of FCP frames received and forwarded, the number of iSCSI login attempts, successes, and failures. It also shows the number of different types of iSCSI PDUs sent and received that are noncritical or occur less frequently, such as NOP in and out (NOP-In and NOP-Out), text request and response (Text-REQ and Text-RESP), and task management request and response (TMF-REQ and TMF-RESP).

Various types of errors and PDU or frame drop occurrences are also counted and displayed. For example, Bad header digest shows the number of iSCSI PDUs received that have a header digest that fails CRC verification. The iSCSI Drop section shows the number of PDUs that were dropped because of reasons such as target down, LUN mapping fail, Data CRC error, or unexpected Immediate or Unsolicited data. These statistics are helpful for debugging purposes when the feature is not working as expected.

The last section, Buffer Stats, gives statistics on the internal IPS packet buffer operation. This section is for debugging purposes only.

### Example 4-3 Displaying Detailed iSCSI Statistics for the iSCSI Interface

```

switch# show iscsi stats iscsi 2/1 detail
iscsi2/1
  5 minutes input rate 704 bits/sec, 88 bytes/sec, 1 frames/sec
  5 minutes output rate 704 bits/sec, 88 bytes/sec, 1 frames/sec
iSCSI statistics
  974454 packets input, 142656516 bytes
    Command 2352 pdus, Data-out 44198 pdus, 92364800 bytes, 0 fragments, unsolicited 0 bytes
  output 1022618 packets, 143431144 bytes
    Response 2352 pdus (with sense 266), R2T 1804 pdus
    Data-in 90453 pdus, 92458248 bytes

```

```

iSCSI Forward:
  Command:2352 PDUs (Rcvd:2352)
  Data-Out (Write):16236 PDUs (Rcvd 44198), 0 fragments, 92364800 bytes, unsolicited 0 bytes
FCP Forward:
  Xfer_rdy:1804 (Rcvd:1804)
  Data-In:90453 (Rcvd:90463), 92458248 bytes
  Response:2352 (Rcvd:2362), with sense 266
  TMF Resp:0

iSCSI Stats:
  Login:attempt:13039, succeed:110, fail:12918, authen fail:0
  Rcvd:NOP-Out:914582, Sent:NOP-In:914582
    NOP-In:0, Sent:NOP-Out:0
    TMF-REQ:0, Sent:TMF-RESP:0
    Text-REQ:18, Sent:Text-RESP:27
    SNACK:0
    Unrecognized Opcode:0, Bad header digest:0
    Command in window but not next:0, exceed wait queue limit:0
    Received PDU in wrong phase:0
    SCSI Busy responses:0
  Immediate data failure::Separation:0
  Unsolicited data failure::Separation:0, Segment:0
    Add header:0
  Sequence ID allocation failure:0
FCP Stats:
  Total:Sent:47654
    Received:96625 (Error:0, Unknown:0)
  Sent:PLOGI:10, Rcvd:PLOGI_ACC:10, PLOGI_RJT:0
    PRLI:10, Rcvd:PRLI_ACC:10, PRLI_RJT:0, Error:0, From initiator:0
    LOGO:4, Rcvd:LOGO_ACC:0, LOGO_RJT:0
    PRLO:4, Rcvd:PRLO_ACC:0, PRLO_RJT:0
    ABTS:0, Rcvd:ABTS_ACC:0
    TMF REQ:0
    Self orig command:10, Rcvd:data:10, resp:10
  Rcvd:PLOGI:156, Sent:PLOGI_ACC:0, PLOGI_RJT:156
    LOGO:0, Sent:LOGO_ACC:0, LOGO_RJT:0
    PRLI:8, Sent:PRLI_ACC:8, PRLI_RJT:0
    PRLO:0, Sent:PRLO_ACC:0, PRLO_RJT:0
    ADISC:0, Sent:ADISC_ACC:0, ADISC_RJT:0
    ABTS:0

iSCSI Drop:
  Command:Target down 0, Task in progress 0, LUN map fail 0
    CmdSeqNo not in window 0, No Exchange ID 0, Reject 0
    No task:0
  Data-Out:0, Data CRC Error:0
  TMF-Req:0, No task:0
  Unsolicited data:0, Immediate command PDU:0
FCP Drop:
  Xfer_rdy:0, Data-In:0, Response:0

Buffer Stats:
  Buffer less than header size:0, Partial:45231, Split:322
  Pullup give new buf:0, Out of contiguous buf:0, Unaligned m_data:0

```

## Displaying Proxy Initiator Information

If the proxy initiator feature is enabled in the iSCSI interface, use the **show interface iscsi** command to display configured proxy initiator information (see [Example 4-4](#) and [Example 4-5](#)).

**Example 4-4 Displaying Proxy Initiator Information for the iSCSI Interface with System-Assigned WWNs**

```

switch# show interface iscsi 4/1
iscsi4/1 is up
  Hardware is GigabitEthernet
  Port WWN is 20:c1:00:05:30:00:a7:9e
  Admin port mode is ISCSI
  Port mode is ISCSI
  Speed is 1 Gbps
  iSCSI initiator is identified by name
  Number of iSCSI session: 0, Number of TCP connection: 0
  Configured TCP parameters
    Local Port is 3260
    PMTU discover is enabled, reset timeout is 3600 sec
    Keepalive-timeout is 60 sec
    Minimum-retransmit-time is 300 ms
    Max-retransmissions 4
    Sack is disabled
    QOS code point is 0
  Forwarding mode: pass-thru
  TMF Queueing Mode : disabled
  Proxy Initiator Mode : enabled<-----Proxy initiator is enabled
    nWWN is 28:00:00:05:30:00:a7:a1 (system-assigned)<----System-assigned nWWN
    pWWN is 28:01:00:05:30:00:a7:a1 (system-assigned)<---- System-assigned pWWN
  5 minutes input rate 0 bits/sec, 0 bytes/sec, 0 frames/sec
  5 minutes output rate 0 bits/sec, 0 bytes/sec, 0 frames/sec
  iSCSI statistics
    Input 7 packets, 2912 bytes
      Command 0 pdus, Data-out 0 pdus, 0 bytes
    Output 7 packets, 336 bytes
      Response 0 pdus (with sense 0), R2T 0 pdus
      Data-in 0 pdus, 0 bytes

```

**Example 4-5 Displaying Proxy Initiator Information for the iSCSI Interface with User-Assigned WWNs**

```

switch# show interface iscsi 4/2
iscsi4/2 is up
  Hardware is GigabitEthernet
  Port WWN is 20:c1:00:05:30:00:a7:9e
  Admin port mode is ISCSI
  Port mode is ISCSI
  Speed is 1 Gbps
  iSCSI initiator is identified by name
  Number of iSCSI session: 0, Number of TCP connection: 0
  Configured TCP parameters
    Local Port is 3260
    PMTU discover is enabled, reset timeout is 3600 sec
    Keepalive-timeout is 60 sec
    Minimum-retransmit-time is 300 ms
    Max-retransmissions 4
    Sack is disabled
    QOS code point is 0
  Forwarding mode: pass-thru
  TMF Queueing Mode : disabled
  Proxy Initiator Mode : enabled
    nWWN is 11:11:11:11:11:11:11:11 (manually-configured)<----User-assigned nWWN
    pWWN is 22:22:22:22:22:22:22:22 (manually-configured)<----User-assigned pWWN
  5 minutes input rate 0 bits/sec, 0 bytes/sec, 0 frames/sec
  5 minutes output rate 0 bits/sec, 0 bytes/sec, 0 frames/sec
  iSCSI statistics
    Input 7 packets, 2912 bytes
      Command 0 pdus, Data-out 0 pdus, 0 bytes

```

```
Output 7 packets, 336 bytes
Response 0 pdus (with sense 0), R2T 0 pdus
Data-in 0 pdus, 0 bytes
```

## Displaying Global iSCSI Information

Use the **show iscsi global** command to view the overall configuration and the iSCSI status. See [Example 4-6](#).

### Example 4-6 Displaying the Current Global iSCSI Configuration and State

```
switch# show iscsi global
iSCSI Global information
Authentication: CHAP, NONE
Import FC Target: Enabled
Initiator idle timeout: 300 seconds
Number of target node: 0
Number of portals: 11
Number of session: 0
Failed session: 0, Last failed initiator name:
```

## Displaying iSCSI Sessions

Use the **show iscsi session** command to view details about the current iSCSI sessions in the switch. Without parameters, this command displays all sessions. The output can be filtered by specifying an initiator, a target, or both.

[Example 4-7](#) displays one iSCSI initiator configured based on the IQN (iqn.1987-05.com.cisco:02.3021b0f2fda0.avanti12-w2k) and another based on its IPv4 address (10.10.100.199).

### Example 4-7 Displaying Brief Information of All iSCSI Sessions

```
switch# show iscsi session
Initiator iqn.1987-05.com.cisco:02.3021b0f2fda0.avanti12-w2k
Initiator ip addr (s): 10.10.100.116
Session #1
Discovery session, ISID 00023d000043, Status active

Session #2
Target VT1
VSAN 1, ISID 00023d000046, Status active, no reservation

Session #3
Target VT2
VSAN 1, ISID 00023d000048, Status active, no reservation

Initiator 10.10.100.199
Initiator name iqn.1987-05.com.cisco.01.7e3183ae458a94b1cd6bc168cba09d2e
Session #1
Target VT2
VSAN 1, ISID 246700000000, Status active, no reservation

Session #2
Target VT1
VSAN 1, ISID 246b00000000, Status active, no reservation

Session #3
Target iqn.1987-05.com.cisco:05.switch.04-01.2100002037a6be32
VSAN 1, ISID 246e00000000, Status active, no reservation
```

[Example 4-8](#) and [Example 4-9](#) display the iSCSI initiator configured based on its IPv4 address (10.10.100.199).

#### **Example 4-8** *Displaying Brief Information About the Specified iSCSI Session*

```
switch# show iscsi session initiator 10.10.100.199 target VT1
Initiator 10.10.100.199
  Initiator name iqn.1987-05.com.cisco.01.7e3183ae458a94b1cd6bc168cba09d2e
  Session #1
    Target VT1
    VSAN 1, ISID 246b00000000, Status active, no reservation
```

#### **Example 4-9** *Displaying Detailed Information About the Specified iSCSI Session*

```
switch# show iscsi session initiator 10.10.100.199 target VT1 detail
Initiator 10.10.100.199 (oasis-qa)
  Initiator name iqn.1987-05.com.cisco.01.7e3183ae458a94b1cd6bc168cba09d2e
  Session #1 (index 3)
    Target VT1
    VSAN 1, ISID 246b00000000, TSIH 384, Status active, no reservation
    Type Normal, ExpCmdSN 39, MaxCmdSN 54, Barrier 0
    MaxBurstSize 0, MaxConn 0, DataPDUInOrder No
    DataSeqInOrder No, InitialR2T Yes, ImmediateData No
    Registered LUN 0, Mapped LUN 0
    Stats:
      PDU: Command: 38, Response: 38
      Bytes: TX: 8712, RX: 0
    Number of connection: 1
    Connection #1
      Local IP address: 10.10.100.200, Peer IP address: 10.10.100.199
      CID 0, State: LOGGED_IN
      StatSN 62, ExpStatSN 0
      MaxRecvDSLength 1024, our_MaxRecvDSLength 1392
      CSG 3, NSG 3, min_pdu_size 48 (w/ data 48)
      AuthMethod none, HeaderDigest None (len 0), DataDigest None (len 0)
      Version Min: 2, Max: 2
      FC target: Up, Reorder PDU: No, Marker send: No (int 0)
      Received MaxRecvDSLen key: No
```

## Displaying iSCSI Initiators

Use the **show iscsi initiator** command to display information about all initiators connected to an iSCSI interface in the switch. The information can be filtered to display only the desired iSCSI initiator by specifying the initiator name. Detailed output of the iSCSI initiator can be obtained by specifying the **detail** option. The **iscsi-session** (and optionally **detail**) parameter displays only iSCSI session information. The **fc-session** (and optionally **detail**) parameter displays only FCP session information. The output includes static and dynamic initiators. See [Example 4-10](#) and [Example 4-11](#).

#### **Example 4-10** *Displaying Information About Connected iSCSI Initiators*

```
switch# show iscsi initiator
iSCSI Node name is iqn.1987-05.com.cisco:02.3021b0f2fda0.avanti12-w2k
  Initiator ip addr (s): 10.10.100.116
  iSCSI alias name: AVANTI12-W2K
  Node WWN is 22:01:00:05:30:00:10:e1 (configured)
  Member of vsans: 1, 2, 10
  Number of Virtual n_ports: 1
  Virtual Port WWN is 22:04:00:05:30:00:10:e1 (configured)
```

```

Interface iSCSI 4/1, Portal group tag: 0x180
VSAN ID 1, FCID 0x6c0202
VSAN ID 2, FCID 0x6e0000
VSAN ID 10, FCID 0x790000

```

```

iSCSI Node name is 10.10.100.199
iSCSI Initiator name: iqn.1987-05.com.cisco.01.7e3183ae458a94b1cd6bc168cba09d2e
iSCSI alias name: oasis-qa
Node WWN is 22:03:00:05:30:00:10:e1 (configured)
Member of vsans: 1, 5
Number of Virtual n_ports: 1
Virtual Port WWN is 22:00:00:05:30:00:10:e1 (configured)
Interface iSCSI 4/1, Portal group tag: 0x180
VSAN ID 5, FCID 0x640000
VSAN ID 1, FCID 0x6c0203

```

#### Example 4-11 Displaying Detailed Information About the iSCSI Initiator

```

switch# show iscsi initiator iqn.1987-05.com.cisco:02.3021b0f2fda0.avanti12-w2k detail
iSCSI Node name is iqn.1987-05.com.cisco:02.3021b0f2fda0.avanti12-w2k
Initiator ip addr (s): 10.10.100.116
iSCSI alias name: AVANTI12-W2K
Node WWN is 22:01:00:05:30:00:10:e1 (configured)
Member of vsans: 1, 2, 10
Number of Virtual n_ports: 1

Virtual Port WWN is 22:04:00:05:30:00:10:e1 (configured)
Interface iSCSI 4/1, Portal group tag is 0x180
VSAN ID 1, FCID 0x6c0202
1 FC sessions, 1 iSCSI sessions
iSCSI session details <-----iSCSI session details
Target: VT1
Statistics:
PDU: Command: 0, Response: 0
Bytes: TX: 0, RX: 0
Number of connection: 1
TCP parameters
Local 10.10.100.200:3260, Remote 10.10.100.116:4190
Path MTU: 1500 bytes
Retransmission timeout: 310 ms
Round trip time: Smoothed 160 ms, Variance: 38
Advertized window: Current: 61 KB, Maximum: 62 KB, Scale: 0
Peer receive window: Current: 63 KB, Maximum: 63 KB, Scale: 0
Congestion window: Current: 1 KB

FCP Session details <-----FCP session details
Target FCID: 0x6c01e8 (S_ID of this session: 0x6c0202)
pWWN: 21:00:00:20:37:62:c0:0c, nWWN: 20:00:00:20:37:62:c0:0c
Session state: CLEANUP
1 iSCSI sessions share this FC session
Target: VT1
Negotiated parameters
RcvDataFieldSize 1392 our_RcvDataFieldSize 1392
MaxBurstSize 0, EMPD: FALSE
Random Relative Offset: FALSE, Sequence-in-order: Yes
Statistics:
PDU: Command: 0, Response: 0

```

Use the **show fcns database** (and optionally **detail**) to display the Fibre Channel name server entry for the Fibre Channel N port created for iSCSI initiators in the SAN. See [Example 4-12](#) and [Example 4-13](#).

**Example 4-12 Displaying the FCNS Database Contents**

```

switch# show fcns database
VSAN 1:
-----
FCID          TYPE  PWWN                               (VENDOR)          FC4-TYPE:FEATURE
-----
0x020101      N     22:04:00:05:30:00:35:e1 (Cisco)           scsi-fcp:init isc..w <---iSCSI
0x020102      N     22:02:00:05:30:00:35:e1 (Cisco)           scsi-fcp:init isc..w initiator
0x0205d4      NL    21:00:00:04:cf:da:fe:c6 (Seagate)          scsi-fcp:target
0x0205d5      NL    21:00:00:04:cf:e6:e4:4b (Seagate)          scsi-fcp:target
...
Total number of entries = 10

VSAN 2:
-----
FCID          TYPE  PWWN                               (VENDOR)          FC4-TYPE:FEATURE
-----
0xef0001      N     22:02:00:05:30:00:35:e1 (Cisco)           scsi-fcp:init isc..w
Total number of entries = 1

VSAN 3:
-----
FCID          TYPE  PWWN                               (VENDOR)          FC4-TYPE:FEATURE
-----
0xed0001      N     22:02:00:05:30:00:35:e1 (Cisco)           scsi-fcp:init isc..w
Total number of entries = 1

```

**Example 4-13 Displaying the FCNS Database in Detail**

```

switch# show fcns database detail
-----
VSAN:1      FCID:0x020101
-----
port-wwn (vendor)      :22:04:00:05:30:00:35:e1 (Cisco)
node-wwn               :22:03:00:05:30:00:35:e1
class                  :2,3
node-ip-addr           :10.2.2.12                <--- iSCSI initiator's IPv4 address
ipa                    :ff ff ff ff ff ff ff ff
fc4-types:fc4_features:scsi-fcp:init iscsi-gw
symbolic-port-name     :
symbolic-node-name     :iqn.1991-05.com.microsoft:oasis2-dell <--- iSCSI initiator's IQN
port-type              :N
port-ip-addr           :0.0.0.0
fabric-port-wwn       :22:01:00:05:30:00:35:de
hard-addr              :0x000000
-----
VSAN:1      FCID:0x020102
-----
port-wwn (vendor)      :22:02:00:05:30:00:35:e1 (Cisco)
node-wwn               :22:01:00:05:30:00:35:e1
class                  :2,3
node-ip-addr           :10.2.2.11
ipa                    :ff ff ff ff ff ff ff ff
fc4-types:fc4_features:scsi-fcp:init iscsi-gw
symbolic-port-name     :
symbolic-node-name     :iqn.1987-05.com.cisco.01.14ac33ba567f986f174723b5f9f2377
port-type              :N
port-ip-addr           :0.0.0.0
fabric-port-wwn       :22:01:00:05:30:00:35:de
hard-addr              :0x000000
...

```

```

Total number of entries = 10
=====
-----
VSAN:2      FCID:0xef0001
-----
port-wwn (vendor)      :22:02:00:05:30:00:35:e1 (Cisco)
node-wwn               :22:01:00:05:30:00:35:e1
class                 :2,3
node-ip-addr           :10.2.2.11
ipa                   :ff ff ff ff ff ff ff ff
fc4-types:fc4_features:scsi-fcp:init iscsi-gw
symbolic-port-name     :
symbolic-node-name     :iqn.1987-05.com.cisco.01.14ac33ba567f986f174723b5f9f2377
port-type              :N
port-ip-addr           :0.0.0.0
fabric-port-wwn        :22:01:00:05:30:00:35:de
hard-addr              :0x000000
Total number of entries = 1
...

```

Use the **show iscsi initiator configured** to display information about all the configured iSCSI initiators. Specifying the name shows information about the desired initiator. See [Example 4-14](#).

#### Example 4-14 Displaying Information About Configured Initiators

```

switch# show iscsi initiator configured
iSCSI Node name is iqn.1987-05.com.cisco:02.3021b0f2fda0.avanti12-w2k
  Member of vsans: 1, 2, 10
  Node WWN is 22:01:00:05:30:00:10:e1
  No. of PWWN: 5
    Port WWN is 22:04:00:05:30:00:10:e1
    Port WWN is 22:05:00:05:30:00:10:e1
    Port WWN is 22:06:00:05:30:00:10:e1
    Port WWN is 22:07:00:05:30:00:10:e1
    Port WWN is 22:08:00:05:30:00:10:e1

iSCSI Node name is 10.10.100.199
  Member of vsans: 1, 5
  Node WWN is 22:03:00:05:30:00:10:e1
  No. of PWWN: 4
    Port WWN is 22:00:00:05:30:00:10:e1
    Port WWN is 22:09:00:05:30:00:10:e1
    Port WWN is 22:0a:00:05:30:00:10:e1
    Port WWN is 22:0b:00:05:30:00:10:e1

  User Name for Mutual CHAP: testuser

```

## Displaying iSCSI Virtual Targets

Use the **show iscsi virtual-target** to display information about the Fibre Channel targets exported as iSCSI virtual targets to the iSCSI initiators. The output includes static as well as dynamic targets. See [Example 4-15](#).

#### Example 4-15 Displaying Exported Targets

```

switch# show iscsi virtual-target
target: VT1
  * Port WWN 21:00:00:20:37:62:c0:0c
  Configured node
  all initiator permit is enabled

```

```
target: VT2
  Port WWN 21:00:00:04:cf:4c:52:c1
  Configured node
  all initiator permit is disabled
target: iqn.1987-05.com.cisco:05.switch.04-01.2100002037a6be32
  Port WWN 21:00:00:20:37:a6:be:32 , VSAN 1
  Auto-created node
```

## Displaying iSCSI User Information

The `show user-account iscsi` command displays all configured iSCSI user names. See [Example 4-16](#).

### Example 4-16 Displaying iSCSI User Names

```
switch# show user-account iscsi
username:iscsiuser
secret: dsfffsffsffasffsdfg

username:user2
secret:cshadhdsadadjajdjas
```

## Configuring iSLB

The iSCSI server load balancing (iSLB) feature provides a means to easily configure large scale iSCSI deployments containing hundreds or even thousands of initiators. iSLB provides the following features:

- The iSLB initiator configuration is simplified with support for initiator targets and auto-zones.
- Cisco Fabric Services (CFS) eliminates the need for manual configuration by distributing the iSLB initiator configuration among all MDS switches in the fabric.
- Dynamic load balancing of iSLB initiators is available using iSCSI login redirect and VRRP.

When not using iSLB, configuring iSCSI requires the following:

- You need to perform multiple configuration steps on the MDS switch, including the following:
  - Initiator configuration using static pWWN and VSAN.
  - Zoning configuration for initiators and targets.
  - Optional create virtual target and give access to the initiator.
  - Configuration of target LUN mapping and masking on the storage system for the initiator based on the static pWWN created for the initiator on the MDS switch.
- You need to duplicate the configuration manually on multiple MDS switches.
- There is no load balancing for IPS ports. For example:
  - The Virtual Router Redundancy Protocol (VRRP) only supports active and backup, not load balancing.
  - You must use multiple VRRP groups and configure hosts in different groups.

iSLB provides the following features:

- The iSLB initiator configuration is simplified with support for initiator targets and auto-zones.
- Cisco Fabric Services (CFS) eliminates the need for manual configuration by distributing the iSLB initiator configuration among all MDS switches in the fabric.



---

**Note** Only statically mapped iSLB initiator configuration is distributed throughout the fabric using CFS. Dynamically and statically mapped iSCSI initiator configurations are not distributed.

---

- Dynamic load balancing of iSLB initiators is available using iSCSI login redirect and VRRP.

This section covers the following topics:

- [iSCSI Configuration Limits, page 4-98](#)
- [iSLB Configuration Prerequisites, page 4-149](#)
- [iSLB Initiators, page 4-149](#)
- [Configuring iSLB Using Device Manager, page 4-149](#)
- [Configuring iSLB Initiators, page 4-151](#)
- [Load Balancing Using VRRP, page 4-161](#)
- [Configuring Load Balancing Using VRRP, page 4-166](#)
- [iSLB Configuration Distribution Using CFS, page 4-167](#)
- [Distributing iSLB Configuration Using CFS, page 4-168](#)



---

**Note** Before configuring iSLB, you must enable iSCSI (see the “[Enabling iSCSI](#)” section on page 4-98).

---



---

**Note** For iSLB, all switches in the fabric must be running Cisco MDS SAN-OS Release 2.1(1a) or later.

---

## iSLB Configuration Limits

iSLB configuration has the following limits:

- The maximum number of iSLB and iSCSI initiators supported in a fabric is 2000.
- The maximum number of iSLB and iSCSI sessions supported by an IPS port in either transparent or proxy initiator mode is 500.
- The maximum number of iSLB initiators supported in a fabric is 2000.
- The maximum number of iSLB initiators and iSCSI sessions supported by a switch is 5000.
- The maximum number of iSLB sessions per IPS port in either transparent or proxy initiator mode is 500.
- The maximum number of iSLB and iSCSI targets supported in a fabric is 6000.
- The maximum number of switches in a fabric that can have iSLB with CFS distribution enabled is four.
- No more than 200 new iSLB initiators can be added to the pending configuration. Before adding more initiators, you must commit the configuration.
- You cannot disable iSCSI if you have more than 200 iSLB initiators in the running configuration. Reduce the number of iSLB initiators to fewer than 200 before disabling iSCSI.
- iSLB can be used without CFS distribution but if iSLB auto-zone feature is used, traffic is disrupted when any zoneset is activated.
- If IVR and iSLB features are enabled in the same fabric, you should have at least one switch in the fabric where both these features are enabled. Any zoning-related configuration and activation (for normal zones, IVR zones, or iSLB zones) must be performed on this switch. Otherwise, there may be traffic disruption in the fabric.

## iSLB Configuration Prerequisites

Perform the following prerequisite actions prior to configuring iSLB:

- Enable iSCSI (see the “[Enabling iSCSI](#)” section on page 4-98 for more information).
- Configure the Gigabit Ethernet interfaces (see the “[Basic Gigabit Ethernet Configuration for IPv4](#)” section on page 7-276).
- Configure the VRRP groups (see the “[Configuring Load Balancing Using VRRP](#)” section on page 4-166).
- Configure and activate a zone set (see the *Cisco Fabric Manager Fabric Configuration Guide* and *Cisco MDS 9000 Family NX-OS Fabric Configuration Guide* for more information).
- Enable CFS distribution for iSLB (see the “[Enabling iSLB Configuration Distribution](#)” section on page 4-169).

## iSLB Initiators

iSLB initiators provide the following features in addition to those supported by iSCSI initiators:

- An iSLB initiator also supports iSLB virtual targets.
- Initiator targets—These targets are configured for a particular initiator.
- Load balancing using iSCSI login redirect and VRRP—If iSCSI login redirect is enabled, the IPS Manager redirects incoming sessions to the best interface based on the calculated load for each interface.
- Configuration distribution to other switches using CFS.

iSLB initiators provide the following features in addition to those supported by iSCSI initiators:

- An iSLB initiator also supports iSLB virtual targets. These targets are very similar to iSCSI virtual targets with the exception that they do not include the advertise interface option and as a result are distributable using CFS.
- Initiator targets—These targets are configured for a particular initiator.
- Load balancing using iSCSI login redirect and VRRP—If load balancing is enabled, the IPS Manager redirects incoming sessions to the best interface based on the calculated load for each interface.
- Configuration distribution to other switches using CFS.

## Configuring iSLB Using Device Manager

To configure iSLB using Device Manager, follow these steps:

**Step 1** Choose **IP > iSCSI iSLB**.

You see the iSCSI iSLB dialog box (see [Figure 4-32](#)).

**Figure 4-32** iSCSI iSLB Dialog Box

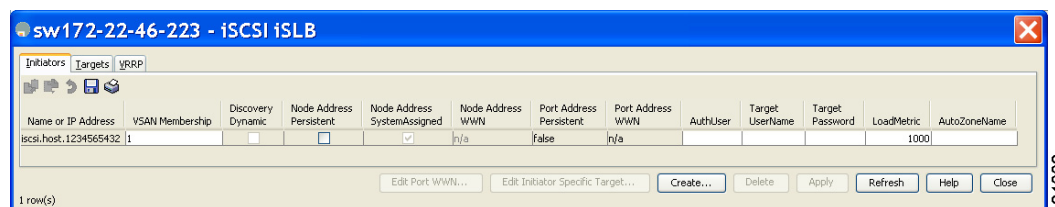

**Step 2** Click **Create** to create a new iSCSI iSLB initiator.

You see the Create iSCSI iSLB Initiators dialog box (see [Figure 4-33](#)).

Figure 4-33 Create iSCSI iSLB Initiators Dialog Box

**Step 3** Set the Name or IP Address field to the iSLB name or IP address.

**Step 4** Set the VSAN Membership field to the VSAN that you want the iSLB initiator in.

Also see the [“Assigning VSAN Membership for iSLB Initiators”](#) section on page 4-154.

**Step 5** Check the **Persistent** check box to convert a dynamic nWWN to static for the iSLB initiator.

Also see the [“Making the Dynamic iSLB Initiator WWN Mapping Static”](#) section on page 4-153.

**Step 6** (Optional) Check the **SystemAssigned** check box to have the switch assign the nWWN.

**Step 7** (Optional) Set the Static WWN field to manually assign the static nWWN. You must ensure uniqueness for this nWWN.

**Step 8** (Optional) Check the Port WWN Mapping **Persistent** check box to convert dynamic pWWNs to static for the iSLB initiator.

See the [“Making the Dynamic iSLB Initiator WWN Mapping Static”](#) section on page 4-153.

**Step 9** (Optional) Check the **SystemAssigned** check box and set the number of pWWNs you want to have the switch assign the PWWN.

**Step 10** (Optional) Set the Static WWN(s) field to manually assign the static pWWNs.

You must ensure uniqueness for these pWWN.

**Step 11** (Optional) Set the AuthUser field to the username that you want to restrict the iSLB initiator to for iSLB authentication.

Also see the [“Restricting iSLB Initiator Authentication”](#) section on page 4-160.

**Step 12** Fill in the Username and Password fields to configure iSLB initiator target CHAP authentication.

Also see the [“Configuring iSLB Session Authentication”](#) section on page 4-160.

**Step 13** In the Initiator Specific Target section, set the pWWN to configure an iSLB initiator target.

**Step 14** (Optional) Set the Name field to a globally unique identifier (IQN).

**Step 15** (Optional) Check the **NoAutoZoneCreation** check box to disable auto-zoning.

**Step 16** (Optional) Check the **TresspassMode** check box.

Also see the [“LUN Trespass for Storage Port Failover”](#) section on page 4-177.

**Step 17** (Optional) Check the **RevertToPrimary** check box to revert back to the primary port after an HA failover when the primary port comes back up.

**Step 18** Set the PrimaryVsan to the VSAN for the iSLB initiator target.

**Step 19** Click **Create** to create this iSLB initiator.

**Step 20** If CFS is enabled, select **commit** from the CFS drop-down menu.

## Configuring iSLB Initiators

This section includes the following topics:

- [Configuring iSLB Initiator Names or IP Addresses](#), page 4-151
- [Assigning WWNs to iSLB Initiators](#), page 4-152
- [Making the Dynamic iSLB Initiator WWN Mapping Static](#), page 4-153
- [Assigning VSAN Membership for iSLB Initiators](#), page 4-154
- [Configuring Metrics for Load Balancing](#), page 4-155
- [Verifying iSLB Initiator Configuration](#), page 4-156
- [Verifying iSLB Authentication Configuration](#), page 4-161
- [Configuring Load Balancing Using VRRP](#), page 4-166
- [Configuring iSLB Session Authentication](#), page 4-160
- [Verifying iSLB Authentication Configuration](#), page 4-161

### Configuring iSLB Initiator Names or IP Addresses

You must specify the iSLB initiator name or IP address before configuring it.



**Note**

Specifying the iSLB initiator name or IP address is the same as for an iSCSI initiator. See the [“Static Mapping”](#) section on page 4-114.

To enter iSLB initiator configuration submode using the **name** option for an iSLB initiator, follow these steps:

	Command	Purpose
<b>Step 1</b>	switch# <b>config terminal</b> switch(config)#	Enters configuration mode.
<b>Step 2</b>	switch(config)# <b>islb initiator name</b> <b>iqn.1987-02.com.cisco.initiator</b> switch(config-islb-init)#	Configures an iSLB initiator using the iSCSI name of the initiator node (iqn.1987-02.com.cisco.initiator) and enters iSLB initiator configuration submode. The maximum name length is 223 alphanumeric characters. The minimum length is 16.
	switch(config)# <b>no islb initiator name</b> <b>iqn.1987-02.com.cisco.initiator</b>	Deletes the configured iSLB initiator.

To enter iSLB initiator configuration submode using the **ip-address** option for an iSLB initiator, follow these steps:

	Command	Purpose
<b>Step 1</b>	switch# <b>config terminal</b> switch(config)#	Enters configuration mode.
<b>Step 2</b>	switch(config)# <b>islb initiator</b> <b>ip-address 10.1.1.3</b> switch(config-islb-init)#	Configures an iSLB initiator using the IPv4 address of the initiator node and enters iSLB initiator configuration submode.
	switch(config)# <b>no islb initiator</b> <b>ip-address 10.1.1.3</b>	Deletes the configured iSLB initiator.
	switch(config)# <b>islb initiator</b> <b>ip-address 2001:0DB8:800:200C::417A</b> switch(config-islb-init)#	Configures an iSLB initiator using the IPv6 unicast address of the initiator node and enters iSLB initiator configuration submode.
	switch(config)# <b>no islb initiator</b> <b>ip-address 2001:0DB8:800:200C::417A</b>	Deletes the configured iSLB initiator.

### Assigning WWNs to iSLB Initiators

An iSLB host is mapped to an N port's WWNs by one of the following mechanisms:

- Dynamic mapping (default)
- Static mapping



#### Note

Assigning WWNs for iSLB initiators is the same as for iSCSI initiators. For information on dynamic and static mapping, see the [“WWN Assignment for iSCSI Initiators”](#) section on page 4-113.



#### Tip

We recommend using the **SystemAssign system-assign** option. If you manually assign a WWN, you must ensure its uniqueness (see the *Cisco Fabric Manager Fabric Configuration Guide* and *Cisco MDS 9000 Family NX-OS Fabric Configuration Guide* for more information). You should not use any previously assigned WWNs.

See the [“Configuring iSLB Using Device Manager”](#) procedure on page 4-149.

## Making the Dynamic iSLB Initiator WWN Mapping Static

After a dynamic iSLB initiator has logged in, you may decide to permanently keep the automatically assigned nWWN/pWWN mapping to allow this initiator to use the same mapping the next time it logs in (see the “[Dynamic Mapping](#)” section on page 4-104).

You can convert a dynamic iSLB initiator to a static iSLB initiator and make its WWNs persistent



**Note** You cannot convert a dynamic iSCSI initiator to a static iSLB initiator or a dynamic iSLB initiator to a static iSCSI initiator (see the “[Dynamic Mapping](#)” section on page 4-20).



**Note** Making the dynamic mapping for iSLB initiators static is the same as for iSCSI. See the “[Making the Dynamic iSLB Initiator WWN Mapping Static](#)” section on page 4-153 “[Making the Dynamic iSCSI Initiator WWN Mapping Static](#)” section on page 4-116.



**Note** Only statically mapped iSLB initiator configuration is distributed throughout the fabric using CFS. Dynamically and statically configured iSCSI initiator configurations are not distributed.

See the “[Configuring iSLB Using Device Manager](#)” procedure on page 4-149.

To permanently keep the automatically assigned nWWN/pWWN mapping, follow these steps:

	Command	Purpose
<b>Step 1</b>	switch# <b>config terminal</b> switch(config)#	Enters configuration mode.
<b>Step 2</b>	switch(config)# <b>islb save-initiator</b> <b>name iqn.1987-02.com.cisco.initiator</b>	Saves the nWWNs and pWWNs that have automatically been assigned to the iSLB initiator whose name is specified.
	switch(config)# <b>islb save-initiator</b> <b>10.10.100.11</b>	Saves the nWWNs and pWWNs that have automatically been assigned to the iSLB initiator whose IPv4 address is specified.
	switch(config)# <b>iscsi save-initiator</b> <b>ip-address 2001:0DB8:800:200C::417A</b>	Saves the nWWNs and pWWNs that have automatically been assigned to the iSCSI initiator whose IPv6 unicast address is specified.
	switch(config)# <b>islb save-initiator</b>	Saves the nWWNs and pWWNs that have automatically been assigned to all the iSLB initiators.
<b>Step 3</b>	switch(config)# <b>exit</b> switch#	Returns to EXEC mode.
<b>Step 4</b>	switch# <b>copy running-config</b> <b>startup-config</b>	Saves the nWWN/pWWN mapping configuration across system reboots.

## Configuring iSLB Target Access Mapping

In iSLB, all fabric distributed configurations including iSCSI virtual target access are part of the iSCSI initiator configuration. Access is granted using the pWWN or the device alias. You can specify the one or more of the following optional parameters:

- Secondary pWWN
- Secondary device alias

- LUN mapping
- IQN

In addition, you can disable auto zoning.

If you configure an IQN for an initiator target then that name is used to identify the target. Otherwise, an unique IQN is generated for the initiator target.

To configure iSLB initiator access to an iSCSI virtual target, follow these steps:

	Command	Purpose
<b>Step 1</b>	switch# <b>config terminal</b>	Enters configuration mode.
<b>Step 2</b>	switch(config)# <b>islb initiator ip-address 10.1.1.3</b> switch(config-iscsi-islb-init)#	Configures the initiator using a name and enters iSLB initiator configuration submenu.
<b>Step 3</b>	switch(config-iscsi-islb-init)# <b>target pwwn 26:00:01:02:03:04:05:06</b>	Grants iSLB initiator access to the target using a pWWN with auto zoning enabled (default).
	switch(config-iscsi-islb-init)# <b>target pwwn 26:00:01:02:03:04:05:06 no-zone</b>	Grants iSLB initiator access to the target using a pWWN with auto zoning disabled.
	switch(config-iscsi-islb-init)# <b>target device-alias SampleAlias</b>	Grants iSLB initiator access to the target using a device alias with auto zoning enabled (default).
	switch(config-iscsi-islb-init)# <b>target device-alias SampleAlias fc-lun 0x1234 iscsi-lun 0x2345</b>	Grants iSLB initiator access to the target using a devices alias and optional LUN mapping.
	switch(config-iscsi-islb-init)# <b>target device-alias SampleAlias iqn-name iqn.1987-01.com.cisco.initiator</b>	Grants iSLB initiator access to the target using a devices alias and an optional IQN.
	switch(config-iscsi-islb-init)# <b>target device-alias SampleAlias sec-device-alias SecondaryAlias</b>	Grants iSLB initiator access to the target using a devices alias and an optional secondary device alias.
	switch(config-iscsi-islb-init)# <b>target device-alias SampleAlias sec-pwwn 26:01:02:03:04:05:06:07</b>	Grants iSLB initiator access to the target using a devices alias and an optional secondary pWWN.
	switch(config-iscsi-init)# <b>no target pwwn 26:00:01:02:03:04:05:06</b>	Removes the target access.

To verify the iSLB target configuration, use the **show islb initiator configured** command.

```
switch# show islb initiator configured
iSCSI Node name is 10.1.1.3

Number of Initiator Targets: 1

Initiator Target: iqn.1987-05.com.cisco:05.ips-hac4
Port WWN 50:06:04:82:ca:e1:26:8d
Zoning Enabled
No. of LU mapping: 3
  iSCSI LUN: 0x0001, FC LUN: 0x0001
  iSCSI LUN: 0x0002, FC LUN: 0x0002
  iSCSI LUN: 0x0003, FC LUN: 0x0003
```

### Assigning VSAN Membership for iSLB Initiators

Individual iSLB hosts can be configured to be in a specific VSAN (similar to the DPVM feature for Fibre Channel). The specified VSAN overrides the iSCSI interface VSAN membership.

For more information, see the *Cisco MDS 9000 Family NX-OS Fabric Manager Fabric Configuration Guide*.



**Note** Specifying the iSLB initiator VSAN is the same as for an iSCSI initiator. See the [VSAN Membership for iSCSI, page 4-120](#).

To assign VSAN membership for iSLB initiators, follow these steps:

	Command	Purpose
<b>Step 1</b>	switch# <b>config terminal</b> switch(config)#	Enters configuration mode.
<b>Step 2</b>	switch(config)# <b>islb initiator ip-address 10.1.1.3</b> switch(config-islb-init)#	Configures an iSLB initiator using its IPv4 address and enters iSLB initiator configuration submode.
<b>Step 3</b>	switch(config-islb-init)# <b>vsan 3</b>	Assigns the iSLB initiator node to a specified VSAN. <b>Note</b> You can assign this host to one or more VSANs.
	switch(config-islb-init)# <b>no vsan 3</b>	Removes the iSLB initiator from the specified VSAN.



**Note** When an iSLB initiator is configured in any other VSAN (other than VSAN 1, the default VSAN), for example VSAN 2, the initiator is automatically removed from VSAN 1. If you also want it to be present in VSAN 1, you must explicitly configure the initiator in VSAN 1.

See the [“Configuring iSLB Using Device Manager” procedure on page 4-149](#).

## Configuring Metrics for Load Balancing

You can assign a load metric to each initiator for weighted load balancing. The load calculated is based on the number of initiators on a given iSCSI interface. This feature accommodates initiators with different bandwidth requirements. For example, you could assign a higher load metric to a database server than to a web server. Weighted load balancing also accommodates initiators with different link speeds.

Also, you can configure initiator targets using the device alias or the pWWN. If you configure an IQN for an initiator target, then that name is used to identify the initiator target. Otherwise, a unique IQN is generated for the initiator target.

For more information on load balancing, see the [“Load Balancing Using VRRP” section on page 4-161](#).

Choose **IP > iSCSI iSLB** in Device Manager and set the LoadMetric field to change the load balancing metric for an iSLB initiator.

See the [“Configuring iSLB Using Device Manager” procedure on page 4-149](#).

To configure a weight for load balancing, follow these steps:

	Command	Purpose
<b>Step 1</b>	switch# <b>config terminal</b> switch(config)#	Enters configuration mode.
<b>Step 2</b>	switch(config)# <b>islb initiator name iqn.1987-02.com.cisco.initiator</b> switch(config-iscsi-init)#	Configures an iSLB initiator using the name of the initiator node and enters iSLB initiator configuration mode.

	Command	Purpose
Step 3	switch(config-iscsi-init)# <b>metric 100</b>	Assigns 100 as the weight metric for this iSLB initiator.
Step 4	switch(config-iscsi-init)# <b>no metric 100</b>	Reverts to the default value (1000).

## Verifying iSLB Initiator Configuration

To verify the iSLB initiator configuration, use the **show islb initiator configured** command.

```
switch# show islb initiator configured
iSCSI Node name is 10.1.1.2
Member of vsans: 10
Node WWN is 23:02:00:0c:85:90:3e:82
Load Balance Metric: 100
Number of Initiator Targets: 1

Initiator Target: test-target
Port WWN 01:01:01:01:02:02:02:02
Primary PWWN VSAN 1
Zoning support is enabled
Trespass support is disabled
Revert to primary support is disabled
```

## Configuring iSLB Initiator Targets

You can configure initiator targets using the device alias or the pWWN. You can also optionally specify one or more of the following optional parameters:

- Secondary pWWN
- Secondary device alias
- LUN mapping
- IQN
- VSAN identifier



**Note** The VSAN identifier is optional if the target is online. If the target is not online, the VSAN identifier is required.

In addition, you can disable auto-zoning.

If you configure an IQN for an initiator target, then that name is used to identify the initiator target. Otherwise, a unique IQN is generated for the initiator target.

To configure iSLB initiator targets, follow these steps:

	Command	Purpose
Step 1	switch# <b>config terminal</b> switch(config)#	Enters configuration mode.
Step 2	switch(config)# <b>islb initiator ip-address 10.1.1.3</b> switch(config-islb-init)#	Configures an iSLB initiator using its IPv4 address and enters iSLB initiator configuration submode.

	Command	Purpose
<b>Step 3</b>	<code>switch(config-iscsi-islb-init)# target pwwn 26:00:01:02:03:04:05:06</code>	Configures the iSLB initiator target using a pWWN with auto-zoning enabled (default).
	<code>switch(config-iscsi-islb-init)# target pwwn 26:00:01:02:03:04:05:06 no-zone</code>	Configures the iSLB initiator target using a pWWN with auto-zoning disabled.
	<code>switch(config-iscsi-islb-init)# target device-alias SampleAlias</code>	Configures the iSLB initiator target using a device alias with auto-zoning enabled (default).
	<code>switch(config-iscsi-islb-init)# target device-alias SampleAlias fc-lun 0x1234 iscsi-lun 0x2345</code>	Configures the iSLB initiator target using a device alias and optional LUN mapping. <b>Note</b> The CLI interprets the LUN identifier value as a hexadecimal value whether or not the <b>0x</b> prefix is included.
	<code>switch(config-iscsi-islb-init)# target device-alias SampleAlias iqn-name iqn.1987-01.com.cisco.initiator</code>	Configures the iSLB initiator target using a device alias and an optional IQN.
	<code>switch(config-iscsi-islb-init)# target device-alias SampleAlias sec-device-alias SecondaryAlias</code>	Configures the iSLB initiator target using a device alias and an optional secondary device alias.
	<code>switch(config-iscsi-islb-init)# target device-alias SampleAlias sec-pwwn 26:01:02:03:04:05:06:07</code>	Configures the iSLB initiator target using a device alias and an optional secondary pWWN.
	<code>switch(config-iscsi-islb-init)# target device-alias SampleAlias vsan 10</code>	Configures the iSLB initiator target using a device alias and the VSAN identifier. <b>Note</b> The VSAN identifier is optional is if the target is online. If the target is not online, the VSAN identifier is required.
	<code>switch(config-iscsi-init)# no target pwwn 26:00:01:02:03:04:05:06</code>	Removes the iSLB initiator target.

To configure additional iSLB initiator targets using Device Manager, follow these steps:

**Step 1** Choose **IP > iSCSI iSLB**.

You see the iSCSI iSLB dialog box (see [Figure 4-32](#)).

**Step 2** Click on the initiator you want to add targets to and click **Edit Initiator Specific Targets**.

You see the Initiator Specific Target dialog box.

**Step 3** Click **Create** to create a new initiator target.

You see the Create Initiator Specific Target dialog box (see [Figure 4-34](#)).

Figure 4-34 Create Initiator Specific Target Dialog Box

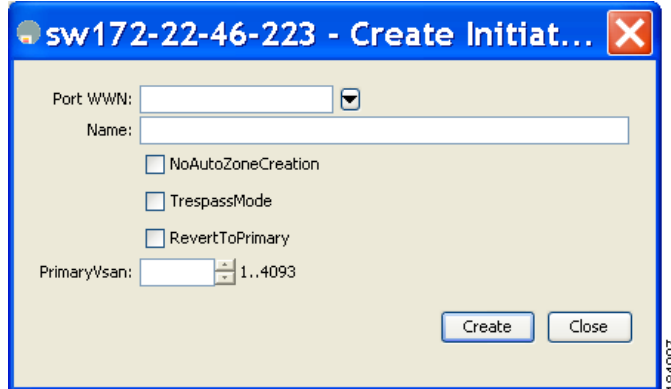

- Step 4** Fill in the pWWN field with the initiator target pWWN.
- Step 5** (Optional) Set the Name field to a globally unique identifier (IQN).
- Step 6** (Optional) Check the **NoAutoZoneCreation** check box to disable auto-zoning (see [Figure 4-33](#)).
- Step 7** (Optional) Check the **TrespassMode** check box. See the “[LUN Trespass for Storage Port Failover](#)” section on page 4-177.
- Step 8** (Optional) Check the **RevertToPrimary** check box to revert back to the primary port after an HA failover when the primary port comes back up.
- Step 9** Set the PrimaryVsan to the VSAN for the iSLB initiator target.
- Step 10** Click **Create** to create this iSLB initiator target.
- Step 11** If CFS is enabled, select **commit** from the CFS drop-down menu.

## Configuring and Activating Zones for iSLB Initiators and Initiator Targets

You can configure a zone name where the iSLB initiators and initiator targets are added. If you do not specify a zone name, the IPS manager creates one dynamically. iSLB zone sets have the following considerations:

- Auto-zoning of the initiator with the initiator targets is enabled by default.
- A zone set must be active in a VSAN for auto-zones to be created in that VSAN.
- iSLB zone set activation might fail if another zone set activation is in process or if the zoning database is locked. Retry the iSLB zone set activation if a failure occurs. To avoid this problem, only perform only one zoning related operation (normal zones, IVR zones, or iSLB zones) at a time.
- Auto-zones are created when the zone set is activated and there has been at least one change in the zoneset. The activation has no effect if only the auto-zones have changed.



### Caution

If IVR and iSLB are enabled in the same fabric, at least one switch in the fabric must have both features enabled. Any zoning related configuration or activation operation (for normal zones, IVR zones, or iSLB zones) must be performed on this switch. Otherwise, traffic might be disrupted in the fabric.

To configure the iSLB initiator optional auto-zone name and activate the zone set, follow these steps:

	Command	Purpose
Step 1	switch# <b>config terminal</b>	Enters configuration mode.
Step 2	switch(config)# <b>islb initiator ip-address 10.1.1.3</b> switch(config-islb-init)#	Configures an iSLB initiator using its IPv4 address and enters iSLB initiator configuration submode.
Step 3	switch(config-islb-init)# <b>zonename IslbZone</b>	Specifies the zone name where the initiators and the initiator targets are added (optional).
	switch(config-islb-init)# <b>no zonename IslbZone</b>	Removes the initiators and initiator targets from the zone and adds them to a dynamically created zone (default).
Step 4	switch(config-islb-init)# <b>exit</b>	Returns to configuration mode.
Step 5	switch(config)# <b>islb zoneset activate</b>	Activates zoning for the iSLB initiators and initiator targets with zoning enabled and creates auto-zones if no zone names are configured.
		<b>Note</b> This step is not required if CFS is enabled. CFS automatically activates the zone when the configuration changes are committed.

Choose **IP > iSCSI iSLB** in Device Manager and set the autoZoneName field to change the auto zone name for an iSLB initiator.

See the “[Configuring iSLB Using Device Manager](#)” procedure on page 4-149.

## Verifying iSLB Zoning Configuration

The following example shows the **show zoneset active** command output when the dynamically generated zone name is used:

```
switch# show zoneset active
zoneset name zoneset-1 vsan 1
  zone name ips_zone_5d9603bcff68008a6fc5862a6670ca09 vsan 1
    * fcid 0x010009 [ip-address 10.1.1.3]
      pwwn 22:00:00:04:cf:75:28:4d
      pwwn 22:00:00:04:cf:75:ed:53
      pwwn 22:00:00:04:cf:75:21:d5
      pwwn 22:00:00:04:cf:75:ee:59
```

The following example shows the **show zoneset active** command output when the configured zone name IslbZone is used:

```
switch# show zoneset active
zoneset name zoneset-1 vsan 1
  zone name ips_zone_IslbZone vsan 1
    ip-address 10.1.1.3
      pwwn 22:00:00:04:cf:75:28:4d
      pwwn 22:00:00:04:cf:75:ed:53
      pwwn 22:00:00:04:cf:75:21:d5
      pwwn 22:00:00:04:cf:75:ee:59
```

## Configuring iSLB Session Authentication

The Fibre Channel module with IPS ports and MPS-14/2 module support the iSLB authentication mechanism to authenticate iSLB hosts that request access to storage. By default, the Fibre Channel module with IPS ports and MPS-14/2 module allow CHAP or None authentication of iSCSI initiators. If authentication is always used, you must configure the switch to allow only CHAP authentication.

For CHAP user name or secret validation you can use any method supported and allowed by the Cisco MDS AAA infrastructure (see the *Cisco Fabric Manager Security Configuration Guide* *Cisco MDS 9000 Family NX-OS Security Configuration Guide* for more information). AAA authentication supports RADIUS, TACACS+, or a local authentication device.



**Note** Specifying the iSLB session authentication is the same as for iSCSI. See the [“iSCSI Session Authentication”](#) section on page 4-128.

### Restricting iSLB Initiator Authentication

By default, the iSLB initiator can use any user name in the RADIUS or local AAA database in authenticating itself to the Fibre Channel module with IPS ports or MPS-14/2 module (the CHAP user name is independent of the iSLB initiator name). The Fibre Channel module with IPS ports or MPS-14/2 module allows the initiator to log in as long as it provides a correct response to the CHAP challenge sent by the switch. This can be a problem if one CHAP user name and password have been compromised.

To restrict an initiator to use a specific user name for CHAP authentication, follow these steps:

	Command	Purpose
<b>Step 1</b>	switch# <b>config terminal</b> switch(config)#	Enters configuration mode.
<b>Step 2</b>	switch(config)# <b>islb initiator</b> <b>name iqn.1987-02.com.cisco.init</b> switch(config-islb-init)#	Configures an iSLB initiator using the IQN of the initiator node and enters iSLB initiator configuration mode.
<b>Step 3</b>	switch(config-islb-init)# <b>username user1</b>	Restricts the initiator <code>iqn.1987-02.com.cisco.init</code> to only authenticate using <code>user1</code> as its CHAP user name.  <b>Note</b> Be sure to define <code>user1</code> as an iSCSI user in the local AAA database or the RADIUS server.

Choose **IP > iSCSI iSLB** in Device Manager and set the AuthName field to restrict an initiator to use a specific user name for CHAP authentication.

See the [“Configuring iSLB Using Device Manager”](#) procedure on page 4-149.

### Mutual CHAP Authentication

In addition to the Fibre Channel module with IPS ports and MPS-14/2 module authentication of the iSLB initiator, the Fibre Channel module with IPS ports and MPS-14/2 module also support a mechanism for the iSLB initiator to authenticate the Cisco MDS switch’s initiator target during the iSCSI login phase. This authentication requires the user to configure a user name and password for the switch to present to the iSLB initiator. The provided password is used to calculate a CHAP response to a CHAP challenge sent to the IPS port by the initiator.

To configure a per-initiator user name and password used by the switch to authenticate itself to an initiator, follow these steps:

	Command	Purpose
Step 1	switch# <b>config terminal</b> switch(config)#	Enters configuration mode.
Step 2	switch(config)# <b>islb initiator name</b> <b>iqn.1987-02.com.cisco.initiator</b> switch(config-islb-init)#	Configures an iSLB initiator using the name of the initiator node and enters iSLB initiator configuration mode.
Step 3	switch(config-islb-init)# <b>mutual-chap</b> <b>username testuser password dcba12LKJ</b>	Configures the switch user account (testuser) along with a password (dcba12LKJ) specified in clear text (default). The password is limited to 128 characters.
	switch(config-islb-init)# <b>mutual-chap</b> <b>username testuser password</b> <b>7!*asdfsdfjh!@df</b>	Configures the switch user account (testuser) along with the encrypted password specified by 7 (!@*asdfsdfjh!@df).
Step 4	switch(config-iscsi-init)# <b>no mutual-chap</b> <b>username testuser</b>	Removes the switch authentication configuration.

Choose **IP > iSCSI iSLB** in Device Manager and set the Target Username and Target Password fields to configure a per-initiator user name and password used by the switch to authenticate itself to an initiator.

See the “[Configuring iSLB Using Device Manager](#)” procedure on page 4-149.

### Verifying iSLB Authentication Configuration

Use the **show running-config** and the **show iscsi global** (see [Example 4-6](#)) commands to display the global configuration. Use the **show running-config** and the **show islb initiator configured** (see [Example 4-14](#)) commands to display the initiator specific configuration.

To verify the iSLB user name and mutual CHAP configuration, use the **show islb initiator configured** command:

```
switch# show islb initiator configured
iSCSI Node name is 10.1.1.3
Member of vsans: 3
User Name for login authentication: user1
User Name for Mutual CHAP: testuser
Load Balance Metric: 1000 Number of Initiator Targets: 1
Number of Initiator Targets: 1

Initiator Target: iqn.1987-05.com.cisco:05.ips-hac4
Port WWN 50:06:04:82:ca:e1:26:8d
Zoning Enabled
No. of LU mapping: 3
iSCSI LUN: 0x0001, FC LUN: 0x0001
iSCSI LUN: 0x0002, FC LUN: 0x0002
iSCSI LUN: 0x0003, FC LUN: 0x0003
```

### Load Balancing Using VRRP

You can configure Virtual Router Redundancy Protocol (VRRP) load balancing for iSLB. The host is configured with a VRRP address as the portal address. When the VRRP master port receives the first iSCSI session from an initiator, it assigns a backup port to serve that particular host. The information is synchronized to all switches through CFS if recovery is needed when a master port fails. The initiator gets a temporary redirect iSCSI login response. The host then logs in to the backup port at its physical IP address. All iSCSI interfaces in a VRRP group that has load balancing enabled must have the same interface VSAN, authentication, proxy initiator mode, and forwarding mode.

You can configure Virtual Router Redundancy Protocol (VRRP) load balancing for iSLB. Figure 4-35 shows an example of load balancing using iSLB.

**Figure 4-35** *iSLB Initiator Load Balancing Example*

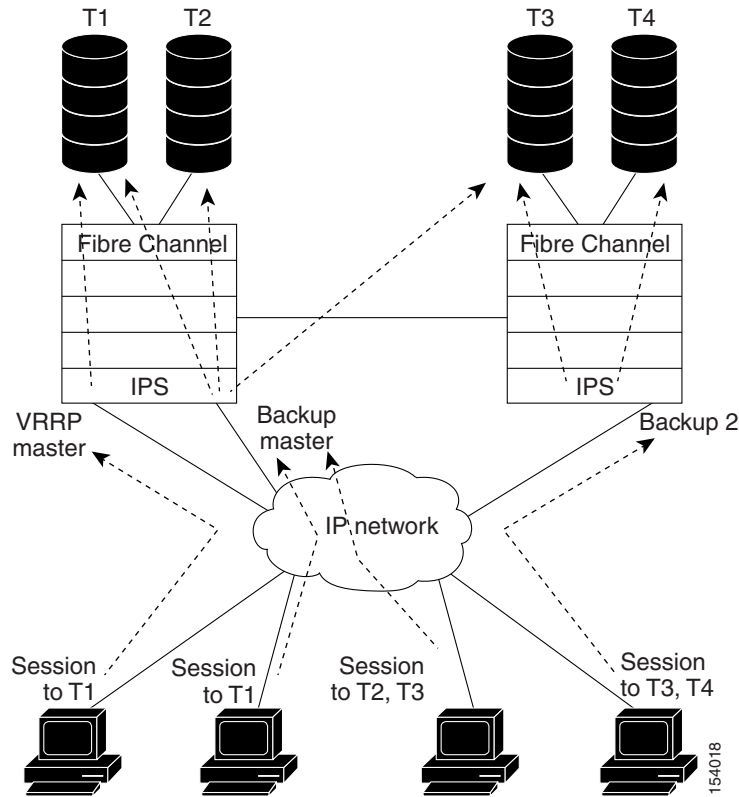

The host is configured with a VRRP address as the portal address. When the VRRP master port receives the first iSCSI session from an initiator, it assigns a backup port to serve that particular host. This information is synchronized to all switches through CFS if recovery is needed when a master port fails. The initiator gets a temporary redirect iSCSI login response. The host then logs in to the backup port at its physical IP address. If the backup port goes down, the host will revert to the master port. The master port knows through CFS that the backup port has gone down and redirects the host to another backup port.



**Note**

If an Ethernet port channel is configured between the Fibre Channel module with IPS ports and an Ethernet switch, the load balancing policy on the Ethernet switch must be based on source/destination IP address only, not port numbers, for load balancing with VRRP to operate correctly.



**Note**

An initiator can also be redirected to the physical IP address of the master interface.



**Tip**

iSLB VRRP load balancing is based on the number of iSLB initiators and not number of sessions. Any iSLB initiator that has more targets configured than the other iSLB initiators (resulting in more sessions) should be configured with a higher load metric. For example, you can increase the load metric of the iSLB initiator with more targets to 3000 from the default value of 1000.

**Caution**

A Gigabit Ethernet interface configured for iSLB can only be in one VRRP group because redirected sessions do not carry information about the VRRP IP address or group. This restriction allows the slave backup port to uniquely identify the VRRP group to which it belongs.

**Changing iSCSI Interface Parameters and the Impact on Load Balancing**

All iSCSI interfaces in a VRRP group that has load balancing enabled must have the same interface VSAN, authentication, proxy initiator mode, and forwarding mode. When you need to change any of these parameters for the iSCSI interfaces in a VRRP group, you must do so one interface at a time. During the transition time when the parameter is changed on some interfaces in the VRRP group and not the others, the master port does not redirect new initiators and instead handles them locally.

**Caution**

Changing the VSAN, proxy initiator, authentication, and forwarding mode for iSCSI interfaces in a VRRP group can cause sessions to go down multiple times.

**VRRP Load Balancing Algorithm for Selecting Gigabit Ethernet Interfaces**

When the VRRP master receives an iSCSI session request from an initiator, it first checks for an existing mapping to one of the interfaces in that VRRP group. If such a mapping exists, the VRRP master redirects the initiator to that interface. If no such mapping exists, the VRRP master selects the least loaded interface and updates the selected interface's load with the initiator's iSLB metric (weight).

**Note**

The VRRP master interface is treated specially and it needs to take a lower load compared to the other interfaces. This is to account for the redirection work performed by the master interface for every session. A new initiator is assigned to the master interface only if the following is true for every other interface:

$$\text{VRRP backup interface load} > [2 * \text{VRRP master interface load} + 1]$$

[Example 4-17](#) and [Example 4-18](#) are based on the following configurations:

- GigabitEthernet2/1.441 is the VRRP master interface for Switch1.
- GigabitEthernet2/2.441 is the VRRP backup interface for Switch1.
- GigabitEthernet1/1.441 is the VRRP backup interface for Switch2.
- GigabitEthernet1/2.441 is the VRRP backup interface for Switch2.

**Example 4-17 Load Distribution with the Default Metric**

The follow example output shows the initial load distribution for three initiators with the default load metric value:

```
switch# show islb vrrp summary
```

```
.
.
.
```

VR Id	VRRP IP	Switch WWN	Iindex	Load
M 1	10.10.122.115	20:00:00:0b:5f:3c:01:80	GigabitEthernet2/1.441	0
1	10.10.122.115	20:00:00:0b:5f:3c:01:80	GigabitEthernet2/2.441	1000
1	10.10.122.115	20:00:00:0c:ce:5c:5b:c0	GigabitEthernet1/1.441	1000
1	10.10.122.115	20:00:00:0c:ce:5c:5b:c0	GigabitEthernet1/2.441	1000

```

-- Initiator To Interface Assignment --
-----
Initiator          VR Id VRRP IP          Switch WWN          Ifindex
-----
iqn.cisco.test-linux.init0 1 10.10.122.115 20:00:00:0b:5f:3c:01:80 GigabitEthernet2/2.441
iqn.cisco.test-linux.init1 1 10.10.122.115 20:00:00:0c:ce:5c:5b:c0 GigabitEthernet1/1.441
iqn.cisco.test-linux.init 1 10.10.122.115 20:00:00:0c:ce:5c:5b:c0 GigabitEthernet1/2.441

```

The following example output shows load distribution for four initiators. The interface load metric value for the master interface changed from 0 to 1000.

```

switch# show islb vrrp summary
.
.
.
-----
VVR Id   VRRP IP          Switch WWN          Ifindex          Load
-----
M 1      10.10.122.115   20:00:00:0b:5f:3c:01:80 GigabitEthernet2/1.441 1000
  1      10.10.122.115   20:00:00:0b:5f:3c:01:80 GigabitEthernet2/2.441 1000
  1      10.10.122.115   20:00:00:0c:ce:5c:5b:c0 GigabitEthernet1/1.441 1000
  1      10.10.122.115   20:00:00:0c:ce:5c:5b:c0 GigabitEthernet1/2.441 1000
-- Initiator To Interface Assignment --

```

```

-----
Initiator          VR Id VRRP IP          Switch WWN          Ifindex
-----
iqn.cisco.test-linux.init0 1 10.10.122.115 20:00:00:0b:5f:3c:01:80 GigabitEthernet2/2.441
iqn.cisco.test-linux.init1 1 10.10.122.115 20:00:00:0c:ce:5c:5b:c0 GigabitEthernet1/1.441
iqn.cisco.test-linux.init2 1 10.10.122.115 20:00:00:0c:ce:5c:5b:c0 GigabitEthernet1/2.441
iqn.cisco.test-linux.init3 1 10.10.122.115 20:00:00:0b:5f:3c:01:80 GigabitEthernet2/1.441

```

The following example output shows load distribution for nine initiators. The interface load metric values for the backup interfaces have changed.

```

switch# show islb vrrp summary
.
.
.
-----
VVR Id   VRRP IP          Switch WWN          Ifindex          Load
-----
M 1      10.10.122.115   20:00:00:0b:5f:3c:01:80 GigabitEthernet2/1.441 1000
  1      10.10.122.115   20:00:00:0b:5f:3c:01:80 GigabitEthernet2/2.441 3000
  1      10.10.122.115   20:00:00:0c:ce:5c:5b:c0 GigabitEthernet1/1.441 3000
  1      10.10.122.115   20:00:00:0c:ce:5c:5b:c0 GigabitEthernet1/2.441 2000
-- Initiator To Interface Assignment --

```

```

-----
Initiator          VR Id VRRP IP          Switch WWN          Ifindex
-----
iqn.cisco.test-linux.init0 1 10.10.122.115 20:00:00:0b:5f:3c:01:80 GigabitEthernet2/2.441
iqn.cisco.test-linux.init1 1 10.10.122.115 20:00:00:0c:ce:5c:5b:c0 GigabitEthernet1/1.441
iqn.cisco.test-linux.init2 1 10.10.122.115 20:00:00:0c:ce:5c:5b:c0 GigabitEthernet1/2.441
iqn.cisco.test-linux.init3 1 10.10.122.115 20:00:00:0b:5f:3c:01:80 GigabitEthernet2/1.441
iqn.cisco.test-linux.init4 1 10.10.122.115 20:00:00:0b:5f:3c:01:80 GigabitEthernet2/2.441
iqn.cisco.test-linux.init5 1 10.10.122.115 20:00:00:0c:ce:5c:5b:c0 GigabitEthernet1/1.441
iqn.cisco.test-linux.init6 1 10.10.122.115 20:00:00:0c:ce:5c:5b:c0 GigabitEthernet1/2.441
iqn.cisco.test-linux.init7 1 10.10.122.115 20:00:00:0b:5f:3c:01:80 GigabitEthernet2/2.441
iqn.cisco.test-linux.init8 1 10.10.122.115 20:00:00:0c:ce:5c:5b:c0 GigabitEthernet1/1.441

```

#### Example 4-18 Load Distribution with the Metric Set to 3000 on One Initiator

The following example output shows the initial load distribution for three initiators with one initiator having load metric of 3000 and the remaining initiator with the default metric value:

```
switch# show islb vrrp summary
```

```
.
.
.
```

```
-----
VVR Id      VRRP IP          Switch WWN          Ifindex            Load
-----
M 1         10.10.122.115   20:00:00:0b:5f:3c:01:80 GigabitEthernet2/1.441 0
  1         10.10.122.115   20:00:00:0b:5f:3c:01:80 GigabitEthernet2/2.441 1000
  1         10.10.122.115   20:00:00:0c:ce:5c:5b:c0 GigabitEthernet1/1.441 3000
  1         10.10.122.115   20:00:00:0c:ce:5c:5b:c0 GigabitEthernet1/2.441 1000
      -- Initiator To Interface Assignment --
-----
Initiator          VR Id VRRP IP          Switch WWN          Ifindex
-----
iqn.cisco.test-linux.init0 1 10.10.122.115 20:00:00:0c:ce:5c:5b:c0 GigabitEthernet1/1.441
iqn.cisco.test-linux.init1 1 10.10.122.115 20:00:00:0b:5f:3c:01:80 GigabitEthernet2/2.441
iqn.cisco.test-linux.init2 1 10.10.122.115 20:00:00:0c:ce:5c:5b:c0 GigabitEthernet1/2.441
```

The follow example output shows load distribution for four initiators. The interface load metric value for the master interface changed from 0 to 1000.

```
switch# show islb vrrp summary
```

```
.
.
.
```

```
-----
VVR Id      VRRP IP          Switch WWN          Ifindex            Load
-----
M 1         10.10.122.115   20:00:00:0b:5f:3c:01:80 GigabitEthernet2/1.441 1000
  1         10.10.122.115   20:00:00:0b:5f:3c:01:80 GigabitEthernet2/2.441 3000
  1         10.10.122.115   20:00:00:0c:ce:5c:5b:c0 GigabitEthernet1/1.441 1000
  1         10.10.122.115   20:00:00:0c:ce:5c:5b:c0 GigabitEthernet1/2.441 1000
      -- Initiator To Interface Assignment --
-----
Initiator          VR Id VRRP IP          Switch WWN          Ifindex
-----
iqn.cisco.test-linux.init0 1 10.10.122.115 20:00:00:0b:5f:3c:01:80 GigabitEthernet2/2.441
iqn.cisco.test-linux.init1 1 10.10.122.115 20:00:00:0c:ce:5c:5b:c0 GigabitEthernet1/2.441
iqn.cisco.test-linux.init2 1 10.10.122.115 20:00:00:0c:ce:5c:5b:c0 GigabitEthernet1/1.441
iqn.cisco.test-linux.init3 1 10.10.122.115 20:00:00:0b:5f:3c:01:80 GigabitEthernet2/1.441
```

The following example output shows load distribution for nine initiators. The interface load metric values for the backup interfaces have changed.

```
switch# show islb vrrp summary
```

```
.
.
.
```

```
-----
VVR Id      VRRP IP          Switch WWN          Ifindex            Load
-----
M 1         10.10.122.115   20:00:00:0b:5f:3c:01:80 GigabitEthernet2/1.441 2000
  1         10.10.122.115   20:00:00:0b:5f:3c:01:80 GigabitEthernet2/2.441 3000
  1         10.10.122.115   20:00:00:0c:ce:5c:5b:c0 GigabitEthernet1/1.441 3000
  1         10.10.122.115   20:00:00:0c:ce:5c:5b:c0 GigabitEthernet1/2.441 3000
      -- Initiator To Interface Assignment --
-----
Initiator          VR Id VRRP IP          Switch WWN          Ifindex
-----
iqn.cisco.test-linux.init0 1 10.10.122.115 20:00:00:0b:5f:3c:01:80 GigabitEthernet2/2.441
iqn.cisco.test-linux.init1 1 10.10.122.115 20:00:00:0c:ce:5c:5b:c0 GigabitEthernet1/1.441
iqn.cisco.test-linux.init2 1 10.10.122.115 20:00:00:0c:ce:5c:5b:c0 GigabitEthernet1/2.441
iqn.cisco.test-linux.init3 1 10.10.122.115 20:00:00:0b:5f:3c:01:80 GigabitEthernet2/1.441
```

```

iqn.cisco.test-linux.init4 1 10.10.122.115 20:00:00:0c:ce:5c:5b:c0 GigabitEthernet1/1.441
iqn.cisco.test-linux.init5 1 10.10.122.115 20:00:00:0c:ce:5c:5b:c0 GigabitEthernet1/2.441
iqn.cisco.test-linux.init6 1 10.10.122.115 20:00:00:0c:ce:5c:5b:c0 GigabitEthernet1/1.441
iqn.cisco.test-linux.init7 1 10.10.122.115 20:00:00:0c:ce:5c:5b:c0 GigabitEthernet1/2.441
iqn.cisco.test-linux.init8 1 10.10.122.115 20:00:00:0b:5f:3c:01:80 GigabitEthernet2/1.441

```

## Configuring Load Balancing Using VRRP

You must first configure VRRP on the Gigabit Ethernet interfaces on the switch that connect to the IP network before configuring VRRP for iSLB. For information on how to configure VRRP on a Gigabit Ethernet interface, see the “[Virtual Router Redundancy Protocol](#)” section on page 5-240.

To configure VRRP load balancing using Device Manager, follow these steps:

**Step 1** Choose **IP > iSCSI iSLB**.

You see the iSCSI iSLB dialog box (see [Figure 4-32](#)).

**Step 2** Click the **VRRP** tab.

**Step 3** Click **Create** to configure VRRP load balancing for iSLB initiators.

You see the Create iSCSI iSLB VRRP dialog box (see [Figure 4-36](#)).

**Figure 4-36** Create iSCSI iSLB VRRP Dialog Box

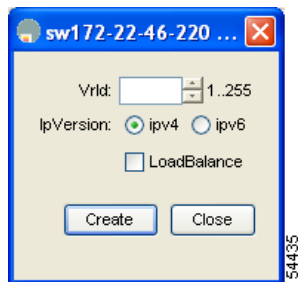

**Step 4** Set the Vrid to the VRRP group number.

**Step 5** Select either **ipv4** or **ipv6** and check the **LoadBalance** check box.

**Step 6** Click **Create** to enable load balancing.

**Step 7** If CFS is enabled, select **commit** from the CFS drop-down menu.

## Enabling VRRP for Load Balancing

To enable or disable VRRP for iSLB, follow these steps:

	Command	Purpose
<b>Step 1</b>	switch# <b>config terminal</b> switch(config)#	Enters configuration mode.
<b>Step 2</b>	switch(config)# <b>islb vrrp 10 load-balance</b>	Enables iSLB VRRP for IPv4 VR group 10.
<b>Step 3</b>	switch(config)# <b>no islb vrrp 10 load-balance</b>	Disables iSLB VRRP for IPv4 VR group 10.

	Command	Purpose
Step 4	switch(config)# <b>islb vrrp ipv6 20 load-balance</b>	Enables iSLB VRRP for IPv6 VR group 20.
Step 5	switch(config)# <b>no islb vrrp ipv6 20 load-balance</b>	Disables iSLB VRRP for IPv6 VR group 20.

## Verifying iSLB VRRP Load Balancing Configuration

To verify the iSLB VRRP load balancing configuration for IPv4, use the **show vrrp vr** command:

```
switch# show vrrp vr 1
  Interface VR IpVersion Pri   Time Pre State   VR IP addr
-----
  GigE1/5   1   IPv4   100   1 s   master 10.10.10.1
  GigE1/6   1   IPv4   100   1 s   master 10.10.10.1
```

To verify the iSLB VRRP load balancing configuration for IPv6, use the **show vrrp ipv6 vr** command:

```
switch# show vrrp ipv6 vr 1
  Interface VR IpVersion Pri   Time Pre State   VR IP addr
-----
  GigE6/2   1   IPv6   100 100cs   master 5000:1::100
  PortCh 4   1   IPv6   100 100cs   master 5000:1::100
```

## Displaying iSLB VRRP Information

Use the **show islb vrrp summary vr** command to display VRRP load-balancing information:

```
switch# show islb vrrp summary vr 30
-- Groups For Load Balance --
-----
VR Id          VRRP Address Type          Configured Status
-----
30             IPv4                        Enabled
-----
-- Interfaces For Load Balance --
-----
VR Id   VRRP IP           Switch WWN           Ifindex           Load
-----
30     192.168.30.40    20:00:00:0d:ec:02:cb:00  GigabitEthernet3/1  2000
30     192.168.30.40    20:00:00:0d:ec:02:cb:00  GigabitEthernet3/2  2000
30     192.168.30.40    20:00:00:0d:ec:0c:6b:c0  GigabitEthernet4/1  2000
M 30     192.168.30.40    20:00:00:0d:ec:0c:6b:c0  GigabitEthernet4/2  1000
```

## iSLB Configuration Distribution Using CFS

You can distribute the configuration for iSLB initiators and initiator targets on an MDS switch. This feature lets you synchronize the iSLB configuration across the fabric from the console of a single MDS switch. The iSCSI initiator idle timeout, global authentication, and iSCSI dynamic initiator mode parameters are also distributed. CFS distribution is disabled by default.

Configuration for iSLB initiators and initiator targets on an MDS switch can be distributed using the Cisco Fabric Services (CFS). This feature allows you to synchronize the iSLB configuration across the fabric from the console of a single MDS switch. The iSCSI initiator idle timeout, iSCSI dynamic initiator mode, and global authentication parameters are also distributed. CFS distribution is disabled by default (see the *Cisco Fabric Manager System Management Configuration Guide* and *Cisco MDS 9000 Family NX-OS System Management Configuration Guide* for more information).

After enabling the distribution, the first configuration starts an implicit session. All server configuration changes entered thereafter are stored in a temporary database and applied to all switches in the fabric (including the originating one) when you explicitly commit the database.

When CFS is enabled for iSLB, the first iSLB configuration operation starts a CFS session and locks the iSLB configuration in the fabric. The configuration changes are applied to the pending configuration database. When you make the changes to the fabric, the pending configuration is distributed to all the switches in the fabric. Each switch then validates the configuration. This check ensures the following:

- The VSANs assigned to the iSLB initiators are configured on all the switches.
- The static WWNs configured for the iSLB initiators are unique and available on all the switches.
- The iSLB initiator node names do not conflict with the iSCSI initiators on all the switches.

After the check completes successfully, all the switches commit the pending configuration to the running configuration. If any check fails, the entire commit fails.

**Note**

iSLB is only fully supported when CFS is enabled. Using iSLB auto-zoning without enabling CFS mode may cause traffic disruption when any zone set is activated.

**Note**

CFS does not distribute non-iSLB initiator configurations or import Fibre Channel target settings.

Non-iSLB virtual targets will continue to support advertised interfaces option.

**Tip**

The pending changes are only available in the volatile directory and are discarded if the switch is restarted.

## Distributing iSLB Configuration Using CFS

This section contains the following:

- [Enabling iSLB Configuration Distribution, page 4-169](#)
- [Locking the Fabric, page 4-169](#)
- [Committing Changes to the Fabric, page 4-170](#)
- [Discarding Pending Changes, page 4-170](#)
- [Clearing a Fabric Lock, page 4-171](#)
- [CFS Merge Process, page 4-171](#)
- [Displaying Pending iSLB Configuration Changes, page 4-171](#)
- [Displaying iSLB CFS Status, page 4-172](#)
- [Displaying iSLB CFS Distribution Session Status, page 4-172](#)
- [Displaying iSLB CFS Merge Status, page 4-172](#)

- [iSLB CFS Merge Status Conflicts, page 4-172](#)

### Enabling iSLB Configuration Distribution

To enable CFS distribution of the iSLB configuration, follow these steps:

	Command	Purpose
<b>Step 1</b>	switch# <b>config terminal</b>	Enters configuration mode.
<b>Step 2</b>	switch(config)# <b>islb distribute</b>	Enables iSLB configuration distribution.
	switch(config)# <b>no isl b distribute</b>	Disables (default) iSLB configuration distribution.

To enable CFS distribution of the iSLB configuration using Device Manager, follow these steps:

**Step 1** Choose **Admin > CFS**.

You see the CFS dialog box (see [Figure 4-37](#)).

**Figure 4-37** Enabling CFS in Device Manager

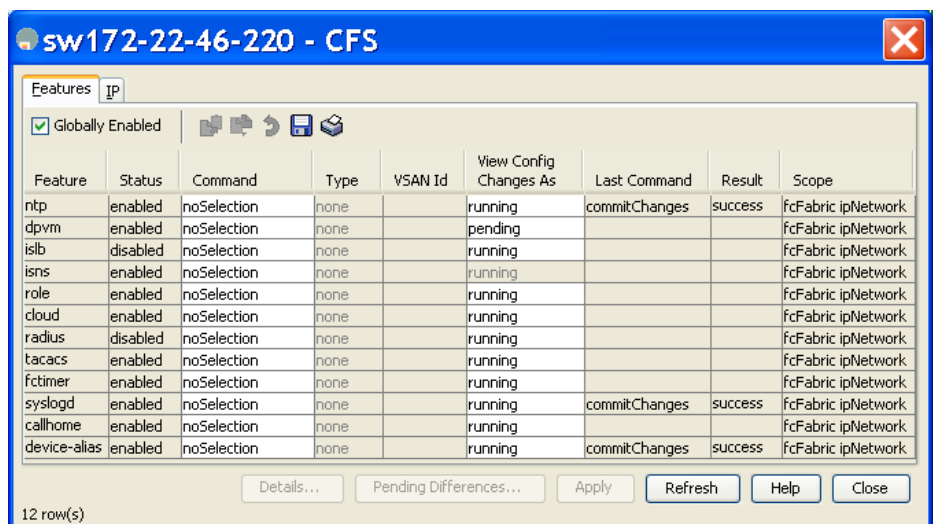

**Step 2** Set the Command field to **enable** for the iSLB feature.

**Step 3** Click **Apply** to save this change.

### Locking the Fabric

The first action that modifies the existing configuration creates the pending configuration and locks the feature in the fabric. Once you lock the fabric, the following conditions apply:

- No other user can make any configuration changes to this feature.
- A pending configuration is created by copying the active configuration. Modifications from this point on are made to the pending configuration and remain there until you commit the changes to the active configuration (and other switches in the fabric) or discard them.



**Note** iSCSI configuration changes are not allowed when an iSLB CFS session is active.

### Committing Changes to the Fabric

To apply the pending iSLB configuration changes to the active configuration and to other MDS switches in the fabric, you must commit the changes. The pending configuration changes are distributed and, on a successful commit, the configuration changes are applied to the active configuration in the MDS switches throughout the fabric, the automatic zones are activated, and the fabric lock is released.

To commit iSLB configuration changes to other MDS switches in the fabric, activate iSLB automatic zones, and release the fabric lock, follow these steps:

	Command	Purpose
<b>Step 1</b>	switch# <b>config terminal</b>	Enters configuration mode.
<b>Step 2</b>	switch(config)# <b>islb commit</b>	Commits the iSLB configuration distribution, activates iSLB automatic zones, and releases the fabric lock.

To commit iSLB configuration changes to other MDS switches in the fabric, activate iSLB automatic zones, and release the fabric lock using Device Manager, follow these steps:

**Step 1** Choose **Admin > CFS**.

You see the CFS Configuration dialog box (see [Figure 4-37](#)).

**Step 2** Set the Command field to **commit** for the iSLB feature.

**Step 3** Click **Apply** to save this change.

### Discarding Pending Changes

At any time, you can discard the pending changes to the iSLB configuration and release the fabric lock. This action has no affect on the active configuration on any switch in the fabric.

To discard the pending iSLB configuration changes and release the fabric lock, follow these steps:

	Command	Purpose
<b>Step 1</b>	switch# <b>config terminal</b>	Enters configuration mode.
<b>Step 2</b>	switch(config)# <b>islb abort</b>	Commits the iSLB configuration distribution.

To discard the pending iSLB configuration changes and release the fabric lock using Device Manager, follow these steps:

**Step 1** Choose **Admin > CFS**.

You see the CFS Configuration dialog box (see [Figure 4-37](#)).

**Step 2** Set the Command field to **abort** for the iSLB feature.

**Step 3** Click **Apply** to save this change.

## Clearing a Fabric Lock

If you have performed an iSLB configuration task and have not released the lock by either committing or discarding the changes, an administrator can release the lock from any switch in the fabric. If the administrator performs this task, your pending changes are discarded and the fabric lock is released.



**Note** The pending changes are only available in the volatile directory and are discarded if the switch is restarted.

To release a fabric lock, issue the **clear islb session** command in EXEC mode using a login ID that has administrative privileges:

```
switch# clear islb session
```

To release a fabric lock using Device Manager, follow these steps:

**Step 1** Choose **Admin > CFS**.

You see the CFS Configuration dialog box (see [Figure 4-37](#)).

**Step 2** Set the Command field to **clear** for the iSLB feature.

**Step 3** Click **Apply** to save this change.

## CFS Merge Process

When two fabrics merge, CFS attempts to merge the iSLB configuration from both the fabrics. A designated switch (called the *dominant switch*) in one fabric sends its iSLB configuration to a designated switch (called the *subordinate switch*) in the other fabric. The subordinate switch compares its running configuration to the received configuration for any conflicts. If no conflicts are detected, it merges the two configurations and sends it to all the switches in both the fabrics. Each switch then validates the configuration. This check ensures the following:

- VSANs assigned to the iSLB initiators are configured on all the switches.
- The static WWNs configured for the iSLB initiators are unique and available on all the switches.
- The iSLB initiator node names have no conflicts with iSCSI initiators on all the switches.

If this check completes successfully, the subordinate switch directs all the switches to commit the merged configuration to running configuration. If any check fails, the merge fails.

The **show islb merge status** command displays the exact reason for the failure. The first successful commit request after a merge failure takes the fabric out of the merge failure state.

## Displaying Pending iSLB Configuration Changes

You can display the pending configuration changes using the **show islb pending** command:

```
switch# show islb pending
iscsi initiator idle-timeout 10
islb initiator ip-address 10.1.1.1
static pWWN 23:01:00:0c:85:90:3e:82
static pWWN 23:06:00:0c:85:90:3e:82
username test1
islb initiator ip-address 10.1.1.2
static nWWN 23:02:00:0c:85:90:3e:82
```

You can display the differences between the pending configuration and the current configuration using the **show islb pending-diff** command:

```
switch# show islb pending-diff
+iscsi initiator idle-timeout 10
islb initiator ip-address 10.1.1.1
+ static pWWN 23:06:00:0c:85:90:3e:82
+islb initiator ip-address 10.1.1.2
+ static nWWN 23:02:00:0c:85:90:3e:82
```

### Displaying iSLB CFS Status

You can display the iSLB CFS status using the **show islb session status** command:

```
switch# show islb status
iSLB Distribute is enabled
iSLB CFS Session exists
```

### Displaying iSLB CFS Distribution Session Status

You can display the status of the iSLB CFS distribution session using the **show islb cfs-session status** command:

```
switch# show islb cfs-session status
last action          : fabric distribute enable
last action result   : success
last action failure cause : success
```

### Displaying iSLB CFS Merge Status

You can display the iSLB CFS merge status using the **show islb merge status** command:

```
switch# show islb merge status
Merge Status: Success
```

### iSLB CFS Merge Status Conflicts

Merge conflicts may occur. User intervention is required for the following merge conflicts:

- The iSCSI global authentication or iSCSI initiator idle timeout parameters are not configured the same in the two fabrics.
- The same iSLB initiator is configured differently in the two fabrics.
- An iSLB initiator in one fabric has the same name as an iSCSI initiator in the other fabric.
- Duplicate pWWN/nWWN configuration is detected in the two fabric. For example, a pWWN/nWWN configured for an iSLB initiator on one fabric is configured for an iSCSI initiator or a different iSLB initiator in the other fabric.
- A VSAN configured for an iSLB initiator in one fabric does not exist in the other fabric.



**Tip**

---

Check the syslog for details on merge conflicts.

---

User intervention is not required when the same iSLB initiator has a different set of non-conflicting initiator targets. The merged configuration is the union of all the initiator targets.

## iSCSI High Availability

The following high availability features are available for iSCSI configurations:

- [Transparent Target Failover, page 4-173](#)
- [Multiple IPS Ports Connected to the Same IP Network, page 4-178](#)
- [VRRP-Based High Availability, page 4-178](#)
- [Ethernet Port Channel-Based High Availability, page 4-179](#)

### Transparent Target Failover

The following high-availability features are available for iSCSI configurations:

- iSCSI high availability with host running multi-path software—In this topology, you have recovery from failure of any of the components. The host multi-path software takes care of load balancing or failover across the different paths to access the storage.
- iSCSI high availability with host not having multi-path software—Without multi-path software, the host does not have knowledge of the multiple paths to the same storage.

#### iSCSI High Availability with Host Running Multipath Software

[Figure 4-38](#) shows the physical and logical topology for an iSCSI HA solution for hosts running multi-path software. In this scenario, the host has four iSCSI sessions. There are two iSCSI sessions from each host NIC to the two IPS ports.

Figure 4-38 Host Running Multipath Software

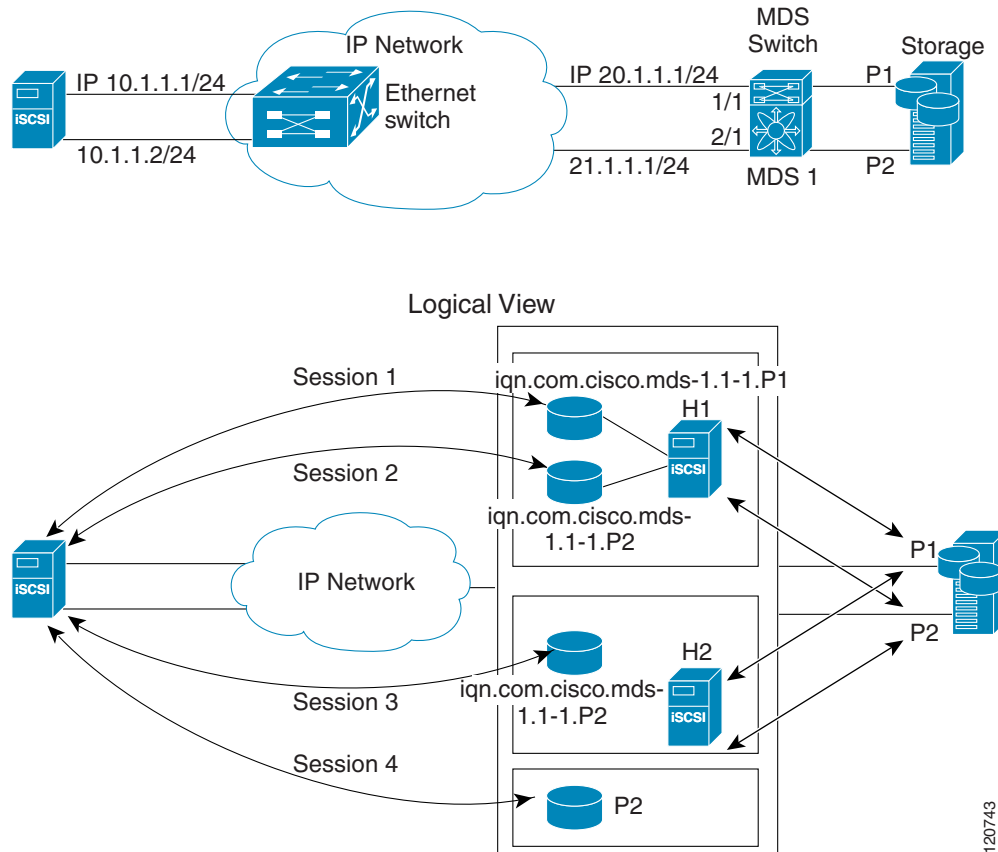

Each IPS ports is exporting the same two Fibre Channel target ports of the storage but as different iSCSI target names if you use dynamic iSCSI targets). So the two IPS ports are exporting a total of four iSCSI target devices. These four iSCSI targets map the same two ports of the Fibre Channel target.

The iSCSI host uses NIC-1 to connect to IPS port 1 and NIC-2 to connect to IPS port 2. Each IPS port exports two iSCSI targets, so the iSCSI host creates four iSCSI sessions.

If the iSCSI host NIC-1 fails (see [Figure 4-38](#) for the physical view), then sessions 1 and 2 fail but we still have sessions 3 and 4.

If the IPS port 1 fails, the iSCSI host cannot connect to the IPS port, and sessions 1 and 2 fail. But sessions 3 and 4 are still available.

If the storage port 1 fails, then the IPS ports will terminate sessions 1 and 3 (put iSCSI virtual target `iqn.com.cisco.mds-5.1-2.p1` and `iqn-com.cisco.mds-5.1-1.p1` in offline state). But sessions 2 and 4 are still available.

In this topology, you have recovery from failure of any of the components. The host multi-path software takes care of load-balancing or failover across the different paths to access the storage.

### iSCSI HA with Host Not Having Any Multipath Software

The above topology will not work if the host does not have multi-path software because the host has multiple sessions to the same storage. Without multi-path software the host does not have knowledge of the multiple paths to the same storage.

IP storage has two additional features that provide an HA solution in this scenario.

- IPS ports support the VRRP feature (see [“Configuring VRRP for IP Storage Interfaces”](#) section on page 6-265) to provide failover for IPS ports.

- IPS has transparent Fibre Channel target failover for iSCSI static virtual targets.

Statically imported iSCSI targets have an additional option to provide a secondary pWWN for the Fibre Channel target. This can be used when the physical Fibre Channel target is configured to have an LU visible across redundant ports. When the active port fails, the secondary port becomes active and the iSCSI session switches to use the new active port (see [Figure 4-39](#)).

**Figure 4-39** Static Target Importing Through Two Fibre Channel Ports

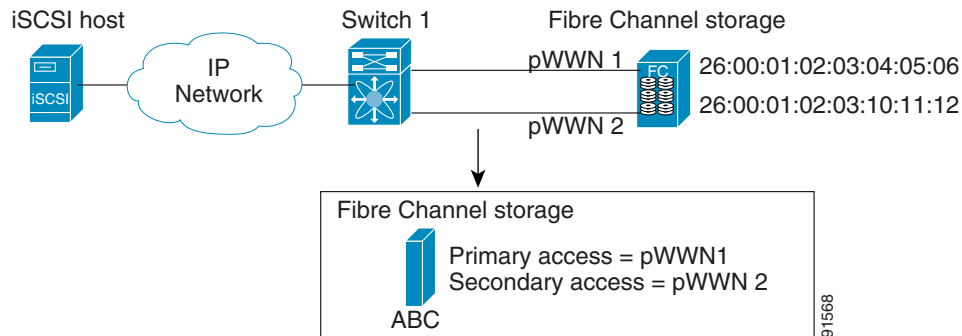

In [Figure 4-39](#), you can create an iSCSI virtual target that is mapped to both pWWN1 and pWWN2 to provide redundant access to the Fibre Channel targets.

The failover to a secondary port is done transparently by the IPS port without impacting the iSCSI session from the host. All outstanding I/Os are terminated with a check condition status when the primary port fails. New I/Os received during the failover are not completed and receive a busy status.



**Tip**

If you use LUN mapping, you can define a different secondary Fibre Channel LUN if the LU number is different.

Enable the optional **revert-primary-port** option to direct the IPS port to switch back to the primary port when the primary port is up again. If this option is disabled (default) and the primary port is up again after a switchover, the old sessions will remain with the secondary port and do not switch back to the primary port. However, any new session will use the primary port. This is the only situation when both the primary and secondary ports are used at the same time.

To create a static iSCSI virtual target, follow these steps:

	Command	Purpose
<b>Step 1</b>	switch# <b>config terminal</b> switch(config)#	Enters configuration mode.
<b>Step 2</b>	switch(config)# <b>iscsi virtual-target name</b> <b>iqn.1987-02.com.cisco.initiator</b>	Creates the iSCSI target name iqn.1987-02.com.cisco.initiator.

	Command	Purpose
<b>Step 3</b>	<code>switch(config-iscsi-tgt)# pwwn 26:00:01:02:03:04:05:06</code>	Configures the primary port for this virtual target.
	<code>switch(config-iscsi-tgt)# pwwn 26:00:01:02:03:04:05:06 secondary-pwwn 26:00:01:02:03:10:11:12</code>	Configures the primary and secondary ports for this virtual target.
	<code>switch(config-iscsi-tgt)# pwwn 26:00:01:02:03:04:05:06 fc-lun 0x1 iscsi-lun 0x0 sec-lun 0x3</code>	Configures the primary port for this virtual target with LUN mapping and different LUN on the secondary Fibre Channel port.  <b>Note</b> The CLI interprets the LUN identifier value as a hexadecimal value whether or not the <b>0x</b> prefix is included.
	<code>switch(config-iscsi-tgt)# no pwwn 26:00:01:02:03:04:05:06</code>	Removes the primary port, secondary port, and LUN mapping configuration for this virtual target.
<b>Step 4</b>	<code>switch(config-iscsi-tgt)# revert-primary-port</code>	Configures the session failover redundancy for this virtual-target to switch all sessions back to primary port when the primary port comes back up.
<b>Step 5</b>	<code>switch(config-iscsi-tgt)# no revert-primary-port</code>	Directs the switch to continue using the secondary port for existing sessions and to use the primary port for new sessions (default).

To create a static iSCSI virtual target for the entire Fibre Channel target port using Device Manager, follow these steps:

**Step 1** Click **IP > iSCSI**.

You see the iSCSI configuration (see [Figure 4-12](#)).

**Step 2** Click the **Targets** tab to display a list of existing iSCSI targets shown (see [Figure 4-13](#)).

**Step 3** Click **Create** to create an iSCSI target.

You see the Create iSCSI Targets dialog box (see [Figure 4-15](#)).

**Step 4** Set the iSCSI target node name in the iSCSI Name field, in IQN format.

**Step 5** Set the Port WWN field for the Fibre Channel target port you are mapping.

**Step 6** Click the **Select from List** radio button and set the iSCSI initiator node names or IP addresses that you want this virtual iSCSI target to access, or click the **All** radio button to let the iSCSI target access all iSCSI initiators. See the “[iSCSI Access Control](#)” section on page 4-123.

**Step 7** Click the **Select from List** radio button and check each interface you want to advertise the iSCSI targets on or choose the **All** radio button to advertise all interfaces.

**Step 8** Click **Apply** to save this change.

## LUN Trespass for Storage Port Failover

In addition to the high availability of statically imported iSCSI targets, the trespass feature is available to enable the move of LUs, on an active port failure, from the active to the passive port of a statically imported iSCSI target.

In physical Fibre Channel targets, which are configured to have LUs visible over two Fibre Channel N ports, when the active port fails, the passive port takes over. Some physical Fibre Channel targets require that the trespass feature be used to move the LUs from the active port to the passive port. A statically imported iSCSI target's secondary pWWN option and an additional option of enabling the trespass feature is available for a physical Fibre Channel target with redundant ports. When the active port fails, the passive port becomes active, and if the trespass feature is enabled, the Cisco MDS switch sends a request to the target to move the LUs on the new active port. The iSCSI session switches to use the new active port and the moved LUs are accessed over the new active port (see [Figure 4-40](#)).

**Figure 4-40** Virtual Target with an Active Primary Port

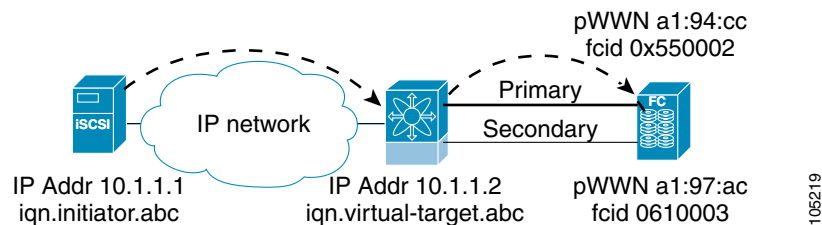

To enable the trespass feature for a static iSCSI virtual target, follow these steps:

	Command	Purpose
<b>Step 1</b>	switch# <b>config terminal</b> switch(config)#	Enters configuration mode.
<b>Step 2</b>	switch(config)# <b>iscsi virtual-target name</b> <b>iqn.1987-02.com.cisco.initiator</b> switch(config-iscsi-tgt)#	Creates the iSCSI target name iqn.1987-02.com.cisco.initiator.
<b>Step 3</b>	switch(config-iscsi-tgt)# <b>pwwn</b> <b>50:00:00:a1:94:cc secondary-pwwn</b> <b>50:00:00:a1:97:ac</b>	Maps a virtual target node to a Fibre Channel target and configures a secondary pWWN.
<b>Step 4</b>	switch(config-iscsi-tgt)# <b>trespass</b>	Enables the trespass feature.
	switch(config-iscsi-tgt)# <b>no trespass</b>	Disables the trespass feature (default).

Use the **show iscsi virtual-target** command to verify:

```
switch# show iscsi virtual-target iqn.1987-02.com.cisco.initiator
target: 1987-02.com.cisco.initiator
  Port WWN 10:20:10:00:56:00:70:50
  Configured node
  all initiator permit is disabled
  trespass support is enabled
```

In Device Manager, choose **IP > iSCSI**, select the **Targets** tab, and check the **Trespass Mode** check box to enable the trespass feature for a static iSCSI virtual target.

## Multiple IPS Ports Connected to the Same IP Network

Figure 4-41 provides an example of a configuration with multiple Gigabit Ethernet interfaces in the same IP network.

Figure 4-41 Multiple Gigabit Ethernet Interfaces in the Same IP Network

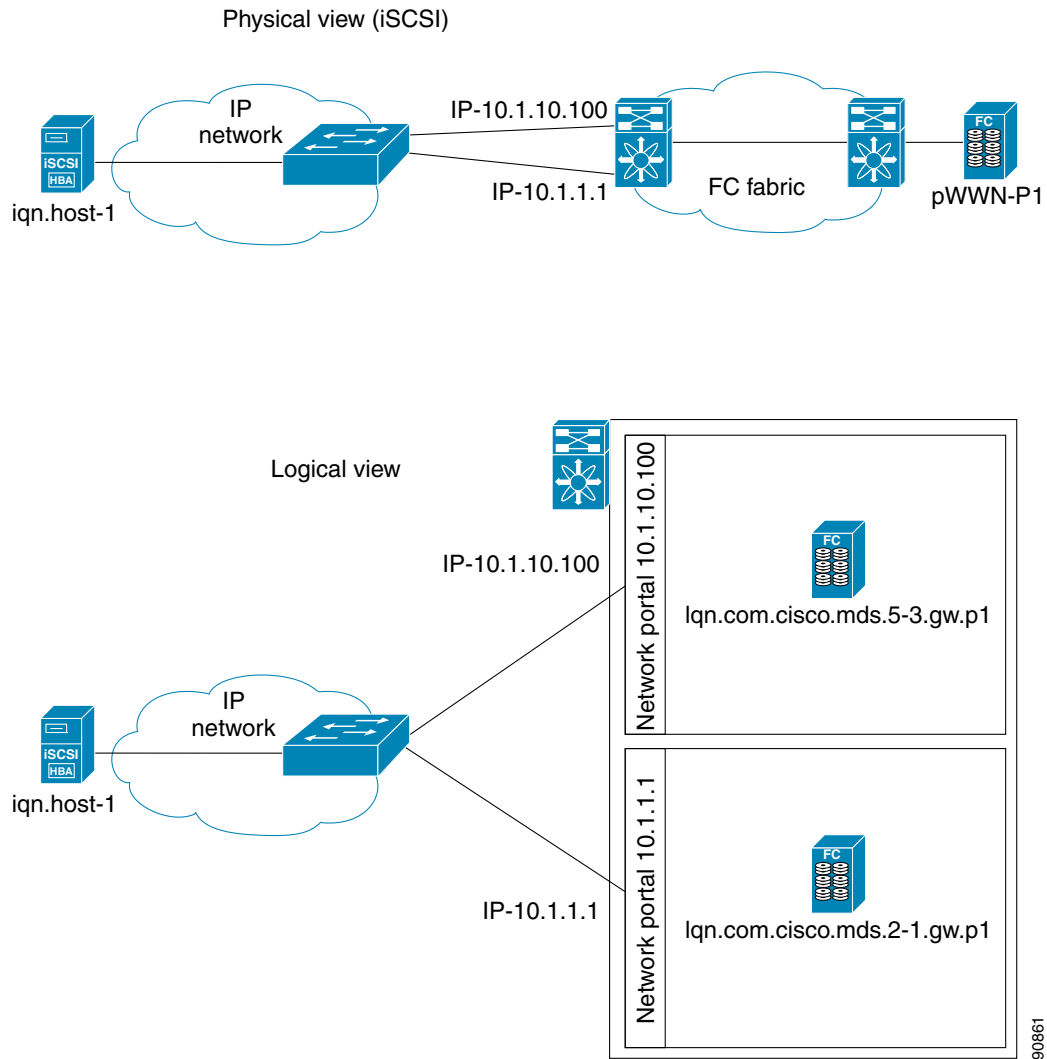

In Figure 4-41, each iSCSI host discovers two iSCSI targets for every physical Fibre Channel target (with different names). The multi-pathing software on the host provides load-balancing over both paths. If one Gigabit Ethernet interface fails, the host multi-pathing software is not affected because it can use the second path.

### VRRP-Based High Availability

Figure 4-42 provides an example of a VRRP-based high availability iSCSI configuration.

Figure 4-42 VRRP-Based iSCSI High Availability

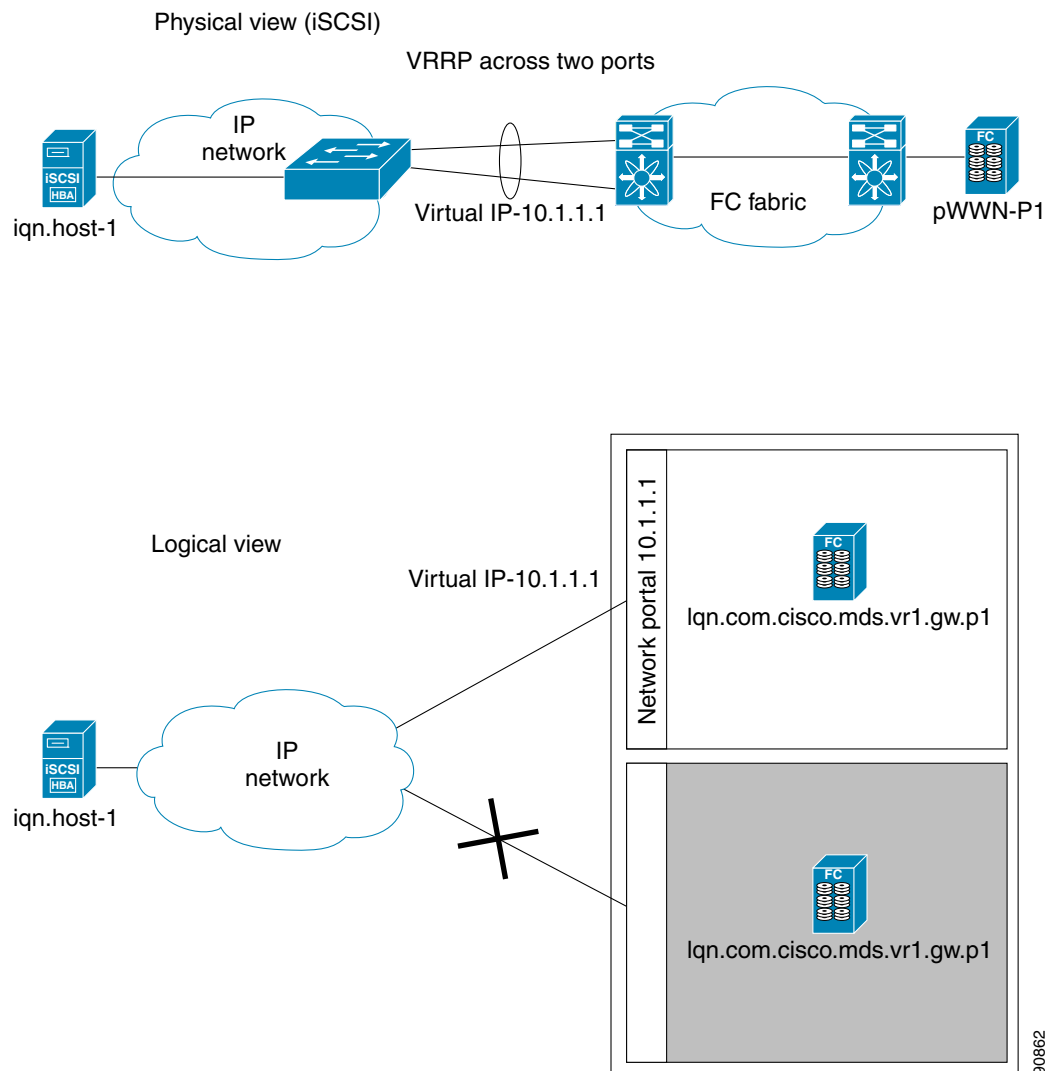

In [Figure 4-42](#), each iSCSI host discovers one iSCSI target for every physical Fibre Channel target. When the Gigabit Ethernet interface of the VRRP master fails, the iSCSI session is terminated. The host then reconnects to the target and the session comes up because the second Gigabit Ethernet interface has taken over the virtual IP address as the new master.

## Ethernet Port Channel-Based High Availability



### Note

All iSCSI data traffic for one iSCSI link is carried on one TCP connection. Consequently, the aggregated bandwidth is 1 Gbps for that iSCSI link.

[Figure 4-43](#) provides a sample Ethernet Port Channel-based high availability iSCSI configuration.

Figure 4-43 Ethernet Port Channel-Based iSCSI High Availability

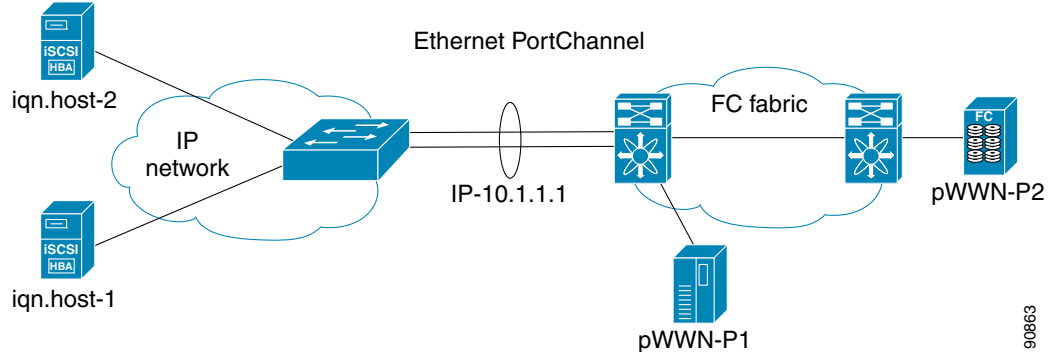

In Figure 4-43, each iSCSI host discovers one iSCSI target for every physical Fibre Channel target. The iSCSI session from the iSCSI host to the iSCSI virtual target (on the IPS port) uses one of the two physical interfaces (because an iSCSI session uses one TCP connection). When the Gigabit Ethernet interface fails, the Fibre Channel module with IPS ports and the Ethernet switch transparently forwards all the frames on to the second Gigabit Ethernet interface.

**Note**

If an Ethernet port channel is configured between the Fibre Channel module with IPS ports and an Ethernet switch, the load balancing policy on the Ethernet switch must be based on source/destination IP address only, not port numbers, for load balancing with VRRP to operate correctly.

## iSCSI Authentication Setup Guidelines and Scenarios

This section provides guidelines on iSCSI authentication possibilities, setup requirements, and sample scenarios. It includes the following authentication setup guidelines:

- [Configuring No Authentication, page 4-180](#)
- [Configuring CHAP with Local Password Database, page 4-181](#)
- [Configuring CHAP with External RADIUS Server, page 4-182](#)
- [iSCSI Transparent Mode Initiator, page 4-184](#)
- [Target Storage Device Requiring LUN Mapping, page 4-192](#)

**Note**

This section does not specify the steps to enter or exit EXEC mode, configuration mode, or any submode. Be sure to verify the prompt before entering any command.

**Caution**

Changing the authentication of an iSCSI interface that is part of an iSLB VRRP group impacts load balancing on the interface. See the [“Changing iSCSI Interface Parameters and the Impact on Load Balancing”](#) section on page 4-163.

## Configuring No Authentication

Set the iSCSI authentication method to **none** to configure a network with no authentication:

In Fabric Manager, choose **End Devices > iSCSI** in the Physical Attributes pane. Then select the **Globals** tab and set the AuthMethod drop-down menu to **none** and click **Apply Changes**.

```
switch(config)# iscsi authentication none
```

## Configuring CHAP with Local Password Database

To configure authentication using the CHAP option with the local password database, follow these steps:

**Step 1** Set the AAA authentication to use the local password database for the iSCSI protocol:

```
switch(config)# aaa authentication iscsi default local
```

**Step 2** Set the iSCSI authentication method to require CHAP for all iSCSI clients:

```
switch(config)# iscsi authentication chap
```

**Step 3** Configure the user names and passwords for iSCSI users:

```
switch(config)# username iscsi-user password abcd iscsi
```



**Note** If you do not specify the **iscsi** option, the user name is assumed to be a Cisco MDS switch user instead of an iSCSI user.

**Step 4** Verify the global iSCSI authentication setup:

```
switch# show iscsi global
iSCSI Global information Authentication: CHAP <----Verify
  Import FC Target: Disabled
.
.
.
```

To configure authentication using the CHAP option with the local password database, follow these steps:

**Step 1** Set the AAA authentication to use the local password database for the iSCSI protocol:

- a. In Fabric Manager, choose **Switches > Security > AAA** in the Physical Attributes pane.
- b. Click the **Applications** tab in the Information pane.
- c. Check the **Local** check box for the iSCSI row and click **Apply Changes**

**Step 2** Set the iSCSI authentication method to require CHAP for all iSCSI clients:

- a. In Fabric Manager, choose **End Devices > iSCSI** in the Physical Attributes pane.
- b. Click the **Globals** tab in the Information pane.
- c. Set the AuthMethod drop-down menu to **chap** and click **Apply Changes**.
- a. **iSCSI** in the Physical Attributes pane.
- b. Click the **Globals** tab in the Information pane.

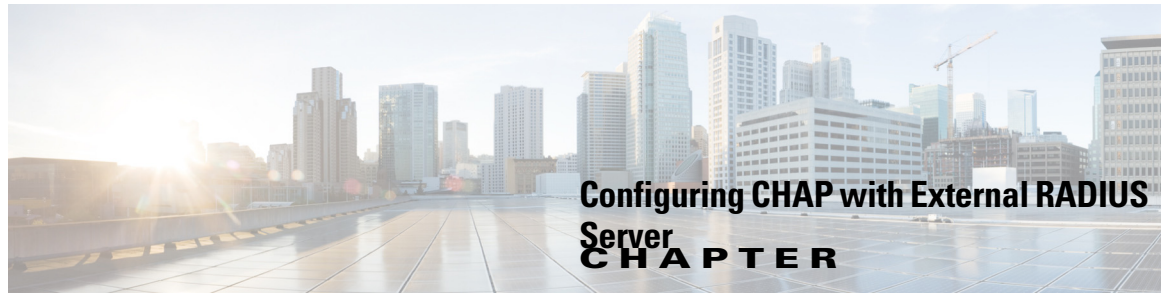

To configure authentication using the CHAP option with an external RADIUS server, follow these steps:

**Step 1** Configure the password for the Cisco MDS switch as RADIUS client to the RADIUS server:

```
switch(config)# radius-server key mds-1
```

**Step 2** Configure the RADIUS server IP address by performing one of the following:

- Configure an IPv4 address:

```
switch(config)# radius-server host 10.1.1.10
```

- Configure an IPv6 address:

```
switch(config)# radius-server host 2001:0DB8:800:200C::417A
```

**Step 3** Configure the RADIUS server group IP address by performing one of the following:

- Configure an IPv4 address:

```
switch(config)# aaa group server radius iscsi-radius-group
switch(config-radius)# server 10.1.1.1
```

- Configure an IPv6 address:

```
switch(config)# aaa group server radius iscsi-radius-group
switch(config-radius)# server 001:0DB8:800:200C::4180
```

```
switch(config)# aaa authentication iscsi default group iscsi-radius-group
```

**Step 4** Set up the iSCSI authentication method to require CHAP for all iSCSI clients:

```
switch(config)# iscsi authentication chap
```

**Step 5** Verify that the global iSCSI authentication setup is for CHAP:

```
switch# show iscsi global
iSCSI Global information
  Authentication: CHAP          <----- Verify CHAP
.
.
.
```

**Step 6** Verify that the AAA authentication information is for iSCSI"

```
switch# show aaa authentication
default: local
console: local
iscsi: group iscsi-radius-group  <----- Group name
dhchap: local
```

```
switch# show radius-server groups
total number of groups:2
```

```
following RADIUS server groups are configured:
group radius:
```

```

server: all configured radius servers
group iscsi-radius-group:
server: 10.1.1.1 on auth-port 1812, acct-port 1813

switch# show radius-server
Global RADIUS shared secret:mds-1    <----- Verify secret
.
.
.

following RADIUS servers are configured:
10.1.1.1:                               <----- Verify the server IPv4 address
available for authentication on port:1812
available for accounting on port:1813

```

**Step 1** Configure the password for the Cisco MDS switch as RADIUS client to the RADIUS server:

- a. In Fabric Manager, choose **Switches > Security > AAA > RADIUS** in the Physical Attributes pane.
- b. Click the **Default** tab in the Information pane.
- c. Set the AuthKey field to the default password and click the **Apply Changes** icon.

**Step 2** Configure the RADIUS server IP address:

- a. In Fabric Manager, choose **Switches > Security > AAA > RADIUS** in the Physical Attributes pane.
- b. Click the **Server** tab in the Information pane and click **Create Row**.
- c. Set the Index field to a unique number.
- d. Set the IP Type radio button to **ipv4** or **ipv6**.
- e. Set the Name or IP Address field to the IP address of the RADIUS server and click **Create**.

**Step 3** Create a RADIUS server group and add the RADIUS server to the group:

- a. In Fabric Manager, choose **Switches > Security > AAA** in the Physical Attributes pane.
- b. Select the **Server Groups** tab in the Information pane and click **Create Row**.
- c. Set the Index field to a unique number.
- d. Set the Protocol radio button to **radius**.
- e. Set the Name field to the server group name.
- f. Set the ServerIDList to the index value of the RADIUS server (as created in [Step 2 c.](#)) and click **Create**.

**Step 4** Set up the authentication verification for the iSCSI protocol to go to the RADIUS server.

- a. In Fabric Manager, choose **Switches > Security > AAA** in the Physical Attributes pane.
- b. Click the **Applications** tab in the Information pane.
- c. Right-click on the iSCSI row in the Type, SubType, Function column.
- d. Set the ServerGroup IDList to the index value of the Server Group (as created in [Step 3 c.](#)) and click **Create**.

**Step 5** Set up the iSCSI authentication method to require CHAP for all iSCSI clients.

- a. In Fabric Manager, choose **End Devices > iSCSI** in the Physical Attributes pane.
- b. Select **chap** from the AuthMethod drop-down menu.
- c. Click the **Apply Changes** icon.

**Step 6** In Fabric Manager, choose **End Devices > iSCSI** in the Physical Attributes pane.

- Step 7** Click the **Globals** tab in the Information pane to verify that the global iSCSI authentication setup is for CHAP.
  - Step 8** In Fabric Manager, choose **Switches > Security > AAA** in the Physical Attributes pane.
  - Step 9** Click the **Applications** tab in the Information pane to verify the AAA authentication information for iSCSI.
- 

To configure an iSCSI RADIUS server, follow these steps:

- Step 1** Configure the RADIUS server to allow access from the Cisco MDS switch's management Ethernet IP address.
  - Step 2** Configure the shared secret for the RADIUS server to authenticate the Cisco MDS switch.
  - Step 3** Configure the iSCSI users and passwords on the RADIUS server.
- 

## iSCSI Transparent Mode Initiator

This scenario assumes the following configuration (see [Figure 4-44](#)):

- No LUN mapping or LUN masking or any other access control for hosts on the target device
- No iSCSI login authentication (that is, login authentication set to none)
- The topology is as follows:
  - iSCSI interface 7/1 is configured to identify initiators by IP address.
  - iSCSI interface 7/5 is configured to identify initiators by node name.
  - The iSCSI initiator host 1 with IPv4 address 10.11.1.10 and name iqn.1987-05.com.cisco:01.255891611111 connects to IPS port 7/1 is identified using IPv4 address (host 1 = 10.11.1.10).
  - The iSCSI initiator host 2 with IPv4 address 10.15.1.10 and node name iqn.1987-05.com.cisco:01.25589167f74c connects to IPS port 7/5.

Figure 4-44 iSCSI Scenario 1

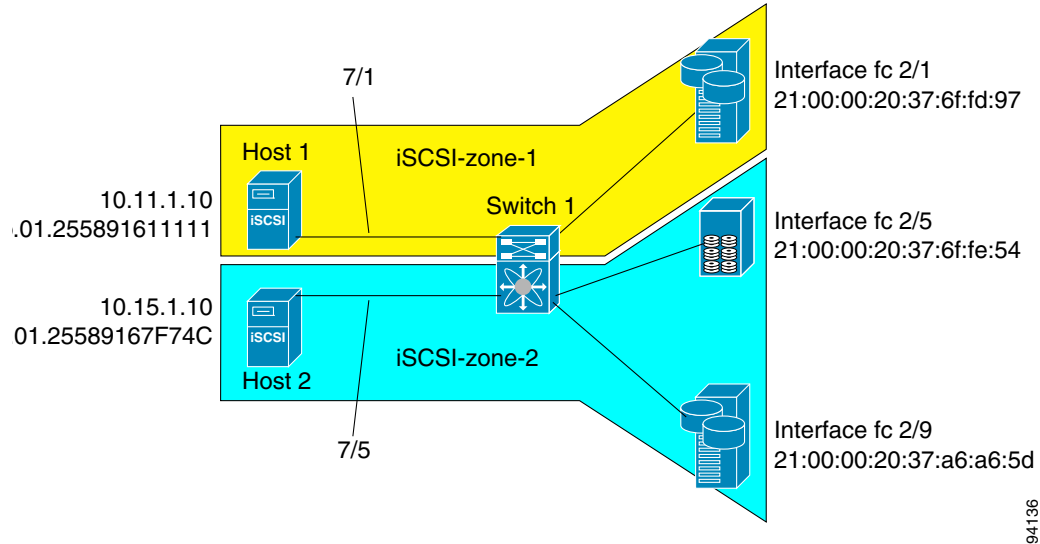

94136

To configure scenario 1 (see Figure 4-44), follow these steps:

**Step 1** Configure null authentication for all iSCSI hosts in Cisco MDS switches:

```
switch(config)# iscsi authentication none
```

**Step 2** Configure iSCSI to dynamically import all Fibre Channel targets into the iSCSI SAN using auto-generated iSCSI target names:

```
switch(config)# iscsi import target fc
```

**Step 3** Configure the Gigabit Ethernet interface in slot 7 port 1 with an IPv4 address and enable the interface:

```
switch(config)# interface gigabitethernet 7/1
switch(config-if)# ip address 10.11.1.1 255.255.255.0
switch(config-if)# no shutdown
```



**Note** Host 2 is connected to this port.

**Step 4** Configure the iSCSI interface in slot 7 port 1 to identify all dynamic iSCSI initiators by their IP address, and enable the interface:

```
switch(config)# interface iscsi 7/1
switch(config-if)# switchport initiator id ip-address
switch(config-if)# no shut
```

**Step 5** Configure the Gigabit Ethernet interface in slot 7 port 5 with the IPv4 address and enable the interface:

```
switch(config)# interface gigabitethernet 7/5
switch(config-if)# ip address 10.15.1.1 255.255.255.0
switch(config-if)# no shutdown
```

**Step 6** Configure the iSCSI interface in slot 7 port 5 to identify all dynamic iSCSI initiators by node name and enable the interface:

```
switch(config)# interface iscsi 7/5
switch(config-if)# switchport initiator id name
switch(config-if)# no shutdown
```



**Note** Host 1 is connected to this port.

**Step 7** Verify the available Fibre Channel targets (see [Figure 4-44](#)):

```
switch# show fcns database
VSAN 1:
```

FCID	TYPE	PWWN	(VENDOR)	FC4-TYPE:FEATURE
0x6d0001	NL	21:00:00:20:37:6f:fd:97	(Seagate)	scsi-fcp:target
0x6d0101	NL	21:00:00:20:37:6f:fe:54	(Seagate)	scsi-fcp:target
0x6d0201	NL	21:00:00:20:37:a6:a6:5d	(Seagate)	scsi-fcp:target

Total number of entries = 3

**Step 8** Create a zone named *iscsi-zone-1* with host 1 and one Fibre Channel target in it:



**Note** Use the IP address of the host in zone membership configuration because the iSCSI interface is configured to identify all hosts based on IP address.

```
switch(config)# zone name iscsi-zone-1 vsan 1
switch(config-zone)# member pwn 21:00:00:20:37:6f:fd:97
switch(config-zone)# member ip-address 10.11.1.10
```

**Step 9** Create a zone named *iscsi-zone-2* with host 2 and two Fibre Channel targets in it:



**Note** Use the symbolic node name of the iSCSI host in zone membership configuration because the iSCSI interface is configured to identify all hosts based on node name.

```
switch(config)# zone name iscsi-zone-2 vsan 1
switch(config-zone)# member pwn 21:00:00:20:37:6f:fe:54
switch(config-zone)# member pwn 21:00:00:20:37:a6:a6:5d
switch(config-zone)# member symbolic-nodename iqn.1987-05.com.cisco:01.25589167f74c
```

**Step 10** Create a zone set and add the two zones as members:

```
switch(config)# zoneset name zoneset-iscsi vsan 1
switch(config-zoneset)# member iscsi-zone-1
switch(config-zoneset)# member iscsi-zone-2
```

**Step 11** Activate the zone set:

```
switch(config)# zoneset activate name zoneset-iscsi vsan 1
```

**Step 12** Display the active zone set:



**Note** The iSCSI hosts are not connected so they do not have an FC ID yet.

```
switch# show zoneset active
zoneset name zoneset-iscsi vsan 1
  zone name iscsi-zone-1 vsan 1
    * fcid 0x6d0001 [pwn 21:00:00:20:37:6f:fd:97] <-----Target
      symbolic-nodename 10.11.1.10 <-----iSCSI host (host 1, not online)

  zone name iscsi-zone-2 vsan 1
    * fcid 0x6d0101 [pwn 21:00:00:20:37:6f:fe:54] <-----Target
```

```
* fcid 0x6d0201 [pwwn 21:00:00:20:37:a6:a6:5d] <-----Target
symbolic-nodename iqn.1987-05.com.cisco:01.25589167f74c <-iSCSI host (host 2, not online)
```

**Step 13** Bring up the iSCSI hosts (host 1 and host 2).

**Step 14** Show all the iSCSI sessions (use the **detail** option for detailed information):

```
switch# show iscsi session
Initiator iqn.1987-05.com.cisco:01.25589167f74c <-----Host 2
Initiator ip addr (s): 10.15.1.11
Session #1
Target iqn.1987-05.com.cisco:05.172.22.92.166.07-05.21000020376ffe54
```



**Note** The last part of the auto-created target name is the Fibre Channel target's pWWN.

```
VSAN 1, ISID 00023d000001, Status active, no reservation
```

```
Session #2
```

```
Target iqn.1987-05.com.cisco:05.172.22.92.166.07-05.2100002037a6a65d
VSAN 1, ISID 00023d000001, Status active, no reservation
```

```
Initiator 10.11.1.10 <-----Host 1
```

```
Initiator name iqn.1987-05.com.cisco:01.e41695d16b1a
```

```
Session #1
```

```
Target iqn.1987-05.com.cisco:05.172.22.92.166.07-01.21000020376ffd97
VSAN 1, ISID 00023d000001, Status active, no reservation
```

**Step 15** Verify the details of the two iSCSI initiators:

```
switch# show iscsi initiator
iSCSI Node name is iqn.1987-05.com.cisco:01.25589167f74c <-----
Initiator ip addr (s): 10.15.1.11
iSCSI alias name: oasis11.cisco.com
Node WWN is 20:02:00:0b:fd:44:68:c2 (dynamic)
Member of vsans: 1
Number of Virtual n_ports: 1
Virtual Port WWN is 20:03:00:0b:fd:44:68:c2 (dynamic)
Interface iSCSI 7/5, Portal group tag: 0x304
VSAN ID 1, FCID 0x6d0300

iSCSI Node name is 10.11.1.10 <-----
iSCSI Initiator name: iqn.1987 - 05.com.cisco:01.e41695d16b1a
iSCSI alias name: oasis10.cisco.com
Node WWN is 20:04:00:0b:fd:44:68:c2 (dynamic)
Member of vsans: 1
Number of Virtual n_ports: 1
Virtual Port WWN is 20:05:00:0b:fd:44:68:c2 (dynamic)
Interface iSCSI 7/1, Portal group tag: 0x300
VSAN ID 1, FCID 0x6d0301
```

**Host 2: Initiator ID based on node name because the initiator is entering iSCSI interface 7/5**

**Host 1: Initiator ID based on IPv4 address because the initiator is entering iSCSI interface 7/1**

**Step 16** View the active zone set. The iSCSI initiators' FC IDs are resolved:

```
switch# show zoneset active
zoneset name zoneset-iscsi vsan 1
  zone name iscsi-zone-1 vsan 1
    * fcid 0x6d0001 [pwwn 21:00:00:20:37:6f:fd:97]
    * fcid 0x6d0301 [symbolic-nodename 10.11.1.10] <-----

  zone name iscsi-zone-2 vsan 1
    * fcid 0x6d0101 [pwwn 21:00:00:20:37:6f:fe:54]
    * fcid 0x6d0201 [pwwn 21:00:00:20:37:a6:a6:5d]
    * fcid 0x6d0300 [symbolic-nodename
iqn.1987-05.com.cisco:01.25589167f74c] <-----
```

**FC ID resolved for host 1**

**FC ID for host 2**

**Step 17** The Fibre Channel name server shows the virtual N ports created for the iSCSI hosts:

```
switch# show fcns database
VSAN 1:
-----
FCID          TYPE  PWWN                               (VENDOR)          FC4-TYPE:FEATURE
-----
0x6d0001      NL    21:00:00:20:37:6f:fd:97 (Seagate)         scsi-fcp:target
0x6d0101      NL    21:00:00:20:37:6f:fe:54 (Seagate)         scsi-fcp:target
0x6d0201      NL    21:00:00:20:37:a6:a6:5d (Seagate)         scsi-fcp:target
0x6d0300      N     20:03:00:0b:fd:44:68:c2 (Cisco)           scsi-fcp:init isc..w
0x6d0301      N     20:05:00:0b:fd:44:68:c2 (Cisco)           scsi-fcp:init isc..w
```

**Step 18** Verify the detailed output of the iSCSI initiator nodes in the Fibre Channel name server:

```
switch# show fcns database fcid 0x6d0300 detail vsan 1
-----
VSAN:1      FCID:0x6d0300
-----
port-wwn (vendor)      :20:03:00:0b:fd:44:68:c2 (Cisco)
node-wwn               :20:02:00:0b:fd:44:68:c2
class                  :2,3
node-ip-addr           :10.15.1.11 <-----
ipa                    :ff ff ff ff ff ff ff ff
fc4-types:fc4_features:scsi-fcp:init iscsi-gw <-----
symbolic-port-name     :

symbolic-node-name
:iqn.1987-05.com.cisco:01.25589167f74c<-----
port-type              :N
port-ip-addr           :0.0.0.0
fabric-port-wwn        :21:91:00:0b:fd:44:68:c0
hard-addr              :0x000000
Total number of entries = 1
```

**IPv4 address of the  
iSCSI host**

**iSCSI gateway node**

**iSCSI initiator ID is  
based on the registered  
node name**

```
switch# show fcns database fcid 0x6d0301 detail vsan 1
-----
VSAN:1      FCID:0x6d0301
-----
port-wwn (vendor)      :20:05:00:0b:fd:44:68:c2 (Cisco)
node-wwn               :20:04:00:0b:fd:44:68:c2
class                  :2,3
node-ip-addr           :10.11.1.10
ipa                    :ff ff ff ff ff ff ff ff
fc4-types:fc4_features:scsi-fcp:init iscsi-gw <-----
symbolic-port-name     :

symbolic-node-name     :10.11.1.10 <-----
port-type              :N
port-ip-addr           :0.0.0.0
fabric-port-wwn        :21:81:00:0b:fd:44:68:c0
hard-addr              :0x000000
```

**iSCSI gateway node**

**iSCSI initiator ID is  
based on the IPv4  
address registered in  
symbolic-node-name  
field**

To configure scenario 1 (see [Figure 4-44](#)), follow these steps:

**Step 1** Configure null authentication for all iSCSI hosts in Cisco MDS switches.

- In Fabric Manager, choose **End Devices > iSCSI** in the Physical Attributes pane.
- Select **none** from the AuthMethod drop-down menu in the Information pane.
- Click the **Apply Changes** icon.

**Step 2** Configure iSCSI to dynamically import all Fibre Channel targets into the iSCSI SAN using auto-generated iSCSI target names.

- In Device Manager, click **IP > iSCSI**.
- Click the **Targets** tab.
- Check the **Dynamically Import FC Targets** check box.

d. Click **Apply**.

**Step 3** Configure the Gigabit Ethernet interface in slot 7 port 1 with an IPv4 address and enable the interface.

- a. In Fabric Manager, choose **Switches > Interfaces > Gigabit Ethernet** in the Physical Attributes pane.
- b. Select the **IP Address** tab in the Information pane and click **Create Row**.
- c. Set the IP address and subnet mask for the Gigabit Ethernet interface in slot 7 port 1.
- d. Click **Create**.
- e. Select the **General** tab and select **up** from the Admin drop-down menu for the Gigabit Ethernet interface in slot 7 port 1.
- f. Click the **Apply Changes** icon.



---

**Note** Host 2 is connected to this port.

---

**Step 4** Configure the iSCSI interface in slot 7 port 1 to identify all dynamic iSCSI initiators by their IP address, and enable the interface.

- a. In Fabric Manager, choose **Switches > Interfaces > FC Logical** in the Physical Attributes pane.
- b. Click the **iSCSI** tab in the Information pane.
- c. Select **ipaddress** from the Initiator ID Mode drop-down menu and click the **Apply Changes** icon.
- d. In Device Manager, choose **Interfaces > Ethernet and iSCSI**.
- e. Click the **iSCSI** tab.
- f. Select **up** from the Admin drop-down menu for the iSCSI interface in slot 7 port 1.
- g. Click **Apply**.

**Step 5** Configure the Gigabit Ethernet interface in slot 7 port 5 with an IPv4 address and enable the interface.

- a. In Fabric Manager, choose **Switches > Interfaces > Gigabit Ethernet** in the Physical Attributes pane.
- b. Click the **IP Address** tab in the Information pane and click **Create Row**.
- c. Set the IP address and subnet mask for the Gigabit Ethernet interface in slot 7 port 5.
- d. Click **Create**.
- e. Select the **General** tab and select **up** from the Admin drop-down menu for the Gigabit Ethernet interface in slot 7 port 5.
- f. Click the **Apply Changes** icon.

**Step 6** Configure the iSCSI interface in slot 7 port 5 to identify all dynamic iSCSI initiators by node name and enable the interface.

- a. In Fabric Manager, choose **Switches > Interfaces > FC Logical** in the Physical Attributes pane.
- b. Click the **iSCSI** tab in the Information pane.
- c. Select **name** from the Initiator ID Mode drop-down menu and click the **Apply Changes** icon.
- d. In Device Manager, choose **Interfaces > Ethernet and iSCSI**.
- e. Click the **iSCSI** tab.
- f. Select **up** from the Admin drop-down menu for the iSCSI interface in slot 7 port 5.
- g. Click **Apply**.



---

**Note** Host 1 is connected to this port.

---

**Step 7** Verify the available Fibre Channel targets.

- a. In Device Manager, Choose **FC > Name Server**.
- b. Click the **General** tab.

**Step 8** Create a zone named *iscsi-zone-1* with host 1 and one Fibre Channel target in it.



**Note** Use the IP address of the host in zone membership configuration because the iSCSI interface is configured to identify all hosts based on IP address.

- a. In Fabric Manager, choose **Zones > Edit Local Full Zone Database**.
- b. Select VSAN 1 from the VSAN drop-down menu in the Edit Local Full Zone Database dialog box.
- c. Select the **Zones** folder in the left navigation pane and click **Insert**.
- d. Set the Zone Name field to **iscsi-zone-1** and click **OK**.
- e. Select the *iscsi-zone-1* folder in the left navigation pane and click **Insert**.
- f. Set the ZoneBy radio button to **WWN**.
- g. Set the Port WWN to the pWWN for the Fibre Channel target (that is, 21:00:00:20:37:6f:fd:97) and click **Add**.
- h. Set the ZoneBy radio button to **iSCSI IP Address/Subnet**.
- i. Set the IP Address/Mask field to the IP Address for Host 1 iSCSI initiator (10.11.1.10) and click **Add**.

**Step 9** Create a zone named *iscsi-zone-2* with host 2 and two Fibre Channel targets in it.



**Note** Use the symbolic node name of the iSCSI host in zone membership configuration because the iSCSI interface is configured to identify all hosts based on node name.

- a. In Fabric Manager, choose **Zones > Edit Local Full Zone Database** from the main menu.
- b. Select VSAN 2 from the VSAN drop-down menu in the Edit Local Full Zone Database dialog box.
- c. Select the **Zones** folder in the left navigation pane and click **Insert**.
- d. Set the Zone Name field to **iscsi-zone-2** and click **OK**.
- e. Select the **iscsi-zone-2** folder in the left navigation pane and click **Insert**.
- f. Set the ZoneBy radio button to **WWN**.
- g. Set the Port WWN to the pWWN for one of the Fibre Channel targets (for example, 21:00:00:20:37:6f:fe:5). and click **Add**.
- h. Set the Port WWN to the pWWN for another of the Fibre Channel targets (for example, 21:00:00:20:37:a6:a6:5d). and click **Add**.
- i. Set the ZoneBy radio button to **iSCSI name**.
- j. Set the Port Name field to the symbolic name for host 2 (iqn.1987-05.com.cisco:01.25589167f74c) and click **Add**.

**Step 10** Create a zone set, add the two zones as members, and activate the zone set.



**Note** iSCSI interface is configured to identify all hosts based on node name.

- a. In Fabric Manager, choose **Zones > Edit Local Full Zone Database**.
- b. Select VSAN 1 from the VSAN drop-down menu in the Edit Local Full Zone Database dialog box.
- c. Select the **Zoneset** folder in the left navigation pane and click **Insert**.

- d. Set the Zoneset Name to **zonset-iscsi** and click **OK**.
  - e. Click on the **zoneset-iscsi** folder and click **Insert**.
  - f. Set the Zone Name field to **iscsi-zone-1** and click **OK**.
  - g. Set the Zone Name field to **iscsi-zone-2** and click **OK**.
  - h. Click **Activate** to activate the new zone set.
  - i. Click **Continue Activation** to finish the activation.
    - Step 11** Bring up the iSCSI hosts (host 1 and host 2).
    - Step 12** Show all the iSCSI sessions.
  - a. In Device Manager, choose **Interfaces > Monitor > Ethernet**.
  - b. Click the **iSCSI connections** tab to show all the iSCSI sessions.
  - c. In Device Manager, choose **IP > iSCSI** and select the **Session Initiators** tab.
  - d. Click **Details**.
    - Step 13** In Fabric Manager, choose **End Devices > iSCSI** in the Physical Attributes pane to verify the details of the two iSCSI initiators
    - Step 14** In Fabric Manager, choose **Zones > Edit Local Full Zone Database** to view the active zone set. The iSCSI initiators' FC IDs are resolved.
    - Step 15** In Device Manager, Choose **FC > Name Server**. The Fibre Channel name server shows the virtual N ports created for the iSCSI hosts.
    - Step 16** In Device Manager, Choose **FC > Name Server**.
    - Step 17** Click the **Advanced** tab. Verify the detailed output of the iSCSI initiator nodes in the Fibre Channel name server.
- 

## Target Storage Device Requiring LUN Mapping

Sample scenario 2 assumes the following configuration (see [Figure 4-45](#)):

- Access control is based on Fibre Channel zoning.
- There is target-based LUN mapping or LUN masking.
- There is no iSCSI authentication (none).
- The iSCSI initiator is assigned to different VSANs.

Figure 4-45 iSCSI Scenario 2

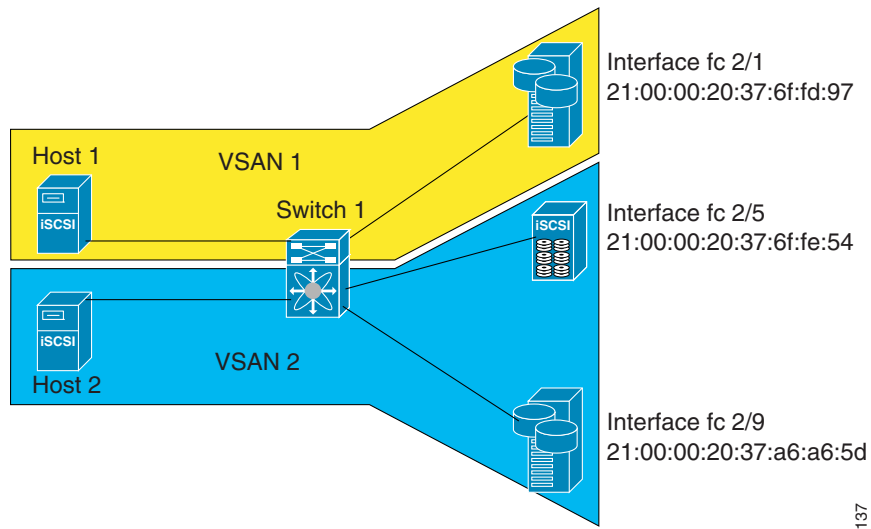

94137

To configure scenario 2 (see [Figure 4-45](#)), follow these steps:

**Step 1** Configure null authentication for all iSCSI hosts:

```
switch(config)# iscsi authentication none
```

**Step 2** Configure iSCSI to dynamically import all Fibre Channel targets into the iSCSI SAN using auto-generated iSCSI target names:

```
switch(config)# iscsi import target fc
```

**Step 3** Configure the Gigabit Ethernet interface in slot 7 port 1 with an IPv4 address and enable the interface:

```
switch(config)# interface gigabitethernet 7/1
switch(config-if)# ip address 10.11.1.1 255.255.255.0
switch(config-if)# no shutdown
```

**Step 4** Configure the iSCSI interface in slot 7 port 1 to identify all dynamic iSCSI initiators by their IP address and enable the interface:

```
switch(config)# interface iscsi 7/1
switch(config-if)# switchport initiator id ip-address
switch(config-if)# no shutdown
```

**Step 5** Configure the Gigabit Ethernet interface in slot 7 port 5 with the IPv4 address and enable the interface:

```
switch(config)# interface gigabitethernet 7/5
switch(config-if)# ip address 10.15.1.1 255.255.255.0
switch(config-if)# no shutdown
```

**Step 6** Configure the iSCSI interface in slot 7 port 5 to identify all dynamic iSCSI initiators by IP address and enable the interface:

```
switch(config)# interface iscsi 7/5
switch(config-if)# switchport initiator id ip-address
switch(config-if)# no shutdown
```

**Step 7** Add static configuration for each iSCSI initiator:

```
switch(config)# iscsi initiator name iqn.1987-05.com.cisco:01.e41695d16b1a <-----Host 2
```

```
switch(config-iscsi-init)# static pWWN system-assign 1
switch(config-iscsi-init)# static nWWN system-assign

switch(config)# iscsi initiator ip address 10.15.1.11 <-----Host 1
switch(config-iscsi-init)# static pwwn system-assigned 1
switch(config-iscsi-init)# vsan 2
```



---

**Note** Host 1 is configured in VSAN 2.

---

**Step 8** View the configured WWNs:



---

**Note** The WWNs are assigned by the system. The initiators are members of different VSANs.

---

```
switch# show iscsi initiator configured
iSCSI Node name is iqn.1987-05.com.cisco:01.e41695d16b1a
  Member of vsans: 1
  Node WWN is 20:03:00:0b:fd:44:68:c2
  No. of PWWN: 1
  Port WWN is 20:02:00:0b:fd:44:68:c2

iSCSI Node name is 10.15.1.11
  Member of vsans: 2
  No. of PWWN: 1
  Port WWN is 20:06:00:0b:fd:44:68:c2
```

**Step 9** Create a zone with host 1:

```
switch(config)# zone name iscsi-zone-1 vsan 1
```

**Step 10** Add three members to the zone named *iscsi-zone-1*:



---

**Note** Fibre Channel storage for zone membership for the iSCSI initiator, either the iSCSI symbolic node name or the pWWN, can be used. In this case, the pWWN is persistent.

---

- The following command is based on the symbolic node name.

```
switch(config-zone)# member symbolic-nodename iqn.1987-05.com.cisco:01.e41695d16b1a
```

- The following command is based on the persistent pWWN assigned to the initiator. You can obtain the pWWN from the **show iscsi initiator** output.

```
switch(config-zone)# member pwwn 20:02:00:0b:fd:44:68:c2
```

**Step 11** Create a zone with host 2 and two Fibre Channel targets:



---

**Note** If the host is in VSAN 2, the Fibre Channel targets and zone must also be in VSAN 2.

---

```
switch(config)# zone name iscsi-zone-2 vsan 2
```

**Step 12** Activate the zone set in VSAN 2:

```
switch(config)# zoneset activate name iscsi-zoneset-v2 vsan 2
Zoneset activation initiated. check zone status
switch# show zoneset active vsan 2
zoneset name iscsi-zoneset-v2 vsan 2
  zone name iscsi-zone-2 vsan 2
```

```
* fcid 0x750001 [pwwn 21:00:00:20:37:6f:fe:54]
* fcid 0x750101 [pwwn 21:00:00:20:37:a6:a6:5d]
pwwn 20:06:00:0b:fd:44:68:c2 <-----Host is not online
```

**Step 13** Start the iSCSI clients on both hosts and verify that sessions come up.

**Step 14** Display the iSCSI sessions to verify the Fibre Channel target and the configured WWNs.

```
switch# show iscsi session
Initiator iqn.1987-05.com.cisco:01.e41695d16b1a
  Initiator ip addr (s): 10.11.1.10
  Session #1
    Discovery session, ISID 00023d000001, Status active

  Session #2
    Target
iqn.1987-05.com.cisco:05.172.22.92.166.07-01.21000020376ffd97<---- To Fibre Channel target
  VSAN 1, ISID 00023d000001, Status active, no reservation
```

**Step 15** Display the iSCSI initiator to verify the configured nWWN and pWWN:

```
switch# show iscsi initiator
iSCSI Node name is iqn.1987-05.com.cisco:01.e41695d16b1a
  Initiator ip addr (s): 10.11.1.10
  iSCSI alias name: oasis10.cisco.com

  Node WWN is 20:03:00:0b:fd:44:68:c2 (configured)<----- The configured nWWN
  Member of vsans: 1
  Number of Virtual n_ports: 1

  Virtual Port WWN is 20:02:00:0b:fd:44:68:c2 (configured)<---- The configured pWWN
  Interface iSCSI 7/1, Portal group tag: 0x300
  VSAN ID 1, FCID 0x680102
```

**Step 16** Check the Fibre Channel name server:

```
switch# show fcns database vsan 1
VSAN 1:
-----
FCID      TYPE PWWN                               (VENDOR)  FC4-TYPE:FEATURE
-----
0x680001 NL   21:00:00:20:37:6f:fd:97 (Seagate) scsi-fcp:target
0x680102 N    20:02:00:0b:fd:44:68:c2 (Cisco)   scsi-fcp:init iscw <--- iSCSI initiator in name server
```

**Step 17** Verify the details of the iSCSI initiator's FC ID in the name server:

```
switch(config)# show fcns database fcid 0x680102 detail vsan 1
-----
VSAN:1      FCID:0x680102
-----
port-wwn (vendor)      :20:02:00:0b:fd:44:68:c2 (Cisco)
node-wwn                :20:03:00:0b:fd:44:68:c2
class                   :2,3
node-ip-addr            :10.11.1.10
ipa                     :ff ff ff ff ff ff ff ff
fc4-types:fc4_features:scsi-fcp:init iscsi-gw
symbolic-port-name      :
symbolic-node-name      :iqn.1987-05.com.cisco:01.e41695d16b1a
port-type                :N
port-ip-addr            :0.0.0.0
fabric-port-wwn         :21:81:00:0b:fd:44:68:c0
iSCSI alias name:      oasis10.cisco.com
```

**Step 18** Check the Fibre Channel name server:

```
switch# show fcns database vsan 1
VSAN 1:
-----
FCID      TYPE  PWWN                                (VENDOR) FC4-TYPE:FEATURE
-----
0x680001  NL   21:00:00:20:37:6f:fd:97 (Seagate) scsi-fcp:target
0x680102  N    20:02:00:0b:fd:44:68:c2 (Cisco)   scsi-fcp:init isc..w<----- iSCSI
initiator in
name server
```

**Step 19** Verify the details of the iSCSI initiator's FC ID in the name server:

```
switch(config)# show fcns database fcid 0x680102 detail vsan 1
-----
VSAN:1      FCID:0x680102
-----
port-wwn (vendor)      :20:02:00:0b:fd:44:68:c2 (Cisco)
node-wwn                :20:03:00:0b:fd:44:68:c2
class                   :2,3
node-ip-addr            :10.11.1.10
ipa                     :ff ff ff ff ff ff ff ff
fc4-types:fc4_features:scsi-fcp:init iscsi-gw
symbolic-port-name      :
symbolic-node-name      :iqn.1987-05.com.cisco:01.e41695d16b1a
port-type                :N
port-ip-addr            :0.0.0.0
fabric-port-wwn         :21:81:00:0b:fd:44:68:c0
hard-addr               :0x000000
```

**Step 20** Verify that zoning has resolved the FC ID for the iSCSI client:

```
switch# show zoneset active vsan 1
zoneset name iscsi-zoneset-v1 vsan 1
  zone name iscsi-zone-1 vsan 1
    * fcid 0x680001 [pwwn 21:00:00:20:37:6f:fd:97]
    * fcid 0x680102 [pwwn 20:02:00:0b:fd:44:68:c2]
```

**Step 21** Verify that the second initiator is connected to the two Fibre Channel targets in VSAN 2:

```

switch# show iscsi session initiator 10.15.1.11
Initiator 10.15.1.11
  Initiator name ign.1987-05.com.cisco:01.25589167f74c
  Session #1
    Target ign.1987-05.com.cisco:05.172.22.92.166.07-05.21000020376ffe54 <-- Session to
    VSAN 2, ISID 00023d000001, Status active, no reservation                first target

  Session #2
    Target ign.1987-05.com.cisco:05.172.22.92.166.07-05.2100002037a6a65d <-- Session to
    VSAN 2, ISID 00023d000001, Status active, no reservation                second
                                                                              target

switch# show iscsi initiator
iSCSI Node name is 10.15.1.11 <--- Initiator ID is the IP address
  iSCSI Initiator name: ign.1987-05.com.cisco:01.25589167f74c
  iSCSI alias name: oasis11.cisco.com

  Node WWN is 20:04:00:0b:fd:44:68:c2 (dynamic) <----- Dynamic
  Member of vsans: 2 <--- vsan membership                    WWN as
  Number of Virtual n_ports: 1                                static WWN
                                                                              not
                                                                              assigned

  Virtual Port WWN is 20:06:00:0b:fd:44:68:c2 (configured) <----- Static
  Interface iSCSI 7/5, Portal group tag: 0x304                pWWN for
  VSAN ID 2, FCID 0x750200                                    the initiator

switch# show fcns database vsan 2
VSAN 2:
-----
FCID          TYPE  PWWN                               (VENDOR)  FC4-TYPE:FEATURE
-----
0x750001      NL    21:00:00:20:37:6f:fe:54 (Seagate) scsi-fcp:target
0x750101      NL    21:00:00:20:37:a6:a6:5d (Seagate) scsi-fcp:target

0x750200      N     20:06:00:0b:fd:44:68:c2 (Cisco)  scsi-fcp:init isc..w <-- iSCSI
Total number of entries = 3                                                initiator
                                                                              entry in
                                                                              name server

switch# show fcns database fcid 0x750200 detail vsan 2
-----
VSAN:2      FCID:0x750200
-----
port-wwn (vendor)      :20:06:00:0b:fd:44:68:c2 (Cisco)
node-wwn               :20:04:00:0b:fd:44:68:c2
class                  :2,3
node-ip-addr           :10.15.1.11
ipa                    :ff ff ff ff ff ff ff ff
fc4-types:fc4_features:scsi-fcp:init iscsi-gw
symbolic-port-name     :
symbolic-node-name     :10.15.1.11
port-type              :N
port-ip-addr           :0.0.0.0
fabric-port-wwn        :21:91:00:0b:fd:44:68:c0
hard-addr              :0x000000
Total number of entries = 1

```

```

switch# show zoneset active vsan 2
zoneset name iscsi-zoneset-v2 vsan 2
  zone name iscsi-zone-2 vsan 2
    * fcid 0x750001 [pwwn 21:00:00:20:37:6f:fe:54]
    * fcid 0x750101 [pwwn 21:00:00:20:37:a6:a6:5d]

    * fcid 0x750200 [pwwn 20:06:00:0b:fd:44:68:c2] <-----

```

**FC ID  
resolved for  
iSCSI  
initiator**

To configure scenario 2 (see [Figure 4-45](#)), follow these steps:

**Step 1** Configure null authentication for all iSCSI hosts.

- a. In Fabric Manager, choose **End Devices > iSCSI** in the Physical Attributes pane.
- b. Select **none** from the AuthMethod drop-down menu in the Information pane.
- c. Click the **Apply Changes** icon.

**Step 2** Configure iSCSI to dynamically import all Fibre Channel targets into the iSCSI SAN using auto-generated iSCSI target names.

- a. In Device Manager, click **IP > iSCSI**.
- b. Click the **Targets** tab.
- c. Check the **Dynamically Import FC Targets** check box.
- d. Click **Apply**.

**Step 3** Configure the Gigabit Ethernet interface in slot 7 port 1 with an IPv4 address and enable the interface.

- a. In Fabric Manager, choose **Switches > Interfaces > Gigabit Ethernet** in the Physical Attributes pane.
- b. Select the **IP Address** tab in the Information pane and click **Create Row**.
- c. Set the IP address and subnet mask for the Gigabit Ethernet interface in slot 7 port 1.
- d. Click **Create**.
- e. Click the **General** tab and select **up** from the Admin drop-down menu for the Gigabit Ethernet interface in slot 7 port 1.
- f. Click the **Apply Changes** icon.

**Step 4** Configure the iSCSI interface in slot 7 port 1 to identify all dynamic iSCSI initiators by their IP address and enable the interface.

- a. In Fabric Manager, choose **Switches > Interfaces > FC Logical** in the Physical Attributes pane.
- b. Select the **iSCSI** tab in the Information pane.
- c. Select **ipaddress** from the Initiator ID Mode drop-down menu and click the **Apply Changes** icon.
- d. In Device Manager, choose **Interfaces > Ethernet and iSCSI**.
- e. Click the **iSCSI** tab.
- f. Select **up** from the Admin drop-down menu for the iSCSI interface in slot 7 port 1.
- g. Click **Apply**.

**Step 5** Configure the Gigabit Ethernet interface in slot 7 port 5 with the IPv4 address and enable the interface.

- a. In Fabric Manager, choose **Switches > Interfaces > Gigabit Ethernet** in the Physical Attributes pane.
- b. Click the **IP Address** tab in the Information pane and click **Create Row**.
- c. Set the IP address and subnet mask for the Gigabit Ethernet interface in slot 7 port 5.
- d. Click **Create**.
- e. Select the **General** tab and select **up** from the Admin drop-down menu for the Gigabit Ethernet interface in slot 7 port 5.
- f. Click the **Apply Changes** icon.

**Step 6** Configure the iSCSI interface in slot 7 port 5 to identify all dynamic iSCSI initiators by IP address and enable the interface.

- a. In Fabric Manager, choose **Switches > Interfaces > FC Logical** in the Physical Attributes pane.
- b. Click the **iSCSI** tab in the Information pane.
- c. Select **ipaddress** from the Initiator ID Mode drop-down menu and click the **Apply Changes** icon.
- d. In Device Manager, choose **Interfaces > Ethernet and iSCSI**.
- e. Click the **iSCSI** tab.
- f. Select **up** from the Admin drop-down menu for the iSCSI interface in slot 7 port 5.
- g. Click **Apply**.

**Step 7** Configure for static pWWN and nWWN for host 1.

- a. In Device Manager, choose **IP > iSCSI**.
- b. Click the **Initiators** tab.
- c. Check the **Node Address Persistent** and **Node Address System-assigned** check boxes the Host 1 iSCSI initiator.
- d. Click **Apply**.

**Step 8** Configure for static pWWN for Host 2.

- a. In Device Manager, Choose **IP > iSCSI**.
- b. Click the **Initiators** tab.
- c. Right-click on the Host 2 iSCSI initiator and click Edit pWWN.
- d. Select **1** from the System-assigned Num field and click **Apply**.

**Step 9** View the configured WWNs.



**Note** The WWNs are assigned by the system. The initiators are members of different VSANs.

- a. In Fabric Manager, choose **End Devices > iSCSI** in the Physical Attributes pane.
- b. Click the **Initiators** tab.

**Step 10** Create a zone for Host 1 and the iSCSI target in VSAN 1.



**Note** Use the IP address of the host in zone membership configuration because the iSCSI interface is configured to identify all hosts based on IP address.

- a. In Fabric Manager, choose **Zones > Edit Local Full Zone Database**.
- b. Select VSAN 1 from the VSAN drop-down menu in the Edit Local Full Zone Database dialog box.

- c. Select the **Zones** folder in the left navigation pane and click **Insert**.
- d. Set the Zone Name field to **iscsi-zone-1** and click **OK**.
- e. Select the iscsi-zone-1 folder in the left navigation pane and click **Insert**.
- f. Set the ZoneBy radio button to **WWN**.
- g. Set the Port WWN to the pWWN for the Fibre Channel target (that is, 21:00:00:20:37:6f:fd:97). and click **Add**.
- h. Set the ZoneBy radio button to **iSCSI IP Address/Subnet**.
- i. Set the IP Address/Mask field to the IP Address for Host 1 iSCSI initiator (10.11.1.10) and click **Add**.



**Note** Fibre Channel storage for zone membership for the iSCSI initiator, either the iSCSI symbolic node name or the pWWN, can be used. In this case, the pWWN is persistent.

**Step 11** Create a zone set in VSAN 1 and activate it.

- a. In Fabric Manager, choose **Zones > Edit Local Full Zone Database**.
- b. Select VSAN 1 from the VSAN drop-down menu in the Edit Local Full Zone Database dialog box.
- c. Select the **Zoneset** folder in the left navigation pane and click **Insert**.
- d. Set the Zoneset Name to **zonset-iscsi-1** and click **OK**.
- e. Click on the **zonset-iscsi-1** folder and click **Insert**.
- f. Set the Zone Name field to **iscsi-zone-1** and click **OK**.
- g. Click **Activate** to activate the new zone set.
- h. Click **Continue Activation** to finish the activation.

**Step 12** Create a zone with host 2 and two Fibre Channel targets.



**Note** If the host is in VSAN 2, the Fibre Channel targets and zone must also be in VSAN 2.



**Note** iSCSI interface is configured to identify all hosts based on node name.

- a. In Fabric Manager, choose **Zones > Edit Local Full Zone Database**.
- b. Select VSAN 2 from the VSAN drop-down menu in the Edit Local Full Zone Database dialog box.
- c. Select the **Zones** folder in the left navigation pane and click **Insert**.
- d. Set the Zone Name field to **iscsi-zone-2** and click **OK**.
- e. Select the **iscsi-zone-2** folder in the left navigation pane and click **Insert**.
- f. Set the ZoneBy radio button to **WWN**.
- g. Set the Port WWN to the pWWN for one of the Fibre Channel targets (for example, 21:00:00:20:37:6f:fe:5) and click **Add**.
- h. Set the Port WWN to the pWWN for another of the Fibre Channel targets (for example, 21:00:00:20:37:a6:a6:5d) and click **Add**.
- i. Set the ZoneBy radio button to **iSCSI IP Address/Subnet**.
- j. Set the IP Address/Mask field to the IP Address for Host 2 iSCSI initiator (10.15.1.11) and click **Add**.

**Step 13** Create a zone set in VSAN 2 and activate it.

- a. In Fabric Manager, choose **Zones > Edit Local Full Zone Database**.
- b. Select VSAN 2 from the VSAN drop-down menu in the Edit Local Full Zone Database dialog box.
- c. Select the **Zoneset** folder in the left navigation pane and click **Insert**.
- d. Set the Zoneset Name to **zonset-iscsi-2** and click **OK**.
- e. Click on the **zonset-iscsi-2** folder and click **Insert**.
- f. Set the Zone Name field to **iscsi-zone-2** and click **OK**.
- g. Click **Activate** to activate the new zone set.
- h. Click **Continue Activation** to finish the activation.

**Step 14** Start the iSCSI clients on both hosts.

**Step 15** Show all the iSCSI sessions.

- a. In Device Manager, choose **Interface > Monitor > Ethernet** and select the **iSCSI connections** tab to show all the iSCSI sessions.
- b. In Device Manager, choose **IP > iSCSI** and select the **Session Initiators** tab.
- c. Click **Details**.

**Step 16** In Fabric Manager, choose **End Devices > iSCSI** in the Physical Attributes pane to verify the details of the two iSCSI initiators.

**Step 17** In Fabric Manager, choose **Zones > Edit Local Full Zone Database** to view the active zone set. The iSCSI initiators' FC IDs are resolved.

**Step 18** In Device Manager, choose **FC > Name Server**. The Fibre Channel name server shows the virtual N ports created for the iSCSI hosts.

**Step 19** In Device Manager, Choose **FC > Name Server**.

**Step 20** Click the **Advanced** tab. Verify the detailed output of the iSCSI initiator nodes in the Fibre Channel name server.

## Overview of Internet Storage Name Service

Internet Storage Name Service (iSNS) allows your existing TCP/IP network to function more effectively as a SAN by automating the discovery, management, and configuration of iSCSI devices. To facilitate these functions, the iSNS server and client function as follows:

- The iSNS client registers iSCSI portals and all iSCSI devices accessible through them with an iSNS server.
- The iSNS server provides the following services for the iSNS client:
  - Device registration
  - State change notification
  - Remote domain discovery services

All iSCSI devices (both initiator and target) acting as iSNS clients, can register with an iSNS server. iSCSI initiators can then query the iSNS server for a list of targets. The iSNS server will respond with a list of targets that the querying client can access based on configured access control parameters.

A Cisco MDS 9000 Family switch can act as an iSNS client and register all available iSCSI targets with an external iSNS server. All switches in the Cisco MDS 9000 Family with Fibre Channel module with IPS ports or MPS-14/2 modules installed support iSNS server functionality. This allows external iSNS clients, such as an iSCSI initiator, to register with the switch and discover all available iSCSI targets in the SAN.

This section includes the following topics:

- [Overview of iSNS Client Functionality, page 4-202](#)
- [Creating an iSNS Client Profile, page 4-203](#)
- [Overview of iSNS Client Functionality, page 4-202](#)
- [Configuring an iSNS Server, page 4-208](#)

## Overview of iSNS Client Functionality

Internet Storage Name Service (iSNS) allows your existing TCP/IP network to function more effectively as a SAN by automating the discovery, management, and configuration of iSCSI devices. The iSNS client registers iSCSI portals and all iSCSI devices accessible through them with an iSNS server. All iSCSI devices (both initiator and target) acting as iSNS clients can register with an iSNS server. When the iSNS client is unable to register or deregister objects with the iSNS server (for example, the client is unable to make a TCP connection to the iSNS server), it retries every minute to reregister all iSNS objects for the affected interfaces with the iSNS server.

The iSNS client functionality on each IPS interface (Gigabit Ethernet interface or subinterface or port channel) registers information with an iSNS server.

Once a profile is tagged to an interface, the switch opens a TCP connection to the iSNS server IP address (using the well-known iSNS port number 3205) in the profile and registers network entity and portal objects; a unique entity is associated with each IPS interface. The switch then searches the Fibre Channel name server (FCNS) database and switch configuration to find storage nodes to register with the iSNS server.

Statically mapped virtual targets are registered if the associated Fibre Channel pWWN is present in the FCNS database and no access control configuration prevents it. A dynamically mapped target is registered if dynamic target importing is enabled. See the [“Presenting Fibre Channel Targets as iSCSI Targets” section on page 4-103](#) for more details on how iSCSI imports Fibre Channel targets.

A storage node is deregistered from the iSNS server when it becomes unavailable when a configuration changes (such as access control change or dynamic import disabling) or the Fibre Channel storage port goes offline. It is registered again when the node comes back online.

When the iSNS client is unable to register or deregister objects with the iSNS server (for example, the client is unable to make a TCP connection to the iSNS server), it retries every minute to reregister all iSNS objects for the affected interfaces with the iSNS server. The iSNS client uses a registration interval value of 15 minutes. If the client fails to refresh the registration during this interval, the server will deregister the entries.

Untagging a profile also causes the network entity and portal to be deregistered from that interface.

**Note**

The iSNS client is not supported on a VRRP interface.

## Creating an iSNS Client Profile

To create an iSNS profile, follow these steps:

	Command	Purpose
<b>Step 1</b>	switch# <b>config terminal</b> switch(config)#	Enters configuration mode.
<b>Step 2</b>	switch(config)# <b>isns profile name MyIsns</b> switch(config-isns-profile)#	Creates a profile called MyIsns.
<b>Step 3</b>	switch(config-isns-profile)# <b>server</b> <b>10.10.100.211</b>	Specifies an iSNS server IPv4 address for this profile.
<b>Step 4</b>	switch(config-isns-profile)# <b>no server</b> <b>10.10.100.211</b>	Removes a configured iSNS server from this profile.
<b>Step 5</b>	switch(config-isns-profile)# <b>server 2003::11</b>	Specifies an iSNS server IPv6 address for this profile.
<b>Step 6</b>	switch(config-isns-profile)# <b>no server</b> <b>10.20.100.211</b>	Removes a configured iSNS server from this profile.

To create an iSNS profile using Fabric Manager, follow these steps:

**Step 1** Choose **End Devices > iSCSI** in the Physical Attributes pane.

You see the iSCSI configuration in the Information pane (see [Figure 4-12](#)).

**Step 2** Select the **iSNS** tab.

**Step 3** You see the iSNS profiles configured (see [Figure 4-46](#)).

**Figure 4-46** iSNS Profiles in Fabric Manager

Switch	Feature	Status	Command	LastCommand	Result
sw172-22-46-220	iscsi	enabled	noSelection	noSelection	none
sw172-22-46-223	iscsi	enabled	noSelection	noSelection	none
sw172-22-46-233	iscsi	enabled	noSelection	noSelection	none
sw172-22-46-224	iscsi	disabled	noSelection	noSelection	none
sw172-22-46-182	iscsi	disabled	noSelection	noSelection	none
sw172-22-46-223	isns-server	enabled	noSelection	noSelection	none
sw172-22-46-221	iscsi	disabled	noSelection	noSelection	none
sw172-22-46-222	iscsi	enabled	noSelection	noSelection	none
sw172-22-46-233	isns-server	enabled	noSelection	noSelection	none

**Step 4** Click the **Create Row** icon.

You see the Create iSNS Profiles dialog box.

**Step 5** Set the ProfileName field to the iSNS profile name that you want to create.

**Step 6** Set the ProfileAddr field to the IP address of the iSNS server.

**Step 7** Click **Create** to save these changes.

To remove an iSNS profile, follow these steps:

	Command	Purpose
<b>Step 1</b>	switch# <b>config terminal</b> switch(config)#	Enters configuration mode.
<b>Step 2</b>	switch(config)# <b>no isns profile name OldIsns</b>	Removes a configured iSNS profile called OldIsns.

To delete an iSNS profile using Fabric Manager, follow these steps:

**Step 1** Choose **End Devices > iSCSI** from the Physical Attributes pane.

You see the iSCSI configuration in the Information pane (see [Figure 4-12](#)).

**Step 2** Select the **iSNS** tab.

You see the iSNS profiles configured (see [Figure 4-46](#)).

**Step 3** Right-click on the profile that you want to delete and click the **Delete Row** icon.

To tag a profile to an interface, follow these steps:

	Command	Purpose
<b>Step 1</b>	switch# <b>config terminal</b> switch(config)#	Enters configuration mode.
<b>Step 2</b>	switch(config)# <b>interface gigabitethernet 4/1</b> switch(config-if)#	Configures the specified Gigabit Ethernet interface.
<b>Step 3</b>	switch(config-if)# <b>isns MyIsns</b>	Tags a profile to an interface.

To tag a profile to an interface using Fabric Manager, follow these steps:

**Step 1** Choose **Switches > Interfaces > Gigabit Ethernet** in the Physical Attributes pane.

You see the Gigabit Ethernet configuration in the Information pane.

**Step 2** Click the **iSNS** tab.

You see the iSNS profiles configured for these interfaces (see [Figure 4-47](#)).

**Figure 4-47** *iSNS Profiles in Fabric Manager*

Switch	Interface	IscsiAuthMethod	iSNS ProfileName	IscsiSessions
sw172-22-46-220	gigE8/1			0
sw172-22-46-223	gigE2/1			0
sw172-22-46-233	gigE1/1			0
sw172-22-46-220	gigE8/2			0
sw172-22-46-220	gigE2/2			0
sw172-22-46-233	gigE1/2			0
sw172-22-46-220	gigE9/1			0
sw172-22-46-174	gigE12/1			0
sw172-22-46-220	gigE9/2			0

**Step 3** Set the iSNS ProfileName field to the iSNS profile name that you want to add to this interface.

**Step 4** Click the **Apply Changes** icon to save these changes.

To untag a profile from an interface, follow these steps:

	Command	Purpose
<b>Step 1</b>	switch# <b>config terminal</b> switch(config)#	Enters configuration mode.
<b>Step 2</b>	switch(config)# <b>interface gigabitethernet 5/1</b> switch(config-if)#	Configures the specified Gigabit Ethernet interface.
<b>Step 3</b>	switch(config-if)# <b>no isns OldIsns</b>	Untags a profile from an interface.

Use the **isns reregister** command in EXEC mode to reregister associated iSNS objects with the iSNS server.

```
switch# isns reregister gigabitethernet 1/4
switch# isns reregister port-channel 1
```

To untag a profile from an interface using Fabric Manager, follow these steps:

**Step 1** Choose **Switches > Interfaces > Gigabit Ethernet** in the Physical Attributes pane.

You see the Gigabit Ethernet Configuration in the Information pane.

**Step 2** Click the **iSNS** tab.

You see the iSNS profiles configured for these interfaces (see [Figure 4-47](#)).

**Step 3** Right-click the iSNS ProfileName field that you want to untag and delete the text in that field.

**Step 4** Click the **Apply Changes** icon to save these changes.

## Verifying iSNS Client Configuration

Use the **show isns profile** command to view configured iSNS profiles. Profile ABC has two portals registered with the iSNS server. Each portal corresponds to a particular interface. Profile XYZ has a specified iSNS server, but does not have any tagged interfaces configured (see [Example 4-19](#) and [Example 4-20](#)).

### Example 4-19 Displaying Information for Configured iSNS Profiles

```
switch# show isns profile
iSNS profile name ABC
tagged interface GigabitEthernet2/3
tagged interface GigabitEthernet2/2
iSNS Server 10.10.100.204

iSNS profile name XYZ
iSNS Server 10.10.100.211
```

### Example 4-20 Displaying a Specified iSNS Profile

```
switch# show isns profile ABC
iSNS profile name ABC
tagged interface GigabitEthernet2/3
tagged interface GigabitEthernet2/2
iSNS Server 10.10.100.204
```

Use the **show isns profile counters** command to view all configured profiles with the iSNS PDU statistics for each tagged interface (see [Example 4-21](#) and [Example 4-22](#)).

**Example 4-21 Displaying Configured Profiles with iSNS Statistics**

```

switch# show isns profile counters
iSNS profile name ABC
tagged interface port-channel 1
iSNS statistics
  Input 54 pdus (registration/deregistration pdus only)
    Reg pdus 37, Dereg pdus 17
  Output 54 pdus (registration/deregistration pdus only)
    Reg pdus 37, Dereg pdus 17
iSNS Server 10.10.100.204

iSNS profile name XYZ
tagged interface port-channel 2
iSNS statistics
  Input 30 pdus (registration/deregistration pdus only)
    Reg pdus 29, Dereg pdus 1
  Output 30 pdus (registration/deregistration pdus only)
    Reg pdus 29, Dereg pdus 1
iSNS Server 10.1.4.218

```

**Example 4-22 Displaying iSNS Statistics for a Specified Profile**

```

switch# show isns profile ABC counters
iSNS profile name ABC
tagged interface port-channel 1
iSNS statistics
  Input 54 pdus (registration/deregistration pdus only)
    Reg pdus 37, Dereg pdus 17
  Output 54 pdus (registration/deregistration pdus only)
    Reg pdus 37, Dereg pdus 17
iSNS Server 10.10.100.204

```

Use the **show isns** command to view all objects registered on the iSNS server and specified in the given profile (see [Example 4-23](#)).

**Example 4-23 Displaying iSNS Queries**

```

switch# show isns query ABC gigabitethernet 2/3
iSNS server: 10.10.100.204
Init: iqn.1991-05.com.w2k
  Alias: <MS SW iSCSI Initiator>
Tgt : iqn.1987-05.com.cisco:05.172.22.94.22.02-03
Tgt : iqn.1987-05.com.cisco:05.172.22.94.22.02-03.210000203762fa34
  nWWN: 200000203762fa34

```

Use the **show interface** command to view the iSNS profile to which an interface is tagged (see [Example 4-24](#)).

**Example 4-24 Displaying Tagged iSNS Interfaces**

```

switch# show interface gigabitethernet 2/3
GigabitEthernet2/3 is up
Hardware is GigabitEthernet, address is 0005.3000.ae94
Internet address is 10.10.100.201/24
MTU 1500 bytes
Port mode is IPS
Speed is 1 Gbps
Beacon is turned off
Auto-Negotiation is turned on
iSNS profile ABC

```



2. Initiator iqn.host2 registers with SW-2, port Gigabitethernet3/1.
3. Initiator iqn.host1 issues an iSNS query to SW-1 to determine all accessible targets.
4. The iSNS server in turn queries the Fibre Channel name server (FCNS) to obtain a list of devices that are accessible (that is, in the same zone) by the query originator. This query yields only P1.
5. The iSNS server then queries its own database to convert the Fibre Channel devices to the corresponding iSCSI targets. This is based on the iSCSI configuration, such as virtual-target and its access control setting or whether the dynamic Fibre Channel target import feature is enabled or disabled.
6. The iSNS server sends a response back to the query initiator. This response contains a list all iSCSI portals known to the iSNS server. This means iqn.host1 can choose to log in to target P1 through either SW-1 (at Gigabitethernet 2/1) or SW-2 (at Gigabitethernet 3/1).
7. If the initiator chooses to log in to SW-1 and later that port becomes inaccessible (for example, Gigabitethernet 2/1 goes down), the initiator has the choice to move to connect to target P1 through port Gigabitethernet 3/1 on SW-2 instead.
8. If the target either goes down or is removed from the zone, the iSNS server sends out an iSNS State Change Notification (SCN) message to the initiator so that the initiator can remove the session.

## Configuring an iSNS Server

This section describe how to configure an iSNS server on a Cisco MDS 9000 Family switch.

This section includes the following topics:

- [Enabling an iSNS Server, page 4-208](#)
- [iSNS Configuration Distribution, page 4-209](#)
- [Configuring the ESI Retry Count, page 4-209](#)
- [Configuring a Registration Period, page 4-210](#)
- [iSNS Client Registration and Deregistration, page 4-210](#)
- [Target Discovery, page 4-211](#)
- [Verifying the iSNS Server Configuration, page 4-211](#)

### Enabling an iSNS Server

Before the iSNS server feature can be enabled, iSCSI must be enabled (see the “[Enabling iSCSI](#)” section on page 4-98). When you disable iSCSI, iSNS is automatically disabled. When the iSNS server is enabled on a switch, every IPS port whose corresponding iSCSI interface is up is capable of servicing iSNS registration and query requests from external iSNS clients.

To enable the iSNS server, follow these steps:

	Command	Purpose
<b>Step 1</b>	switch# <b>config terminal</b> switch(config)#	Enters configuration mode.
<b>Step 2</b>	switch(config)# <b>isns-server enable</b> switch(config)# <b>no isns-server enable</b>	Enables the iSNS server. Disables (default) the iSNS server.

To enable the iSNS server using Fabric Manager, follow these steps:

- 
- Step 1** Choose **End Devices > iSNS**.

You see the iSNS configuration in the Information pane.

- Step 2** Click the **Control** tab and select **enable** from the Command drop-down menu for the iSNS server feature.
- Step 3** Click the **Apply Changes** icon to save this change.



**Note** If you are using VRRP IPv4 addresses for discovering targets from iSNS clients, ensure that the IP address is created using the **secondary** option (see [“Adding Virtual Router IP Addresses”](#) section on page 5-244).

### iSNS Configuration Distribution

You can use the CFS infrastructure to distribute the iSCSI initiator configuration to iSNS servers across the fabric. This allows the iSNS server running on any switch to provide a querying iSNS client a list of iSCSI devices available anywhere on the fabric. For information on CFS, see the *Cisco Fabric Manager System Management Configuration Guide* and *Cisco MDS 9000 Family NX-OS System Management Configuration Guide*.

To enable iSNS configuration distribution using, follow these steps:

	Command	Purpose
<b>Step 1</b>	switch# <b>config terminal</b> switch(config)#	Enters configuration mode.
<b>Step 2</b>	switch(config)# <b>isns distribute</b>  switch(config)# <b>no isns distribute</b>	Uses the CFS infrastructure to distribute the iSCSI virtual target configuration to all switches in the fabric.  Stops (default) the distribution of iSCSI virtual target configuration to all switches in the fabric.

To enable iSNS configuration distribution using Fabric Manager, follow these steps:

- Step 1** Choose **End Devices > iSNS**.

You see the iSNS configuration in the Information pane.

- Step 2** Click the **CFS** tab and select **enable** from the Admin drop-down menu for iSNS.
- Step 3** Select **enable** from the Global drop-down menu for iSNS.
- Step 4** Click the **Apply Changes** icon to save this change.

### Configuring the ESI Retry Count

The iSNS client registers information with its configured iSNS server using an iSNS profile. At registration, the client can indicate an entity status inquiry (ESI) interval of 60 seconds or more. If the client registers with an ESI interval set to zero (0), then the server does not monitor the client using ESI. In such cases, the client’s registrations remain valid until explicitly deregistered or the iSNS server feature is disabled.

The ESI retry count is the number of times the iSNS server queries iSNS clients for their entity status. The default ESI retry count is 3. The client sends the server a response to indicate that it is still alive. If the client fails to respond after the configured number of retries, the client is deregistered from the server.

To configure the ESI retry count for an iSNS server, follow these steps:

	Command	Purpose
<b>Step 1</b>	switch# <b>config terminal</b> switch(config)#	Enters configuration mode.
<b>Step 2</b>	switch(config)# <b>isns esi retries 6</b>	Configures the ESI to retry contacting the client up to 6 times. The range is 1 to 10.
	switch(config)# <b>no isns esi retries 6</b>	Reverts to the default value of 3 retries.

### Configuring a Registration Period

The iSNS client specifies the registration period with the iSNS Server. The iSNS Server keeps the registration active until the end of this period. If there are no commands from the iSNS client during this period, then the iSNS server removes the client registration from its database.

If the iSNS client does not specify a registration period, the iSNS server assumes a default value of 0, which keeps the registration active indefinitely. You can also manually configure the registration period on the MDS iSNS Server.

To configure the registration period on an iSNS Server, follow these steps:

	Command	Purpose
<b>Step 1</b>	switch# <b>config terminal</b> switch(config)#	Enters configuration mode.
<b>Step 2</b>	switch(config)# <b>isns registration period 300</b>	Configures the registration to be active for 300 seconds. The permissible registration period is between 0 to 65536 seconds.
	switch(config)# <b>no isns registration period</b>	Reverts to the client registered timeout value, or the default value of 0.

To configure the registration period on an iSNS Server using Fabric Manager, follow these steps:

---

**Step 1** Choose **End Devices > iSNS**.

You see the iSNS configuration in the Information pane.

**Step 2** Click the **Servers** tab.

You see the configured iSNS servers.

**Step 3** Set the **ESI NonResponse Threshold** field to the ESI retry count value.

**Step 4** Click the **Apply Changes** icon to save this change.

---

### iSNS Client Registration and Deregistration

You can use the **show isns database** command to display all registered iSNS clients and their associated configuration.

An iSNS client cannot query the iSNS server until it has registered. iSNS client deregistration can occur either explicitly or when the iSNS server detects that it can no longer reach the client (through ESI monitoring).

iSNS client registration and deregistration result in status change notifications (SCNs) being generated to all interested iSNS clients.

## Target Discovery

iSCSI initiators discover targets by issuing queries to the iSNS server. The server supports *DevGetNext* requests to search the list of targets and *DevAttrQuery* to determine target and portal details, such as the IP address or port number to which to connect.

On receiving a query request from the iSCSI client, the iSNS server queries the Fibre Channel Name Server (FCNS) to obtain a list of Fibre Channel targets that are accessible by the querying initiator. The result of this query depends on zoning configuration currently active and current configuration(s) of the initiator. The iSNS server will subsequently use the iSCSI target configuration(s) (virtual target and dynamic import configuration) to translate the Fibre Channel target to an equivalent iSCSI target. At this stage it also applies any access control configured for the virtual target. A response message with the target details is then sent back to the query initiator.

The iSNS server sends a consolidated response containing all possible targets and portals to the querying initiator. For example, if a Fibre Channel target is exported as different iSCSI targets on different IPS interfaces, the iSNS server will respond with a list of all possible iSCSI targets and portals.

In order to keep the list of targets updated, the iSNS server sends state change notifications (SCN) to the client whenever an iSCSI target becomes reachable or unreachable. The client is then expected to rediscover its list of accessible targets by initiating another iSNS query. Reachability of iSCSI targets changes when any one of the following occurs:

- Target goes up or down.
- Dynamic import of FC target configuration changes.
- Zone set changes.
- Default zone access control changes.
- IPS interface state changes.
- Initiator configuration change makes the target accessible or inaccessible.

## Verifying the iSNS Server Configuration

Use the **show isns config** command to view the ESI interval and the summary information about the iSNS database contents (see [Example 4-25](#)).

### Example 4-25 Displaying the iSNS Server Configuration of ESI Interval and Database Contents

```
switch# show isns config
Server Name: switch1(Cisco Systems) Up since: Fri Jul 30 04:08:16 2004
  Index: 1   Version: 1   TCP Port: 3205
  fabric distribute (remote sync): ON
  ESI
    Non Response Threshold: 5 Interval(seconds): 60
  Database contents
    Number of Entities: 2
    Number of Portals: 3
    Number of iSCSI devices: 4
    Number of Portal Groups: 0
```

Use the **show isns database** command to view detailed information about the contents of the iSNS database (see [Example 4-26](#) through [Example 4-29](#)). This command displays the full iSNS database giving all the entities, nodes, and portals registered in the database. This command without options only displays explicitly registered objects. The asterisk next to the VSAN ID indicates that the iSCSI node is in the default zone for that VSAN.

### Example 4-26 Displaying Explicitly Registered Objects

```
switch# show isns database
Entity Id: dp-204
```

Index: 2                    Last accessed: Fri Jul 30 04:08:46 2004

```
iSCSI Node Name: iqn.1991-05.comdp-2041
Entity Index: 2
Node Type: Initiator(2)            Node Index: 0x1
SCN Bitmap: OBJ_UPDATED|OBJ_ADDED|OBJ_REMOVED|TARGET&SELF
Node Alias: <MS SW iSCSI Initiator>
```

VSANS: 1(\*), 5(\*)

```
Portal IP Address: 192.168.100.2            TCP Port: 4179
Entity Index: 2        Portal Index: 1
ESI Interval: 0        ESI Port: 4180        SCN Port: 4180
```

#### **Example 4-27 Displaying the Full Database with Both Registered and Configured Nodes and Portals**

```
switch# show isns database full
Entity Id: isns.entity.mds9000
Index: 1                    Last accessed: Fri Jul 30 04:08:16 2004
```

```
iSCSI Node Name: iqn.com.cisco.disk1
Entity Index: 1
Node Type: Target(1)            Node Index: 0x80000001
WWN(s):
  22:00:00:20:37:39:dc:45
VSANS:
```

```
iSCSI Node Name: iqn.isns-first-virtual-target
Entity Index: 1
Node Type: Target(1)            Node Index: 0x80000002
```

VSANS:

```
iSCSI Node Name: iqn.com.cisco.disk2
Entity Index: 1
Node Type: Target(1)            Node Index: 0x80000003
WWN(s):
  22:00:00:20:37:39:dc:45
```

VSANS:

```
Portal IP Address: 192.168.100.5            TCP Port: 3205
Entity Index: 1        Portal Index: 3
```

```
Portal IP Address: 192.168.100.6            TCP Port: 3205
Entity Index: 1        Portal Index: 5
```

```
Entity Id: dp-204
Index: 2                    Last accessed: Fri Jul 30 04:08:46 2004
```

```
iSCSI Node Name: iqn.1991-05.com.microsoft:dp-2041
Entity Index: 2
Node Type: Initiator(2)            Node Index: 0x1
SCN Bitmap: OBJ_UPDATED|OBJ_ADDED|OBJ_REMOVED|TARGET&SELF
Node Alias: <MS SW iSCSI Initiator>
```

VSANS: 1(\*), 5(\*)

```
Portal IP Address: 192.168.100.2            TCP Port: 4179
Entity Index: 2        Portal Index: 1
ESI Interval: 0        ESI Port: 4180        SCN Port: 4180
```



---

**Note**    The **local** option is only available for virtual targets.

---

**Example 4-28 Displaying the Virtual Target Information in a Local Switch**

```

switch# show isns database virtual-targets local
Entity Id: isns.entity.mds9000
  Index: 1          Last accessed: Fri Jul 30 04:08:16 2004

iSCSI Node Name: iqn.com.cisco.disk1
  Entity Index: 1
  Node Type: Target(1)      Node Index: 0x80000001
  WWN(s):
    22:00:00:20:37:39:dc:45

  VSANS:
iSCSI Node Name: iqn.isns-first-virtual-target
  Entity Index: 1
  Node Type: Target(1)      Node Index: 0x80000002

  VSANS:
iSCSI Node Name: iqn.com.cisco.disk2
  Entity Index: 1
  Node Type: Target(1)      Node Index: 0x80000003
  WWN(s):
    22:00:00:20:37:39:dc:45

  VSANS:
Portal IP Address: 192.168.100.5      TCP Port: 3205
  Entity Index: 1    Portal Index: 3

Portal IP Address: 192.168.100.6      TCP Port: 3205
  Entity Index: 1    Portal Index: 5

```

**Example 4-29 Displaying Virtual Target for a Specified Switch**

```

switch# show isns database virtual-targets switch 20:00:00:0d:ec:01:04:40
Entity Id: isns.entity.mds9000
  Index: 1          Last accessed: Fri Jul 30 04:08:16 2004

iSCSI Node Name: iqn.com.cisco.disk1
  Entity Index: 1
  Node Type: Target(1)      Node Index: 0x80000001
  WWN(s):
    22:00:00:20:37:39:dc:45

  VSANS:
iSCSI Node Name: iqn.isns-first-virtual-target
  Entity Index: 1
  Node Type: Target(1)      Node Index: 0x80000002

  VSANS:
iSCSI Node Name: iqn.com.cisco.disk2
  Entity Index: 1
  Node Type: Target(1)      Node Index: 0x80000003
  WWN(s):
    22:00:00:20:37:39:dc:45

  VSANS:
Portal IP Address: 192.168.100.5      TCP Port: 3205
  Entity Index: 1    Portal Index: 3

Portal IP Address: 192.168.100.6      TCP Port: 3205
  Entity Index: 1    Portal Index: 5

```

Use the **show isns node** command to display attributes of nodes registered with the iSNS server (see [Example 4-30](#) through [Example 4-32](#)). If you do not specify any options, the server displays the name and node type attribute in a compact format; one per line.

#### Example 4-30 Displaying Explicitly Registered Objects

```
switch# show isns node all
-----
iSCSI Node Name                               Type
-----
iqn.1987-05.com.cisco:05.switch1.02-03.22000020375a6c8      Target
...
iqn.com.cisco.disk1                                         Target
iqn.com.cisco.ipdisk                                         Target
iqn.isns-first-virtual-target                               Target
iqn.1991-05.cw22                                             Target
iqn.1991-05.cw53                                             Target
```

#### Example 4-31 Displaying the Specified Node

```
switch# show isns node name iqn.com.cisco.disk1
iSCSI Node Name: iqn.com.cisco.disk1
  Entity Index: 1
  Node Type: Target(1)      Node Index: 0x80000001
  WWN(s):
    22:00:00:20:37:39:dc:45
  VSANS: 1
```

#### Example 4-32 Displaying the Attribute Details for All Nodes

```
switch# show isns node all detail
iSCSI Node Name: iqn.1987-05.com.cisco:05.switch1.02-03.22000020375a6c8f
  Entity Index: 1
  Node Type: Target(1)      Node Index: 0x30000003
  Configured Switch WWN: 20:00:00:0d:ec:01:04:40
  WWN(s):
    22:00:00:20:37:5a:6c:8f
  VSANS: 1
...
iSCSI Node Name: iqn.com.cisco.disk1
  Entity Index: 1
  Node Type: Target(1)      Node Index: 0x80000001
  Configured Switch WWN: 20:00:00:0d:ec:01:04:40
  WWN(s):
    22:00:00:20:37:39:dc:45
  VSANS: 1

iSCSI Node Name: iqn.com.cisco.ipdisk
  Entity Index: 1
  Node Type: Target(1)      Node Index: 0x80000002
  Configured Switch WWN: 20:00:00:0d:ec:01:04:40
  WWN(s):
    22:00:00:20:37:5a:70:1a
  VSANS: 1

iSCSI Node Name: iqn.isns-first-virtual-target
  Entity Index: 1
  Node Type: Target(1)      Node Index: 0x80000003
  Configured Switch WWN: 20:00:00:0d:ec:01:04:40
```

```
iSCSI Node Name: iqn.parna.121212
  Entity Index: 1
  Node Type: Target(1)      Node Index: 0x80000004
  Configured Switch WWN: 20:00:00:0d:ec:01:04:40
```

```
iSCSI Node Name: iqn.parna.121213
  Entity Index: 1
  Node Type: Target(1)      Node Index: 0x80000005
  Configured Switch WWN: 20:00:00:0d:ec:01:04:40
```

Use the **show isns portal** command to display the attributes of a portal along with its accessible nodes (see [Example 4-33](#) through [Example 4-37](#)). You can specify portals by using the switch WWN-interface combination or the IP address-port number combination.

#### **Example 4-33** *Displaying the Attribute Information for All Portals*

```
switch# show isns portal all
-----
IPAddress      TCP Port      Index          SCN Port      ESI  port
-----
192.168.100.5  3205         3              -             -
192.168.100.6  3205         5              -             -
```

#### **Example 4-34** *Displaying Detailed Attribute Information for All Portals*

```
switch# show isns portal all detail
Portal IP Address: 192.168.100.5      TCP Port: 3205
  Entity Index: 1    Portal Index: 3

Portal IP Address: 192.168.100.6      TCP Port: 3205
  Entity Index: 1    Portal Index: 5
```

#### **Example 4-35** *Displaying Virtual Portals*

```
switch# show isns portal virtual
-----
IPAddress      TCP Port      Index          SCN Port      ESI  port
-----
192.168.100.5  3205         3              -             -
192.168.100.6  3205         5              -             -
```

#### **Example 4-36** *Displaying Virtual Portals for a Specified Switch*

```
switch# show isns portal virtual switch 20:00:00:0d:ec:01:04:40
-----
IPAddress      TCP Port      Index          SCN Port      ESI  port
-----
192.168.100.5  3205         3              -             -
192.168.100.6  3205         5              -             -
```

#### **Example 4-37** *Displaying Detailed Information for the Virtual Portals in a Specified Switch*

```
switch# show isns portal virtual switch 20:00:00:0d:ec:01:04:40 detail
Portal IP Address: 192.168.100.5      TCP Port: 3205
  Entity Index: 1    Portal Index: 3
```

```
Switch WWN: 20:00:00:0d:ec:01:04:40
Interface: GigabitEthernet2/3
```

```
Portal IP Address: 192.168.100.6      TCP Port: 3205
Entity Index: 1      Portal Index: 5
Switch WWN: 20:00:00:0d:ec:01:04:40
Interface: GigabitEthernet2/5
```

Use the **show isns entity** command to display the attributes of an entity along with the list of portals and nodes in that entity (see [Example 4-38](#) through [Example 4-42](#)). If you do not specify any option, this command displays the entity ID and number of nodes or portals associated with the entity in a compact format; one per line.

#### **Example 4-38** *Displaying All Registered Entries*

```
switch1# show isns entity
-----
Entity ID                               Last Accessed
-----
dp-204                                  Tue Sep  7 23:15:42 2004
```

#### **Example 4-39** *Displaying All Entities in the Database*

```
switch# show isns entity all
-----
Entity ID                               Last Accessed
-----
isns.entity.mds9000                    Tue Sep  7 21:33:23 2004
dp-204                                  Tue Sep  7 23:15:42 2004
```

#### **Example 4-40** *Displaying the Entity with a Specified ID*

```
switch1# show isns entity id dp-204
Entity Id: dp-204
Index: 2      Last accessed: Tue Sep  7 23:15:42 2004
```

#### **Example 4-41** *Displaying Detailed Information for All Entities in the Database*

```
switch1# show isns entity all detail
Entity Id: isns.entity.mds9000
Index: 1      Last accessed: Tue Sep  7 21:33:23 2004

Entity Id: dp-204
Index: 2      Last accessed: Tue Sep  7 23:16:34 2004
```

#### **Example 4-42** *Displaying Virtual Entities*

```
switch# show isns entity virtual
Entity Id: isns.entity.mds9000
Index: 1      Last accessed: Thu Aug  5 00:58:50 2004

Entity Id: dp-204
Index: 2      Last accessed: Thu Aug  5 01:00:23 2004
```

Use the **show iscsi global config** command to display information about import targets (see [Example 4-43](#) and [Example 4-44](#)).

**Example 4-43 Displaying the Import Target Settings for a Specified Switch**

```
switch# show isns iscsi global config switch 20:00:00:05:ec:01:04:00
iSCSI Global configuration:
  Switch: 20:00:00:05:ec:01:04:00 iSCSI Auto Import: Enabled
```

**Example 4-44 Displaying the Import Target Settings for All Switches**

```
switch# show isns iscsi global config all
iSCSI Global configuration:
  Switch: 20:00:44:0d:ec:01:02:40 iSCSI Auto Import: Enabled
```

Use the **show cfs peers** command to display CFS peers switch information about the iSNS application (see [Example 4-45](#)).

**Example 4-45 Displaying the CFS Peer Switch Information for the iSNS Application**

```
switch# show cfs peers name isns

Scope      : Physical
-----
Switch WWN          IP Address
-----
20:00:00:00:ec:01:00:40  10.10.100.11  [Local]

Total number of entries = 1
```

## iSNS Cloud Discovery

You can configure iSNS cloud discovery to automate the process of discovering iSNS servers in the IP network.

This section includes the following topics:

- [Cloud Discovery, page 4-217](#)
- [Configuring iSNS Cloud Discovery, page 4-218](#)
- [Verifying Cloud Discovery Status, page 4-220](#)
- [Verifying Cloud Discovery Membership, page 4-220](#)
- [Displaying Cloud Discovery Statistics, page 4-221](#)

## Cloud Discovery

When an iSNS server receives a query request, it responds with a list of available targets and the portals through which the initiator can reach the target. The IP network configuration outside the MDS switch may result in only a subset of Gigabit Ethernet interfaces being reachable from the initiator. To ensure that the set of portals returned to the initiator is reachable, the iSNS server needs to know the set of Gigabit Ethernet interfaces that are reachable from a given initiator.

**Note**

iSNS Cloud Discovery is not supported on the Cisco Fabric Switch for IBM BladeCenter and Cisco Fabric Switch for HP c-Class BladeSystem.

The iSNS cloud discovery feature provides information to the iSNS server on the various interfaces reachable from an initiator by partitioning the interfaces on a switch into disjointed IP clouds. This discovery is achieved by sending messages to all other known IPS ports that are currently up and, depending on the response (or the lack of it), determines if the remote IPS port is in the same IP network or in a different IP network.

Cloud discovery is initiated when the following events occur:

- Manual requests from the CLI initiate cloud discovery from the CLI. This action causes the destruction of existing memberships and makes new ones.
- Auto-discovery of the interface results in an interface being assigned to its correct cloud. All other cloud members are not affected. The membership of each cloud is built incrementally and is initiated by the following events:
  - A Gigabit Ethernet interface comes up. This can be a local or remote Gigabit Ethernet interface.
  - The IP address of a Gigabit Ethernet interface changes.
  - The VRRP configuration on a port changes.

The iSNS server distributes cloud and membership information across all the switches using CFS. Therefore, the cloud membership view is the same on all the switches in the fabric.



**Note** For CFS distribution to operate correctly for iSNS cloud discovery, all switches in the fabric must be running Cisco SAN-OS Release 3.0(1) or NX-OS 4.1(1b) and later.

## Configuring iSNS Cloud Discovery

This section describes how to configure iSNS cloud discovery and includes the following topics:

- [Enabling iSNS Cloud Discovery, page 4-218](#)
- [Initiating On-Demand iSNS Cloud Discovery, page 4-219](#)
- [Configuring Automatic iSNS Cloud Discovery, page 4-219](#)
- [Verifying Automatic iSNS Cloud Discovery Configuration, page 4-219](#)
- [Configuring iSNS Cloud Discovery, page 4-218](#)
- [Configuring iSNS Cloud Discovery Message Types, page 4-220](#)

### Enabling iSNS Cloud Discovery

To enable iSNS cloud discovery, follow these steps:

	Command	Purpose
<b>Step 1</b>	switch# <b>config terminal</b> switch(config)#	Enters configuration mode.
<b>Step 2</b>	switch(config)# <b>cloud-discovery enable</b>	Enables iSNS cloud discovery.
	switch(config)# <b>no cloud-discovery enable</b>	Disables (default) iSNS cloud discovery.

To enable iSNS cloud discovery using Fabric Manager, follow these steps:

**Step 1** Choose **End Devices > iSNS**.

You see the iSNS configuration in the Information pane.

**Step 2** Click the **Control** tab and select **enable** from the Command drop-down menu for the cloud discovery feature.

**Step 3** Click the **Apply Changes** icon to save this change.

---

### Initiating On-Demand iSNS Cloud Discovery

To initiate on-demand iSNS cloud discovery, use the **cloud discover** command in EXEC mode.

The following example shows how to initiate on-demand cloud discovery for the entire fabric:

```
switch# cloud discover
```

To initiate on-demand iSNS cloud discovery using Fabric Manager, follow these steps:

**Step 1** Choose **End Devices > iSNS**.

You see the iSNS configuration in the Information pane.

**Step 2** Click the **Cloud Discovery** tab and check the **Manual Discovery** check box.

**Step 3** Click the **Apply Changes** icon to save this change.

---

### Configuring Automatic iSNS Cloud Discovery

To configure automatic iSNS cloud discovery, follow these steps:

	Command	Purpose
<b>Step 1</b>	switch# <b>config terminal</b> switch(config)#	Enters configuration mode.
<b>Step 2</b>	switch(config)# <b>cloud discovery auto</b>	Enables (default) automatic iSNS cloud discovery.
	switch(config)# <b>no cloud discovery auto</b>	Disables automatic iSNS cloud discovery.

To configure automatic iSNS cloud discovery using Fabric Manager, follow these steps:

**Step 1** Choose **End Devices > iSNS**.

You see the iSNS configuration in the Information pane.

**Step 2** Click the **Cloud Discovery** tab and check the **AutoDiscovery** check box.

**Step 3** Click the **Apply Changes** icon to save this change.

---

### Verifying Automatic iSNS Cloud Discovery Configuration

To verify the automatic iSNS cloud discovery configuration, use the **show cloud discovery config** command:

```
switch# show cloud discovery config
Auto discovery: Enabled
```

## Configuring iSNS Cloud Discovery Distribution

To configure iSNS cloud discovery distribution using CFS, follow these steps:

	Command	Purpose
<b>Step 1</b>	switch# <b>config terminal</b> switch(config)#	Enters configuration mode.
<b>Step 2</b>	switch(config)# <b>cloud discovery fabric distribute</b>	Enables (default) iSNS cloud discovery fabric distribution.
	switch(config)# <b>no cloud discovery fabric distribute</b>	Disables iSNS cloud discovery fabric distribution.

To configure iSNS cloud discovery CFS distribution using Fabric Manager, follow these steps:

**Step 1** Choose **End Devices > iSNS**.

You see the iSNS configuration in the Information pane.

**Step 2** Click the **CFS** tab and select **enable** from the Admin drop-down menu for the cloud discovery feature.

**Step 3** Select **enable** from the Global drop-down menu for the cloud discovery feature.

**Step 4** Click the **Apply Changes** icon to save this change.

## Configuring iSNS Cloud Discovery Message Types

You can configure iSNS cloud discovery the type of message to use. By default, iSNS cloud discovery uses ICMP.

To configure iSNS cloud discovery message types, follow these steps:

	Command	Purpose
<b>Step 1</b>	switch# <b>config terminal</b> switch(config)#	Enters configuration mode.
<b>Step 2</b>	switch(config)# <b>cloud discovery message icmp</b>	Enables (default) iSNS cloud discovery using ICMP messages.
		<b>Note</b> Only ICMP messages are supported.

## Verifying Cloud Discovery Status

Use the **show cloud discovery status** command to verify the status of the cloud discovery operation:

```
switch# show cloud discovery status
Discovery status: Succeeded
```

## Verifying Cloud Discovery Membership

Use the **show cloud membership all** command to verify the cloud membership for the switch:

```
switch# show cloud membership all
Cloud 2
  GigabitEthernet1/5 [20:00:00:0d:ec:02:c6:c0] IP Addr 10.10.10.5
  GigabitEthernet1/6 [20:00:00:0d:ec:02:c6:c0] IP Addr 10.10.10.6
#members=2
```

Use the **show cloud membership unresolved** command to verify the unresolved membership on the switch:

```
switch# show cloud membership unresolved
Undiscovered Cloud
  No members
```

## Displaying Cloud Discovery Statistics

Use the **show cloud discovery statistics** command to display the statistics for the cloud discovery operation:

```
switch# show cloud discovery statistics
Global statistics
  Number of Auto Discovery           = 1
  Number of Manual Discovery         = 0
  Number of cloud discovery (ping) messages sent = 1
  Number of cloud discovery (ping) success   = 1
```

## Default Settings

Table 4-2 lists the default settings for iSCSI parameters.

**Table 4-2** Default iSCSI Parameters

Parameters	Default
Number of TCP connections	One per iSCSI session
minimum-retransmit-time	300 msec
keepalive-timeout	60 seconds
max-retransmissions	4 retransmissions
PMTU discovery	Enabled
pmtu-enable reset-timeout	3600 sec
SACK	Enabled
max-bandwidth	1 Gbps
min-available-bandwidth	70 Mbps
round-trip-time	1 msec
Buffer size	4096 KB
Control TCP and data connection	No packets are transmitted
TCP congestion window monitoring	Enabled
Burst size	50 KB
Jitter	500 microseconds
TCP connection mode	Active mode is enabled
Fibre Channel targets to iSCSI	Not imported
Advertising iSCSI target	Advertised on all Gigabit Ethernet interfaces, subinterfaces, port channel interfaces, and port channel subinterfaces

**Table 4-2** *Default iSCSI Parameters (continued)*

<b>Parameters</b>	<b>Default</b>
iSCSI hosts mapping to virtual Fibre Channel hosts	Dynamic mapping
Dynamic iSCSI initiators	Members of the VSAN 1
Identifying initiators	iSCSI node names
Advertising static virtual targets	No initiators are allowed to access a virtual target (unless explicitly configured)
iSCSI login authentication	CHAP or none authentication mechanism
revert-primary-port	Disabled
Header and data digest	Enabled automatically when iSCSI initiators send requests. This feature cannot be configured and is not available in store-and-forward mode.
iSNS registration interval	60 sec (not configurable)
iSNS registration interval retries	3
Fabric distribution	Disabled

Table 4-3 lists the default settings for iSLB parameters.

**Table 4-3** *Default iSLB Parameters*

<b>Parameters</b>	<b>Default</b>
Fabric distribution	Disabled
Load balancing metric	1000



## Configuring IP Services

---

Cisco MDS 9000 Family switches can route IP traffic between Ethernet and Fibre Channel interfaces. The IP static routing feature is used to route traffic between VSANs. To do so, each VSAN must be in a different IP subnetwork. Each Cisco MDS 9000 Family switch provides the following services for network management systems (NMSs):

- IP forwarding on the out-of-band Ethernet interface (mgmt0) on the front panel of the supervisor modules.
- IP forwarding on in-band Fibre Channel interface using the IP over Fibre Channel (IPFC) function—IPFC specifies how IP frames can be transported over Fibre Channel using encapsulation techniques. IP frames are encapsulated into Fibre Channel frames so NMS information can cross the Fibre Channel network without using an overlay Ethernet network.
- IP routing (default routing and static routing)—If your configuration does not need an external router, you can configure a default route using static routing.

Switches are compliant with RFC 2338 standards for Virtual Router Redundancy Protocol (VRRP) features. VRRP is a restartable application that provides a redundant, alternate path to the gateway switch.



**Note**

---

From Cisco MDS NX-OS Release 8.3(1) and later, the VRRP feature is not supported on Cisco MDS 9000 Series Switches.

---



**Note**

---

For information about configuring IPv6, see [Chapter 8, “Configuring IPv6 for Gigabit Ethernet Interfaces.”](#)

---

This chapter includes the following sections:

- [Traffic Management Services, page 5-224](#)
- [Management Interface Configuration, page 5-224](#)
- [Default Gateway, page 5-226](#)
- [IPv4 Default Network Configuration, page 5-229](#)
- [IP over Fibre Channel, page 5-230](#)
- [IPv4 Static Routes, page 5-235](#)
- [Overlay VSANs, page 5-236](#)
- [Configuring Multiple VSANs, page 5-238](#)

- [Virtual Router Redundancy Protocol, page 5-240](#)
- [DNS Configuration, page 5-252](#)
- [Default Settings for Distributed Name Server Features, page 5-253](#)

## Traffic Management Services

In-band options are compliant with and use the RFC 2625 standards. An NMS host running the IP protocol over an Fibre Channel interface can access the switch using the IPFC functionality. If the NMS does not have a Fibre Channel HBA, in-band management can still be performed using one of the switches as an access point to the fabric as shown in [Figure 5-1](#).

**Figure 5-1** Management Access to Switches

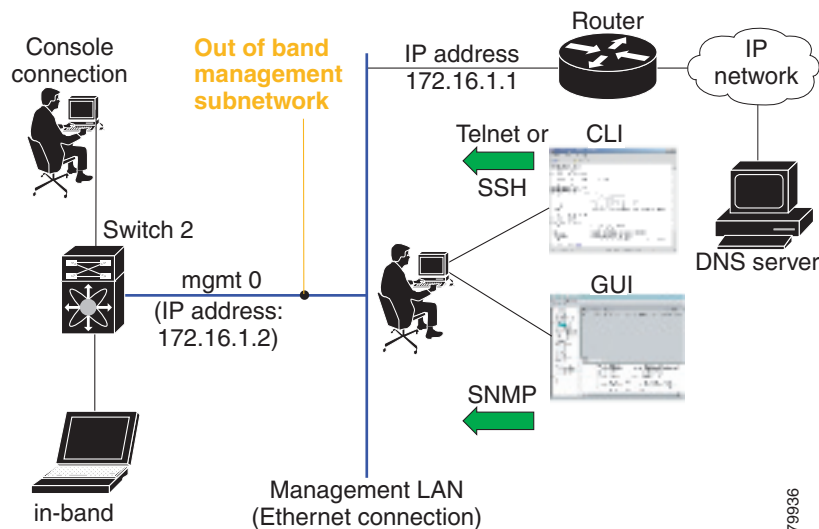

## Management Interface Configuration

The management interface on the switch allows multiple simultaneous Telnet or SNMP sessions. You can remotely configure the switch through the management interface, but first you must configure IP version 4 (IPv4) parameters (IP address, subnet mask) or an IP version 6 (IPv6) address and prefix length so that the switch is reachable. For information on configuring IPv6 addresses, see [Chapter 8, “Configuring IPv6 for Gigabit Ethernet Interfaces.”](#)

On director class switches, a single IP address is used to manage the switch. The active supervisor module's management (mgmt0) interface uses this IP address. The mgmt0 interface on the standby supervisor module remains in an inactive state and cannot be accessed until a switchover happens. After a switchover, the mgmt0 interface on the standby supervisor module becomes active and assumes the same IP address as the previously active supervisor module.



### Note

The port on the Ethernet switch to which the MDS management interface is connected should be configured as a host port (also known as access port) instead of a switch port. Spanning tree configuration for that port (on the Ethernet switch) should be disabled. This helps avoid the delay in the MDS management port coming up due to delay from Ethernet spanning tree processing that the Ethernet

switch would run if enabled. For Cisco Ethernet switches, use either the **switchport host** command in Cisco IOS or the **set port host** command in the Catalyst OS. Refer to the configuration guide for your Ethernet switch.



**Note** Before you begin to configure the management interface manually, obtain the switch's IP address and IP subnet mask. Also make sure the console cable is connected to the console port.

To configure the mgmt0 Ethernet interface for IPv4, follow these steps:

	Command	Purpose
<b>Step 1</b>	switch# <b>config terminal</b> switch(config)#	Enters configuration mode.
<b>Step 2</b>	switch(config)# <b>interface mgmt0</b> switch(config-if)#	Enters the interface configuration mode on the management Ethernet interface (mgmt0).
<b>Step 3</b>	switch(config-if)# <b>ip address</b> <b>10.1.1.1 255.255.255.0</b>	Enters the IPv4 address (10.1.1.1) and IPv4 subnet mask (255.255.255.0) for the management interface.
<b>Step 4</b>	switch(config-if)# <b>no shutdown</b>	Enables the interface.

To configure the mgmt0 Ethernet interface for IPv6, follow these steps:

	Command	Purpose
<b>Step 1</b>	switch# <b>config terminal</b> switch(config)#	Enters configuration mode.
<b>Step 2</b>	switch(config)# <b>interface mgmt0</b> switch(config-if)#	Enters the interface configuration mode on the management Ethernet interface (mgmt0).
<b>Step 3</b>	switch(config-if)# <b>ipv6 address</b> <b>2001:0db8:800:200c::417a/64</b>	Enters the IPv6 address (2001:0DB8:800:200C::417A) and IPv6 prefix length (/64) for the management interface and enables IPv6 processing on the interface.
	switch(config-if)# <b>ipv6 enable</b>	Automatically configures a link-local IPv6 address on the interface and enables IPv6 processing on the interface.
<b>Step 4</b>	switch(config-if)# <b>no shutdown</b>	Enables the interface.

To configure the mgmt0 Ethernet interface using Device Manager for IPv6, follow these steps:

- Step 1** Select **Interface > Mgmt > Mgmt0**.
- Step 2** Enter the description.
- Step 3** Select the administrative state of the interface.
- Step 4** Check the **CDP** check box to enable CDP.
- Step 5** Enter the IP address mask.
- Step 6** Click **Apply** to apply the changes.

## Default Gateway

You can configure a default gateway IPv4 address on your Cisco MDS 9000 Family switch.

This section includes the following topics:

- [Configuring the Default Gateway, page 5-226](#)
- [Verifying the Default Gateway Configuration, page 5-228](#)

The default gateway IPv4 address should be configured along with the IPv4 static routing attributes (IP default network, destination prefix, and destination mask, and next hop address). If you configure the static route IP forwarding and the default-network details, these IPv4 addresses will be used regardless of the default-gateway being enabled or disabled.

The default gateway IPv4 address should be configured along with the IPv4 static routing attributes commands (IP default network, destination prefix, and destination mask, and next hop address).



**Tip**

If you configure the static route IP forwarding and the default-network details, these IPv4 addresses will be used regardless of the default-gateway being enabled or disabled. If these IP addresses are configured but not available, the switch will fall back to using the default gateway IP address, if you have configured it. Be sure to configure IP addresses for all entries in the switch.

Use the **ip default-gateway** command to configure the IP address for a switch's default gateway and the **show ip route** command to verify that the IPv4 address for the default gateway is configured.

## Configuring the Default Gateway

To configure an IP route using Fabric Manager, follow these steps:

**Step 1** Select **Switches > Interfaces > Management**, and select **IP** in the Physical Attributes pane.

**Step 2** Click the **Route** tab in the information pane.

You see the IP route window showing the switch name, destination, mask, gateway, metric, interface, and active status of each IP route as shown in [Figure 5-2](#).

To configure the default gateway, follow these steps:

	Command	Purpose
<b>Step 1</b>	switch# <b>config t</b> switch(config)#	Enters configuration mode.
<b>Step 2</b>	switch(config)# <b>ip default-gateway 1.12.11.1</b>	Configures the IPv4 address for the default gateway.

Figure 5-2 IP Route For Multiple Switches

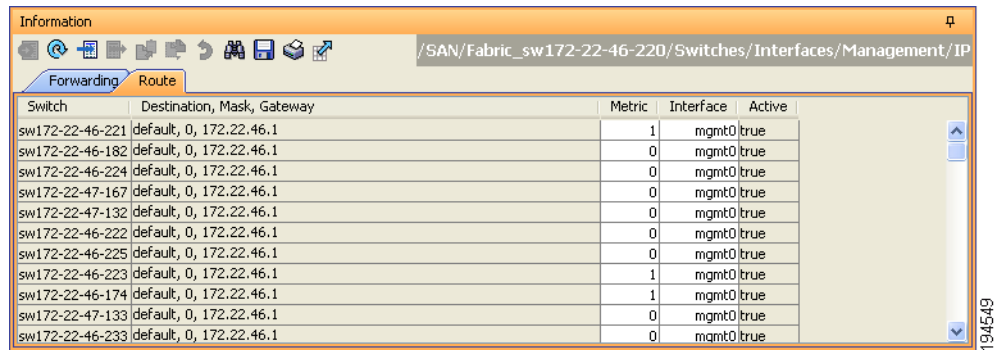

Switch	Destination, Mask, Gateway	Metric	Interface	Active
sw172-22-46-221	default, 0, 172.22.46.1	1	mgmt0	true
sw172-22-46-182	default, 0, 172.22.46.1	0	mgmt0	true
sw172-22-46-224	default, 0, 172.22.46.1	0	mgmt0	true
sw172-22-47-167	default, 0, 172.22.46.1	0	mgmt0	true
sw172-22-47-132	default, 0, 172.22.46.1	0	mgmt0	true
sw172-22-46-222	default, 0, 172.22.46.1	0	mgmt0	true
sw172-22-46-225	default, 0, 172.22.46.1	0	mgmt0	true
sw172-22-46-223	default, 0, 172.22.46.1	1	mgmt0	true
sw172-22-46-174	default, 0, 172.22.46.1	1	mgmt0	true
sw172-22-47-133	default, 0, 172.22.46.1	0	mgmt0	true
sw172-22-46-233	default, 0, 172.22.46.1	0	mgmt0	true

- Step 3** Click the **Create Row** icon to add a new IP route.  
You see the dialog box shown in Figure 5-3.

Figure 5-3 User-Defined Command Dialog Box

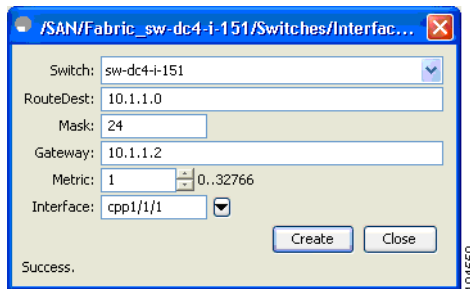

Switch: sw-dc4-i-151  
 RouteDest: 10.1.1.0  
 Mask: 24  
 Gateway: 10.1.1.2  
 Metric: 1 (0..32766)  
 Interface: cpp1/1/1  
 Create Close  
 Success.

- Step 4** Complete the fields in this window.
- Enter the switch name in the Switch field.
  - Configure a static route, by entering the destination network ID and subnet mask in the Routedest and Mask fields.
  - Configure a default gateway by entering the IP address of the seed switch in the Gateway field.
  - Set the Metric and Interface fields.

**Note**

With Cisco NX-OS Release 4.2(1) and later, CPP interfaces also are available for selection when you create a new IP route.

- Step 5** Click the **Create** icon.

To configure an IP route or identify the default gateway using Device Manager, follow these steps:

- Step 1** Choose **IP > Routes**.  
You see the IP Routes window.
- Step 2** Create a new IP route or identify the default gateway on a switch by clicking **Create**.  
You see the dialog box shown in Figure 5-4.

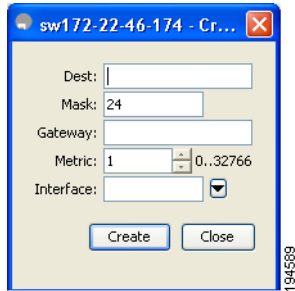
**Figure 5-4** User-Defined Command Dialog Box

**Step 3** Complete the fields in this window.

- Enter the switch name in the Switch field.
- Configure a static route, by entering the destination network ID and subnet mask in the Routedest and Mask fields.
- Configure a default gateway by entering the IP address of the seed switch in the Gateway field.
- Set the Metric and Interface fields.



**Note** With Cisco NX-OS Release 4.2(1) and later, CPP interfaces also are available for selection when you create a new IP route.

If you choose the CPP interface, the switch uses the input CPP-assigned IP address and mask to generate the IP route prefix.

**Step 4** Click **Create** to add the IP route.

The new IP route is created as shown in [Figure 5-5](#).

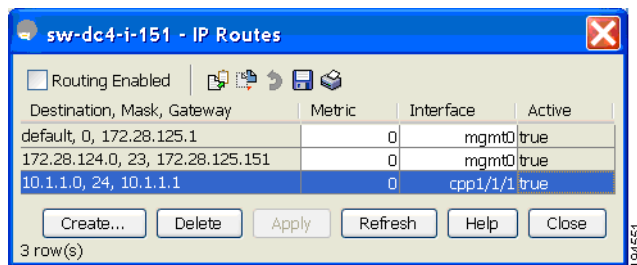
**Figure 5-5** IP Route Window

**Note** You cannot delete the switch-generated IP route for the CPP interface. If you try to delete the IP route for the CPP interface, SNMP displays this error message:

```
ip: route type not supported.
```

## Verifying the Default Gateway Configuration

Use the `show ip route` command to verify the default gateway configuration.

```

switch# show ip route

Codes: C - connected, S - static

Gateway of last resort is 1.12.11.1

S 5.5.5.0/24 via 1.1.1.1, GigabitEthernet1/1
C 1.12.11.0/24 is directly connected, mgmt0
C 1.1.1.0/24 is directly connected, GigabitEthernet1/1
C 3.3.3.0/24 is directly connected, GigabitEthernet1/6
C 3.3.3.0/24 is directly connected, GigabitEthernet1/5
S 3.3.3.0/24 via 1.1.1.1, GigabitEthernet1/1

```

## IPv4 Default Network Configuration

If you assign the IPv4 default network address, the switch considers routes to that network as the last resort. If the IPv4 default network address is not available, the switch uses the IPv4 default gateway address. For every network configured with the IPv4 default network address, the switch flags that route as a candidate default route, if the route is available.

If you configure the static route IP forwarding and the default network details, these IPv4 addresses will be used regardless of the default gateway being enabled or disabled. If these IPv4 addresses are configured and not available, the switch will fall back to using the default gateway IPv4 address, if you have configured it. Be sure to configure IPv4 addresses for all entries in the switch if you are using IPv4.

When the Ethernet interface is configured, the switch should point to the gateway router for the IP network. The host accesses the gateway using a gateway switch. This gateway switch is configured as the default gateway. The other switches in the fabric that are connected to the same VSAN as the gateway switch can also be connected through the gateway switch. Every interface connected to this VSAN should be configured with the VSAN IPv4 address of the gateway switch as shown in [Figure 5-6](#).

**Figure 5-6** Overlay VSAN Functionality

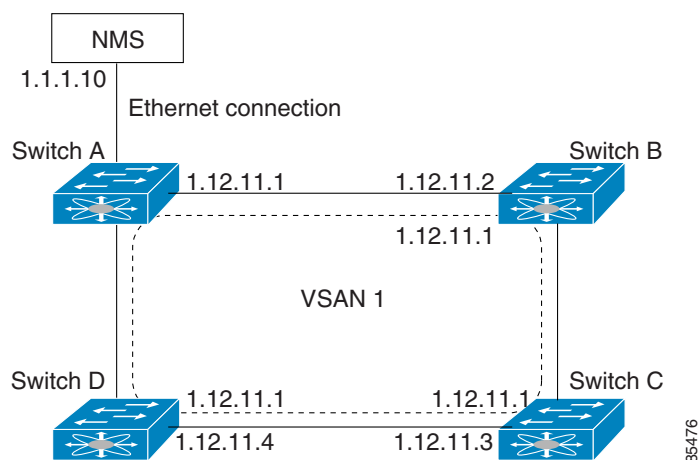

In [Figure 5-1](#), switch A has the IPv4 address 1.12.11.1, switch B has the IPv4 address 1.12.11.2, switch C has the IPv4 address 1.12.11.3, and switch D has the IPv4 address 1.12.11.4. Switch A is the gateway switch with the Ethernet connection. The NMS uses the IPv4 address 1.1.1.10 to connect to the gateway switch. Frames forwarded to any switch in the overlaid VSAN 1 are routed through the gateway switch.

Configuring the gateway switch's IPv4 address (1.12.11.1) in the other switches enable the gateway switch to forward the frame to the intended destination. Similarly, if a non-gateway switch in the VSAN forwards a frame to the Ethernet, the frame is routed through the gateway switch.

When forwarding is disabled (default), IP frames are not sent from one interface to another. In these cases, the software performs local IP routing between two switches using the in-band option for Fibre Channel traffic and the mgmt0 option for Ethernet traffic.

When a VSAN is created, a VSAN interface is not created automatically. You need to specifically create the interface.

To configure default networks using IPv4 addresses, follow these steps:

	Command	Purpose
Step 1	switch# <b>config t</b>	Enters configuration mode.
Step 2	switch(config)# <b>ip default-network 190.10.1.0</b>	Configures the IPv4 address for the default network (190.10.1.0).
	switch(config)# <b>ip route 10.0.0.0 255.0.0.0 131.108.3.4</b> switch(config)# <b>ip default-network 10.0.0.0</b>	Defines a static route to network 10.0.0.0 as the static default route.

## IP over Fibre Channel

IP over Fibre Channel (IPFC) provides IP forwarding on in-band switch management over a Fibre Channel interface (rather than out-of-band using the Gigabit Ethernet mgmt 0 interface). You can use IPFC to specify that IP frames can be transported over Fibre Channel using encapsulation techniques. IP frames are encapsulated into Fibre Channel frames so NMS information can cross the Fibre Channel network without using an overlay Ethernet network.

Once the VSAN interface is created, you can specify the IP address for that VSAN. You can assign an IPv4 address or an IPv6 address.



### Note

See the [Chapter 8, “Configuring IPv6 for Gigabit Ethernet Interfaces”](#) for information about configuring IPv6 on the Cisco MDS 9000 Family switches.

This topic includes the following sections:

- [IPFC Configuration, page 5-230](#)
- [Configuring an IPv4 Address in a VSAN, page 5-231](#)
- [Verifying the VSAN Interface Configuration, page 5-231](#)
- [Enabling IPv4 Routing, page 5-231](#)
- [Verifying the IPv4 Routing Configuration, page 5-231](#)
- [IPFC Configuration Example, page 5-232](#)

## IPFC Configuration

Follow this procedure to configure IPFC:

1. Create the VSAN to use for in-band management, if necessary.
2. Configure an IPv4 address and subnet mask for the VSAN interface.

3. Enable IPv4 routing.
4. Verify connectivity.

## Configuring an IPv4 Address in a VSAN

To create a VSAN interface and configure an IPv4 address for that interface, follow these steps:

	Command	Purpose
Step 1	switch# <b>config t</b>	Enters configuration mode.
Step 2	switch(config)# <b>interface vsan 10</b> switch(config-if)#	Configures the interface for the specified VSAN (10).
Step 3	switch(config-if)# <b>ip address 10.0.0.12 255.255.255.0</b>	Configures the IPv4 address and netmask for the selected interface.
Step 4	switch(config-if)# <b>no shutdown</b>	Enables the interface.

## Verifying the VSAN Interface Configuration

Use the **show interface vsan** command to verify the configuration of the VSAN interface.



### Note

You can see the output for this command only if you have previously configured a VSAN interface.

```
switch# show interface vsan 1
vsan1 is down (Administratively down)
  WWPN is 10:00:00:0c:85:90:3e:85, FCID not assigned
  Internet address is 10.0.0.12/24
  MTU 1500 bytes, BW 1000000 Kbit
  0 packets input, 0 bytes, 0 errors, 0 multicast
  0 packets output, 0 bytes, 0 errors, 0 dropped
```

## Enabling IPv4 Routing

By default, the IPv4 routing feature is disabled in all switches.

To enable the IPv4 routing feature, follow these steps:

	Command	Purpose
Step 1	switch# <b>config t</b>	Enters configuration mode.
Step 2	switch(config)# <b>ip routing</b>	Enables IPv4 routing (disabled by default).
Step 3	switch(config)# <b>no ip routing</b>	Disables IPv4 routing and reverts to the factory settings.

## Verifying the IPv4 Routing Configuration

Use the **show ip routing** command to verify the IPv4 routing configuration.

```
switch(config)# show ip routing
ip routing is enabled
```

## IPFC Configuration Example

This section describe an example configuration for IPFC. [Figure 5-7](#) shows an example network.

The example network has the following links:

- Switch\_1 is connected to the main network by the mgmt 0 interface and to the fabric by an ISL.
- Switch\_2 and Switch\_3 are connected to the fabric by an ISL but are not connected to the main network.

**Figure 5-7 IPFC Example Network**

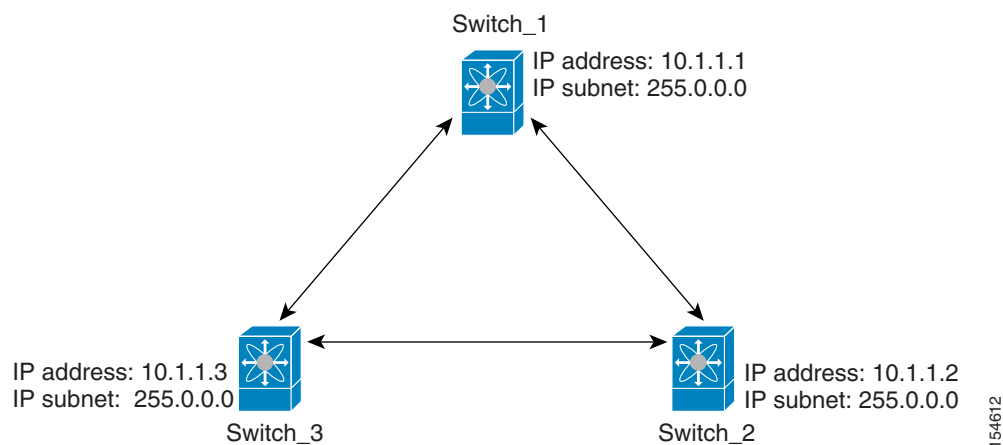

The following steps show how to configure Switch\_1 in the example network in [Figure 5-7](#):

**Step 1** Create the VSAN interface and enter interface configuration submode:

```
switch_1# config t
switch_1(config)# interface vsan 1
switch_1(config-if)#
```

**Step 2** Configure the IP address and subnet mask:

```
switch_1(config-if)# ip address 10.1.1.1 255.0.0.0
```

**Step 3** Enable the VSAN interface and exit interface configuration submode:

```
switch_1(config-if)# no shutdown
switch_1(config-if)# exit
switch_1(config)#
```

**Step 4** Enable IPv4 routing:

```
switch_1(config)# ip routing
switch_1(config)# exit
switch_1#
```

**Step 5** Display the routes:

```
switch_1# show ip route
```

```
Codes: C - connected, S - static

C 172.16.1.0/23 is directly connect, mgmt0
C 10.0.0.0./8 is directly connected, vsan1
```

The following steps show how to configure Switch\_2 in the example network in [Figure 5-7](#):

**Step 1** Enable the mgmt 0 interface:



**Note** Configure this switch using the console connection.

```
switch_2# config t
switch_2(config)# interface mgmt 0
switch_2(config-if)# no shutdown
switch_2(config-if)# exit
switch_2(config)#
```

**Step 2** Create the VSAN interface and enter interface configuration:

```
switch_2# config t
switch_2(config)# interface vsan 1
switch_2(config-if)#
```

**Step 3** Configure the IP address and subnet mask:

```
switch_2(config-if)# ip address 10.1.1.2 255.0.0.0
```

**Step 4** Enable the VSAN interface and exit interface configuration submode:

```
switch_2(config-if)# no shutdown
switch_2(config-if)# exit
switch_2(config)#
```

**Step 5** Enable IPv4 routing:

```
switch_2(config)# ip routing
switch_2(config)# exit
switch_2#
```

**Step 6** Display the routes:

```
switch_2# show ip route

Codes: C - connected, S - static

C 10.0.0.0./8 is directly connected, vsan1
```

**Step 7** Verify the connectivity to Switch\_1:

```
switch_2# ping 10.1.1.1
PING 10.1.1.1 (10.1.1.1) 56(84) bytes of data.
64 bytes from 10.1.1.1: icmp_seq=1 ttl=64 time=0.618 ms
64 bytes from 10.1.1.1: icmp_seq=2 ttl=64 time=0.528 ms
64 bytes from 10.1.1.1: icmp_seq=3 ttl=64 time=0.567 ms

--- 10.1.1.1 ping statistics ---
3 packets transmitted, 3 received, 0% packet loss, time 4998 ms
rtt min/avg/max/mdev = 0.528/0.570/0.618/0.057 ms
```

The following steps show how to configure Switch\_3 in the example network in [Figure 5-7](#):

**Step 1** Enable the mgmt 0 interface:



**Note** Configure this switch using the console connection.

```
switch_3# config t
switch_3(config)# interface mgmt 0
switch_3(config-if)# no shutdown
switch_3(config-if)# exit
switch_3(config)#
```

```
switch_3# config t
switch_3(config)# interface vsan 1
switch_3(config-if)#
```

**Step 2** Configure the IP address and subnet mask:

```
switch_3(config-if)# ip address 10.1.1.3 255.0.0.0
```

**Step 3** Enable the VSAN interface and exit interface configuration submode:

```
switch_3(config-if)# no shutdown
switch_3(config-if)# exit
switch_3(config)#
```

**Step 4** Enable IPv4 routing:

```
switch_3(config)# ip routing
switch_3(config)# exit
switch_3#
```

**Step 5** Display the routes:

```
switch_3# show ip route
```

```
Codes: C - connected, S - static
```

```
C 10.0.0.0./8 is directly connected, vsan1
```

**Step 6** Verify the connectivity to Switch\_1:

```
switch_3# ping 10.1.1.1
PING 10.1.1.1 (10.1.1.1) 56(84) bytes of data.
64 bytes from 10.1.1.1: icmp_seq=1 ttl=64 time=1.19 ms
64 bytes from 10.1.1.1: icmp_seq=2 ttl=64 time=0.510 ms
64 bytes from 10.1.1.1: icmp_seq=3 ttl=64 time=0.653 ms

--- 10.1.1.1 ping statistics ---
3 packets transmitted, 3 received, 0% packet loss, time 2008 ms
rtt min/avg/max/mdev = 0.510/0.787/1.199/0.297 ms
```

## IPv4 Static Routes

If your network configuration does not need an external router, you can configure IPv4 static routing on your MDS switch.

**Note**

For information about IPv6 static routing, see the [Chapter 8, “Configuring IPv6 for Gigabit Ethernet Interfaces.”](#)

This section includes the following topics:

- [Overview of IPv4 Static Routes, page 5-235](#)
- [Configuring IPv4 Static Routes, page 5-235](#)
- [Verifying IPv4 Static Route Information, page 5-235](#)
- [Displaying and Clearing ARPs, page 5-236](#)

## Overview of IPv4 Static Routes

Static routing is a mechanism to configure IPv4 routes on the switch. You can configure more than one static route.

If a VSAN has multiple exit points, configure static routes to direct traffic to the appropriate gateway switch. IPv4 routing is disabled by default on any gateway switch between the out-of-band management interface and the default VSAN, or between directly connected VSANs.

## Configuring IPv4 Static Routes

To configure an IPv4 static route, follow these steps:

	Command	Purpose
Step 1	switch# <b>config t</b>	Enters configuration mode.
Step 2	switch(config)# <b>ip route</b> <i>network IP address netmask next hop IPv4 address distance number interface vsan number</i>  For example: switch(config)# <b>ip route 10.0.0.0 255.0.0.0 20.20.20.10 distance 10 interface vsan 1</b> switch(config)#	Configures the static route for the specified IPv4 address, subnet mask, next hop, distance, and interface.

## Verifying IPv4 Static Route Information

Use the **show ip route** command to verifying the IPv4 static route configuration:

```
switch# show ip route configured
Destination          Gateway             Mask Metric         Interface
-----
          default          172.22.95.1        0.0.0.0     0             mgmt0
          10.1.1.0           0.0.0.0           255.255.255.0 0             vsan1
          172.22.95.0        0.0.0.0           255.255.255.0 0             mgmt0
```

Use the **show ip route** command to verifying the active and connected IPv4 static route:

```
switch# show ip route

Codes: C - connected, S - static

Default gateway is 172.22.95.1

C 172.22.95.0/24 is directly connected, mgmt0
C 10.1.1.0/24 is directly connected, vsan1
```

### Example 5-1 Displaying the IP Routing Status

```
switch# show ip routing
ip routing is disabled
```

## Displaying and Clearing ARPs

Address Resolution Protocol (ARP) entries in Cisco MDS 9000 Family switches can be displayed, deleted, or cleared. The ARP feature is enabled on all switches.

- Use the **show arp** command to display the ARP table.

```
switch# show arp
Protocol Address          Age (min)  Hardware Addr  Type  Interface
Internet 171.1.1.1              0  0006.5bec.699c  ARPA  mgmt0
Internet 172.2.0.1              4  0000.0c07.ac01  ARPA  mgmt0
```

- Use the **no arp** command in configuration mode to remove an ARP entry from the ARP table.

```
switch(config)# no arp 172.2.0.1
```

- Use the **clear arp** command to delete all entries from the ARP table. The ARP table is empty by default:

```
switch# clear arp-cache
```

## Overlay VSANs

This section describes overlay VSANs and how to configure them.

This section includes the following topics:

### Overlay VSANs

VSANs enable deployment of larger SANs by overlaying multiple logical SANs, each running its own instance of fabric services, on a single large physical network. This partitioning of fabric services reduces network instability by containing fabric reconfiguration and error conditions within an individual VSAN. VSANs also provide the same isolation between individual VSANs as physically separated SANs. Traffic cannot cross VSAN boundaries and devices may not reside in more than one VSAN. Because each VSAN runs separate instances of fabric services, each VSAN has its own zone server and can be zoned in exactly the same way as SANs without VSAN capability.

## Configuring Overlay VSANs

To configure an overlay VSAN, follow these steps:

- Step 1** Add the VSAN to the VSAN database on all switches in the fabric.
- Step 2** Create a VSAN interface for the VSAN on all switches in the fabric. Any VSAN interface belonging to the VSAN has an IP address in the same subnet. Create a route to the IPFC cloud on the IP side.
- Step 3** Configure a default route on every switch in the Fibre Channel fabric pointing to the switch that provides NMS access.
- Step 4** Configure the default gateway (route) and the IPv4 address on switches that point to the NMS as shown in [Figure 5-8](#):

**Figure 5-8** Overlay VSAN Configuration Example

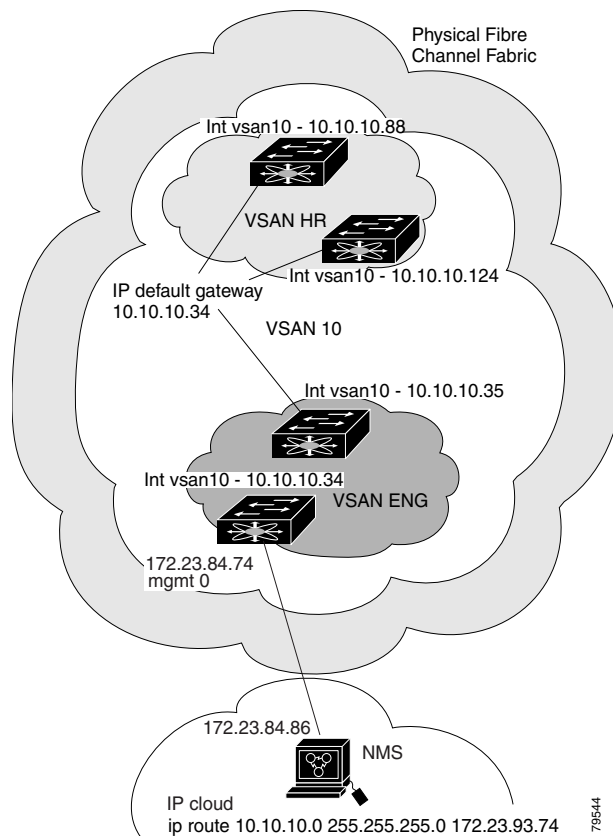

**Note**

To configure the management interface displayed in [Figure 5-8](#), set the default gateway to an IPv4 address on the Ethernet network.

The following procedure configures an overlay VSAN in one switch. This procedure must be repeated for each switch in the fabric.

To configure an overlay VSAN in one switch (using the example in [Figure 5-8](#)), follow these steps:

	<b>Command</b>	<b>Purpose</b>
<b>Step 1</b>	switch# <b>config t</b>	Enters configuration mode.
<b>Step 2</b>	switch(config)# <b>vsan database</b> switch-config-vsan-db#	Configures the VSAN database.
<b>Step 3</b>	switch--config-vsan-db# <b>vsan 10 name MGMT_VSAN</b>	Defines the VSAN in the VSAN database on all of the switches in the Fibre Channel fabric.
<b>Step 4</b>	switch--config-vsan-db# <b>exit</b> switch(config)#	Exits the VSAN database mode.
<b>Step 5</b>	switch(config)# <b>interface vsan 10</b> switch(config-if)#	Creates a VSAN interface (VSAN 10).
<b>Step 6</b>	switch(config-if)# <b>ip address 10.10.10.0</b> <b>netmask 255.255.255.0</b>	Assigns an IPv4 address and subnet mask for this switch.
<b>Step 7</b>	switch(config-if)# <b>no shutdown</b>	Enables the configured interface.
<b>Step 8</b>	switch(config-if)# <b>end</b> switch#	Exits to EXEC mode.
<b>Step 9</b>	switch# <b>exit</b>	Exits the switch and returns to the NMS. In this example the NMS is assumed to be on the same subnet of the Ethernet management interface of the edge that provides access to the Fibre Channel fabric.

To configure the NMS station displayed in [Figure 5-8](#), follow this step:

	<b>Command</b>	<b>Purpose</b>
<b>Step 1</b>	nms# <b>route ADD 10.10.10.0 MASK 255.255.255.0</b> <b>172.22.93.74</b>	Defines a static route on the NMS pointing to the management interface of the edge switch that provides access to the Fibre Channel fabric.

## Configuring Multiple VSANs

More than one VSAN can be used to segment the management network in multiple subnets. An active interface must be present on the switch for the VSAN interface to be enabled.

To configure multiple VSANs, follow these steps:

- 
- Step 1** Add the VSAN to the VSAN database on any switch in the fabric.
  - Step 2** Create a VSAN interface for the appropriate VSAN on any switch in the fabric.
  - Step 3** Assign an IP address on every VSAN interface on the same subnet as the corresponding VSAN.

**Step 4** Define the multiple static routes on the Fibre Channel switches and the IP cloud as shown in [Figure 5-9](#):

**Figure 5-9 Multiple VSAN Configuration Example**

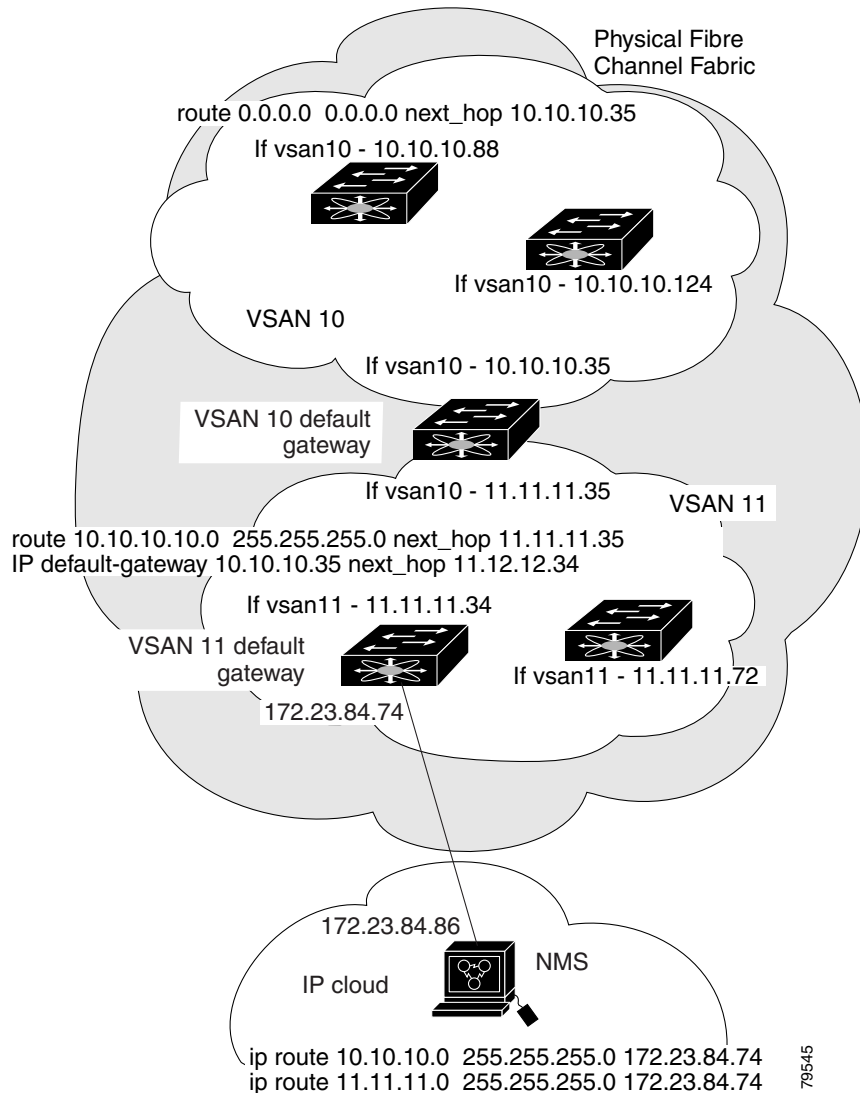

To configure an overlay VSAN (using the example in [Figure 5-9](#)), follow these steps:

	Command	Purpose
<b>Step 1</b>	switch# <b>config t</b>	Enters configuration mode.
<b>Step 2</b>	switch(config)# <b>vsan database</b> switch-config-vsan-db#	Configures the VSAN database.
<b>Step 3</b>	switch-config-vsan-db# <b>vsan 10 name MGMT_VSAN_10</b> switch-config-vsan-db#	Defines the VSAN in the VSAN database on all of the switches in VSAN 10.
<b>Step 4</b>	switch-config-vsan-db# <b>exit</b> switch(config)#	Exits the VSAN database configuration submode.

	Command	Purpose
Step 5	switch-config-vsantdb# <b>vsan 11 name MGMT_VSAN_11</b> switch-config-vsantdb#	Defines the VSAN in the VSAN database on all of the switches in VSAN 11.
Step 6	switch-config-vsantdb# <b>exit</b> switch(config)#	Exits the VSAN database configuration submode.
Step 7	switch(config)# <b>interface vsan 10</b> switch(config-if)#	Enters the interface configuration submode for VSAN 10.
Step 8	switch(config-if)# <b>ip address 10.10.10.0 netmask 255.255.255.0</b> switch(config-if)#	Assigns an IPv4 address and subnet mask for this interface.
Step 9	switch(config-if)# <b>no shutdown</b>	Enables the configured interface for VSAN 10.
Step 10	switch(config-if)# <b>exit</b> switch(config)#	Exits the VSAN 10 interface mode.
Step 11	switch(config)# <b>interface vsan 11</b> switch(config-if)#	Enters the interface configuration submode for VSAN 11.
Step 12	switch(config-if)# <b>ip address 11.11.11.0 netmask 255.255.255.0</b> switch(config-if)#	Assigns an IPv4 address and subnet mask for this interface.
Step 13	switch(config-if)# <b>no shutdown</b>	Enables the configured interface for VSAN 11.
Step 14	switch(config-if)# <b>end</b> switch#	Exits to EXEC mode.
Step 15	switch# <b>exit</b>	Exits the switch and returns to the NMS. In this example the NMS is assumed to be on the same subnet of the Ethernet management interface of the edge that provides access to the Fibre Channel fabric.
Step 16	NMS# <b>route ADD 10.10.10.0 MASK 255.255.255.0 172.22.93.74</b>	Defines a static route on the NMS pointing to the management interface of the edge switch that provides access to the IPv4 cloud.
Step 17	NMS# <b>route ADD 11.11.11.0 MASK 255.255.255.0 172.22.93.74</b>	Defines a static route for VSAN 11 on the NMS pointing to the management interface of the edge switch that provides access to the Fibre Channel fabric.
Step 18	switch# <b>route 10.10.10.0 255.255.255.0 next_hop 11.11.11.35</b>	Defines the route to reach subnet 10 from subnet 11.

## Virtual Router Redundancy Protocol

Cisco MDS 9000 Family switches are compliant with RFC 2338 standards for Virtual Router Redundancy Protocol (VRRP) features. This section provides details on the VRRP feature.

This section includes the following topics:

- [Overview of VRRP, page 5-241](#)

- [Configuring VRRP, page 5-242](#)

## Overview of VRRP

Cisco MDS 9000 Family switches are compliant with RFC 2338 standards for Virtual Router Redundancy Protocol (VRRP) features. VRRP provides a redundant alternative path to the gateway switch, which has connectivity to the NMS.

**Note**

---

VRRP is not supported on Cisco MDS 24/10 port SAN Extension Module.

---

VRRP has the following characteristics and advantages:

- VRRP is a restartable application.
- When a VRRP master fails, the VRRP backup takes over within three times the advertisement time.
- VRRP over Ethernet, VRRP over VSAN, and Fibre Channel functions are implemented as defined in RFC 2338 and the draft-ietf-vrrp-ipv6 specification.
- A virtual router is mapped to each VSAN and Ethernet interface with its unique virtual router IP, virtual router MAC, and VR ID.
- VR IDs can be reused in multiple VSANs with different virtual router IP mapping.
- Both IPv4 and IPv6 is supported.
- The management interface (mgmt 0) supports only one virtual router group. All other interfaces each support up to seven virtual router groups, including both IPv4 and IPv6 combined. Up to 255 virtual router groups can be assigned in each VSAN.
- VRRP security provides three options, including no authentication, simple text authentication, and MD5 authentication.

**Note**

---

If you are using IPv6, you must either configure an IPv6 address on the interface or enable IPv6 on the interface. For more information about IPv6, see [Chapter 8, “Configuring IPv6 for Gigabit Ethernet Interfaces.”](#)

---

In [Figure 5-10](#), switch A is the VRRP master and switch B is the VRRP backup switch. Both switches have an IP address to VRRP mapping configured. The other switches set switch A as the default gateway. If switch A fails, the other switches do not have to change the routing configurations as switch B automatically becomes the master and takes over the function of a gateway.

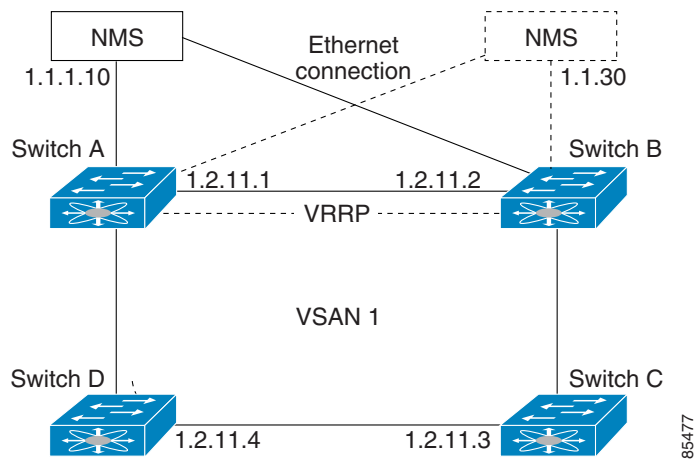
**Figure 5-10 VRRP Functionality**

In [Figure 5-11](#), the fabric example has two virtual router groups (VR1 and VR 2) because a virtual router cannot span across different types of interfaces. In both switch 1 and switch 2, the Ethernet interface is in VR 1 and the FC interface is in VR 2. Each virtual router is uniquely identified by the VSAN interface and the VR ID.

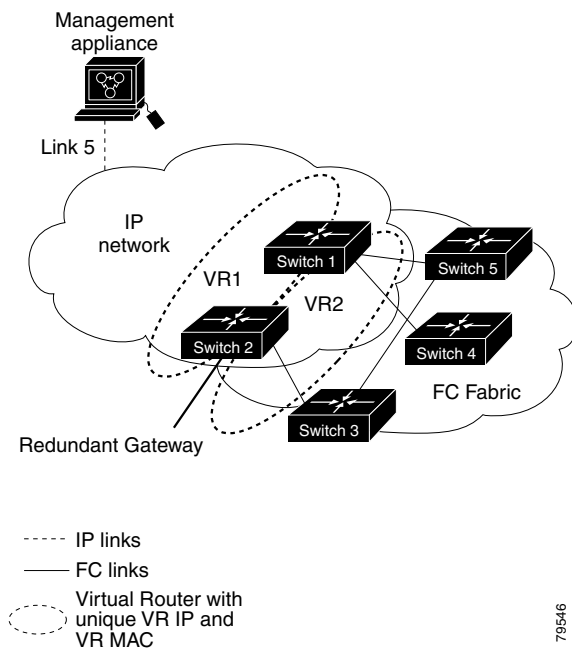
**Figure 5-11 Redundant Gateway**

## Configuring VRRP

This section describes how to configure VRRP and includes the following topics:

- [Adding and Deleting a Virtual Router, page 5-243](#)
- [Virtual Router Initiation, page 5-243](#)

- [Adding Virtual Router IP Addresses, page 5-244](#)
- [Setting the Priority for the Virtual Router, page 5-245](#)
- [Setting the Time Interval for Advertisement Packets, page 5-246](#)
- [Configuring or Enabling Priority Preemption, page 5-247](#)
- [Setting Virtual Router Authentication, page 5-247](#)
- [Tracking Interface Priority, page 5-248](#)
- [Displaying IPv4 VRRP Information, page 5-249](#)
- [Displaying IPv6 VRRP Information, page 5-250](#)
- [Displaying VRRP Statistics, page 5-251](#)
- [Clearing VRRP Statistics, page 5-251](#)

## Adding and Deleting a Virtual Router

All VRRP configurations should be replicated across switches in a fabric that runs VRRP.



### Note

The total number of VRRP groups that you can configure on a Gigabit Ethernet port, including main interfaces and subinterfaces, cannot exceed seven. This limitation applies to both IPv4 and IPv6 groups.

To create or remove a VR for IPv4, follow these steps:

	Command	Purpose
Step 1	switch# <b>config t</b> switch(config)#	Enters configuration mode.
Step 2	switch(config)# <b>interface vsan 10</b> switch(config-if)#	Configures a VSAN interface (VSAN 10).
Step 3	switch(config-if)# <b>vrrp 250</b> switch(config-if-vrrp)#	Creates VR ID 250.
	switch(config-if)# <b>no vrrp 250</b>	Removes VR ID 250.

To create or remove a VR for IPv6, follow these steps:

	Command	Purpose
Step 1	switch# <b>config t</b> switch(config)#	Enters configuration mode.
Step 2	switch(config)# <b>interface vsan 10</b> switch(config-if)#	Configures a VSAN interface (VSAN 10).
Step 3	switch(config-if)# <b>vrrp ipv6 250</b> switch(config-if-vrrp-ipv6)#	Creates VR ID 250.
	switch(config-if)# <b>no vrrp ipv6 250</b>	Removes VR ID 250.

## Virtual Router Initiation

By default, a virtual router is always disabled. VRRP can be configured only if this state is enabled. Be sure to configure at least one IP address, either IPv4 or IPv6, before attempting to enable a VR.

To enable or disable a virtual router configure for IPv4, follow these steps:

	Command	Purpose
Step 1	switch(config-if-vrrp)# <b>no shutdown</b>	Enables VRRP configuration.
	switch(config-if-vrrp)# <b>shutdown</b>	Disables VRRP configuration.

To enable or disable a virtual router configured for IPv6, follow these steps:

	Command	Purpose
Step 1	switch(config-if-vrrp-ipv6)# <b>no shutdown</b>	Enables VRRP configuration.
	switch(config-if-vrrp-ipv6)# <b>shutdown</b>	Disables VRRP configuration.

## Adding Virtual Router IP Addresses

One virtual router IP address can be configured for a virtual router. If the configured IP address is the same as the interface IP address, this switch automatically owns the IP address. You can configure either an IPv4 address or an IPv6 address.

According to the VRRP specification, the master VRRP router drops the packets addressed to the virtual router's IP address because the virtual router is only intended as a next-hop router to forward packets. In MDS switches however, some applications require that packets addressed to virtual router's IP address be accepted and delivered to them. By using the **secondary** option to the virtual router IPv4 address, the VRRP router will accept these packets when it is the master.

To manage IP addresses for virtual routers from Device Manager, follow these steps:

- 
- Step 1** Choose **IP > VRRP**. You see the **Operations** tab of the VRRP dialog box.
  - Step 2** Click the **IP Addresses** tab on the VRRP dialog box.
  - Step 3** To create a new VRRP entry, click **Create**. You see the Create VRRP IP Addresses window.
  - Step 4** Complete the fields in this window to create a new VRRP IP address, and click **OK** or **Apply**.
- 

To configure an IPv4 address for a virtual router, follow these steps:

	Command	Purpose
Step 1	switch# <b>config t</b>	Enters configuration mode.
Step 2	switch(config)# <b>interface vsan 10</b> switch(config-if)#	Configures a VSAN interface (VSAN 10).
Step 3	switch(config-if)# <b>interface ip address</b> <b>10.0.0.12 255.255.255.0</b>	Configures an IPv4 address and subnet mask. The IPv4 address must be configured before the VRRP is added.
Step 4	switch(config-if)# <b>vrrp 250</b> switch(config-if-vrrp)#	Creates VR ID 250.
Step 5	switch(config-if-vrrp)# <b>address 10.0.0.10</b>	Configures the IPv4 address for the selected VR. <b>Note</b> This IP v4address should be in the same subnet as the IPv4 address of the interface.
	switch(config-if-vrrp)# <b>no address 10.0.0.10</b>	Removes the IP address for the selected VR.

	Command	Purpose
Step 6	switch(config-if-vrrp)# <b>address 10.0.0.10 secondary</b>	Configures the IP address (10.0.0.10) as secondary for the selected VR.  <b>Note</b> The <b>secondary</b> option should be used only with applications that require VRRP routers to accept the packets sent to the virtual router's IP address and deliver to them.
	switch(config-if-vrrp)# <b>no address 10.0.0.10 secondary</b>	Removes the IP address (10.0.0.10) as secondary for the selected VR.

To configure an IPv6 address for a virtual router, follow these steps:

	Command	Purpose
Step 1	switch# <b>config t</b>	Enters configuration mode.
Step 2	switch(config)# <b>interface vsan 12</b> switch(config-if)#	Configures a VSAN interface (VSAN 12).
Step 3	switch(config-if)# <b>interface ipv6 address 2001:0db8:800:200c::417a/64</b>	Configures an IP address and prefix. The IPv6 address must be configured before the VRRP is added.
Step 4	switch(config-if)# <b>vrrp ipv6 200</b> switch(config-if-vrrp-ipv6)#	Creates VR ID 200.
Step 5	switch(config-if-vrrp-ipv6)# <b>address 2001:0db8:800:200c::417a</b>	Assigns single primary link-local IPv6 address or one of the multiple secondary IPv6 addresses.  <b>Note</b> If this IPv6 address is the same as the physical IPv6 address, this switch is automatically the owner of this IPv6 address.
	switch(config-if-vrrp-ipv6)# <b>no address 2001:0db8:800:200c::417a</b>	Removes the IPv6 address for the selected VR.

## Setting the Priority for the Virtual Router

The valid range to assign a virtual router priority is 1 to 254 with 1 being the lowest priority and 254 being the highest priority. The default value is 100 for switches with secondary IP addresses and 255 for switches with the primary IP address.

To set the priority for a virtual router using IPv4, follow these steps:

	Command	Purpose
Step 1	switch# <b>config t</b>	Enters configuration mode.
Step 2	switch(config)# <b>interface vsan 10</b> switch(config-if)#	Configures a VSAN interface (VSAN 10).
Step 3	switch(config-if)# <b>vrrp 250</b> switch(config-if-vrrp)#	Creates a virtual router.

	Command	Purpose
Step 4	switch(config-if-vrrp)# <b>priority 2</b>	Configures the priority for the selected VRRP. <b>Note</b> Priority 255 cannot be preempted.
	switch(config-if-vrrp)# <b>no priority</b>	Reverts to the default value (100 for switch with the secondary IPv4 addresses and 255 for switches with the primary IPv4 address).

To set the priority for a virtual router using IPv6, follow these steps:

	Command	Purpose
Step 1	switch# <b>config t</b>	Enters configuration mode.
Step 2	switch(config)# <b>interface vsan 12</b> switch(config-if)#	Configures a VSAN interface (VSAN 12).
Step 3	switch(config-if)# <b>vrrp ipv6 200</b> switch(config-if-vrrp-ipv6)#	Creates a virtual router.
Step 4	switch(config-if-vrrp-ipv6)# <b>priority 2</b>	Configures the priority for the selected VRRP. <b>Note</b> Priority 255 cannot be preempted.
	switch(config-if-vrrp-ipv6)# <b>no priority</b>	Reverts to the default value (100 for switch with the secondary IPv6 addresses and 255 for switches with the primary IPv6 address).

## Setting the Time Interval for Advertisement Packets

The valid time range for an advertisement packet on an interface using IPv4 is between 1 and 41 seconds. The default value is 1 (one) second. If the switch has the primary IP address, this time must be specified.

To set the time interval for advertisement packets for a virtual router using IPv4, follow these steps:

	Command	Purpose
Step 1	switch# <b>config t</b>	Enters configuration mode.
Step 2	switch(config)# <b>interface vsan 10</b> switch(config-if)#	Configures a VSAN interface (VSAN 10).
Step 3	switch(config-if)# <b>vrrp 50</b> switch(config-if-vrrp)#	Creates a virtual router.
Step 4	switch(config-if-vrrp)# <b>advertisement-interval 15</b>	Sets the interval time in seconds between sending advertisement frames. The range is 1 to 41.
	switch(config-if-vrrp)# <b>no advertisement-interval</b>	Reverts to the default value (1 second).

To set the time interval for advertisement packets for a virtual router using IPv6, follow these steps:

	Command	Purpose
Step 1	switch# <b>config t</b>	Enters configuration mode.
Step 2	switch(config)# <b>interface vsan 12</b> switch(config-if)#	Configures a VSAN interface (VSAN 12).
Step 3	switch(config-if)# <b>vrrp ipv6 200</b> switch(config-if-vrrp-ipv6)#	Creates a virtual router.

	Command	Purpose
Step 4	switch(config-if-vrrp-ipv6)# <b>advertisement-interval 150</b>	Sets the interval time in centiseconds between sending advertisement frames. The range is 100 to 4095. The default is 100 centiseconds.
	switch(config-if-vrrp-ipv6)# <b>no advertisement-interval</b>	Reverts to the default value (100 centiseconds).

## Configuring or Enabling Priority Preemption

You can enable a higher-priority backup virtual router to preempt the lower-priority master virtual router.



**Note** If the virtual IP address is also the IP address for the interface, then preemption is implicitly applied.

To enable or disable preempting when using IPv4, follow these steps:

	Command	Purpose
Step 1	switch# <b>config t</b>	Enters configuration mode.
Step 2	switch(config)# <b>interface vsan 10</b> switch(config-if)#	Configures a VSAN interface (VSAN 10).
Step 3	switch(config-if)# <b>vrrp 250</b> switch(config-if-vrrp)#	Creates a virtual router.
Step 4	switch(config-if-vrrp)# <b>preempt</b>	Enables the higher priority backup virtual router to preempt the lower priority master virtual router. <b>Note</b> This preemption does not apply to the primary IP address.
	switch(config-if-vrrp)# <b>no preempt</b>	Disables (default) the preempt option and allows the master to keep its priority level.

To enable or disable preempting when using IPv6, follow these steps:

	Command	Purpose
Step 1	switch# <b>config t</b>	Enters configuration mode.
Step 2	switch(config)# <b>interface vsan 12</b> switch(config-if)#	Configures a VSAN interface (VSAN 12).
Step 3	switch(config-if)# <b>vrrp ipv6 200</b> switch(config-if-vrrp-ipv6)#	Creates a virtual router.
Step 4	switch(config-if-vrrp-ipv6)# <b>preempt</b>	Enables the higher priority backup virtual router to preempt the lower priority master virtual router. <b>Note</b> This preemption does not apply to the primary IP address.
	switch(config-if-vrrp-ipv6)# <b>no preempt</b>	Disables (default) the preempt option and allows the master to keep its priority level.

## Setting Virtual Router Authentication

VRRP security provides three options, including simple text authentication, MD5 authentication, and no authentication:

- Simple text authentication uses a unique, 1 to 8 character password that is used by all switches participating in the same virtual router. This password should be different from other security passwords.
- MD5 authentication uses a unique, 16 character key that is shared by all switches participating in the same virtual router. This secret key is shared by all switches in the same virtual router.
- No authentication is the default option.

You can configure the key using the authentication option in the VRRP submode and distribute it using the configuration file. The security parameter index (SPI) settings assigned in this option should be unique for each VSAN.



**Note** All VRRP configurations must be duplicated.



**Note** VRRP router authentication does not apply to IPv6.

To set an authentication option for a virtual router, follow these steps:

	Command	Purpose
<b>Step 1</b>	switch# <b>config t</b>	Enters configuration mode.
<b>Step 2</b>	switch(config)# <b>interface vsan 1</b> switch(config-if)#	Configures a VSAN interface (VSAN 1).
<b>Step 3</b>	switch(config-if)# <b>vrrp 250</b> switch(config-if-vrrp)#	Creates a virtual router.
<b>Step 4</b>	switch(config-if-vrrp)# <b>authentication text password</b>	Assigns the simple text authentication option and specifies the password for this option.
	switch(config-if-vrrp)# <b>authentication md5 password2003 spi 0x2003</b>	Assigns the MD5 authentication option and specifies the key and the unique SPI value for this option. The SPI and the valid range is 0x100 to 0xFFFFFFFF.
	switch(config-if-vrrp)# <b>no authentication</b>	Assigns the no authentication option, which is the default.

## Tracking Interface Priority

Interface state tracking changes the priority of the virtual router based on the state of another interface in the switch. When the tracked interface is down, the priority of the virtual router is restored to the interface state tracking value. When the tracked interface is up, the priority reverts to the priority value for the virtual router (see the [“Setting the Priority for the Virtual Router”](#) section on page 5-245). You can track the state of either a specified VSAN interface or the management interface (mgmt 0). The interface state tracking feature is disabled by default.



**Note** For interface state tracking to function, you must enable preemption on the interface. See the [“Configuring or Enabling Priority Preemption”](#) section on page 5-247.

To track the interface priority for a virtual router using IPv4, follow these steps:

	Command	Purpose
Step 1	switch# <b>config t</b>	Enters configuration mode.
Step 2	switch(config)# <b>interface vsan 10</b> switch(config-if)#	Configures a VSAN interface (VSAN 10).
Step 3	switch(config-if)# <b>vrrp 250</b> switch(config-if-vrrp)#	Creates a virtual router.
Step 4	switch(config-if-vrrp)# <b>preempt</b>	Enables priority preemption.
Step 5	switch(config-if-vrrp)# <b>track interface</b> <b>mgmt 0 priority 2</b>	Specifies the priority of the virtual router to be modified based on the state of the management interface.
	switch(config-if-vrrp)# <b>no track</b>	Disables the tracking feature.

To track the interface priority for a virtual router using IPv6, follow these steps:

	Command	Purpose
Step 1	switch# <b>config t</b>	Enters configuration mode.
Step 2	switch(config)# <b>interface vsan 12</b> switch(config-if)#	Configures a VSAN interface (VSAN 12).
Step 3	switch(config-if)# <b>vrrp ipv6 200</b> switch(config-if-vrrp-ipv6)#	Creates a virtual router.
Step 4	switch(config-if-vrrp-ipv6)# <b>preempt</b>	Enables priority preemption.
Step 5	switch(config-if-vrrp-ipv6)# <b>track</b> <b>interface mgmt 0 priority 2</b>	Specifies the priority of the virtual router to be modified based on the state of the management interface.
	switch(config-if-vrrp-ipv6)# <b>no track</b>	Disables the tracking feature.

**Note** You must enable IPv6 on the tracked interface for the priority tracking to take affect (see the [“Configuring Basic Connectivity for IPv6”](#) section on page 8-297). If IPv6 is not enabled, the interface state is treated as down by VRRP over IPv6, regardless of the actual state of the interface.

## Displaying IPv4 VRRP Information

Use the **show vrrp vr** command to display configured IPv4 VRRP information (see Examples 5-2 to 5-4).

### Example 5-2 Displaying IPv4 VRRP Configured Information

```
switch# show vrrp vr 7 interface vsan 2 configuration
vr id 7 configuration
admin state down
priority 100
no authentication
advertisement-Interval 1
preempt yes
tracking interface vsan1 priority 2
```

```
protocol IP
```

### Example 5-3 Displaying IPv4 VRRP Status Information

```
switch# show vrrp vr 7 interface vsan 2 status
vr id 7 status
MAC address 00:00:5e:00:01:07
Operational state: init
```

### Example 5-4 Displaying IPv4 VRRP Statistics

```
switch# show vrrp vr 7 interface vsan 2 statistics
vr id 7 statistics
Become master 0
Advertisement 0
Advertisement Interval Error 0
Authentication Failure 0
TTL Error 0
Priority 0 Received 0
Priority 0 Sent 0
Invalid Type 0
Mismatch Address List 0
Invalid Authentication Type 0
Mismatch Authentication 0
Invalid Packet Length 0
```

## Displaying IPv6 VRRP Information



### Note

---

The Cisco MDS 9250i switch, Cisco MDS 9148S switch, and the Cisco MDS 9396S switch do not support VRRP IPV6 feature.

---

Use the **show vrrp ipv6 vr** command to display configured IPv6 VRRP information (see [Example 5-5](#) through [Example 5-8](#)).

### Example 5-5 Displaying IPv6 VRRP Information

```
switch# show vrrp ipv6 vr 1
-----
Interface  VR  IpVersion  Pri   Time Pre  State   VR IP addr
-----
GigE1/5    1   IPv6        100  100cs  master  2004::1
GigE1/6    1   IPv6        100  100cs  backup  2004::1
```

### Example 5-6 Displaying IPv6 VRRP Interface Configuration Information

```
switch# show vrrp ipv6 vr 1 interface gigabitethernet 1/5 configuration
IPv6 vr id 1 configuration
admin state up
priority 100
associated ip: 2004::1
advertisement-interval 100
preempt no
protocol IPv6
```

**Example 5-7 Displaying IPv6 VRRP Interface Status Information**

```
switch# show vrrp ipv6 vr 1 interface gigabitethernet 1/5 status
IPv6 vr id 1 status
MAC address 00:00:5e:00:02:01
Operational state: master
Up time 37 min, 10 sec
Master IP address: fe80::20c:30ff:fedc:96dc
```

**Example 5-8 Displaying IPv6 VRRP Statistics**

```
switch# show vrrp ipv6 vr 1 interface gigabitethernet 1/5 statistics
IPv6 vr id 1 statistics
Become master 1
Advertisement 0
Advertisement Interval Error 0
TTL Error 0
Priority 0 Received 0
Priority 0 Sent 0
Invalid Type 0
Mismatch Address List 0
Invalid Packet Length 0
```

## Displaying VRRP Statistics

Use the **show vrrp statistics** command to display configured IPv6 VRRP information (see [Example 5-9](#)).

**Example 5-9 Displaying VRRP Cumulative Statistics**

```
switch# show vrrp statistics
Invalid checksum 0
Invalid version 0
Invalid VR ID 0
```

## Clearing VRRP Statistics

Use the **clear vrrp statistics** command to clear all the VRRP statistics for all interfaces on the switch (see [Example 5-10](#)).

**Example 5-10 Clearing VRRP Statistics**

```
switch# clear vrrp Statistics
```

Use the **clear vrrp vr** command to clear both the IPv4 and IPv6 VRRP statistics for a specified interface (see [Example 5-11](#)).

**Example 5-11 Clearing VRRP Statistics on a Specified Interface**

```
switch# clear vrrp vr 1 interface vsan 1
```

Use the **clear vrrp ipv4** command to clear all the statistics for the specified IPv4 virtual router (see [Example 5-12](#)).

**Example 5-12 Clearing VRRP IPv4 Statistics on a Specified Interface**

```
switch# clear vrrp ipv4 vr 7 interface vsan 2
```

Use the **clear vrrp ipv6** command to clear all the statistics for the specified IPv6 virtual router (see [Example 5-13](#)).

**Example 5-13 Clearing VRRP IPv6 Statistics on a Specified Interface**

```
switch# clear vrrp ipv6 vr 7 interface vsan 2
```

## DNS Configuration

The DNS client on the switch communicates with the DNS server to perform the IP address-name server correspondence.

The DNS server may be dropped after two attempts because of one of the following reasons:

- The IP address or the switch name is wrongly configured.
- The DNS server is not reachable because external reasons (reasons beyond our control).

**Note**

When accessing a Telnet host, if the DNS server is not reachable (for any reason) the switch login prompt may take a longer time to appear. If so, verify that the DNS server is accurately configured and reachable.

To configure a DNS server, follow these steps:

	Command	Purpose
<b>Step 1</b>	switch# <b>config t</b> switch(config)#	Enters configuration mode.
<b>Step 2</b>	switch(config)# <b>ip domain-lookup</b>	Enables the IP Domain Naming System (DNS)-based host name-to-address translation.
	switch(config)# <b>no ip domain-lookup</b>	Disables (default) the IP DNS-based host name-to-address translation and reverts to the factory default.
<b>Step 3</b>	switch(config)# <b>ip domain-name</b> <b>cisco.com</b>	Enables the default domain name feature used to complete unqualified host names. Any IP host name that does not contain a domain name (that is, any name without a dot) will have the dot and cisco.com appended to it before being added to the host table.
	switch(config)# <b>no ip domain-name</b> <b>cisco.com</b>	Disables (default) the domain name.

	Command	Purpose
Step 4	switch(config)# <b>ip domain-list harvard.edu</b> switch(config)# <b>ip domain-list stanford.edu</b> switch(config)# <b>ip domain-list yale.edu</b>	Defines a filter of default domain names to complete unqualified host names by using the <b>ip domain-list</b> global configuration command. You can define up to 10 domain names in this filter. To delete a name from a filter, use the <b>no</b> form of this command.
	switch(config)# <b>no ip domain-list</b>	Deletes the defined filter and reverts to factory default. No domains are configured by default.
	<b>Note</b>	If you have not configured a domain list, the domain name that you specified with the <b>ip domain-name</b> global configuration command is used. If you configured a domain list, the default domain name is not used. The <b>ip domain-list</b> command is similar to the <b>ip domain-name</b> command, except that with the <b>ip domain-list</b> command you can define a list of domains, each to be tried in turn.
Step 5	switch(config)# <b>ip name-server 15.1.0.1 2001:0db8:800:200c::417a</b>	Specifies the first address (15.1.0.1) as the primary server and the second address (2001:0db8:800:200c::417a) as the secondary server. You can configure a maximum of six servers.
	switch(config)# <b>no ip name-server</b>	Deletes the configured server(s) and reverts to factory default. No server is configured by default.
	<b>Note</b>	Alternatively, you can configure the DNS entry using the switch names (instead of IP addresses). The configured switch name automatically looks up the corresponding IP address.

## Displaying DNS Host Information

Use the **show hosts** command to display the DNS configuration (see [Example 5-14](#)).

### Example 5-14 Displaying Configured Host Details

```
switch# show hosts
Default domain is cisco.com
Domain list: ucsc.edu harvard.edu yale.edu stanford.edu
Name/address lookup uses domain service
Name servers are 15.1.0.1 15.2.0.0
```

## Default Settings for Distributed Name Server Features

[Table 5-1](#) lists the default settings for DNS features.

**Table 5-1** Default DNS Settings

Parameters	Default
Domain lookup	Disabled
Domain name	Disabled
Domains	None
Domain server	None
Maximum domain servers	6

Table 5-2 lists the default settings for VRRP features.

**Table 5-2**      **Default VRRP Settings**

<b>Parameters</b>	<b>Default</b>
Virtual router state	Disabled
Maximum groups per VSAN	255
Maximum groups per Gigabit Ethernet port	7
Priority preemption	Disabled
Virtual router priority	100 for switch with secondary IP addresses 255 for switches with the primary IP address
Priority interface state tracking	Disabled
Advertisement interval	1 second for IPv4 100 centiseconds for IPv6



## Configuring IPStorage Services

---

Cisco MDS 9000 Series IPStorage (IPS) services extend the reach of Fibre Channel SANs by using open-standard, IP-based technology. The switch connects separated SAN islands using Fibre Channel over IP (FCIP) and it allows IP hosts to access Fibre Channel storage.



### Note

---

The FCIP feature is available in the modules with IPS ports and available in Cisco MDS 9250i, MDS 9220i, and Cisco MDS 9700 Director switches.

The Cisco MDS 24/10 Port SAN Extension Module for MDS 9700 series switch allows you to use Fibre Channel and FCIP features. The Cisco MDS 24/10 port SAN Extension Module can be used in any of the Cisco MDS 9700 series switches.

---

This chapter includes the following sections:

- [Feature Information, page 6-256](#)
- [Supported Hardware, page 6-256](#)
- [Upgrading FCIP and iSCSI Interfaces, page 6-256](#)
- [Configuring IPS Ports on Cisco MDS 9220i Switch, page 6-256](#)
- [Configuring 40 Gbps Speed on Cisco MDS 24/10 port SAN Extension Module, page 6-257](#)
- [Configuring IPStorage Interfaces for IPv4, page 6-258](#)
- [Fibre Channel Module with IPS Ports Core Dumps, page 6-259](#)
- [Configuring IPStorage High Availability, page 6-262](#)
- [Configuring CDP, page 6-265](#)
- [Changing Link Speed on IPStorage Interfaces, page 6-265](#)
- [Default Settings for IPStorage Services Parameters, page 6-273](#)

## Feature Information

This section briefly describes the new and updated features for releases, starting from Cisco MDS NX-OS Release 8.x.

**Table 6-1 Feature Information Table**

Feature	Release	Description
<a href="#">Configuring 40 Gbps Speed on Cisco MDS 24/10 port SAN Extension Module, page 6-257</a>	8.5(1)	This feature allows you to configure 40-Gbps speed on the IPS ports of Cisco MDS 24/10 port SAN Extension Module.
<a href="#">Configuring IPS Ports on Cisco MDS 9220i Switch, page 6-256</a>	8.5(1)	Support for Cisco MDS 9220i Fabric Switch was added.
<a href="#">Changing Link Speed on Cisco MDS 9220i Switch and Cisco MDS 24/10 port SAN Extension Module, page 6-267</a>	7.3(0)DY(1)	This feature enables users to change the link speed on IPStorage interfaces between 1 Gbps and 10 Gbps on the Cisco MDS 24/10 port SAN Extension Module.
<a href="#">Changing Link Speed on Cisco MDS 9250i Multiservice Fabric Switch, page 6-265</a>	6.2(13)	This feature enables users to change the link speed on IPStorage interfaces between 1 Gbps and 10 Gbps on the Cisco MDS 9250i Multiservice Fabric Switch.

## Supported Hardware

You can configure the FCIP and iSCSI features on the following types of hardware:

- Cisco MDS 24/10 port SAN Extension Module in Cisco MDS 9700 Series Director Switches and Cisco MDS 9220i Fabric Switches support FCIP.
- Cisco MDS 9250i Multiservice Fabric Switches support iSCSI.

## Upgrading FCIP and iSCSI Interfaces

ISSU/D is disruptive for FCIP and iSCSI interfaces along with the update of the underlying IPS and GigabitEthernet interfaces supporting these upper layer interfaces. Fibre Channel interfaces (including FC interfaces on the same module or switch as the IPS and GigabitEthernet interfaces), FCoE Ethernet interfaces, and supervisor modules are all updated nondisruptively.

Within Cisco MDS 9700 Directors, the modules with IPS ports implement a 5 minute delay before the next module with IPS ports is upgraded.

## Configuring IPS Ports on Cisco MDS 9220i Switch

Starting from Cisco MDS NX-OS Release 8.5(1), the Cisco MDS 9220i Fabric Switch is supported. Cisco MDS 9220i switch supports six IPS ports. Ports 1 through 4 support 1- and 10-Gbps speed and port 6 supports 40-Gbps speed. By default, the first two ports are operating at a 1-Gbps speed mode and

are licensed. To enable the other ports and different speed modes, you must obtain a license. You cannot move the default license from the first two ports to any other ports. For information on port licensing, see the [Cisco MDS 9000 Series Licensing Guide, Release 8.x](#).

**Note**

Port 5 is 25-Gbps IPS port and is not supported in Cisco MDS NX-OS Release 8.5(1).

Cisco MDS 9220i switch supports four 1 or 10 Gbps IPS ports and one 40 Gbps IPS port. All these ports are handled by a single Service Engine. [Table 6-2](#) provides the different speed combinations that can be configured on the IPS ports of Cisco MDS 9220i switch. For configuring the link speed, see [Changing Link Speed on Cisco MDS 9220i Switch and Cisco MDS 24/10 port SAN Extension Module, page 6-267](#).

**Note**

The maximum throughput on a single FCIP tunnel is 7 Gbps. On the 40 Gbps IPS port, the maximum throughput is 28.5 Gbps when 4 FCIP tunnels are created on separate VLAN interfaces.

**Table 6-2** *IPS Port Speed Configuration Matrix for Cisco MDS 9220i Switch*

Service Engine 1	
Ports 1 through 4	Port 6
1 Gbps	Out-of-service
10 Gbps	Out-of-service
Out-of-service	40 Gbps

## Configuring 40 Gbps Speed on Cisco MDS 24/10 port SAN Extension Module

From Cisco MDS NX-OS Release 8.5(1), you can configure 40 Gbps on the IPS ports 9 and 10 of Cisco MDS 24/10 port SAN Extension Module. Cisco MDS 24/10 port SAN Extension Module supports eight 1 or 10 Gbps IPS ports and two 40 Gbps IPS ports. Ports 1 through 4 and port 9 and handled by Service Engine 1 and Ports 5 through 8 and port 10 and handled by Service Engine 2. Each Service Engine has the capability of 40 Gbps. You can only configure 40 Gbps speed on ports 9 and 10. When you configure 40 Gbps speed on port 9, ports 1 through 4 are moved to out-of-service because the Service Engine capability is 40 Gbps. However, ports 5 through 8 can be configured for 1 or 10 Gbps speed provided port 10 is not configured for 40 Gbps speed. Similarly, when you configure 40 Gbps speed on port 10, ports 5 through 8 are moved to out-of-service. However, ports 1 through 4 can be configured for 1 or 10 Gbps speed provided port 9 is not configured for 40 Gbps speed. [Table 6-3](#) provides the different speed combinations that can be configured on the IPS ports of Cisco MDS 24/10 port SAN Extension Module. For configuring the link speed, see [Changing Link Speed on Cisco MDS 9220i Switch and Cisco MDS 24/10 port SAN Extension Module, page 6-267](#).

The following are the recommended configurations for achieving maximum throughput on the 40 Gbps IPS port:

- The maximum bandwidth of FCIP tunnel is 10 Gbps. Therefore, configure four FCIP tunnels on the 40 Gbps IPS port. To create the FCIP tunnels, create four VLAN sub interfaces on the 40 Gbps IPS port. On each VLAN create an FCIP tunnel.
- Configure the number of TCP connections to 5.

**Table 6-3** *IPS Port Speed Configuration Matrix for Cisco MDS 24/10 port SAN Extension Module*

Service Engine 1		Service Engine 2	
Ports 1 through 4	Port 9	Ports 5 through 8	Port 10
1 Gbps	Out-of-service	1 Gbps	Out-of-service
10 Gbps	Out-of-service	10 Gbps	Out-of-service
1 Gbps	Out-of-service	10 Gbps	Out-of-service
10 Gbps	Out-of-service	1 Gbps	Out-of-service
Out-of-service	40 Gbps	1 Gbps	Out-of-service
Out-of-service	40 Gbps	10 Gbps	Out-of-service
1 Gbps	Out-of-service	Out-of-service	40 Gbps
10 Gbps	Out-of-service	Out-of-service	40 Gbps
Out-of-service	40 Gbps	Out-of-service	40 Gbps

## Configuring IPStorage Interfaces for IPv4

Both FCIP and iSCSI rely on TCP/IP for network connectivity. On each Fibre Channel module with IPS ports, connectivity is provided in the form of IP storage ports on Cisco MDS 9250i switches and Cisco MDS 9700 series switches with 24/10 port SAN Extension modules that are appropriately configured. This section covers the steps required to configure IP for subsequent use by FCIP and iSCSI.

A new port mode, called IPS, is defined for IP storage ports on each Fibre Channel module with IPS ports. IP storage ports are implicitly set to IPS mode, so it can only be used to perform iSCSI and FCIP storage functions. IP storage ports do not bridge Ethernet frames or route other IP packets.

Each IPS port represents a single virtual Fibre Channel host in the Fibre Channel SAN. All the iSCSI hosts connected to this IPS port are merged and multiplexed through the single Fibre Channel host.

In large scale iSCSI deployments where the Fibre Channel storage subsystems require explicit LUN access control for every host device, use of proxy-initiator mode simplifies the configuration.



### Note

To configure IPv6 on an IPStorage interface, see the *Cisco Fabric Manager Security Configuration Guide*. For information about configuring FCIP, see [Chapter 2, “Configuring Fibre Channel over IP.”](#) For information about configuring iSCSI, see [Chapter 4, “Configuring Internet Small Computer Systems Interface.”](#)



### Tip

IPStorage ports on any Fibre Channel module with IPS ports should not be configured in the same IPS broadcast domain as the management IPS port—they should be configured in a different broadcast domain, either by using separate standalone hubs or switches or by using separate VLANs.

## Basic IPStorage Configuration

[Figure 6-1](#) shows an example of a basic IPStorage IP version 4 (IPv4) configuration.

Figure 6-1 IPStorage IPv4 Configuration Example

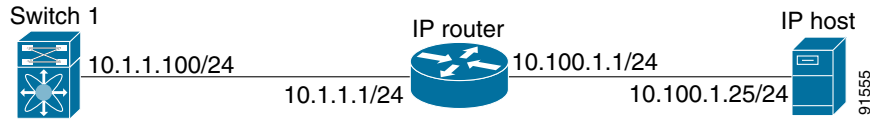
**Note**

The port on the Ethernet switch to which the IPStorage interface is connected should be configured as a host port (also known as access port) instead of a switch port. Spanning tree configuration for that port (on the Ethernet switch) should be disabled. This helps avoid the delay in the management port coming up due to delay from Ethernet spanning tree processing that the Ethernet switch would run if enabled. For Cisco Ethernet switches, use either the **switchport host** command in Cisco IOS or the **set port host** command in Catalyst OS.

## Fibre Channel Module with IPS Ports Core Dumps

IPS core dumps are different from the system's kernel core dumps for other modules. When the Fibre Channel module with IPS port's operating system (OS) unexpectedly resets, it is useful to obtain a copy of the memory image (called a IPS core dump) to identify the cause of the reset. Under that condition, the Fibre Channel module with IPS ports sends the core dump to the supervisor module for storage. Cisco MDS switches have two levels of IPS core dumps:

- Partial core dumps (default)—Each partial core dump consists of four parts (four files). All four files are saved in the active supervisor module.

In Cisco MDS 9700 Series Switches with 24/10 port SAN Extension Modules, each partial core dump consists of five parts (five files). All five files are saved in the active supervisor module.

Use the **show cores** command to list these files.

- Full core dumps—Each full core dump of Cisco MDS 9250i Switches and SSN-16 modules consists of 64 parts (64 files), and each full core dump of Cisco MDS 9700 Series Switches with 24/10 port SAN Extension Modules consists of 67 parts (67 files). The IPS core dump for MSM-18/4 modules consists of 32 parts. This dump cannot be saved on the supervisor module because of its large space requirement. They are copied directly to an external TFTP server.

Use the **system cores tftp:** command to configure an external TFTP server to copy the IPS core dump (and other core dumps).

To configure IPS core dumps on the Fibre Channel module with IPS ports, follow these steps:

	Command	Purpose
Step 1	switch# <b>config terminal</b> switch(config)#	Enters configuration mode.
Step 2	switch(config)# <b>ips core dump full</b> ips core dump full' successfully set for module 9	Configures a dump of the full core generation for all Fibre Channel module with IPS ports in the switch.
	switch(config)# <b>no ips core dump full</b> ips core dump partial' successfully set for module 9	Configures a dump of the partial core (default) generation for the Fibre Channel module with IPS ports in slot 9.

## Configuring Interface Descriptions

See the *Cisco Fabric Manager Interfaces Configuration Guide* for details on configuring the switch port description for any interface.

## Configuring Beacon Mode

See the *Cisco Fabric Manager Interfaces Configuration Guide* for details on configuring the beacon mode for any interface.

## Configuring Autonegotiation

By default, autonegotiation is enabled on all the IPStorage interface. You can enable or disable autonegotiation for a specified IPStorage interface. When autonegotiation is enabled, the port automatically detects the speed or pause method, and duplex of incoming signals based on the link partner. You can also detect link up conditions using the autonegotiation feature.

## Configuring the MTU Frame Size

You can configure the interfaces on a switch to transfer large (or jumbo) frames on a port. The default IP maximum transmission unit (MTU) frame size is 1500 bytes for all Ethernet ports. By configuring jumbo frames on a port, the MTU size can be increased up to 9000 bytes.



**Note**

---

The minimum MTU size is 576 bytes.

---



**Tip**

---

MTU changes are disruptive, all FCIP links and iSCSI sessions flap when the software detects a change in the MTU size.

---

## Configuring Promiscuous Mode

You can enable or disable promiscuous mode on a specific IPStorage interface. By enabling the promiscuous mode, the IPStorage interface receives all the packets and the software then filters and discards the packets that are not destined for that IPStorage interface.

## About VLANs for IPStorage

Virtual LANs (VLANs) create multiple virtual Layer 2 networks over a physical LAN network. VLANs provide traffic isolation, security, and broadcast control.

IPStorage ports automatically recognize Ethernet frames with IEEE 802.1Q VLAN encapsulation. If you need to have traffic from multiple VLANs terminated on one IPStorage port, configure subinterfaces—one for each VLAN.

If the Fibre Channel module with IPS ports or MPS-14/2 module is connected to a Cisco Ethernet switch, and you need to have traffic from multiple VLANs coming to one IPS port, verify the following requirements on the Ethernet switch:

- The encapsulation is set to 802.1Q and not ISL, which is the default.

Use the VLAN ID as a subscription to the IPStorage interface name to create the subinterface name: `<slot-number> / <port-number>. <VLAN-ID>`.

## Interface Subnet Requirements

IPStorage interfaces (major), subinterfaces (VLAN ID), and management interfaces (mgmt 0) can be configured in the same or different subnet depending on the configuration (see [Table 6-4](#)).

**Table 6-4 Subnet Requirements for Ethernet Interfaces Within the Same Switch**

Interface 1	Interface 2	Same Subnet Allowed	Notes
IPStorage 1/1	IPStorage 1/2	Yes <sup>1</sup>	Two major interfaces can be configured in the same or different subnets.
IPStorage 1/1.100	IPStorage 1/2.100	Yes <sup>1</sup>	Two subinterfaces with the same VLAN ID can be configured in the same or different subnets.
IPStorage 1/1.100	IPStorage 1/2.200	No	Two subinterfaces with different VLAN IDs cannot be configured in the same subnet.
IPStorage 1/1	IPStorage 1/1.100	No	A subinterface cannot be configured on the same subnet as the major interface.
mgmt0	IPStorage 1/1.100	No	The mgmt0 interface cannot be configured in the same subnet as the IPStorage interfaces or subinterfaces.
mgmt0	IPStorage 1/1	No	

1. Except IPSec enabled interfaces, which should not be configured in the same IP subnet.



**Note**

The configuration requirements in [Table 6-4](#) also apply to Ethernet PortChannels.

## Verifying IPStorage Connectivity

Once the IPStorage interfaces are connected with valid IP addresses, verify the interface connectivity on each switch. Ping the IP host using the IP address of the host to verify that the static IP route is configured correctly.



**Note**

If the connection fails, verify the following, and ping the IP host again:

- The IP address for the destination (IP host) is correctly configured.
- The host is active (powered on).
- The IP route is configured correctly.
- The IP host has a route to get to the IPStorage interface subnet.
- The IPStorage interface is in the up state.

## IPStorage IPv4-ACL Guidelines



### Tip

If IPv4-ACLs are already configured in a IPStorage interface, you cannot add this interface to an Ethernet PortChannel group.

Follow these guidelines when configuring IPv4-ACLs for IPStorage interfaces:

- Only use Transmission Control Protocol (TCP) or Internet Control Message Protocol (ICMP).



### Note

Other protocols such as User Datagram Protocol (UDP) and HTTP are not supported in IPStorage interfaces. Applying an ACL that contains rules for these protocols to a IPStorage interface is allowed but those rules have no effect.

- Apply IPv4-ACLs to the interface before you enable an interface. This ensures that the filters are in place before traffic starts flowing.
- Be aware of the following conditions:
  - If you use the **log-deny** option, a maximum of 50 messages are logged per second.
  - The **established**, **precedence**, and **fragments** options are ignored when you apply IPv4-ACLs (containing these options) to IPStorage interfaces.
  - If an IPv4-ACL rule applies to a preexisting TCP connection, that rule is ignored. For example if there is an existing TCP connection between A and B, and an IPv4-ACL specifies dropping all packets whose source is A and destination is B is subsequently applied, it will have no effect.

## Configuring IPStorage High Availability

Virtual Router Redundancy Protocol (VRRP) and Ethernet PortChannels are two IPStorage features that provide high availability for iSCSI and FCIP services.

### VRRP for iSCSI and FCIP Services

VRRP provides a redundant alternate path to the IPStorage port for iSCSI and FCIP services. VRRP provides IP address failover protection to an alternate IPStorage interface so the IP address is always available (see [Figure 6-2](#)).

Figure 6-2 VRRP Scenario

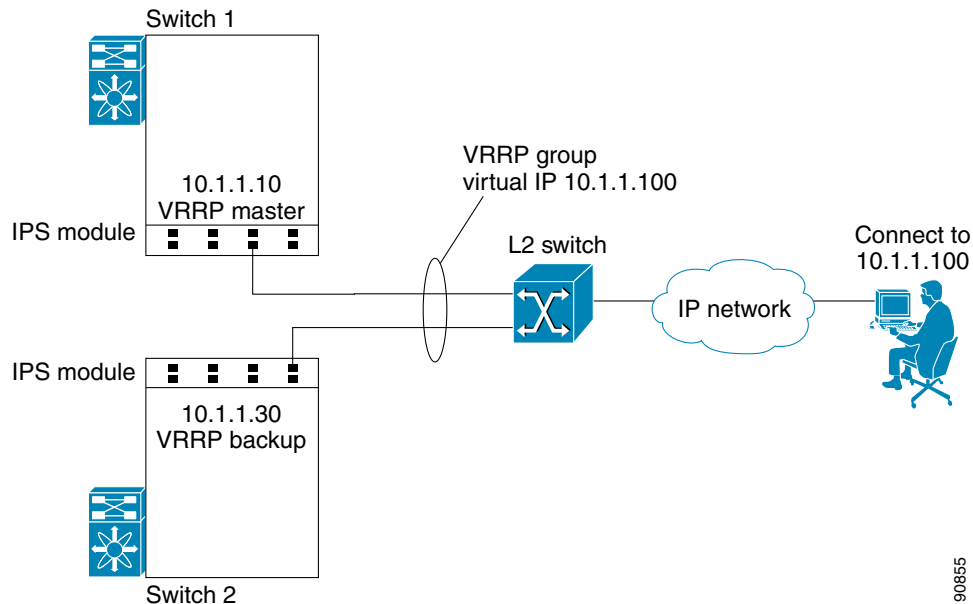

In Figure 6-2, all members of the VRRP group must be IPStorage ports. VRRP group members can be one or more of the following interfaces:

- One or more interfaces in the same Fibre Channel module with IPS ports or MSM-18/4 module
- Interfaces across Fibre Channel module with IPS ports or MSM-18/4 modules in one switch
- Interfaces across Fibre Channel module with IPS ports or MSM-18/4 modules in different switches
- IPStorage subinterfaces
- Ethernet PortChannels and PortChannel subinterfaces

**Note**

You can configure no more than seven VRRP groups, both IPv4 and IPv6, on a IPStorage interface, including the main interface and all subinterfaces.

## Configuring VRRP for IPStorage Interfaces

To configure VRRP for IPStorage interfaces using IPv4, follow these steps:

	Command	Purpose
Step 1	switch1# <b>config terminal</b> switch1(config)#	Enters configuration mode.
Step 2	switch(config)# <b>interface</b> <b>IPStorage 2/2</b> switch(config-if)#	Enters the interface configuration mode on the IPStorage interface (slot 2, port 2).
Step 3	switch(config-if)# <b>ip address</b> <b>10.1.1.10 255.255.255.0</b>	Assigns the IPv4 address (10.1.1.10) and subnet mask (255.255.255.0) for the IPStorage interface.
Step 4	switch(config-if)# <b>no</b> <b>shutdown</b>	Enables the selected interface.
Step 5	switch(config-if)# <b>vrrp 100</b> switch(config-if-vrrp)	Creates VR ID 100.

	Command	Purpose
Step 6	switch(config-if-vrrp)# address 10.1.1.100	Configures the virtual IPv4 address (10.1.1.100) for the selected VRRP group (identified by the VR ID).  <b>Note</b> The virtual IPv4 address must be in the same subnet as the IPv4 address of the IPStorage interface. All members of the VRRP group must configure the same virtual IPv4 address.
Step 7	switch(config-if-vrrp)# priority 10	Configures the priority for the selected interface within this VRRP group.  <b>Note</b> The interface with the highest priority is selected as the master.
Step 8	switch(config-if-vrrp)# no shutdown	Enables the VRRP protocol on the selected interface.

To configure VRRP for IPStorage interfaces using IPv6, follow these steps:

	Command	Purpose
Step 1	switch1# config terminal switch1(config)#	Enters configuration mode.
Step 2	switch(config)# interface IPStorage 2/2 switch(config-if)#	Enters the interface configuration mode on the IPStorage interface (slot 2, port 2).
Step 3	switch(config-if)# ipv6 address 2001:0db8:800:200c::417a/64	Assigns the IPv6 address for the IPStorage interface.
Step 4	switch(config-if)# no shutdown	Enables the selected interface.
Step 5	switch(config-if)# vrrp ipv6 100 switch(config-if-vrrp-ipv6)	Creates VR ID 100.
Step 6	switch(config-if-vrrp-ipv6)# address 2001:0db8:800:200c::417a	Assigns single primary link-local IPv6 address or one of the multiple secondary IPv6 addresses.  <b>Note</b> If this IPv6 address is the same as the physical IPv6 address, this switch is automatically the owner of this IPv6 address.
Step 7	switch(config-if-vrrp-ipv6)# priority 10	Configures the priority for the selected interface within this VRRP group.  <b>Note</b> The interface with the highest priority is selected as the master.
Step 8	switch(config-if-vrrp-ipv6)# no shutdown	Enables the VRRP protocol on the selected interface.



**Note**

The VRRP **preempt** option is not supported on IPS interfaces. However, if the virtual IPv4 IP address is also the IPv4 IP address for the interface, then preemption is implicitly applied.

## Configuring CDP

The Cisco Discovery Protocol (CDP) is supported on the management Ethernet interface on the supervisor module and the IPStorage interfaces on the Fibre Channel module with IPS ports or MSM-18/4 module.

For information about configuring CDP, refer to the *Cisco MDS 9000 Series NX-OS Fundamentals Configuration Guide*.

## Changing Link Speed on IPStorage Interfaces

### Changing Link Speed on Cisco MDS 9250i Multiservice Fabric Switch

The Cisco MDS 9250i Multiservice Fabric Switch has two IPStorage interfaces that support 1 Gbps and 10 Gbps link speeds. By default, IPStorage interfaces are configured at 10 Gbps link speed.



#### Note

Switching between different link speeds is supported on Cisco 10 Gbps IPStorage platforms starting from Cisco MDS NX-OS Release 6.2(13). An ISSD to a release earlier than Cisco MDS NX-OS Release 6.2(13) when any of the IPStorage ports are configured at 1 Gbps, is disallowed. Reconfigure such ports back to the default link speed of 10 Gbps before attempting such a downgrade.

To configure 1 Gbps link speed on an IPStorage interface, follow these steps:

	Command	Purpose
Step 1	switch1# <b>config terminal</b> switch1(config)#	Enters configuration mode.
Step 2	switch(config)# <b>interface IPStorage</b> <i>slot-number/port-number-range</i> switch(config-if)#	Enters IPStorage interface configuration mode.
Step 3	switch(config-if)# <b>shutdown</b>	Administratively disables the interface and stops traffic through the interface.
Step 4	switch(config-if)# <b>switchport speed 1000</b> <sup>1</sup> This speed change will disrupt FCIP/iSCSI traffic for 5 mins on all IPStorage ports. If FCIP tunnels are configured please make sure max-bw <= 1000 Mbps and tcp-connections set to 2. Do you want to continue(y/n) ? [n]	Sets the link speed of the interface and all subinterfaces to 1000 Mbps (1 Gbps).  <b>Note</b> This command causes all IPStorage ports on the selected FCIP engine to be reset. This may cause traffic disruption for up to 5 minutes. By default, <i>n</i> is selected. Press <b>Enter</b> to abort the command. Enter <i>y</i> and press <b>Enter</b> to continue. <sup>2</sup>
Step 5	switch(config-if)# <b>no shutdown</b>	Administratively enables the interface.
Step 6	switch(config-if)# <b>end</b> switch#	Exits IPStorage interface configuration mode and returns to privileged EXEC mode.
Step 7	switch# <b>show ips status</b>	Displays the operational speed of the IPStorage port.

1. Configuring the link speed of an interface generates the following port software failure syslog message:

%IF\_DOWN\_SOFTWARE\_FAILURE: %\$VSAN 1%\$ Interface fcip is down (Port software failure)

- If the conditions specified in the warning message are not met, the configured link speed is still applied. However, issues such as packet drops, retransmissions, and FCIP tunnel flaps may occur.

To configure 10 Gbps link speed on an IPStorage interface, follow these steps:

	Command	Purpose
Step 1	switch1# <b>config terminal</b> switch1(config)#	Enters configuration mode.
Step 2	switch(config)# <b>interface IPStorage</b> <i>slot-number/port-number-range</i> switch(config-if)#	Enters IPStorage interface configuration mode.
Step 3	switch(config-if)# <b>shutdown</b>	Administratively disables the interface and stops traffic through the interface.
Step 4	switch(config-if)# <b>switchport speed 10000</b> <sup>1</sup> "This speed change will disrupt FCIP/iSCSI traffic for 5 mins on all IPStorage ports. Do you want to continue(y/n) ? [n]"	Sets the link speed of the interface and all subinterfaces to 10000 Mbps (10 Gbps).  <b>Note</b>  This command causes all IPStorage ports on the selected FCIP engine to be reset. This may cause traffic disruption for up to 5 minutes. By default, <i>n</i> is selected. Press <b>Enter</b> to abort the command. Enter <i>y</i> and press <b>Enter</b> to continue. <sup>2</sup>
Step 5	switch(config-if)# <b>no shutdown</b>	Administratively enables the interface.
Step 6	switch(config-if)# <b>end</b> switch#	Exits IPStorage interface configuration mode and returns to privileged EXEC mode.
Step 7	switch# <b>show ips status</b>	Displays the operational speed of the IPStorage port.

- Configuring the link speed of an interface generates the following port software failure syslog message:  
%IF\_DOWN\_SOFTWARE\_FAILURE: %\$VSAN 1%\$ Interface fcip is down (Port software failure)
- If the conditions specified in the warning message are not met, the configured link speed is still applied. However, issues such as packet drops, retransmissions, and FCIP tunnel flaps may occur.

If there is a mismatch between the configured link speed and the small form-factor pluggable (SFP) speed capabilities, the port goes into an Error Disabled state and a corresponding syslog message is logged. In such a scenario, either the configured link speed or the SFP should be changed. If the link speed is changed, even if the port is already enabled, the **shutdown** and **no shutdown** commands must be explicitly issued for the change to be applied.

For more information about supported 1 Gbps SFPs for a Cisco MDS 9250i Multiservice Fabric Switch, see the [Cisco MDS 9000 Family Pluggable Transceivers Data Sheet](#).

For information about configuring FCIP tunnels with IPStorage interfaces at 1 Gbps speed, see the [Configuring FCIP](#) chapter.

## Changing Link Speed on Cisco MDS 9220i Switch and Cisco MDS 24/10 port SAN Extension Module



**Note** For Cisco MDS 9220i switch, delete all the FCIP related configurations, such as profiles, tunnels, and so on, before switching from 1 or 10 Gbps speed to 40 Gbps speed or vice versa.

To configure 1 Gbps link speed on an IPStorage interface, follow these steps:

	Command	Purpose
<b>Step 1</b>	switch1# <b>config terminal</b> switch1(config)#	Enters configuration mode.
<b>Step 2</b>	Releases prior to Cisco MDS NX-OS Release 8.5(1):  <b>Note</b> The values for <i>port-number-range</i> can be 1-4 or 5-8.  switch(config)# <b>interface IPStorage</b> <i>slot-number/port-number-range</i> switch(config-if)#  Cisco MDS NX-OS Release 8.5(1) or later releases:  <b>Note</b> The values for <i>port-number-range</i> can be 1-4 or 5-8. The value for port number can be 9 if <i>port-number-range</i> is 1-4 and the value for port number can be 10 if <i>port-number-range</i> is 5-8.  switch(config)# <b>interface IPStorage</b> <i>slot-number/port-number-range, IPStorage</i> <i>slot-number/port-number</i>	Enters IPStorage interface configuration mode.
<b>Step 3</b>	switch(config-if)# <b>1G-speed-mode</b> This speed change will disrupt FCIP/iSCSI traffic for 60 seconds on selected IPStorage ports.If FCIP tunnels are configured please make sure max-bw <= 1000 Mbps and tcp-connections set to 2. Do you wish to continue(y/n)? [n]	Sets the link speed of the interface and all subinterfaces to 1000 Mbps (1 Gbps) and administratively enables the interface.
<b>Step 4</b>	switch(config-if)# <b>end</b> switch#	Exits IPStorage interface configuration mode and returns to privileged EXEC mode.
<b>Step 5</b>	switch# <b>show ips status</b>	Displays the operational speed of the IPStorage port.

To configure 10 Gbps link speed on an IPStorage interface, follow these steps:

	Command	Purpose
<b>Step 1</b>	<pre>switch1# <b>config terminal</b> switch1(config)#</pre>	Enters configuration mode.
<b>Step 2</b>	<p>Releases prior to Cisco MDS NX-OS Release 8.5(1):</p> <p><b>Note</b> The values for <i>port-number-range</i> can be 1-4 or 5-8.</p> <pre>switch(config)# <b>interface IPStorage</b> slot-number/port-number-range switch(config-if)#</pre> <p>Cisco MDS NX-OS Release 8.5(1) or later releases:</p> <p><b>Note</b> The values for <i>port-number-range</i> can be 1-4 or 5-8. The value for port number can be 9 if <i>port-number-range</i> is 1-4 and the value for port number can be 10 if <i>port-number-range</i> is 5-8.</p> <pre>switch(config)# <b>interface IPStorage</b> slot-number/port-number-range, <b>IPStorage</b> slot-number/port-number</pre>	Enters IPStorage interface configuration mode.
<b>Step 3</b>	<pre>switch(config-if)# <b>10G-speed-mode</b> This speed change will disrupt FCIP/iSCSI traffic for 60 seconds on select IPStorage ports. Do you wish to continue(y/n)? [n]</pre>	<p>Sets the link speed of the interface and all subinterfaces to 10000 Mbps (10 Gbps) and administratively enables the interface.</p> <p><b>Note</b> Configure the number of TCP connections to 5 for attaining maximum throughput.</p>
<b>Step 4</b>	<pre>switch(config-if)# <b>end</b> switch#</pre>	Exits IPStorage interface configuration mode and returns to privileged EXEC mode.
<b>Step 5</b>	<pre>switch# <b>show ips status</b></pre>	Displays the operational speed of the IPStorage port.

To configure 40 Gbps link speed on an IPStorage interface, follow these steps:

	Command	Purpose
Step 1	switch1# <b>configure</b>	Enters configuration mode.
Step 2	<p>Cisco MDS 24/10 port SAN Extension Module:</p> <p><b>Note</b> The values for <i>port-number-range</i> can be 1-4 or 5-8. The value for port number can be 9 if <i>port-number-range</i> is 1-4 and the value for port number can be 10 if <i>port-number-range</i> is 5-8.</p> <pre>switch(config)# <b>interface IPStorage</b> slot-number/port-number-range, <b>IPStorage</b> slot-number/port-number</pre> <p>Cisco MDS 9220i Switch:</p> <p><b>Note</b> The values for <i>port-number-range</i> can only be 6.</p> <pre>switch(config)# <b>interface IPStorage</b> slot-number/port-number-range</pre>	<p>Enters IPStorage interface configuration mode.</p> <p><b>Note</b> The values for <i>port-number-range</i> can be 9 or 10 only for Cisco MDS 24/10 Port SAN Extension Module and 6 for Cisco MDS 9220i switch.</p> <p><b>Note</b> Configure the number of TCP connections to 5 for attaining maximum throughput.</p>
Step 3	switch(config-if)# <b>40G-speed-mode</b>	Sets the link speed of the interface to 40 Gbps and interfaces in the range to out-of-service.

## Displaying Statistics

This section provides examples to verify IPStorage interfaces and TCP/IP statistics on the IPStorage ports.

Use the **show interface IPStorage** command on each switch to verify that the interfaces are up and functioning as desired. See [Example 6-1](#).

### Example 6-1 Displaying the IPStorage Interface

```
switch# show interface IPStorage 4/1
IPStorage4/1 is up
  Hardware is IPStorage, address is 008e.7339.39e7
  Internet address is 10.197.141.81/24
  MTU 2500 bytes
  Port mode is IPS
  Speed is 10 Gbps
  Beacon is turned off
  Auto-Negotiation is turned on
  5 minutes input rate 77012744 bits/sec, 9626593 bytes/sec, 112755 frames/sec
  5 minutes output rate 2762915176 bits/sec, 345364397 bytes/sec, 175258 frames/sec
  71187036 packets input, 6078261484 bytes
    0 multicast frames, 0 compressed
  0 input errors, 0 frame, 0 overrun 0 fifo
  110617842 packets output, 217860230652 bytes, 0 underruns
    0 output errors, 0 collisions, 0 fifo
    0 carrier errors
```

```
switch# show interface IPStorage 5/1-10 brief
```

Interface	Status	IP Address	Speed	MTU
IPStorage5/1	up	1.1.1.1/24	10 Gbps	2500
IPStorage5/2	up	2.2.2.2/24	10 Gbps	2500
IPStorage5/3	up	3.3.3.3/24	10 Gbps	2500
IPStorage5/4	up	4.4.4.4/24	10 Gbps	2500
IPStorage5/5	up	6811::3456/64	1 Gbps	2300
IPStorage5/6	up	9.9.9.1/24	1 Gbps	2500
IPStorage5/7	up	7.7.7.1/24	1 Gbps	2500
IPStorage5/8	up	8.8.8.1/24	1 Gbps	2500
IPStorage5/9	outOfServc	--	auto	1500
IPStorage5/10	outOfServc	--	auto	1500



**Note** In Cisco MDS NX-OS Release 7.3(0)DY(1), 40GE IPStorage interfaces are not supported.

## Displaying Ethernet MAC Statistics

The **show ips stats mac interface ips** command takes the IPStorage interface as a parameter and returns the statistics for that interface. See [Example 6-2](#).



**Note**

Use the physical interface, not the subinterface, to display Ethernet MAC statistics.

### Example 6-2 Displaying IPStorage Interface MAC Statistics

```
switch# show ips stats mac interface ips 4/1

DPP HW IPStorage port 4 (octeon port 19) statistics

Rx stats :
  dropped          : 0          octs, 0          pkts
  l2 red pkts     : 0          mcast, 0         bcasts
  l3 red pkts     : 0          mcast, 0         bcasts
  oversize        : 0          pkts, 0          crcpkts
  runt            : 0          pkts, 0          crcpkts
  inband          : 0          octs, 0          pkts, 0          err
  pci raw         : 0          pkts
  fcs_align_err   : 0          pkts

  total           : 0          octs, 0          pkts

length of [pkts]:-
  [64B]           : 0          [65B-127B]      : 0
  [128B-255B]     : 0          [256B-511B]     : 0
  [512B-1023B]    : 0          [1024B-1518B]   : 0
  [1519B-MAX]    : 0

Tx stats :
  total           : 0          octs, 0          pkts
  dropped         : 0          octs, 0          pkts

Hw-intf stats :
  total           : 0          Rx_octs, 0        Rx_pkts
  dropped         : 0          Rx_pkts
  total           : 0          Tx_octs, 0        Tx_pkts
  dropped         : 0          Tx_pkts
```

## Displaying TCP Statistics

Use the **show ips stats tcp interface ips** to display and verify TCP statistics. This command takes the main Ethernet interface as a parameter, and shows TCP stats along with the connection list and TCP state. The **detail** option shows all information maintained by the interface. See [Example 6-3](#) and [Example 6-4](#).

### Example 6-3 Displaying TCP Statistics

```
switch# show ips stats tcp interface ips 4/1

TCP statistics for port IPStorage4/1
  Connection Stats
    0 active openings, 3 accepts
    0 failed attempts, 12 reset received, 3 established
  Segment stats
    163 received, 355 sent, 0 retransmitted
    0 bad segments received, 0 reset sent
  TCP Active Connections
    Local Address      Remote Address      State      Send-Q  Recv-Q
    0.0.0.0:3260      0.0.0.0:0          LISTEN     0       0
```

### Example 6-4 Displaying Detailed TCP Statistics

```
switch# show ips stats tcp interface ips 4/1 detail

TCP Statistics for port IPStorage4/1
  TCP send stats
    355 segments, 37760 bytes
    222 data, 130 ack only packets
    3 control (SYN/FIN/RST), 0 probes, 0 window updates
    0 segments retransmitted, 0 bytes
    0 retransmitted while on ethernet send queue, 0 packets split
    0 delayed acks sent
  TCP receive stats
    163 segments, 114 data packets in sequence, 6512 bytes in sequence
    0 predicted ack, 10 predicted data
    0 bad checksum, 0 multi/broadcast, 0 bad offset
    0 no memory drops, 0 short segments
    0 duplicate bytes, 0 duplicate packets
    0 partial duplicate bytes, 0 partial duplicate packets
    0 out-of-order bytes, 1 out-of-order packets
    0 packet after window, 0 bytes after window
    0 packets after close
    121 acks, 37764 ack bytes, 0 ack toomuch, 4 duplicate acks
    0 ack packets left of snd_una, 0 non-4 byte aligned packets
    8 window updates, 0 window probe
    30 pcb hash miss, 0 no port, 0 bad SYN, 0 paws drops
  TCP Connection Stats
    0 attempts, 3 accepts, 3 established
    3 closed, 2 drops, 0 conn drops
    0 drop in retransmit timeout, 1 drop in keepalive timeout
    0 drop in persist drops, 0 connections drained
  TCP Miscellaneous Stats
    115 segments timed, 121 rtt updated
    0 retransmit timeout, 0 persist timeout
    12 keepalive timeout, 11 keepalive probes
  TCP SACK Stats
    0 recovery episodes, 0 data packets, 0 data bytes
    0 data packets retransmitted, 0 data bytes retransmitted
```

```

    0 connections closed, 0 retransmit timeouts
TCP SYN Cache Stats
  15 entries, 3 connections completed, 0 entries timed out
  0 dropped due to overflow, 12 dropped due to RST
  0 dropped due to ICMP unreachable, 0 dropped due to bucket overflow
  0 abort due to no memory, 0 duplicate SYN, 0 no-route SYN drop
  0 hash collisions, 0 retransmitted
TCP Active Connections
  Local Address      Remote Address      State      Send-Q  Recv-Q
  0.0.0.0:3260      0.0.0.0:0          LISTEN    0       0

```

Use the **show ips stats icmp interface ips** to display and verify IP statistics. This command takes the main Ethernet interface as a parameter and returns the ICMP statistics for that interface. See [Example 6-5](#).

#### **Example 6-5** Displaying ICMP Statistics

```

switch# show ips stats icmp interface ips 4/1

ICMP Statistics for port IPStorage4/1
  0 ICMP messages received
  0 ICMP messages dropped due to errors
ICMP input histogram
  0 destination unreachable
  0 time exceeded
  0 parameter problem
  0 source quench
  0 redirect
  0 echo request
  0 echo reply
  0 timestamp request
  0 timestamp reply
  0 address mask request
  0 address mask reply
ICMP output histogram
  0 destination unreachable
  0 time exceeded
  0 parameter problem
  0 source quench
  0 redirect
  0 echo request
  0 echo reply
  0 timestamp request
  0 timestamp reply
  0 address mask request
  0 address mask reply

```

## Displaying IPStorage Ports Speed

Use the **show ips status** command to verify the programmed speed of an IPStorage port.

#### **Example 6-6** Displays IPStorage Port Speed

```

switch# show ips status
  Port 1/1 READY 10G
  Port 1/2 READY 1G

```

## Default Settings for IPStorage Services Parameters

Table 6-5 lists the default settings for IPStorage services parameters.

**Table 6-5** *Default IPStorage Parameters*

Parameters	Default
IPS core size	Partial





# Configuring IPv4 for Gigabit Ethernet Interfaces

---

Cisco MDS 9000 Family supports IP version 4 (IPv4) on Gigabit Ethernet interfaces. This chapter describes how to configure IPv4 addresses and other IPv4 features.

This chapter includes the following topics:

- [Overview of IPv4, page 7-275](#)
- [Basic Gigabit Ethernet Configuration for IPv4, page 7-276](#)
- [Verifying Gigabit Ethernet Connectivity, page 7-280](#)
- [VLANs Support in Cisco MDS NX-OS, page 7-280](#)
- [Configuring Static IPv4 Routing, page 7-282](#)
- [IPv4-Access Control Lists, page 7-283](#)
- [Address Resolution Protocol Cache, page 7-284](#)
- [Displaying IPv4 Statistics, page 7-285](#)
- [Default Settings for IPv4 Parameters, page 7-285](#)

## Overview of IPv4

Cisco MDS 9000 Family supports IP version 4 (IPv4) on Gigabit Ethernet interfaces. Both FCIP and iSCSI rely on TCP/IP for network connectivity. On each Fibre Channel module with IPS ports or MPS-14/2 module, connectivity is provided in the form of Gigabit Ethernet interfaces that are appropriately configured.

A new port mode, called IPS, is defined for Gigabit Ethernet ports on each Fibre Channel module with IPS ports or MPS-14/2 module. IP storage ports are implicitly set to IPS mode, so it can only be used to perform iSCSI and FCIP storage functions. IP storage ports do not bridge Ethernet frames or route other IP packets.

Each IPS port represents a single virtual Fibre Channel host in the Fibre Channel SAN. All the iSCSI hosts connected to this IPS port are merged and multiplexed through the single Fibre Channel host.



**Note**

---

The Gigabit Ethernet interfaces on the MPS-14/2 module do not support EtherChannel.

---

Both FCIP and iSCSI rely on TCP/IP for network connectivity. On each Fibre Channel module with IPS ports or MSM-18/4 module, connectivity is provided in the form of Gigabit Ethernet interfaces that are appropriately configured. This section covers the steps required to configure IP for subsequent use by FCIP and iSCSI.

**Note**

For information about configuring FCIP, see [Chapter 2, “Configuring Fibre Channel over IP.”](#) For information about configuring iSCSI, see [Chapter 4, “Configuring Internet Small Computer Systems Interface.”](#)

A new port mode, called IPS, is defined for Gigabit Ethernet ports on each Fibre Channel module with IPS ports or MSM-18/4 module. IP storage ports are implicitly set to IPS mode, so it can only be used to perform iSCSI and FCIP storage functions. IP storage ports do not bridge Ethernet frames or route other IP packets.

Each IPS port represents a single virtual Fibre Channel host in the Fibre Channel SAN. All the iSCSI hosts connected to this IPS port are merged and multiplexed through the single Fibre Channel host.

In large scale iSCSI deployments where the Fibre Channel storage subsystems do not require explicit LUN access control for every host device, use of proxy-initiator mode simplifies the configuration.

**Note**

The Gigabit Ethernet interfaces on the MSM-18/4 module do not support EtherChannel.

**Note**

To configure IPv6 on a Gigabit Ethernet interface, see the [“Configuring IPv6 Addressing and Enabling IPv6 Routing”](#) section on page 8-297.

**Tip**

Gigabit Ethernet ports on any Fibre Channel module with IPS ports or MSM-18/4 module should not be configured in the same Ethernet broadcast domain as the management Ethernet port. They should be configured in a different broadcast domain, either by using separate standalone hubs or switches or by using separate VLANs.

## Basic Gigabit Ethernet Configuration for IPv4

[Figure 7-1](#) shows an example of a basic Gigabit Ethernet IP version 4 (IPv4) configuration.

**Figure 7-1 Gigabit Ethernet IPv4 Configuration Example**

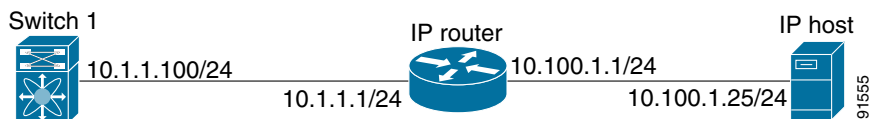
**Note**

The port on the Ethernet switch to which the MDS Gigabit Ethernet interface is connected should be configured as a host port (also known as access port) instead of a switch port. Spanning tree configuration for that port (on the Ethernet switch) should be disabled. This helps avoid the delay in the management port coming up due to delay from Ethernet spanning tree processing that the Ethernet switch would run if enabled. For Cisco Ethernet switches, use either the **switchport host** command in Cisco IOS or the **set port host** command in the Catalyst OS.

To configure the Gigabit Ethernet interface for the example in [Figure 7-1](#), follow these steps:

	Command	Purpose
<b>Step 1</b>	switch# <b>config terminal</b> switch(config)#	Enters configuration mode.
<b>Step 2</b>	switch(config)# <b>interface gigabitethernet 2/2</b> switch(config-if)#	Enters the interface configuration mode on the Gigabit Ethernet interface (slot 2, port 2).
<b>Step 3</b>	switch(config-if)# <b>ip address 10.1.1.100</b> <b>255.255.255.0</b>	Enters the IPv4 address (10.1.1.100) and subnet mask (255.255.255.0) for the Gigabit Ethernet interface.
<b>Step 4</b>	switch(config-if)# <b>no shutdown</b>	Enables the interface.

## Configuring Gigabit Ethernet Interface

To configure the Gigabit Ethernet interface using Fabric Manager, follow these steps:

- 
- Step 1** Expand **Switches > Interfaces > Ethernet > IPS**.  
You see the Gigabit Ethernet Configuration in the Information pane.
- Step 2** Click the **IP Addresses** tab.
- Step 3** Click **Create Row**.  
You see the Create Gigabit Ethernet Interface dialog box.
- Step 4** Select the switch on which you want to create the Gigabit Ethernet interface.
- Step 5** Enter the interface. For example, 2/2 for slot 2, port 2.
- Step 6** Enter the IPv4 address (10.1.1.100) and subnet mask (255.255.255.0).
- Step 7** Click **Create** to save these changes or click **Close** to discard any unsaved changes.
- 

This section includes the following topics:

- [Configuring Interface Descriptions, page 7-277](#)
- [Configuring Beacon Mode, page 7-277](#)
- [Configuring Autonegotiation, page 7-278](#)
- [NoteWhen using DS-SFP-GE-T \(copper SFPs\) on Gigabit Ethernet interfaces in a DS-X9316-SSNK9 module, auto-negotiation should be disabled., page 7-278](#)
- [Configuring Promiscuous Mode, page 7-279](#)

## Configuring Interface Descriptions

See the *Cisco Fabric Manager Interfaces Configuration GuideCisco MDS 9000 Family NX-OS Interfaces Configuration Guide* for details on configuring the switch port description for any interface.

## Configuring Beacon Mode

See the *Cisco Fabric Manager Interfaces Configuration GuideCisco MDS 9000 Family NX-OS Interfaces Configuration Guide* for details on configuring the beacon mode for any interface.

## Configuring Autonegotiation

By default, autonegotiation is enabled all Gigabit Ethernet interface. You can enable or disable autonegotiation for a specified Gigabit Ethernet interface. When autonegotiation is enabled, the port automatically detects the speed or pause method, and duplex of incoming signals based on the link partner. You can also detect link up conditions using the autonegotiation feature.

To configure autonegotiation, follow these steps:

	Command	Purpose
Step 1	switch# <b>config terminal</b> switch(config)#	Enters configuration mode.
Step 2	switch(config)# <b>interface gigabitethernet 2/2</b> switch(config-if)#	Enters the interface configuration mode on the Gigabit Ethernet interface (slot 2, port 2).
Step 3	switch(config-if)# <b>switchport auto-negotiate</b>	Enables autonegotiation for this Gigabit Ethernet interface (default).
	switch(config-if)# <b>no switchport auto-negotiate</b>	Disables autonegotiation for this Gigabit Ethernet interface.

To configure autonegotiation using Fabric Manager, follow these steps:

- 
- Step 1** Expand **Switches > Interfaces > Ethernet > IPS**.
- You see the Gigabit Ethernet Configuration in the Information pane.
- Step 2** In the General tab, you can enable or disable the Auto Negotiate option for a specific switch.
- Step 3** Click **Apply Changes**.
- 



### Note

When using DS-SFP-GE-T (copper SFPs) on Gigabit Ethernet interfaces in a DS-X9316-SSNK9 module, auto-negotiation should be disabled.

---

## Configuring the MTU Frame Size

You can configure the interfaces on a switch to transfer large (or jumbo) frames on a port. The default IP maximum transmission unit (MTU) frame size is 1500 bytes for all Ethernet ports. By configuring jumbo frames on a port, the MTU size can be increased up to 9000 bytes.



### Note

The minimum MTU size is 576 bytes.

---



### Tip

MTU changes are disruptive, all FCIP links and iSCSI sessions flap when the software detects a change in the MTU size.

---

You do not need to explicitly issue the **shutdown** and **no shutdown** commands.

To configure the MTU frame size, follow these steps:

	Command	Purpose
<b>Step 1</b>	switch# <b>config terminal</b> switch(config)#	Enters configuration mode.
<b>Step 2</b>	switch(config)# <b>interface gigabitethernet 2/2</b> switch(config-if)#	Enters the interface configuration mode on the Gigabit Ethernet interface (slot 2, port 2).
<b>Step 3</b>	switch(config-if)# <b>switchport mtu 3000</b>	Changes the MTU size to 3000 bytes. The default is 1500 bytes.

To configure the MTU frame size using Fabric Manager, follow these steps:

- 
- Step 1** Expand **Switches > Interfaces > Ethernet > IPS**.  
You see the Gigabit Ethernet Configuration in the Information pane.
- Step 2** In the General tab, in the Mtu column, you can enter a new value to configure the MTU Frame Size for a specific switch. For example 3000 bytes. The default is 1500 bytes.
- Step 3** Click **Apply Changes**.
- 

## Configuring Promiscuous Mode

You can enable or disable promiscuous mode on a specific Gigabit Ethernet interface. By enabling the promiscuous mode, the Gigabit Ethernet interface receives all the packets and the software then filters and discards the packets that are not destined for that Gigabit Ethernet interface.

To configure the promiscuous mode, follow these steps:

	Command	Purpose
<b>Step 1</b>	switch# <b>config terminal</b> switch(config)#	Enters configuration mode.
<b>Step 2</b>	switch(config)# <b>interface gigabitethernet 2/2</b> switch(config-if)#	Enters the interface configuration mode on the Gigabit Ethernet interface (slot 2, port 2).
<b>Step 3</b>	switch(config-if)# <b>switchport promiscuous-mode on</b>	Enables promiscuous mode for this Gigabit Ethernet interface. The default is <b>off</b> .
	switch(config-if)# <b>switchport promiscuous-mode off</b>	Disables (default) promiscuous mode for this Gigabit Ethernet interface.
	switch(config-if)# <b>no switchport promiscuous-mode</b>	Disables (default) the promiscuous mode for this Gigabit Ethernet interface.

To configure the promiscuous mode using Fabric Manager, follow these steps:

- 
- Step 1** Expand **Switches > Interfaces > Ethernet > IPS**.  
You see the Gigabit Ethernet Configuration in the Information pane.
- Step 2** In the General tab, you can enable or disable the Promiscuous Mode option for a specific switch.

**Step 3** Click **Apply Changes**.

## Verifying Gigabit Ethernet Connectivity

Once the Gigabit Ethernet interfaces are connected with valid IP addresses, verify the interface connectivity on each switch. Ping the IP host using the IP address of the host to verify that the static IP route is configured correctly.



### Note

If the connection fails, verify the following, and ping the IP host again:

- The IP address for the destination (IP host) is correctly configured.
- The host is active (powered on).
- The IP route is configured correctly.
- The IP host has a route to get to the Gigabit Ethernet interface subnet.
- The Gigabit Ethernet interface is in the up state.

Use the **ping** command to verify the Gigabit Ethernet connectivity (see [Example 7-1](#)). The **ping** command sends echo request packets out to a remote device at an IP address that you specify.

Use the **show interface gigabitethernet** command to verify if the Gigabit Ethernet interface is up.

### Example 7-1 Verifying Gigabit Ethernet Connectivity

```
switch# ping 10.100.1.25
PING 10.100.1.25 (10.100.1.25): 56 data bytes
64 bytes from 10.100.1.25: icmp_seq=0 ttl=255 time=0.1 ms
64 bytes from 10.100.1.25: icmp_seq=1 ttl=255 time=0.1 ms
64 bytes from 10.100.1.25: icmp_seq=2 ttl=255 time=0.1 ms
--- 10.100.1.25 ping statistics ---
3 packets transmitted, 3 packets received, 0% packet loss
round-trip min/avg/max = 0.1/0.1/0.1 ms
```

## VLANs Support in Cisco MDS NX-OS

This section describes virtual LAN (VLAN) support in Cisco MDS NX-OS and includes the following topics:

- [VLANs for Gigabit Ethernet, page 7-280](#)
- [Configuring a VLAN Subinterface, page 7-281](#)
- [Interface Subnet Requirements, page 7-281](#)

### VLANs for Gigabit Ethernet

Virtual LANs (VLANs) create multiple virtual Layer 2 networks over a physical LAN network. VLANs provide traffic isolation, security, and broadcast control.

Gigabit Ethernet ports automatically recognize Ethernet frames with IEEE 802.1Q VLAN encapsulation. If you need to have traffic from multiple VLANs terminated on one Gigabit Ethernet port, configure subinterfaces—one for each VLAN.

**Note**

If the Fibre Channel module with IPS ports or MSM-18/4 module is connected to a Cisco Ethernet switch, and you need to have traffic from multiple VLANs coming to one IPS port, verify the following requirements on the Ethernet switch:

- The Ethernet switch port connected to the Fibre Channel module with IPS ports or MSM-18/4 module is configured as a trunking port.
- The encapsulation is set to 802.1Q and not ISL, which is the default.

Use the VLAN ID as a subscription to the Gigabit Ethernet interface name to create the subinterface name:

slot-number / port-number.VLAN-ID

## Configuring a VLAN Subinterface

To configure a VLAN subinterface (VLAN ID), follow these steps:

	Command	Purpose
<b>Step 1</b>	switch# <b>config terminal</b> switch(config)#	Enters configuration mode.
<b>Step 2</b>	switch(config)# <b>interface gigabitethernet 2/2.100</b> switch(config-if)#	Specifies the subinterface on which 802.1Q is used (slot 2, port 2, VLAN ID 100).  <b>Note</b> The subinterface number, 100 in this example, is the VLAN ID. The VLAN ID ranges from 1 to 4093.
<b>Step 3</b>	switch(config-if)# <b>ip address 10.1.1.101</b> <b>255.255.255.0</b>	Enters the IPv4 address (10.1.1.100) and subnet mask (255.255.255.0) for the Gigabit Ethernet interface.
<b>Step 4</b>	switch(config-if)# <b>shutdown</b>	Enables the interface.

To configure a VLAN subinterface (VLAN ID) using Device Manager, follow these steps:

- Step 1** Select **Interface > Ethernet and iSCSI**.
- Step 2** Click the **Sub Interfaces** tab.
- Step 3** Select the Gigabit Ethernet subinterface on which 802.1Q should be used.
- Step 4** Click the **Edit IP Address** button.
- Step 5** Enter the IPv4 address and subnet mask for the Gigabit Ethernet interface.
- Step 6** Click **Create** to save the changes or you may click **Close**.

## Interface Subnet Requirements

Gigabit Ethernet interfaces (major), subinterfaces (VLAN ID), and management interfaces (mgmt 0) can be configured in the same or different subnet depending on the configuration (see [Table 7-1](#)).

**Table 7-1 Subnet Requirements for Interfaces**

Interface 1	Interface 2	Same Subnet Allowed	Notes
Gigabit Ethernet 1/1	Gigabit Ethernet 1/2	Yes	Two major interfaces can be configured in the same or different subnets.
Gigabit Ethernet 1/1.100	Gigabit Ethernet 1/2.100	Yes	Two subinterfaces with the same VLAN ID can be configured in the same or different subnets.
Gigabit Ethernet 1/1.100	Gigabit Ethernet 1/2.200	No	Two subinterfaces with different VLAN IDs cannot be configured in the same subnet.
Gigabit Ethernet 1/1	Gigabit Ethernet 1/1.100	No	A subinterface cannot be configured on the same subnet as the major interface.
mgmt0	Gigabit Ethernet 1/1.100	No	The mgmt0 interface cannot be configured in the same subnet as the Gigabit Ethernet interfaces or subinterfaces.
mgmt0	Gigabit Ethernet 1/1	No	

**Note**

The configuration requirements in [Table 7-1](#) also apply to Ethernet PortChannels.

## Configuring Static IPv4 Routing

To configure static IPv4 routing (see [Figure 7-1](#)) through the Gigabit Ethernet interface, follow these steps:

	Command	Purpose
<b>Step 1</b>	switch# <b>config terminal</b> switch(config)#	Enters configuration mode.
<b>Step 2</b>	switch(config)# <b>ip route</b> <b>10.100.1.0 255.255.255.0 10.1.1.1</b> switch(config-if)#	Enters the IP subnet (10.100.1.0 255.255.255.0) of the IP host and configures the next hop 10.1.1.1, which is the IPv4 address of the router connected to the Gigabit Ethernet interface.

## Displaying the IPv4 Route Table

The **ip route interface** command takes the Gigabit Ethernet interface as a parameter and returns the route table for the interface. See [Example 7-2](#).

### Example 7-2 Displaying an IP Route Table

```
switch# show ips ip route interface gig 8/1
Codes: C - connected, S - static
No default gateway
C 10.1.3.0/24 is directly connected, GigabitEthernet8/1
```

Connected (C) identifies the subnet in which the interface is configured (directly connected to the interface). Static (S) identifies the static routes that go through the router.

## IPv4-Access Control Lists

This section describes the guidelines for IPv4 access control lists and how to apply them to Gigabit Ethernet interfaces.

This section includes the following topics:

- [Gigabit Ethernet Guidelines, page 7-283](#)
- [Applying on Gigabit Ethernet Interfaces, page 7-283](#)



### Note

For information on creating IPv4-ACLs, see the *Cisco Fabric Manager Security Configuration Guide* and *Cisco MDS 9000 Family NX-OS Security Configuration Guide*.

## Gigabit Ethernet Guidelines

Follow these guidelines when configuring for Gigabit Ethernet interfaces:

- Only use Transmission Control Protocol (TCP) or Internet Control Message Protocol (ICMP).



### Note

Other protocols such as User Datagram Protocol (UDP) and HTTP are not supported in Gigabit Ethernet interfaces. Applying an ACL that contains rules for these protocols to a Gigabit Ethernet interface is allowed but those rules have no effect.

- Apply to the interface before you enable an interface. This ensures that the filters are in place before traffic starts flowing.
- Be aware of the following conditions:
  - If you use the **log-deny** option, a maximum of 50 messages are logged per second.
  - The **established** option is ignored when you apply containing this option to Gigabit Ethernet interfaces.
  - If an rule applies to a pre-existing TCP connection, that rule is ignored. For example if there is an existing TCP connection between A and B and an IPv4-ACL which specifies dropping all packets whose source is A and destination is B is subsequently applied, it will have no effect.



### Note

If IPv4-ACLs are already configured in a Gigabit Ethernet interface, you cannot add this interface to an Ethernet PortChannel group. For information on configuring IPv4-ACLs, see the *Cisco Fabric Manager Security Configuration Guide* and *Cisco MDS 9000 Family NX-OS Security Configuration Guide*.

## Applying on Gigabit Ethernet Interfaces

To apply on a Gigabit Ethernet interface, follow these steps:

	Command	Purpose
Step 1	switch# <b>config t</b>	Enters configuration mode.
Step 2	switch(config)# <b>interface gigabitethernet 3/1</b> switch(config-if)#	Configures a Gigabit Ethernet interface (3/1).

	Command	Purpose
Step 3	<code>switch(config-if)# ip access-group SampleName</code>	Applies the IPv4-ACL SampleName on Gigabit Ethernet 3/1 for both ingress and egress traffic (if the association does not exist already).
Step 4	<code>switch(config-if)# ip access-group SampleName1 in</code>	Applies the IPv4-ACL SampleName on Gigabit Ethernet 3/1 for ingress traffic.
	<code>switch(config-if)# ip access-group SampleName2 out</code>	Applies the IPv4-ACL SampleName on Gigabit Ethernet 3/1 for egress traffic (if the association does not exist already).

## Address Resolution Protocol Cache

Cisco MDS NX-OS supports Address Resolution Protocol (ARP) cache for Gigabit Ethernet interface configured for IPv4. This section includes the following topics:

- [Displaying ARP Cache, page 7-284](#)
- [Clearing ARP Cache, page 7-284](#)

## Displaying ARP Cache

You can display the ARP cache on Gigabit Ethernet interfaces.



### Note

Use the physical interface, not the subinterface, for all ARP cache commands.

Use the `show ips arp interface gigabitethernet` command to display the ARP cache on the Gigabit Ethernet interfaces. This command takes the Ethernet interface as a parameter and returns the ARP cache for that interface. See [Example 7-3](#).

### Example 7-3 Displaying ARP Cache

```
switch# show ips arp interface gigabitethernet 7/1
Protocol      Address      Age (min)    Hardware Addr  Type   Interface
Internet     20.1.1.5     3            0005.3000.9db6 ARPA   GigabitEthernet7/1
Internet     20.1.1.10    7            0004.76eb.2ff5 ARPA   GigabitEthernet7/1
Internet     20.1.1.11    16           0003.47ad.21c4 ARPA   GigabitEthernet7/1
Internet     20.1.1.12    6            0003.4723.c4a6 ARPA   GigabitEthernet7/1
Internet     20.1.1.13    13           0004.76f0.ef81 ARPA   GigabitEthernet7/1
Internet     20.1.1.14    0            0004.76e0.2f68 ARPA   GigabitEthernet7/1
Internet     20.1.1.15    6            0003.47b2.494b ARPA   GigabitEthernet7/1
Internet     20.1.1.17    2            0003.479a.b7a3 ARPA   GigabitEthernet7/1
.
.
.
```

## Clearing ARP Cache

The ARP cache can be cleared in two ways: clearing just one entry or clearing all entries in the ARP cache.

Use the **clear ips arp** command to clear the ARP cache. See [Example 7-4](#) and [Example 7-5](#).

**Example 7-4 Clearing an ARP Cache Entry**

```
switch# clear ips arp address 10.2.2.2 interface gigabitethernet 8/7
arp clear successful
```

**Example 7-5 Clearing All ARP Cache Entries**

```
switch# clear ips arp interface gigabitethernet 8/7
arp clear successful
```

## Displaying IPv4 Statistics

Use the **show ips stats ip interface gigabitethernet** to display and verify IP v4 statistics. This command takes the main Ethernet interface as a parameter and returns the IPv4 statistics for that interface. See [Example 7-6](#).



**Note**

Use the physical interface, not the subinterface, to display IPv4 statistics.

**Example 7-6 Displaying IPv4 Statistics**

```
switch# show ips stats ip interface gigabitethernet 4/1
Internet Protocol Statistics for port GigabitEthernet4/1
  168 total received, 168 good, 0 error
  0 reassembly required, 0 reassembled ok, 0 dropped after timeout
  371 packets sent, 0 outgoing dropped, 0 dropped no route
  0 fragments created, 0 cannot fragment
```

## Default Settings for IPv4 Parameters

[Table 7-2](#) lists the default settings for IPv4 parameters.

**Table 7-2 Default IPv4 Parameters**

Parameters	Default
IPv4 MTU frame size	1500 bytes for all Ethernet ports
Autonegotiation	Enabled
Promiscuous mode	Disabled





## Configuring IPv6 for Gigabit Ethernet Interfaces

IP version 6 (IPv6) provides extended addressing capability beyond those provided in IP version 4 (IPv4) in Cisco MDS NX-OS. The architecture of IPv6 has been designed to allow existing IPv4 users to transition easily to IPv6 while providing services such as end-to-end security, quality of service (QoS), and globally unique addresses.

This chapter includes the following sections:

- [Overview of IPv6, page 8-287](#)
- [Configuring Basic Connectivity for IPv6, page 8-297](#)
- [Configuring Neighbor Discovery Parameters, page 8-303](#)
- [Gigabit Ethernet IPv6-ACL Guidelines, page 8-306](#)
- [Transitioning from IPv4 to IPv6, page 8-307](#)
- [Displaying IPv6, page 8-307](#)
- [Default Settings, page 8-308](#)



**Note**

For Cisco NX-OS features that use IP addressing, refer to the chapters in this guide that describe those features for information on IPv6 addressing support.



**Note**

To configure IP version 4 (IPv4) on a Gigabit Ethernet interface, see [Chapter 7, “Configuring IPv4 for Gigabit Ethernet Interfaces.”](#)

### Overview of IPv6

IP version 6 (IPv6) provides extended addressing capability beyond those provided in IP version 4 (IPv4) in Cisco MDS NX-OS by quadrupling the number of network address bits from 32 bits (in IPv4) to 128 bits. The architecture of IPv6 has been designed to allow existing IPv4 users to transition easily to IPv6 while providing services such as end-to-end security, quality of service (QoS), and globally unique addresses.

IPv6 provides the following enhancements over IPv4:

- Allows networks to scale and provide global reachability
- Reduces the need for private address and network address translation (NAT)
- Provides simpler autoconfiguration of addresses

IPv6 provides the following enhancements over IPv4:

- Allows networks to scale and provide global reachability.
- Reduces the need for private address and network address translation (NAT).
- Provides simpler autoconfiguration of addresses.

This section describes the IPv6 features supported by Cisco MDS NX-OS and includes the following topics:

- [Extended IPv6 Address Space for Unique Addresses, page 8-288](#)
- [IPv6 Address Formats, page 8-288](#)
- [IPv6 Address Prefix Format, page 8-289](#)
- [IPv6 Address Type-Unicast, page 8-289](#)
- [IPv6 Address Type-Multicast, page 8-291](#)
- [ICMP for IPv6, page 8-292](#)
- [Path MTU Discovery for IPv6, page 8-293](#)
- [IPv6 Neighbor Discovery, page 8-293](#)
- [Router Discovery, page 8-295](#)
- [IPv6 Stateless Autoconfiguration, page 8-295](#)
- [Dual IPv4 and IPv6 Protocol Stacks, page 8-296](#)

## Extended IPv6 Address Space for Unique Addresses

IPv6 extends the address space by quadrupling the number of network address bits from 32 bits (in IPv4) to 128 bits, which provides many more globally unique IP addresses. By being globally unique, IPv6 addresses enable global reachability and end-to-end security for networked devices, functionality that is crucial to the applications and services that are driving the demand for more addresses.

## IPv6 Address Formats

IPv6 addresses are represented as a series of 16-bit hexadecimal fields separated by colons (:) in the format x:x:x:x:x:x:x. The following are examples of IPv6 addresses:

```
2001:0DB8:7654:3210:FEDC:BA98:7654:3210
```

```
2001:0DB8:0:0:8:800:200C:417A
```

It is common for IPv6 addresses to contain successive hexadecimal fields of zeros. To make IPv6 addresses easier to use, two colons (::) may be used to compress successive hexadecimal fields of zeros at the beginning, middle, or end of an IPv6 address (the colons represent successive hexadecimal fields of zeros). [Table 8-1](#) lists compressed IPv6 address formats.



### Note

Two colons (::) can be used only once in an IPv6 address to represent the longest successive hexadecimal fields of zeros.



### Note

The hexadecimal letters in IPv6 addresses are not case-sensitive.

**Table 8-1 Compressed IPv6 Address Formats**

IPv6 Address Type	Uncompressed Format	Compressed Format
Unicast	2001:0DB8:800:200C:0:0:0:417A	2001:0DB8:800:200C::417A
Multicast	FF01:0:0:0:0:0:101	FF01::101

## IPv6 Address Prefix Format

An IPv6 address prefix, in the format *ipv6-prefix/prefix-length*, can be used to represent bit-wise contiguous blocks of the entire address space. The *ipv6-prefix* is specified in hexadecimal using 16-bit values between the colons. The *prefix-length* is a decimal value that indicates how many of the high-order contiguous bits of the address comprise the prefix (the network portion of the address). For example, 2001:0DB8:8086:6502::/32 is a valid IPv6 prefix.

## IPv6 Address Type-Unicast

An IPv6 unicast address is an identifier for a single interface on a single node. A packet that is sent to a unicast address is delivered to the interface identified by that address. The Cisco MDS NX-OS supports the following IPv6 unicast address types:

- Global addresses
- Link-local addresses

## Global Addresses

Global IPv6 addresses are defined by a global routing prefix, a subnet ID, and an interface ID. [Figure 8-1](#) shows the structure of a global address.

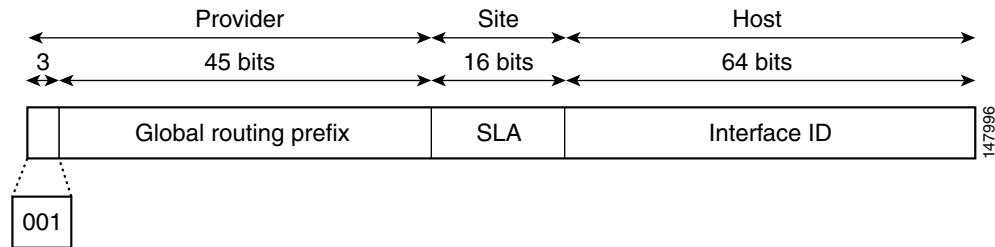
**Figure 8-1 Global Address Format**

Addresses with a prefix of 2000::/3 (001) through E000::/3 (111) are required to have 64-bit interface identifiers in the extended universal identifier (EUI)-64 format. The Internet Assigned Numbers Authority (IANA) allocates the IPv6 address space in the range of 2000::/16 to regional registries.

The aggregatable global address typically consists of a 48-bit global routing prefix and a 16-bit subnet ID or Site-Level Aggregator (SLA). In the IPv6 aggregatable global unicast address format document (RFC 2374), the global routing prefix included two other hierarchically structured fields named Top-Level Aggregator (TLA) and Next-Level Aggregator (NLA). The IETF decided to remove the TLA and NLA fields from the RFCs because these fields are policy-based. Some existing IPv6 networks deployed before the change might still be using networks based on the older architecture.

A 16-bit subnet field called the subnet ID could be used by individual organizations to create their own local addressing hierarchy and to identify subnets. A subnet ID is similar to a subnet in IPv4, except that an organization with an IPv6 subnet ID can support up to 65,535 individual subnets.

An interface ID is used to identify interfaces on a link. The interface ID must be unique to the link. They may also be unique over a broader scope. In many cases, an interface ID will be the same as, or based on, the link-layer address of an interface, which results in a globally unique interface ID. Interface IDs used in aggregatable global unicast and other IPv6 address types must be 64 bits long and constructed in the modified EUI-64 format.

Cisco MDS NX-OS supports IEEE 802 interface types (for example, Gigabit Ethernet interfaces). The first three octets (24 bits) are taken from the Organizationally Unique Identifier (OUI) of the 48-bit link-layer address (MAC address) of the interface, the fourth and fifth octets (16 bits) are a fixed hexadecimal value of FFFE, and the last three octets (24 bits) are taken from the last three octets of the MAC address. The construction of the interface ID is completed by setting the Universal/Local (U/L) bit—the seventh bit of the first octet—to a value of 0 or 1. A value of 0 indicates a locally administered identifier; a value of 1 indicates a globally unique IPv6 interface identifier (see [Figure 8-2](#)).

**Figure 8-2** Interface Identifier Format

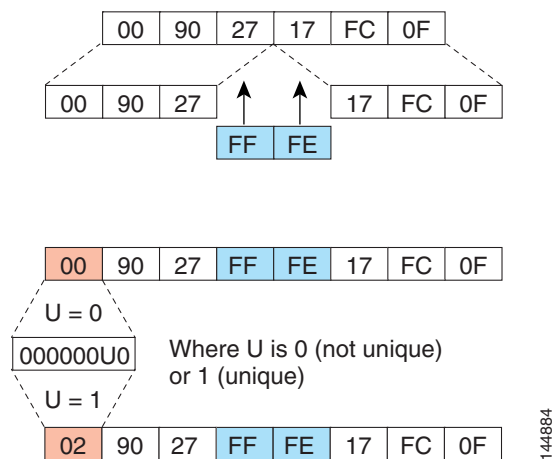

## Link-Local Address

A link-local address is an IPv6 unicast address that is automatically configured on an interface using the link-local prefix FE80::/10 and the interface identifier in the modified EUI-64 format. Link-local addresses are used in the neighbor discovery protocol and the stateless autoconfiguration process. Nodes on a local link can use link-local addresses to communicate. [Figure 8-3](#) shows the structure of a link-local address.

**Figure 8-3 Link-Local Address Format**

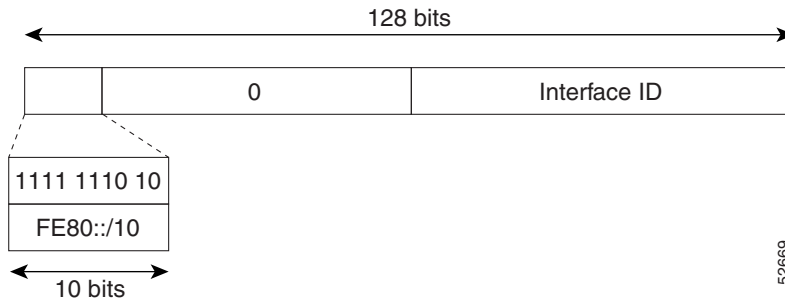

52669

## IPv6 Address Type-Multicast

An IPv6 multicast address is an IPv6 address that has a prefix of FF00::/8 (1111 1111). An IPv6 multicast address is an identifier for a set of interfaces that typically belong to different nodes. A packet sent to a multicast address is delivered to all interfaces identified by the multicast address. The second octet following the prefix defines the lifetime and scope of the multicast address. A permanent multicast address has a lifetime parameter equal to 0; a temporary multicast address has a lifetime parameter equal to 1. A multicast address has the scope of a node, link, site, or organization, or a global scope has a scope parameter of 1, 2, 5, 8, or E, respectively. For example, a multicast address with the prefix FF02::/16 is a permanent multicast address with a link scope. Figure 8-4 shows the format of the IPv6 multicast address.

**Figure 8-4 IPv6 Multicast Address Format**

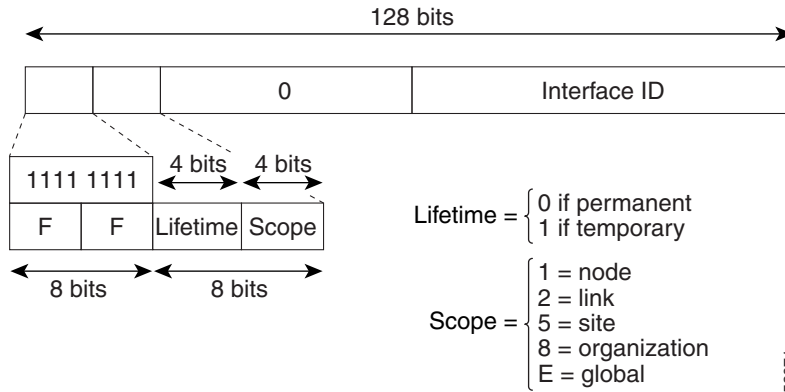

52671

IPv6 hosts are required to join (receive packets destined for) the following multicast groups:

- All-node multicast group FF02::1.
- Solicited-node multicast group FF02:0:0:0:0:1:FF00:0000/104 concatenated with the low-order 24 bit of the unicast address.

The solicited-node multicast address is a multicast group that corresponds to an IPv6 unicast address. IPv6 nodes must join the associated solicited-node multicast group for every unicast address to which it is assigned. The IPv6 solicited-node multicast address has the prefix FF02:0:0:0:0:1:FF00:0000/104 concatenated with the 24 low-order bits of a corresponding IPv6

unicast address. (See [Figure 8-5](#).) For example, the solicited-node multicast address corresponding to the IPv6 address 2037::01:800:200E:8C6C is FF02::1:FF0E:8C6C. Solicited-node addresses are used in neighbor solicitation messages.

**Figure 8-5 IPv6 Solicited-Node Multicast Address Format**

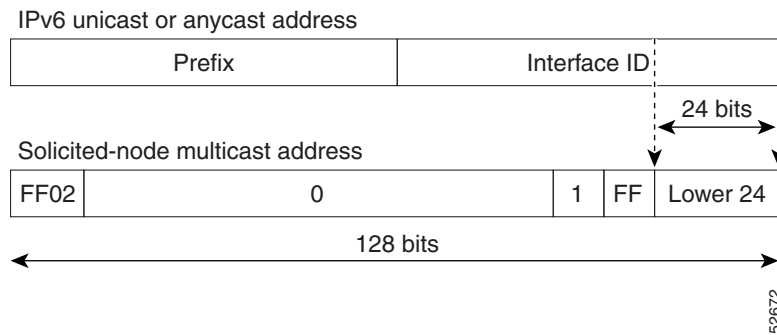

**Note**

There are no broadcast addresses in IPv6. IPv6 multicast addresses are used instead of broadcast addresses.

## ICMP for IPv6

Internet Control Message Protocol (ICMP) in IPv6 functions the same as ICMP in IPv4—ICMP generates error messages such as ICMP destination unreachable messages, and informational messages such as ICMP echo request and reply messages. Additionally, ICMP packets in IPv6 are used in the IPv6 neighbor discovery process, path MTU discovery, and the Multicast Listener Discovery (MLD) protocol for IPv6. MLD is based on version 2 of the Internet Group Management Protocol (IGMP) for IPv4.

A value of 58 in the Next Header field of the basic IPv6 packet header identifies an IPv6 ICMP packet. ICMP packets in IPv6 resemble a transport-layer packet in the sense that the ICMP packet follows all the extension headers and is the last piece of information in the IPv6 packet. Within IPv6 ICMP packets, the ICMPv6 Type and ICMPv6 Code fields identify IPv6 ICMP packet specifics, such as the ICMP message type. The value in the Checksum field is derived (computed by the sender and checked by the receiver) from the fields in the IPv6 ICMP packet and the IPv6 pseudoheader. The ICMPv6 Data field contains error or diagnostic information relevant to IP packet processing. [Figure 8-6](#) shows the IPv6 ICMP packet header format.

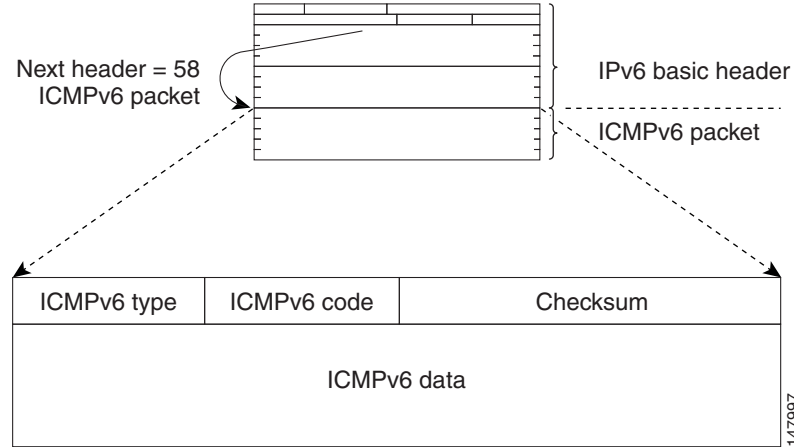
**Figure 8-6 IPv6 ICMP Packet Header Format**

## Path MTU Discovery for IPv6

As in IPv4, path MTU discovery in IPv6 allows a host to dynamically discover and adjust to differences in the MTU size of every link along a given data path. In IPv6, however, fragmentation is handled by the source of a packet when the path MTU of one link along a given data path is not large enough to accommodate the size of the packets. Having IPv6 hosts handle packet fragmentation saves IPv6 router processing resources and helps IPv6 networks run more efficiently.



### Note

In IPv4, the minimum link MTU is 68 octets, which means that the MTU size of every link along a given data path must support an MTU size of at least 68 octets.

In IPv6, the minimum link MTU is 1280 octets. We recommend using MTU value of 1500 octets for IPv6 links.

## IPv6 Neighbor Discovery

The IPv6 neighbor discovery process uses ICMP messages and solicited-node multicast addresses to determine the link-layer address of a neighbor on the same network (local link), verify the reachability of a neighbor, and keep track of neighboring routers.

### IPv6 Neighbor Solicitation and Advertisement Messages

A value of 135 in the Type field of the ICMP packet header identifies a neighbor solicitation message. Neighbor solicitation messages are sent on the local link when a node wants to determine the link-layer address of another node on the same local link. (See [Figure 8-7](#).) When a node wants to determine the link-layer address of another node, the source address in a neighbor solicitation message is the IPv6 address of the node sending the neighbor solicitation message. The destination address in the neighbor solicitation message is the solicited-node multicast address that corresponds to the IPv6 address of the destination node. The neighbor solicitation message also includes the link-layer address of the source node.

**Figure 8-7 IPv6 Neighbor Discovery—Neighbor Solicitation Message**

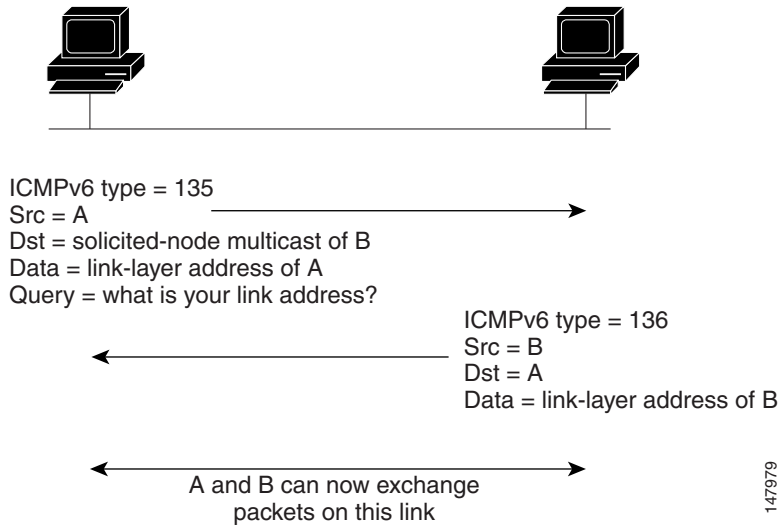

After receiving the neighbor solicitation message, the destination node replies by sending a neighbor advertisement message, which has a value of 136 in the Type field of the ICMP packet header, on the local link. The source address in the neighbor advertisement message is the IPv6 address of the node (more specifically, the IPv6 address of the node interface) sending the neighbor advertisement message. The destination address in the neighbor advertisement message is the IPv6 address of the node that sent the neighbor solicitation message. The data portion of the neighbor advertisement message includes the link-layer address of the node sending the neighbor advertisement message.

After the source node receives the neighbor advertisement, the source node and destination node can communicate.

Neighbor solicitation messages are also used to verify the reachability of a neighbor after the link-layer address of a neighbor is identified. When a node wants to verify the reachability of a neighbor, the destination address in a neighbor solicitation message is the unicast address of the neighbor.

Neighbor advertisement messages are also sent when there is a change in the link-layer address of a node on a local link. When there is such a change, the destination address for the neighbor advertisement is the all-node multicast address.

Neighbor solicitation messages are also used to verify the reachability of a neighbor after the link-layer address of a neighbor is identified. Neighbor unreachability detection identifies the failure of a neighbor or the failure of the forward path to the neighbor, and is used for all paths between hosts and neighboring nodes (hosts or routers). Neighbor unreachability detection is performed for neighbors to which only unicast packets are being sent and is not performed for neighbors to which multicast packets are being sent.

A neighbor is considered reachable when the neighbor returns a positive acknowledgment indicating that it has received and processed packets previously sent to it. A positive acknowledgment could be from an upper-layer protocol such as TCP indicating that a connection is making forward progress (reaching its destination) or the receipt of a neighbor advertisement message in response to a neighbor solicitation message. If packets are reaching the peer, they are also reaching the next-hop neighbor of the source. Therefore, forward progress is also a confirmation that the next-hop neighbor is reachable.

For destinations that are not on the local link, forward progress implies that the first-hop router is reachable. When acknowledgments from an upper-layer protocol are not available, a node probes the neighbor using unicast neighbor solicitation messages to verify that the forward path is still working. The return of a solicited neighbor advertisement message from the neighbor is a positive

acknowledgment that the forward path is still working (neighbor advertisement messages that have the solicited flag set to a value of 1 are sent only in response to a neighbor solicitation message). Unsolicited messages confirm only the one-way path from the source to the destination node; solicited neighbor advertisement messages indicate that a path is working in both directions.

**Note**

A neighbor advertisement message that has the solicited flag set to a value of 0 must not be considered as a positive acknowledgment that the forward path is still working.

Neighbor solicitation messages are also used in the stateless autoconfiguration process to verify the uniqueness of unicast IPv6 addresses before the addresses are assigned to an interface. Duplicate address detection is performed first on a new, link-local IPv6 address before the address is assigned to an interface (the new address remains in a tentative state while duplicate address detection is performed). Specifically, a node sends a neighbor solicitation message with an unspecified source address and a tentative link-local address in the body of the message. If another node is already using that address, the node returns a neighbor advertisement message that contains the tentative link-local address. If another node is simultaneously verifying the uniqueness of the same address, that node also returns a neighbor solicitation message. If no neighbor advertisement messages are received in response to the neighbor solicitation message and no neighbor solicitation messages are received from other nodes that are attempting to verify the same tentative address, the node that sent the original neighbor solicitation message considers the tentative link-local address to be unique and assigns the address to the interface.

Every IPv6 unicast address (global or link-local) must be checked for uniqueness on the link; however, until the uniqueness of the link-local address is verified, duplicate address detection is not performed on any other IPv6 addresses associated with the link-local address.

## Router Discovery

Router discovery performs both router solicitation and router advertisement. Router solicitations are sent by hosts to all-routers multicast addresses. Router advertisements are sent by routers in response to solicitations or unsolicited and contain default router information as well as additional parameters such as the MTU and hop limit.

## IPv6 Stateless Autoconfiguration

All interfaces on IPv6 nodes must have a link-local address, which is automatically configured from the identifier for an interface and the link-local prefix FE80::/10. A link-local address enables a node to communicate with other nodes on the link and can be used to further configure the node.

Nodes can connect to a network and automatically generate site-local and global IPv6 address without the need for manual configuration or help of a server, such as a DHCP server. With IPv6, a router on the link advertises in router advertisement (RA) messages any site-local and global prefixes, and its willingness to function as a default router for the link. RA messages are sent periodically and in response to router solicitation messages, which are sent by hosts at system startup. (See [Figure 8-8](#).)

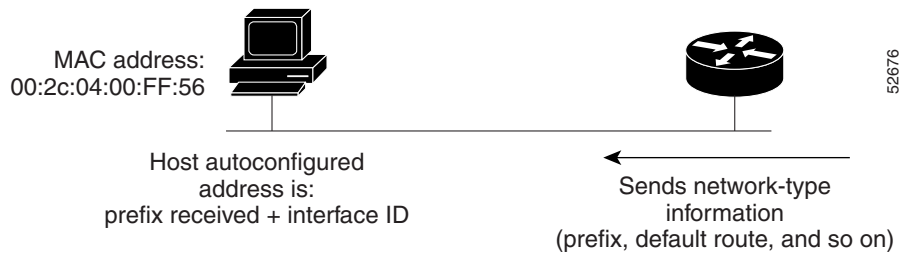
**Figure 8-8 IPv6 Stateless Autoconfiguration**

A node on the link can automatically configure site-local and global IPv6 addresses by appending its interface identifier (64 bits) to the prefixes (64 bits) included in the RA messages. The resulting 128-bit IPv6 addresses configured by the node are then subjected to duplicate address detection to ensure their uniqueness on the link. If the prefixes advertised in the RA messages are globally unique, then the IPv6 addresses configured by the node are also guaranteed to be globally unique. Router solicitation messages, which have a value of 133 in the Type field of the ICMP packet header, are sent by hosts at system startup so that the host can immediately autoconfigure without needing to wait for the next scheduled RA message.

## Dual IPv4 and IPv6 Protocol Stacks

The dual IPv4 and IPv6 protocol stack technique is one technique for a transition to IPv6. It enables gradual, one-by-one upgrades to applications running on nodes. Applications running on nodes are upgraded to make use of the IPv6 protocol stack. Applications that are not upgraded—they support only the IPv4 protocol stack—can coexist with upgraded applications on the same node. New and upgraded applications simply make use of both the IPv4 and IPv6 protocol stacks. (See [Figure 8-9](#).)

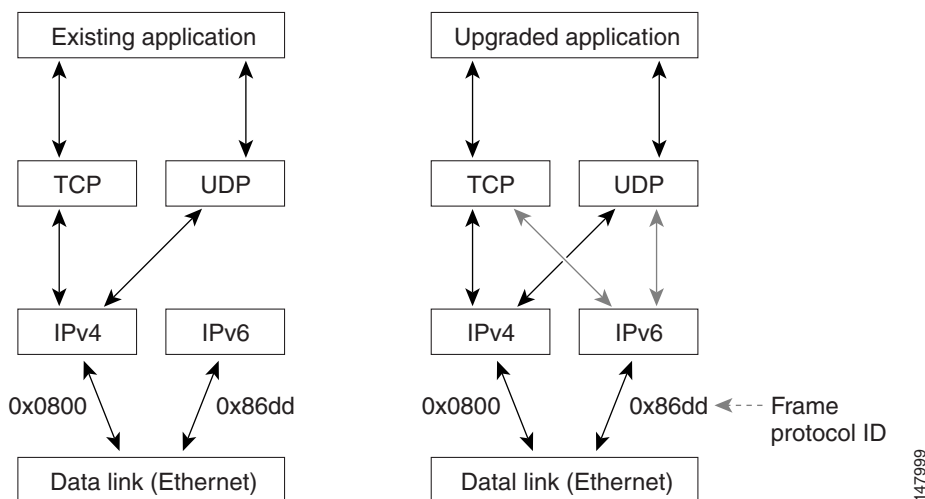
**Figure 8-9 Dual IPv4 and IPv6 Protocol Stack Technique**

A new API has been defined to support both IPv4 and IPv6 addresses and DNS requests. An application can be upgraded to the new API and still use only the IPv4 protocol stack. The Cisco MDS NX-OS supports the dual IPv4 and IPv6 protocol stack technique. When an interface is configured with both an IPv4 and an IPv6 address, the interface will accept and process both IPv4 and IPv6 traffic.

In [Figure 8-10](#), an application that supports dual IPv4 and IPv6 protocol stacks requests all available addresses for the destination host name `www.a.com` from a DNS server. The DNS server replies with all available addresses (both IPv4 and IPv6 addresses) for `www.a.com`. The application chooses an address—in most cases, IPv6 addresses are the default choice—and connects the source node to the destination using the IPv6 protocol stack.

**Figure 8-10** Dual IPv4 and IPv6 Protocol Stack Applications

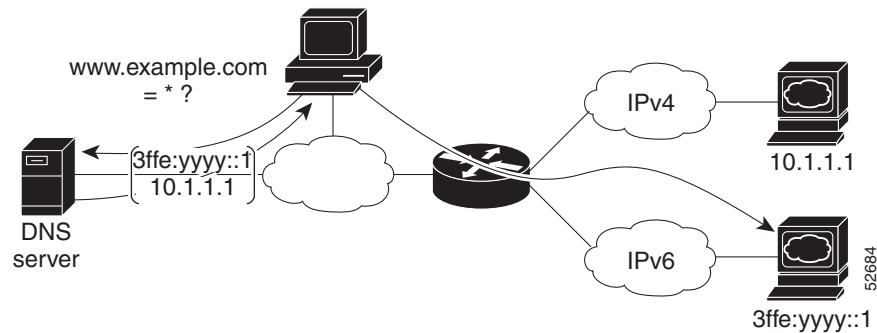

## Configuring Basic Connectivity for IPv6

The tasks in this section explain how to implement IPv6 basic connectivity. Each task in the list is identified as either required or optional. This section includes the following topics:

- [Configuring IPv6 Addressing and Enabling IPv6 Routing](#), page 8-297
- [Configuring IPv4 and IPv6 Protocol Addresses](#), page 8-300
- [Verifying Basic IPv6 Connectivity Configuration and Operation](#), page 8-301
- [Clearing IPv6 Neighbor Discovery Cache](#), page 8-302

## Configuring IPv6 Addressing and Enabling IPv6 Routing

### About Configuring IPv6 Addressing and Enabling IPv6 Routing

IPv6 addresses are represented as a series of 16-bit hexadecimal fields separated by colons (:) in the format `x:x:x:x:x:x:x`. It is common for IPv6 addresses to contain successive hexadecimal fields of zeros. To make IPv6 addresses easier to use, two colons (::) may be used to compress successive hexadecimal fields of zeros at the beginning, middle, or end of an IPv6 address (the colons represent successive hexadecimal fields of zeros). By default, IPv6 addresses are not configured, and IPv6 processing is disabled. You can configure IPv6 addresses on the following interface types:

- Gigabit Ethernet
- Management
- VLAN (Gigabit Ethernet subinterface)
- VSAN

Configuring a global IPv6 address on an interface automatically configures a link-local address and activates IPv6 for that interface. Additionally, the configured interface automatically joins the following required multicast groups for that link:

- Solicited-node multicast group FF02:0:0:0:1:FF00::/104 for each unicast address assigned to the interface
- All-node link-local multicast group FF02::1

This task explains how to assign IPv6 addresses to individual router interfaces and enable the processing of IPv6 traffic. By default, IPv6 addresses are not configured and IPv6 processing is disabled.

You can configure IPv6 addresses on the following interface types:

- Gigabit Ethernet
- Management
- VLAN (Gigabit Ethernet subinterface)
- VSAN

**Note**

The IPv6 address *ipv6-address* argument in the **ipv6 address** command must be in the form documented in RFC 2373, where the address is specified in hexadecimal using 16-bit values between colons.

The IPv6 prefix *ipv6-prefix* argument in the **ipv6 address** command must be in the form documented in RFC 2373, where the address is specified in hexadecimal using 16-bit values between colons.

The IPv6 prefix length *prefix-length* argument in the **ipv6 address** command is a decimal value that indicates how many of the high-order contiguous bits of the address comprise the prefix (the network portion of the address). A slash mark must precede the decimal value.

Configuring a global IPv6 address on an interface automatically configures a link-local address and activates IPv6 for that interface. Additionally, the configured interface automatically joins the following required multicast groups for that link:

- Solicited-node multicast group FF02:0:0:0:1:FF00::/104 for each unicast address assigned to the interface
- All-node link-local multicast group FF02::1



**Note** The solicited-node multicast address is used in the neighbor discovery process.

**Note**

The maximum number of IPv6 addresses (static and autoconfigured) allowed on an interface is eight, except on the management (mgmt 0) interface where only one static IPv6 address can be configured.

To configure an IPv6 address on an interface and enable IPv6 routing, follow these steps:

	Command or Action	Purpose
<b>Step 1</b>	switch# <b>config t</b> switch(config)#	Enters configuration mode.
<b>Step 2</b>	switch(config)# <b>interface gigabitethernet 1/1</b> switch(config-if)#	Specifies a Gigabit Ethernet interface and enters interface configuration submode.
	switch(config)# <b>interface mgmt 0</b> switch(config-if)#	Specifies the management interface and enters interface configuration submode.
	switch(config)# <b>interface gigabitethernet 2/2.100</b> switch(config-if)#	Specifies a Gigabit Ethernet subinterface (VLAN ID) and enters interface configuration submode.
	switch(config)# <b>interface vsan 10</b> switch(config-if)#	Specifies a VSAN interface and enters interface configuration submode.
<b>Step 3</b>	switch(config-if)# <b>ipv6 address 2001:0DB8:800:200C::417A/64</b>	Assigns a unicast IPv6 address to the interface, automatically configures an IPv6 link-local address on the interface, and enables IPv6 processing on the interface.
	switch(config-if)# <b>ipv6 enable</b>	Automatically configures an IPv6 link-local address on the interface while also enabling the interface for IPv6 processing. The link-local address can be used only to communicate with nodes on the same link.
<b>Step 4</b>	switch(config-if)# <b>no shutdown</b>	Enables the interface.
<b>Step 5</b>	switch(config-if)# <b>exit</b> switch(config)	Exits interface configuration submode and returns to configuration mode.
<b>Step 6</b>	switch(config)# <b>ipv6 routing</b>	Enables the processing of IPv6 unicast datagrams.

To configure an IPv6 address on an interface using Device Manager, follow these steps:

**Step 1** Choose **Interfaces > Gigabit Ethernet and iSCSI**.

You see the Gigabit Ethernet Configuration dialog box (see [Figure 8-11](#)).

**Figure 8-11 Gigabit Ethernet Configuration in Device Manager**

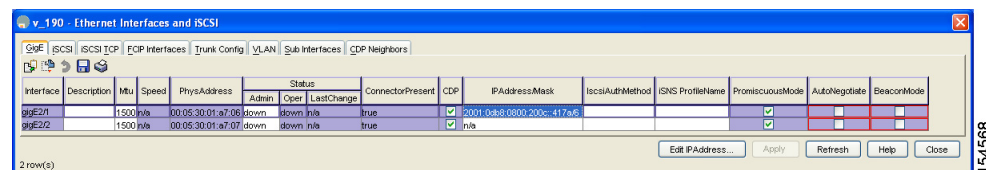

**Step 2** Click the IP Address that you want to configure and click **Edit IP Address**.

You see the IP Address dialog box.

**Step 3** Click **Create** and set the IP Address/Mask field, using the IPv6 format (for example, 2001:0DB8:800:200C::417A/64).

**Step 4** Click **Create** to save these changes or click **Close** to discard any unsaved changes.

To enable IPv6 routing using Device Manager, follow these steps:

**Step 1** Choose **IP > Routing**. You see the IP Routing Configuration dialog box. (see [Figure 8-11](#)).

**Figure 8-12** IP Routing Configuration in Device Manager

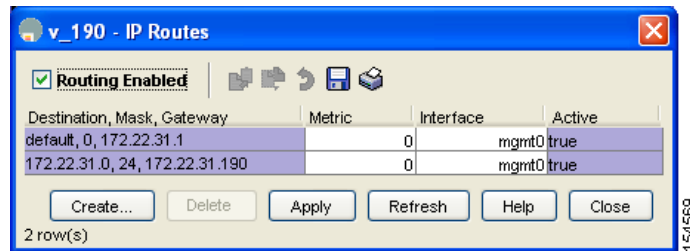

**Step 2** Check the **Routing Enabled** check box.

**Step 3** Click **Apply** to save these changes or click **Close** to discard any unsaved changes.

## Configuring IPv4 and IPv6 Protocol Addresses

When an interface in a Cisco networking device is configured with both an IPv4 and an IPv6 address, the interface can send and receive data on both IPv4 and IPv6 networks.

To configure an interface in a Cisco networking device to support both the IPv4 and IPv6 protocol stacks, follow these steps:

	Command	Purpose
<b>Step 1</b>	switch# <b>config t</b> switch(config)#	Enters configuration mode.
<b>Step 2</b>	switch(config)# <b>interface gigabitethernet 1/1</b> switch(config-if)#	Specifies the interface, and enters interface configuration submenu.
<b>Step 3</b>	switch(config-if)# <b>ip address 192.168.99.1</b> <b>255.255.255.0</b>	Specifies a primary or secondary IPv4 address for an interface.
<b>Step 4</b>	switch(config-if)# <b>ipv6 address</b> <b>2001:0DB8:c18:1::3/64</b>	Specifies the IPv6 network assigned to the interface and enables IPv6 processing on the interface.  <b>Note</b> See the “ <a href="#">Configuring IPv6 Addressing and Enabling IPv6 Routing</a> ” section for more information on configuring IPv6 addresses.
<b>Step 5</b>	switch(config-if)# <b>no shutdown</b>	Enables the interface.

	Command	Purpose
<b>Step 6</b>	switch(config-if)# <b>exit</b> switch(config)	Exits interface configuration submode, and returns to configuration mode.
<b>Step 7</b>	switch(config)# <b>ipv6 routing</b>	Enables the processing of IPv6 unicast datagrams.

To configure an interface in a Cisco networking device to support both the IPv4 and IPv6 protocol stacks using Device Manager, follow these steps:

- 
- Step 1** Choose **Interfaces > Gigabit Ethernet and iSCSI**.  
You see the Gigabit Ethernet Configuration dialog box.
- Step 2** Click the IP Address field that you want to configure and click **Edit IP Address**.  
You see the IP Address dialog box.
- Step 3** Click **Create** and set the IP Address/Mask field, using the IPv4 or IPv6 format.
- Step 4** Click **Create** to save these changes or click **Close** to discard any unsaved changes.
- 

## Verifying Basic IPv6 Connectivity Configuration and Operation

You can display information to verify the configuration and operation of basic IPv6 connectivity.

This section provides the following **show ipv6** command output examples:

- [Example Output for the show ipv6 interface Command](#)
- [Example Output for the show ipv6 neighbours Command](#)
- [Example Output for the show ipv6 traffic Command](#)

### Example Output for the show ipv6 interface Command

In the following example, the **show ipv6 interface** command is used to verify that IPv6 addresses are configured correctly for the Gigabit Ethernet 6/1 interface:

```
switch# show ipv6 interface mgmt 0
mgmt0 is up
  IPv6 is enabled
  Global address(es):
    2172:22::180/64
  Link-local address(es):
    fe80::b8db:adff:feba:d074
  ND DAD is disabled
  ND reachable time is 30000 milliseconds
  ND retransmission time is 1000 milliseconds
  Stateless autoconfig for addresses disabled
  MTU is 1500 bytes
```

## Example Output for the show ipv6 neighbours Command

In the following example, the **show ipv6 neighbours** command displays IPv6 neighbor discovery cache information for all interfaces:

```
switch# show ipv6 neighbours
R - Reachable, I - Incomplete, S - Stale, F - Failed, P - Probe, D - Delay
IPv6 Address                               Age  State Link-layer Addr  Interface
fe80::211:5dff:fe53:500a                   0    S    0011.5d53.500a    GigE6/1
fe80::211:5dff:fe53:500a                   0    S    0011.5d53.500a    GigE6/2
5000:1::250                                 0    S    0011.5d53.500a    po 4
fe80::211:5dff:fe53:500a                   0    S    0011.5d53.500a    po 4
fe80::211:5dff:fe53:500a                   0    S    0011.5d53.500a    po 4
fe80::2d0:3ff:fe61:4800                     184  S    00d0.0361.4800    mgmt0
```

In the following example, the **show ipv6 neighbours interface** command displays IPv6 neighbor discovery cache information for the Gigabit Ethernet 6/1 interface:

```
switch# show ipv6 neighbours interface gigabitethernet 6/1
R - Reachable, I - Incomplete, S - Stale, F - Failed, P - Probe, D - Delay
IPv6 Address                               Age  State Link-layer Addr  Interface
fe80::211:5dff:fe53:500a                   0    S    0011.5d53.500a    GigE6/1
```

## Example Output for the show ipv6 traffic Command

The **show ipv6 traffic** command displays IPv6 and ICMP statistics:

```
switch# show ipv6 traffic
IPv6 Statistics:
  Rcvd: 100 total, 0 local destination
        0 errors, 0 truncated, 0 too big
        0 unknown protocol, 0 dropped
        0 fragments, 0 reassembled
        0 couldn't reassemble, 0 reassembly timeouts
  Sent: 0 generated, 0 forwarded 0 dropped
        0 fragmented, 0 fragments created, 0 couldn't fragment

ICMPv6 Statistics:
  Rcvd: 100 total, 0 errors, 0 unreachable, 0 time exceeded
        0 too big, 0 param probs, 0 admin prohibits
        0 echos, 0 echo reply, 0 redirects
        0 group query, 0 group report, 0 group reduce
        0 router solicit, 69 router advert
        0 neighbor solicit, 31 neighbor advert
  Sent: 55 total, 0 errors, 0 unreachable, 0 time exceeded
        0 too big, 0 param probs, 0 admin prohibits
        0 echos, 0 echo reply, 0 redirects
        0 group query, 20 group report, 2 group reduce
        0 router solicit, 0 router advert
        0 neighbor solicit, 33 neighbor advert
```

## Clearing IPv6 Neighbor Discovery Cache

You can clear the IPv6 neighbor discovery cache using the **clear ipv6 neighbor** command in EXEC mode:

```
switch# clear ipv6 neighbor
```

## Configuring Neighbor Discovery Parameters

You can configure the following neighbor discovery parameters:

- Duplicate address detection attempts
- Reachability time
- Retransmission timer



### Note

We recommend that you use the factory-defined defaults for these parameters.

This section includes the following topics:

- [Duplicate Address Detection Attempts, page 8-303](#)
- [Reachability Time, page 8-303](#)
- [Retransmission Time, page 8-304](#)
- [Verifying Neighbor Discovery Parameter Configuration, page 8-304](#)

## Duplicate Address Detection Attempts

To configure the number of duplicate address detection attempts, follow these steps:

	Command or Action	Purpose
Step 1	switch# <b>config t</b> switch(config)#	Enters configuration mode.
Step 2	switch(config)# <b>interface gigabitethernet 3/1</b> switch(config-if)#	Specifies an interface and enters interface configuration submenu.
Step 3	switch(config-if)# <b>ipv6 nd dad attempts 3</b>	Sets the duplicate address detection attempts count to 100. The range is 0 to 15.
Step 4	switch(config-if)# <b>no ipv6 nd dad attempts</b>	Reverts to the default value (0). <b>Note</b> When the attempt count is set to 0, neighbor discovery is disabled.

## Reachability Time

To configure the reachability time, follow these steps:

	Command or Action	Purpose
Step 1	switch# <b>config t</b> switch(config)#	Enters configuration mode.
Step 2	switch(config)# <b>interface gigabitethernet 3/1</b> switch(config-if)#	Specifies an interface and enters interface configuration submenu.
Step 3	switch(config-if)# <b>ipv6 nd reachability-time 10000</b>	Sets the reachability time to 10000 milliseconds. The range is 1000 to 3600000 milliseconds.
Step 4	switch(config-if)# <b>no ipv6 nd reachability-time</b>	Reverts to the default value (30000 milliseconds).

## Retransmission Time

To configure the retransmission time, follow these steps:

	Command or Action	Purpose
Step 1	switch# <b>config t</b> switch(config)#	Enters configuration mode.
Step 2	switch(config)# <b>interface gigabitethernet 3/1</b> switch(config-if)#	Specifies an interface and enters interface configuration submenu.
Step 3	switch(config-if)# <b>ipv6 nd</b> <b>retransmission-timer 20000</b>	Sets the retransmission time to 20000 milliseconds. The range is 1000 to 3600000 milliseconds.
Step 4	switch(config-if)# <b>no ipv6 nd</b> <b>retransmission-timer</b>	Reverts to the default value (1000 milliseconds).

## Verifying Neighbor Discovery Parameter Configuration

The **show ipv6 interface** command displays the configuration of the neighbor discovery parameters:

```
switch# show ipv6 interface mgmt 0
mgmt0 is up
  IPv6 is enabled
  Global address(es):
    2003::1/64
  Link-local address(es):
    fe80::205:30ff:fe00:533e
  ND DAD is enabled, number of DAD attempts: 5
  ND reachable time is 50000 milliseconds
  ND retransmission time is 3000 milliseconds
  Stateless autoconfig for addresses disabled
```

## IPv6 Static Routes

Cisco MDS NX-OS supports static routes for IPv6. This section includes the following topics:

- [Configuring an IPv6 Static Route, page 8-304](#)
- [Verifying IPv6 Static Route Configuration and Operation, page 8-305](#)

### Configuring an IPv6 Static Route

You must manually configure IPv6 static routes and define an explicit path between two networking devices. IPv6 static routes are not automatically updated and must be reconfigured manually if the network topology changes.

You must manually configure IPv6 static routes and define an explicit path between two networking devices. IPv6 static routes are not automatically updated and must be manually reconfigured if the network topology changes.

To configure a IPv6 static route, follow these steps:

	Command or Action	Purpose
<b>Step 1</b>	switch# <b>confi g t</b> switch(config)#	Enters configuration mode.
<b>Step 2</b>	switch(config)# <b>ipv6 route ::/0</b> <b>gigabitethernet 3/1</b>	Configures a static default IPv6 route on a Gigabit Ethernet interface.
<b>Step 3</b>	switch(config)# <b>ipv6 route 2001:0DB8::/32</b> <b>gigabitethernet 3/2</b>	Configures a fully specified IPv6 static route on a Gigabit Ethernet interface.

To configure a IPv6 static route using Device Manager, follow these steps:

- 
- Step 1** Choose **IP > Routing**.  
You see the IP Routing Configuration dialog box.
- Step 2** Click **Create**.  
You see the Create IP Route dialog box.
- Step 3** Set the Dest field to the IPv6 destination address.
- Step 4** Set the Mask field to the IPv6 subnet mask.
- Step 5** Set the Gateway field to the IPv6 default gateway.
- Step 6** (Optional) Set the Metric field to the desired route metric.
- Step 7** Select the interface from the Interface drop-down menu.
- Step 8** Click **Create** to save these changes or click **Close** to discard any unsaved changes.
- 

## Verifying IPv6 Static Route Configuration and Operation

The **show ipv6 route** command displays the IPv6 route table for the switch:

```
switch# show ipv6 route

IPv6 Routing Table
Codes: C - Connected, L - Local, S - Static G - Gateway
G    ::/0
     via fe80::211:5dff:fe53:500a, GigabitEthernet6/1, distance 2
G    ::/0
     via fe80::2d0:3ff:fe61:4800, mgmt0, distance 2
C    2000::/64
     via ::, mgmt0
C    2172:22::/64
     via ::, mgmt0, distance 2
C    3000:3::/64
     via fe80::205:30ff:fe01:7ed6, GigabitEthernet4/1
C    3000:4::/64
     via fe80::205:30ff:fe01:7ed6, GigabitEthernet4/1.250
C    3000:5::/64
     via fe80::213:1aff:fee5:e69b, GigabitEthernet5/4
C    3000:6::/64
     via fe80::213:1aff:fee5:e69b, GigabitEthernet5/4.250
C    3000:7::/64
     via fe80::205:30ff:fe01:7ed7, GigabitEthernet4/2
C    3000:8::/64
```

```

    via fe80::205:30ff:fe01:7ed7, GigabitEthernet4/2.250
C   3000:9::/64
    via fe80::213:1aff:fee5:e69e, port-channel 3
C   3000:10::/64
    via fe80::213:1aff:fee5:e69e, port-channel 3.250
C   5000:1::/64
    via fe80::205:30ff:fe01:3917, GigabitEthernet6/2
C   5000:1::/64
    via fe80::205:30ff:fe01:3918, port-channel 4
C   6000:1:1:1::/64
    via fe80::205:30ff:fe01:3916, GigabitEthernet6/1
C   7000:1::/64
    via fe80::205:30ff:fe01:3917, GigabitEthernet6/2.250
C   7000:1::/64
    via fe80::205:30ff:fe01:3918, port-channel 4.250
C   7000:1:1:1::/64
    via fe80::205:30ff:fe01:3917, GigabitEthernet6/2, distance 2
L   fe80::/10
    via ::
L   ff00::/8
    via ::

```

## Gigabit Ethernet IPv6-ACL Guidelines



### Tip

If IPv6-ACLs are already configured in a Gigabit Ethernet interface, you cannot add this interface to a Ethernet PortChannel group. See the *Cisco Fabric Manager Security Configuration Guide Cisco MDS 9000 Family NX-OS Security Configuration Guide* for information on configuring IPv6-ACLs.

Follow these guidelines when configuring IPv6-ACLs for Gigabit Ethernet interfaces:

- Only use Transmission Control Protocol (TCP) or Internet Control Message Protocol (ICMP).



### Note

Other protocols such as User Datagram Protocol (UDP) and HTTP are not supported in Gigabit Ethernet interfaces. Applying an ACL that contains rules for these protocols to a Gigabit Ethernet interface is allowed but those rules have no effect.

- Apply IPv6-ACLs to the interface before you enable an interface. This ensures that the filters are in place before traffic starts flowing.
- Be aware of the following conditions:
  - If you use the **log-deny** option, a maximum of 50 messages are logged per second.
  - The **established** option is ignored when you apply IPv6-ACLs containing this option to Gigabit Ethernet interfaces.
  - If an IPv6-ACL rule applies to a preexisting TCP connection, that rule is ignored. For example, if there is an existing TCP connection between A and B and an IPv6-ACL that specifies dropping all packets whose source is A and destination is B is subsequently applied, it will have no effect.

See the *Cisco Fabric Manager Security Configuration Guide Cisco MDS 9000 Family NX-OS Security Configuration Guide* for information on applying IPv6-ACLs to an interface.

## Transitioning from IPv4 to IPv6

Cisco MDS NX-OS does not support any transitioning mechanisms from IPv4 to IPv6. However, you can use the transitioning schemes in the Cisco router products for this purpose. For information on configuring Cisco routers to transition your network, refer to the [“Implementing Tunneling for IPv6”](#) chapter.

## Displaying IPv6

Use the **show ips ipv6 neighbours interface** command for information about IPv6 neighbors for an interface:

```
switch# show ips ipv6 neighbours interface gigabitethernet 6/1
IPv6 Address                               Age (min)  Link-layer Addr  State  Interface
fe80::211:5dff:fe53:500a                   0          0011.5d53.500a   S      GigabitEthernet6/1
```

Use the **show ips ipv6 prefix-list interface** command for information about IPv6 prefixes for an interface:

```
switch# show ips ipv6 prefix-list interface gigabitethernet 6/1
Prefix                               Prefix-len  Addr
Valid Preferred
6000:1:1:1::                          64         ::
      2592000      604800
```

Use the **show ips ipv6 interface** command for information about the IPv6 routes for an interface:

```
switch# show ips ipv6 route interface gigabitethernet 6/1
IPv6 Routing Table - 4 entries
Codes: C - Connected, L - Local, S - Static, G - Gateway, M - Multicast
C 6000:1:1:1::/64 is directly connected, GigabitEthernet6/1
C 6000:1:1:1::/64 is directly connected, GigabitEthernet6/1
C fe80::/64 is directly connected, GigabitEthernet6/1
M ff02::/32 is multicast, GigabitEthernet6/1
G ::/0 via fe80::211:5dff:fe53:500a, GigabitEthernet6/1
```

Use the **show ips ipv6 routers interface** command for information about IPv6 routers for an interface:

```
switch# show ips ipv6 routers interface gigabitethernet 6/1
Addr                               Lifetime  Expire
fe80::211:5dff:fe53:500a           1800     1781
```

Use the **show ips ipv6 traffic interface** command for information about IPv6 traffic statistics for an interface:

```
switch# show ips ipv6 traffic interface gigabitethernet 6/1
IPv6 statistics:
  Rcvd: 5094 total
        0 bad header, 0 unknown option, 0 unknown protocol
        0 fragments, 0 total reassembled
        0 reassembly timeouts, 0 reassembly failures
  Sent: 13625 generated
        0 fragmented into 0 fragments, 0 failed
        2 no route
ICMP statistics:
  Rcvd: 1264 input, 0 checksum errors, 0 too short
        0 unknown info type, 0 unknown error type
  unreachable: 0 routing, 0 admin, 0 neighbor, 0 address, 0 port
  parameter: 0 error, 0 header, 0 option
  0 hopcount expired, 0 reassembly timeout, 0 too big
  0 echo request, 0 echo reply
```

```

734 group query, 0 group report, 0 group reduce
0 router solicit, 528 router advert, 0 redirects
0 neighbor solicit, 2 neighbor advert
Sent: 6045 output, 0 rate-limited
unreach: 0 routing, 0 admin, 0 neighbor, 1160 address, 0 port
parameter: 0 error, 0 header, 0 option
0 hopcount expired, 0 reassembly timeout, 0 too big
0 echo request, 0 echo reply
0 group query, 1466 group report, 0 group reduce
1 router solicit, 0 router advert, 0 redirects
3412 neighbor solicit, 6 neighbor advert

```

## Default Settings

Table 8-2 lists the default settings for IPv6 parameters.

**Table 8-2**      **Default IPv6 Parameters**

Parameters	Default
IPv6 processing	Disabled
Duplicate address detection attempts	0 (neighbor discovery disabled)
Reachability time	1000 milliseconds
Retransmission time	30000 milliseconds
IPv6-ACLs	None



---

## Symbols

\* (asterisk)

iSCSI node [4-156](#)

---

## A

AAA authentication

configuring [4-90](#)

access control

enforcing iSCSI

enforcing access control [4-89](#)

iSCSI [4-86, 4-88](#)

access control zoning based access control iSCSI

zoning based access control [4-89](#)

ACL based access control

configuring for iSCSI [4-88](#)

ACLs

configuring for iSCSI [4-88](#)

advertisement packets

setting time intervals [5-188](#)

ARP

clearing entries [5-178](#)

displaying entries [5-178](#)

ARP caches

clearing [7-219](#)

displaying [7-219](#)

authentication

CHAP option [4-135](#)

iSCSI setup [4-134](#)

local [4-91](#)

MD5 [5-189](#)

mechanism [4-91](#)

mutual CHAP mutual CHAP authentication [4-92](#)

restricting iSLB initiator authentication

restricting iSLB

restricting iSLB initiators [4-116](#)

simple text [5-189](#)

See also MD5 authentication

See also simple text authentication

autogenerated iSCSI target iSCSI

autogenerated target [4-90](#)

auto-negotiation

configuring Gigabit Ethernet interfaces [7-213](#)

---

## B

B ports

configuring [2-35](#)

interoperability mode [2-33](#)

SAN extenders [2-34](#)

bridge ports. See B ports

buffer sizes

configuring in FCIP profiles [2-28](#)

---

## C

CDP

configuring

CFS

iSLB config distribution [4-123](#)

CHAP authentication [4-90, 4-115](#)

configuring for iSCSI [4-135](#)

CHAP challenge [4-92](#)

CHAP response [4-92](#)

CHAP user name [4-92](#)

---

Cisco Discovery Protocol. See CDP  
 Cisco Transport Controller. See CTC  
 cloud discovery. See iSNS cloud discovery  
 congestion window monitoring. See CWM  
 core dumps  
   IPS modules [6-200](#)

CTC  
   description [2-22](#)  
   launching [2-22](#)

Cut-through routing mode [4-95](#)

CWM  
   configuring in FCIP profiles [2-27](#)

---

## D

default gateways. See IPv4 default gateways  
 default networks. See IPv4 default networks  
 differentiated services code point. See DSCP  
 direct memory access devices. See DMA-bridges

DMA-bridges  
   displaying statistics [6-206](#)

DNS  
   default settings [5-195](#)

DNS hosts  
   displaying information [5-194](#)

DNS servers  
   configuring [5-193](#)

domain names  
   defining [5-194](#)

Domain Name System servers. See DNS servers

drivers  
   iSCSI [4-68](#)

DSCP  
   configuring [2-36](#)  
 dynamic initiator mode parameter  
   distributed with CFS [4-123](#)  
 dynamic iSCSI initiator  
   converting [4-110](#)  
   convert to static iSCSI

  convert dynamic initiator to static [4-81](#)  
 dynamic mapping [4-72, 4-110](#)  
 dynamic mapping iSCSI  
   dynamic mapping iSCSI  
   static mapping static mapping [4-72](#)

---

## E

ELP  
   verifying using Device Manager (procedure) [2-22](#)  
 entity status inquiry. See ESI

E ports  
   configuring [2-37](#)  
   trunking configuration [2-22](#)

ESI  
   non-resp threshold [4-154](#)

Ethernet MAC statistics  
   displaying [6-206](#)

Ethernet PortChannels  
   adding Gigabit Ethernet interfaces [6-205](#)  
   configuring [6-204](#)  
   description [6-203](#)  
   iSCSI [4-133](#)  
   redundancy [2-10](#)

explicit fabric logout [4-78](#)

Extended Link Protocol. See ELP

external RADIUS server  
   CHAP [4-135](#)  
 external RADIUS servers  
   CHAP [4-135](#)

---

## F

FCIP [4-67](#)  
   advanced features [2-42](#)  
   checking trunk status (procedure) [2-22](#)  
   compression [2-53](#)  
   configuring [2-12 to 2-30, ?? to 2-30](#)

- configuring using FCIP Wizard [?? to 2-18](#)
  - default parameters [2-55](#)
  - discarding packets [2-33](#)
  - enabling [2-12](#)
  - Gigabit Ethernet ports [7-211](#)
  - high availability [2-8 to ??](#)
  - IPS modules [2-6](#)
  - IP storage services support [6-197](#)
  - link failures [2-9](#)
  - MPS-14/2 module [2-6](#)
  - tape acceleration [2-46 to 2-53](#)
  - time stamps [2-33](#)
  - VE ports [2-6](#)
  - verifying ELP (procedure) [2-22](#)
  - verifying interfaces (procedure) [2-22](#)
  - virtual ISLs [2-6](#)
  - VRRP [2-10](#)
  - write acceleration [2-42](#)
- FCIP compression
- configuring [2-54](#)
  - configuring (procedure) [2-15](#)
  - description [2-53](#)
  - displaying information [2-54](#)
- FCIP interfaces
- configuring advanced features [2-30 to 2-37, ?? to 2-37](#)
  - configuring peers [2-30](#)
  - configuring QoS [2-36](#)
  - creating [2-30](#)
  - displaying information [2-38](#)
  - parameters [2-8](#)
- FCIP links
- B port interoperability mode [2-33](#)
  - configuring [2-18](#)
  - configuring peers [2-30](#)
  - configuring QoS [2-36](#)
  - creating [2-21](#)
  - description [2-7](#)
  - endpoints [2-7](#)
  - initiating IP connections [2-32](#)
  - TCP connections [2-7](#)
- FCIP listener ports
- configuring [2-24](#)
- FCIP peers
- configuring IP addresses [2-31](#)
- FCIP profiles
- configuring listener ports [2-24](#)
  - configuring TCP parameters [2-24 to 2-29, ?? to 2-30](#)
  - creating [2-19](#)
  - description [2-8](#)
  - displaying information [2-20](#)
- FCIP tape acceleration
- configuring [2-51](#)
  - description [2-46 to 2-51](#)
  - displaying information [2-52](#)
- FCIP TCP parameters
- configuring buffer size [2-28](#)
  - configuring CWM [2-27](#)
  - configuring keepalive timeouts [2-25](#)
  - configuring maximum jitter [2-28](#)
  - configuring maximum retransmissions [2-25](#)
  - configuring minimum retransmit timeouts [2-24](#)
  - configuring PMTUs [2-25](#)
  - configuring SACKs [2-26](#)
  - configuring window management [2-26](#)
  - displaying [2-29, 2-30](#)
- FCIP write acceleration
- configuring [2-45](#)
  - configuring (procedure) [2-15](#)
  - description [2-42](#)
  - displaying information [2-45](#)
- FCP
- routing requests [4-70](#)
- Fibre Channel [4-67](#)
- iSCSI targets [4-72 to ??](#)
- Fibre Channel over IP. See FCIP
- Fibre Channel targets
- dynamic importing [4-73](#)
  - dynamic mapping [4-73](#)

Fibre Channel zoning-based access control [4-89](#)

## FPSF

load balancing (example) [2-9](#)

## frames

configuring MTU size [7-213](#)

## full core dumps

IPS modules [6-200](#)

## G

Gigabit Ethernet interface example [4-131](#)

## Gigabit Ethernet interfaces

configuring [?? to 6-205](#)

configuring auto-negotiation [7-213](#)

configuring high availability [6-201 to 6-205](#)

configuring IPv4 [7-212](#)

configuring IPv6 addresses [8-232](#)

configuring MTU frame sizes [7-213](#)

configuring promiscuous mode [7-214](#)

configuring static IPv4 routing [7-217](#)

configuring VRRP [6-202](#)

default parameters [7-220](#)

displaying statistics [6-205 to 6-209](#)

IPv4-ACL guidelines [7-217](#)

subinterfaces [7-216](#)

subnet requirements [7-216](#)

verifying connectivity [7-214](#)

## Gigabit Ethernet subinterfaces

configuring VLANs [7-216](#)

## global authentication

parameter distributed [4-123](#)

## H

HA solution example [4-129](#)

HBA port [4-77, 4-82](#)

## high availability

Ethernet PortChannel [4-133](#)

Ethernet PortChannels [2-10](#)

Fibre Channel PortChannels [2-11](#)

VRRP [2-10, 4-132](#)

VRRPVRRP-based high availability [4-132](#)

## ICMP

displaying statistics [6-208](#)

IPv6 [8-226](#)

## ICMP packets

IPv6 header format, figure [8-226](#)

## in-band management

IPFC [5-172](#)

## initiators

statically mapped iSCSI [4-107](#)

Internet Control Message Protocol. See ICMP

Internet Storage Name Service. See iSNS

## IP connections

active mode [2-32](#)

initiating [2-32](#)

passive mode [2-32](#)

## IPFC

configuration guidelines [5-172](#)

configuring VSAN interfaces [5-172](#)

description [5-172](#)

enabling IPv4 routing [5-173](#)

example configuration [5-173 to 5-176](#)

IPS core dumps. See core dumps

## IPS modules

CDP support [6-205](#)

core dumps [6-200](#)

FCIP [2-6](#)

partial core dumps [6-200](#)

port modes [7-211](#)

software upgrades [6-199](#)

supported features [6-197](#)

IPS ports [4-72](#)

modes [7-211](#)

- multiple connections [4-131](#)
- IP storage services
  - default parameters [6-209](#)
- IP Storage services modules. See IPS modules
- IPv4
  - configuring Gigabit Ethernet interfaces [7-212](#)
  - configuring management interfaces [5-169](#)
  - configuring virtual routers [5-185](#)
  - default settings [7-220](#)
  - description [7-211](#)
  - displaying statistics [7-219](#)
  - transitioning to IPv6 [8-239](#)
- IPv4-ACLs
  - guidelines for Gigabit Ethernet interfaces [7-217](#)
- IPv4 addresses
  - adding for VRRP [5-186](#)
  - configuring in VSANs [5-172](#)
  - configuring IPv6 and IPV6 protocol stacks [8-233](#)
  - IPv6 protocol stacks [8-230](#)
- IPv4 default gateways
  - configuring [5-170, 5-171](#)
  - description [5-170](#)
  - IP static routing [5-170](#)
  - static routes (tip) [5-171](#)
  - verifying configuration [5-170](#)
- IPv4 default networks
  - description [5-170](#)
- IPv4 routing
  - configuring Gigabit Ethernet interfaces [7-217](#)
  - disabling [5-173](#)
  - displaying route tables [7-217](#)
  - enabling [5-173](#)
  - verifying configuration [5-173](#)
- IPv4 static routing
  - configuring [5-177](#)
  - description [5-177](#)
  - verifying configuration [5-177](#)
- IPv6
  - address types [8-223](#)
  - configuring addressing [8-231](#)
  - configuring IPv4 and IPv6 addresses [8-233](#)
  - configuring management interfaces [5-169](#)
  - configuring neighbor discovery parameters [8-235](#)
  - configuring virtual routers [5-185](#)
  - default settings [8-240](#)
  - description [8-221 to 8-231](#)
  - displaying information [8-239](#)
  - dual IPv4 and IPv6 protocol stack applications, figure [8-231](#)
  - dual IPv4 and IPv6 protocol stacks [8-230](#)
  - dual IPv4 and IPv6 protocol stack technique, figure [8-230](#)
  - enabling routing [8-231](#)
  - enhancements over IPv4 [8-221](#)
  - ICMP [8-226](#)
  - IPv6-ACL guidelines [8-238](#)
  - neighbor discovery [8-227](#)
  - path MTU discovery [8-227](#)
  - router advertisement messages [8-229](#)
  - router discovery [8-229](#)
  - stateless autoconfiguration [8-229](#)
  - static routes [8-237](#)
  - transitioning from IPv4 [8-239](#)
  - verifying basic connectivity [8-233](#)
  - verifying configuration [8-233](#)
- IPv6-ACLs
  - guidelines for IPv6 [8-238](#)
- IPv6 addresses
  - adding for VRRP [5-186](#)
  - configuring [8-231](#)
  - configuring IPv4 and IPV6 protocol stacks [8-233](#)
  - formats [8-222](#)
  - link-local type [8-224](#)
  - multicast type [8-225](#)
  - prefix format [8-223](#)
  - unicast type [8-223](#)
- IPv6 neighbor discovery
  - advertisement messages [8-227](#)

- description [8-227](#)
- neighbor solicitation message, figure [8-228](#)
- solicitation messages [8-227](#)
- IPv6 routing
  - enabling [8-231](#)
- IPv6 static routes
  - configuring [8-237](#)
  - displaying the route table [8-237](#)
- IQN
  - formats [4-72](#)
- IQN's
  - formats [4-72](#)
- ISCSI
  - enforcing access control [4-89](#)
- iSCSI
  - access control [4-86 to 4-90](#)
  - add initiator to zone database [4-88](#)
  - advanced VSAN membershipadvanced VSAN membership [4-86](#)
  - checking for WWN conflicts [4-82](#)
  - configuring [4-67, 4-67 to ??, 4-70, ?? to 4-134](#)
  - configuring AAA authentication [4-90, 4-91](#)
  - configuring ACLs [4-88](#)
  - configuring VRRP [4-132](#)
  - default parameters [4-165](#)
  - discovery phase [4-89](#)
  - displaying global information [4-101](#)
  - displaying statistics [4-98](#)
  - drivers [4-68](#)
  - enabling [4-68, 4-71](#)
  - error [4-77](#)
  - Fibre Channel targets [4-72 to ??](#)
  - Gigabit Ethernet ports [7-211](#)
  - GW flagiSCSI
    - gateway device [4-78](#)
  - HA with host without multi-path software [4-128](#)
  - initiator idle timeoutinitiator idle timeout
    - iSCSIinitiator idle timeout
      - configuring with Fabric Manager [4-78](#)
  - initiator name [4-92](#)
  - IPS module support [6-198](#)
  - IQN's [4-76](#)
  - login redirect [4-108, 4-109](#)
  - LUN mapping for targets [4-141 to 4-147](#)
  - MPS-14/2 module support [6-198](#)
  - multiple IPS ports [4-131](#)
  - PortChannel-based high availability [4-133](#)
  - PortChannel-based high availabilityEthernet
    - PortChannel-based high availability [4-133](#)
  - protocol [4-67, 4-68](#)
  - requests and responses [4-70](#)
  - restrict an initiator to a specific user name for CHAP authentication [4-92](#)
  - routing [4-67, 4-68](#)
  - routing modes chartrouting modes chart for iSCSI [4-96](#)
  - session creation [4-90](#)
  - statically mapped initiators [4-107](#)
  - transparent initiator mode [4-77](#)
  - transparent mode initiator [4-136 to 4-141](#)
  - users with local authentication [4-91](#)
  - VSAN membership [4-84](#)
  - VSAN membership example [4-85](#)
  - VSAN membership for iSCSI interfaces [4-84](#)
- iSCSI authentication
  - CHAP option [4-135](#)
  - configuring [4-90, 4-115](#)
  - configuring mechanisms [4-91](#)
  - external RADIUS servers [4-135](#)
  - global override [4-91](#)
  - local authentication [4-91](#)
  - mechanisms [4-91](#)
  - restricting on initiators [4-92](#)
  - scenarios [4-134](#)
  - setup guidelines [4-134](#)
- iSCSI-based access control [4-86, 4-88](#)
- iSCSI devices
  - example membership in VSANs [4-85](#)
- iscsi-gw [4-83](#)

- iSCSI high availability
  - configuring [4-127 to 4-134](#)
- iSCSI hosts
  - initiator identification [4-76](#)
- iSCSI initiators
  - assigning WWNs [4-80](#)
  - configuring dynamic IP address mapping [4-79](#)
  - configuring static IP address mapping [4-80](#)
  - displaying information [4-103 to 4-106](#)
  - displaying proxy information [4-100](#)
  - dynamic mapping [4-79](#)
  - making dynamic WWN mapping static [4-81](#)
  - proxy mode [4-82](#)
  - static mapping [4-80](#)
  - transparent mode [4-77](#)
  - verifying configuration [4-112](#)
  - WWN assignments [4-79](#)
- iSCSI interfaces
  - configuring [4-76, 4-76 to 4-97](#)
  - configuring listener ports [4-94](#)
  - configuring listener portsiSCSI
    - listener port [4-94](#)
  - configuring QoS [4-95](#)
  - configuring routing mode [4-95 to 4-97](#)
  - configuring routing modesiSCS
    - configuring routing modesrouting modes [4-95](#)
  - configuring TCP tuning parameters [4-94](#)
  - creating [4-71](#)
  - creatingiSCSI
    - creating interfaces [4-71](#)
    - displaying information [4-97](#)
- iSCSI LUs [4-72](#)
- iSCSI protocol [4-67](#)
- iSCSI server load balancing [4-106](#)
- iSCSI Server Load Balancing. See iSLB
- iSCSI sessions
  - authentication [4-90 to 4-93](#)
  - displaying information [4-101](#)
- iSCSI targets
  - advertising [4-74](#)
  - dynamic importing [4-72](#)
  - dynamic mapping [4-72](#)
  - secondary access [4-129](#)
  - static importing [4-73](#)
  - static importingstatic mappingiSCSI targets
    - static mapping [4-73](#)
  - transparent failover [4-127 to 4-131](#)
- iSCSI users
  - displaying information [4-106](#)
- iSCSI virtual targets
  - displaying information [4-106](#)
- iSLB
  - activating zones [4-113](#)
  - auto-zoning [4-123](#)
  - committing configuration changescommitting configuration changes
    - iSLB [4-124](#)
  - configuration distribution [4-123 to ??, 4-123](#)
  - configuration prerequisites [4-108](#)
  - configuring [4-106](#)
  - configuring initiators and targets [4-113](#)
  - configuring VRRP [4-122](#)
  - configuring zones [4-113](#)
  - default settings [4-166](#)
  - distributing configuration using CF [4-123](#)
  - dynamic initiator mapping [4-110](#)
  - enabling configuration distribution [4-124](#)
  - initiator WWN assignment [4-106](#)
  - load balancing algorithm [4-119 to 4-121](#)
  - maximum initiators [4-108](#)
  - static initiator configurationinitiator configuration
    - static iSLB [4-107](#)
  - VSAN membership [4-111](#)
  - zone set activation failed [4-114](#)
- iSlb
  - default settings [4-166](#)
- iSLB initiators [4-108](#)
  - assigning WWNs [4-110](#)

- configuring [4-109 to 4-117](#)
  - configuring IP addresses [4-109](#)
  - configuring names [4-109](#)
  - configuring static name mapping [4-109](#)
  - description [4-108](#)
  - dynamic initiator mapping [4-110](#)
  - VSAN membership [4-111](#)
  - iSLB initiator targets
    - configuring [4-113](#)
    - description [4-113](#)
  - iSLB sessions
    - maximum per IPS portiSLB
      - maximum sessions per IPS port [4-108](#)
  - iSLB VRRP
    - displaying information [4-122](#)
    - enabling [4-122](#)
    - verifying configuration [4-122](#)
  - iSMS servers
    - enabling [4-153](#)
  - iSNS
    - client registration [4-154](#)
    - cloud discovery [4-161, 4-165](#)
    - configuring [4-155](#)
    - configuring servers [4-152 to 4-155](#)
    - description [4-147](#)
    - ESI [4-154](#)
  - iSNS client
    - description [4-147](#)
  - iSNS clients
    - creating profiles [4-148](#)
    - verifying configuration [4-149](#)
  - iSNS cloud discovery
    - CFS distribution [4-164](#)
    - description [4-162](#)
    - displaying statistics [4-165](#)
    - verifying configuration [4-163](#)
    - verifying membership [4-164](#)
    - verifying status [4-164](#)
  - iSNS profiles
    - creating [4-148](#)
    - verifying configuration [4-149](#)
  - iSNS servers
    - configuration distribution [4-153](#)
    - description [4-151](#)
    - displaying configurations [4-155 to 4-161](#)
    - enabling [4-153](#)
    - example scenario [4-151](#)
- 
- ## J
- jitter
    - configuring estimated maximum in FCIP profiles [2-28](#)
  - jumbo frames. See MTUs
- 
- ## K
- keepalive timeouts
    - configuring in FCIP profiles [2-25](#)
- 
- ## L
- latency
    - forwarding [4-95](#)
  - link-local addresses
    - description [8-224](#)
    - format, figure [8-224](#)
  - link redundancy
    - Ethernet PortChannel aggregation [6-203](#)
  - load balancing [4-107, 4-108, 4-109](#)
    - FSPF (example) [2-9](#)
    - PortChannels (example) [2-9](#)
    - weighted [4-112](#)
  - load metric [4-112](#)
  - lock the fabric [4-124](#)
  - LUN [4-72](#)
  - LUN mapping [4-129](#)
    - iSCSI [4-141 to 4-147](#)

## LUNs

- explicit access control [4-82](#)
- mapping and assignment [4-82](#)

LUs [4-72](#)

---

**M**

## management interfaces

- configuring for IPv4 [5-169](#)
- configuring for IPv6 [5-169](#)

## maximum retransmissions

- configuring in FCIP profiles [2-25](#)

## MD5 authentication

- VRRP [5-189](#)

## merge status conflictsiSLB

- merge status conflictsCFS
- merge status conflicts [4-126](#)

## mgmt0 interfaces

- configuring IPv4 addresses [5-169](#)
- configuring IPv6 addresses [5-169](#)
- local IPv4 routing [5-171](#)

## minimum retransmit timeouts

- configuring in FCIP profiles [2-24](#)

MPS-14/2 modules [4-67, 4-68, 4-69, 4-71, 4-83, 4-89](#)

- CDP support [6-205](#)
- FCIP [2-6](#)
- port modes [7-211](#)
- software upgrades [6-199](#)

## MTUs

- configuring frame sizes [7-213](#)
- configuring size
- path discovery for IPv6 [8-227](#)

## multicast addresses

- IPv6 alternative to broadcast addresses [8-226](#)
- IPv6 format, figure [8-225](#)
- IPv6 solicited-node format, figure [8-226](#)

multi-path software example [4-128](#)

## multiple VSANs

- configuring [5-180](#)

Multiprotocol Services modules. See MPS-14/2 modules

## mutual CHAP authentication

- configuring for iSCSI [4-92](#)
- configuring for iSLB [4-116](#)
- configuring for iSLBI [4-116](#)

---

**N**

## neighbor discovery

- configuring parameters [8-235](#)
- verifying configuration [8-236](#)

None authentication [4-90](#)

## NTP

- time-stamp option [2-33](#)

---

**O**

## overlay VSANs

- configuring [5-178](#)
- description [5-178](#)

---

**P**

## packets

- discarding in FCIP [2-33](#)

pass-thru routing mode [4-95](#)

## path MTUs. See PMTUs

PDU [4-95](#)

## PMTUs

- configuring in FCIP profiles [2-25](#)

## PortChannel

- interfaces [4-74](#)
- subinterfaces [4-74](#)

## PortChannels

- configuring for FCIP high availability [2-9](#)
- IQN formats [4-72](#)
- load balancing (example) [2-9](#)
- member combinations [6-203](#)

- redundancy [2-11](#)
- port modes
  - IPS [7-211](#)
- ports
  - virtual E [2-6](#)
- promiscuous mode
  - configuring Gigabit Ethernet interfaces [7-214](#)
- protocol [4-67](#)
- protocols
  - VRRP [4-72](#)
- proxy initiator
  - configuring iSCSI
    - configuring proxy initiator [4-83](#)
- proxy initiator mode [4-76, 4-87](#)
  - configuring [4-83](#)
  - zoning [4-84](#)
- proxy initiator mode iSCSI
  - proxy initiator mode [4-82](#)

---

## Q

- QoS
  - DSCP value [2-36](#)
- QoS values
  - configuring [4-95](#)

---

## R

- RADIUS
  - AAA authentication [4-90, 4-116](#)
- redundancy
  - Ethernet PortChannels [2-10, 2-11](#)
  - Fibre Channel PortChannels [2-11](#)
  - VRRP [2-10](#)
- router discovery
  - IPv6 [8-229](#)
- RSCNs [4-78](#)

---

## S

- SACKs
  - configuring in FCIP profiles [2-26](#)
- SAN extension tuner
  - assigning SCSI read/write commands [3-61, 3-63](#)
  - configuring [3-58](#)
  - configuring data patterns [3-64](#)
  - configuring nWWNs [3-60](#)
  - configuring virtual N ports [3-61](#)
  - data patterns [3-59](#)
  - default settings [3-66](#)
  - description [3-57](#)
  - initialization [3-60](#)
  - license requirements [3-59](#)
  - tuning guidelines [3-58](#)
  - verifying configuration [3-65](#)
- SCSI
  - routing requests [4-68](#)
- security parameter index. See SPI
- selective acknowledgments. See SACKs
- SPI
  - configuring virtual routers [5-189](#)
- statically imported iSCSI targets [4-129](#)
- static iSLB initiator
  - converting [4-110](#)
- static mapped iSCSI target iSCSI
  - static mapped target [4-90](#)
- static mapping [4-110](#)
- static WWN mapping [4-87](#)
- store-and-forward routing mode [4-95](#)
- subnet masks
  - configuring IPv4 routes [5-177](#)
- subnets
  - requirements [7-216](#)
- switch management
  - in-band [5-172](#)
- switchovers
  - VRRP [2-10](#)

**T**

## TACACS+

- AAA authentication [4-116](#)

- target discovery [4-155](#)

## TCP connections

- FCIP profiles [2-8](#)

## TCP parameters

- configuring in FCIP profiles [2-24 to 2-29, ?? to 2-30](#)

## TCP statistics

- displaying [6-207](#)

- TCP tuning parameters [4-94](#)

- transient failure [4-78](#)

- transparent initiator mode [4-76](#)

## transparent initiator mode iSCSI

- transparent initiator mode [4-82](#)

## troubleshooting

- CTC [2-22](#)

## trunking

- link state [2-22](#)

## trunking mode

- FCIP interface [2-8](#)

**V**

## VE ports

- description [2-6](#)

- FCIP [2-6](#)

- virtual E ports. See VE ports

- virtual Fibre Channel host [4-69](#)

## virtual ISLs

- description [2-6](#)

- Virtual LANs. See VLANs

- virtual router IDs. See VR IDs

- Virtual Router Redundancy Protocol. See VRRP

## Virtual Router Redundancy Protocol protocols

- Virtual Router Redundancy [4-107](#)

## virtual routers

- adding [5-185](#)

- adding primary IP addresses [5-186](#)

- authentication [5-189](#)

- configuring for IPv4 [5-185](#)

- configuring for IPv6 [5-185](#)

- default settings [5-195](#)

- deleting [5-185](#)

- initiating [5-185](#)

- setting priorities [5-187](#)

## VLANs

- configuring on Gigabit Ethernet subinterfaces [7-216](#)

- description [7-215](#)

## VR IDs

- configuring for IPv4 [5-185](#)

- configuring for IPv6 [5-185](#)

- description [5-183](#)

- mapping [5-183](#)

VRRP [4-107](#)

- algorithm for selecting Gigabit Ethernet interfaces [4-119 to 4-121](#)

- backup switches [5-183](#)

- clearing statistics [5-193](#)

- configuring advertisement time intervals [5-188](#)

- configuring for Gigabit Ethernet interfaces [6-202](#)

- configuring for iSLB [4-122](#)

- configuring virtual routers [5-185](#)

- configuring VR IDs for IPv4 [5-185](#)

- configuring VR IDs for IPv6 [5-185](#)

- default settings [5-195](#)

- description [5-183, 6-201](#)

- displaying information [5-191 to 5-193](#)

- displaying statistics [5-193](#)

- group members [6-201](#)

- initiating virtual routers [5-185](#)

- IQN formats [4-72](#)

- iSCSI parameter change impact [4-119](#)

- iSLB [4-117 to 4-123](#)

- master switches [5-183](#)

- MD5 authentication [5-189](#)

- primary IP address [5-186](#)

- priority preemption [5-188](#)
- security authentication [5-189](#)
- setting priorities [5-187](#)
- setting priority [5-187](#)
- simple text authentication [5-189](#)

VRRP group [4-85](#)

VRRP–I f iSCSI login redirect [4-108, 4-109](#)

VSAN interfaces

- configuring IPv4 addresses [5-172](#)
- verifying configuration [5-173](#)

VSANs

- configuring multiple IPv4 subnets [5-180](#)
- example membership for iSCSI devices [4-85](#)
- gateway switches [5-171](#)
- IPv4 static routing [5-177](#)
- iSLB [4-111](#)
- iSLB initiators [4-111](#)
- overlaid routes [5-178](#)
- traffic routing between [5-167](#)
- VRRP [5-183](#)

---

## W

window management

- configuring in FCIP profiles [2-26](#)

WWNs

- static binding [4-82](#)

---

## Z

zones

- configuring and activating for iSLB [4-113](#)
- iSLB [4-113](#)

zoning based access control

- configuring for iSCSI [4-87](#)
- configuring for iSCSIiSCSI
  - configuring zoning based access control [4-87](#)