



Networking and Management Connectivity

This chapter contains the following sections:

- [DHCP Relay, on page 1](#)
- [DNS, on page 3](#)
- [In-Band and Out-of-Band Management Access, on page 4](#)
- [IPv6 Support, on page 6](#)
- [Routing Within the Tenant, on page 11](#)
- [WAN and Other External Networks, on page 12](#)
- [Tenant Routed Multicast, on page 30](#)
- [Cisco ACI GOLF , on page 35](#)
- [Multipod, on page 38](#)
- [About Anycast Services, on page 42](#)
- [Remote Leaf Switches, on page 43](#)
- [QoS, on page 51](#)
- [HSRP, on page 53](#)

DHCP Relay

Although ACI fabric-wide flooding is disabled by default, flooding within a bridge domain is enabled by default. Because flooding within a bridge domain is enabled by default, clients can connect to DHCP servers within the same EPG. However, when the DHCP server is in a different EPG or Virtual Routing and Forwarding (VRF) instance than the clients, DHCP Relay is required. Also, when Layer 2 flooding is disabled, DHCP Relay is required.



Note When the ACI fabric acts as a DHCP relay, it inserts the DHCP Option 82 (the DHCP Relay Agent Information Option) in DHCP requests that it proxies on behalf of clients. If a response (DHCP offer) comes back from a DHCP server without Option 82, it is silently dropped by the fabric. When ACI acts as a DHCP relay, DHCP servers providing IP addresses to compute nodes attached to the ACI fabric must support Option 82. Windows 2003 and 2008 do not support option 82 but Windows 2012 does.

The figure below shows the managed objects in the management information tree (MIT) that can contain DHCP relays: user tenants, the `common` tenant, the `infra` tenant, the `mgmt` tenant, and fabric access.

Figure 1: DHCP Relay Locations in the MIT

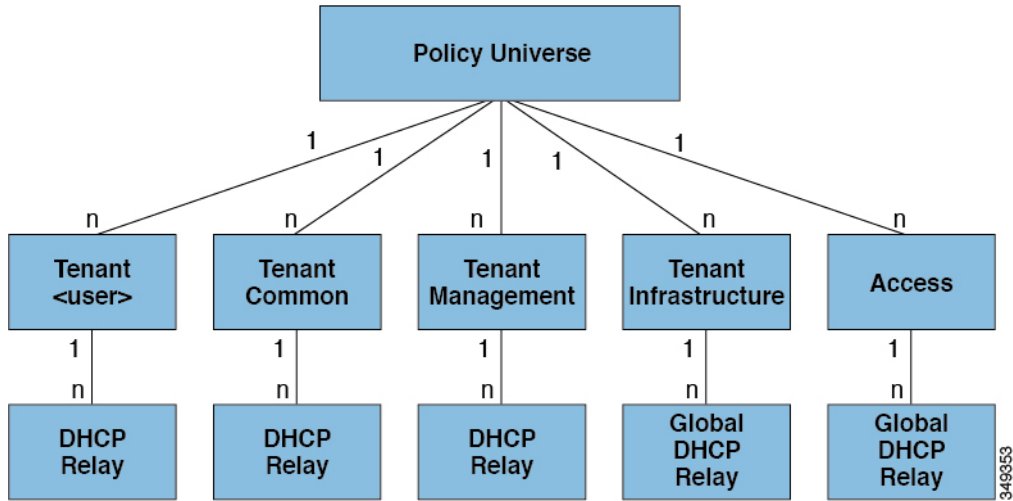

Note DHCP relay is limited to a single subnet per bridge domain.

The figure below shows the logical relationships of the DHCP relay objects within a user tenant.

Figure 2: Tenant DHCP Relay

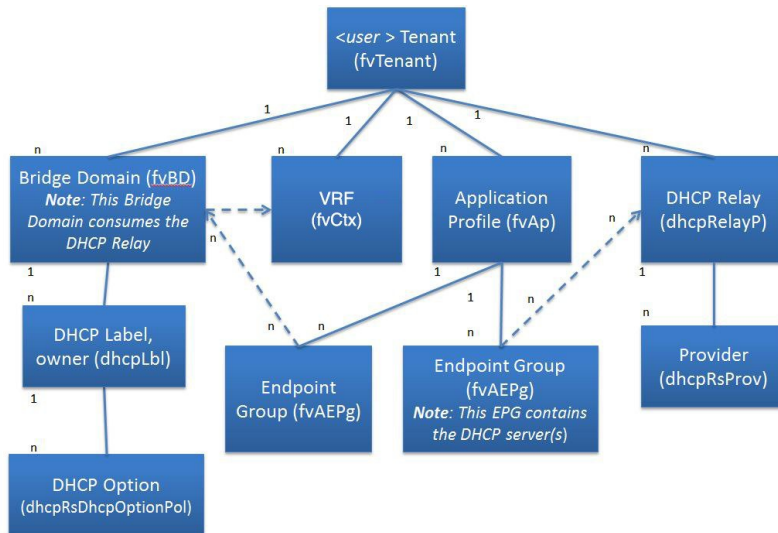

The DHCP Relay profile contains one or more providers. An EPG contains one or more DHCP servers, and the relation between the EPG and DHCP Relay specifies the DHCP server IP address. The consumer bridge domain contains a DHCP label that associates the provider DHCP server with the bridge domain. Label matching enables the bridge domain to consume the DHCP Relay.



Note The bridge domain DHCP label must match the DHCP Relay name.

The DHCP label object also specifies the owner. The owner can be a tenant or the access infrastructure. If the owner is a tenant, the ACI fabric first looks within the tenant for a matching DHCP Relay. If there is no match within a user tenant, the ACI fabric then looks in the common tenant.

DHCP Relay operates in the Visible mode as follows: `visible`—the provider's IP and subnet are leaked into the consumer's VRF. When the DHCP Relay is visible, it is exclusive to the consumer's VRF.

While the tenant and access DHCP Relays are configured in a similar way, the following use cases vary accordingly:

- Common tenant DHCP Relays can be used by any tenant.
- Infra tenant DHCP Relays are exposed selectively by the ACI fabric service provider to other tenants.
- Fabric Access (`infraInfra`) DHCP Relays can be used by any tenant and allow more granular configuration of the DHCP servers. In this case, it is possible to provision separate DHCP servers within the same bridge domain for each leaf switch in the node profile.

DNS

The ACI fabric DNS service is contained in the fabric managed object. The fabric global default DNS profile can be accessed throughout the fabric. The figure below shows the logical relationships of the DNS-managed objects within the fabric.

Figure 3: DNS

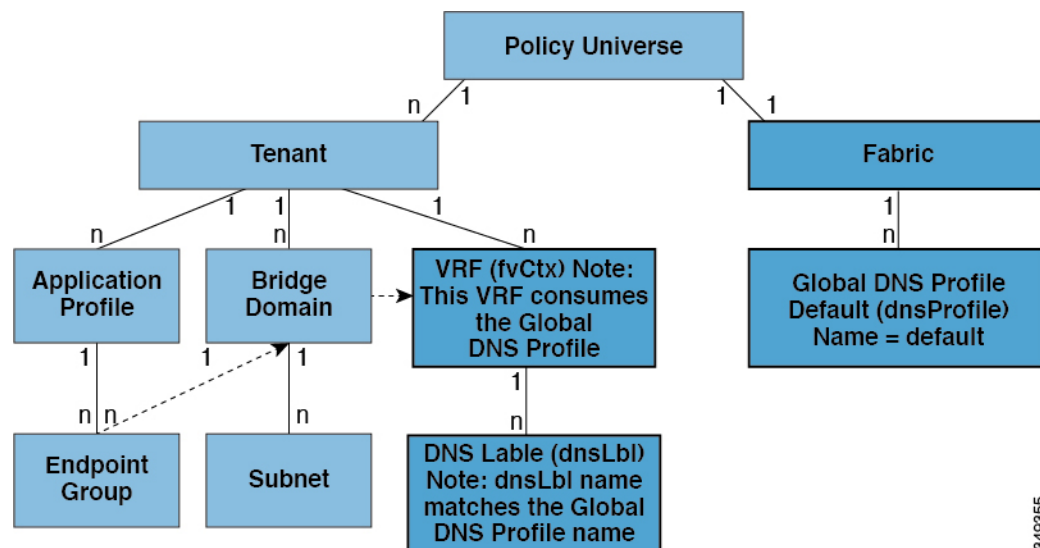

A VRF (context) must contain a `dnsLBl` object in order to use the global default DNS service. Label matching enables tenant VRFs to consume the global DNS provider. Because the name of the global DNS profile is "default," the VRF label name is "default" (`dnsLBl name = default`).

In-Band and Out-of-Band Management Access

The mgmt tenant provides a convenient means to configure access to fabric management functions. While fabric management functions are accessible through the APIC, they can also be accessed directly through in-band and out-of-band network policies.

Static and Dynamic Management Access

APIC supports both static and dynamic management access. For simple deployments where users manage the IP addresses of a few leaf and spine switches, configuring static in-band and out-of-band management connectivity is simpler. For more complex deployments, where you might have a large number of leaf and spine switches that require managing many IP addresses, static management access is not recommended. For detailed information about static management access, see *Cisco APIC and Static Management Access*.

In-Band Management Access

The following figure shows an overview of the mgmt tenant in-band fabric management access policy.

Figure 4: In-Band Management Access Policy

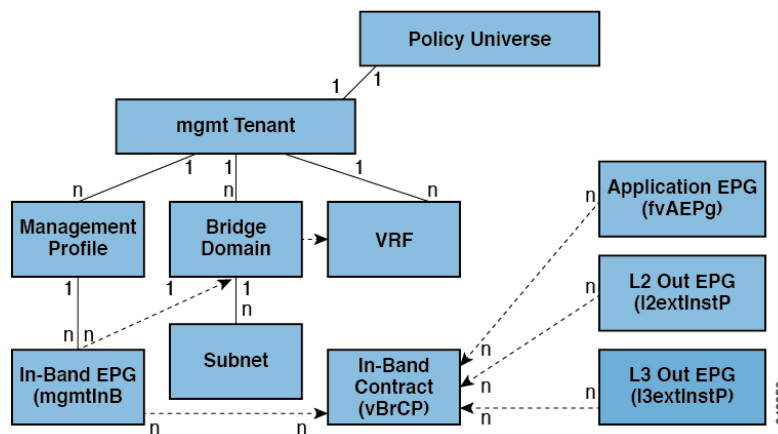

The management profile includes the in-band EPG MO that provides access to management functions via the in-band contract (*vzBrCP*). The *vzBrCP* enables *fvAEPg*, *l2extInstP*, and *l3extInstP* EPGs to consume the in-band EPG. This exposes the fabric management to locally connected devices, as well as devices connected over Layer 2 bridged external networks, and Layer 3 routed external networks. If the consumer and provider EPGs are in different tenants, they can use a bridge domain and VRF from the **common** tenant. Authentication, access, and audit logging apply to these connections; any user attempting to access management functions through the in-band EPG must have the appropriate access privileges.

The figure below shows an in-band management access scenario.

Figure 5: In-Band Management Access Scenario

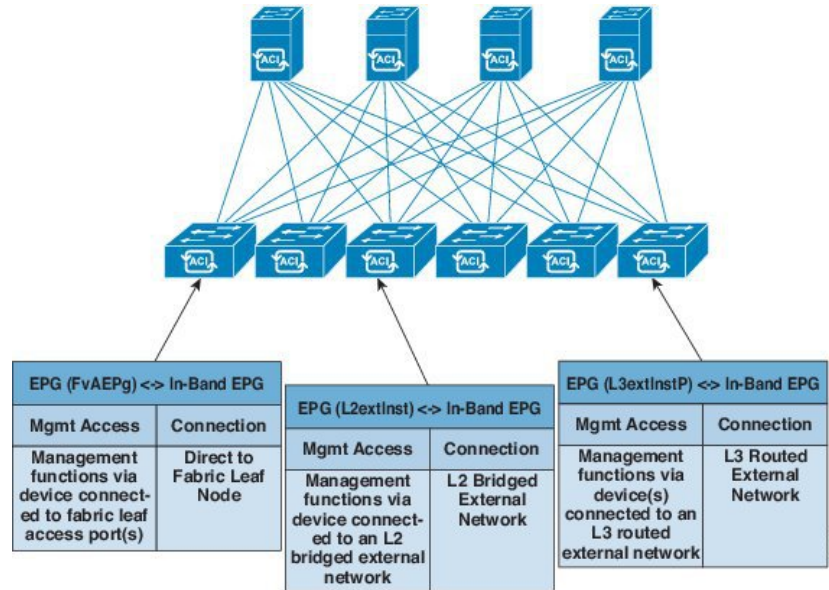

Out-of-Band Management Access

The following figure shows an overview of the mgmt tenant out-of-band fabric management access policy.

Figure 6: Out-of-Band Management Access Policy

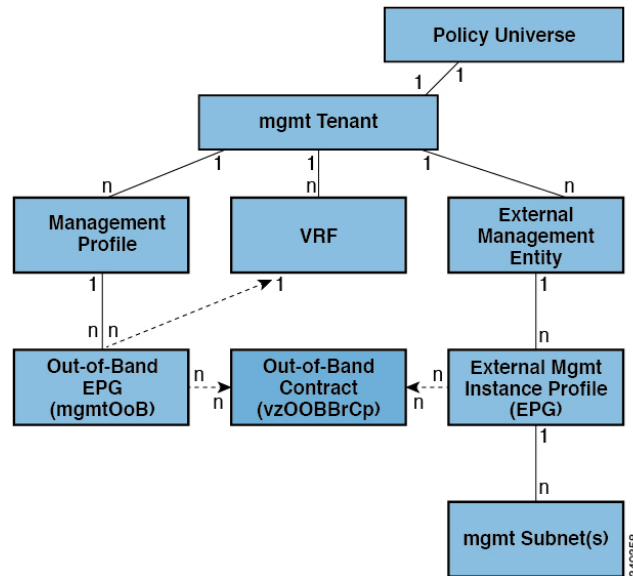

The management profile includes the out-of-band EPG MO that provides access to management functions via the out-of-band contract (`vzOOBBrCP`). The `vzOOBBrCP` enables the external management instance profile (`mgmtExtInstP`) EPG to consume the out-of-band EPG. This exposes the fabric node supervisor ports to locally or remotely connected devices, according to the preference of the service provider. While the bandwidth of the supervisor ports will be lower than the in-band ports, the supervisor ports can provide direct access to

the fabric nodes when access through the in-band ports is unavailable. Authentication, access, and audit logging apply to these connections; any user attempting to access management functions through the out-of-band EPG must have the appropriate access privileges. When an administrator configures an external management instance profile, it specifies a subnet range for devices that are allowed out-of-band access. Any device not in this range will not have out-of-band access.

The figure below shows how out-of-band management access can be consolidated through a dedicated switch.

Figure 7: Out-of-Band Access Scenario

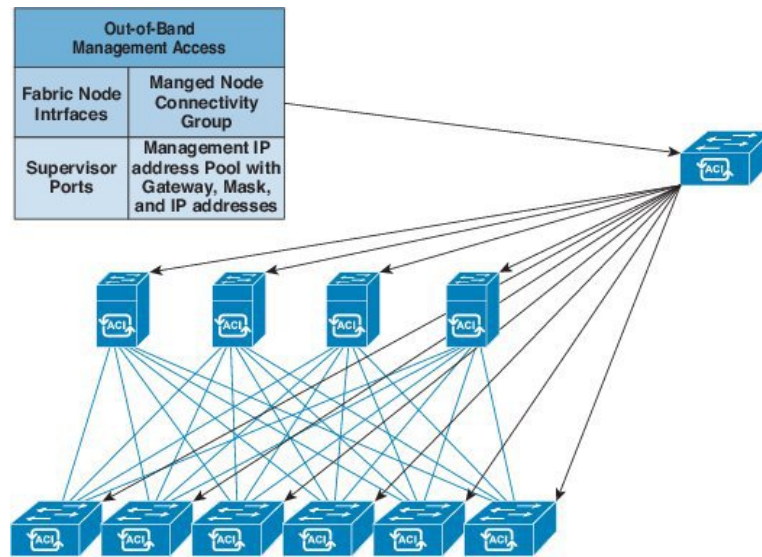

While some service providers choose to restrict out-of-band connectivity to local connections, others can choose to enable routed or bridged connections from external networks. Also, a service provider can choose to configure a set of policies that include both in-band and out-of-band management access for local devices only, or both local and remote devices.



Note Starting with APIC release 1.2(2), when a contract is provided on an out-of-band node management EPG, the default APIC out-of-band contract source address is the local subnet that is configured on the out-of-band node management address. Previously, any address was allowed to be the default APIC out-of-band contract source address.

IPv6 Support

The ACI fabric supports the following IPv6 features for in-band and out-of-band interfaces, tenant addressing, contracts, shared services, routing, Layer 4 - Layer 7 services, and troubleshooting:

- IPv6 address management, pervasive software virtual interface (SVI) bridge domain subnets, outside network external interface addresses, and routes for shared services such as load balancers or intrusion detection.
- Neighbor Discovery using ICMPv6 messages known as router advertisements (RA) and router solicitations (RS), and Duplicate Address Detection (DAD),

- Stateless Address Auto configuration (SLAAC) and DHCPv6.
- Bridge domain forwarding.
- Troubleshooting (see the atomic counters, SPAN, iping6, and traceroute topics in the Troubleshooting Chapter).
- IPv4 only, IPv6 only, or dual stack configuration of in-band and out-of-band interfaces.

Limitations of the current ACI fabric IPv6 implementation include the following:

- Multicast Listener Discovery (MLD) snooping is not supported.
- For IPv6 management, only static addresses are permitted; dynamic IPv6 pools are not supported for IPv6 management.
- IPv6 tunnel interfaces (Intra-Site Automatic Tunnel Addressing Protocol, 6to4 and so forth) are not supported within the fabric; IPv6 tunnel traffic run over the fabric is transparent to the fabric.

ACI fabric interfaces can be configured with link local, global unicast, and multicast IPv6 addresses.



Note While many of the examples provided in this manual use IPv4 addresses, IPv6 addresses could also be used.

A global unicast address can be routed across the public Internet; it is globally unique within a routing domain. A Link Local Address (LLA) has link-local scope and is unique on the link (subnet). The LLA cannot be routed across subnets. These are used by control protocols such as neighbor discovery or OSPF. Multicast addresses are used by IPv6 control protocols such as Neighbor Discovery to deliver packets to more than one endpoint. These are not configurable; they are automatically generated by the protocol components.

Global Unicast Addresses

An administrator can manually specify one or more complete 128-bit IPv6 global unicast addresses on an interface in compressed or uncompressed format. For example, the administration can specify the address in one of the following formats: '2001:0000:0000:0001:0000:0000:0000:0003', '2001:0:0:1:0:0:0:3', '2001:0:0:1::3'. In the ACI fabric naming property, an IPv6 address is always represented in the compressed format. In the above example, the Relative Name is: 2001:0:0:1::3. The administrator can choose any mask length as appropriate for the address.

An administrator can also specify an ACI fabric IPv6 global unicast address in EUI-64 format. As specified in RFC2373, Extended Unique Identifier (EUI) enables a host to assign itself a unique 64-bit IPv6 interface identifier (EUI-64). The IPv6 EUI-64 format address is obtained by incorporating the switch MAC address within the 128-bit IPv6 global unicast address. This feature of IPv6 eliminates the need for manual configuration or DHCP. An IPv6 address for a bridge domain or Layer 3 interface specified in the EUI-64 format is formed this way: <IPv6 prefix>::<mask>/eui64 where the mask is <=64. For example, 2002::/64/eui64 is what the administrator specifies, and the switch assigns the address as 2002::222:bdf:fe8:19ff/64. The switch uses the switch MAC address to create the EUI-64 address. The formed IPv6 address is contained in the `operAddr` field of the `ipv6If` object.



Note The EUI-64 format can only be used for pervasive bridge domain and Layer 3 interface addresses. It cannot be used for other IP fields in the fabric such as an external server address or for DHCP relay.

Bridge domain subnets and Layer 3 external interface IP addresses can be IPv6 global addresses with a mask ranging from /1 to /127. A bridge domain can contain multiple IPv4 and IPv6 subnets. To support IPv4 and IPv6 address on the same L3 external interface, the administrator creates multiple interface profiles. When an EPG or external EPG gets deployed on the switch, the presence of a manually configured link-local address for the equivalent bridge domain/L3 Interface or an IPv6 address for the subnet/address field results in the creation of `ipv6If` interface in the switch.

Link-Local Addresses

One Link-Local Address (LLA) can be assigned to an interface. The LLA can be autogenerated or configured by an administrator. By default, an ACI LLA is autogenerated by the switch in EUI-64 format. An administrator must configure at least one global address on the interface for an autogenerated LLA to be generated on the switch. The autogenerated address is saved in the `operLlAddr` field of the `ipv6If` MO. For pervasive SVIs the MAC address used is the same as the configured interface MAC address. For other kinds of interfaces the switch MAC address is used. An administrator has the option to manually specify a complete 128-bit IPv6 link-local address on an interface in compressed or uncompressed format.



Note The switch hardware tables are limited to one LLA per Virtual Routing and Forwarding (VRF) instance.

Each pervasive bridge domain can have a single IPv6 LLA. This LLA can be set by an administrator, or can be automatically configured by the switch when one isn't provided. When automatically configured, the switch forms the LLA in the modified EUI-64 format where the MAC address is encoded in the IPv6 address to form a unique address. A pervasive bridge domain uses one LLA on all the leaf nodes.

Follow these guidelines for setting LLAs:

- For external SVI and VPC members, the LLA is unique for every leaf node.
- LLAs can be changed to manual (non-zero manually specified link-local addresses) or auto (by manually setting the specified link-local address to zero) anytime in the lifecycle of the interface.
- LLAs specified by an administrator must conform to the IPv6 link-local format (FE80:/10).
- The IPv6 interface MO (`ipv6If`) is created on the switch upon the creation of the first global address on the interface, or when an administrator manually configures an LLA, whichever happens first.
- An administrator-specified LLA is represented in the `llAddr` property in the bridge domain and Layer 3 interface objects in the logical model.
- The LLA used by the switch (either from `llAddr` or autogenerated when `llAddr` is zero) is represented in the `operLlAddr` property in the corresponding `ipv6If` object.
- Operational LLA-related errors like duplicate LLAs are detected by the switch during Duplicate Address Detection process and recorded in `operStQual` field in the `ipv6If` object or raise faults as appropriate.
- Apart from the `llAddr` fields, an LLA (FE80:/10) cannot be a valid address in any other IP address field in the APIC (such as external server addresses or bridge domain subnets) as these addresses cannot be routed.

Static Routes

ACI IPv6 static routes are similar to what is supported in the IPv4, except for the address and prefix format differences in the configurations. The following types of static routes are typically handled by IPv6 static route module:

- Local Routes: Any /128 address configured on an interface leads to a local route that points to the CPU.
- Direct routes: For any configured address on a pervasive BD, the policy element pushes a subnet route pointing to an IPv4 proxy tunnel destination on the spine. For any configured address on a non-pervasive Layer 3 external interface, the IPv6 manager module automatically pushes a subnet route pointing to the CPU.
- Static routes pushed from PE: Used for external connectivity. The next hop IPv6 address for such routes can be on a directly connected subnet on the external router or a recursive next hop that can be resolved to a real next hop on a directly connected subnet. Note that the interface model does not allow an interface as a next hop (though it is supported in the switch). Used to enable shared services across tenants, the next hop for shared-services static routes is located in the shared services Virtual Routing and Forwarding (VRF) instance, which is different from the tenant VRF, where the route is installed on the ingress leaf switches.

Neighbor Discovery

The IPv6 Neighbor Discovery (ND) protocol is responsible for the address auto configuration of nodes, discovery of other nodes on the link, determining the link-layer addresses of other nodes, duplicate address detection, finding available routers and DNS servers, address prefix discovery, and maintaining reachability information about the paths to other active neighbor nodes.

ND-specific Neighbor Solicitation or Neighbor Advertisement (NS or NA) and Router Solicitation or Router Advertisement (RS or RA) packet types are supported on all ACI fabric Layer 3 interfaces, including physical, Layer 3 sub interface, and SVI (external and pervasive). Up to APIC release 3.1(1x), RS/RA packets are used for auto configuration for all Layer 3 interfaces but are only configurable for pervasive SVIs.

Starting with APIC release 3.1(2x), RS/RA packets are used for auto configuration and are configurable on Layer 3 interfaces including routed interface, Layer 3 sub interface, and SVI (external and pervasive).

ACI bridge domain ND always operates in flood mode; unicast mode is not supported.

The ACI fabric ND support includes the following:

- Interface policies (`nd:IfPol`) control ND timers and behavior for NS/NA messages.
- ND prefix policies (`nd:PxPol`) control RA messages.
- Configuration of IPv6 subnets for ND (`fv:Subnet`).
- ND interface policies for external networks.
- Configurable ND subnets for external networks, and arbitrary subnet configurations for pervasive bridge domains are not supported.

Configuration options include the following:

- Adjacencies
 - Configurable Static Adjacencies: (`<vrf, L3Iface, ipv6 address> --> mac address`)

- Dynamic Adjacencies: Learned via exchange of NS/NA packets
- Per Interface
 - Control of ND packets (NS/NA)
 - Neighbor Solicitation Interval
 - Neighbor Solicitation Retry count
 - Control of RA packets
 - Suppress RA
 - Suppress RA MTU
 - RA Interval, RA Interval minimum, Retransmit time
- Per Prefix (advertised in RAs) control
 - Lifetime, preferred lifetime
 - Prefix Control (auto configuration, on link)
- Neighbor Discovery Duplicate Address Detection (DAD)

Duplicate Address Detection

Duplicate address detection (DAD) discovers any other node on the link that is already using the address being configured. DAD is performed for both link-local and global addresses. Each configured address maintains the following DAD states:

- **NONE**—This is the state when the address is initially created before attempting the DAD.
- **VALID**—This is the state that represents the address has successfully passed the DAD process without detecting the address as a duplicate address.
- **DUP**—This is the state that represents the address is found as duplicate on the link.

Any configured address is usable for sending and receiving IPv6 traffic only if its DAD state is **VALID**.

Stateless Address Autoconfiguration (SLAAC) and DHCPv6

The following host configurations are supported:

- SLAAC only
- DHCPv6 only
- SLAAC and DHCPv6 stateless used together use SLAAC for address configuration only, but uses DHCPv6 for DNS resolution and other functions.

IPv6 addresses are supported for DHCP relay. DHCPv6 relay applies across Virtual Routing and Forwarding (VRF) instances. DHCP relay over VLAN and VXLAN are also supported. DHCPv4 works in conjunction with DHCPv6.

Routing Within the Tenant

The Application Centric Infrastructure (ACI) fabric provides tenant default gateway functionality and routes between the fabric virtual extensible local area (VXLAN) networks. For each tenant, the fabric provides a virtual default gateway or Switched Virtual Interface (SVI) whenever a subnet is created on the APIC. This spans any switch that has a connected endpoint for that tenant subnet. Each ingress interface supports the default gateway interface and all of the ingress interfaces across the fabric share the same router IP address and MAC address for a given tenant subnet.

Configuring Route Reflectors

ACI fabric route reflectors use multiprotocol BGP (MP-BGP) to distribute external routes within the fabric. To enable route reflectors in the ACI fabric, the fabric administrator must select the spine switches that will be the route reflectors, and provide the autonomous system (AS) number. It is recommended to configure at least two spine nodes per pod as MP-BGP route reflectors for redundancy.

After route reflectors are enabled in the ACI fabric, administrators can configure connectivity to external networks through leaf nodes using a component called Layer 3 Out (L3Out). A leaf node configured with an L3Out is called a border leaf. The border leaf exchanges routes with a connected external device via a routing protocol specified in the L3Out. You can also configure static routes via L3Outs.

After both L3Outs and spine route reflectors are deployed, border leaf nodes learn external routes via L3Outs, and those external routes are distributed to all leaf nodes in the fabric via spine MP-BGP route reflectors.

Check the *Verified Scalability Guide for Cisco APIC* for your release to find the maximum number of routes supported by a leaf.

Common Pervasive Gateway

Multiple ACI fabrics can be configured with an IPv4 common gateway on a per bridge domain basis. Doing so enables moving one or more virtual machines (VM) or conventional hosts across the fabrics while the host retains its IP address. VM host moves across fabrics can be done automatically by the VM hypervisor. The ACI fabrics can be co-located, or provisioned across multiple sites. The Layer 2 connection between the ACI fabrics can be a local link, or can be across a routed WAN link. The following figure illustrates the basic common pervasive gateway topology.

Figure 8: ACI Multi-Fabric Common Pervasive Gateway

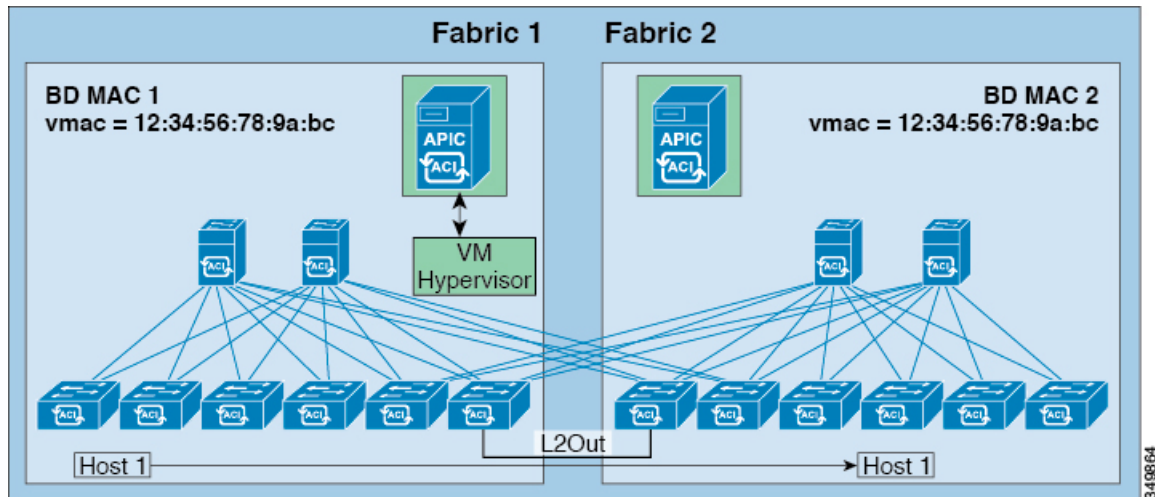

The per-bridge domain common pervasive gateway configuration requirements are as follows:

- The bridge domain MAC (*mac*) values for each fabric must be unique.



Note The default bridge domain MAC (*mac*) address values are the same for all ACI fabrics. The common pervasive gateway requires an administrator to configure the bridge domain MAC (*mac*) values to be unique for each ACI fabric.

- The bridge domain virtual MAC (*vmac*) address and the subnet virtual IP address must be the same across all ACI fabrics for that bridge domain. Multiple bridge domains can be configured to communicate across connected ACI fabrics. The virtual MAC address and the virtual IP address can be shared across bridge domains.

WAN and Other External Networks

External routers that connect to the WAN and the enterprise core connect to the front panel interfaces of the leaf switch. The leaf switch interface that connects to the external router can be configured as a bridged interface or a routing peer.

Router Peering and Route Distribution

As shown in the figure below, when the routing peer model is used, the leaf switch interface is statically configured to peer with the external router's routing protocol.

Figure 9: Router Peering

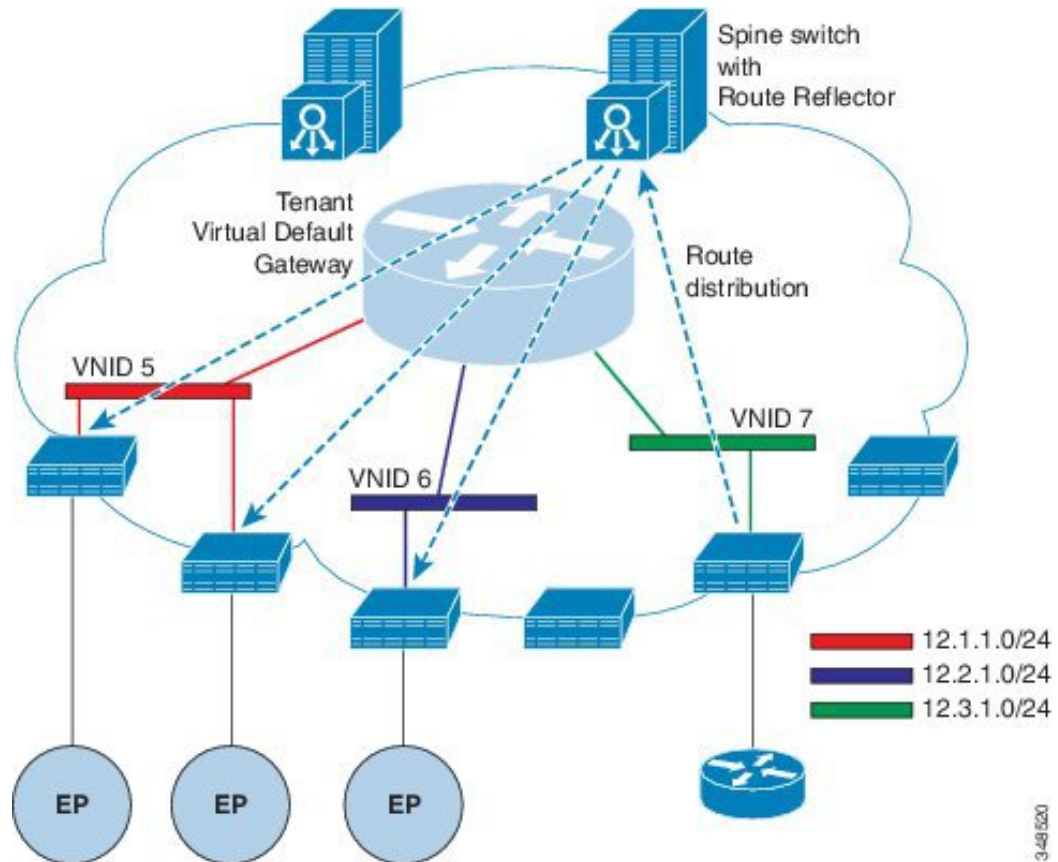

The routes that are learned through peering are sent to the spine switches. The spine switches act as route reflectors and distribute the external routes to all of the leaf switches that have interfaces that belong to the same tenant. These routes are longest prefix match (LPM) summarized addresses and are placed in the leaf switch's forwarding table with the VTEP IP address of the remote leaf switch where the external router is connected. WAN routes have no forwarding proxy. If the WAN routes do not fit in the leaf switch's forwarding table, the traffic is dropped. Because the external router is not the default gateway, packets from the tenant endpoints (EPs) are sent to the default gateway in the ACI fabric.

Networking Domains

A fabric administrator creates domain policies that configure ports, protocols, VLAN pools, and encapsulation. These policies can be used exclusively by a single tenant, or shared. Once a fabric administrator configures domains in the ACI fabric, tenant administrators can associate tenant endpoint groups (EPGs) to domains.

The following networking domain profiles can be configured:

- VMM domain profiles (`vmmDomP`) are required for virtual machine hypervisor integration.
- Physical domain profiles (`physDomP`) are typically used for bare metal server attachment and management access.
- Bridged outside network domain profiles (`l2extDomP`) are typically used to connect a bridged external network trunk switch to a leaf switch in the ACI fabric.

- Routed outside network domain profiles (`l3extDomP`) are used to connect a router to a leaf switch in the ACI fabric.
- Fibre Channel domain profiles (`fcDomP`) are used to connect Fibre Channel VLANs and VSANs.

A domain is configured to be associated with a VLAN pool. EPGs are then configured to use the VLANs associated with a domain.



Note EPG port and VLAN configurations must match those specified in the domain infrastructure configuration with which the EPG associates. If not, the APIC will raise a fault. When such a fault occurs, verify that the domain infrastructure configuration matches the EPG port and VLAN configurations.

Bridged and Routed Connectivity to External Networks

Outside network managed objects enable Layer 2 and Layer 3 tenant connectivity to external networks. The GUI, CLI, or REST API can be used to configure tenant connectivity to external networks. To easily locate the external network access points in the fabric, Layer 2 and Layer 3 external leaf nodes can be tagged as "Border Leaf Nodes."

Layer 2 Out for Bridged Connectivity to External Networks

Tenant Layer 2 bridged connectivity to external networks is enabled by associating a fabric access (`infraInfra`) external bridged domain (`L2extDomP`) with the Layer 2 external instance profile (`l2extInstP`) EPG of a Layer 2 external outside network (`l2extOut`) as shown in the figure below.

Figure 10: Tenant Bridged Connectivity to External Networks

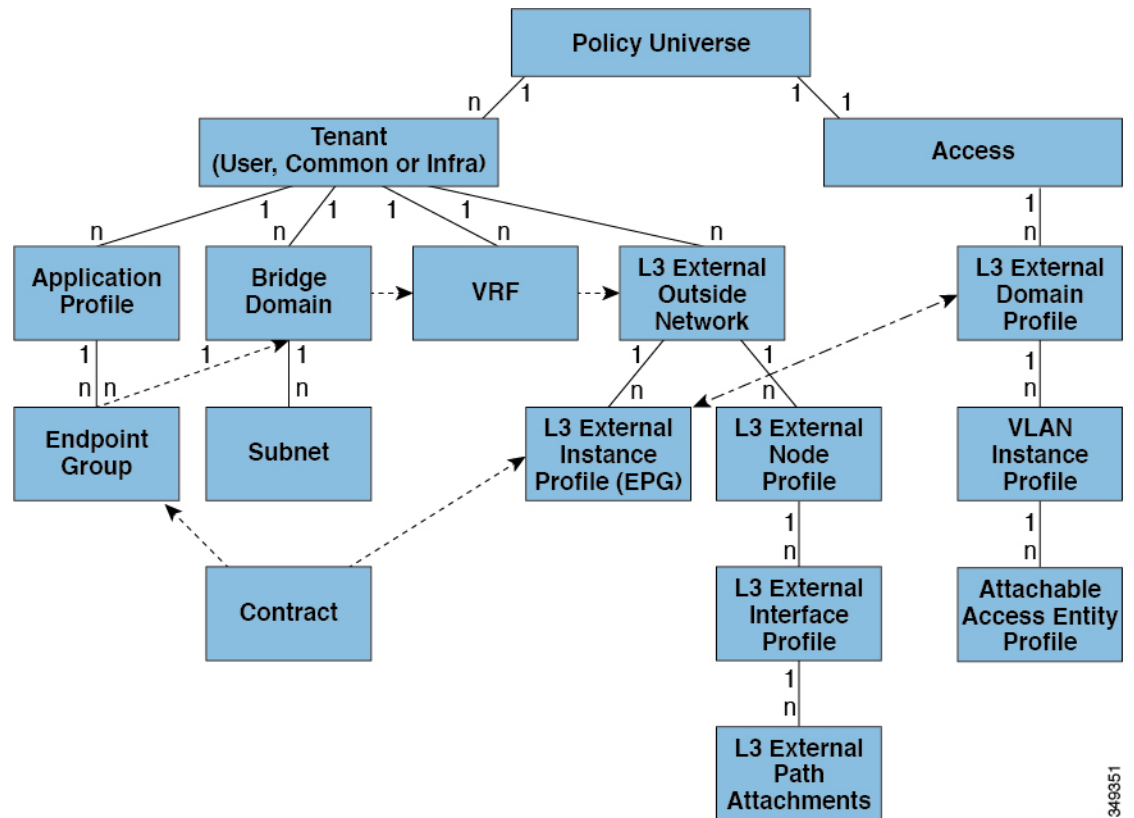

The `l2extOut` includes the switch-specific configuration and interface-specific configuration. The `l2extInstP` EPG exposes the external network to tenant EPGs through a contract. For example, a tenant EPG that contains a group of network-attached storage devices could communicate through a contract with the `l2extInstP` EPG according to the network configuration contained in the Layer 2 external outside network. Only one outside network can be configured per leaf switch. However, the outside network configuration can easily be reused for multiple nodes by associating multiple nodes with the Layer 2 external node profile. Multiple nodes that use the same profile can be configured for fail-over or load balancing.

Bridged Interface to an External Router

As shown in the figure below, when the leaf switch interface is configured as a bridged interface, the default gateway for the tenant VNID is the external router.

Figure 11: Bridged External Router

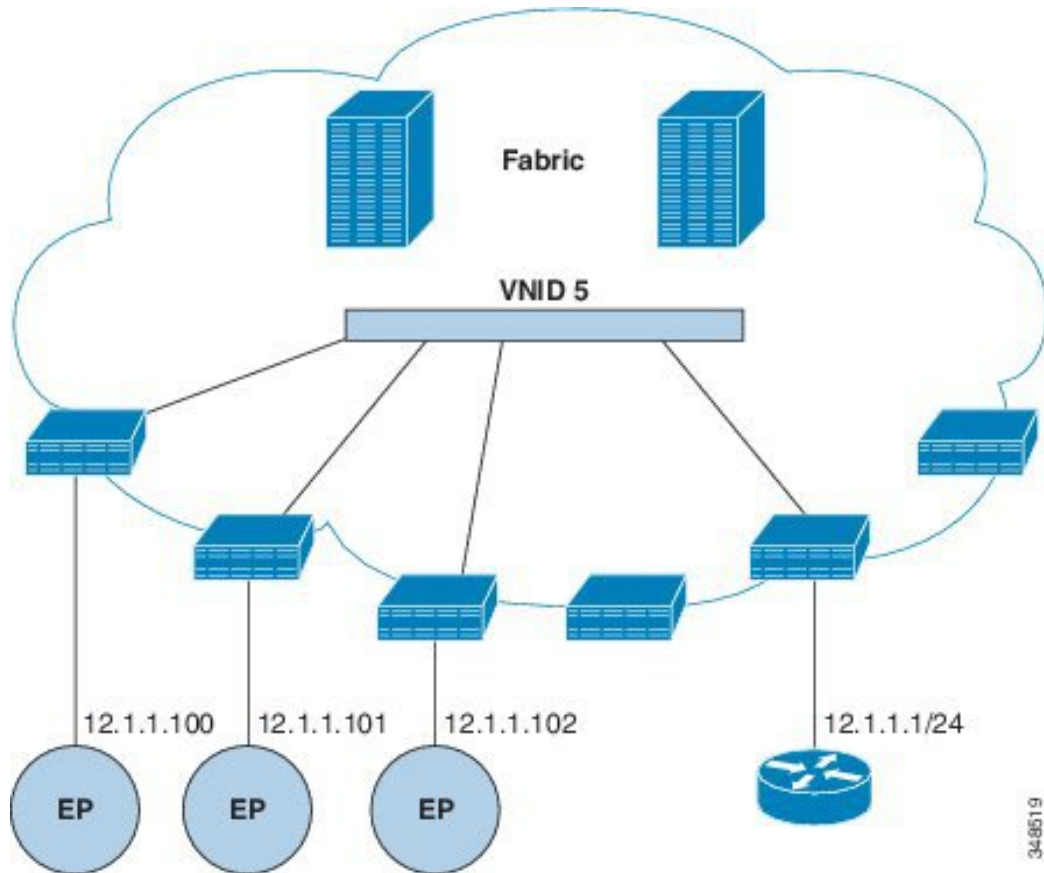

The ACI fabric is unaware of the presence of the external router and the APIC statically assigns the leaf switch interface to its EPG.

Layer 3 Out for Routed Connectivity to External Networks

Routed connectivity to external networks is enabled by associating a fabric access (`infraInfra`) external routed domain (`l3extDomP`) with a tenant Layer 3 external instance profile (`l3extInstP` or external EPG) of a Layer 3 external outside network (`l3extOut`), in the hierarchy in the following diagram:

Figure 12: Policy Model for Layer 3 External Connections

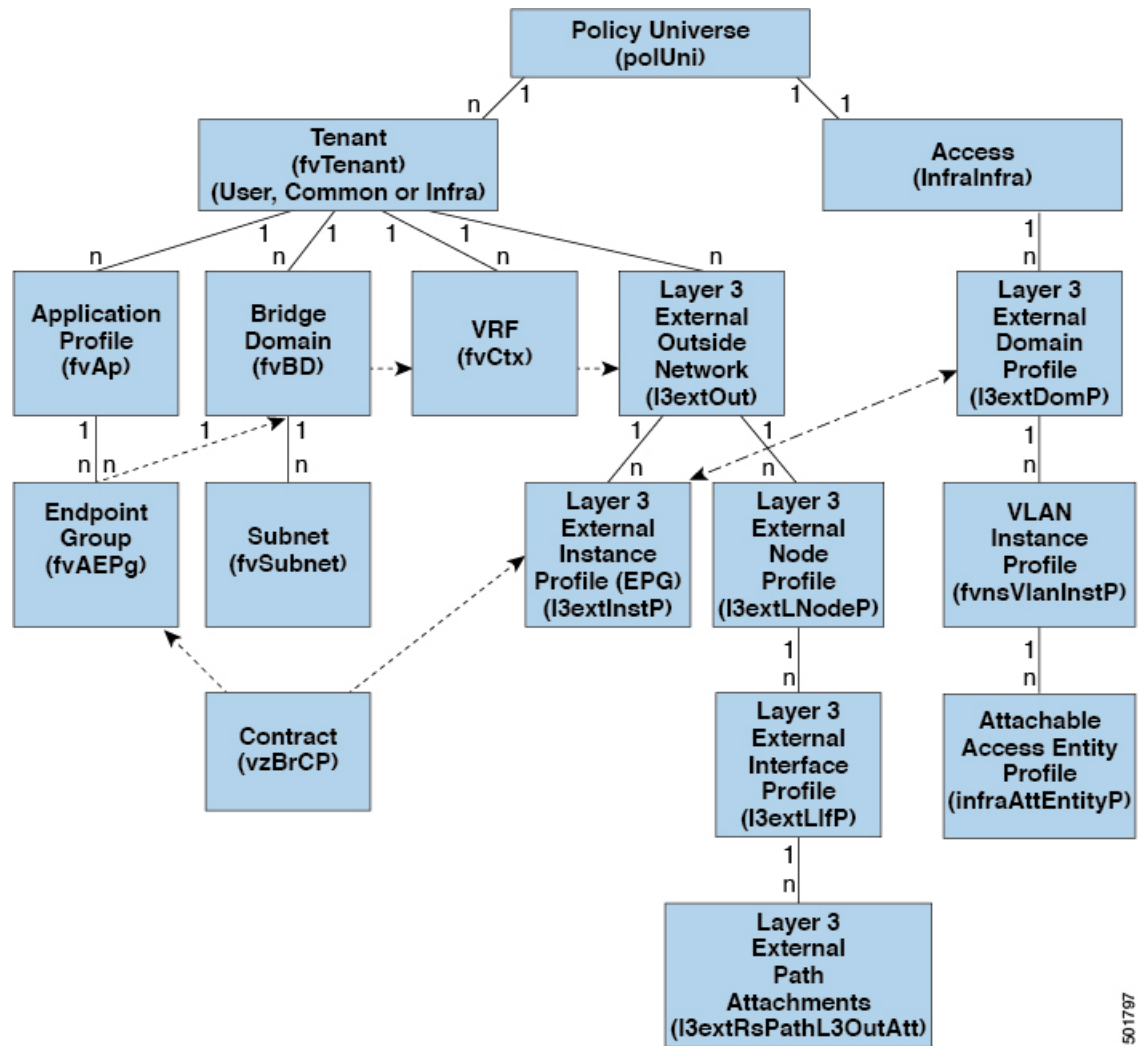

A Layer 3 external outside network (`l3extOut` object) includes the routing protocol options (BGP, OSPF, or EIGRP or supported combinations) and the switch-specific and interface-specific configurations. While the `l3extOut` contains the routing protocol (for example, OSPF with its related Virtual Routing and Forwarding (VRF) and area ID), the Layer 3 external interface profile contains the necessary OSPF interface details. Both are needed to enable OSPF.

The `l3extInstP` EPG exposes the external network to tenant EPGs through a contract. For example, a tenant EPG that contains a group of web servers could communicate through a contract with the `l3extInstP` EPG according to the network configuration contained in the `l3extOut`. The outside network configuration can easily be reused for multiple nodes by associating the nodes with the L3 external node profile. Multiple nodes that use the same profile can be configured for fail-over or load balancing. Also, a node can be added to multiple `l3extOuts` resulting in VRFs that are associated with the `l3extOuts` also being deployed on that node. For scalability information, refer to the current *Verified Scalability Guide for Cisco ACI*.

Advertise Host Routes

Enabling Advertise Host Routes on the BD, individual host-routes (/32 and /128 prefixes) are advertised from the Border-Leaf switches (BL). The BD must be associated to the L3out or an explicit prefix list matching the host routes. The host routes must be configured to advertise host routes out of the fabric.

Border-Leaf switches along with the subnet advertise the individual end-point(EP) prefixes. The route information is advertised only if the host is connected to the local POD. If the EP is moved away from the local POD or once the EP is removed from EP database (even if the EP is attached to a remote leaf), the route advertisement is then withdrawn.

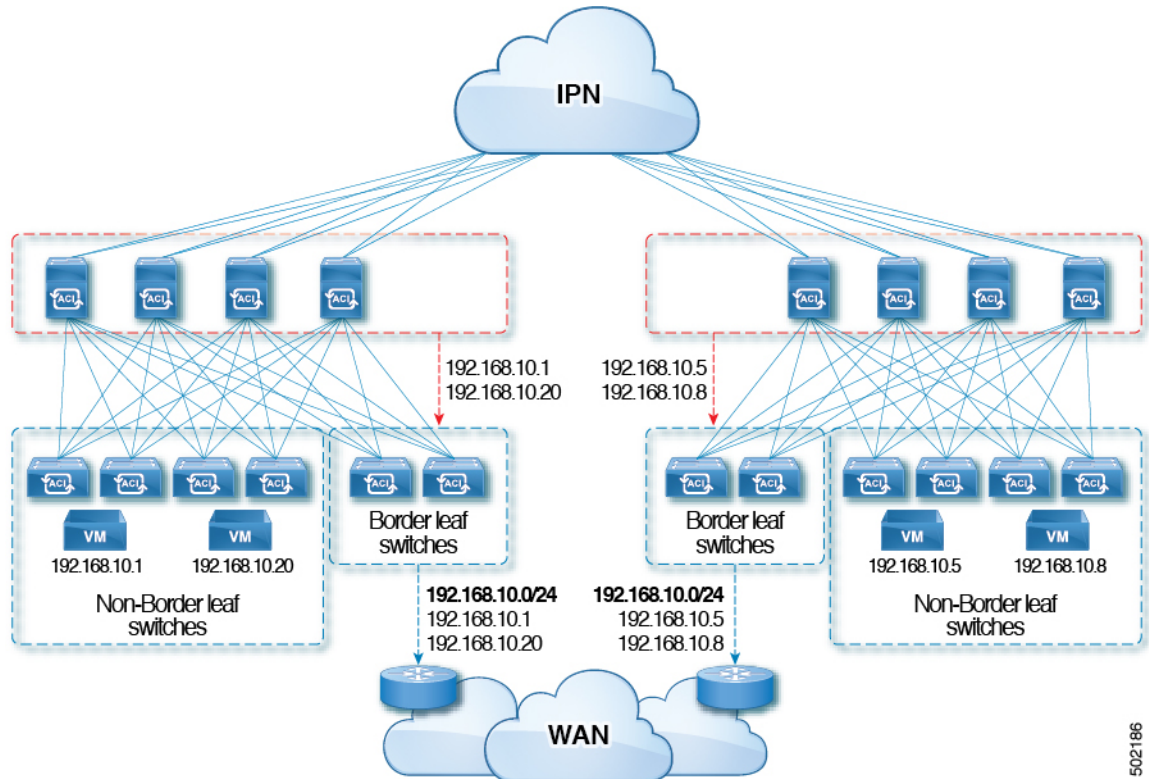

502186

Advertise Host Route configuration guidelines and limitations are:

- When host routes are advertised, the VRF Transit Route Tag is set in order to prevent them from being advertised back into the fabric and installed. In order for this loop protection to work properly, external routers must preserve this route-tag if advertising to another L3Out.
- If a bridge domain is tied to an EPG that has the same subnet configured for internal leaking, you must also enable the "Advertised Externally" flag on the EPG subnet.
- The Advertise Host Routes feature is supported on Generation 2 switches or later (Cisco Nexus N9K switches with "EX", "FX", or "FX2" on the end of the switch model name or later; for example, N9K-93108TC-EX).
- Host route advertisement supports both BD to L3out Association and the explicit route map configurations. We recommend using explicit route map configuration which allows you greater control in selecting individual or a range of host routes to configure.
- EPs/Host routes in SITE-1 will not be advertised out through Border Leafs in other SITES.

- When EPs is aged out or removed from the database, Host routes are withdrawn from the Border Leaf.
- When EP is moved across SITES or PODs, Host routes should be withdrawn from first SITE/POD and advertised in new POD/SITE.
- EPs learned on a specific BD, under any of the BD subnets are advertised from the L3out on the border leaf in the same POD.
- EPs are advertised out as Host Routes only in the local POD through the Border Leaf.
- Host routes are not advertised out from one POD to another POD.
- In the case of Remote Leaf, if EPs are locally learned in the Remote Leaf, they are then advertised only through a L3out deployed in Remote Leaf switches in same POD.
- EPs/Host routes in a Remote Leaf are not advertised out through Border Leaf switches in main POD or another POD.
- EPs/Host routes in the main POD are not advertised through L3out in Remote Leaf switches of same POD or another POD.
- The BD subnet must have the **Advertise Externally** option enabled.
- The BD must be associated to an L3out or the L3out must have explicit route-map configured matching BD subnets.
- There must be a contract between the EPG in the specified BD and the External EPG for the L3out.



Note If there is no contract between the BD/EPG and the External EPG the BD subnet and host routes will not be installed on the border leaf.

- Advertise Host Route is supported for shared services. For example: epg1/BD1 deployed is in VRF-1 and L3out in another VRF-2. By providing shared contract between EPG and L3out host routes are pulled from one VRF-1 to another VRF-2.
- When Advertise Host Route is enabled on BD custom tag cannot be set on BD Subnet using route-map.
- When Advertise Host Route is enabled on a BD and the BD is associated with an L3Out, BD subnet is marked public. If there's a rogue EP present under the BD, that EP is advertised out on L3Out.

Static Route Preference

Static route preference within the ACI fabric is carried in MP-BGP using cost extended community.

The following figure illustrates how the ACI fabric keeps static route preferences intact across leaf switches so that route selection happens based on this preference.

Figure 13: Static Route Preference

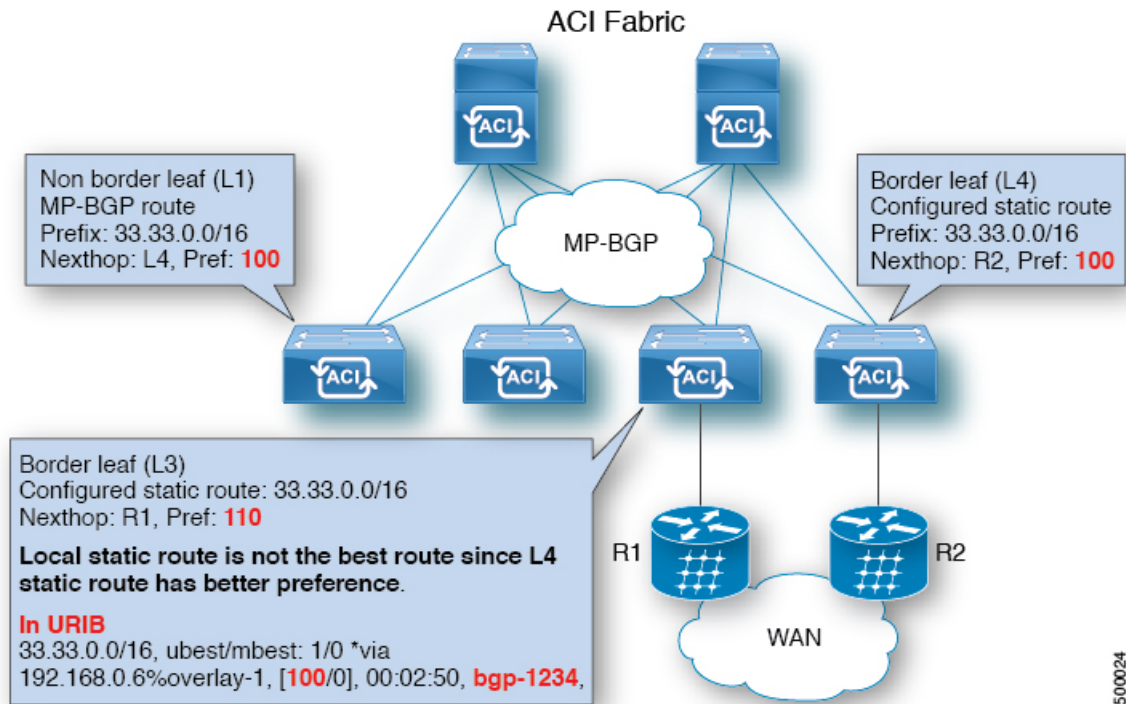

This figure shows a MP-BGP route coming to leaf switch 3 (L3) from leaf switch 4 (L4) that wins over a local static route. A static route is installed in the Unicast Routing Information Base (URIB) with the preference configured by an administrator. On an ACI non-border leaf switch, a static route is installed with leaf switch 4 (L4) as its next hop. When next hop on L4 is not available, the L3 static route becomes the best route in fabric.



Note If a static route in a leaf switch is defined with `next hop Null 0`, MP-BGP does not advertise that route to other leaf switches in fabric.

Route Import and Export, Route Summarization, and Route Community Match

Subnet route export or import configuration options can be specified according to the scope and aggregation options described below.

For routed subnets, the following scope options are available:

- Export Route Control Subnet: Controls the export route direction.
- Import Route Control Subnet: Controls the import route direction.



Note Import route control is supported for BGP and OSPF, but not EIGRP.

- **External Subnets for the External EPG (Security Import Subnet):** Specifies which external subnets have contracts applied as part of a specific external L3Out EPG (`l3extInstP`). For a subnet under the `l3extInstP` to be classified as an external EPG, the scope on the subnet should be set to "import-security". Subnets of this scope determine which IP addresses are associated with the `l3extInstP`. Once this is determined, contracts determine with which other EPGs that external subnet is allowed to communicate. For example, when traffic enters the ACI switch on the Layer 3 external outside network (`L3extOut`), a lookup occurs to determine which source IP addresses are associated with the `l3extInstP`. This action is performed based on Longest Prefix Match (LPM) so that more specific subnets take precedence over more general subnets.
- **Shared Route Control Subnet:** In a shared service configuration, only subnets that have this property enabled will be imported into the consumer EPG Virtual Routing and Forwarding (VRF). It controls the route direction for shared services between VRFs.
- **Shared Security Import Subnet:** Applies shared contracts to imported subnets. The default specification is External Subnets for the external EPG.

Routed subnets can be aggregated. When aggregation is not set, the subnets are matched exactly. For example, if 11.1.0.0/16 is the subnet, then the policy will not apply to a 11.1.1.0/24 route, but it will apply only if the route is 11.1.0.0/16. However, to avoid a tedious and error prone task of defining all the subnets one by one, a set of subnets can be aggregated into one export, import or shared routes policy. At this time, only 0/0 subnets can be aggregated. When 0/0 is specified with aggregation, all the routes are imported, exported, or shared with a different VRF, based on the selection option below:

- **Aggregate Export:** Exports all transit routes of a VRF (0/0 subnets).
- **Aggregate Import:** Imports all incoming routes of given L3 peers (0/0 subnets).



Note Aggregate import route control is supported for BGP and OSPF, but not for EIGRP.

- **Aggregate Shared Routes:** If a route is learned in one VRF but needs to be advertised to another VRF, the routes can be shared by matching the subnet exactly, or can be shared in an aggregate way according to a subnet mask. For aggregate shared routes, multiple subnet masks can be used to determine which specific route groups are shared between VRFs. For example, 10.1.0.0/16 and 12.1.0.0/16 can be specified to aggregate these subnets. Or, 0/0 can be used to share all subnet routes across multiple VRFs.



Note Routes shared between VRFs function correctly on Generation 2 switches (Cisco Nexus N9K switches with "EX" or "FX" on the end of the switch model name, or later; for example, N9K-93108TC-EX). On Generation 1 switches, however, there may be dropped packets with this configuration, because the physical ternary content-addressable memory (TCAM) tables that store routes do not have enough capacity to fully support route parsing.

Route summarization simplifies route tables by replacing many specific addresses with a single address. For example, 10.1.1.0/24, 10.1.2.0/24, and 10.1.3.0/24 are replaced with 10.1.0.0/16. Route summarization policies enable routes to be shared efficiently among border leaf switches and their neighbor leaf switches. BGP, OSPF, or EIGRP route summarization policies are applied to a bridge domain or transit subnet. For OSPF, inter-area and external route summarization are supported. Summary routes are exported; they are not advertised

within the fabric. In the example above, when a route summarization policy is applied, and an EPG uses the 10.1.0.0/16 subnet, the entire range of 10.1.0.0/16 is shared with all the neighboring leaf switches.



Note When two `L3extOut` policies are configured with OSPF on the same leaf switch, one regular and another for the backbone, a route summarization policy configured on one `L3extOut` is applied to both `L3extOut` policies because summarization applies to all areas in the VRF.

As illustrated in the figure below, route control profiles derive route maps according to prefix-based and community-based matching.

Figure 14: Route Community Matching

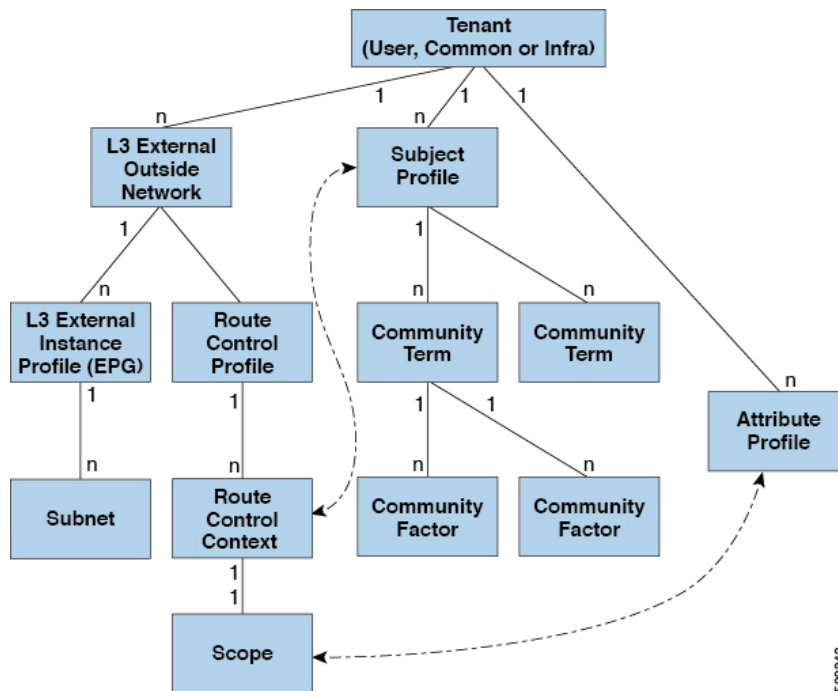

The route control profile (`rtctrlProfile`) specifies what is allowed. The Route Control Context specifies what to match, and the scope specifies what to set. The subject profile contains the community match specifications, which can be used by multiple `L3extOut` instances. The subject profile (`SubjP`) can contain multiple community terms each of which contains one or more community factors (communities). This arrangement enables specifying the following boolean operations:

- Logical `or` among multiple community terms
- Logical `and` among multiple community factors

For example, a community term called `northeast` could have multiple communities that each include many routes. Another community term called `southeast` could also include many different routes. The administrator could choose to match one, or the other, or both. A community factor type can be regular or extended. Care should be taken when using extended type community factors, to ensure there are no overlaps among the specifications.

The scope portion of the route control profile references the attribute profile (`rtctrlAttrP`) to specify what set-action to apply, such as preference, next hop, community, and so forth. When routes are learned from an `L3extOut`, route attributes can be modified.

The figure above illustrates the case where an `L3extOut` contains a `rtctrlProfile`. A `rtctrlProfile` can also exist under the tenant. In this case, the `L3extOut` has an interleave relation policy (`L3extRsInterleakPol`) that associates it with the `rtctrlProfile` under the tenant. This configuration enables reusing the `rtctrlProfile` for multiple `L3extOut` connections. It also enables keeping track of the routes the fabric learns from OSPF to which it gives BGP attributes (BGP is used within the fabric). A `rtctrlProfile` defined under an `L3extOut` has a higher priority than one defined under the tenant.

The `rtctrlProfile` has two modes: combinable, and global. The default combinable mode combines pervasive subnets (`fvSubnet`) and external subnets (`L3extSubnet`) with the match/set mechanism to render the route map. The global mode applies to all subnets within the tenant, and overrides other policy attribute settings. A global `rtctrlProfile` provides permit-all behavior without defining explicit (0/0) subnets. A global `rtctrlProfile` is used with non-prefix based match rules where matching is done using different subnet attributes such as community, next hop, and so on. Multiple `rtctrlProfile` policies can be configured under a tenant.

`rtctrlProfile` policies enable enhanced default import and default export route control. Layer 3 Outside networks with aggregated import or export routes can have import/export policies that specify supported default-export and default-import, and supported 0/0 aggregation policies. To apply a `rtctrlProfile` policy on all routes (inbound or outbound), define a global default `rtctrlProfile` that has no match rules.



Note While multiple `L3extOut` connections can be configured on one switch, all Layer 3 outside networks configured on a switch must use the same `rtctrlProfile` because a switch can have only one route map.

The protocol interleave and redistribute policy controls externally learned route sharing with ACI fabric BGP routes. Set attributes are supported. Such policies are supported per `L3extOut`, per node, or per VRF. An interleave policy applies to routes learned by the routing protocol in the `L3extOut`. Currently, interleave and redistribute policies are supported for OSPF v2 and v3. A route control policy `rtctrlProfile` has to be defined as `global` when it is consumed by an interleave policy.

Shared Services Contracts Usage

Shared services enable communications across tenants while preserving the isolation and security policies of the tenants. A routed connection to an external network is an example of a shared service that multiple tenants use.

Follow these guidelines when configuring shared services contracts.

- For shared services that export subnets to different Virtual Routing and Forwarding (VRF) instances (also known as contexts or private networks), the subnet must be configured under an EPG, and the scope must be set to **Advertised Externally** and **Shared Between VRFs**.
- Contracts are not needed for inter-bridge domain traffic when a VRF is unenforced.
- Contracts are needed for shared service inter-VRF traffic, even when a VRF is unenforced.
- The VRF of a provider EPG cannot be in unenforced mode while providing a shared service.
- A shared service is supported only with non-overlapping and non-duplicate subnets. When configuring subnets for shared services, follow these guidelines:

- Configure the subnet for a shared service provider under the EPG, not under the bridge domain.
- Subnets configured under an EPG that share the same VRF must be disjointed and must not overlap.
- Subnets leaked from one VRF to another must be disjointed and must not overlap.
- Subnets leaked from multiple consumer networks into a VRF or vice versa must be disjointed and must not overlap.



Note If two consumers are mistakenly configured with the same subnet, recover from this condition by removing the subnet configuration for both then reconfigure the subnets correctly.

- Do not configure a shared service with `AnyToProv` in the provider VRF. The APIC rejects this configuration and raises a fault.
- When a contract is configured between in-band and out-of-band EPGs, the following restrictions apply:
 - Both EPGs should be in the same VRF.
 - Filters apply only in the incoming direction.
 - Layer 2 filters are not supported.
 - QoS does not apply to in-band Layer 4 to Layer 7 services.
 - Management statistics are not available.
 - Shared services for CPU-bound traffic are not supported.

Shared Layer 3 Out

A shared Layer 3 outside network (`L3extOut`) configuration provides routed connectivity to external networks as a shared service. An `L3extOut` profile (`L3extInstP`) EPG provides routed connectivity to external networks. It can be provisioned as a shared service in any tenant (`user`, `common`, `infra`, or `mgmt`). Prior to release 1.2(1x), this configuration was only supported in the `user` and `common` tenants. An EPG in any tenant can use a shared services contract to connect with an `L3extInstP` EPG regardless of where in the fabric that `L3extInstP` EPG is provisioned. This simplifies the provisioning of routed connectivity to external networks; multiple tenants can share a single `L3extInstP` EPG for routed connectivity to external networks. Sharing an `L3extInstP` EPG is more efficient because it consumes only one session on the switch regardless of how many EPGs use the single shared `L3extInstP` EPG.



Note All switches that will use `L3extInstP` EPG shared service contracts require the hardware and software support available starting with the APIC 1.2(1x) and switch 11.2(1x) releases. Refer to the *Cisco APIC Management, Installation, Upgrade, and Downgrade Guide* and Release Notes documentation for more details.

The figure below illustrates the major policy model objects that are configured for a shared `L3extInstP` EPG.

Figure 15: Shared Layer 3 Out Policy Model

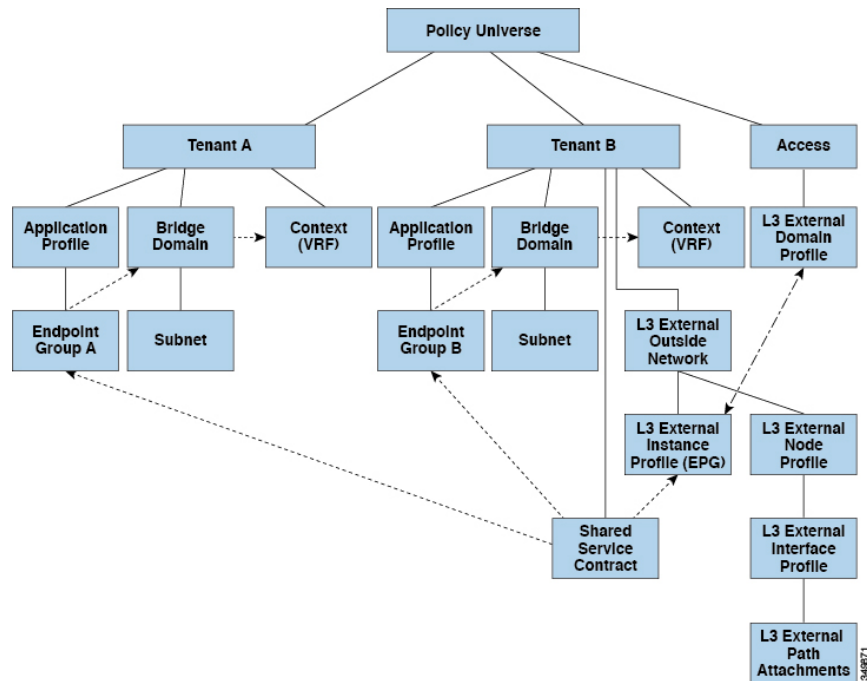

Take note of the following guidelines and limitations for shared Layer 3 outside network configurations:

- No tenant limitations: Tenants A and B can be any kind of tenant (*user*, *common*, *infra*, *mgmt.*). The shared `l3extInstP` EPG does not have to be in the `common` tenant.
- Flexible placement of EPGs: EPG A and EPG B in the illustration above are in different tenants. EPG A and EPG B could use the same bridge domain and VRF, but they are not required to do so. EPG A and EPG B are in different bridge domains and different VRFs but still share the same `l3extInstP` EPG.
- A subnet can be *private*, *public*, or *shared*. A subnet that is to be advertised into a consumer or provider EPG of an `L3extOut` must be set to *shared*. A subnet that is to be exported to an `L3extOut` must be set to *public*.
- The shared service contract is exported from the tenant that contains the `l3extInstP` EPG that provides shared Layer 3 outside network service. The shared service contract is imported into the tenants that contain the EPGs that consume the shared service.
- Do not use taboo contracts with a shared L3 out; this configuration is not supported.
- The `l3extInstP` as a shared service provider is supported, but only with non `l3extInstP` consumers (where the `L3extOut` EPG is the same as the `l3extInstP`).
- Traffic Disruption (Flap): When an `l3instP` EPG is configured with an external subnet of `0.0.0.0/0` with the scope property of the `l3instP` subnet set to shared route control (*shared-rctrl*), or shared security (*shared-security*), the VRF is redeployed with a global `pcTag`. This will disrupt all the external traffic in that VRF (because the VRF is redeployed with a global `pcTag`).
- Prefixes for a shared `L3extOut` must be unique. Multiple shared `L3extOut` configurations with the same prefix in the same VRF will not work. Be sure that the external subnets (external prefixes) that are advertised into a VRF are unique (the same external subnet cannot belong to multiple `l3instPs`). An `L3extOut` configuration (for example, named `L3Out1`) with `prefix1` and a second Layer 3 outside

configuration (for example, named L3Out2) also with prefix1 belonging to the same VRF will not work (because only 1 pcTag is deployed). Different behaviors of L3extOut are possible when configured on the same leaf switch under the same VRF. The two possible scenarios are as follows:

- Scenario 1 has an L3extOut with an SVI interface and two subnets (10.10.10.0/24 and 0.0.0.0/0) defined. If ingress traffic on the Layer 3 outside network has the matching prefix 10.10.10.0/24, then the ingress traffic uses the External EPG pcTag. If ingress traffic on the Layer 3 Outside network has the matching default prefix 0.0.0.0/0, then the ingress traffic uses the External Bridge pcTag.
- Scenario 2 has an L3extOut using a routed or routed-sub-interface with two subnets (10.10.10.0/24 and 0.0.0.0/0) defined. If ingress traffic on the Layer 3 outside network has the matching prefix 10.10.10.0/24, then the ingress traffic uses the External EPG pcTag. If ingress traffic on the Layer 3 outside network has the matching default prefix 0.0.0.0/0, then the ingress traffic uses the VRF pcTag.
- As a result of these described behaviors, the following use cases are possible if the same VRF and same leaf switch are configured with L3extOut-A and L3extOut-B using an SVI interface:

Case 1 is for L3extOut-A: This External Network EPG has two subnets defined: 10.10.10.0/24 & 0.0.0.0/1. If ingress traffic on L3extOut-A has the matching prefix 10.10.10.0/24, it uses the external EPG pcTag & contract-A which is associated with L3extOut-A. When egress traffic on L3extOut-A has no specific match found, but there is a maximum prefix match with 0.0.0.0/1, it uses the External Bridge Domain (BD) pcTag & contract-A.

Case 2 is for L3extOut-B: This External Network EPG has one subnet defined: 0.0.0.0/0. When ingress traffic on L3extOut-B has the matching prefix 10.10.10.0/24 (which is defined under L3extOut-A), it uses the External EPG pcTag of L3extOut-A and the contract-A which is tied with L3extOut-A. It does not use contract-B which is tied with L3extOut-B.

- Traffic not permitted: Traffic is not permitted when an invalid configuration sets the scope of the external subnet to shared route control (shared-rtctrl) as a subset of a subnet that is set to shared security (shared-security). For example, the following configuration is invalid:

- *shared rtctrl*: 10.1.1.0/24, 10.1.2.0/24
- *shared security*: 10.1.0.0/16

In this case, ingress traffic on a non-border leaf with a destination IP of 10.1.1.1 is dropped, since prefixes 10.1.1.0/24 and 10.1.2.0/24 are installed with a drop rule. Traffic is not permitted. Such traffic can be enabled by revising the configuration to use the *shared-rtctrl* prefixes as *shared-security* prefixes as well.

- Inadvertent traffic flow: Prevent inadvertent traffic flow by avoiding the following configuration scenarios:

- **Case 1** configuration details:

- A Layer 3 outside network configuration (for example, named L3extOut-1) with VRF1 is called provider1.
- A second Layer 3 outside network configuration (for example, named L3extOut-2) with VRF2 is called provider2.
- L3extOut-1 VRF1 advertises a default route to the Internet, 0.0.0.0/0 which enables both *shared-rtctrl* and *shared-security*.
- L3extOut-2 VRF2 advertises specific subnets to DNS and NTP, 192.0.0.0/8 which enables *shared-rtctrl*.

- L3extOut-2 VRF2 has specific subnet 192.1.0.0/16, which enables *shared-security*.
- **Variation A:** EPG Traffic Goes to Multiple VRFs.
 - Communications between EPG1 and L3extOut-1 is regulated by an *allow_all* contract.
 - Communications between EPG1 and L3extOut-2 is regulated by an *allow_all* contract.
 - Result:** Traffic from EPG1 to L3extOut-2 also goes to 192.2.x.x.
- **Variation B:** An EPG conforms to the *allow_all* contract of a second shared Layer 3 outside network.
 - Communications between EPG1 and L3extOut-1 is regulated by an *allow_all* contract.
 - Communications between EPG1 and L3extOut-2 is regulated by an *allow_icmp* contract.
 - Result:** Traffic from EPG1 to L3extOut-2 to 192.2.x.x conforms to the *allow_all* contract.
- **Case 2** configuration details:
 - A L3extOut profile (l3instP) has one shared prefix and other non-shared prefixes.
 - Traffic coming in with `src = non-shared` is allowed to go to the EPG
 - **Variation A:** Unintended traffic goes through an EPG.
 - L3extOut (l3instP) EPG traffic goes through a L3extOut that has these prefixes:
 - 192.0.0.0/8 = `import-security, shared-rtctrl`
 - 192.1.0.0/16 = `shared-security`
 - The EPG has 1.1.0.0/16 = `shared`
 - Result:** Traffic going from 192.2.x.x also goes through to the EPG.
 - **Variation B:** Unintended traffic goes through an EPG. Traffic coming in a shared L3extOut can go through the EPG.
 - The shared L3extOut VRF has an EPG with `pcTag = prov vrf` and a contract set to *allow_all*
 - The EPG <subnet> = `shared`.
 - Result:** The traffic coming in on the Layer 3 out can go through the EPG.

Bidirectional Forwarding Detection

Use Bidirectional Forwarding Detection (BFD) to provide sub-second failure detection times in the forwarding path between ACI fabric border leaf switches configured to support peering router connections.

BFD is particularly useful in the following scenarios:

- When the peering routers are connected through a Layer 2 device or a Layer 2 cloud where the routers are not directly connected to each other. Failures in the forwarding path may not be visible to the peer routers. The only mechanism available to control protocols is the hello timeout, which can take tens of seconds or even minutes to time out. BFD provides sub-second failure detection times.

- When the peering routers are connected through a physical media that does not support reliable failure detection, such as shared Ethernet. In this case too, routing protocols have only their large hello timers to fall back on.
- When many protocols are running between a pair of routers, each protocol has its own hello mechanism for detecting link failures, with its own timeouts. BFD provides a uniform timeout for all the protocols, which makes convergence time consistent and predictable.

Observe the following BFD guidelines and limitations:

- Beginning with APIC Release 3.1(1), BFD between leaf and spine switches is supported on fabric-interfaces for IS-IS. In addition, BFD feature on spine switch is supported for OSPF and static routes.
- BFD is supported on modular spine switches that have -EX and -FX line cards (or newer versions), and BFD is also supported on the Nexus 9364C non-modular spine switch (or newer versions).
- BFD between VPC peers is not supported.
- Beginning with APIC Release 5.0(1), BFD multihop is supported on leaf switches. The maximum number of BFD sessions is unchanged, as BFD multihop sessions are now included in the total.
- Beginning with APIC Release 5.0(1), ACI supports C-bit-aware BFD. The C-bit on incoming BFD packets determines whether BFD is dependent or independent of the control plane.
- BFD over iBGP is not supported for loopback address peers.
- BFD sub interface optimization can be enabled in an interface policy. One sub-interface having this flag will enable optimization for all the sub-interfaces on that physical interface.
- BFD for BGP prefix peer not supported.



Note Cisco ACI does not support IP fragmentation. Therefore, when you configure Layer 3 Outside (L3Out) connections to external routers, or multipod connections through an Inter-Pod Network (IPN), it is critical that the interface MTU is set appropriately on both ends of a link. On some platforms, such as Cisco ACI, Cisco NX-OS, and Cisco IOS, the configurable MTU value does not take into account the ethernet headers (matching IP MTU, and excluding the 14-18 ethernet header size), while other platforms, such as IOS-XR, include the ethernet header in the configured MTU value. A configured value of 9000 results in a max IP packet size of 9000 bytes in Cisco ACI, Cisco NX-OS, and Cisco IOS, but results in a max IP packet size of 8986 bytes for an IOS-XR untagged interface.

For the appropriate MTU values for each platform, see the relevant configuration guides.

We highly recommend that you test the MTU using CLI-based commands. For example, on the Cisco NX-OS CLI, use a command such as `ping 1.1.1.1 df-bit packet-size 9000 source-interface ethernet 1/1`.

ACI IP SLAs

Many companies conduct most of their business online and any loss of service can affect their profitability. Internet service providers (ISPs) and even internal IT departments now offer a defined level of service, a service level agreement (SLA), to provide their customers with a degree of predictability.

IP SLA tracking is a common requirement in networks. IP SLA tracking allows a network administrator to collect information about network performance in real time. With the Cisco ACI IP SLA, you can track an IP address using ICMP and TCP probes. Tracking configurations can influence route tables, allowing for routes to be removed when tracking results come in negative and returning the route to the table when the results become positive again.

ACI IP SLAs are available for the following:

- Static routes:
 - New in ACI 4.1
 - Automatically remove or add a static route from/to a route table
 - Track the route using ICMP and TCP probes
- Policy-based redirect (PBR) tracking:
 - Available since ACI 3.1
 - Automatically remove or add a next -hop
 - Track the next-hop IP address using ICMP and TCP probes, or a combination using L2Ping
 - Redirect traffic to the PBR node based on the reachability of the next-hop

For more information about PBR tracking, see *Configuring Policy-Based Redirect* in the *Cisco APIC Layer 4 to Layer 7 Services Deployment Guide*.



Note For either feature, you can perform a network action based on the results of the probes, including configuration, using APIs, or running scripts.

ACI IP SLA Supported Topologies

The following ACI fabric topologies support IP SLA:

- **Single Fabric:** IP SLA tracking is supported for IP address reachable through both L3out and EPG/BD
- **Multi-Pod**
 - You can define a single object tracking policy across different Pods.
 - A workload can move from one Pod to another. The IP SLA policy continues to check accessibility information and detects if an endpoint has moved.
 - If an endpoint moves to another Pod, IP SLA tracking is moved to the other Pod as well, so that tracking information is not passed through the IP network.
- **Remote Leaf**
 - You can define single object tracking policies across ACI main data center and the remote leaf switch.
 - IP SLA probes on remote leaf switches track IP addresses locally without using the IP network.

- A workload can move from one local leaf to a remote leaf. The IP SLA policy continues to check accessibility information and detects if an endpoint has moved.
- IP SLA policies move to the remote leaf switches or ACI main data center, based on the endpoint location, for local tracking, so that tracking traffic is not passed through the IP network.

Tenant Routed Multicast

Cisco Application Centric Infrastructure (ACI) Tenant Routed Multicast (TRM) enables Layer 3 multicast routing in Cisco ACI tenant VRF instances. TRM supports multicast forwarding between senders and receivers within the same or different subnets. Multicast sources and receivers can be connected to the same or different leaf switches or external to the fabric using L3Out connections.

In the Cisco ACI fabric, most unicast and IPv4/IPv6 multicast routing operate together on the same border leaf switches, with the IPv4/IPv6 multicast protocol operating over the unicast routing protocols.

In this architecture, only the border leaf switches run the full Protocol Independent Multicast (PIM) or PIM6 protocol. Non-border leaf switches run PIM/PIM6 in a passive mode on the interfaces. They do not peer with any other PIM/PIM6 routers. The border leaf switches peer with other PIM/PIM6 routers connected to them over L3Outs and also with each other.

The following figure shows border leaf switch 1 and border leaf switch 2 connecting to router 1 and router 2 in the IPv4/IPv6 multicast cloud. Each virtual routing and forwarding (VRF) instance in the fabric that requires IPv4/IPv6 multicast routing will peer separately with external IPv4/IPv6 multicast routers.

Figure 16: Overview of Multicast Cloud

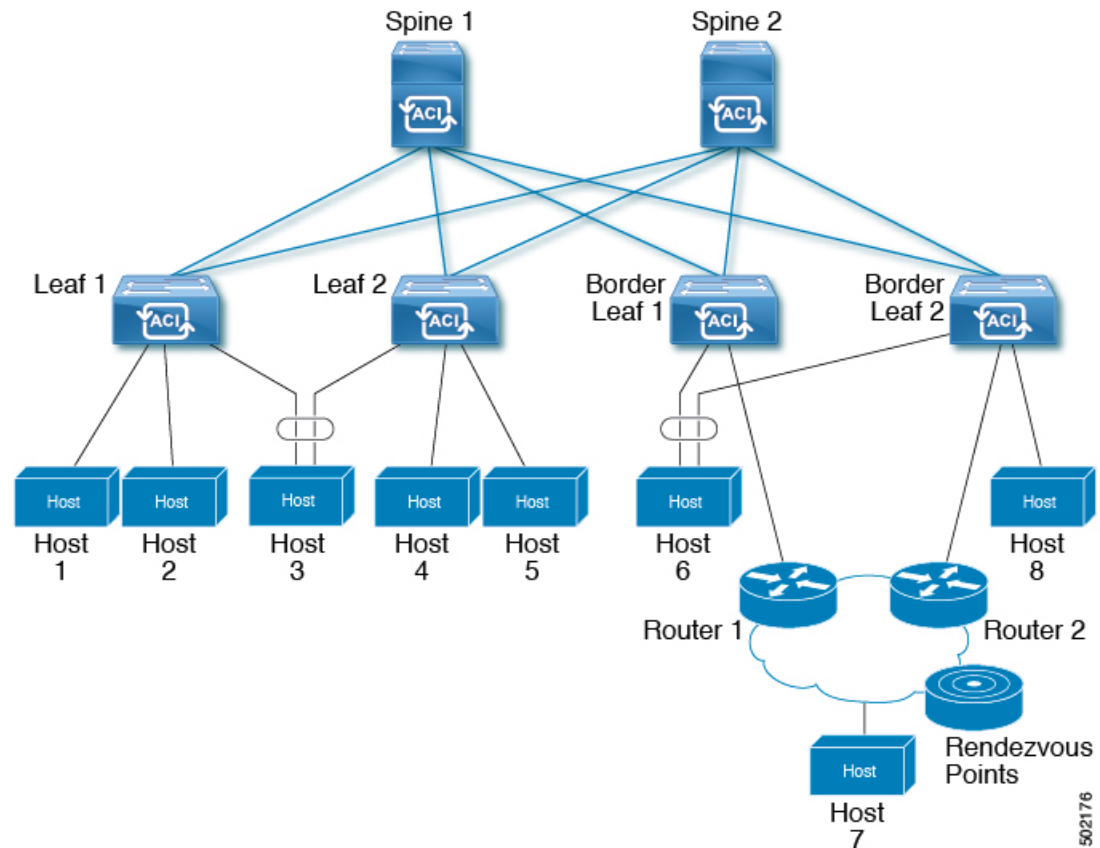

About the Fabric Interface

The fabric interface is a virtual interface between software modules and represents the fabric for IPv4/IP6 multicast routing. The interface takes the form of a tunnel interface with the tunnel destination being the VRF GIPo (Group IP outer address)¹. PIM6 shares the same tunnel that PIM4 uses. For example, if a border leaf is the designated forwarder responsible for forwarding traffic for a group, then the fabric interface would be in the outgoing interface (OIF) list for the group. There is no equivalent for the interface in hardware. The operational state of the fabric interface should follow the state published by the intermediate system-to-intermediate system (IS-IS).



Note Each multicast-enabled VRF requires one or more border leaf switches configured with a loopback interface. You must configure a unique IPv4 loopback address on all nodes in a PIM-enabled L3Out. The Router-ID loopback or another unique loopback address can be used.

Any loopback configured for unicast routing can be reused. This loopback address must be routed from the external network and will be injected into the fabric MP-BGP (Multiprotocol Border Gateway Protocol) routes

¹ The GIPo (Group IP outer address) is the destination multicast IP address used in the outer IP header of the VXLAN packet for all multi-destination packets (Broadcast, Unknown unicast, and Multicast) packets forwarded within the fabric.

for the VRF. The fabric interface source IP will be set to this loopback as the loopback interface. The following figure shows the fabric for IPv4/IPv6 multicast routing.

Figure 17: Fabric for IPv4/IPv6 Multicast Routing

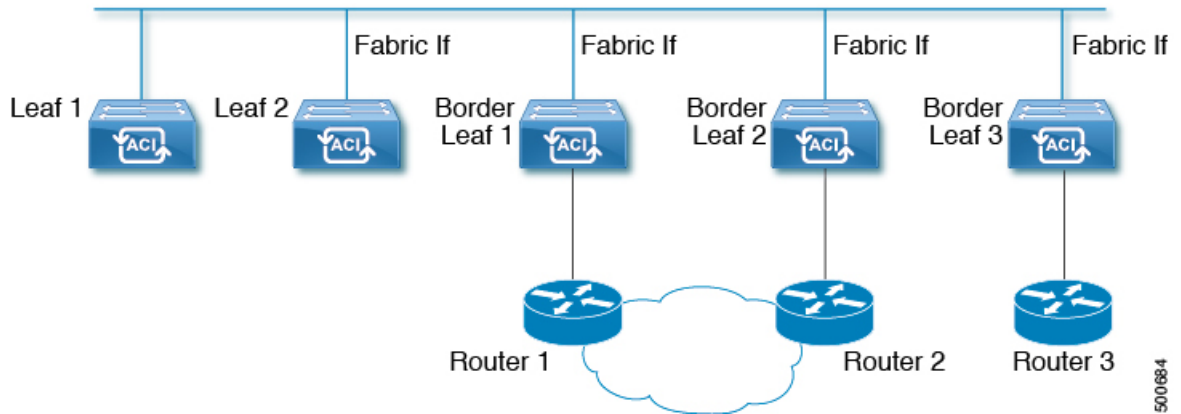

Enabling IPv4/IPv6 Tenant Routed Multicast

The process to enable or disable IPv4 or IPv6 multicast routing in a Cisco ACI fabric occurs at three levels:

- **VRF level:** Enable multicast routing at the VRF level.
- **L3Out level:** Enable PIM/PIM6 for one or more L3Outs configured in the VRF.
- **Bridge domain level:** Enable PIM/PIM6 for one or more bridge domains where multicast routing is needed.

At the top level, IPv4/IPv6 multicast routing must be enabled on the VRF that has any multicast routing-enabled bridge domains. On an IPv4/IPv6 multicast routing-enabled VRF, there can be a combination of IPv4/IPv6 multicast routing-enabled bridge domains and bridge domains where IPv4/IPv6 multicast routing is disabled. A bridge domain with IPv4/IPv6 multicast routing disabled will not show on the VRF IPv4/IPv6 multicast panel. An L3Out with IPv4/IPv6 multicast routing-enabled will show up on the panel, but any bridge domain that has IPv4/IPv6 multicast routing enabled will always be a part of a VRF that has IPv4/IPv6 multicast routing enabled.

IPv4/IPv6 multicast routing is not supported on the leaf switches such as Cisco Nexus 93128TX, 9396PX, and 9396TX. All the IPv4/IPv6 multicast routing and any IPv4/IPv6 multicast-enabled VRF should be deployed only on the switches with -EX and -FX in their product IDs.



Note Layer 3 Out ports and sub-interfaces are supported while external SVIs are not supported. Since external SVIs are not supported, PIM/PIM6 cannot be enabled in L3-VPC.

Guidelines, Limitations, and Expected Behaviors for Configuring Layer 3 IPv4/IPv6 Multicast

See the following guidelines and restrictions:

- [Guidelines and Limitations for IPv4 and IPv6 Multicast, on page 33](#)
- [Guidelines and Limitations for IPv4 Multicast, on page 34](#)
- [Guidelines and Limitations for IPv6 Multicast, on page 35](#)

Guidelines and Limitations for IPv4 and IPv6 Multicast

The following restrictions apply for both IPv4 and IPv6 multicast:

- The Layer 3 IPv4/IPv6 multicast feature is supported on second generation leaf switches. A second generation switch is one with -EX, -FX, -FX2, -FX3, -GX, or any later suffix in the product ID.
- Custom QoS policy is not supported for Layer 3 multicast traffic sourced from outside the Cisco Application Centric Infrastructure (ACI) fabric (received from L3Out).
- Enabling PIMv4/PIM6 and Advertise Host routes on a bridge domain is supported.
- Layer 3 multicast is enabled at the VRF level and the multicast protocols will function within the VRF instance. Each VRF instance can have multicast enabled or disabled independently.
- After a VRF instance is enabled for multicast, the individual bridge domains and L3Outs under the enabled VRF instance can be enabled for multicast configuration. By default, multicast is disabled in all bridge domains and L3Outs.
- Bidirectional PIMv4/PIM6 is currently not supported.
- Multicast routers are not supported in pervasive bridge domains.
- The supported route scale is 2,000. The multicast scale number is a combined scale that includes both IPv4 and IPv6. The total route limit is defined as route counts. Each IPv4 route is counted as 1, and each IPv6 route is counted as 4. Even with node profiles that support more multicast scales, the IPv6 route scale will remain at 2,000.
- PIMv4/PIM6 is supported on Layer 3 Out routed interfaces and routed subinterfaces including Layer 3 port-channel interfaces. PIMv4/PIM6 is not supported on Layer 3 Out SVI interfaces.
- Enabling PIMv4/PIM6 on an L3Out causes an implicit external network to be configured. This action results in the L3Out being deployed and protocols potentially coming up even if you have not defined an external network.
- If the multicast source is connected to Leaf-A as an orphan port and you have an L3Out on Leaf-B, and Leaf-A and Leaf-B are in a vPC pair, the EPG encapsulation VLAN tied to the multicast source will need to be deployed on Leaf-B.
- The behavior of an ingress leaf switch receiving a packet from a source that is attached to a bridge domain differs for Layer 3 IPv4 or IPv6 multicast support:
 - For Layer 3 IPv4 multicast support, when the ingress leaf switch receives a packet from a source that is attached on a bridge domain, and the bridge domain is enabled for IPv4 multicast routing, the ingress leaf switch sends only a routed VRF instance copy to the fabric (routed implies that the TTL is decremented by 1, and the source-mac is rewritten with a pervasive subnet MAC). The egress leaf switch also routes the packet into receivers in all the relevant bridge domains. Therefore, if a receiver is on the same bridge domain as the source, but on a different leaf switch than the source, that receiver continues to get a routed copy, although it is in the same bridge domain. This also applies if the source and receiver are on the same bridge domain and on the same leaf switch, if PIM is enabled on this bridge domain.

For more information, see details about Layer 3 multicast support for multipod that leverages existing Layer 2 design, at the following link [Adding Pods](#).

- For Layer 3 IPv6 multicast support, when the ingress leaf switch receives a packet from a source that is attached on a bridge domain, and the bridge domain is enabled for IPv6 multicast routing, the ingress leaf switch sends only a routed VRF instance copy to the fabric (routed implies that the TTL is decremented by 1, and the source-mac is rewritten with a pervasive subnet MAC). The egress leaf switch also routes the packet into receivers. The egress leaf also decrements the TTL in the packet by 1. This results in TTL being decremented two times. Also, for ASM the multicast group must have a valid RP configured.
- You cannot use a filter with inter-VRF multicast communication.



Note Cisco ACI does not support IP fragmentation. Therefore, when you configure Layer 3 Outside (L3Out) connections to external routers, or multipod connections through an Inter-Pod Network (IPN), it is critical that the interface MTU is set appropriately on both ends of a link. On some platforms, such as Cisco ACI, Cisco NX-OS, and Cisco IOS, the configurable MTU value does not take into account the ethernet headers (matching IP MTU, and excluding the 14-18 ethernet header size), while other platforms, such as IOS-XR, include the ethernet header in the configured MTU value. A configured value of 9000 results in a max IP packet size of 9000 bytes in Cisco ACI, Cisco NX-OS, and Cisco IOS, but results in a max IP packet size of 8986 bytes for an IOS-XR untagged interface.

For the appropriate MTU values for each platform, see the relevant configuration guides.

We highly recommend that you test the MTU using CLI-based commands. For example, on the Cisco NX-OS CLI, use a command such as `ping 1.1.1.1 df-bit packet-size 9000 source-interface ethernet 1/1`.

Guidelines and Limitations for IPv4 Multicast

The following restrictions apply specifically for IPv4 multicast:

- If the border leaf switches in your Cisco ACI fabric are running multicast and you disable multicast on the L3Out while you still have unicast reachability, you will experience traffic loss if the external peer is a Cisco Nexus 9000 switch. This impacts cases where traffic is destined towards the fabric (where the sources are outside the fabric but the receivers are inside the fabric) or transiting through the fabric (where the source and receivers are outside the fabric, but the fabric is transit).
- Any Source Multicast (ASM) and Source-Specific Multicast (SSM) are supported for IPv4.
- You can configure a maximum of four ranges for SSM multicast in the route map per VRF instance.
- IGMP snooping cannot be disabled on pervasive bridge domains with multicast routing enabled.
- Starting with Release 3.1(1x), Layer 3 multicast is supported with FEX. Multicast sources or receivers that are connected to FEX ports are supported. For further details about how to add FEX in your testbed, see Configure a Fabric Extender with Application Centric Infrastructure at this URL: <https://www.cisco.com/c/en/us/support/docs/cloud-systems-management/application-policy-infrastructure-controller-apic/200529-Configure-a-Fabric-Extender-with-Applica.html>. For releases preceeding Release 3.1(1x), Layer 3 multicast is not supported with FEX. Multicast sources or receivers that are connected to FEX ports are not supported.

Guidelines and Limitations for IPv6 Multicast

The following restrictions apply specifically for IPv6 multicast:

- Source Specific Multicast (SSM) is supported, but *RFC 3306 - Unicast-Prefix-based IPv6 Multicast Addresses* specifies a fixed SSM range. Therefore, the SSM range cannot be changed in IPv6.
- You can configure a maximum of four ranges for SSM multicast in the route map per VRF instance.
- Any Source Multicast (ASM) is supported for IPv6.
- OIF and VRF scale numbers for IPv6 are the same as they are for IPv4.
- For PIM6 only static RP configuration is supported. Auto-RP and BSR are not supported for PIM6.
- Receivers inside the fabric are not supported. MLD Snoop Policy must be disabled when enabling IPv6 multicast. MLD snooping and PIM6 cannot be enabled in the same VRF instance.
- Currently, Layer 3 Multicast Listener Discovery (MLD) is not supported with Cisco ACI.
- Fabric Rendezvous Point (RP) is not supported for IPv6 multicast.
- Cisco Multi-Site Orchestrator support is not available.

Cisco ACI GOLF

The Cisco ACI GOLF feature (also known as Layer 3 EVPN Services for Fabric WAN) enables much more efficient and scalable ACI fabric WAN connectivity. It uses the BGP EVPN protocol over OSPF for WAN routers that are connected to spine switches.

Figure 18: Cisco ACI GOLF Topology

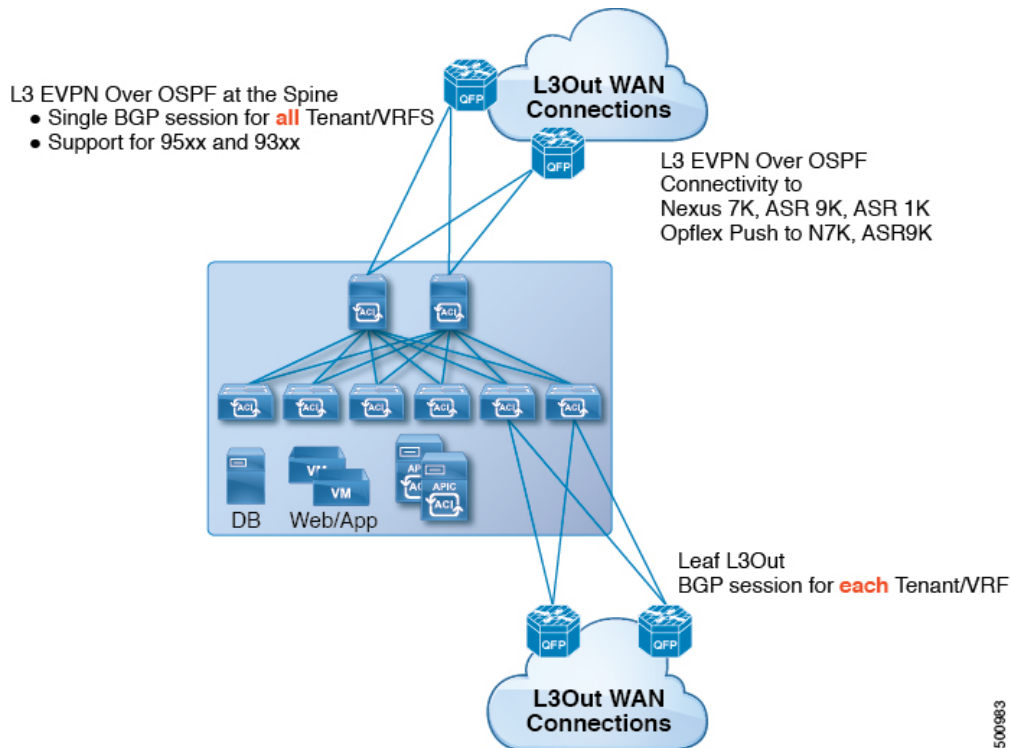

All tenant WAN connections use a single session on the spine switches where the WAN routers are connected. This aggregation of tenant BGP sessions towards the Data Center Interconnect Gateway (DCIG) improves control plane scale by reducing the number of tenant BGP sessions and the amount of configuration required for all of them. The network is extended out using Layer 3 subinterfaces configured on spine fabric ports. Transit routing with shared services using GOLF is not supported.

A Layer 3 external outside network (`L3extOut`) for GOLF physical connectivity for a spine switch is specified under the `infra` tenant, and includes the following:

- `LNodeP` (`L3extInstP` is not required within the `L3Out` in the `infra` tenant.)
- A provider label for the `L3extOut` for GOLF in the `infra` tenant.
- OSPF protocol policies
- BGP protocol policies

All regular tenants use the above-defined physical connectivity. The `L3extOut` defined in regular tenants requires the following:

- An `L3extInstP` (EPG) with subnets and contracts. The scope of the subnet is used to control import/export route control and security policies. The bridge domain subnet must be set to advertise externally and it must be in the same VRF as the application EPG and the GOLF `L3Out` EPG.
- Communication between the application EPG and the GOLF `L3Out` EPG is governed by explicit contracts (not Contract Preferred Groups).

- An `L3extConsLbl` consumer label that must be matched with the same provider label of an `L3Out` for GOLF in the `infra` tenant. Label matching enables application EPGs in other tenants to consume the `LNodeP` external `L3Out` EPG.
- The BGP EVPN session in the matching provider `L3extOut` in the `infra` tenant advertises the tenant routes defined in this `L3Out`.

Route Target filtering

Route target filtering is the practice of optimizing BGP routing tables by filtering the routes that are stored on them. This action can be accomplished by explicit route target policy or by automated algorithm.

Route Target Policy

A route target policy explicitly defines the BGP routes that can be shared between VRFs. It specifies which local routes can be exported from the local VRF to another and specifies which routes can be imported into the local VRF from external VRFs.

Within APIC, route target policies can be specified during creation or configuration of a VRF, which can in turn be associated with an L3 Out policy to define BGP route sharing associated with that policy.

Auto Route Target filtering

Auto route target filtering implements an automated algorithm for optimizing BGP routing tables for maximum overall efficiency, conserving memory by filtering out storage of all imported BGP route targets except for those associated with directly connected VPNs.

When a VRF receives a BGP VPN-IPv4 or VPN-IPv6 route target from another Policy Element (PE) router, BGP stores that route target in its local routing table only if at least one VRF imports a route target of that route. If no VRF imports any of the route targets of the route, BGP discards the route target; The intention is that BGP keeps track of route targets only for directly connected VPNs, and discards all other VPN-IPv4 or VPN-IPv6 route targets to conserve memory.

If a new VPN is connected to the router (that is, if the import route-target list of a VRF changes), BGP automatically sends a route-refresh message to obtain the routes that it previously discarded.

Distributing BGP EVPN Type-2 Host Routes to a DCIG

In APIC up to release 2.0(1f), the fabric control plane did not send EVPN host routes directly, but advertised public bridge domain (BD) subnets in the form of BGP EVPN type-5 (IP Prefix) routes to a Data Center Interconnect Gateway (DCIG). This could result in suboptimal traffic forwarding. To improve forwarding, in APIC release 2.1x, you can enable fabric spines to also advertise host routes using EVPN type-2 (MAC-IP) host routes to the DCIG along with the public BD subnets.

To do so, you must perform the following steps:

1. When you configure the BGP Address Family Context Policy, enable Host Route Leak.
2. When you leak the host route to BGP EVPN in a GOLF setup:
 - a. To enable host routes when GOLF is enabled, the BGP Address Family Context Policy must be configured under the application tenant (the application tenant is the consumer tenant that leaks the endpoint to BGP EVPN) rather than under the infrastructure tenant.

- b. For a single-pod fabric, the host route feature is not required. The host route feature is required to avoid sub-optimal forwarding in a multi-pod fabric setup. However, if a single-pod fabric is setup, then in order to leak the endpoint to BGP EVPN, a Fabric External Connection Policy must be configured to provide the ETEP IP address. Otherwise, the host route will not leak to BGP EVPN.
- 3. When you configure VRF properties:
 - a. Add the BGP Address Family Context Policy to the BGP Context Per Address Families for IPv4 and IPv6.
 - b. Configure BGP Route Target Profiles that identify routes that can be imported or exported from the VRF.

Multipod

Multipod enables provisioning a more fault tolerant fabric comprised of multiple pods with isolated control plane protocols. Also, multipod provides more flexibility with regard to the full mesh cabling between leaf and spine switches. For example, if leaf switches are spread across different floors or different buildings, multipod enables provisioning multiple pods per floor or building and providing connectivity between pods through spine switches.

Multipod uses MP-BGP EVPN as the control-plane communication protocol between the ACI spines in different Pods. WAN routers can be provisioned in the IPN, directly connected to spine switches, or connected to border leaf switches. Multipod uses a single APIC cluster for all the pods; all the pods act as a single fabric. Individual APIC controllers are placed across the pods but they are all part of a single APIC cluster.

Figure 19: Multipod Overview

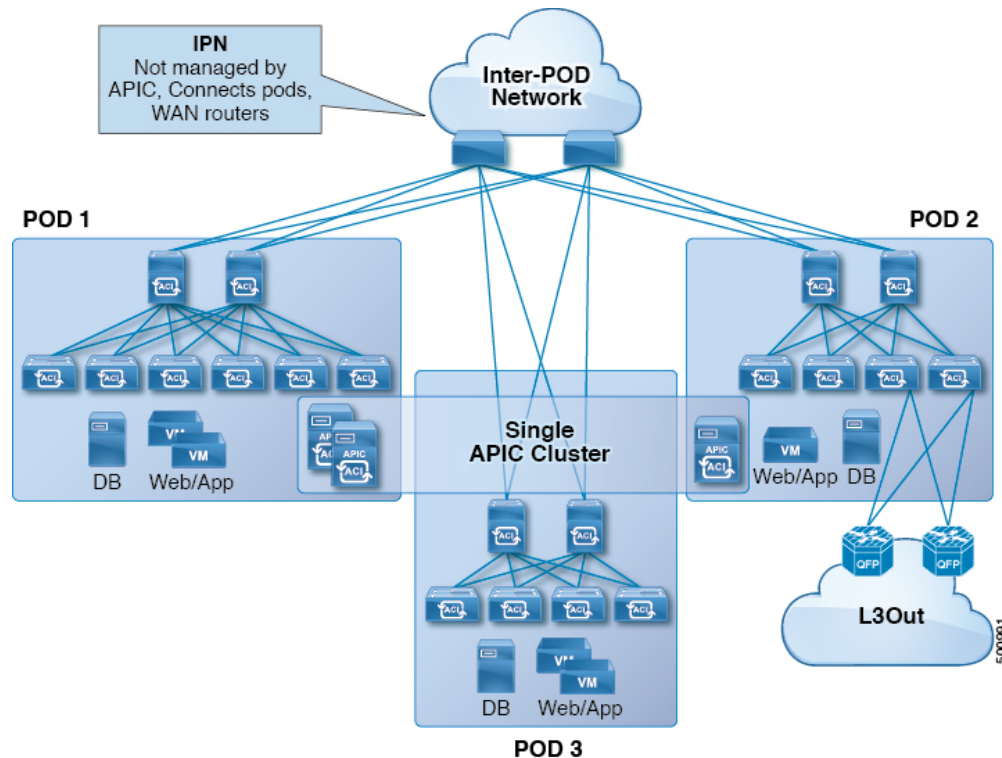

For control plane isolation, IS-IS and COOP are not extended across pods. Endpoints synchronize across pods using BGP EVPN over the IPN between the pods. Two spines in each pod are configured to have BGP EVPN sessions with spines of other pods. The spines connected to the IPN get the endpoints and multicast groups from COOP within a pod, but they advertise them over the IPN EVPN sessions between the pods. On the receiving side, BGP gives them back to COOP and COOP synchs them across all the spines in the pod. WAN routes are exchanged between the pods using BGP VPNv4/VPNv6 address families; they are not exchanged using the EVPN address family.

There are two modes of setting up the spine switches for communicating across pods as peers and route reflectors:

- **Automatic**

- Automatic mode is a route reflector based mode that does not support a full mesh where all spines peer with each other. The administrator must post an existing BGP route reflector policy and select IPN aware (EVPN) route reflectors. All the peer/client settings are automated by the APIC.
- The administrator does not have an option to choose route reflectors that don't belong to the fabric (for example, in the IPN).

- **Manual**

- The administrator has the option to configure full mesh where all spines peer with each other without route reflectors.
- In manual mode, the administrator must post the already existing BGP peer policy.

Observe the following multipod guidelines and limitations:

- When adding a pod to the ACI fabric, wait for the control plane to converge before adding another pod.
- OSPF is deployed on ACI spine switches and IPN switches to provide reachability between PODs. Layer 3 subinterfaces are created on spines to connect to IPN switches. OSPF is enabled on these Layer 3 subinterfaces and per POD TEP prefixes are advertised over OSPF. There is one subinterface created on each external spine link. Provision many external links on each spine if the expectation is that the amount of east-west traffic between PODs will be large. Currently, ACI spine switches support up to 64 external links on each spine, and each subinterface can be configured for OSPF. Spine proxy TEP addresses are advertised in OSPF over all the subinterfaces leading to a maximum of 64 way ECMP on the IPN switch for proxy TEP addresses. Similarly, spines would receive proxy TEP addresses of other PODs from IPN switches over OSPF and the spine can have up to 64 way ECMP for remote pod proxy TEP addresses. In this way, traffic between PODs spread over all these external links provides the desired bandwidth.
- When the all fabric links of a spine switch are down, OSPF advertises the TEP routes with the maximum metric. This will force the IPN switch to remove the spine switch from ECMP which will prevent the IPN from forwarding traffic to the down spine switch. Traffic is then received by other spines that have up fabric links.
- Up to APIC release 2.0(2), multipod is not supported with GOLF. In release 2.0 (2) the two features are supported in the same fabric only over Cisco Nexus N9000K switches without “EX” on the end of the switch name; for example, N9K-9312TX. Since the 2.1(1) release, the two features can be deployed together over all the switches used in the multipod and EVPN topologies.
- In a multipod fabric, if a spine in POD1 uses the infra tenant L3extOut-1, the TORs for the other pods (POD2, POD3) cannot use the same infra L3extOut (L3extOut-1) for Layer 3 EVPN control plane connectivity. Each POD must use their own spine switch and infra L3extOut, because it is not supported to use a pod as a transit for WAN connectivity of other pods.
- No filtering is done for limiting the routes exchanged across pods. All end-point and WAN routes present in each pod are exported to other pods.
- Inband management across pods is automatically configured by a self tunnel on every spine.
- The maximum latency supported between pods is 10 msec RTT, which roughly translates to a geographical distance of up to 500 miles.

Multipod Provisioning

The IPN is not managed by the APIC. It must be preconfigured with the following information:

- Configure the interfaces connected to the spines of all PODs. Use the VLAN-4 or VLAN-5 and MTU of 9150 and the associated correct IP addresses. Use VLAN-5 for the multipod interfaces/sub-interfaces, if any of the pods have connections to remote leaf switches.
- Enable OSPF on sub-interfaces with the correct area ID.
- Enable DHCP Relay on IPN interfaces connected to all spines.
- Enable PIM.
- Add bridge domain GIPO range as PIM Bidir group range (default is 225.0.0.0/8).
- Add 239.255.255.240/28 as PIM bidir group range.

- Enable PIM and IGMP on the interface connected to all spines.

Figure 20: Multipod Provisioning

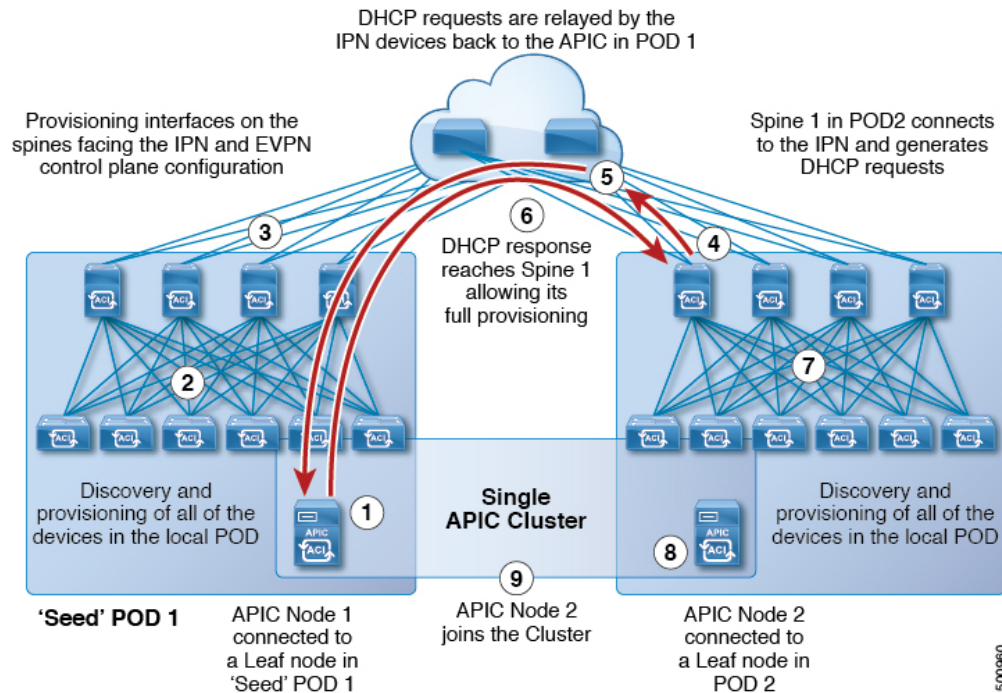

The multipod discovery process follows the following sequence:

1. APIC1 connected to POD1 starts the discovery process.
2. Spine and leaf switches in the POD that are directly connected to the APIC1 are discovered same way as the single pod fabric discovery.
3. APIC1 pushes the L3out policies to the spines in POD1. The spine L3out policy provisions the IPN connected interfaces on spines and IP connectivity to the IPN is established.
4. POD2 spine sends DHCP request to the IPN.
5. The IPN relays the DHCP request to the APIC.
6. The APIC sends DHCP response with the sub-interface IP from the spine L3Out configuration. Upon receiving the DHCP response, the spine configures the IP address on the IPN interface, creates the static route to the APIC using the relay address in the DHCP response as the gateway address, downloads the L3Out configuration from the spine which enables OSPF, removes the APIC static route, configures the infra DHCP relay, enables the DHCP client for all fabric and spine L3Out ports, and then the spine comes up according to the normal bringup sequence.
7. All other nodes in POD2 come up as usual.
8. The APIC controller in POD2 is discovered as usual.
9. The APIC controller in POD2 joins the APIC cluster.

Multi-Pod QoS and DSCP Translation Policy

When traffic is sent and received within the Cisco ACI fabric, the QoS Level is determined based on the CoS value of the VXLAN packet's outer header. In Multi-Pod topologies, where devices that are not under Cisco APIC's management may modify the CoS values in the transiting packets, you can preserve the QoS Level setting by creating a mapping between the Cisco ACI and the DSCP value within the packet.

If you are not concerned with preserving the QoS settings in the IPN traffic between pods, but would like to preserve the original CoS values of the packets ingressing and egressing the fabric, see [Class of Service \(CoS\) Preservation for Ingress and Egress Traffic, on page 52](#) instead.

Figure 21: Multi-Pod Topology

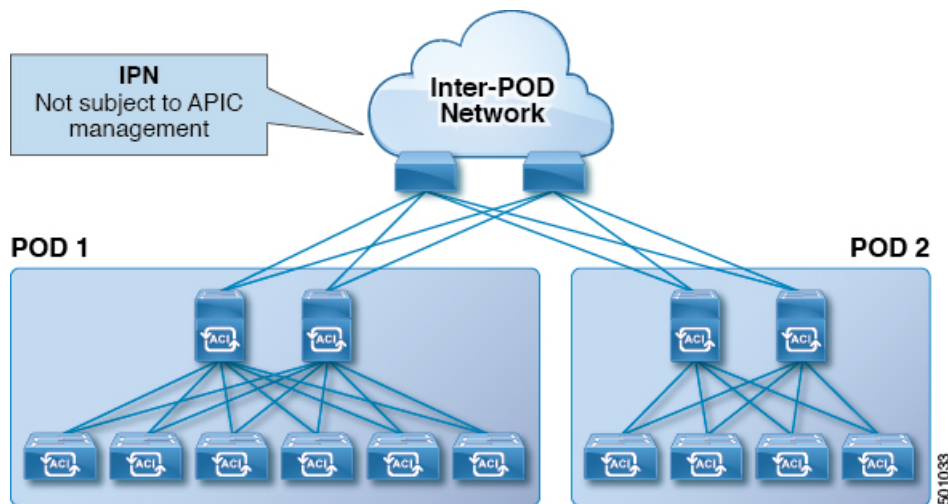

As illustrated in this figure, traffic between pods in a Multi-Pod topology passes through an IPN, which may contain devices that are not under Cisco APIC's management. When a network packet is sent from a spine or a leaf switch in POD1, the devices in the IPN may modify the 802.1p value in the packet. In this case, when the frame reaches a spine or a leaf switch in POD2, it would have an 802.1p value that was assigned by the IPN device, instead of the Cisco ACI QoS Level value assigned at the source in POD1.

In order to preserve the proper QoS Level of the packet and avoid high priority packets from being delayed or dropped, you can use a DSCP translation policy for traffic that goes between multiple PODs connected by an IPN. When a DSCP translation policy is enabled, Cisco APIC converts the QoS Level value (represented by the CoS value of the VXLAN packet) to a DSCP value according to the mapping rules you specify. When a packet sent from POD1 reaches POD2, the mapped DSCP value is translated back into the original CoS value for the appropriate QoS Level.

About Anycast Services

Anycast services are supported in the Cisco ACI fabric. A typical use case is to support Cisco Adaptive Security Appliance (ASA) firewalls in the pods of a multipod fabric, but Anycast could be used to enable other services, such as DNS servers or printing services. In the ASA use case, a firewall is installed in every pod and Anycast is enabled, so the firewall can be offered as an Anycast service. One instance of a firewall going down does not affect clients, as the requests are routed to the next, nearest instance available. You install ASA firewalls in each pod, then enable Anycast and configure the IP address and MAC addresses to be used.

APIC deploys the configuration of the Anycast MAC and IP addresses to the leaf switches where the VRF is deployed or where there is a contract to allow an Anycast EPG.

Initially, each leaf switch installs the Anycast MAC and IP addresses as a proxy route to the spine switch. When the first packet from the Anycast Service is received, the destination information for the service is installed on the leaf switch behind which the service is installed. All other leaf switches continue to point to the spine proxy. When the Anycast service has been learned, located behind a leaf in a pod, COOP installs the entry on the spine switch to point to the service that is local to the pod.

When the Anycast service is running in one pod, the spine receives the route information for the Anycast service present in the pod through BGP-EVPN. If the Anycast service is already locally present, then COOP caches the Anycast service information of the remote pod. This route through the remote pod is only installed when the local instance of the service goes down.

Remote Leaf Switches

About Remote Leaf Switches in the ACI Fabric

With an ACI fabric deployed, you can extend ACI services and APIC management to remote data centers with Cisco ACI leaf switches that have no local spine switch or APIC attached.

The remote leaf switches are added to an existing pod in the fabric. All policies deployed in the main data center are deployed in the remote switches, which behave like local leaf switches belonging to the pod. In this topology, all unicast traffic is through VXLAN over Layer 3. Layer 2 broadcast, unknown unicast, and multicast (BUM) messages are sent using Head End Replication (HER) tunnels without the use of Layer 3 multicast (bidirectional PIM) over the WAN. Any traffic that requires use of the spine switch proxy is forwarded to the main data center.

The APIC system discovers the remote leaf switches when they come up. From that time, they can be managed through APIC, as part of the fabric.



Note

- All inter-VRF traffic (pre-release 4.0(1)) goes to the spine switch before being forwarded.
 - For releases prior to Release 4.1(2), before decommissioning a remote leaf switch, you must first delete the vPC.
-

Characteristics of Remote Leaf Switch Behavior in Release 4.0(1)

Starting in Release 4.0(1), remote leaf switch behavior takes on the following characteristics:

- Reduction of WAN bandwidth use by decoupling services from spine-proxy:
 - PBR: For local PBR devices or PBR devices behind a vPC, local switching is used without going to the spine proxy. For PBR devices on orphan ports on a peer remote leaf, a RL-vPC tunnel is used. This is true when the spine link to the main DC is functional or not functional.
 - ERSPAN: For peer destination EPGs, a RL-vPC tunnel is used. EPGs on local orphan or vPC ports use local switching to the destination EPG. This is true when the spine link to the main DC is functional or not functional.

- Shared Services: Packets do not use spine-proxy path reducing WAN bandwidth consumption.
- Inter-VRF traffic is forwarded through an upstream router and not placed on the spine.
- This enhancement is only applicable for a remote leaf vPC pair. For communication across remote leaf pairs, a spine proxy is still used.
- Resolution of unknown L3 endpoints (through ToR glean process) in a remote leaf location when spine-proxy is not reachable.

Characteristics of Remote Leaf Switch Behavior in Release 4.1(2)

Before Release 4.1(2), all local switching (within the remote leaf vPC peer) traffic on the remote leaf location is switched directly between endpoints, whether physical or virtual, as shown in the following figure.

Figure 22: Local Switching Traffic: Prior to Release 4.1(2)

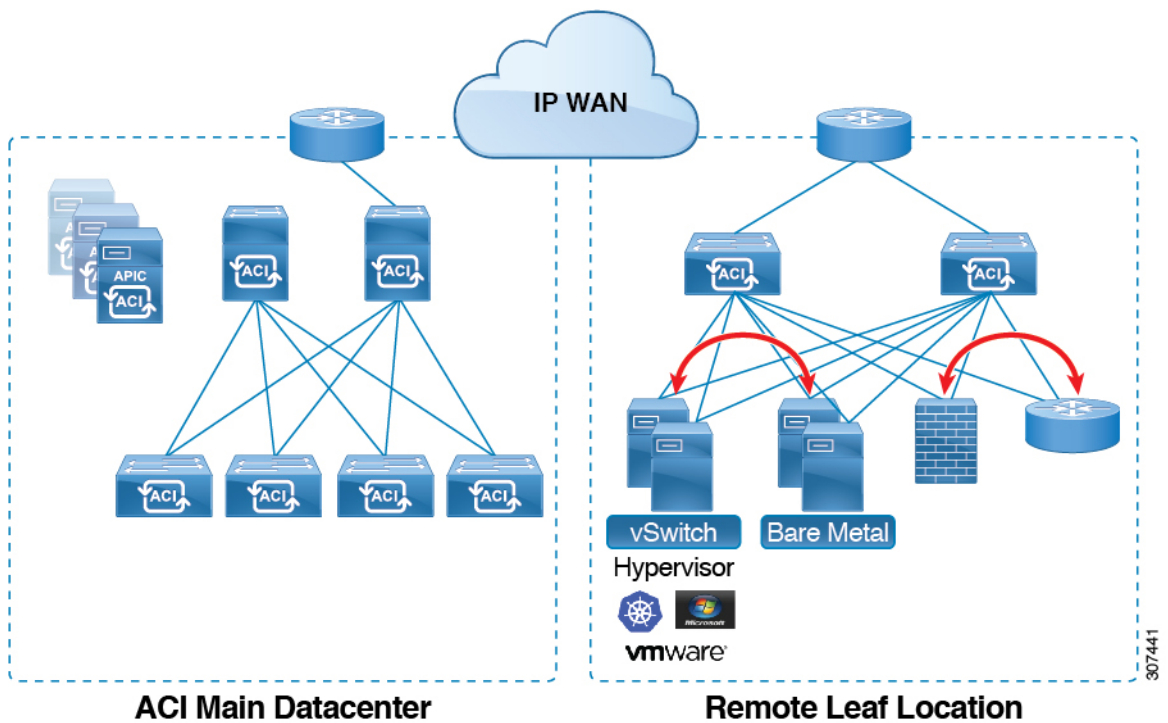

In addition, before Release 4.1(2), traffic between the remote leaf switch vPC pairs, either within a remote location or between remote locations, is forwarded to the spine switches in the ACI main data center pod, as shown in the following figure.

Figure 23: Remote Switching Traffic: Prior to Release 4.1(2)

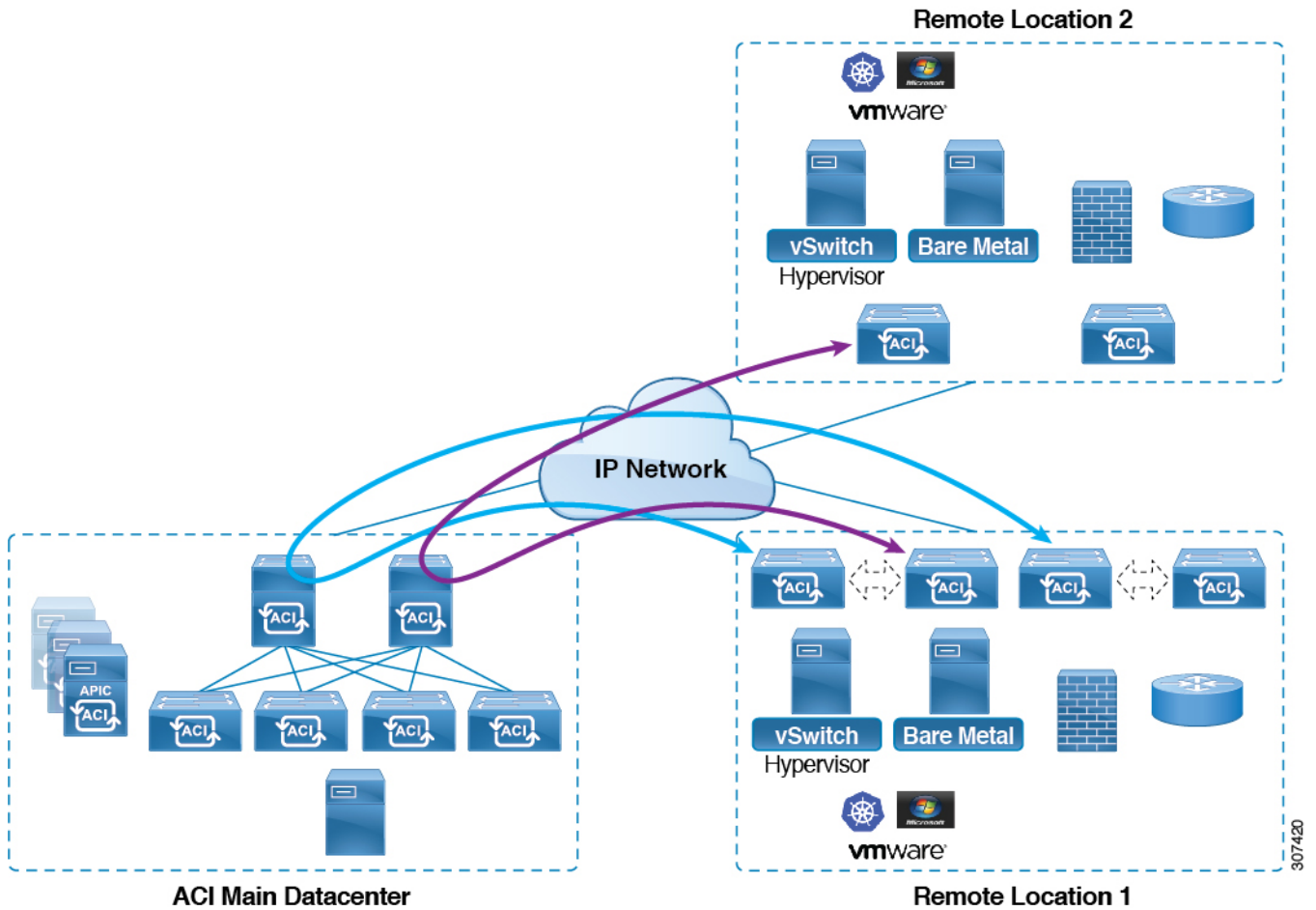

Starting in Release 4.1(2), support is now available for direct traffic forwarding between remote leaf switches in different remote locations. This functionality offers a level of redundancy and availability in the connections between remote locations, as shown in the following figure.

Figure 24: Remote Leaf Switch Behavior: Release 4.1(2)

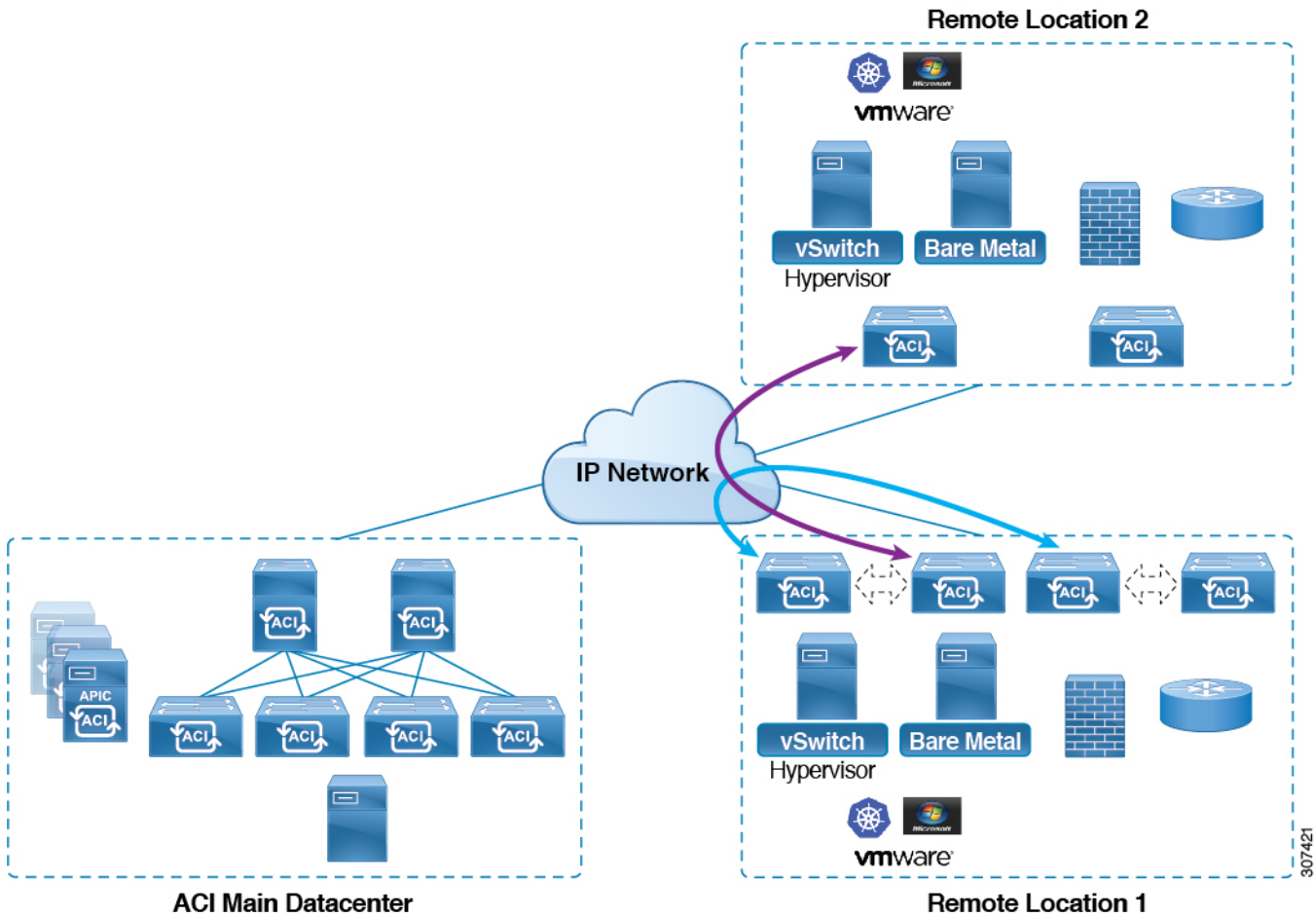

In addition, remote leaf switch behavior also takes on the following characteristics starting in release 4.1(2):

- Starting with Release 4.1(2), with direct traffic forwarding, when a spine switch fails within a single-pod configuration, the following occurs:
 - Local switching will continue to function for existing and new end point traffic between the remote leaf switch vPC peers, as shown in the "Local Switching Traffic: Prior to Release 4.1(2)" figure above.
 - For traffic between remote leaf switches across remote locations:
 - New end point traffic will fail because the remote leaf switch-to-spine switch tunnel would be down. From the remote leaf switch, new end point details will not get synced to the spine switch, so the other remote leaf switch pairs in the same or different locations cannot download the new end point information from COOP.
 - For uni-directional traffic, existing remote end points will age out after 300 secs, so traffic will fail after that point. Bi-directional traffic within a remote leaf site (between remote leaf VPC pairs) in a pod will get refreshed and will continue to function. Note that bi-directional traffic to remote locations (remote leaf switches) will be affected as the remote end points will be expired by COOP after a timeout of 900 seconds.

- For shared services (inter-VRF), bi-directional traffic between end points belonging to remote leaf switches attached to two different remote locations in the same pod will fail after the remote leaf switch COOP end point age-out time (900 sec). This is because the remote leaf switch-to-spine COOP session would be down in this situation. However, shared services traffic between end points belonging to remote leaf switches attached to two different pods will fail after 30 seconds, which is the COOP fast-aging time.
- L3Out-to-L3Out communication would not be able to continue because the BGP session to the spine switches would be down.
- When there is remote leaf direct uni-directional traffic, where the traffic is sourced from one remote leaf switch and destined to another remote leaf switch (which is not the vPC peer of the source), there will be a milli-second traffic loss every time the remote end point (XR EP) timeout of 300 seconds occurs.
- With a remote leaf switches with ACI Multi-Site configuration, all traffic continues from the remote leaf switch to the other pods and remote locations, even with a spine switch failure, because traffic will flow through an alternate available pod in this situation.

10 Mbps Bandwidth Support in IPN for Remote Leaf Switches

You might have situations where most of the data traffic from the remote leaf switches is local and the Inter-Pod Network (IPN) is needed only for management purposes. In these situations, you may not need a 100 Mbps IPN. To support these environments, starting with Release 4.2(4), support is now available for 10 Mbps as a minimum bandwidth in the IPN.

To support this, the following requirements should be met:

- The IPN path is only used for managing remote leaf switches (management functions such as upgrades and downgrades, discovery, COOP, and policy pushes).
- Configure IPN with the QoS configuration in order to prioritize control and management plane traffic between the Cisco ACI datacenter and remote leaf switch pairs based on the information provided in the section "Creating DSCP Translation Policy Using Cisco APIC GUI".
- All traffic from the Cisco ACI datacenter and remote leaf switches is through the local L3Out.
- The EPG or bridge domain are not stretched between the remote leaf switch and the ACI main datacenter.
- You should pre-download software images on the remote leaf switches to reduce upgrade time.

The following figure shows a graphical representation of this feature.

Figure 25: Remote Leaf Switch Behavior, Release 4.2(4): Remote Leaf Switch Management through IPN

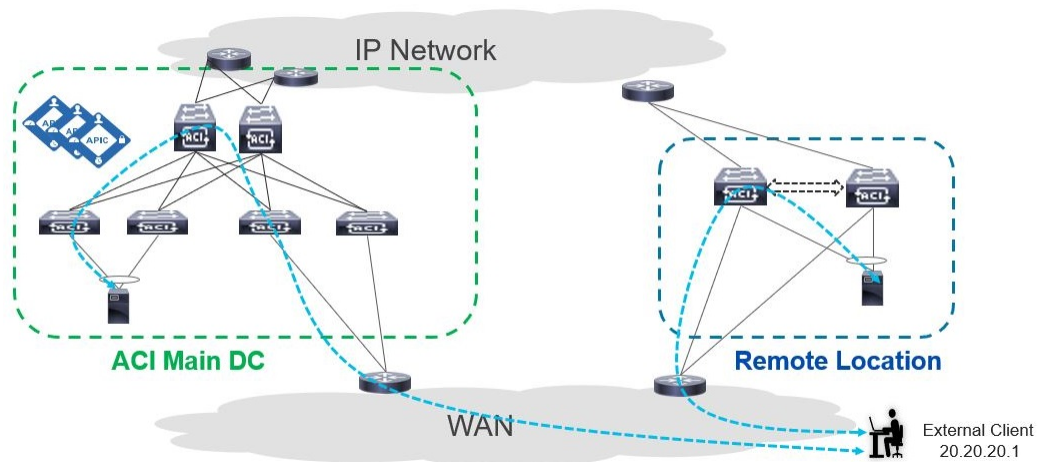

Dot1q Tunnel Support on Remote Leaf Switches

In some situations, a co-location provider might be hosting multiple customers, where each customer is using thousands of VLANs per remote leaf switch pair. Starting with Release 4.2(4), support is available to create an 802.1Q tunnel between the remote leaf switch and the ACI main datacenter, which provides the flexibility to map multiple VLANs into a single 802.1Q tunnel, thereby reducing the EPG scale requirement.

The following figure shows a graphical representation of this feature.

Figure 26: Remote Leaf Switch Behavior, Release 4.2(4): 802.1Q Tunnel Support on Remote Leaf Switches

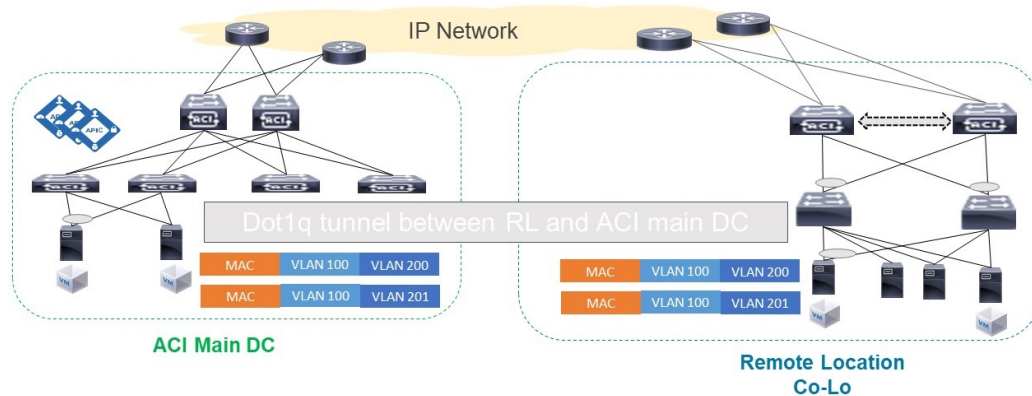

Create this 802.1Q tunnel between the remote leaf switch and the ACI main datacenter using the instructions provided in the "802.1Q Tunnels" chapter in the *Cisco APIC Layer 2 Networking Configuration Guide*, located in the [Cisco APIC documentation landing page](#).

You can configure remote leaf switches in the APIC GUI, either with and without a wizard, or use the REST API or the NX-OS style CLI.

Remote Leaf Switch Restrictions and Limitations

The following guidelines and restrictions apply to remote leaf switches:

- The remote leaf solution requires the /32 tunnel end point (TEP) IP addresses of the remote leaf switches and main data center leaf/spine switches to be advertised across the main data center and remote leaf switches without summarization.
- If you move a remote leaf switch to a different site within the same pod and the new site has the same node ID as the original site, you must delete and recreate the virtual port channel (vPC).
- With the Cisco N9K-C9348GC-FXP switch, you can perform the initial remote leaf switch discovery only on ports 1/53 or 1/54. Afterward, you can use the other ports for fabric uplinks to the ISN/IPN for the remote leaf switch.

The following sections provide information on what is supported and not supported with remote leaf switches:

- [Supported Features, on page 49](#)
- [Unsupported Features, on page 49](#)
- [Changes For Release 5.0\(1\), on page 51](#)

Supported Features

Stretching of an L3Out SVI within a vPC remote leaf switch pair is supported.

Beginning with Cisco APIC release 4.2(4), the 802.1Q (Dot1q) tunnels feature is supported.

Beginning with Cisco APIC release 4.1(2), the following features are supported:

- Remote leaf switches with ACI Multi-Site
- Traffic forwarding directly across two remote leaf vPC pairs in the same remote data center or across data centers, when those remote leaf pairs are associated to the same pod or to pods that are part of the same multipod fabric
- Transit L3Out across remote locations, which is when the main Cisco ACI data center pod is a transit between two remote locations (the L3Out in `RL location-1` and L3Out in `RL location-2` are advertising prefixes for each other)

Beginning with Cisco APIC release 4.0(1), the following features are supported:

- Q-in-Q Encapsulation Mapping for EPGs
- PBR Tracking on remote leaf switches (with system-level global GIPo enabled)
- PBR Resilient Hashing
- Netflow
- MacSec Encryption
- Troubleshooting Wizard
- Atomic counters

Unsupported Features

Full fabric and tenant policies are supported on remote leaf switches in this release with the exception of the following features, which are unsupported:

- GOLF
- vPod
- Floating L3Out
- Fast-convergence mode
- Stretching of L3Out SVI between local leaf switches (ACI main data center switches) and remote leaf switches or stretching across two different vPC pairs of remote leaf switches
- Copy service is not supported when deployed on local leaf switches and when the source or destination is on the remote leaf switch. In this situation, the routable TEP IP address is not allocated for the local leaf switch. For more information, see the section "Copy Services Limitations" in the "Configuring Copy Services" chapter in the *Cisco APIC Layer 4 to Layer 7 Services Deployment Guide*, available in the [APIC documentation page](#).
- Layer 2 Outside Connections (except Static EPGs)
- Copy services with vzAny contract
- FCoE connections on remote leaf switches
- Flood in encapsulation for bridge domains or EPGs
- Fast Link Failover policies
- Managed Service Graph-attached devices at remote locations
- Traffic Storm Control
- Cloud Sec Encryption
- First Hop Security
- Layer 3 Multicast routing on remote leaf switches
- Maintenance mode
- TEP to TEP atomic counters

The following scenarios are not supported when integrating remote leaf switches in a Multi-Site architecture in conjunction with the intersite L3Out functionality:

- Transit routing between L3Outs deployed on remote leaf switch pairs associated to separate sites
- Endpoints connected to a remote leaf switch pair associated to a site communicating with the L3Out deployed on the remote leaf switch pair associated to a remote site
- Endpoints connected to the local site communicating with the L3Out deployed on the remote leaf switch pair associated to a remote site
- Endpoints connected to a remote leaf switch pair associated to a site communicating with the L3Out deployed on a remote site



Note The limitations above do not apply if the different data center sites are deployed as pods as part of the same Multi-Pod fabric.

The following deployments and configurations are not supported with the remote leaf switch feature:

- It is not supported to stretch a bridge domain between remote leaf nodes associated to a given site (APIC domain) and leaf nodes part of a separate site of a Multi-Site deployment (in both scenarios where those leaf nodes are local or remote) and a fault is generated on APIC to highlight this restriction. This applies independently from the fact that BUM flooding is enabled or disabled when configuring the stretched bridge domain on the Multi-Site Orchestrator (MSO). However, a bridge domain can always be stretched (with BUM flooding enabled or disabled) between Remote Leaf nodes and Local Leaf nodes belonging to the same site (APIC domain).
- Spanning Tree Protocol across remote leaf location and main data center.
- APICs directly connected to remote leaf switches.
- Orphan port channel or physical ports on remote leaf switches, with a vPC domain (this restriction applies for releases 3.1 and earlier).
- With and without service node integration, local traffic forwarding within a remote location is only supported if the consumer, provider, and services nodes are all connected to remote leaf switches are in vPC mode.
- /32 loopbacks advertised from the spine switch to the IPN must not be suppressed/aggregated toward the remote leaf switch. The /32 loopbacks must be advertised to the remote leaf switch.

Changes For Release 5.0(1)

Beginning with Cisco APIC release 5.0(1), the following changes have been applied for remote leaf switches:

- The direct traffic forwarding feature is enabled by default and cannot be disabled.
- A configuration without direct traffic forwarding for remote leaf switches is no longer supported. If you have remote leaf switches and you are upgrading to Cisco APIC release 5.0(1), review the information provided in the section "About Direct Traffic Forwarding" and enable direct traffic forwarding using the instructions in that section.

QoS

L3Outs QoS

L3Out QoS can be configured using Contracts applied at the external EPG level. Starting with Release 4.0(1), L3Out QoS can also be configured directly on the L3Out interfaces.



Note If you are running Cisco APIC Release 4.0(1) or later, we recommend using the custom QoS policies applied directly to the L3Out to configure QoS for L3Outs.

Packets are classified using the ingress DSCP or CoS value so it is possible to use custom QoS policies to classify the incoming traffic into Cisco ACI QoS queues. A custom QoS policy contains a table mapping the DSCP/CoS values to the user queue and to the new DSCP/CoS value (in case of marking). If there is no

mapping for a specific DSCP/CoS value, the user queue is selected by the QoS priority setting of the ingress L3Out interface if configured.

Class of Service (CoS) Preservation for Ingress and Egress Traffic

When traffic enters the Cisco ACI fabric, each packet's priority is mapped to a Cisco ACI QoS level. These QoS levels are then stored in the CoS field and DE bit of the packet's outer header while the original headers are discarded.

If you want to preserve the original CoS values of the ingressing packets and restore it when the packet leaves the fabric, you can enable the 802.1p Class of Service (CoS) preservation using a global fabric QoS policy as described in this section.

The CoS preservation is supported in single pod and multipod topologies, however in multipod topologies, CoS preservation can be used only when you are not concerned with preserving the settings in the IPN between pods. To preserve the CoS values of the packets as they are transiting the IPN, use the DSCP translation policy as described in [Multi-Pod QoS and DSCP Translation Policy, on page 42](#).

Multi-Pod QoS and DSCP Translation Policy

When traffic is sent and received within the Cisco ACI fabric, the QoS Level is determined based on the CoS value of the VXLAN packet's outer header. In Multi-Pod topologies, where devices that are not under Cisco APIC's management may modify the CoS values in the transiting packets, you can preserve the QoS Level setting by creating a mapping between the Cisco ACI and the DSCP value within the packet.

If you are not concerned with preserving the QoS settings in the IPN traffic between pods, but would like to preserve the original CoS values of the packets ingressing and egressing the fabric, see [Class of Service \(CoS\) Preservation for Ingress and Egress Traffic, on page 52](#) instead.

Figure 27: Multi-Pod Topology

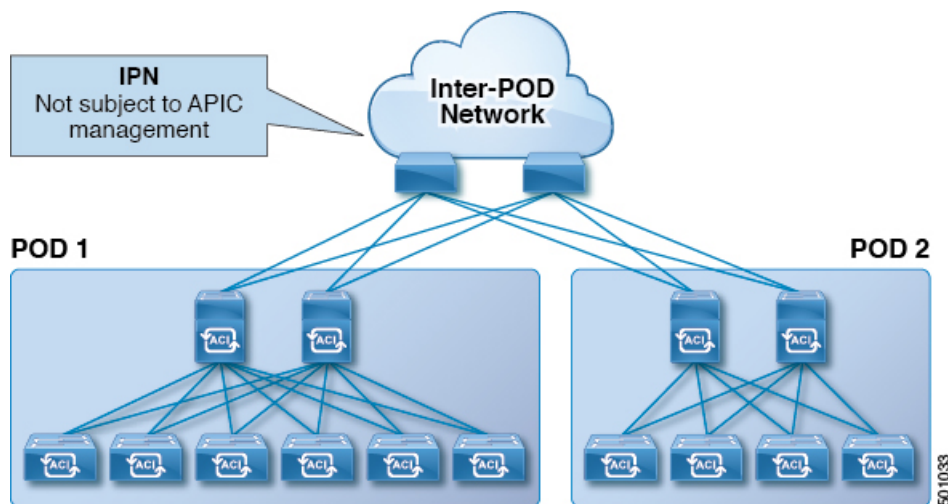

As illustrated in this figure, traffic between pods in a Multi-Pod topology passes through an IPN, which may contain devices that are not under Cisco APIC's management. When a network packet is sent from a spine or a leaf switch in POD1, the devices in the IPN may modify the 802.1p value in the packet. In this case, when the frame reaches a spine or a leaf switch in POD2, it would have an 802.1p value that was assigned by the IPN device, instead of the Cisco ACI QoS Level value assigned at the source in POD1.

In order to preserve the proper QoS Level of the packet and avoid high priority packets from being delayed or dropped, you can use a DSCP translation policy for traffic that goes between multiple PODs connected by an IPN. When a DSCP translation policy is enabled, Cisco APIC converts the QoS Level value (represented by the CoS value of the VXLAN packet) to a DSCP value according to the mapping rules you specify. When a packet sent from POD1 reaches POD2, the mapped DSCP value is translated back into the original CoS value for the appropriate QoS Level.

Translating Ingress to Egress QoS Markings

Cisco APIC enables translating the DSCP and CoS values of the ingressing traffic to a QoS Level to be used inside the Cisco ACI fabric. Translation is supported only if the DSCP values are present in the IP packet and CoS values are present in the Ethernet frames.

For example, this functionality allows the Cisco ACI fabric to classify the traffic for devices that classify the traffic based only on the CoS value, such as Layer-2 packets, which do not have an IP header.

CoS Translation Guidelines and Limitations

You must enable the global fabric CoS preservation policy, as described in [Class of Service \(CoS\) Preservation for Ingress and Egress Traffic, on page 52](#).

CoS translation is not supported on external L3 interfaces.

CoS translation is supported only if the egress frame is 802.1Q encapsulated.

CoS translation is not supported when the following configuration options are enabled:

- Contracts are configured that include QoS.
- The outgoing interface is on a FEX.
- Multipod QoS using a DSCP policy is enabled.
- Dynamic packet prioritization is enabled.
- If an EPG is configured with intra-EPG endpoint isolation enforced.
- If an EPG is configured with allow-microsegmentation enabled.

HSRP

About HSRP

HSRP is a first-hop redundancy protocol (FHRP) that allows a transparent failover of the first-hop IP router. HSRP provides first-hop routing redundancy for IP hosts on Ethernet networks configured with a default router IP address. You use HSRP in a group of routers for selecting an active router and a standby router. In a group of routers, the active router is the router that routes packets, and the standby router is the router that takes over when the active router fails or when preset conditions are met.

Many host implementations do not support any dynamic router discovery mechanisms but can be configured with a default router. Running a dynamic router discovery mechanism on every host is not practical for many reasons, including administrative overhead, processing overhead, and security issues. HSRP provides failover services to such hosts.

When you use HSRP, you configure the HSRP virtual IP address as the default router of the host (instead of the IP address of the actual router). The virtual IP address is an IPv4 or IPv6 address that is shared among a group of routers that run HSRP.

When you configure HSRP on a network segment, you provide a virtual MAC address and a virtual IP address for the HSRP group. You configure the same virtual address on each HSRP-enabled interface in the group. You also configure a unique IP address and MAC address on each interface that acts as the real address. HSRP selects one of these interfaces to be the active router. The active router receives and routes packets destined for the virtual MAC address of the group.

HSRP detects when the designated active router fails. At that point, a selected standby router assumes control of the virtual MAC and IP addresses of the HSRP group. HSRP also selects a new standby router at that time.

HSRP uses a priority designator to determine which HSRP-configured interface becomes the default active router. To configure an interface as the active router, you assign it with a priority that is higher than the priority of all the other HSRP-configured interfaces in the group. The default priority is 100, so if you configure just one interface with a higher priority, that interface becomes the default active router.

Interfaces that run HSRP send and receive multicast User Datagram Protocol (UDP)-based hello messages to detect a failure and to designate active and standby routers. When the active router fails to send a hello message within a configurable period of time, the standby router with the highest priority becomes the active router. The transition of packet forwarding functions between the active and standby router is completely transparent to all hosts on the network.

You can configure multiple HSRP groups on an interface. The virtual router does not physically exist but represents the common default router for interfaces that are configured to provide backup to each other. You do not need to configure the hosts on the LAN with the IP address of the active router. Instead, you configure them with the IP address of the virtual router (virtual IP address) as their default router. If the active router fails to send a hello message within the configurable period of time, the standby router takes over, responds to the virtual addresses, and becomes the active router, assuming the active router duties. From the host perspective, the virtual router remains the same.



Note Packets received on a routed port destined for the HSRP virtual IP address terminate on the local router, regardless of whether that router is the active HSRP router or the standby HSRP router. This process includes ping and Telnet traffic. Packets received on a Layer 2 (VLAN) interface destined for the HSRP virtual IP address terminate on the active router.

About Cisco APIC and HSRP

HSRP in Cisco ACI is supported only on routed-interface or sub-interface. Therefore HSRP can only be configured under Layer 3 Out. Also there must be Layer 2 connectivity provided by external device(s) such as a Layer 2 switch between ACI leaf switches running HSRP because HSRP operates on leaf switches by exchanging Hello messages over external Layer 2 connections. An HSRP hello message does not pass through the spine switch.

The following is an example topology of an HSRP deployment in Cisco APIC.

Figure 28: HSRP Deployment Topology

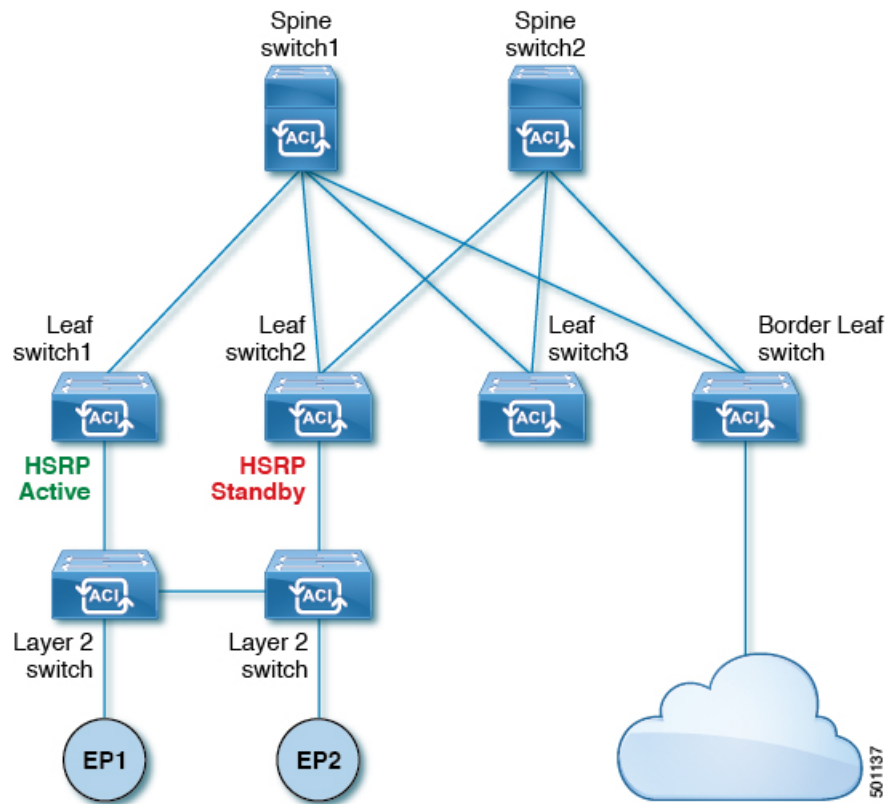

Guidelines and Limitations

Follow these guidelines and limitations:

- The HSRP state must be the same for both HSRP IPv4 and IPv6. The priority and preemption must be configured to result in the same state after failovers.
- Currently, only one IPv4 and one IPv6 group is supported on the same sub-interface in Cisco ACI. Even when dual stack is configured, Virtual MAC must be the same in IPv4 and IPv6 HSRP configurations.
- BFD IPv4 and IPv6 is supported when the network connecting the HSRP peers is a pure layer 2 network. You must configure a different router MAC address on the leaf switches. The BFD sessions become active only if you configure different MAC addresses in the leaf interfaces.
- Users must configure the same MAC address for IPv4 and IPv6 HSRP groups for dual stack configurations.
- HSRP VIP must be in the same subnet as the interface IP.
- It is recommended that you configure interface delay for HSRP configurations.
- HSRP is only supported on routed-interface or sub-interface. HSRP is not supported on VLAN interfaces and switched virtual interface (SVI). Therefore, no VPC support for HSRP is available.
- Object tracking on HSRP is not supported.
- HSRP Management Information Base (MIB) for SNMP is not supported.

- Multiple group optimization (MGO) is not supported with HSRP.
- ICMP IPv4 and IPv6 redirects are not supported.
- Cold Standby and Non-Stop Forwarding (NSF) are not supported because HSRP cannot be restarted in the Cisco ACI environment.
- There is no extended hold-down timer support as HSRP is supported only on leaf switches. HSRP is not supported on spine switches.
- HSRP version change is not supported in APIC. You must remove the configuration and reconfigure with the new version.
- HSRP version 2 does not inter-operate with HSRP version 1. An interface cannot operate both version 1 and version 2 because both versions are mutually exclusive. However, the different versions can be run on different physical interfaces of the same router.
- Route Segmentation is programmed in Cisco Nexus 93128TX, Cisco Nexus 9396PX, and Cisco Nexus 9396TX leaf switches when HSRP is active on the interface. Therefore, there is no DMAC=router MAC check conducted for route packets on the interface. This limitation does not apply for Cisco Nexus 93180LC-EX, Cisco Nexus 93180YC-EX, and Cisco Nexus 93108TC-EX leaf switches.
- HSRP configurations are not supported in the Basic GUI mode. The Basic GUI mode has been deprecated starting with APIC release 3.0(1).
- Fabric to Layer 3 Out traffic will always load balance across all the HSRP leaf switches, irrespective of their state. If HSRP leaf switches span multiple pods, the fabric to out traffic will always use leaf switches in the same pod.
- This limitation applies to some of the earlier Cisco Nexus 93128TX, Cisco Nexus 9396PX, and Cisco Nexus 9396TX switches. When using HSRP, the MAC address for one of the routed interfaces or routed sub-interfaces must be modified to prevent MAC address flapping on the Layer 2 external device. This is because Cisco APIC assigns the same MAC address (00:22:BD:F8:19:FF) to every logical interface under the interface logical profiles.

HSRP Versions

Cisco APIC supports HSRP version 1 by default. You can configure an interface to use HSRP version 2.

HSRP version 2 has the following enhancements to HSRP version 1:

- Expands the group number range. HSRP version 1 supports group numbers from 0 to 255. HSRP version 2 supports group numbers from 0 to 4095.
- For IPv4, uses the IPv4 multicast address 224.0.0.102 or the IPv6 multicast address FF02::66 to send hello packets instead of the multicast address of 224.0.0.2, which is used by HSRP version 1.
- Uses the MAC address range from 0000.0C9F.F000 to 0000.0C9F.FFFF for IPv4 and 0005.73A0.0000 through 0005.73A0.0FFF for IPv6 addresses. HSRP version 1 uses the MAC address range 0000.0C07.AC00 to 0000.0C07.ACFE.