



# CHAPTER 36

## Configuring QoS

---

This chapter describes how to configure quality of service (QoS) by using automatic QoS (auto-QoS) commands or by using standard QoS commands on the switch. With QoS, you can provide preferential treatment to certain types of traffic at the expense of others. Without QoS, the switch offers best-effort service to each packet, regardless of the packet contents or size. It sends the packets without any assurance of reliability, delay bounds, or throughput. Unless otherwise noted, the term *switch* refers to a standalone switch and to a switch stack.

You can configure QoS on physical ports and on switch virtual interfaces (SVIs). Other than to apply policy maps, you configure the QoS settings, such as classification, queueing, and scheduling, the same way on physical ports and SVIs. When configuring QoS on a physical port, you apply a nonhierarchical policy map. When configuring QoS on an SVI, you apply a nonhierarchical or a hierarchical policy map.



### Note

For complete syntax and usage information for the commands used in this chapter, see the command reference this release.

---

This chapter consists of these sections:

- [Understanding QoS, page 36-2](#)
- [Configuring Auto-QoS, page 36-20](#)
- [Displaying Auto-QoS Information, page 36-29](#)
- [Configuring Standard QoS, page 36-29](#)
- [Displaying Standard QoS Information, page 36-78](#)

The switch supports some of the modular QoS CLI (MQC) commands. For more information about the MQC commands, see the “Modular Quality of Service Command-Line Interface Overview” at this site: [http://www.cisco.com/en/US/products/sw/iosswrel/ps1835/products\\_configuration\\_guide\\_chapter09186a00800bd908.html#9](http://www.cisco.com/en/US/products/sw/iosswrel/ps1835/products_configuration_guide_chapter09186a00800bd908.html#9)

# Understanding QoS

Typically, networks operate on a best-effort delivery basis, which means that all traffic has equal priority and an equal chance of being delivered in a timely manner. When congestion occurs, all traffic has an equal chance of being dropped.

When you configure the QoS feature, you can select specific network traffic, prioritize it according to its relative importance, and use congestion-management and congestion-avoidance techniques to provide preferential treatment. Implementing QoS in your network makes network performance more predictable and bandwidth utilization more effective.

The QoS implementation is based on the Differentiated Services (Diff-Serv) architecture, an emerging standard from the Internet Engineering Task Force (IETF). This architecture specifies that each packet is classified upon entry into the network.

The classification is carried in the IP packet header, using 6 bits from the deprecated IP type of service (ToS) field to carry the classification (*class*) information. Classification can also be carried in the Layer 2 frame. These special bits in the Layer 2 frame or a Layer 3 packet are described here and shown in [Figure 36-1](#):

- Prioritization bits in Layer 2 frames:

Layer 2 Inter-Switch Link (ISL) frame headers have a 1-byte User field that carries an IEEE 802.1p class of service (CoS) value in the three least-significant bits. On ports configured as Layer 2 ISL trunks, all traffic is in ISL frames.

Layer 2 802.1Q frame headers have a 2-byte Tag Control Information field that carries the CoS value in the three most-significant bits, which are called the User Priority bits. On ports configured as Layer 2 802.1Q trunks, all traffic is in 802.1Q frames except for traffic in the native VLAN.

Other frame types cannot carry Layer 2 CoS values.

Layer 2 CoS values range from 0 for low priority to 7 for high priority.

- Prioritization bits in Layer 3 packets:

Layer 3 IP packets can carry either an IP precedence value or a Differentiated Services Code Point (DSCP) value. QoS supports the use of either value because DSCP values are backward-compatible with IP precedence values.

IP precedence values range from 0 to 7.

DSCP values range from 0 to 63.



---

**Note** IPv6 QoS is not supported in this release.

---

**Figure 36-1 QoS Classification Layers in Frames and Packets**

Encapsulated Packet

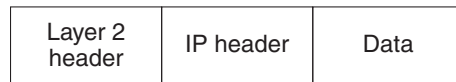

Layer 2 ISL Frame

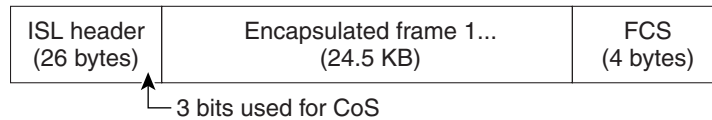

Layer 2 802.1Q and 802.1p Frame

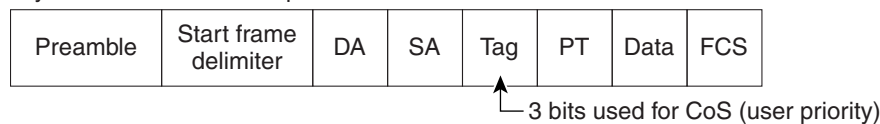

Layer 3 IPv4 Packet

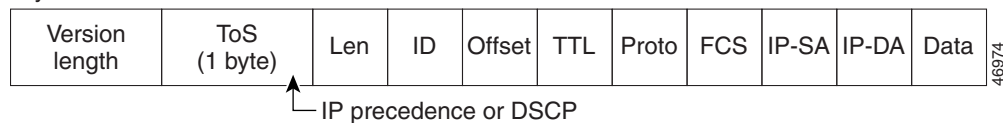

All switches and routers that access the Internet rely on the class information to provide the same forwarding treatment to packets with the same class information and different treatment to packets with different class information. The class information in the packet can be assigned by end hosts or by switches or routers along the way, based on a configured policy, detailed examination of the packet, or both. Detailed examination of the packet is expected to happen closer to the edge of the network so that the core switches and routers are not overloaded with this task.

Switches and routers along the path can use the class information to limit the amount of resources allocated per traffic class. The behavior of an individual device when handling traffic in the DiffServ architecture is called per-hop behavior. If all devices along a path provide a consistent per-hop behavior, you can construct an end-to-end QoS solution.

Implementing QoS in your network can be a simple or complex task and depends on the QoS features offered by your internetworking devices, the traffic types and patterns in your network, and the granularity of control that you need over incoming and outgoing traffic.

## Basic QoS Model

To implement QoS, the switch must distinguish packets or flow from one another (classify), assign a label to indicate the given quality of service as the packets move through the switch, make the packets comply with the configured resource usage limits (police and mark), and provide different treatment (queue and schedule) in all situations where resource contention exists. The switch also needs to ensure that traffic sent from it meets a specific traffic profile (shape).

Figure 36-2 shows the basic QoS model. Actions at the ingress port include classifying traffic, policing, marking, queueing, and scheduling:

- Classifying a distinct path for a packet by associating it with a QoS label. The switch maps the CoS or DSCP in the packet to a QoS label to distinguish one kind of traffic from another. The QoS label that is generated identifies all future QoS actions to be performed on this packet. For more information, see the “[Classification](#)” section on page 36-5.
- Policing determines whether a packet is in or out of profile by comparing the rate of the incoming traffic to the configured policer. The policer limits the bandwidth consumed by a flow of traffic. The result is passed to the marker. For more information, see the “[Policing and Marking](#)” section on page 36-8.
- Marking evaluates the policer and configuration information for the action to be taken when a packet is out of profile and determines what to do with the packet (pass through a packet without modification, mark down the QoS label in the packet, or drop the packet). For more information, see the “[Policing and Marking](#)” section on page 36-8.
- Queueing evaluates the QoS label and the corresponding DSCP or CoS value to select into which of the two ingress queues to place a packet. Queueing is enhanced with the weighted tail-drop (WTD) algorithm, a congestion-avoidance mechanism. If the threshold is exceeded, the packet is dropped. For more information, see the “[Queueing and Scheduling Overview](#)” section on page 36-13.
- Scheduling services the queues based on their configured shaped round robin (SRR) weights. One of the ingress queues is the priority queue, and SRR services it for its configured share before servicing the other queue. For more information, see the “[SRR Shaping and Sharing](#)” section on page 36-14.

Actions at the egress port include queueing and scheduling:

- Queueing evaluates the QoS packet label and the corresponding DSCP or CoS value before selecting which of the four egress queues to use. Because congestion can occur when multiple ingress ports simultaneously send data to an egress port, WTD differentiates traffic classes and subjects the packets to different thresholds based on the QoS label. If the threshold is exceeded, the packet is dropped. For more information, see the “[Queueing and Scheduling Overview](#)” section on page 36-13.
- Scheduling services the four egress queues based on their configured SRR shared or shaped weights. One of the queues (queue 1) can be the expedited queue, which is serviced until empty before the other queues are serviced.

**Figure 36-2 Basic QoS Model**

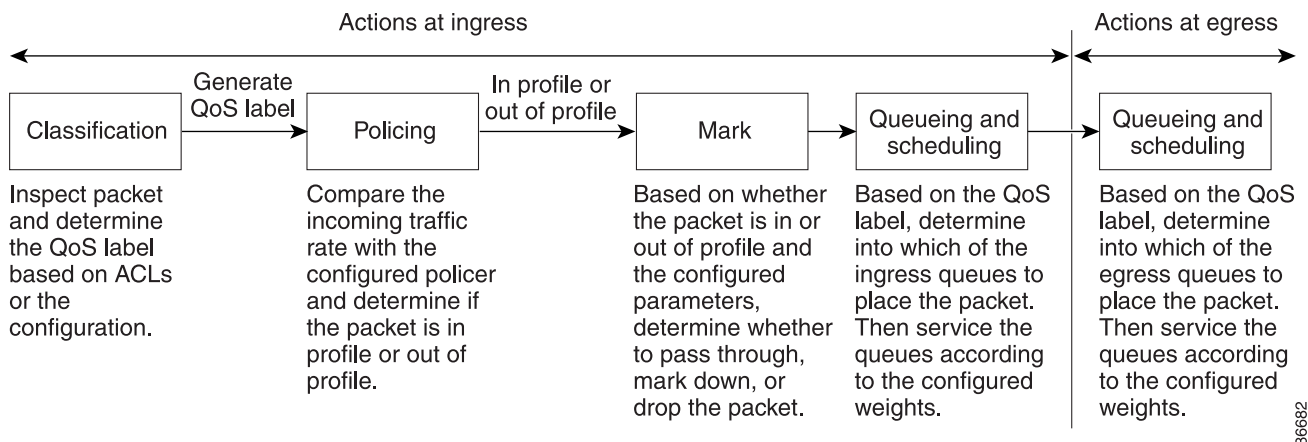

## Classification

Classification is the process of distinguishing one kind of traffic from another by examining the fields in the packet. Classification is enabled only if QoS is globally enabled on the switch. By default, QoS is globally disabled, so no classification occurs.

During classification, the switch performs a lookup and assigns a QoS label to the packet. The QoS label identifies all QoS actions to be performed on the packet and from which queue the packet is sent.

The QoS label is based on the DSCP or the CoS value in the packet and decides the queuing and scheduling actions to perform on the packet. The label is mapped according to the trust setting and the packet type as shown in [Figure 36-3 on page 36-6](#).

You specify which fields in the frame or packet that you want to use to classify incoming traffic. For non-IP traffic, you have these classification options as shown in [Figure 36-3](#):

- Trust the CoS value in the incoming frame (configure the port to trust CoS). Then use the configurable CoS-to-DSCP map to generate a DSCP value for the packet. Layer 2 ISL frame headers carry the CoS value in the 3 least-significant bits of the 1-byte User field. Layer 2 802.1Q frame headers carry the CoS value in the 3 most-significant bits of the Tag Control Information field. CoS values range from 0 for low priority to 7 for high priority.
- Trust the DSCP or trust IP precedence value in the incoming frame. These configurations are meaningless for non-IP traffic. If you configure a port with either of these options and non-IP traffic is received, the switch assigns a CoS value and generates an internal DSCP value from the CoS-to-DSCP map. The switch uses the internal DSCP value to generate a CoS value representing the priority of the traffic.
- Perform the classification based on a configured Layer 2 MAC access control list (ACL), which can examine the MAC source address, the MAC destination address, and other fields. If no ACL is configured, the packet is assigned 0 as the DSCP and CoS values, which means best-effort traffic. Otherwise, the policy-map action specifies a DSCP or CoS value to assign to the incoming frame.

For IP traffic, you have these classification options as shown in [Figure 36-3](#):

- Trust the DSCP value in the incoming packet (configure the port to trust DSCP), and assign the same DSCP value to the packet. The IETF defines the 6 most-significant bits of the 1-byte ToS field as the DSCP. The priority represented by a particular DSCP value is configurable. DSCP values range from 0 to 63.

For ports that are on the boundary between two QoS administrative domains, you can modify the DSCP to another value by using the configurable DSCP-to-DSCP-mutation map.

- Trust the IP precedence value in the incoming packet (configure the port to trust IP precedence), and generate a DSCP value for the packet by using the configurable IP-precedence-to-DSCP map. The IP Version 4 specification defines the 3 most-significant bits of the 1-byte ToS field as the IP precedence. IP precedence values range from 0 for low priority to 7 for high priority.
- Trust the CoS value (if present) in the incoming packet, and generate a DSCP value for the packet by using the CoS-to-DSCP map. If the CoS value is not present, use the default port CoS value.
- Perform the classification based on a configured IP standard or an extended ACL, which examines various fields in the IP header. If no ACL is configured, the packet is assigned 0 as the DSCP and CoS values, which means best-effort traffic. Otherwise, the policy-map action specifies a DSCP or CoS value to assign to the incoming frame.

For information on the maps described in this section, see the [“Mapping Tables” section on page 36-12](#). For configuration information on port trust states, see the [“Configuring Classification Using Port Trust States” section on page 36-35](#).

After classification, the packet is sent to the policing, marking, and the ingress queuing and scheduling stages.

Figure 36-3 Classification Flowchart

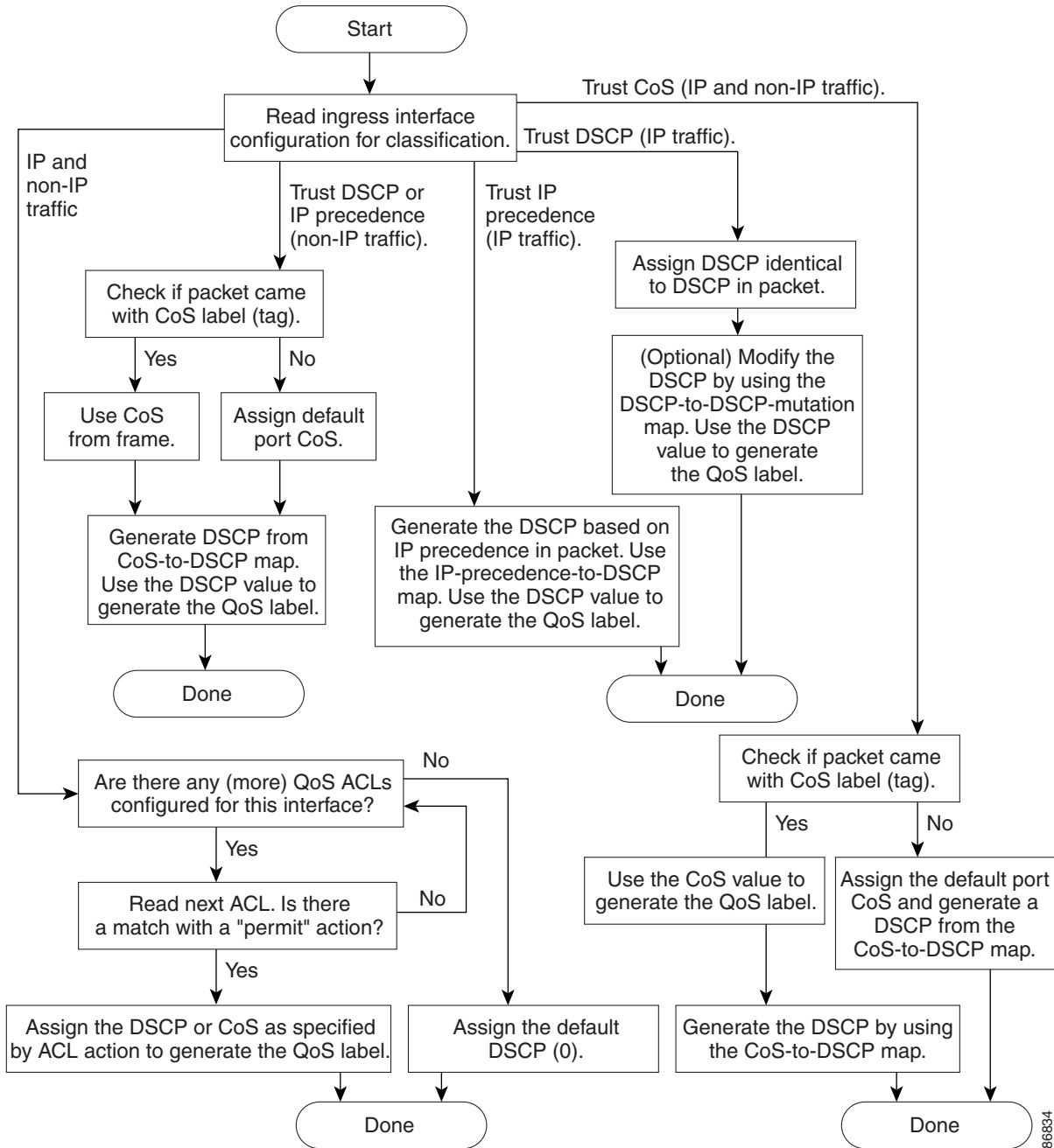

86634

## Classification Based on QoS ACLs

You can use IP standard, IP extended, or Layer 2 MAC ACLs to define a group of packets with the same characteristics (*class*). In the QoS context, the permit and deny actions in the access control entries (ACEs) have different meanings than with security ACLs:

- If a match with a permit action is encountered (first-match principle), the specified QoS-related action is taken.
- If a match with a deny action is encountered, the ACL being processed is skipped, and the next ACL is processed.
- If no match with a permit action is encountered and all the ACEs have been examined, no QoS processing occurs on the packet, and the switch offers best-effort service to the packet.
- If multiple ACLs are configured on a port, the lookup stops after the packet matches the first ACL with a permit action, and QoS processing begins.



### Note

---

When creating an access list, remember that, by default, the end of the access list contains an implicit deny statement for everything if it did not find a match before reaching the end.

---

After a traffic class has been defined with the ACL, you can attach a policy to it. A policy might contain multiple classes with actions specified for each one of them. A policy might include commands to classify the class as a particular aggregate (for example, assign a DSCP) or rate-limit the class. This policy is then attached to a particular port on which it becomes effective.

You implement IP ACLs to classify IP traffic by using the **access-list** global configuration command; you implement Layer 2 MAC ACLs to classify non-IP traffic by using the **mac access-list extended** global configuration command. For configuration information, see the [“Configuring a QoS Policy” section on page 36-42](#).

## Classification Based on Class Maps and Policy Maps

A class map is a mechanism that you use to name a specific traffic flow (or class) and to isolate it from all other traffic. The class map defines the criteria used to match against a specific traffic flow to further classify it. The criteria can include matching the access group defined by the ACL or matching a specific list of DSCP or IP precedence values. If you have more than one type of traffic that you want to classify, you can create another class map and use a different name. After a packet is matched against the class-map criteria, you further classify it through the use of a policy map.

A policy map specifies which traffic class to act on. Actions can include trusting the CoS, DSCP, or IP precedence values in the traffic class; setting a specific DSCP or IP precedence value in the traffic class; or specifying the traffic bandwidth limitations and the action to take when the traffic is out of profile. Before a policy map can be effective, you must attach it to a port.

You create a class map by using the **class-map** global configuration command or the **class** policy-map configuration command. You should use the **class-map** command when the map is shared among many ports. When you enter the **class-map** command, the switch enters the class-map configuration mode. In this mode, you define the match criterion for the traffic by using the **match** class-map configuration command.

You create and name a policy map by using the **policy-map** global configuration command. When you enter this command, the switch enters the policy-map configuration mode. In this mode, you specify the actions to take on a specific traffic class by using the **class**, **trust**, or **set** policy-map configuration and policy-map class configuration commands.

The policy map can contain the **police** and **police aggregate** policy-map class configuration commands, which define the policer, the bandwidth limitations of the traffic, and the action to take if the limits are exceeded.

To enable the policy map, you attach it to a port by using the **service-policy** interface configuration command.

You can apply a nonhierarchical policy map to a physical port or an SVI. However, a hierarchical policy map can only be applied to an SVI. A hierarchical policy map contains two levels. The first level, the VLAN level, specifies the actions to be taken against a traffic flow on the SVI. The second level, the interface level, specifies the actions to be taken against the traffic on the physical ports that belong to the SVI. The interface-level actions are specified in the interface-level policy map.

For more information, see the [“Policing and Marking” section on page 36-8](#). For configuration information, see the [“Configuring a QoS Policy” section on page 36-42](#).

## Policing and Marking

After a packet is classified and has a DSCP-based or CoS-based QoS label assigned to it, the policing and marking process can begin as shown in [Figure 36-4](#).

Policing involves creating a policer that specifies the bandwidth limits for the traffic. Packets that exceed the limits are *out of profile* or *nonconforming*. Each policer decides on a packet-by-packet basis whether the packet is in or out of profile and specifies the actions on the packet. These actions, carried out by the marker, include passing through the packet without modification, dropping the packet, or modifying (marking down) the assigned DSCP of the packet and allowing the packet to pass through. The configurable policed-DSCP map provides the packet with a new DSCP-based QoS label. For information on the policed-DSCP map, see the [“Mapping Tables” section on page 36-12](#). Marked-down packets use the same queues as the original QoS label to prevent packets in a flow from getting out of order.



### Note

---

All traffic, regardless of whether it is bridged or routed, is subjected to a policer, if one is configured. As a result, bridged packets might be dropped or might have their DSCP or CoS fields modified when they are policed and marked.

---

You can configure policing on a physical port or an SVI. For more information about configuring policing on physical ports, see the [“Policing on Physical Ports” section on page 36-9](#). When configuring policy maps on an SVI, you can create a hierarchical policy map and can define an individual policer only in the secondary interface-level policy map. For more information, see the [“Policing on SVIs” section on page 36-10](#).

After you configure the policy map and policing actions, attach the policy to an ingress port or SVI by using the **service-policy** interface configuration command. For configuration information, see the [“Classifying, Policing, and Marking Traffic on Physical Ports by Using Policy Maps” section on page 36-48](#), the [“Classifying, Policing, and Marking Traffic on SVIs by Using Hierarchical Policy Maps” section on page 36-52](#), and the [“Classifying, Policing, and Marking Traffic by Using Aggregate Policers” section on page 36-58](#).



## Policing on Physical Ports

In policy maps on physical ports, you can create these types of policers:

- Individual—QoS applies the bandwidth limits specified in the policer separately to each matched traffic class. You configure this type of policer within a policy map by using the **police** policy-map class configuration command.
- Aggregate—QoS applies the bandwidth limits specified in an aggregate policer cumulatively to all matched traffic flows. You configure this type of policer by specifying the aggregate policer name within a policy map by using the **police aggregate** policy-map class configuration command. You specify the bandwidth limits of the policer by using the **mls qos aggregate-policer** global configuration command. In this way, the aggregate policer is shared by multiple classes of traffic within a policy map.

Policing uses a token-bucket algorithm. As each frame is received by the switch, a token is added to the bucket. The bucket has a hole in it and leaks at a rate that you specify as the average traffic rate in bits per second. Each time a token is added to the bucket, the switch verifies that there is enough room in the bucket. If there is not enough room, the packet is marked as nonconforming, and the specified policer action is taken (dropped or marked down).

How quickly the bucket fills is a function of the bucket depth (burst-byte), the rate at which the tokens are removed (rate-bps), and the duration of the burst above the average rate. The size of the bucket imposes an upper limit on the burst length and limits the number of frames that can be transmitted back-to-back. If the burst is short, the bucket does not overflow, and no action is taken against the traffic flow. However, if a burst is long and at a higher rate, the bucket overflows, and the policing actions are taken against the frames in that burst.

You configure the bucket depth (the maximum burst that is tolerated before the bucket overflows) by using the *burst-byte* option of the **police** policy-map class configuration command or the **mls qos aggregate-policer** global configuration command. You configure how fast (the average rate) that the tokens are removed from the bucket by using the *rate-bps* option of the **police** policy-map class configuration command or the **mls qos aggregate-policer** global configuration command.

Figure 36-4 shows the policing and marking process when these types of policy maps are configured:

- A nonhierarchical policy map on a physical port.
- The interface level of a hierarchical policy map attached to an SVI. The physical ports are specified in this secondary policy map.

**Figure 36-4 Policing and Marking Flowchart on Physical Ports**

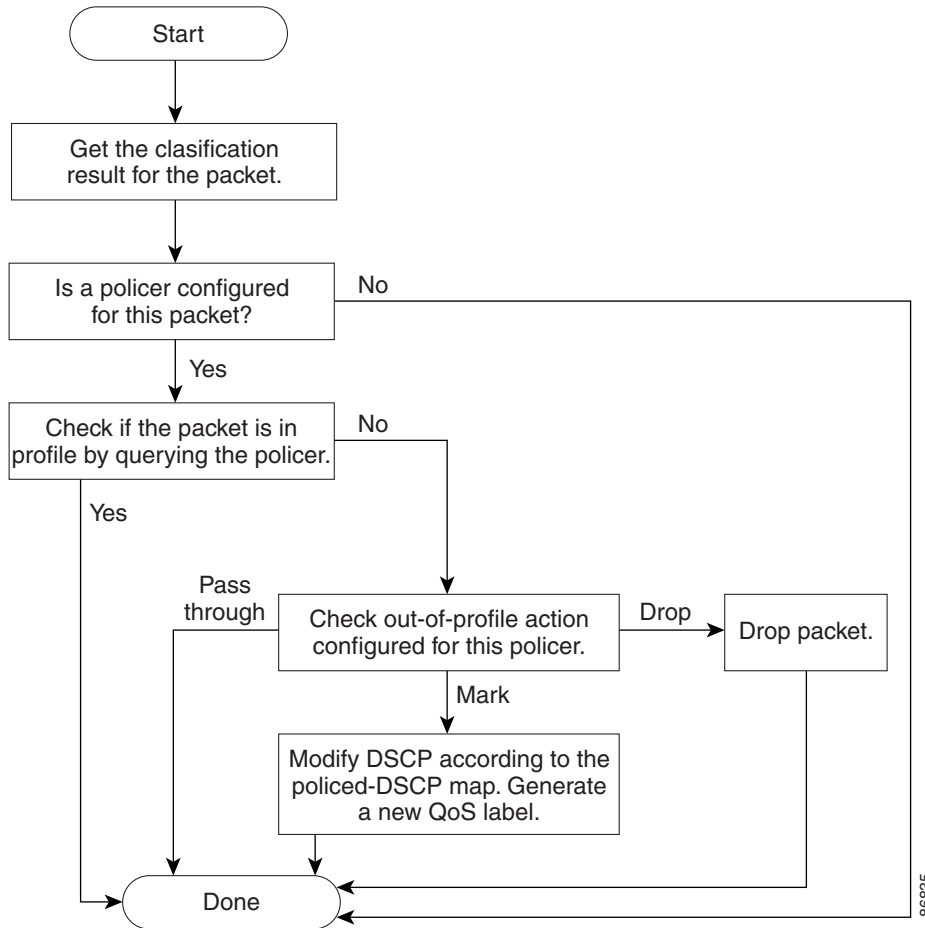

## Policing on SVIs



**Note**

Before configuring a hierarchical policy map with individual policers on an SVI, you must enable VLAN-based QoS on the physical ports that belong to the SVI. Though a policy map is attached to the SVI, the individual policers only affect traffic on the physical ports specified in the secondary interface level of the hierarchical policy map.

A hierarchical policy map has two levels. The first level, the VLAN level, specifies the actions to be taken against a traffic flow on an SVI. The second level, the interface level, specifies the actions to be taken against the traffic on the physical ports that belong to the SVI and are specified in the interface-level policy map.

When configuring policing on an SVI, you can create and configure a hierarchical policy map with these two levels:

- VLAN level—Create this primary level by configuring class maps and classes that specify the port trust state or set a new DSCP or IP precedence value in the packet. The VLAN-level policy map applies only to the VLAN in an SVI and does not support policers.
- Interface level—Create this secondary level by configuring class maps and classes that specify the individual policers on physical ports that belong to the SVI. The interface-level policy map only supports individual policers and does not support aggregate policers. You can configure different interface-level policy maps for each class defined in the VLAN-level policy map.

See the “[Classifying, Policing, and Marking Traffic on SVIs by Using Hierarchical Policy Maps](#)” section on page 36-52 for an example of a hierarchical policy map.

Figure 36-5 shows the policing and marking process when hierarchical policy maps on an SVI.

**Figure 36-5** Policing and Marking Flowchart on SVIs

## Mapping Tables

During QoS processing, the switch represents the priority of all traffic (including non-IP traffic) with an QoS label based on the DSCP or CoS value from the classification stage:

- During classification, QoS uses configurable mapping tables to derive a corresponding DSCP or CoS value from a received CoS, DSCP, or IP precedence value. These maps include the CoS-to-DSCP map and the IP-precedence-to-DSCP map. You configure these maps by using the **mls qos map cos-dscp** and the **mls qos map ip-prec-dscp** global configuration commands.

On an ingress port configured in the DSCP-trusted state, if the DSCP values are different between the QoS domains, you can apply the configurable DSCP-to-DSCP-mutation map to the port that is on the boundary between the two QoS domains. You configure this map by using the **mls qos map dscp-mutation** global configuration command.

- During policing, QoS can assign another DSCP value to an IP or a non-IP packet (if the packet is out of profile and the policer specifies a marked-down value). This configurable map is called the policed-DSCP map. You configure this map by using the **mls qos map policed-dscp** global configuration command.
- Before the traffic reaches the scheduling stage, QoS stores the packet in an ingress and an egress queue according to the QoS label. The QoS label is based on the DSCP or the CoS value in the packet and selects the queue through the DSCP input and output queue threshold maps or through the CoS input and output queue threshold maps. In addition to an ingress or an egress queue, the QoS label also identifies the WTD threshold value. You configure these maps by using the **mls qos srr-queue {input | output} dscp-map** and the **mls qos srr-queue {input | output} cos-map** global configuration commands.

The CoS-to-DSCP, DSCP-to-CoS, and the IP-precedence-to-DSCP maps have default values that might or might not be appropriate for your network.

The default DSCP-to-DSCP-mutation map and the default policed-DSCP map are null maps; they map an incoming DSCP value to the same DSCP value. The DSCP-to-DSCP-mutation map is the only map you apply to a specific port. All other maps apply to the entire switch.

For configuration information, see the [“Configuring DSCP Maps” section on page 36-60](#).

For information about the DSCP and CoS input queue threshold maps, see the [“Queueing and Scheduling on Ingress Queues” section on page 36-15](#). For information about the DSCP and CoS output queue threshold maps, see the [“Queueing and Scheduling on Egress Queues” section on page 36-17](#).

## Queueing and Scheduling Overview

The switch has queues at specific points to help prevent congestion as shown in [Figure 36-6](#).

**Figure 36-6** Ingress and Egress Queue Location

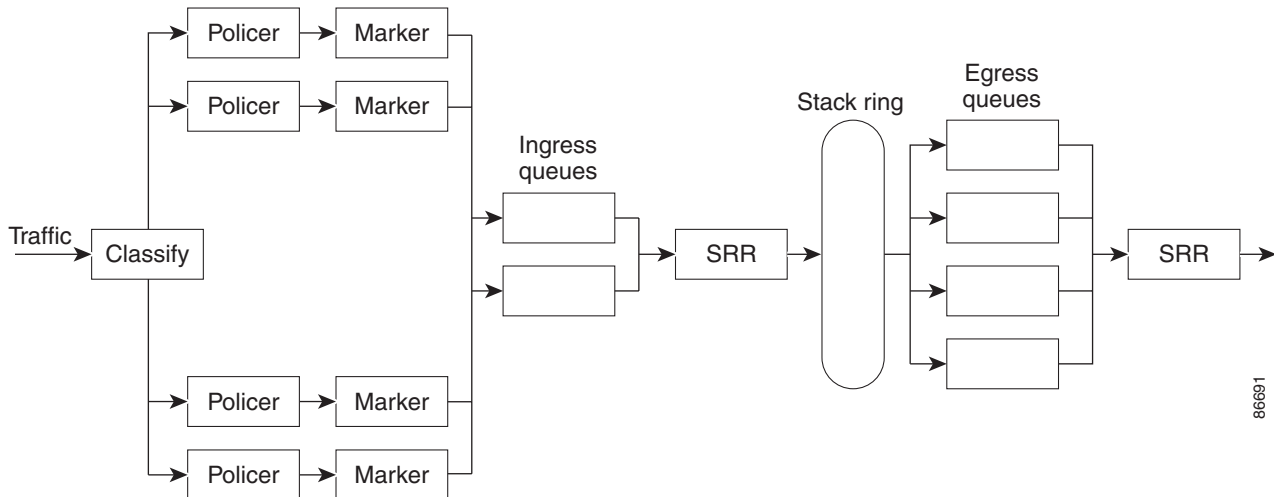

Because the total inbound bandwidth of all ports can exceed the bandwidth of the stack or internal ring, ingress queues are located after the packet is classified, policed, and marked and before packets are forwarded into the switch fabric. Because multiple ingress ports can simultaneously send packets to an egress port and cause congestion, outbound queues are located after the stack or internal ring.

## Weighted Tail Drop

Both the ingress and egress queues use an enhanced version of the tail-drop congestion-avoidance mechanism called weighted tail drop (WTD). WTD is implemented on queues to manage the queue lengths and to provide drop precedences for different traffic classifications.

As a frame is enqueued to a particular queue, WTD uses the frame's assigned QoS label to subject it to different thresholds. If the threshold is exceeded for that QoS label (the space available in the destination queue is less than the size of the frame), the switch drops the frame.

Each queue has three threshold values. The QoS label determines which of the three threshold values is subjected to the frame. Of the three thresholds, two are configurable (explicit) and one is not (implicit).

[Figure 36-7](#) shows an example of WTD operating on a queue whose size is 1000 frames. Three drop percentages are configured: 40 percent (400 frames), 60 percent (600 frames), and 100 percent (1000 frames). These percentages mean that up to 400 frames can be queued at the 40-percent threshold, up to 600 frames at the 60-percent threshold, and up to 1000 frames at the 100-percent threshold.

In this example, CoS values 6 and 7 have a greater importance than the other CoS values, and they are assigned to the 100-percent drop threshold (queue-full state). CoS values 4 and 5 are assigned to the 60-percent threshold, and CoS values 0 to 3 are assigned to the 40-percent threshold.

Suppose the queue is already filled with 600 frames, and a new frame arrives. It contains CoS values 4 and 5 and is subjected to the 60-percent threshold. If this frame is added to the queue, the threshold will be exceeded, so the switch drops it.

**Figure 36-7 WTD and Queue Operation**

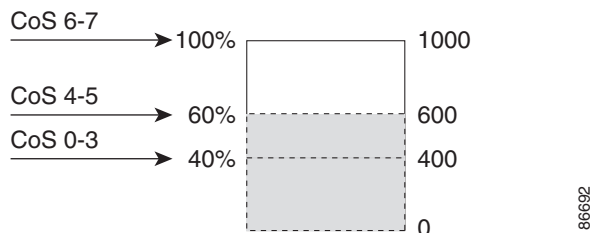

For more information, see the [“Mapping DSCP or CoS Values to an Ingress Queue and Setting WTD Thresholds”](#) section on page 36-67, the [“Allocating Buffer Space to and Setting WTD Thresholds for an Egress Queue-Set”](#) section on page 36-71, and the [“Mapping DSCP or CoS Values to an Egress Queue and to a Threshold ID”](#) section on page 36-73.

## SRR Shaping and Sharing

Both the ingress and egress queues are serviced by SRR, which controls the rate at which packets are sent. On the ingress queues, SRR sends packets to the stack or internal ring. On the egress queues, SRR sends packets to the egress port.

You can configure SRR on egress queues for sharing or for shaping. However, for ingress queues, sharing is the default mode, and it is the only mode supported.

In shaped mode, the egress queues are guaranteed a percentage of the bandwidth, and they are rate-limited to that amount. Shaped traffic does not use more than the allocated bandwidth even if the link is idle. Shaping provides a more even flow of traffic over time and reduces the peaks and valleys of bursty traffic. With shaping, the absolute value of each weight is used to compute the bandwidth available for the queues.

In shared mode, the queues share the bandwidth among them according to the configured weights. The bandwidth is guaranteed at this level but not limited to it. For example, if a queue is empty and no longer requires a share of the link, the remaining queues can expand into the unused bandwidth and share it among them. With sharing, the ratio of the weights controls the frequency of dequeuing; the absolute values are meaningless. Shaping and sharing is configured per interface. Each interface can be uniquely configured.

For more information, see the [“Allocating Bandwidth Between the Ingress Queues”](#) section on page 36-68, the [“Configuring SRR Shaped Weights on Egress Queues”](#) section on page 36-75, and the [“Configuring SRR Shared Weights on Egress Queues”](#) section on page 36-76.

## Queueing and Scheduling on Ingress Queues

Figure 36-8 shows the queueing and scheduling flowchart for ingress ports.

**Figure 36-8** Queueing and Scheduling Flowchart for Ingress Ports

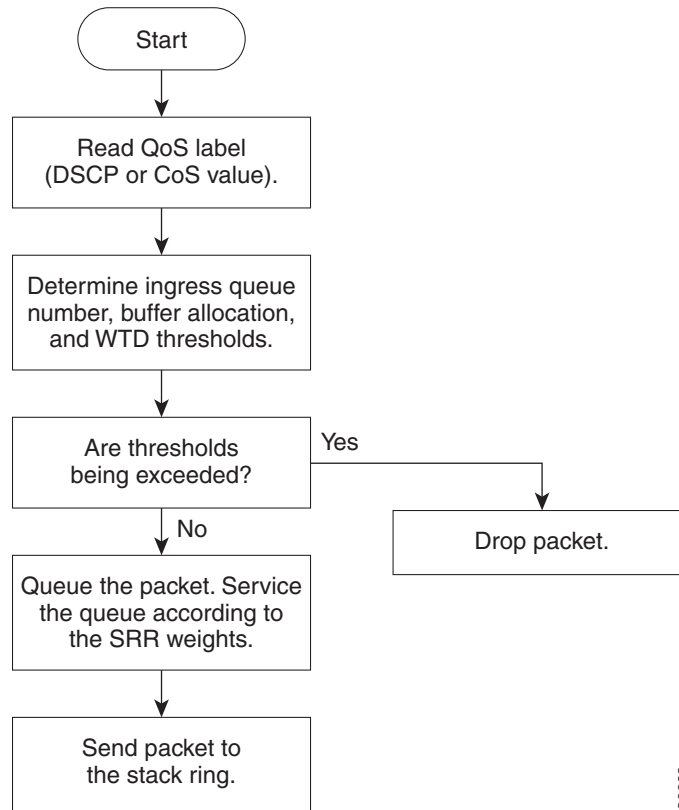

**Note**

SRR services the priority queue for its configured share before servicing the other queue.

The switch supports two configurable ingress queues, which are serviced by SRR in shared mode only. Table 36-1 describes the queues.

**Table 36-1** Ingress Queue Types

Queue Type <sup>1</sup>	Function
Normal	User traffic that is considered to be normal priority. You can configure three different thresholds to differentiate among the flows. You can use the <b>mls qos srr-queue input threshold</b> , the <b>mls qos srr-queue input dscp-map</b> , and the <b>mls qos srr-queue input cos-map</b> global configuration commands.
Expedite	High-priority user traffic such as differentiated services (DF) expedited forwarding or voice traffic. You can configure the bandwidth required for this traffic as a percentage of the total traffic or total stack traffic by using the <b>mls qos srr-queue input priority-queue</b> global configuration command. The expedite queue has guaranteed bandwidth.

1. The switch uses two nonconfigurable queues for traffic that is essential for proper network and stack operation.

You assign each packet that flows through the switch to a queue and to a threshold. Specifically, you map DSCP or CoS values to an ingress queue and map DSCP or CoS values to a threshold ID. You use the **mls qos srr-queue input dscp-map queue** *queue-id* {*dscp1...dscp8* | **threshold** *threshold-id* *dscp1...dscp8*} or the **mls qos srr-queue input cos-map queue** *queue-id* {*cos1...cos8* | **threshold** *threshold-id* *cos1...cos8*} global configuration command. You can display the DSCP input queue threshold map and the CoS input queue threshold map by using the **show mls qos maps** privileged EXEC command.

## WTD Thresholds

The queues use WTD to support distinct drop percentages for different traffic classes. Each queue has three drop thresholds: two configurable (*explicit*) WTD thresholds and one nonconfigurable (*implicit*) threshold preset to the queue-full state. You assign the two explicit WTD threshold percentages for threshold ID 1 and ID 2 to the ingress queues by using the **mls qos srr-queue input threshold** *queue-id* *threshold-percentage1* *threshold-percentage2* global configuration command. Each threshold value is a percentage of the total number of allocated buffers for the queue. The drop threshold for threshold ID 3 is preset to the queue-full state, and you cannot modify it. For more information about how WTD works, see the “[Weighted Tail Drop](#)” section on page 36-13.

## Buffer and Bandwidth Allocation

You define the ratio (allocate the amount of space) with which to divide the ingress buffers between the two queues by using the **mls qos srr-queue input buffers** *percentage1* *percentage2* global configuration command. The buffer allocation together with the bandwidth allocation control how much data can be buffered and sent before packets are dropped. You allocate bandwidth as a percentage by using the **mls qos srr-queue input bandwidth** *weight1* *weight2* global configuration command. The ratio of the weights is the ratio of the frequency in which the SRR scheduler sends packets from each queue.

## Priority Queueing

You can configure one ingress queue as the priority queue by using the **mls qos srr-queue input priority-queue** *queue-id* **bandwidth** *weight* global configuration command. The priority queue should be used for traffic (such as voice) that requires guaranteed delivery because this queue is guaranteed part of the bandwidth regardless of the load on the stack or internal ring.

SRR services the priority queue for its configured weight as specified by the **bandwidth** keyword in the **mls qos srr-queue input priority-queue** *queue-id* **bandwidth** *weight* global configuration command. Then, SRR shares the remaining bandwidth with both ingress queues and services them as specified by the weights configured with the **mls qos srr-queue input bandwidth** *weight1* *weight2* global configuration command.

You can combine the commands described in this section to prioritize traffic by placing packets with particular DSCPs or CoSs into certain queues, by allocating a large queue size or by servicing the queue more frequently, and by adjusting queue thresholds so that packets with lower priorities are dropped. For configuration information, see the “[Configuring Ingress Queue Characteristics](#)” section on page 36-66.



## Queueing and Scheduling on Egress Queues

Figure 36-9 shows the queueing and scheduling flowchart for egress ports.



### Note

If the expedite queue is enabled, SRR services it until it is empty before servicing the other three queues.

**Figure 36-9** Queueing and Scheduling Flowchart for Egress Ports

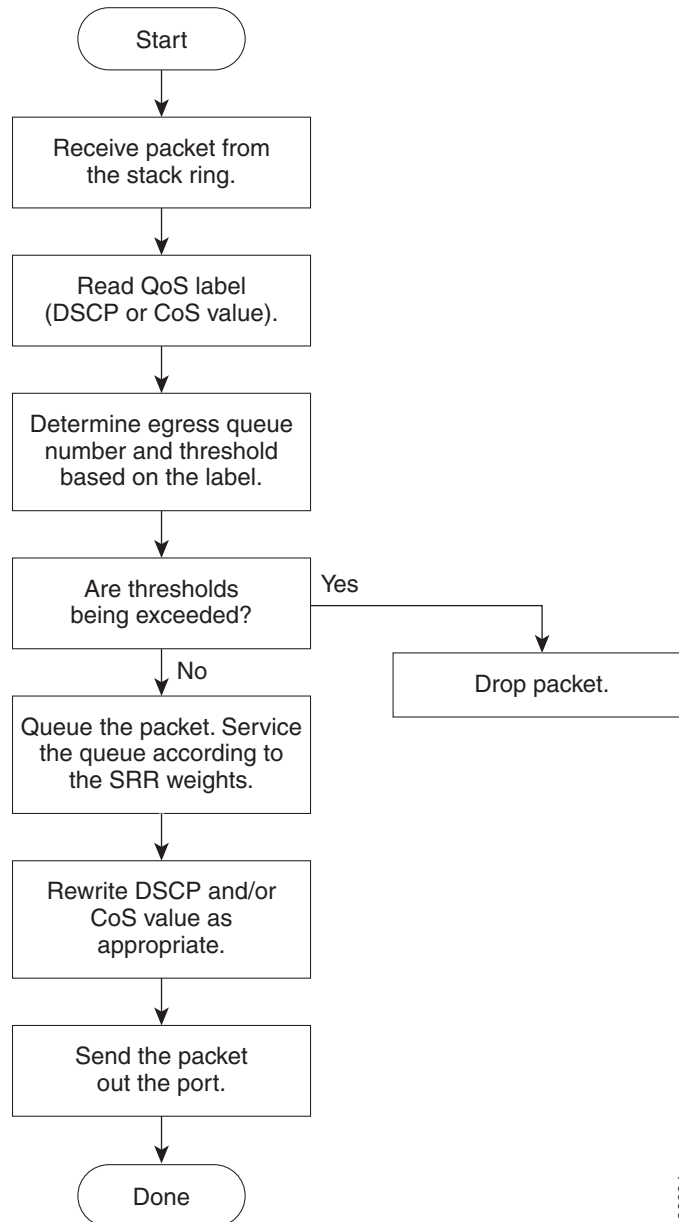

86694

Each port supports four egress queues, one of which (queue 1) can be the egress expedite queue. These queues are configured by a queue-set. All traffic leaving an egress port flows through one of these four queues and is subjected to a threshold based on the QoS label assigned to the packet.

These queues are assigned to a queue-set. All traffic exiting the switch flows through one of these four queues and is subjected to a threshold based on the QoS label assigned to the packet.

Figure 36-10 shows the egress queue buffer. The buffer space is divided between the common pool and the reserved pool. The switch uses a buffer allocation scheme to reserve a minimum amount of buffers for each egress queue, to prevent any queue or port from consuming all the buffers and depriving other queues, and to control whether to grant buffer space to a requesting queue. The switch detects whether the target queue has not consumed more buffers than its reserved amount (under-limit), whether it has consumed all of its maximum buffers (over limit), and whether the common pool is empty (no free buffers) or not empty (free buffers). If the queue is not over-limit, the switch can allocate buffer space from the reserved pool or from the common pool (if it is not empty). If there are no free buffers in the common pool or if the queue is over-limit, the switch drops the frame.

**Figure 36-10 Egress Queue Buffer Allocation**

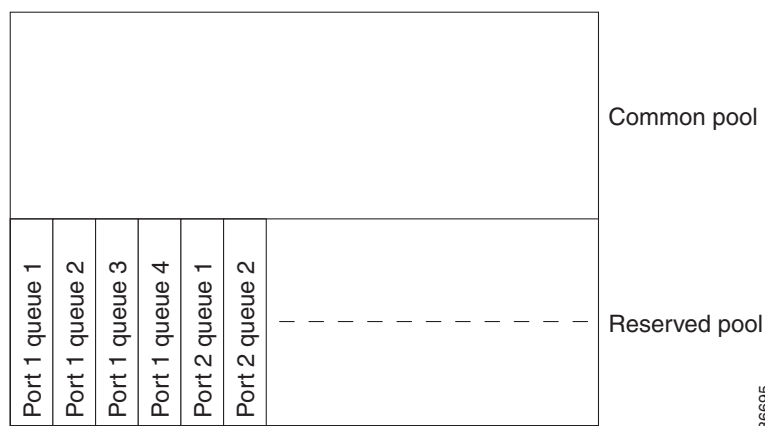

## Buffer and Memory Allocation

You guarantee the availability of buffers, set drop thresholds, and configure the maximum memory allocation for a queue-set by using the **mls qos queue-set output *qset-id* threshold *queue-id* drop-threshold1 drop-threshold2 reserved-threshold maximum-threshold** global configuration command. Each threshold value is a percentage of the queue's allocated memory, which you specify by using the **mls qos queue-set output *qset-id* buffers allocation1 ... allocation4** global configuration command. The sum of all the allocated buffers represents the reserved pool, and the remaining buffers are part of the common pool.

Through buffer allocation, you can ensure that high-priority traffic is buffered. For example, if the buffer space is 400, you can allocate 70 percent of it to queue 1 and 10 percent to queues 2 through 4. Queue 1 then has 280 buffers allocated to it, and queues 2 through 4 each have 40 buffers allocated to them.

You can guarantee that the allocated buffers are reserved for a specific queue in a queue-set. For example, if there are 100 buffers for a queue, you can reserve 50 percent (50 buffers). The switch returns the remaining 50 buffers to the common pool. You also can enable a queue in the full condition to obtain more buffers than are reserved for it by setting a maximum threshold. The switch can allocate the needed buffers from the common pool if the common pool is not empty.

## WTD Thresholds

You can assign each packet that flows through the switch to a queue and to a threshold. Specifically, you map DSCP or CoS values to an egress queue and map DSCP or CoS values to a threshold ID. You use the **mls qos srr-queue output dscp-map queue** *queue-id* {*dscp1...dscp8* | **threshold** *threshold-id* *dscp1...dscp8*} or the **mls qos srr-queue output cos-map queue** *queue-id* {*cos1...cos8* | **threshold** *threshold-id* *cos1...cos8*} global configuration command. You can display the DSCP output queue threshold map and the CoS output queue threshold map by using the **show mls qos maps** privileged EXEC command.

The queues use WTD to support distinct drop percentages for different traffic classes. Each queue has three drop thresholds: two configurable (*explicit*) WTD thresholds and one nonconfigurable (*implicit*) threshold preset to the queue-full state. You assign the two WTD threshold percentages for threshold ID 1 and ID 2. The drop threshold for threshold ID 3 is preset to the queue-full state, and you cannot modify it. For more information about how WTD works, see the [“Weighted Tail Drop” section on page 36-13](#).

## Shaped or Shared Mode

SRR services each queue-set in shared or shaped mode. You map a port to a queue-set by using the **queue-set** *qset-id* interface configuration command. You assign shared or shaped weights to the port by using the **srr-queue bandwidth share** *weight1 weight2 weight3 weight4* or the **srr-queue bandwidth shape** *weight1 weight2 weight3 weight4* interface configuration command. For an explanation of the differences between shaping and sharing, see the [“SRR Shaping and Sharing” section on page 36-14](#).

The buffer allocation together with the SRR weight ratios control how much data can be buffered and sent before packets are dropped. The weight ratio is the ratio of the frequency in which the SRR scheduler sends packets from each queue.

All four queues participate in the SRR unless the expedite queue is enabled, in which case the first bandwidth weight is ignored and is not used in the ratio calculation. The expedite queue is a priority queue, and it is serviced until empty before the other queues are serviced. You enable the expedite queue by using the **priority-queue out** interface configuration command.

You can combine the commands described in this section to prioritize traffic by placing packets with particular DSCPs or CoSs into certain queues, by allocating a large queue size or by servicing the queue more frequently, and by adjusting queue thresholds so that packets with lower priorities are dropped. For configuration information, see the [“Configuring Egress Queue Characteristics” section on page 36-70](#).



### Note

The egress queue default settings are suitable for most situations. You should change them only when you have a thorough understanding of the egress queues and if these settings do not meet your QoS solution.

## Packet Modification

A packet is classified, policed, and queued to provide QoS. Packet modifications can occur during this process:

- For IP and non-IP packets, classification involves assigning a QoS label to a packet based on the DSCP or CoS of the received packet. However, the packet is not modified at this stage; only an indication of the assigned DSCP or CoS value is carried along. The reason for this is that QoS classification and forwarding lookups occur in parallel, and it is possible that the packet is forwarded with its original DSCP to the CPU where it is again processed through software.

- During policing, IP and non-IP packets can have another DSCP assigned to them (if they are out of profile and the policer specifies a markdown DSCP). Once again, the DSCP in the packet is not modified, but an indication of the marked-down value is carried along. For IP packets, the packet modification occurs at a later stage; for non-IP packets the DSCP is converted to CoS and used for queueing and scheduling decisions.
- Depending on the QoS label assigned to a frame and the mutation chosen, the DSCP and CoS values of the frame are rewritten. If you do not configure the mutation map and if you configure the port to trust the DSCP of the incoming frame, the DSCP value in the frame is not changed, but the CoS is rewritten according to the DSCP-to-CoS map. If you configure the port to trust the CoS of the incoming frame and it is an IP packet, the CoS value in the frame is not changed, but the DSCP might be changed according to the CoS-to-DSCP map.

The input mutation causes the DSCP to be rewritten depending on the new value of DSCP chosen. The set action in a policy map also causes the DSCP to be rewritten.

## Configuring Auto-QoS

You can use the auto-QoS feature to simplify the deployment of existing QoS features. Auto-QoS makes assumptions about the network design, and as a result, the switch can prioritize different traffic flows and appropriately use the ingress and egress queues instead of using the default QoS behavior. (The default is that QoS is disabled. The switch then offers best-effort service to each packet, regardless of the packet contents or size, and sends it from a single queue.)

When you enable auto-QoS, it automatically classifies traffic based on the traffic type and ingress packet label. The switch uses the resulting classification to choose the appropriate egress queue.

You use auto-QoS commands to identify ports connected to Cisco IP Phones and to devices running the Cisco SoftPhone application. You also use the commands to identify ports that receive trusted traffic through an uplink. Auto-QoS then performs these functions:

- Detects the presence or absence of Cisco IP Phones
- Configures QoS classification
- Configures egress queues

These sections contain this configuration information:

- [Generated Auto-QoS Configuration, page 36-21](#)
- [Effects of Auto-QoS on the Configuration, page 36-25](#)
- [Auto-QoS Configuration Guidelines, page 36-25](#)
- [Enabling Auto-QoS for VoIP, page 36-26](#)
- [Auto-QoS Configuration Example, page 36-27](#)

## Generated Auto-QoS Configuration

By default, auto-QoS is disabled on all ports.

When auto-QoS is enabled, it uses the ingress packet label to categorize traffic, to assign packet labels, and to configure the ingress and egress queues as shown in [Table 36-2](#).

**Table 36-2** Traffic Types, Packet Labels, and Queues

	VoIP <sup>1</sup> Data Traffic	VoIP Control Traffic	Routing Protocol Traffic	STP BPDU Traffic	Real-Time Video Traffic	All Other Traffic
DSCP	46	24, 26	48	56	34	–
CoS	5	3	6	7	4	–
CoS-to-Ingress Queue Map	2, 3, 4, 5, 6, 7 (queue 2)					0, 1 (queue 1)
CoS-to-Egress Queue Map	5 (queue 1)	3, 6, 7 (queue 2)			4 (queue 3)	2 (queue 3) 0, 1 (queue 4)

1. VoIP = voice over IP

[Table 36-3](#) shows the generated auto-QoS configuration for the ingress queues.

**Table 36-3** Auto-QoS Configuration for the Ingress Queues

Ingress Queue	Queue Number	CoS-to-Queue Map	Queue Weight (Bandwidth)	Queue (Buffer) Size
SRR shared	1	0, 1	81 percent	67 percent
Priority	2	2, 3, 4, 5, 6, 7	19 percent	33 percent

[Table 36-4](#) shows the generated auto-QoS configuration for the egress queues.

**Table 36-4** Auto-QoS Configuration for the Egress Queues

Egress Queue	Queue Number	CoS-to-Queue Map	Queue Weight (Bandwidth)	Queue (Buffer) Size for Gigabit-Capable Ports	Queue (Buffer) Size for 10/100 Ethernet Ports
SRR shared	2	3, 6, 7	10 percent	6 percent	10 percent
SRR shared	3	2, 4	60 percent	17 percent	26 percent
SRR shared	4	0, 1	20 percent	61 percent	54 percent

When you enable the auto-QoS feature on the first port, these automatic actions occur:

- QoS is globally enabled (**mls qos** global configuration command), and other global configuration commands are added.
- When you enter the **auto qos voip cisco-softphone** interface configuration command on a port at the edge of the network that is connected to a device running the Cisco SoftPhone, the switch uses policing to determine whether a packet is in or out of profile and to specify the action on the packet.

If the packet does not have a DSCP value of 24, 26, or 46 or is out of profile, the switch changes the DSCP value to 0. The switch configures ingress and egress queues on the port according to the settings in [Table 36-3](#) and [Table 36-4](#).

- When you enter the **auto qos voip trust** interface configuration command on a port connected to the interior of the network, the switch trusts the CoS value for nonrouted ports or the DSCP value for routed ports in ingress packets (the assumption is that traffic has already been classified by other edge devices). The switch configures the ingress and egress queues on the port according to the settings in [Table 36-3](#) and [Table 36-4](#).

For information about the trusted boundary feature, see the “[Configuring a Trusted Boundary to Ensure Port Security](#)” section on page 36-38.

When you enable auto-QoS by using the **auto qos voip cisco-phone**, the **auto qos voip cisco-softphone**, or the **auto qos voip trust** interface configuration command, the switch automatically generates a QoS configuration based on the traffic type and ingress packet label and applies the commands listed in [Table 36-5](#) to the port.

**Table 36-5** Generated Auto-QoS Configuration

Description	Automatically Generated Command
The switch automatically enables standard QoS and configures the CoS-to-DSCP map (maps CoS values in incoming packets to a DSCP value).	<pre>Switch(config)# mls qos Switch(config)# mls qos map cos-dscp 0 8 16 26 32 46 48 56</pre>
The switch automatically maps CoS values to an ingress queue and to a threshold ID.	<pre>Switch(config)# no mls qos srr-queue input cos-map Switch(config)# mls qos srr-queue input cos-map queue 1 threshold 3 0 Switch(config)# mls qos srr-queue input cos-map queue 1 threshold 2 1 Switch(config)# mls qos srr-queue input cos-map queue 2 threshold 1 2 Switch(config)# mls qos srr-queue input cos-map queue 2 threshold 2 4 6 7 Switch(config)# mls qos srr-queue input cos-map queue 2 threshold 3 3 5</pre>
The switch automatically maps CoS values to an egress queue and to a threshold ID.	<pre>Switch(config)# no mls qos srr-queue output cos-map Switch(config)# mls qos srr-queue output cos-map queue 1 threshold 3 5 Switch(config)# mls qos srr-queue output cos-map queue 2 threshold 3 3 6 7 Switch(config)# mls qos srr-queue output cos-map queue 3 threshold 3 2 4 Switch(config)# mls qos srr-queue output cos-map queue 4 threshold 2 1 Switch(config)# mls qos srr-queue output cos-map queue 4 threshold 3 0</pre>

Table 36-5 Generated Auto-QoS Configuration (continued)

Description	Automatically Generated Command
The switch automatically maps DSCP values to an ingress queue and to a threshold ID.	<pre>Switch(config)# no mls qos srr-queue input dscp-map Switch(config)# mls qos srr-queue input dscp-map queue 1 threshold 2 9 10 11 12 13 14 15 Switch(config)# mls qos srr-queue input dscp-map queue 1 threshold 3 0 1 2 3 4 5 6 7 Switch(config)# mls qos srr-queue input dscp-map queue 1 threshold 3 32 Switch(config)# mls qos srr-queue input dscp-map queue 2 threshold 1 16 17 18 19 20 21 22 23 Switch(config)# mls qos srr-queue input dscp-map queue 2 threshold 2 33 34 35 36 37 38 39 48 Switch(config)# mls qos srr-queue input dscp-map queue 2 threshold 2 49 50 51 52 53 54 55 56 Switch(config)# mls qos srr-queue input dscp-map queue 2 threshold 2 57 58 59 60 61 62 63 Switch(config)# mls qos srr-queue input dscp-map queue 2 threshold 3 24 25 26 27 28 29 30 31 Switch(config)# mls qos srr-queue input dscp-map queue 2 threshold 3 40 41 42 43 44 45 46 47</pre>
The switch automatically maps DSCP values to an egress queue and to a threshold ID.	<pre>Switch(config)# no mls qos srr-queue output dscp-map Switch(config)# mls qos srr-queue output dscp-map queue 1 threshold 3 40 41 42 43 44 45 46 47 Switch(config)# mls qos srr-queue output dscp-map queue 2 threshold 3 24 25 26 27 28 29 30 31 Switch(config)# mls qos srr-queue output dscp-map queue 2 threshold 3 48 49 50 51 52 53 54 55 Switch(config)# mls qos srr-queue output dscp-map queue 2 threshold 3 56 57 58 59 60 61 62 63 Switch(config)# mls qos srr-queue output dscp-map queue 3 threshold 3 16 17 18 19 20 21 22 23 Switch(config)# mls qos srr-queue output dscp-map queue 3 threshold 3 32 33 34 35 36 37 38 39 Switch(config)# mls qos srr-queue output dscp-map queue 4 threshold 1 8 Switch(config)# mls qos srr-queue output dscp-map queue 4 threshold 2 9 10 11 12 13 14 15 Switch(config)# mls qos srr-queue output dscp-map queue 4 threshold 3 0 1 2 3 4 5 6 7</pre>
The switch automatically sets up the ingress queues, with queue 2 as the priority queue and queue 1 in shared mode. The switch also configures the bandwidth and buffer size for the ingress queues.	<pre>Switch(config)# no mls qos srr-queue input priority-queue 1 Switch(config)# no mls qos srr-queue input priority-queue 2 Switch(config)# mls qos srr-queue input bandwidth 90 10 Switch(config)# mls qos srr-queue input threshold 1 8 16 Switch(config)# mls qos srr-queue input threshold 2 34 66 Switch(config)# mls qos srr-queue input buffers 67 33</pre>

Table 36-5 Generated Auto-QoS Configuration (continued)

Description	Automatically Generated Command
<p>The switch automatically configures the egress queue buffer sizes. It configures the bandwidth and the SRR mode (shaped or shared) on the egress queues mapped to the port.</p>	<pre>Switch(config)# mls qos queue-set output 1 threshold 1 138 138 92 138 Switch(config)# mls qos queue-set output 1 threshold 2 138 138 92 400 Switch(config)# mls qos queue-set output 1 threshold 3 36 77 100 318 Switch(config)# mls qos queue-set output 1 threshold 4 20 50 67 400 Switch(config)# mls qos queue-set output 2 threshold 1 149 149 100 149 Switch(config)# mls qos queue-set output 2 threshold 2 118 118 100 235 Switch(config)# mls qos queue-set output 2 threshold 3 41 68 100 272 Switch(config)# mls qos queue-set output 2 threshold 4 42 72 100 242 Switch(config)# mls qos queue-set output 1 buffers 10 10 26 54 Switch(config)# mls qos queue-set output 2 buffers 16 6 17 61  Switch(config-if)# srr-queue bandwidth share 10 10 60 20</pre>
<p>If you entered the <b>auto qos voip trust</b> command, the switch automatically sets the ingress classification to trust the CoS value received in the packet on a nonrouted port by using the <b>mls qos trust cos</b> command or to trust the DSCP value received in the packet on a routed port by using the <b>mls qos trust dscp</b> command.</p>	<pre>Switch(config-if)# mls qos trust cos Switch(config-if)# mls qos trust dscp</pre>
<p>If you entered the <b>auto qos voip cisco-phone</b> command, the switch automatically enables the trusted boundary feature, which uses the CDP to detect the presence or absence of a Cisco IP Phone.</p>	<pre>Switch(config-if)# mls qos trust device cisco-phone</pre>
<p>If you entered the <b>auto qos voip cisco-softphone</b> command, the switch automatically creates class maps and policy maps.</p>	<pre>Switch(config)# mls qos map policed-dscp 24 26 46 to 0 Switch(config)# class-map match-all AutoQoS-VoIP-RTP-Trust Switch(config-cmap)# match ip dscp ef Switch(config)# class-map match-all AutoQoS-VoIP-Control-Trust Switch(config-cmap)# match ip dscp cs3 af31 Switch(config)# policy-map AutoQoS-Police-SoftPhone Switch(config-pmap)# class AutoQoS-VoIP-RTP-Trust Switch(config-pmap-c)# set dscp ef Switch(config-pmap-c)# police 320000 8000 exceed-action policed-dscp-transmit Switch(config-pmap)# class AutoQoS-VoIP-Control-Trust Switch(config-pmap-c)# set dscp cs3 Switch(config-pmap-c)# police 32000 8000 exceed-action policed-dscp-transmit</pre>
<p>After creating the class maps and policy maps, the switch automatically applies the policy map called <i>AutoQoS-Police-SoftPhone</i> to an ingress interface on which auto-QoS with the Cisco SoftPhone feature is enabled.</p>	<pre>Switch(config-if)# service-policy input AutoQoS-Police-SoftPhone</pre>



## Effects of Auto-QoS on the Configuration

When auto-QoS is enabled, the **auto qos voip** interface configuration command and the generated configuration are added to the running configuration.

The switch applies the auto-QoS-generated commands as if the commands were entered from the CLI. An existing user configuration can cause the application of the generated commands to fail or to be overridden by the generated commands. These actions occur without warning. If all the generated commands are successfully applied, any user-entered configuration that was not overridden remains in the running configuration. Any user-entered configuration that was overridden can be retrieved by reloading the switch without saving the current configuration to memory. If the generated commands fail to be applied, the previous running configuration is restored.

## Auto-QoS Configuration Guidelines

Before configuring auto-QoS, you should be aware of this information:

- Auto-QoS configures the switch for VoIP with Cisco IP Phones on nonrouted and routed ports. Auto-QoS also configures the switch for VoIP with devices running the Cisco SoftPhone application.



---

**Note** When a device running Cisco SoftPhone is connected to a nonrouted or routed port, the switch supports only one Cisco SoftPhone application per port.

---

- To take advantage of the auto-QoS defaults, you should enable auto-QoS before you configure other QoS commands. If necessary, you can fine-tune the QoS configuration, but we recommend that you do so only after the auto-QoS configuration is completed. For more information, see the [“Effects of Auto-QoS on the Configuration”](#) section on page 36-25.
- After auto-QoS is enabled, do not modify a policy map or aggregate policer that includes *AutoQoS* in its name. If you need to modify the policy map or aggregate policer, make a copy of it, and change the copied policy map or policer. To use this new policy map instead of the generated one, remove the generated policy map from the interface, and apply the new policy map to the interface.
- You can enable auto-QoS on static, dynamic-access, voice VLAN access, and trunk ports.
- By default, the CDP is enabled on all ports. For auto-QoS to function properly, do not disable the CDP.
- When enabling auto-QoS with a Cisco IP Phone on a routed port, you must assign a static IP address to the IP phone.
- This release supports only Cisco IP SoftPhone Version 1.3(3) or later.
- Connected devices must use Cisco Call Manager Version 4 or later.

## Enabling Auto-QoS for VoIP

Beginning in privileged EXEC mode, follow these steps to enable auto-QoS for VoIP within a QoS domain:

	Command	Purpose
Step 1	<b>configure terminal</b>	Enter global configuration mode.
Step 2	<b>interface</b> <i>interface-id</i>	Specify the port that is connected to a Cisco IP Phone, the port that is connected to a device running the Cisco SoftPhone feature, or the uplink port that is connected to another trusted switch or router in the interior of the network, and enter interface configuration mode.
Step 3	<b>auto qos voip</b> { <b>cisco-phone</b>   <b>cisco-softphone</b>   <b>trust</b> }	<p>Enable auto-QoS.</p> <p>The keywords have these meanings:</p> <ul style="list-style-type: none"> <li>• <b>cisco-phone</b>—If the port is connected to a Cisco IP Phone, the QoS labels of incoming packets are trusted only when the telephone is detected.</li> <li>• <b>cisco-softphone</b>—The port is connected to device running the Cisco SoftPhone feature.</li> <li>• <b>trust</b>—The uplink port is connected to a trusted switch or router, and the VoIP traffic classification in the ingress packet is trusted.</li> </ul>
Step 4	<b>end</b>	Return to privileged EXEC mode.
Step 5	<b>show auto qos interface</b> <i>interface-id</i>	<p>Verify your entries.</p> <p>This command displays the auto-QoS command on the interface on which auto-QoS was enabled. You can use the <b>show running-config</b> privileged EXEC command to display the auto-QoS configuration and the user modifications.</p>

To display the QoS commands that are automatically generated when auto-QoS is enabled or disabled, enter the **debug auto qos** privileged EXEC command *before* enabling auto-QoS. For more information, see the **debug autoqos** command in the command reference for this release.

To disable auto-QoS on a port, use the **no auto qos voip** interface configuration command. Only the auto-QoS-generated interface configuration commands for this port are removed. If this is the last port on which auto-QoS is enabled and you enter the **no auto qos voip** command, auto-QoS is considered disabled even though the auto-QoS-generated global configuration commands remain (to avoid disrupting traffic on other ports affected by the global configuration).

You can use the **no mls qos** global configuration command to disable the auto-QoS-generated global configuration commands. With QoS disabled, there is no concept of trusted or untrusted ports because the packets are not modified (the CoS, DSCP, and IP precedence values in the packet are not changed). Traffic is switched in pass-through mode (packets are switched without any rewrites and classified as best effort without any policing).

This example shows how to enable auto-QoS and to trust the QoS labels received in incoming packets when the switch or router connected to a port is a trusted device:

```
Switch(config)# interface gigabitethernet2/0/1
Switch(config-if)# auto qos voip trust
```

## Auto-QoS Configuration Example

This section describes how you could implement auto-QoS in a network, as shown in [Figure 36-11](#). For optimum QoS performance, enable auto-QoS on all the devices in the network.

**Figure 36-11** Auto-QoS Configuration Example Network

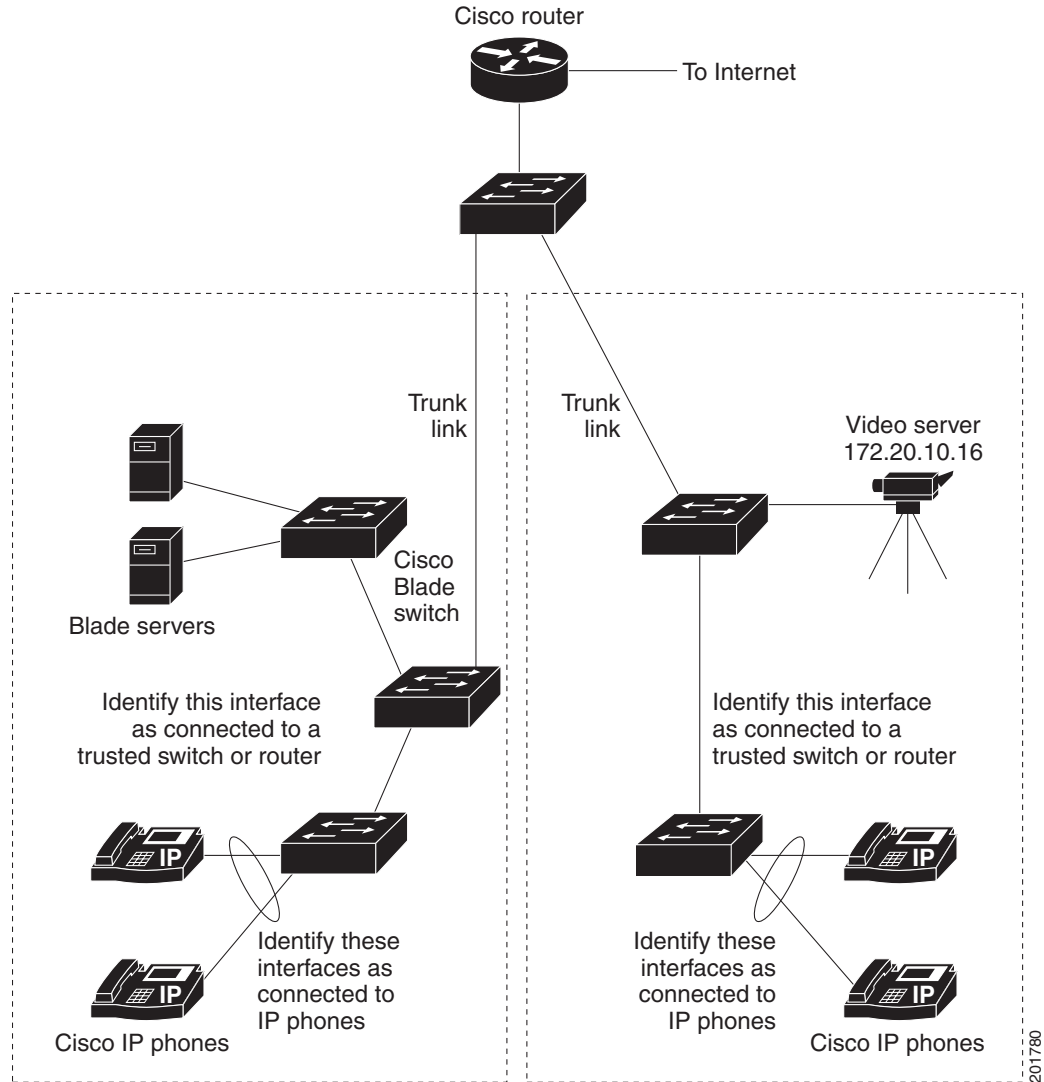

[Figure 36-11](#) shows a network in which the VoIP traffic is prioritized over all other traffic. Auto-QoS is enabled on the switches in the network at the edge of the QoS domain.

**Note**

You should not configure any standard QoS commands before entering the auto-QoS commands. You can fine-tune the QoS configuration, but we recommend that you do so only after the auto-QoS configuration is completed.

Beginning in privileged EXEC mode, follow these steps to configure the switch at the edge of the QoS domain to prioritize the VoIP traffic over all other traffic:

	<b>Command</b>	<b>Purpose</b>
<b>Step 1</b>	<b>debug auto qos</b>	Enable debugging for auto-QoS. When debugging is enabled, the switch displays the QoS configuration that is automatically generated when auto-QoS is enabled.
<b>Step 2</b>	<b>configure terminal</b>	Enter global configuration mode.
<b>Step 3</b>	<b>cdp enable</b>	Enable CDP globally. By default, it is enabled.
<b>Step 4</b>	<b>interface interface-id</b>	Specify the switch port connected to the Cisco IP Phone, and enter interface configuration mode.
<b>Step 5</b>	<b>auto qos voip cisco-phone</b>	Enable auto-QoS on the port, and specify that the port is connected to a Cisco IP Phone.  The QoS labels of incoming packets are trusted only when the Cisco IP Phone is detected.
<b>Step 6</b>	<b>exit</b>	Return to global configuration mode.
<b>Step 7</b>		Repeat Steps 4 to 6 for as many ports as are connected to the Cisco IP Phone.
<b>Step 8</b>	<b>interface interface-id</b>	Specify the switch port identified as connected to a trusted switch or router, and enter interface configuration mode. See <a href="#">Figure 36-11</a> .
<b>Step 9</b>	<b>auto qos voip trust</b>	Enable auto-QoS on the port, and specify that the port is connected to a trusted router or switch.
<b>Step 10</b>	<b>end</b>	Return to privileged EXEC mode.
<b>Step 11</b>	<b>show auto qos</b>	Verify your entries.  This command displays the auto-QoS command on the interface on which auto-QoS was enabled. You can use the <b>show running-config</b> privileged EXEC command to display the auto-QoS configuration and the user modifications.  For information about the QoS configuration that might be affected by auto-QoS, see the “Displaying Auto-QoS Information” section on page 26-12.
<b>Step 12</b>	<b>copy running-config startup-config</b>	Save the <b>auto qos voip</b> interface configuration commands and the generated auto-QoS configuration in the configuration file.

## Displaying Auto-QoS Information

To display the initial auto-QoS configuration, use the **show auto qos [interface *interface-id*]** privileged EXEC command. To display any user changes to that configuration, use the **show running-config** privileged EXEC command. You can compare the **show auto qos** and the **show running-config** command output to identify the user-defined QoS settings.

To display information about the QoS configuration that might be affected by auto-QoS, use one of these commands:

- **show mls qos**
- **show mls qos maps cos-dscp**
- **show mls qos interface *interface-id* [buffers | queueing]**
- **show mls qos maps [cos-dscp | cos-input-q | cos-output-q | dscp-cos | dscp-input-q | dscp-output-q]**
- **show mls qos input-queue**
- **show running-config**

For more information about these commands, see the command reference for this release.

## Configuring Standard QoS

Before configuring standard QoS, you must have a thorough understanding of these items:

- The types of applications used and the traffic patterns on your network.
- Traffic characteristics and needs of your network. Is the traffic bursty? Do you need to reserve bandwidth for voice and video streams?
- Bandwidth requirements and speed of the network.
- Location of congestion points in the network.

These sections contain this configuration information:

- [Default Standard QoS Configuration, page 36-30](#)
- [Standard QoS Configuration Guidelines, page 36-32](#)
- [Enabling QoS Globally, page 36-34](#) (required)
- [Enabling VLAN-Based QoS on Physical Ports, page 36-34](#) (optional)
- [Configuring Classification Using Port Trust States, page 36-35](#) (required)
- [Configuring a QoS Policy, page 36-42](#) (required)
- [Configuring DSCP Maps, page 36-60](#) (optional, unless you need to use the DSCP-to-DSCP-mutation map or the policed-DSCP map)
- [Configuring Ingress Queue Characteristics, page 36-66](#) (optional)
- [Configuring Egress Queue Characteristics, page 36-70](#) (optional)

## Default Standard QoS Configuration

QoS is disabled. There is no concept of trusted or untrusted ports because the packets are not modified (the CoS, DSCP, and IP precedence values in the packet are not changed). Traffic is switched in pass-through mode (packets are switched without any rewrites and classified as best effort without any policing).

When QoS is enabled with the **mls qos** global configuration command and all other QoS settings are at their defaults, traffic is classified as best effort (the DSCP and CoS value is set to 0) without any policing. No policy maps are configured. The default port trust state on all ports is untrusted. The default ingress and egress queue settings are described in the “[Default Ingress Queue Configuration](#)” section on page 36-30 and the “[Default Egress Queue Configuration](#)” section on page 36-31.

## Default Ingress Queue Configuration

Table 36-6 shows the default ingress queue configuration when QoS is enabled.

**Table 36-6** Default Ingress Queue Configuration

Feature	Queue 1	Queue 2
Buffer allocation	90 percent	10 percent
Bandwidth allocation <sup>1</sup>	4	4
Priority queue bandwidth <sup>2</sup>	0	10
WTD drop threshold 1	100 percent	100 percent
WTD drop threshold 2	100 percent	100 percent

1. The bandwidth is equally shared between the queues. SRR sends packets in shared mode only.

2. Queue 2 is the priority queue. SRR services the priority queue for its configured share before servicing the other queue.

Table 36-7 shows the default CoS input queue threshold map when QoS is enabled.

**Table 36-7** Default CoS Input Queue Threshold Map

CoS Value	Queue ID–Threshold ID
0–4	1–1
5	2–1
6, 7	1–1

Table 36-8 shows the default DSCP input queue threshold map when QoS is enabled.

**Table 36-8** Default DSCP Input Queue Threshold Map

DSCP Value	Queue ID–Threshold ID
0–39	1–1
40–47	2–1
48–63	1–1

## Default Egress Queue Configuration

Table 36-9 shows the default egress queue configuration for each queue-set when QoS is enabled. All ports are mapped to queue-set 1. The port bandwidth limit is set to 100 percent and rate unlimited.

**Table 36-9** *Default Egress Queue Configuration*

Feature	Queue 1	Queue 2	Queue 3	Queue 4
Buffer allocation	25 percent	25 percent	25 percent	25 percent
WTD drop threshold 1	100 percent	200 percent	100 percent	100 percent
WTD drop threshold 2	100 percent	200 percent	100 percent	100 percent
Reserved threshold	50 percent	50 percent	50 percent	50 percent
Maximum threshold	400 percent	400 percent	400 percent	400 percent
SRR shaped weights (absolute) <sup>1</sup>	25	0	0	0
SRR shared weights <sup>2</sup>	25	25	25	25

1. A shaped weight of zero means that this queue is operating in shared mode.
2. One quarter of the bandwidth is allocated to each queue.

Table 36-10 shows the default CoS output queue threshold map when QoS is enabled.

**Table 36-10** *Default CoS Output Queue Threshold Map*

CoS Value	Queue ID–Threshold ID
0, 1	2–1
2, 3	3–1
4	4–1
5	1–1
6, 7	4–1

Table 36-11 shows the default DSCP output queue threshold map when QoS is enabled.

**Table 36-11** *Default DSCP Output Queue Threshold Map*

DSCP Value	Queue ID–Threshold ID
0–15	2–1
16–31	3–1
32–39	4–1
40–47	1–1
48–63	4–1

## Default Mapping Table Configuration

The default CoS-to-DSCP map is shown in [Table 36-12 on page 36-60](#).

The default IP-precedence-to-DSCP map is shown in [Table 36-13 on page 36-61](#).

The default DSCP-to-CoS map is shown in [Table 36-14 on page 36-63](#).

The default DSCP-to-DSCP-mutation map is a null map, which maps an incoming DSCP value to the same DSCP value.

The default policed-DSCP map is a null map, which maps an incoming DSCP value to the same DSCP value (no markdown).

## Standard QoS Configuration Guidelines

Before beginning the QoS configuration, you should be aware of this information in these sections:

- [“QoS ACL Guidelines” section on page 36-32](#)
- [“Applying QoS on Interfaces” section on page 36-32](#)
- [“Policing Guidelines” section on page 36-33](#)
- [“General QoS Guidelines” section on page 36-33](#)

### QoS ACL Guidelines

These are the guidelines with for configuring QoS with access control lists (ACLs):

- It is not possible to match IP fragments against configured IP extended ACLs to enforce QoS. IP fragments are sent as best-effort. IP fragments are denoted by fields in the IP header.
- Only one ACL per class map and only one **match** class-map configuration command per class map are supported. The ACL can have multiple ACEs, which match fields against the contents of the packet.
- A trust statement in a policy map requires multiple hardware entries per ACL line. If an input service policy map contains a trust statement in an ACL, the access list might be too large to fit into the available QoS hardware memory, and an error can occur when you apply the policy map to a port. Whenever possible, you should minimize the number of lines in a QoS ACL.

### Applying QoS on Interfaces

These are the guidelines with for configuring QoS on physical ports. This section also applies to SVIs (Layer 3 interfaces):

- You can configure QoS on physical ports and SVIs. When configuring QoS on physical ports, you create and apply nonhierarchical policy maps. When configuring QoS on SVIs, you can create and apply nonhierarchical and hierarchical policy maps.
- Incoming traffic is classified, policed, and marked down (if configured) regardless of whether the traffic is bridged, routed, or sent to the CPU. It is possible for bridged frames to be dropped or to have their DSCP and CoS values modified.



- Follow these guidelines when configuring policy maps on physical ports or SVIs:
  - You cannot apply the same policy map to a physical port and to an SVI.
  - If VLAN-based QoS is configured on a physical port, the switch removes all the port-based policy maps on the port. The traffic on this physical port is now affected by the policy map attached to the SVI to which the physical port belongs.
  - In a hierarchical policy map attached to an SVI, you can only configure an individual policer at the interface level on a physical port to specify the bandwidth limits for the traffic on the port. The ingress port must be configured as a trunk or as a static-access port. You cannot configure policers at the VLAN level of the hierarchical policy map.
  - The switch does not support aggregate policers in hierarchical policy maps.
  - After the hierarchical policy map is attached to an SVI, the interface-level policy map cannot be modified or removed from the hierarchical policy map. A new interface-level policy map also cannot be added to the hierarchical policy map. If you want these changes to occur, the hierarchical policy map must first be removed from the SVI. You also cannot add or remove a class map specified in the hierarchical policy map.

## Policing Guidelines

These are the policing guidelines:

- The port ASIC device, which controls more than one physical port, supports 256 policers (255 user-configurable policers plus 1 policer reserved for system internal use). The maximum number of user-configurable policers supported per port is 63. For example, you could configure 32 policers on a Gigabit Ethernet port and 7 policers on a 10-Gigabit Ethernet port, or you could configure 64 policers on a Gigabit Ethernet port and 4 policers on a 10-Gigabit Ethernet port. Policers are allocated on demand by the software and are constrained by the hardware and ASIC boundaries. You cannot reserve policers per port; there is no guarantee that a port will be assigned to any policer.
- Only one policer is applied to a packet on an ingress port. Only the average rate and committed burst parameters are configurable.
- You can create an aggregate policer that is shared by multiple traffic classes within the same nonhierarchical policy map. However, you cannot use the aggregate policer across different policy maps.
- On a port configured for QoS, all traffic received through the port is classified, policed, and marked according to the policy map attached to the port. On a trunk port configured for QoS, traffic in *all* VLANs received through the port is classified, policed, and marked according to the policy map attached to the port.
- If you have EtherChannel ports configured on your switch, you must configure QoS classification, policing, mapping, and queueing on the individual physical ports that comprise the EtherChannel. You must decide whether the QoS configuration should match on all ports in the EtherChannel.

## General QoS Guidelines

These are general QoS guidelines:

- Control traffic (such as spanning-tree bridge protocol data units [BPDUs] and routing update packets) received by the switch are subject to all ingress QoS processing.
- You are likely to lose data when you change queue settings; therefore, try to make changes when traffic is at a minimum.

- A switch that is running the IP services feature set supports QoS DSCP and IP precedence matching in policy-based routing (PBR) route maps with these limitations:
  - You cannot apply QoS DSCP mutation maps and PBR route maps to the same interface.
  - You cannot configure DSCP transparency and PBR DSCP route maps on the same switch.

## Enabling QoS Globally

By default, QoS is disabled on the switch.

Beginning in privileged EXEC mode, follow these steps to enable QoS. This procedure is required.

	Command	Purpose
Step 1	<b>configure terminal</b>	Enter global configuration mode.
Step 2	<b>mls qos</b>	Enable QoS globally.  QoS runs with the default settings described in the “ <a href="#">Default Standard QoS Configuration</a> ” section on page 36-30, the “ <a href="#">Queueing and Scheduling on Ingress Queues</a> ” section on page 36-15, and the “ <a href="#">Queueing and Scheduling on Egress Queues</a> ” section on page 36-17.
Step 3	<b>end</b>	Return to privileged EXEC mode.
Step 4	<b>show mls qos</b>	Verify your entries.
Step 5	<b>copy running-config startup-config</b>	(Optional) Save your entries in the configuration file.

To disable QoS, use the **no mls qos** global configuration command.

## Enabling VLAN-Based QoS on Physical Ports

By default, VLAN-based QoS is disabled on all physical switch ports. The switch applies QoS, including class maps and policy maps, only on a physical-port basis. In Cisco IOS Release 12.2(25)SE or later, you can enable VLAN-based QoS on a switch port.

Beginning in privileged EXEC mode, follow these steps to enable VLAN-based QoS. This procedure is required on physical ports that are specified in the interface level of a hierarchical policy map on an SVI.

	Command	Purpose
Step 1	<b>configure terminal</b>	Enter global configuration mode.
Step 2	<b>interface <i>interface-id</i></b>	Specify the physical port, and enter interface configuration mode.
Step 3	<b>mls qos vlan-based</b>	Enable VLAN-based QoS on the port.
Step 4	<b>end</b>	Return to privileged EXEC mode.
Step 5	<b>show mls qos interface <i>interface-id</i></b>	Verify if VLAN-based QoS is enabled on the physical port.
Step 6	<b>copy running-config startup-config</b>	(Optional) Save your entries in the configuration file.

Use the **no mls qos vlan-based** interface configuration command to disable VLAN-based QoS on the physical port.

## Configuring Classification Using Port Trust States

These sections describe how to classify incoming traffic by using port trust states. Depending on your network configuration, you must perform one or more of these tasks or one or more of the tasks in the “Configuring a QoS Policy” section on page 36-42:

- [Configuring the Trust State on Ports within the QoS Domain, page 36-35](#)
- [Configuring the CoS Value for an Interface, page 36-37](#)
- [Configuring a Trusted Boundary to Ensure Port Security, page 36-38](#)
- [Enabling DSCP Transparency Mode, page 36-39](#)
- [Configuring the DSCP Trust State on a Port Bordering Another QoS Domain, page 36-40](#)

### Configuring the Trust State on Ports within the QoS Domain

Packets entering a QoS domain are classified at the edge of the QoS domain. When the packets are classified at the edge, the switch port within the QoS domain can be configured to one of the trusted states because there is no need to classify the packets at every switch within the QoS domain.

[Figure 36-12](#) shows a sample network topology.

Figure 36-12 Port Trusted States within the QoS Domain

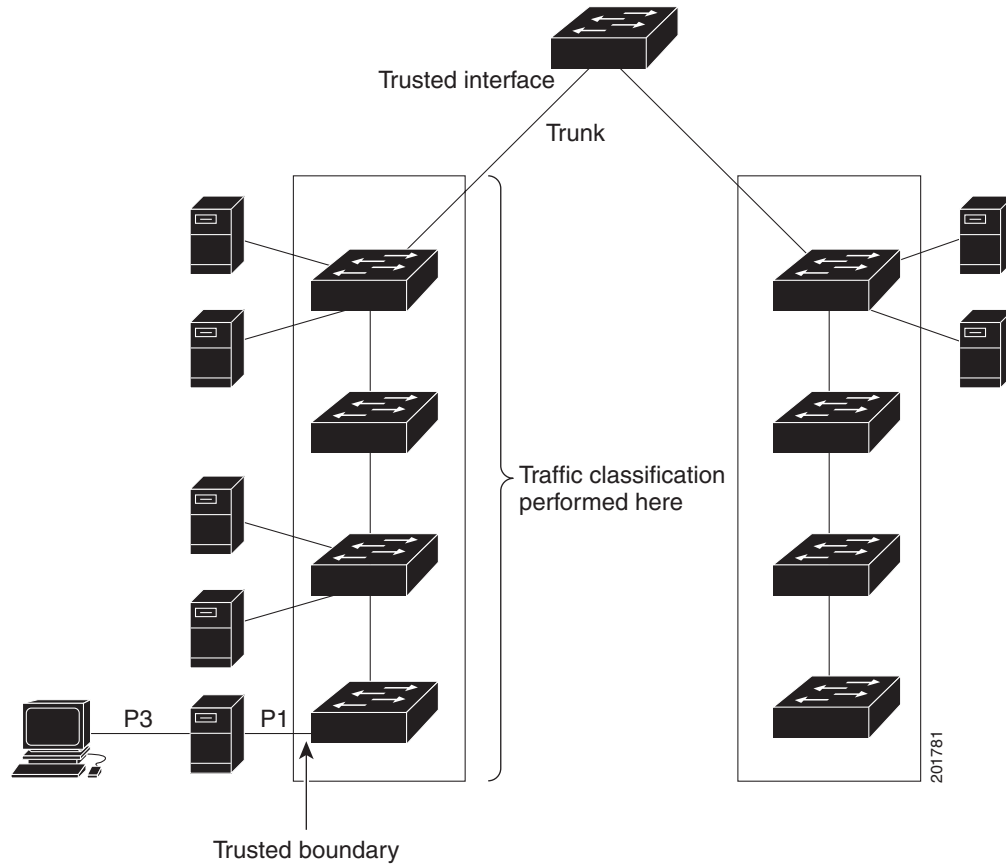

Beginning in privileged EXEC mode, follow these steps to configure the port to trust the classification of the traffic that it receives:

	Command	Purpose
Step 1	<code>configure terminal</code>	Enter global configuration mode.
Step 2	<code>interface interface-id</code>	Specify the port to be trusted, and enter interface configuration mode.  Valid interfaces include physical ports.

	Command	Purpose
Step 3	<b>mls qos trust [cos   dscp   ip-precedence]</b>	<p>Configure the port trust state.</p> <p>By default, the port is not trusted. If no keyword is specified, the default is <b>dscp</b>.</p> <p>The keywords have these meanings:</p> <ul style="list-style-type: none"> <li>• <b>cos</b>—Classifies an ingress packet by using the packet CoS value. For an untagged packet, the port default CoS value is used. The default port CoS value is 0.</li> <li>• <b>dscp</b>—Classifies an ingress packet by using the packet DSCP value. For a non-IP packet, the packet CoS value is used if the packet is tagged; for an untagged packet, the default port CoS is used. Internally, the switch maps the CoS value to a DSCP value by using the CoS-to-DSCP map.</li> <li>• <b>ip-precedence</b>—Classifies an ingress packet by using the packet IP-precedence value. For a non-IP packet, the packet CoS value is used if the packet is tagged; for an untagged packet, the default port CoS is used. Internally, the switch maps the CoS value to a DSCP value by using the CoS-to-DSCP map.</li> </ul>
Step 4	<b>end</b>	Return to privileged EXEC mode.
Step 5	<b>show mls qos interface</b>	Verify your entries.
Step 6	<b>copy running-config startup-config</b>	(Optional) Save your entries in the configuration file.

To return a port to its untrusted state, use the **no mls qos trust** interface configuration command.

For information on how to change the default CoS value, see the [“Configuring the CoS Value for an Interface”](#) section on page 36-37. For information on how to configure the CoS-to-DSCP map, see the [“Configuring the CoS-to-DSCP Map”](#) section on page 36-60.

## Configuring the CoS Value for an Interface

QoS assigns the CoS value specified with the **mls qos cos** interface configuration command to untagged frames received on trusted and untrusted ports.

Beginning in privileged EXEC mode, follow these steps to define the default CoS value of a port or to assign the default CoS to all incoming packets on the port:

	Command	Purpose
Step 1	<b>configure terminal</b>	Enter global configuration mode.
Step 2	<b>interface <i>interface-id</i></b>	<p>Specify the port to be configured, and enter interface configuration mode.</p> <p>Valid interfaces include physical ports.</p>

	Command	Purpose
Step 3	<code>mls qos cos {default-cos   override}</code>	Configure the default CoS value for the port. <ul style="list-style-type: none"> <li>For <i>default-cos</i>, specify a default CoS value to be assigned to a port. If the packet is untagged, the default CoS value becomes the packet CoS value. The CoS range is 0 to 7. The default is 0.</li> <li>Use the <b>override</b> keyword to override the previously configured trust state of the incoming packet and to apply the default port CoS value to the port on all incoming packets. By default, CoS override is disabled.</li> </ul> Use the <b>override</b> keyword when all incoming packets on specified ports deserve higher or lower priority than packets entering from other ports. Even if a port was previously set to trust DSCP, CoS, or IP precedence, this command overrides the previously configured trust state, and all the incoming CoS values are assigned the default CoS value configured with this command. If an incoming packet is tagged, the CoS value of the packet is modified with the default CoS of the port at the ingress port.
Step 4	<code>end</code>	Return to privileged EXEC mode.
Step 5	<code>show mls qos interface</code>	Verify your entries.
Step 6	<code>copy running-config startup-config</code>	(Optional) Save your entries in the configuration file.

To return to the default setting, use the `no mls qos cos {default-cos | override}` interface configuration command.

## Configuring a Trusted Boundary to Ensure Port Security

In a typical network, you connect a Cisco IP Phone to a switch port, as shown in [Figure 36-12 on page 36-36](#), and cascade devices that generate data packets from the back of the telephone. The Cisco IP Phone guarantees the voice quality through a shared data link by marking the CoS level of the voice packets as high priority (CoS = 5) and by marking the data packets as low priority (CoS = 0). Traffic sent from the telephone to the switch is typically marked with a tag that uses the 802.1Q header. The header contains the VLAN information and the class of service (CoS) 3-bit field, which is the priority of the packet.

For most Cisco IP Phone configurations, the traffic sent from the telephone to the switch should be trusted to ensure that voice traffic is properly prioritized over other types of traffic in the network. By using the `mls qos trust cos` interface configuration command, you configure the switch port to which the telephone is connected to trust the CoS labels of all traffic received on that port. Use the `mls qos trust dscp` interface configuration command to configure a routed port to which the telephone is connected to trust the DSCP labels of all traffic received on that port.

With the trusted setting, you also can use the trusted boundary feature to prevent misuse of a high-priority queue if a user bypasses the telephone and connects the PC directly to the switch. Without trusted boundary, the CoS labels generated by the PC are trusted by the switch (because of the trusted CoS setting). By contrast, trusted boundary uses CDP to detect the presence of a Cisco IP Phone (such as the Cisco IP Phone 7910, 7935, 7940, and 7960) on a switch port. If the telephone is not detected, the trusted boundary feature disables the trusted setting on the switch port and prevents misuse of a high-priority queue. Note that the trusted boundary feature is not effective if the PC and Cisco IP Phone are connected to a hub that is connected to the switch.

In some situations, you can prevent a PC connected to the Cisco IP Phone from taking advantage of a high-priority data queue. You can use the **switchport priority extend cos** interface configuration command to configure the telephone through the switch CLI to override the priority of the traffic received from the PC.

Beginning in privileged EXEC mode, follow these steps to enable trusted boundary on a port:

	Command	Purpose
Step 1	<b>configure terminal</b>	Enter global configuration mode.
Step 2	<b>cdp run</b>	Enable CDP globally. By default, CDP is enabled.
Step 3	<b>interface <i>interface-id</i></b>	Specify the port connected to the Cisco IP Phone, and enter interface configuration mode.  Valid interfaces include physical ports.
Step 4	<b>cdp enable</b>	Enable CDP on the port. By default, CDP is enabled.
Step 5	<b>mls qos trust cos</b>  <b>mls qos trust dscp</b>	Configure the switch port to trust the CoS value in traffic received from the Cisco IP Phone.  or Configure the routed port to trust the DSCP value in traffic received from the Cisco IP Phone.  By default, the port is not trusted.
Step 6	<b>mls qos trust device cisco-phone</b>	Specify that the Cisco IP Phone is a trusted device.  You cannot enable both trusted boundary and auto-QoS ( <b>auto qos voip</b> interface configuration command) at the same time; they are mutually exclusive.
Step 7	<b>end</b>	Return to privileged EXEC mode.
Step 8	<b>show mls qos interface</b>	Verify your entries.
Step 9	<b>copy running-config startup-config</b>	(Optional) Save your entries in the configuration file.

To disable the trusted boundary feature, use the **no mls qos trust device** interface configuration command.

## Enabling DSCP Transparency Mode

The switch supports the DSCP transparency feature. It affects only the DSCP field of a packet at egress. By default, DSCP transparency is disabled. The switch modifies the DSCP field in an incoming packet, and the DSCP field in the outgoing packet is based on the quality of service (QoS) configuration, including the port trust setting, policing and marking, and the DSCP-to-DSCP mutation map.

If DSCP transparency is enabled by using the **no mls qos rewrite ip dscp** command, the switch does not modify the DSCP field in the incoming packet, and the DSCP field in the outgoing packet is the same as that in the incoming packet.



### Note

Enabling DSCP transparency does not affect the port trust settings on IEEE 802.1Q tunneling ports.

Regardless of the DSCP transparency configuration, the switch modifies the internal DSCP value of the packet, which the switch uses to generate a class of service (CoS) value that represents the priority of the traffic. The switch also uses the internal DSCP value to select an egress queue and threshold.

Beginning in privileged EXEC mode, follow these steps to enable DSCP transparency on a switch:

	Command	Purpose
Step 1	<b>configure terminal</b>	Enter global configuration mode.
Step 2	<b>mls qos</b>	Enable QoS globally.
Step 3	<b>no mls qos rewrite ip dscp</b>	Enable DSCP transparency. The switch is configured to not modify the DSCP field of the IP packet.
Step 4	<b>end</b>	Return to privileged EXEC mode.
Step 5	<b>show mls qos interface</b> [ <i>interface-id</i> ]	Verify your entries.
Step 6	<b>copy running-config startup-config</b>	(Optional) Save your entries in the configuration file.

To configure the switch to modify the DSCP value based on the trust setting or on an ACL by disabling DSCP transparency, use the **mls qos rewrite ip dscp** global configuration command.

If you disable QoS by using the **no mls qos** global configuration command, the CoS and DSCP values are not changed (the default QoS setting).

If you enter the **no mls qos rewrite ip dscp** global configuration command to enable DSCP transparency and then enter the **mls qos trust [cos | dscp]** interface configuration command, DSCP transparency is still enabled.

## Configuring the DSCP Trust State on a Port Bordering Another QoS Domain

If you are administering two separate QoS domains between which you want to implement QoS features for IP traffic, you can configure the switch ports bordering the domains to a DSCP-trusted state as shown in [Figure 36-13](#). Then the receiving port accepts the DSCP-trusted value and avoids the classification stage of QoS. If the two domains use different DSCP values, you can configure the DSCP-to-DSCP-mutation map to translate a set of DSCP values to match the definition in the other domain.



Figure 36-13 DSCP-Trusted State on a Port Bordering Another QoS Domain

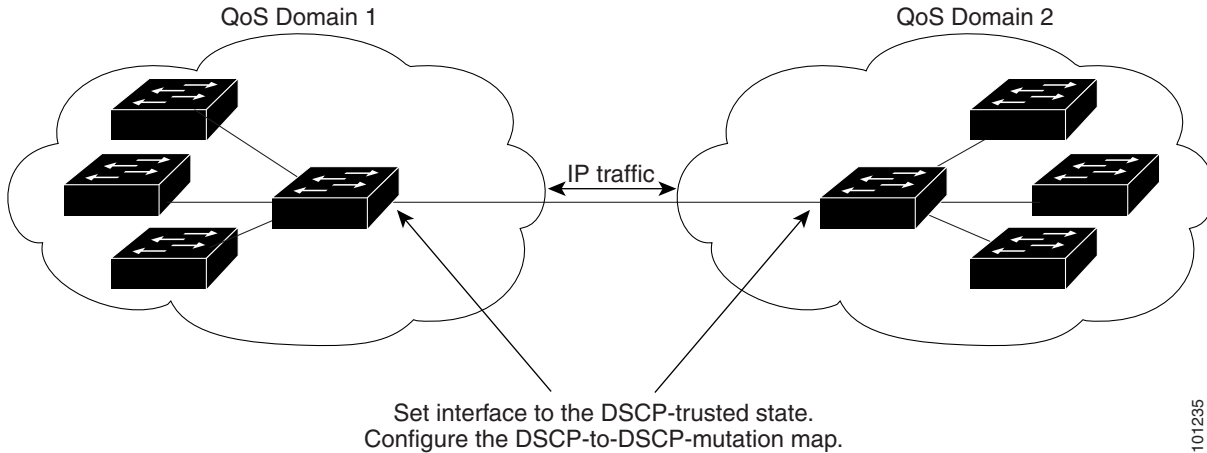

Beginning in privileged EXEC mode, follow these steps to configure the DSCP-trusted state on a port and modify the DSCP-to-DSCP-mutation map. To ensure a consistent mapping strategy across both QoS domains, you must perform this procedure on the ports in both domains:

	Command	Purpose
Step 1	<b>configure terminal</b>	Enter global configuration mode.
Step 2	<b>mls qos map dscp-mutation</b> <i>dscp-mutation-name in-dscp to out-dscp</i>	Modify the DSCP-to-DSCP-mutation map.  The default DSCP-to-DSCP-mutation map is a null map, which maps an incoming DSCP value to the same DSCP value. <ul style="list-style-type: none"> <li>For <i>dscp-mutation-name</i>, enter the mutation map name. You can create more than one map by specifying a new name.</li> <li>For <i>in-dscp</i>, enter up to eight DSCP values separated by spaces. Then enter the <b>to</b> keyword.</li> <li>For <i>out-dscp</i>, enter a single DSCP value.</li> </ul> The DSCP range is 0 to 63.
Step 3	<b>interface</b> <i>interface-id</i>	Specify the port to be trusted, and enter interface configuration mode.  Valid interfaces include physical ports.
Step 4	<b>mls qos trust dscp</b>	Configure the ingress port as a DSCP-trusted port. By default, the port is not trusted.
Step 5	<b>mls qos dscp-mutation</b> <i>dscp-mutation-name</i>	Apply the map to the specified ingress DSCP-trusted port.  For <i>dscp-mutation-name</i> , specify the mutation map name created in Step 2.  You can configure multiple DSCP-to-DSCP-mutation maps on an ingress port.
Step 6	<b>end</b>	Return to privileged EXEC mode.
Step 7	<b>show mls qos maps dscp-mutation</b>	Verify your entries.
Step 8	<b>copy running-config startup-config</b>	(Optional) Save your entries in the configuration file.

To return a port to its non-trusted state, use the **no mls qos trust** interface configuration command. To return to the default DSCP-to-DSCP-mutation map values, use the **no mls qos map dscp-mutation dscp-mutation-name** global configuration command.

This example shows how to configure a port to the DSCP-trusted state and to modify the DSCP-to-DSCP-mutation map (named *gi1/0/2-mutation*) so that incoming DSCP values 10 to 13 are mapped to DSCP 30:

```
Switch(config)# mls qos map dscp-mutation gigabitethernet1/0/2-mutation 10 11 12 13 to 30
Switch(config)# interface gigabitethernet1/0/2
Switch(config-if)# mls qos trust dscp
Switch(config-if)# mls qos dscp-mutation gigabitethernet1/0/2-mutation
Switch(config-if)# end
```

## Configuring a QoS Policy

Configuring a QoS policy typically requires classifying traffic into classes, configuring policies applied to those traffic classes, and attaching policies to ports.

For background information, see the [“Classification” section on page 36-5](#) and the [“Policing and Marking” section on page 36-8](#). For configuration guidelines, see the [“Standard QoS Configuration Guidelines” section on page 36-32](#).

These sections describe how to classify, police, and mark traffic. Depending on your network configuration, you must perform one or more of these tasks:

- [Classifying Traffic by Using ACLs, page 36-43](#)
- [Classifying Traffic by Using Class Maps, page 36-46](#)
- [Classifying, Policing, and Marking Traffic on Physical Ports by Using Policy Maps, page 36-48](#)
- [Classifying, Policing, and Marking Traffic on SVIs by Using Hierarchical Policy Maps, page 36-52](#)
- [Classifying, Policing, and Marking Traffic by Using Aggregate Policers, page 36-58](#)

## Classifying Traffic by Using ACLs

You can classify IP traffic by using IP standard or IP extended ACLs; you can classify non-IP traffic by using Layer 2 MAC ACLs.

Beginning in privileged EXEC mode, follow these steps to create an IP standard ACL for IP traffic:

	Command	Purpose
Step 1	<code>configure terminal</code>	Enter global configuration mode.
Step 2	<code>access-list <i>access-list-number</i> {deny   permit} <i>source</i> [<i>source-wildcard</i>]</code>	<p>Create an IP standard ACL, repeating the command as many times as necessary.</p> <ul style="list-style-type: none"> <li>For <i>access-list-number</i>, enter the access list number. The range is 1 to 99 and 1300 to 1999.</li> <li>Use the <b>permit</b> keyword to permit a certain type of traffic if the conditions are matched. Use the <b>deny</b> keyword to deny a certain type of traffic if conditions are matched.</li> <li>For <i>source</i>, enter the network or host from which the packet is being sent. You can use the <b>any</b> keyword as an abbreviation for 0.0.0.0 255.255.255.255.</li> <li>(Optional) For <i>source-wildcard</i>, enter the wildcard bits in dotted decimal notation to be applied to the source. Place ones in the bit positions that you want to ignore.</li> </ul> <p><b>Note</b> When creating an access list, remember that, by default, the end of the access list contains an implicit deny statement for everything if it did not find a match before reaching the end.</p>
Step 3	<code>end</code>	Return to privileged EXEC mode.
Step 4	<code>show access-lists</code>	Verify your entries.
Step 5	<code>copy running-config startup-config</code>	(Optional) Save your entries in the configuration file.

To delete an access list, use the **no access-list *access-list-number*** global configuration command.

This example shows how to allow access for only those hosts on the three specified networks. The wildcard bits apply to the host portions of the network addresses. Any host with a source address that does not match the access list statements is rejected.

```
Switch(config)# access-list 1 permit 192.5.255.0 0.0.0.255
Switch(config)# access-list 1 permit 128.88.0.0 0.0.255.255
Switch(config)# access-list 1 permit 36.0.0.0 0.0.0.255
! (Note: all other access implicitly denied)
```

Beginning in privileged EXEC mode, follow these steps to create an IP extended ACL for IP traffic:

	Command	Purpose
Step 1	<code>configure terminal</code>	Enter global configuration mode.
Step 2	<code>access-list access-list-number {deny   permit} protocol source source-wildcard destination destination-wildcard</code>	<p>Create an IP extended ACL, repeating the command as many times as necessary.</p> <ul style="list-style-type: none"> <li>For <i>access-list-number</i>, enter the access list number. The range is 100 to 199 and 2000 to 2699.</li> <li>Use the <b>permit</b> keyword to permit a certain type of traffic if the conditions are matched. Use the <b>deny</b> keyword to deny a certain type of traffic if conditions are matched.</li> <li>For <i>protocol</i>, enter the name or number of an IP protocol. Use the question mark (?) to see a list of available protocol keywords.</li> <li>For <i>source</i>, enter the network or host from which the packet is being sent. You specify this by using dotted decimal notation, by using the <b>any</b> keyword as an abbreviation for <i>source</i> 0.0.0.0 <i>source-wildcard</i> 255.255.255.255, or by using the <b>host</b> keyword for <i>source</i> 0.0.0.0.</li> <li>For <i>source-wildcard</i>, enter the wildcard bits by placing ones in the bit positions that you want to ignore. You specify the wildcard by using dotted decimal notation, by using the <b>any</b> keyword as an abbreviation for <i>source</i> 0.0.0.0 <i>source-wildcard</i> 255.255.255.255, or by using the <b>host</b> keyword for <i>source</i> 0.0.0.0.</li> <li>For <i>destination</i>, enter the network or host to which the packet is being sent. You have the same options for specifying the <i>destination</i> and <i>destination-wildcard</i> as those described by <i>source</i> and <i>source-wildcard</i>.</li> </ul> <p><b>Note</b> When creating an access list, remember that, by default, the end of the access list contains an implicit deny statement for everything if it did not find a match before reaching the end.</p>
Step 3	<code>end</code>	Return to privileged EXEC mode.
Step 4	<code>show access-lists</code>	Verify your entries.
Step 5	<code>copy running-config startup-config</code>	(Optional) Save your entries in the configuration file.

To delete an access list, use the **no access-list** *access-list-number* global configuration command.

This example shows how to create an ACL that permits IP traffic from any source to any destination that has the DSCP value set to 32:

```
Switch(config)# access-list 100 permit ip any any dscp 32
```

This example shows how to create an ACL that permits IP traffic from a source host at 10.1.1.1 to a destination host at 10.1.1.2 with a precedence value of 5:

```
Switch(config)# access-list 100 permit ip host 10.1.1.1 host 10.1.1.2 precedence 5
```

This example shows how to create an ACL that permits PIM traffic from any source to a destination group address of 224.0.0.2 with a DSCP set to 32:

```
Switch(config)# access-list 102 permit pim any 224.0.0.2 dscp 32
```

Beginning in privileged EXEC mode, follow these steps to create a Layer 2 MAC ACL for non-IP traffic:

	Command	Purpose
Step 1	<b>configure terminal</b>	Enter global configuration mode.
Step 2	<b>mac access-list extended</b> <i>name</i>	Create a Layer 2 MAC ACL by specifying the name of the list. After entering this command, the mode changes to extended MAC ACL configuration.
Step 3	<b>{permit   deny} {host</b> <i>src-MAC-addr mask</i>   <b>any</b>   <b>host</b> <i>dst-MAC-addr</i>   <i>dst-MAC-addr mask</i> } [ <i>type mask</i> ]	Specify the type of traffic to permit or deny if the conditions are matched, entering the command as many times as necessary. <ul style="list-style-type: none"> <li>For <i>src-MAC-addr</i>, enter the MAC address of the host from which the packet is being sent. You specify this by using the hexadecimal format (H.H.H), by using the <b>any</b> keyword as an abbreviation for <i>source</i> 0.0.0, <i>source-wildcard</i> ffff.ffff.ffff, or by using the <b>host</b> keyword for <i>source</i> 0.0.0.</li> <li>For <i>mask</i>, enter the wildcard bits by placing ones in the bit positions that you want to ignore.</li> <li>For <i>dst-MAC-addr</i>, enter the MAC address of the host to which the packet is being sent. You specify this by using the hexadecimal format (H.H.H), by using the <b>any</b> keyword as an abbreviation for <i>source</i> 0.0.0, <i>source-wildcard</i> ffff.ffff.ffff, or by using the <b>host</b> keyword for <i>source</i> 0.0.0.</li> <li>(Optional) For <i>type mask</i>, specify the Ethertype number of a packet with Ethernet II or SNAP encapsulation to identify the protocol of the packet. For <i>type</i>, the range is from 0 to 65535, typically specified in hexadecimal. For <i>mask</i>, enter the <i>don't care</i> bits applied to the Ethertype before testing for a match.</li> </ul> <p><b>Note</b> When creating an access list, remember that, by default, the end of the access list contains an implicit deny statement for everything if it did not find a match before reaching the end.</p>
Step 4	<b>end</b>	Return to privileged EXEC mode.
Step 5	<b>show access-lists</b> [ <i>access-list-number</i>   <i>access-list-name</i> ]	Verify your entries.
Step 6	<b>copy running-config startup-config</b>	(Optional) Save your entries in the configuration file.

To delete an access list, use the **no mac access-list extended** *access-list-name* global configuration command.

This example shows how to create a Layer 2 MAC ACL with two permit statements. The first statement allows traffic from the host with MAC address 0001.0000.0001 to the host with MAC address 0002.0000.0001. The second statement allows only Ethertype XNS-IDP traffic from the host with MAC address 0001.0000.0002 to the host with MAC address 0002.0000.0002.

```
Switch(config)# mac access-list extended maclist1
Switch(config-ext-macl)# permit 0001.0000.0001 0.0.0 0002.0000.0001 0.0.0
Switch(config-ext-macl)# permit 0001.0000.0002 0.0.0 0002.0000.0002 0.0.0 xns-idp
! (Note: all other access implicitly denied)
```

## Classifying Traffic by Using Class Maps

You use the **class-map** global configuration command to name and to isolate a specific traffic flow (or class) from all other traffic. The class map defines the criteria to use to match against a specific traffic flow to further classify it. Match statements can include criteria such as an ACL, IP precedence values, or DSCP values. The match criterion is defined with one match statement entered within the class-map configuration mode.



### Note

You can also create class-maps during policy map creation by using the **class** policy-map configuration command. For more information, see the “[Classifying, Policing, and Marking Traffic on Physical Ports by Using Policy Maps](#)” section on page 36-48 and the “[Classifying, Policing, and Marking Traffic on SVIs by Using Hierarchical Policy Maps](#)” section on page 36-52.

Beginning in privileged EXEC mode, follow these steps to create a class map and to define the match criterion to classify traffic:

	Command	Purpose
Step 1	<b>configure terminal</b>	Enter global configuration mode.
Step 2	<b>access-list</b> <i>access-list-number</i> { <b>deny</b>   <b>permit</b> } <i>source</i> [ <i>source-wildcard</i> ] or <b>access-list</b> <i>access-list-number</i> { <b>deny</b>   <b>permit</b> } <i>protocol source</i> [ <i>source-wildcard</i> ] <i>destination</i> [ <i>destination-wildcard</i> ] or <b>mac access-list extended</b> <i>name</i> { <b>permit</b>   <b>deny</b> } { <b>host</b> <i>src-MAC-addr mask</i>   <b>any</b>   <b>host</b> <i>dst-MAC-addr</i>   <i>dst-MAC-addr mask</i> } [ <i>type mask</i> ]	Create an IP standard or extended ACL for IP traffic or a Layer 2 MAC ACL for non-IP traffic, repeating the command as many times as necessary.  For more information, see the “ <a href="#">Classifying Traffic by Using ACLs</a> ” section on page 36-43.  <b>Note</b> When creating an access list, remember that, by default, the end of the access list contains an implicit deny statement for everything if it did not find a match before reaching the end.
Step 3	<b>class-map</b> [ <b>match-all</b>   <b>match-any</b> ] <i>class-map-name</i>	Create a class map, and enter class-map configuration mode.  By default, no class maps are defined. <ul style="list-style-type: none"> <li>• (Optional) Use the <b>match-all</b> keyword to perform a logical-AND of all matching statements under this class map. All match criteria in the class map must be matched.</li> <li>• (Optional) Use the <b>match-any</b> keyword to perform a logical-OR of all matching statements under this class map. One or more match criteria must be matched.</li> <li>• For <i>class-map-name</i>, specify the name of the class map.</li> </ul> If neither the <b>match-all</b> or <b>match-any</b> keyword is specified, the default is <b>match-all</b> .  <b>Note</b> Because only one <b>match</b> command per class map is supported, the <b>match-all</b> and <b>match-any</b> keywords function the same. See the “ <a href="#">Creating Named Standard and Extended ACLs</a> ” section on page 34-15 for limitations when using the <b>match-all</b> and the <b>match-any</b> keywords.

	Command	Purpose
Step 4	<b>match</b> { <b>access-group</b> <i>acl-index-or-name</i>   <b>ip dscp</b> <i>dscp-list</i>   <b>ip precedence</b> <i>ip-precedence-list</i> }	<p>Define the match criterion to classify traffic.</p> <p>By default, no match criterion is defined.</p> <p>Only one match criterion per class map is supported, and only one ACL per class map is supported.</p> <ul style="list-style-type: none"> <li>For <b>access-group</b> <i>acl-index-or-name</i>, specify the number or name of the ACL created in Step 2.</li> <li>For <b>ip dscp</b> <i>dscp-list</i>, enter a list of up to eight IP DSCP values to match against incoming packets. Separate each value with a space. The range is 0 to 63.</li> <li>For <b>ip precedence</b> <i>ip-precedence-list</i>, enter a list of up to eight IP-precedence values to match against incoming packets. Separate each value with a space. The range is 0 to 7.</li> </ul>
Step 5	<b>end</b>	Return to privileged EXEC mode.
Step 6	<b>show class-map</b>	Verify your entries.
Step 7	<b>copy running-config startup-config</b>	(Optional) Save your entries in the configuration file.

To delete an existing policy map, use the **no policy-map** *policy-map-name* global configuration command. To delete an existing class map, use the **no class-map** [**match-all** | **match-any**] *class-map-name* global configuration command. To remove a match criterion, use the **no match** {**access-group** *acl-index-or-name* | **ip dscp** | **ip precedence**} class-map configuration command.

This example shows how to configure the class map called *class1*. The *class1* has one match criterion, which is access list 103. It permits traffic from any host to any destination that matches a DSCP value of 10.

```
Switch(config)# access-list 103 permit ip any any dscp 10
Switch(config)# class-map class1
Switch(config-cmap)# match access-group 103
Switch(config-cmap)# end
Switch#
```

This example shows how to create a class map called *class2*, which matches incoming traffic with DSCP values of 10, 11, and 12.

```
Switch(config)# class-map class2
Switch(config-cmap)# match ip dscp 10 11 12
Switch(config-cmap)# end
Switch#
```

This example shows how to create a class map called *class3*, which matches incoming traffic with IP-precedence values of 5, 6, and 7:

```
Switch(config)# class-map class3
Switch(config-cmap)# match ip precedence 5 6 7
Switch(config-cmap)# end
Switch#
```

## Classifying, Policing, and Marking Traffic on Physical Ports by Using Policy Maps

You can configure a nonhierarchical policy map on a physical port that specifies which traffic class to act on. Actions can include trusting the CoS, DSCP, or IP precedence values in the traffic class; setting a specific DSCP or IP precedence value in the traffic class; and specifying the traffic bandwidth limitations for each matched traffic class (policer) and the action to take when the traffic is out of profile (marking).

A policy map also has these characteristics:

- A policy map can contain multiple class statements, each with different match criteria and policers.
- A separate policy-map class can exist for each type of traffic received through a port.

Follow these guidelines when configuring policy maps on physical ports:

- You can attach only one policy map per ingress port.
- If you configure the IP-precedence-to-DSCP map by using the **mls qos map ip-prec-dscp dscp1...dscp8** global configuration command, the settings only affect packets on ingress interfaces that are configured to trust the IP precedence value. In a policy map, if you set the packet IP precedence value to a new value by using the **set ip precedence new-precedence** policy-map class configuration command, the egress DSCP value is not affected by the IP-precedence-to-DSCP map. If you want the egress DSCP value to be different than the ingress value, use the **set dscp new-dscp** policy-map class configuration command.
- If you enter or have used the **set ip dscp** command, the switch changes this command to **set dscp** in its configuration.
- You can use the **set ip precedence** or the **set precedence** policy-map class configuration command to change the packet IP precedence value. This setting appears as **set ip precedence** in the switch configuration.
- You can configure a separate second-level policy map for each class defined for the port. The second-level policy map specifies the police action to take for each traffic class. For information on configuring a hierarchical policy map, see [Classifying, Policing, and Marking Traffic on SVIs by Using Hierarchical Policy Maps](#), page 36-52.



Beginning in privileged EXEC mode, follow these steps to create a nonhierarchical policy map:

	Command	Purpose
Step 1	<b>configure terminal</b>	Enter global configuration mode.
Step 2	<b>class-map</b> [ <b>match-all</b>   <b>match-any</b> ] <i>class-map-name</i>	<p>Create a class map, and enter class-map configuration mode.</p> <p>By default, no class maps are defined.</p> <ul style="list-style-type: none"> <li>• (Optional) Use the <b>match-all</b> keyword to perform a logical-AND of all matching statements under this class map. All match criteria in the class map must be matched.</li> <li>• (Optional) Use the <b>match-any</b> keyword to perform a logical-OR of all matching statements under this class map. One or more match criteria must be matched.</li> <li>• For <i>class-map-name</i>, specify the name of the class map.</li> </ul> <p>If neither the <b>match-all</b> or <b>match-any</b> keyword is specified, the default is <b>match-all</b>.</p> <p><b>Note</b> Because only one <b>match</b> command per class map is supported, the <b>match-all</b> and <b>match-any</b> keywords function the same. See the <a href="#">“Creating Named Standard and Extended ACLs”</a> section on page 34-15 for limitations when using the <b>match-all</b> and the <b>match-any</b> keywords.</p>
Step 3	<b>policy-map</b> <i>policy-map-name</i>	<p>Create a policy map by entering the policy map name, and enter policy-map configuration mode.</p> <p>By default, no policy maps are defined.</p> <p>The default behavior of a policy map is to set the DSCP to 0 if the packet is an IP packet and to set the CoS to 0 if the packet is tagged. No policing is performed.</p>
Step 4	<b>class</b> <i>class-map-name</i>	<p>Define a traffic classification, and enter policy-map class configuration mode.</p> <p>By default, no policy map class-maps are defined.</p> <p>If a traffic class has already been defined by using the <b>class-map</b> global configuration command, specify its name for <i>class-map-name</i> in this command.</p>

Command	Purpose
<b>Step 5</b> <b>trust [cos   dscp   ip-precedence]</b>	<p>Configure the trust state, which QoS uses to generate a CoS-based or DSCP-based QoS label.</p> <p><b>Note</b> This command is mutually exclusive with the <b>set</b> command within the same policy map. If you enter the <b>trust</b> command, go to Step 6.</p> <p>By default, the port is not trusted. If no keyword is specified when the command is entered, the default is <b>dscp</b>.</p> <p>The keywords have these meanings:</p> <ul style="list-style-type: none"> <li>• <b>cos</b>—QoS derives the DSCP value by using the received or default port CoS value and the CoS-to-DSCP map.</li> <li>• <b>dscp</b>—QoS derives the DSCP value by using the DSCP value from the ingress packet. For non-IP packets that are tagged, QoS derives the DSCP value by using the received CoS value; for non-IP packets that are untagged, QoS derives the DSCP value by using the default port CoS value. In either case, the DSCP value is derived from the CoS-to-DSCP map.</li> <li>• <b>ip-precedence</b>—QoS derives the DSCP value by using the IP precedence value from the ingress packet and the IP-precedence-to-DSCP map. For non-IP packets that are tagged, QoS derives the DSCP value by using the received CoS value; for non-IP packets that are untagged, QoS derives the DSCP value by using the default port CoS value. In either case, the DSCP value is derived from the CoS-to-DSCP map.</li> </ul> <p>For more information, see the <a href="#">“Configuring the CoS-to-DSCP Map” section on page 36-60</a>.</p>
<b>Step 6</b> <b>set {dscp new-dscp   ip precedence new-precedence}</b>	<p>Classify IP traffic by setting a new value in the packet.</p> <ul style="list-style-type: none"> <li>• For <b>dscp new-dscp</b>, enter a new DSCP value to be assigned to the classified traffic. The range is 0 to 63.</li> <li>• For <b>ip precedence new-precedence</b>, enter a new IP-precedence value to be assigned to the classified traffic. The range is 0 to 7.</li> </ul>
<b>Step 7</b> <b>police rate-bps burst-byte [exceed-action {drop   policed-dscp-transmit}]</b>	<p>Define a policer for the classified traffic.</p> <p>By default, no policer is defined. For information on the number of policers supported, see the <a href="#">“Standard QoS Configuration Guidelines” section on page 36-32</a>.</p> <ul style="list-style-type: none"> <li>• For <i>rate-bps</i>, specify average traffic rate in bits per second (b/s). The range is 8000 to 1000000000.</li> <li>• For <i>burst-byte</i>, specify the normal burst size in bytes. The range is 8000 to 1000000.</li> <li>• (Optional) Specify the action to take when the rates are exceeded. Use the <b>exceed-action drop</b> keywords to drop the packet. Use the <b>exceed-action policed-dscp-transmit</b> keywords to mark down the DSCP value (by using the policed-DSCP map) and to send the packet. For more information, see the <a href="#">“Configuring the Policed-DSCP Map” section on page 36-62</a>.</li> </ul>

	Command	Purpose
Step 8	<b>exit</b>	Return to policy map configuration mode.
Step 9	<b>exit</b>	Return to global configuration mode.
Step 10	<b>interface</b> <i>interface-id</i>	Specify the port to attach to the policy map, and enter interface configuration mode.  Valid interfaces include physical ports.
Step 11	<b>service-policy input</b> <i>policy-map-name</i>	Specify the policy-map name, and apply it to an ingress port.  Only one policy map per ingress port is supported.
Step 12	<b>end</b>	Return to privileged EXEC mode.
Step 13	<b>show policy-map</b> [ <i>policy-map-name</i> [ <b>class</b> <i>class-map-name</i> ]]	Verify your entries.
Step 14	<b>copy running-config startup-config</b>	(Optional) Save your entries in the configuration file.

To delete an existing policy map, use the **no policy-map** *policy-map-name* global configuration command. To delete an existing class map, use the **no class** *class-map-name* policy-map configuration command. To return to the untrusted state, use the **no trust** policy-map configuration command. To remove an assigned DSCP or IP precedence value, use the **no set** {**dscp** *new-dscp* | **ip precedence** *new-precedence*} policy-map configuration command. To remove an existing policer, use the **no police** *rate-bps burst-byte* [**exceed-action** {**drop** | **policed-dscp-transmit**}] policy-map configuration command. To remove the policy map and port association, use the **no service-policy input** *policy-map-name* interface configuration command.

This example shows how to create a policy map and attach it to an ingress port. In the configuration, the IP standard ACL permits traffic from network 10.1.0.0. For traffic matching this classification, the DSCP value in the incoming packet is trusted. If the matched traffic exceeds an average traffic rate of 48000 b/s and a normal burst size of 8000 bytes, its DSCP is marked down (based on the policed-DSCP map) and sent:

```
Switch(config)# access-list 1 permit 10.1.0.0 0.0.255.255
Switch(config)# class-map ipclass1
Switch(config-cmap)# match access-group 1
Switch(config-cmap)# exit
Switch(config)# policy-map flow1t
Switch(config-pmap)# class ipclass1
Switch(config-pmap-c)# trust dscp
Switch(config-pmap-c)# police 1000000 8000 exceed-action policed-dscp-transmit
Switch(config-pmap-c)# exit
Switch(config-pmap)# exit
Switch(config)# interface gigabitethernet2/0/1
Switch(config-if)# service-policy input flow1t
```

This example shows how to create a Layer 2 MAC ACL with two permit statements and attach it to an ingress port. The first permit statement allows traffic from the host with MAC address 0001.0000.0001 destined for the host with MAC address 0002.0000.0001. The second permit statement allows only Ethertype XNS-IDP traffic from the host with MAC address 0001.0000.0002 destined for the host with MAC address 0002.0000.0002.

```
Switch(config)# mac access-list extended maclist1
Switch(config-ext-mac)# permit 0001.0000.0001 0.0.0 0002.0000.0001 0.0.0
Switch(config-ext-mac)# permit 0001.0000.0002 0.0.0 0002.0000.0002 0.0.0 xns-idp
Switch(config-ext-mac)# exit
Switch(config)# mac access-list extended maclist2
Switch(config-ext-mac)# permit 0001.0000.0003 0.0.0 0002.0000.0003 0.0.0
Switch(config-ext-mac)# permit 0001.0000.0004 0.0.0 0002.0000.0004 0.0.0 aarp
```

```

Switch(config-ext-mac)# exit
Switch(config)# class-map macclass1
Switch(config-cmap)# match access-group maclist1
Switch(config-cmap)# exit
Switch(config)# policy-map macpolicy1
Switch(config-pmap)# class macclass1
Switch(config-pmap-c)# set dscp 63
Switch(config-pmap-c)# exit
Switch(config-pmap)# class macclass2 maclist2
Switch(config-pmap-c)# set dscp 45
Switch(config-pmap-c)# exit
Switch(config-pmap)# exit
Switch(config)# interface gigabitethernet1/0/1
Switch(config-if)# mls qos trust cos
Switch(config-if)# service-policy input macpolicy1

```

## Classifying, Policing, and Marking Traffic on SVIs by Using Hierarchical Policy Maps

You can configure hierarchical policy maps on SVIs, but not on other types of interfaces. Hierarchical policing combines the VLAN- and interface-level policy maps to create a single policy map.

On an SVI, the VLAN-level policy map specifies which traffic class to act on. Actions can include trusting the CoS, DSCP, or IP precedence values or setting a specific DSCP or IP precedence value in the traffic class. Use the interface-level policy map to specify the physical ports that are affected by individual policers.

Follow these guidelines when configuring hierarchical policy maps:

- Before configuring a hierarchical policy map, you must enable VLAN-based QoS on the physical ports that are to be specified at the interface level of the policy map.
- You can attach only one policy map per ingress port or SVI.
- A policy map can contain multiple class statements, each with different match criteria and actions.
- A separate policy-map class can exist for each type of traffic received on the SVI.
- If you configure the IP-precedence-to-DSCP map by using the **mls qos map ip-prec-dscp dscp1...dscp8** global configuration command, the settings only affect packets on ingress interfaces that are configured to trust the IP precedence value. In a policy map, if you set the packet IP precedence value to a new value by using the **set ip precedence new-precedence** policy-map class configuration command, the egress DSCP value is not affected by the IP-precedence-to-DSCP map. If you want the egress DSCP value to be different than the ingress value, use the **set dscp new-dscp** policy-map class configuration command.
- If you enter or have used the **set ip dscp** command, the switch changes this command to **set dscp** in its configuration. If you enter the **set ip dscp** command, this setting appears as **set dscp** in the switch configuration.
- You can use the **set ip precedence** or the **set precedence** policy-map class configuration command to change the packet IP precedence value. This setting appears as **set ip precedence** in the switch configuration.
- If VLAN-based QoS is enabled, the hierarchical policy map supersedes the previously configured port-based policy map.
- The hierarchical policy map is attached to the SVI and affects all traffic belonging to the VLAN. The actions specified in the VLAN-level policy map affect the traffic belonging to the SVI. The police action on the port-level policy map affects the ingress traffic on the affected physical interfaces.

- When configuring a hierarchical policy map on trunk ports, the VLAN ranges must not overlap. If the ranges overlap, the actions specified in the policy map affect the incoming and outgoing traffic on the overlapped VLANs.
- Aggregate policers are not supported in hierarchical policy maps.
- When VLAN-based QoS is enabled, the switch supports VLAN-based features, such as the VLAN map.
- You can configure a hierarchical policy map only on the primary VLAN of a private VLAN.
- When you enable VLAN-based QoS and configure a hierarchical policy map in a switch stack, these automatic actions occur when the stack configuration changes:
  - When a new stack master is selected, the stack master re-enables and reconfigures these features on all applicable interfaces on the stack master.
  - When a stack member is added, the stack master re-enables and reconfigures these features on all applicable ports on the stack member.
  - When you merge switch stacks, the new stack master re-enables and reconfigures these features on the switches in the new stack.
  - When the switch stack divides into two or more switch stacks, the stack master in each switch stack re-enables and reconfigures these features on all applicable interfaces on the stack members, including the stack master.

Beginning in privileged EXEC mode, follow these steps to create a hierarchical policy map:

	Command	Purpose
Step 1	<b>configure terminal</b>	Enter global configuration mode.
Step 2	<b>class-map [match-all   match-any]</b> <i>class-map-name</i>	<p>Create a VLAN-level class map, and enter class-map configuration mode. For information about creating a class map, see the <a href="#">“Classifying Traffic by Using Class Maps”</a> section on page 36-46.</p> <p>By default, no class maps are defined.</p> <ul style="list-style-type: none"> <li>• (Optional) Use the <b>match-all</b> keyword to perform a logical-AND of all matching statements under this class map. All match criteria in the class map must be matched.</li> <li>• (Optional) Use the <b>match-any</b> keyword to perform a logical-OR of all matching statements under this class map. One or more match criteria must be matched.</li> <li>• For <i>class-map-name</i>, specify the name of the class map.</li> </ul> <p>If neither the <b>match-all</b> or <b>match-any</b> keyword is specified, the default is <b>match-all</b>.</p> <p><b>Note</b> Because only one <b>match</b> command per class map is supported, the <b>match-all</b> and <b>match-any</b> keywords function the same. See the <a href="#">“Creating Named Standard and Extended ACLs”</a> section on page 34-15 for limitations when using the <b>match-all</b> and the <b>match-any</b> keywords.</p>

	Command	Purpose
Step 3	<b>match</b> { <b>access-group</b> <i>acl-index-or-name</i>   <b>ip dscp</b> <i>dscp-list</i>   <b>ip precedence</b> <i>ip-precedence-list</i> }	<p>Define the match criterion to classify traffic.</p> <p>By default, no match criterion is defined.</p> <p>Only one match criterion per class map is supported, and only one ACL per class map is supported.</p> <ul style="list-style-type: none"> <li>For <b>access-group</b> <i>acl-index-or-name</i>, specify the number or name of the ACL.</li> <li>For <b>ip dscp</b> <i>dscp-list</i>, enter a list of up to eight IP DSCP values to match against incoming packets. Separate each value with a space. The range is 0 to 63.</li> <li>For <b>ip precedence</b> <i>ip-precedence-list</i>, enter a list of up to eight IP-precedence values to match against incoming packets. Separate each value with a space. The range is 0 to 7.</li> </ul>
Step 4	<b>exit</b>	Return to class-map configuration mode.
Step 5	<b>exit</b>	Return to global configuration mode.
Step 6	<b>class-map</b> [ <b>match-all</b>   <b>match-any</b> ] <i>class-map-name</i>	<p>Create an interface-level class map, and enter class-map configuration mode.</p> <p>By default, no class maps are defined.</p> <ul style="list-style-type: none"> <li>(Optional) Use the <b>match-all</b> keyword to perform a logical-AND of all matching statements under this class map. All match criteria in the class map must be matched.</li> <li>(Optional) Use the <b>match-any</b> keyword to perform a logical-OR of all matching statements under this class map. One or more match criteria must be matched.</li> <li>For <i>class-map-name</i>, specify the name of the class map.</li> </ul> <p>If neither the <b>match-all</b> or <b>match-any</b> keyword is specified, the default is <b>match-all</b>.</p> <p><b>Note</b> Because only one <b>match</b> command per class map is supported, the <b>match-all</b> and <b>match-any</b> keywords function the same. See the <a href="#">“Creating Named Standard and Extended ACLs”</a> section on page 34-15 for limitations when using the <b>match-all</b> and the <b>match-any</b> keywords.</p>
Step 7	<b>match input-interface</b> <i>interface-id-list</i>	<p>Specify the physical ports on which the interface-level class map acts. You can specify up to six ports as follows:</p> <ul style="list-style-type: none"> <li>A single port (counts as one entry)</li> <li>A list of ports separated by a space (each port counts as an entry)</li> <li>A range of ports separated by a hyphen (counts as two entries)</li> </ul> <p>This command can only be used in the child-level policy map and must be the only match condition in the child-level policy map.</p>
Step 8	<b>exit</b>	Return to class-map configuration mode.
Step 9	<b>exit</b>	Return to global configuration mode.

	Command	Purpose
Step 10	<b>policy-map</b> <i>policy-map-name</i>	Create an interface-level policy map by entering the policy-map name, and enter policy-map configuration mode.  By default, no policy maps are defined, and no policing is performed.
Step 11	<b>class-map</b> <i>class-map-name</i>	Define an interface-level traffic classification, and enter policy-map configuration mode.  By default, no policy-map class-maps are defined.  If a traffic class has already been defined by using the <b>class-map</b> global configuration command, specify its name for <i>class-map-name</i> in this command.
Step 12	<b>police</b> <i>rate-bps burst-byte</i> [ <b>exceed-action</b> { <b>drop</b>   <b>policed-dscp-transmit</b> }]	Define an individual policer for the classified traffic.  By default, no policer is defined. For information on the number of policers supported, see the <a href="#">“Standard QoS Configuration Guidelines” section on page 36-32</a> .  <ul style="list-style-type: none"> <li>For <i>rate-bps</i>, specify average traffic rate in bits per second (b/s). The range is 8000 to 1000000000.</li> <li>For <i>burst-byte</i>, specify the normal burst size in bytes. The range is 8000 to 1000000.</li> <li>(Optional) Specify the action to take when the rates are exceeded. Use the <b>exceed-action drop</b> keywords to drop the packet. Use the <b>exceed-action policed-dscp-transmit</b> keywords to mark down the DSCP value (by using the policed-DSCP map) and to send the packet. For more information, see the <a href="#">“Configuring the Policed-DSCP Map” section on page 36-62</a>.</li> </ul>
Step 13	<b>exit</b>	Return to policy-map configuration mode.
Step 14	<b>exit</b>	Return to global configuration mode.
Step 15	<b>policy-map</b> <i>policy-map-name</i>	Create a VLAN-level policy map by entering the policy-map name, and enter policy-map configuration mode.  By default, no policy maps are defined.  The default behavior of a policy map is to set the DSCP to 0 if the packet is an IP packet and to set the CoS to 0 if the packet is tagged. No policing is performed.
Step 16	<b>class</b> <i>class-map-name</i>	Define a VLAN-level traffic classification, and enter policy-map class configuration mode.  By default, no policy-map class-maps are defined.  If a traffic class has already been defined by using the <b>class-map</b> global configuration command, specify its name for <i>class-map-name</i> in this command.

Command	Purpose
<b>Step 17</b> <code>trust [cos   dscp   ip-precedence]</code>	<p>Configure the trust state, which QoS uses to generate a CoS-based or DSCP-based QoS label.</p> <p><b>Note</b> This command is mutually exclusive with the <code>set</code> command within the same policy map. If you enter the <code>trust</code> command, omit Step 18.</p> <p>By default, the port is not trusted. If no keyword is specified when the command is entered, the default is <code>dscp</code>.</p> <p>The keywords have these meanings:</p> <ul style="list-style-type: none"> <li>• <b>cos</b>—QoS derives the DSCP value by using the received or default port CoS value and the CoS-to-DSCP map.</li> <li>• <b>dscp</b>—QoS derives the DSCP value by using the DSCP value from the ingress packet. For non-IP packets that are tagged, QoS derives the DSCP value by using the received CoS value; for non-IP packets that are untagged, QoS derives the DSCP value by using the default port CoS value. In either case, the DSCP value is derived from the CoS-to-DSCP map.</li> <li>• <b>ip-precedence</b>—QoS derives the DSCP value by using the IP precedence value from the ingress packet and the IP-precedence-to-DSCP map. For non-IP packets that are tagged, QoS derives the DSCP value by using the received CoS value; for non-IP packets that are untagged, QoS derives the DSCP value by using the default port CoS value. In either case, the DSCP value is derived from the CoS-to-DSCP map.</li> </ul> <p>For more information, see the “<a href="#">Configuring the CoS-to-DSCP Map</a>” section on page 36-60.</p>
<b>Step 18</b> <code>set {dscp new-dscp   ip precedence new-precedence}</code>	<p>Classify IP traffic by setting a new value in the packet.</p> <ul style="list-style-type: none"> <li>• For <code>dscp new-dscp</code>, enter a new DSCP value to be assigned to the classified traffic. The range is 0 to 63.</li> <li>• For <code>ip precedence new-precedence</code>, enter a new IP-precedence value to be assigned to the classified traffic. The range is 0 to 7.</li> </ul>
<b>Step 19</b> <code>service-policy policy-map-name</code>	<p>Specify the interface-level policy-map name (from Step 10) and associate it with the VLAN-level policy map.</p> <p>If the VLAN-level policy map specifies more than one class, each class can have a different <code>service-policy policy-map-name</code> command.</p>
<b>Step 20</b> <code>exit</code>	<p>Return to policy-map configuration mode.</p>
<b>Step 21</b> <code>exit</code>	<p>Return to global configuration mode.</p>
<b>Step 22</b> <code>interface interface-id</code>	<p>Specify the SVI to which to attach the hierarchical policy map, and enter interface configuration mode.</p>



	Command	Purpose
Step 23	<b>service-policy input</b> <i>policy-map-name</i>	Specify the VLAN-level policy-map name, and apply it to the SVI. Repeat the previous step and this command to apply the policy map to other SVIs.  If the hierarchical VLAN-level policy map has more than one interface-level policy map, all class maps must be configured to the same VLAN-level policy map specified in the <b>service-policy</b> <i>policy-map-name</i> command.
Step 24	<b>end</b>	Return to privileged EXEC mode.
Step 25	<b>show policy-map</b> [ <i>policy-map-name</i> [ <b>class</b> <i>class-map-name</i> ]]  or  <b>show mls qos vlan-based</b>	Verify your entries.
Step 26	<b>copy running-config startup-config</b>	(Optional) Save your entries in the configuration file.

To delete an existing policy map, use the **no policy-map** *policy-map-name* global configuration command. To delete an existing class map, use the **no class** *class-map-name* policy-map configuration command.

To return to the untrusted state in a policy map, use the **no trust** policy-map configuration command. To remove an assigned DSCP or IP precedence value, use the **no set** {**dscp** *new-dscp* | **ip precedence** *new-precedence*} policy-map configuration command.

To remove an existing policer in an interface-level policy map, use the **no police** *rate-bps burst-byte* [**exceed-action** {**drop** | **policed-dscp-transmit**}] policy-map configuration command. To remove the hierarchical policy map and port associations, use the **no service-policy input** *policy-map-name* interface configuration command.

This example shows how to create a hierarchical policy map:

```
Switch> enable
Switch# configure terminal
Enter configuration commands, one per line. End with CNTL/Z.
Switch(config)# access-list 101 permit ip any any
Switch(config)# class-map cm-1
Switch(config-cmap)# match access 101
Switch(config-cmap)# exit
Switch(config)# exit
Switch#
Switch#
```

This example shows how to attach the new map to an SVI:

```
Switch# configure terminal
Enter configuration commands, one per line. End with CNTL/Z.
Switch(config)# class-map cm-interface-1
Switch(config-cmap)# match input gigabitethernet3/0/1 - gigabitethernet3/0/2
Switch(config-cmap)# exit
Switch(config)# policy-map port-plcmap
Switch(config-pmap)# class-map cm-interface-1
Switch(config-pmap-c)# police 900000 9000 exc policed-dscp-transmit
Switch(config-pmap-c)# exit
Switch(config-pmap)# exit
Switch(config)# policy-map vlan-plcmap
Switch(config-pmap)# class-map cm-1
Switch(config-pmap-c)# set dscp 7
Switch(config-pmap-c)# service-policy port-plcmap-1
```

```

Switch(config-pmap-c) # exit
Switch(config-pmap) # class-map cm-2
Switch(config-pmap-c) # match ip dscp 2
Switch(config-pmap-c) # service-policy port-plcmap-1
Switch(config-pmap) # exit
Switch(config-pmap) # class-map cm-3
Switch(config-pmap-c) # match ip dscp 3
Switch(config-pmap-c) # service-policy port-plcmap-2
Switch(config-pmap) # exit
Switch(config-pmap) # class-map cm-4
Switch(config-pmap-c) # trust dscp
Switch(config-pmap) # exit
Switch(config) # interface vlan 10
Switch(config-if) #
Switch(config-if) # service input vlan-plcmap
Switch(config-if) # exit
Switch(config) # exit
Switch#

```

## Classifying, Policing, and Marking Traffic by Using Aggregate Policers

By using an aggregate policer, you can create a policer that is shared by multiple traffic classes within the same policy map. However, you cannot use the aggregate policer across different policy maps or ports.

You can configure aggregate policers only in nonhierarchical policy maps on physical ports.

Beginning in privileged EXEC mode, follow these steps to create an aggregate policer:

	Command	Purpose
Step 1	<b>configure terminal</b>	Enter global configuration mode.
Step 2	<b>mls qos aggregate-policer</b> <i>aggregate-policer-name rate-bps burst-byte</i> <b>exceed-action {drop  </b> <b>policed-dscp-transmit}</b>	<p>Define the policer parameters that can be applied to multiple traffic classes within the same policy map.</p> <p>By default, no aggregate policer is defined. For information on the number of policers supported, see the <a href="#">“Standard QoS Configuration Guidelines”</a> section on page 36-32.</p> <ul style="list-style-type: none"> <li>For <i>aggregate-policer-name</i>, specify the name of the aggregate policer.</li> <li>For <i>rate-bps</i>, specify average traffic rate in bits per second (b/s). The range is 8000 to 1000000000.</li> <li>For <i>burst-byte</i>, specify the normal burst size in bytes. The range is 8000 to 1000000.</li> <li>Specify the action to take when the rates are exceeded. Use the <b>exceed-action drop</b> keywords to drop the packet. Use the <b>exceed-action policed-dscp-transmit</b> keywords to mark down the DSCP value (by using the policed-DSCP map) and to send the packet. For more information, see the <a href="#">“Configuring the Policed-DSCP Map”</a> section on page 36-62.</li> </ul>
Step 3	<b>class-map [match-all   match-any]</b> <i>class-map-name</i>	Create a class map to classify traffic as necessary. For more information, see the <a href="#">“Classifying Traffic by Using Class Maps”</a> section on page 36-46 and the <a href="#">“Creating Named Standard and Extended ACLs”</a> section on page 34-15.

	Command	Purpose
Step 4	<b>policy-map</b> <i>policy-map-name</i>	Create a policy map by entering the policy map name, and enter policy-map configuration mode.  For more information, see the “ <a href="#">Classifying, Policing, and Marking Traffic on Physical Ports by Using Policy Maps</a> ” section on page 36-48.
Step 5	<b>class</b> <i>class-map-name</i>	Define a traffic classification, and enter policy-map class configuration mode.  For more information, see the “ <a href="#">Classifying, Policing, and Marking Traffic on Physical Ports by Using Policy Maps</a> ” section on page 36-48.
Step 6	<b>police aggregate</b> <i>aggregate-policer-name</i>	Apply an aggregate policer to multiple classes in the same policy map.  For <i>aggregate-policer-name</i> , enter the name specified in Step 2.
Step 7	<b>exit</b>	Return to global configuration mode.
Step 8	<b>interface</b> <i>interface-id</i>	Specify the port to attach to the policy map, and enter interface configuration mode.  Valid interfaces include physical ports.
Step 9	<b>service-policy input</b> <i>policy-map-name</i>	Specify the policy-map name, and apply it to an ingress port.  Only one policy map per ingress port is supported.
Step 10	<b>end</b>	Return to privileged EXEC mode.
Step 11	<b>show mls qos aggregate-policer</b> [ <i>aggregate-policer-name</i> ]	Verify your entries.
Step 12	<b>copy running-config startup-config</b>	(Optional) Save your entries in the configuration file.

To remove the specified aggregate policer from a policy map, use the **no police aggregate** *aggregate-policer-name* policy map configuration mode. To delete an aggregate policer and its parameters, use the **no mls qos aggregate-policer** *aggregate-policer-name* global configuration command.

This example shows how to create an aggregate policer and attach it to multiple classes within a policy map. In the configuration, the IP ACLs permit traffic from network 10.1.0.0 and from host 11.3.1.1. For traffic coming from network 10.1.0.0, the DSCP in the incoming packets is trusted. For traffic coming from host 11.3.1.1, the DSCP in the packet is changed to 56. The traffic rate from the 10.1.0.0 network and from host 11.3.1.1 is policed. If the traffic exceeds an average rate of 48000 b/s and a normal burst size of 8000 bytes, its DSCP is marked down (based on the policed-DSCP map) and sent. The policy map is attached to an ingress port.

```
Switch(config)# access-list 1 permit 10.1.0.0 0.0.255.255
Switch(config)# access-list 2 permit 11.3.1.1
Switch(config)# mls qos aggregate-police transmit1 48000 8000 exceed-action
policed-dscp-transmit
Switch(config)# class-map ipclass1
Switch(config-cmap)# match access-group 1
Switch(config-cmap)# exit
Switch(config)# class-map ipclass2
Switch(config-cmap)# match access-group 2
Switch(config-cmap)# exit
Switch(config)# policy-map aggflow1
Switch(config-pmap)# class ipclass1
```

```

Switch(config-pmap-c) # trust dscp
Switch(config-pmap-c) # police aggregate transmit1
Switch(config-pmap-c) # exit
Switch(config-pmap) # class ipclass2
Switch(config-pmap-c) # set dscp 56
Switch(config-pmap-c) # police aggregate transmit1
Switch(config-pmap-c) # exit
Switch(config-pmap) # exit
Switch(config) # interface gigabitethernet2/0/1
Switch(config-if) # service-policy input aggflow1
Switch(config-if) # exit

```

## Configuring DSCP Maps

These sections contain this configuration information:

- [Configuring the CoS-to-DSCP Map, page 36-60](#) (optional)
- [Configuring the IP-Precedence-to-DSCP Map, page 36-61](#) (optional)
- [Configuring the Policed-DSCP Map, page 36-62](#) (optional, unless the null settings in the map are not appropriate)
- [Configuring the DSCP-to-CoS Map, page 36-63](#) (optional)
- [Configuring the DSCP-to-DSCP-Mutation Map, page 36-64](#) (optional, unless the null settings in the map are not appropriate)

All the maps, except the DSCP-to-DSCP-mutation map, are globally defined and are applied to all ports.

### Configuring the CoS-to-DSCP Map

You use the CoS-to-DSCP map to map CoS values in incoming packets to a DSCP value that QoS uses internally to represent the priority of the traffic.

[Table 36-12](#) shows the default CoS-to-DSCP map.

**Table 36-12** Default CoS-to-DSCP Map

CoS Value	DSCP Value
0	0
1	8
2	16
3	24
4	32
5	40
6	48
7	56

If these values are not appropriate for your network, you need to modify them.

Beginning in privileged EXEC mode, follow these steps to modify the CoS-to-DSCP map. This procedure is optional.

	Command	Purpose
Step 1	<b>configure terminal</b>	Enter global configuration mode.
Step 2	<b>mls qos map cos-dscp</b> <i>dscp1...dscp8</i>	Modify the CoS-to-DSCP map.  For <i>dscp1...dscp8</i> , enter eight DSCP values that correspond to CoS values 0 to 7. Separate each DSCP value with a space.  The DSCP range is 0 to 63.
Step 3	<b>end</b>	Return to privileged EXEC mode.
Step 4	<b>show mls qos maps cos-dscp</b>	Verify your entries.
Step 5	<b>copy running-config startup-config</b>	(Optional) Save your entries in the configuration file.

To return to the default map, use the **no mls qos cos-dscp** global configuration command.

This example shows how to modify and display the CoS-to-DSCP map:

```
Switch(config)# mls qos map cos-dscp 10 15 20 25 30 35 40 45
Switch(config)# end
Switch# show mls qos maps cos-dscp
```

```
Cos-dscp map:
  cos:   0  1  2  3  4  5  6  7
-----
  dscp:  10 15 20 25 30 35 40 45
```

## Configuring the IP-Precedence-to-DSCP Map

You use the IP-precedence-to-DSCP map to map IP precedence values in incoming packets to a DSCP value that QoS uses internally to represent the priority of the traffic.

Table 36-13 shows the default IP-precedence-to-DSCP map:

**Table 36-13** Default IP-Precedence-to-DSCP Map

IP Precedence Value	DSCP Value
0	0
1	8
2	16
3	24
4	32
5	40
6	48
7	56

If these values are not appropriate for your network, you need to modify them.

Beginning in privileged EXEC mode, follow these steps to modify the IP-precedence-to-DSCP map. This procedure is optional.

	Command	Purpose
Step 1	<b>configure terminal</b>	Enter global configuration mode.
Step 2	<b>mls qos map ip-prec-dscp</b> <i>dscp1...dscp8</i>	Modify the IP-precedence-to-DSCP map. For <i>dscp1...dscp8</i> , enter eight DSCP values that correspond to the IP precedence values 0 to 7. Separate each DSCP value with a space. The DSCP range is 0 to 63.
Step 3	<b>end</b>	Return to privileged EXEC mode.
Step 4	<b>show mls qos maps ip-prec-dscp</b>	Verify your entries.
Step 5	<b>copy running-config startup-config</b>	(Optional) Save your entries in the configuration file.

To return to the default map, use the **no mls qos ip-prec-dscp** global configuration command.

This example shows how to modify and display the IP-precedence-to-DSCP map:

```
Switch(config)# mls qos map ip-prec-dscp 10 15 20 25 30 35 40 45
Switch(config)# end
Switch# show mls qos maps ip-prec-dscp

IpPrecedence-dscp map:
  ipprec:   0  1  2  3  4  5  6  7
-----
          dscp:  10 15 20 25 30 35 40 45
```

## Configuring the Policed-DSCP Map

You use the policed-DSCP map to mark down a DSCP value to a new value as the result of a policing and marking action.

The default policed-DSCP map is a null map, which maps an incoming DSCP value to the same DSCP value.

Beginning in privileged EXEC mode, follow these steps to modify the policed-DSCP map. This procedure is optional.

	Command	Purpose
Step 1	<b>configure terminal</b>	Enter global configuration mode.
Step 2	<b>mls qos map policed-dscp</b> <i>dscp-list to</i> <i>mark-down-dscp</i>	Modify the policed-DSCP map. <ul style="list-style-type: none"> <li>For <i>dscp-list</i>, enter up to eight DSCP values separated by spaces. Then enter the <b>to</b> keyword.</li> <li>For <i>mark-down-dscp</i>, enter the corresponding policed (marked down) DSCP value.</li> </ul>
Step 3	<b>end</b>	Return to privileged EXEC mode.
Step 4	<b>show mls qos maps policed-dscp</b>	Verify your entries.
Step 5	<b>copy running-config startup-config</b>	(Optional) Save your entries in the configuration file.

To return to the default map, use the **no mls qos policed-dscp** global configuration command.

This example shows how to map DSCP 50 to 57 to a marked-down DSCP value of 0:

```
Switch(config)# mls qos map policed-dscp 50 51 52 53 54 55 56 57 to 0
Switch(config)# end
Switch# show mls qos maps policed-dscp
Policed-dscp map:
  d1 :  d2 0  1  2  3  4  5  6  7  8  9
-----
  0 :    00 01 02 03 04 05 06 07 08 09
  1 :    10 11 12 13 14 15 16 17 18 19
  2 :    20 21 22 23 24 25 26 27 28 29
  3 :    30 31 32 33 34 35 36 37 38 39
  4 :    40 41 42 43 44 45 46 47 48 49
  5 :    00 00 00 00 00 00 00 00 58 59
  6 :    60 61 62 63
```



**Note**

In this policed-DSCP map, the marked-down DSCP values are shown in the body of the matrix. The d1 column specifies the most-significant digit of the original DSCP; the d2 row specifies the least-significant digit of the original DSCP. The intersection of the d1 and d2 values provides the marked-down value. For example, an original DSCP value of 53 corresponds to a marked-down DSCP value of 0.

## Configuring the DSCP-to-CoS Map

You use the DSCP-to-CoS map to generate a CoS value, which is used to select one of the four egress queues.

Table 36-14 shows the default DSCP-to-CoS map.

**Table 36-14** Default DSCP-to-CoS Map

DSCP Value	CoS Value
0–7	0
8–15	1
16–23	2
24–31	3
32–39	4
40–47	5
48–55	6
56–63	7

If these values are not appropriate for your network, you need to modify them.

Beginning in privileged EXEC mode, follow these steps to modify the DSCP-to-CoS map. This procedure is optional.

	Command	Purpose
Step 1	<code>configure terminal</code>	Enter global configuration mode.
Step 2	<code>mls qos map dscp-cos dscp-list to cos</code>	Modify the DSCP-to-CoS map. <ul style="list-style-type: none"> <li>For <i>dscp-list</i>, enter up to eight DSCP values separated by spaces. Then enter the <b>to</b> keyword.</li> <li>For <i>cos</i>, enter the CoS value to which the DSCP values correspond.</li> </ul> The DSCP range is 0 to 63; the CoS range is 0 to 7.
Step 3	<code>end</code>	Return to privileged EXEC mode.
Step 4	<code>show mls qos maps dscp-to-cos</code>	Verify your entries.
Step 5	<code>copy running-config startup-config</code>	(Optional) Save your entries in the configuration file.

To return to the default map, use the **no mls qos dscp-cos** global configuration command.

This example shows how to map DSCP values 0, 8, 16, 24, 32, 40, 48, and 50 to CoS value 0 and to display the map:

```
Switch(config)# mls qos map dscp-cos 0 8 16 24 32 40 48 50 to 0
Switch(config)# end
Switch# show mls qos maps dscp-cos
Dscp-cos map:
  d1 :  d2 0  1  2  3  4  5  6  7  8  9
-----
  0 :    00 00 00 00 00 00 00 00 00 00 01
  1 :    01 01 01 01 01 01 00 02 02 02
  2 :    02 02 02 02 00 03 03 03 03 03
  3 :    03 03 00 04 04 04 04 04 04 04
  4 :    00 05 05 05 05 05 05 05 00 06
  5 :    00 06 06 06 06 06 06 07 07 07
  6 :    07 07 07 07
```



#### Note

In the above DSCP-to-CoS map, the CoS values are shown in the body of the matrix. The d1 column specifies the most-significant digit of the DSCP; the d2 row specifies the least-significant digit of the DSCP. The intersection of the d1 and d2 values provides the CoS value. For example, in the DSCP-to-CoS map, a DSCP value of 08 corresponds to a CoS value of 0.

## Configuring the DSCP-to-DSCP-Mutation Map

If two QoS domains have different DSCP definitions, use the DSCP-to-DSCP-mutation map to translate one set of DSCP values to match the definition of another domain. You apply the DSCP-to-DSCP-mutation map to the receiving port (ingress mutation) at the boundary of a QoS administrative domain.

With ingress mutation, the new DSCP value overwrites the one in the packet, and QoS treats the packet with this new value. The switch sends the packet out the port with the new DSCP value.

You can configure multiple DSCP-to-DSCP-mutation maps on an ingress port. The default DSCP-to-DSCP-mutation map is a null map, which maps an incoming DSCP value to the same DSCP value.



Beginning in privileged EXEC mode, follow these steps to modify the DSCP-to-DSCP-mutation map. This procedure is optional.

	Command	Purpose
Step 1	<b>configure terminal</b>	Enter global configuration mode.
Step 2	<b>mls qos map dscp-mutation</b> <i>dscp-mutation-name in-dscp to out-dscp</i>	Modify the DSCP-to-DSCP-mutation map. <ul style="list-style-type: none"> <li>For <i>dscp-mutation-name</i>, enter the mutation map name. You can create more than one map by specifying a new name.</li> <li>For <i>in-dscp</i>, enter up to eight DSCP values separated by spaces. Then enter the <b>to</b> keyword.</li> <li>For <i>out-dscp</i>, enter a single DSCP value.</li> </ul> The DSCP range is 0 to 63.
Step 3	<b>interface</b> <i>interface-id</i>	Specify the port to which to attach the map, and enter interface configuration mode.  Valid interfaces include physical ports.
Step 4	<b>mls qos trust dscp</b>	Configure the ingress port as a DSCP-trusted port. By default, the port is not trusted.
Step 5	<b>mls qos dscp-mutation</b> <i>dscp-mutation-name</i>	Apply the map to the specified ingress DSCP-trusted port.  For <i>dscp-mutation-name</i> , enter the mutation map name specified in Step 2.
Step 6	<b>end</b>	Return to privileged EXEC mode.
Step 7	<b>show mls qos maps dscp-mutation</b>	Verify your entries.
Step 8	<b>copy running-config startup-config</b>	(Optional) Save your entries in the configuration file.

To return to the default map, use the **no mls qos dscp-mutation** *dscp-mutation-name* global configuration command.

This example shows how to define the DSCP-to-DSCP-mutation map. All the entries that are not explicitly configured are not modified (remains as specified in the null map):

```
Switch(config)# mls qos map dscp-mutation mutation1 1 2 3 4 5 6 7 to 0
Switch(config)# mls qos map dscp-mutation mutation1 8 9 10 11 12 13 to 10
Switch(config)# mls qos map dscp-mutation mutation1 20 21 22 to 20
Switch(config)# mls qos map dscp-mutation mutation1 30 31 32 33 34 to 30
Switch(config)# interface gigabitethernet1/0/1
Switch(config-if)# mls qos trust dscp
Switch(config-if)# mls qos dscp-mutation mutation1
Switch(config-if)# end
Switch# show mls qos maps dscp-mutation mutation1
Dscp-dscp mutation map:
mutation1:
d1 : d2 0 1 2 3 4 5 6 7 8 9
-----
0 : 00 00 00 00 00 00 00 00 10 10
1 : 10 10 10 10 14 15 16 17 18 19
2 : 20 20 20 23 24 25 26 27 28 29
3 : 30 30 30 30 30 35 36 37 38 39
4 : 40 41 42 43 44 45 46 47 48 49
5 : 50 51 52 53 54 55 56 57 58 59
6 : 60 61 62 63
```

**Note**

---

In the above DSCP-to-DSCP-mutation map, the mutated values are shown in the body of the matrix. The d1 column specifies the most-significant digit of the original DSCP; the d2 row specifies the least-significant digit of the original DSCP. The intersection of the d1 and d2 values provides the mutated value. For example, a DSCP value of 12 corresponds to a mutated value of 10.

---

## Configuring Ingress Queue Characteristics

Depending on the complexity of your network and your QoS solution, you might need to perform all of the tasks in the next sections. You will need to make decisions about these characteristics:

- Which packets are assigned (by DSCP or CoS value) to each queue?
- What drop percentage thresholds apply to each queue, and which CoS or DSCP values map to each threshold?
- How much of the available buffer space is allocated between the queues?
- How much of the available bandwidth is allocated between the queues?
- Is there traffic (such as voice) that should be given high priority?

These sections contain this configuration information:

- [Mapping DSCP or CoS Values to an Ingress Queue and Setting WTD Thresholds, page 36-67](#) (optional)
- [Allocating Buffer Space Between the Ingress Queues, page 36-68](#) (optional)
- [Allocating Bandwidth Between the Ingress Queues, page 36-68](#) (optional)
- [Configuring the Ingress Priority Queue, page 36-69](#) (optional)

## Mapping DSCP or CoS Values to an Ingress Queue and Setting WTD Thresholds

You can prioritize traffic by placing packets with particular DSCPs or CoSs into certain queues and adjusting the queue thresholds so that packets with lower priorities are dropped.

Beginning in privileged EXEC mode, follow these steps to map DSCP or CoS values to an ingress queue and to set WTD thresholds. This procedure is optional.

	Command	Purpose
Step 1	<b>configure terminal</b>	Enter global configuration mode.
Step 2	<b>mls qos srr-queue input dscp-map queue <i>queue-id</i> threshold <i>threshold-id</i> <i>dscp1...dscp8</i></b> or <b>mls qos srr-queue input cos-map queue <i>queue-id</i> threshold <i>threshold-id</i> <i>cos1...cos8</i></b>	Map DSCP or CoS values to an ingress queue and to a threshold ID.  By default, DSCP values 0–39 and 48–63 are mapped to queue 1 and threshold 1. DSCP values 40–47 are mapped to queue 2 and threshold 1.  By default, CoS values 0–4, 6, and 7 are mapped to queue 1 and threshold 1. CoS value 5 is mapped to queue 2 and threshold 1. <ul style="list-style-type: none"> <li>For <i>queue-id</i>, the range is 1 to 2.</li> <li>For <i>threshold-id</i>, the range is 1 to 3. The drop-threshold percentage for threshold 3 is predefined. It is set to the queue-full state.</li> <li>For <i>dscp1...dscp8</i>, enter up to eight values, and separate each value with a space. The range is 0 to 63.</li> <li>For <i>cos1...cos8</i>, enter up to eight values, and separate each value with a space. The range is 0 to 7.</li> </ul>
Step 3	<b>mls qos srr-queue input threshold <i>queue-id</i> <i>threshold-percentage1</i> <i>threshold-percentage2</i></b>	Assign the two WTD threshold percentages for (threshold 1 and 2) to an ingress queue. The default, both thresholds are set to 100 percent. <ul style="list-style-type: none"> <li>For <i>queue-id</i>, the range is 1 to 2.</li> <li>For <i>threshold-percentage1</i> <i>threshold-percentage2</i>, the range is 1 to 100. Separate each value with a space.</li> </ul> Each threshold value is a percentage of the total number of queue descriptors allocated for the queue.
Step 4	<b>end</b>	Return to privileged EXEC mode.
Step 5	<b>show mls qos maps</b>	Verify your entries.  The DSCP input queue threshold map appears as a matrix. The d1 column specifies the most-significant digit of the DSCP number; the d2 row specifies the least-significant digit in the DSCP number. The intersection of the d1 and the d2 values provides the queue ID and threshold ID; for example, queue 2 and threshold 1 (02-01).  The CoS input queue threshold map shows the CoS value in the top row and the corresponding queue ID and threshold ID in the second row; for example, queue 2 and threshold 2 (2-2).
Step 6	<b>copy running-config startup-config</b>	(Optional) Save your entries in the configuration file.

To return to the default CoS input queue threshold map or the default DSCP input queue threshold map, use the **no mls qos srr-queue input cos-map** or the **no mls qos srr-queue input dscp-map** global configuration command. To return to the default WTD threshold percentages, use the **no mls qos srr-queue input threshold *queue-id*** global configuration command.

This example shows how to map DSCP values 0 to 6 to ingress queue 1 and to threshold 1 with a drop threshold of 50 percent. It maps DSCP values 20 to 26 to ingress queue 1 and to threshold 2 with a drop threshold of 70 percent:

```
Switch(config)# mls qos srr-queue input dscp-map queue 1 threshold 1 0 1 2 3 4 5 6
Switch(config)# mls qos srr-queue input dscp-map queue 1 threshold 2 20 21 22 23 24 25 26
Switch(config)# mls qos srr-queue input threshold 1 50 70
```

In this example, the DSCP values (0 to 6) are assigned the WTD threshold of 50 percent and will be dropped sooner than the DSCP values (20 to 26) assigned to the WTD threshold of 70 percent.

## Allocating Buffer Space Between the Ingress Queues

You define the ratio (allocate the amount of space) with which to divide the ingress buffers between the two queues. The buffer and the bandwidth allocation control how much data can be buffered before packets are dropped.

Beginning in privileged EXEC mode, follow these steps to allocate the buffers between the ingress queues. This procedure is optional.

	Command	Purpose
Step 1	<b>configure terminal</b>	Enter global configuration mode.
Step 2	<b>mls qos srr-queue input buffers</b> <i>percentage1 percentage2</i>	Allocate the buffers between the ingress queues  By default 90 percent of the buffers are allocated to queue 1, and 10 percent of the buffers are allocated to queue 2.  For <i>percentage1 percentage2</i> , the range is 0 to 100. Separate each value with a space.  You should allocate the buffers so that the queues can handle any incoming bursty traffic.
Step 3	<b>end</b>	Return to privileged EXEC mode.
Step 4	<b>show mls qos interface buffer</b>  or <b>show mls qos input-queue</b>	Verify your entries.
Step 5	<b>copy running-config startup-config</b>	(Optional) Save your entries in the configuration file.

To return to the default setting, use the **no mls qos srr-queue input buffers** global configuration command.

This example shows how to allocate 60 percent of the buffer space to ingress queue 1 and 40 percent of the buffer space to ingress queue 2:

```
Switch(config)# mls qos srr-queue input buffers 60 40
```

## Allocating Bandwidth Between the Ingress Queues

You need to specify how much of the available bandwidth is allocated between the ingress queues. The ratio of the weights is the ratio of the frequency in which the SRR scheduler sends packets from each queue. The bandwidth and the buffer allocation control how much data can be buffered before packets are dropped. On ingress queues, SRR operates only in shared mode.

Beginning in privileged EXEC mode, follow these steps to allocate bandwidth between the ingress queues. This procedure is optional.

	Command	Purpose
Step 1	<b>configure terminal</b>	Enter global configuration mode.
Step 2	<b>mls qos srr-queue input bandwidth</b> <i>weight1 weight2</i>	Assign shared round robin weights to the ingress queues.  The default setting for <i>weight1</i> and <i>weight2</i> is 4 (1/2 of the bandwidth is equally shared between the two queues).  For <i>weight1</i> and <i>weight2</i> , the range is 1 to 100. Separate each value with a space.  SRR services the priority queue for its configured weight as specified by the <b>bandwidth</b> keyword in the <b>mls qos srr-queue input priority-queue queue-id bandwidth weight</b> global configuration command. Then, SRR shares the remaining bandwidth with both ingress queues and services them as specified by the weights configured with the <b>mls qos srr-queue input bandwidth weight1 weight2</b> global configuration command. For more information, see the <a href="#">“Configuring the Ingress Priority Queue” section on page 36-69</a> .
Step 3	<b>end</b>	Return to privileged EXEC mode.
Step 4	<b>show mls qos interface queueing</b>  or <b>show mls qos input-queue</b>	Verify your entries.
Step 5	<b>copy running-config startup-config</b>	(Optional) Save your entries in the configuration file.

To return to the default setting, use the **no mls qos srr-queue input bandwidth** global configuration command.

This example shows how to assign the ingress bandwidth to the queues. Priority queueing is disabled, and the shared bandwidth ratio allocated to queue 1 is 25/(25+75) and to queue 2 is 75/(25+75):

```
Switch(config)# mls qos srr-queue input priority-queue 2 bandwidth 0
Switch(config)# mls qos srr-queue input bandwidth 25 75
```

## Configuring the Ingress Priority Queue

You should use the priority queue only for traffic that needs to be expedited (for example, voice traffic, which needs minimum delay and jitter).

The priority queue is guaranteed part of the bandwidth to reduce the delay and jitter under heavy network traffic on an oversubscribed ring (when there is more traffic than the backplane can carry, and the queues are full and dropping frames).

SRR services the priority queue for its configured weight as specified by the **bandwidth** keyword in the **mls qos srr-queue input priority-queue queue-id bandwidth weight** global configuration command. Then, SRR shares the remaining bandwidth with both ingress queues and services them as specified by the weights configured with the **mls qos srr-queue input bandwidth weight1 weight2** global configuration command.

Beginning in privileged EXEC mode, follow these steps to configure the priority queue. This procedure is optional.

	Command	Purpose
Step 1	<b>configure terminal</b>	Enter global configuration mode.
Step 2	<b>mls qos srr-queue input priority-queue <i>queue-id</i> bandwidth <i>weight</i></b>	Assign a queue as the priority queue and guarantee bandwidth on the stack or internal ring if the ring is congested.  By default, the priority queue is queue 2, and 10 percent of the bandwidth is allocated to it. <ul style="list-style-type: none"> <li>For <i>queue-id</i>, the range is 1 to 2.</li> <li>For <b>bandwidth <i>weight</i></b>, assign the bandwidth percentage of the stack or internal ring. The range is 0 to 40. The amount of bandwidth that can be guaranteed is restricted because a large value affects the entire ring and can degrade the switch or stack performance.</li> </ul>
Step 3	<b>end</b>	Return to privileged EXEC mode.
Step 4	<b>show mls qos interface queueing</b>  or <b>show mls qos input-queue</b>	Verify your entries.
Step 5	<b>copy running-config startup-config</b>	(Optional) Save your entries in the configuration file.

To return to the default setting, use the **no mls qos srr-queue input priority-queue *queue-id*** global configuration command. To disable priority queueing, set the bandwidth weight to 0, for example, **mls qos srr-queue input priority-queue *queue-id* bandwidth 0**.

This example shows how to assign the ingress bandwidths to the queues. Queue 1 is the priority queue with 10 percent of the bandwidth allocated to it. The bandwidth ratios allocated to queues 1 and 2 is 4/(4+4). SRR services queue 1 (the priority queue) first for its configured 10 percent bandwidth. Then SRR equally shares the remaining 90 percent of the bandwidth between queues 1 and 2 by allocating 45 percent to each queue:

```
Switch(config)# mls qos srr-queue input priority-queue 1 bandwidth 10
Switch(config)# mls qos srr-queue input bandwidth 4 4
```

## Configuring Egress Queue Characteristics

Depending on the complexity of your network and your QoS solution, you might need to perform all of the tasks in the next sections. You will need to make decisions about these characteristics:

- Which packets are mapped by DSCP or CoS value to each queue and threshold ID?
- What drop percentage thresholds apply to the queue-set (four egress queues per port), and how much reserved and maximum memory is needed for the traffic type?
- How much of the fixed buffer space is allocated to the queue-set?
- Does the bandwidth of the port need to be rate limited?
- How often should the egress queues be serviced and which technique (shaped, shared, or both) should be used?

These sections contain this configuration information:

- [Configuration Guidelines, page 36-71](#)
- [Allocating Buffer Space to and Setting WTD Thresholds for an Egress Queue-Set, page 36-71 \(optional\)](#)
- [Mapping DSCP or CoS Values to an Egress Queue and to a Threshold ID, page 36-73 \(optional\)](#)
- [Configuring SRR Shaped Weights on Egress Queues, page 36-75 \(optional\)](#)
- [Configuring SRR Shared Weights on Egress Queues, page 36-76 \(optional\)](#)
- [Configuring the Egress Expedite Queue, page 36-76 \(optional\)](#)
- [Limiting the Bandwidth on an Egress Interface, page 36-77 \(optional\)](#)

## Configuration Guidelines

Follow these guidelines when the expedite queue is enabled or the egress queues are serviced based on their SRR weights:

- If the egress expedite queue is enabled, it overrides the SRR shaped and shared weights for queue 1.
- If the egress expedite queue is disabled and the SRR shaped and shared weights are configured, the shaped mode overrides the shared mode for queue 1, and SRR services this queue in shaped mode.
- If the egress expedite queue is disabled and the SRR shaped weights are not configured, SRR services this queue in shared mode.

## Allocating Buffer Space to and Setting WTD Thresholds for an Egress Queue-Set

You can guarantee the availability of buffers, set WTD thresholds, and configure the maximum allocation for a queue-set by using the **mls qos queue-set output *qset-id* threshold *queue-id* drop-threshold1 drop-threshold2 reserved-threshold maximum-threshold** global configuration command.

Each threshold value is a percentage of the queue's allocated buffers, which you specify by using the **mls qos queue-set output *qset-id* buffers *allocation1* ... *allocation4*** global configuration command. The queues use WTD to support distinct drop percentages for different traffic classes.



### Note

The egress queue default settings are suitable for most situations. You should change them only when you have a thorough understanding of the egress queues and if these settings do not meet your QoS solution.

Beginning in privileged EXEC mode, follow these steps to configure the memory allocation and to drop thresholds for a queue-set. This procedure is optional.

	Command	Purpose
Step 1	<b>configure terminal</b>	Enter global configuration mode.
Step 2	<b>mls qos queue-set output</b> <i>qset-id</i> <b>buffers</b> <i>allocation1 ... allocation4</i>	<p>Allocate buffers to a queue-set.</p> <p>By default, all allocation values are equally mapped among the four queues (25, 25, 25, 25). Each queue has 1/4 of the buffer space.</p> <ul style="list-style-type: none"> <li>For <i>qset-id</i>, enter the ID of the queue-set. The range is 1 to 2. Each port belongs to a queue-set, which defines all the characteristics of the four egress queues per port.</li> <li>For <i>allocation1 ... allocation4</i>, specify four percentages, one for each queue in the queue-set. For <i>allocation1</i>, <i>allocation3</i>, and <i>allocation4</i>, the range is 0 to 99. For <i>allocation2</i>, the range is 1 to 100 (including the CPU buffer).</li> </ul> <p>Allocate buffers according to the importance of the traffic; for example, give a large percentage of the buffer to the queue with the highest-priority traffic.</p>
Step 3	<b>mls qos queue-set output</b> <i>qset-id</i> <b>threshold</b> <i>queue-id drop-threshold1</i> <i>drop-threshold2 reserved-threshold</i> <i>maximum-threshold</i>	<p>Configure the WTD thresholds, guarantee the availability of buffers, and configure the maximum memory allocation for the queue-set (four egress queues per port).</p> <p>By default, the WTD thresholds for queues 1, 3, and 4 are set to 100 percent. The thresholds for queue 2 are set to 200 percent. The reserved thresholds for queues 1, 2, 3, and 4 are set to 50 percent. The maximum thresholds for all queues are set to 400 percent.</p> <ul style="list-style-type: none"> <li>For <i>qset-id</i>, enter the ID of the queue-set specified in Step 2. The range is 1 to 2.</li> <li>For <i>queue-id</i>, enter the specific queue in the queue-set on which the command is performed. The range is 1 to 4.</li> <li>For <i>drop-threshold1 drop-threshold2</i>, specify the two WTD thresholds expressed as a percentage of the queue's allocated memory. The range is 1 to 3200 percent.</li> <li>For <i>reserved-threshold</i>, enter the amount of memory to be guaranteed (reserved) for the queue expressed as a percentage of the allocated memory. The range is 1 to 100 percent.</li> <li>For <i>maximum-threshold</i>, enable a queue in the full condition to obtain more buffers than are reserved for it. This is the maximum memory the queue can have before the packets are dropped if the common pool is not empty. The range is 1 to 3200 percent.</li> </ul>
Step 4	<b>interface</b> <i>interface-id</i>	Specify the port of the outbound traffic, and enter interface configuration mode.
Step 5	<b>queue-set</b> <i>qset-id</i>	<p>Map the port to a queue-set.</p> <p>For <i>qset-id</i>, enter the ID of the queue-set specified in Step 2. The range is 1 to 2. The default is 1.</p>
Step 6	<b>end</b>	Return to privileged EXEC mode.



	Command	Purpose
Step 7	<code>show mls qos interface [interface-id] buffers</code>	Verify your entries.
Step 8	<code>copy running-config startup-config</code>	(Optional) Save your entries in the configuration file.

To return to the default setting, use the `no mls qos queue-set output qset-id buffers` global configuration command. To return to the default WTD threshold percentages, use the `no mls qos queue-set output qset-id threshold [queue-id]` global configuration command.

This example shows how to map a port to queue-set 2. It allocates 40 percent of the buffer space to egress queue 1 and 20 percent to egress queues 2, 3, and 4. It configures the drop thresholds for queue 2 to 40 and 60 percent of the allocated memory, guarantees (reserves) 100 percent of the allocated memory, and configures 200 percent as the maximum memory that this queue can have before packets are dropped:

```
Switch(config)# mls qos queue-set output 2 buffers 40 20 20 20
Switch(config)# mls qos queue-set output 2 threshold 2 40 60 100 200
Switch(config)# interface gigabitethernet1/0/1
Switch(config-if)# queue-set 2
```

## Mapping DSCP or CoS Values to an Egress Queue and to a Threshold ID

You can prioritize traffic by placing packets with particular DSCPs or costs of service into certain queues and adjusting the queue thresholds so that packets with lower priorities are dropped.



### Note

The egress queue default settings are suitable for most situations. You should change them only when you have a thorough understanding of the egress queues and if these settings do not meet your QoS solution.

Beginning in privileged EXEC mode, follow these steps to map DSCP or CoS values to an egress queue and to a threshold ID. This procedure is optional.

	Command	Purpose
Step 1	<b>configure terminal</b>	Enter global configuration mode.
Step 2	<b>mls qos srr-queue output dscp-map queue <i>queue-id</i> threshold <i>threshold-id</i> <i>dscp1...dscp8</i></b> or <b>mls qos srr-queue output cos-map queue <i>queue-id</i> threshold <i>threshold-id</i> <i>cos1...cos8</i></b>	Map DSCP or CoS values to an egress queue and to a threshold ID.  By default, DSCP values 0–15 are mapped to queue 2 and threshold 1. DSCP values 16–31 are mapped to queue 3 and threshold 1. DSCP values 32–39 and 48–63 are mapped to queue 4 and threshold 1. DSCP values 40–47 are mapped to queue 1 and threshold 1.  By default, CoS values 0 and 1 are mapped to queue 2 and threshold 1. CoS values 2 and 3 are mapped to queue 3 and threshold 1. CoS values 4, 6, and 7 are mapped to queue 4 and threshold 1. CoS value 5 is mapped to queue 1 and threshold 1. <ul style="list-style-type: none"> <li>• For <i>queue-id</i>, the range is 1 to 4.</li> <li>• For <i>threshold-id</i>, the range is 1 to 3. The drop-threshold percentage for threshold 3 is predefined. It is set to the queue-full state.</li> <li>• For <i>dscp1...dscp8</i>, enter up to eight values, and separate each value with a space. The range is 0 to 63.</li> <li>• For <i>cos1...cos8</i>, enter up to eight values, and separate each value with a space. The range is 0 to 7.</li> </ul>
Step 3	<b>end</b>	Return to privileged EXEC mode.
Step 4	<b>show mls qos maps</b>	Verify your entries.  The DSCP output queue threshold map appears as a matrix. The d1 column specifies the most-significant digit of the DSCP number; the d2 row specifies the least-significant digit in the DSCP number. The intersection of the d1 and the d2 values provides the queue ID and threshold ID; for example, queue 2 and threshold 1 (02-01).  The CoS output queue threshold map shows the CoS value in the top row and the corresponding queue ID and threshold ID in the second row; for example, queue 2 and threshold 2 (2-2).
Step 5	<b>copy running-config startup-config</b>	(Optional) Save your entries in the configuration file.

To return to the default DSCP output queue threshold map or the default CoS output queue threshold map, use the **no mls qos srr-queue output dscp-map** or the **no mls qos srr-queue output cos-map** global configuration command.

This example shows how to map DSCP values 10 and 11 to egress queue 1 and to threshold 2:

```
Switch(config)# mls qos srr-queue output dscp-map queue 1 threshold 2 10 11
```

## Configuring SRR Shaped Weights on Egress Queues

You can specify how much of the available bandwidth is allocated to each queue. The ratio of the weights is the ratio of frequency in which the SRR scheduler sends packets from each queue.

You can configure the egress queues for shaped or shared weights, or both. Use shaping to smooth bursty traffic or to provide a smoother output over time. For information about shaped weights, see the “[SRR Shaping and Sharing](#)” section on page 36-14. For information about shared weights, see the “[Configuring SRR Shared Weights on Egress Queues](#)” section on page 36-76.

Beginning in privileged EXEC mode, follow these steps to assign the shaped weights and to enable bandwidth shaping on the four egress queues mapped to a port. This procedure is optional.

	Command	Purpose
Step 1	<b>configure terminal</b>	Enter global configuration mode.
Step 2	<b>interface</b> <i>interface-id</i>	Specify the port of the outbound traffic, and enter interface configuration mode.
Step 3	<b>srr-queue bandwidth shape</b> <i>weight1 weight2 weight3 weight4</i>	Assign SRR weights to the egress queues. By default, <i>weight1</i> is set to 25; <i>weight2</i> , <i>weight3</i> , and <i>weight4</i> are set to 0, and these queues are in shared mode. For <i>weight1 weight2 weight3 weight4</i> , enter the weights to control the percentage of the port that is shaped. The inverse ratio ( $1/\textit{weight}$ ) controls the shaping bandwidth for this queue. Separate each value with a space. The range is 0 to 65535. If you configure a weight of 0, the corresponding queue operates in shared mode. The weight specified with the <b>srr-queue bandwidth shape</b> command is ignored, and the weights specified with the <b>srr-queue bandwidth share</b> interface configuration command for a queue come into effect. When configuring queues in the same queue-set for both shaping and sharing, make sure that you configure the lowest number queue for shaping. The shaped mode overrides the shared mode.
Step 4	<b>end</b>	Return to privileged EXEC mode.
Step 5	<b>show mls qos interface</b> <i>interface-id</i> <b>queueing</b>	Verify your entries.
Step 6	<b>copy running-config startup-config</b>	(Optional) Save your entries in the configuration file.

To return to the default setting, use the **no srr-queue bandwidth shape** interface configuration command.

This example shows how to configure bandwidth shaping on queue 1. Because the weight ratios for queues 2, 3, and 4 are set to 0, these queues operate in shared mode. The bandwidth weight for queue 1 is 1/8, which is 12.5 percent:

```
Switch(config)# interface gigabitethernet2/0/1
Switch(config-if)# srr-queue bandwidth shape 8 0 0 0
```

## Configuring SRR Shared Weights on Egress Queues

In shared mode, the queues share the bandwidth among them according to the configured weights. The bandwidth is guaranteed at this level but not limited to it. For example, if a queue empties and does not require a share of the link, the remaining queues can expand into the unused bandwidth and share it among them. With sharing, the ratio of the weights controls the frequency of dequeuing; the absolute values are meaningless.



### Note

The egress queue default settings are suitable for most situations. You should change them only when you have a thorough understanding of the egress queues and if these settings do not meet your QoS solution.

Beginning in privileged EXEC mode, follow these steps to assign the shared weights and to enable bandwidth sharing on the four egress queues mapped to a port. This procedure is optional.

	Command	Purpose
Step 1	<b>configure terminal</b>	Enter global configuration mode.
Step 2	<b>interface</b> <i>interface-id</i>	Specify the port of the outbound traffic, and enter interface configuration mode.
Step 3	<b>srr-queue bandwidth share</b> <i>weight1 weight2 weight3 weight4</i>	Assign SRR weights to the egress queues.  By default, all four weights are 25 (1/4 of the bandwidth is allocated to each queue).  For <i>weight1 weight2 weight3 weight4</i> , enter the weights to control the ratio of the frequency in which the SRR scheduler sends packets. Separate each value with a space. The range is 1 to 255.
Step 4	<b>end</b>	Return to privileged EXEC mode.
Step 5	<b>show mls qos interface</b> <i>interface-id</i> <b>queueing</b>	Verify your entries.
Step 6	<b>copy running-config startup-config</b>	(Optional) Save your entries in the configuration file.

To return to the default setting, use the **no srr-queue bandwidth share** interface configuration command.

This example shows how to configure the weight ratio of the SRR scheduler running on an egress port. Four queues are used, and the bandwidth ratio allocated for each queue in shared mode is  $1/(1+2+3+4)$ ,  $2/(1+2+3+4)$ ,  $3/(1+2+3+4)$ , and  $4/(1+2+3+4)$ , which is 10 percent, 20 percent, 30 percent, and 40 percent for queues 1, 2, 3, and 4. This means that queue 4 has four times the bandwidth of queue 1, twice the bandwidth of queue 2, and one-and-a-third times the bandwidth of queue 3.

```
Switch(config)# interface gigabitethernet2/0/1
Switch(config-if)# srr-queue bandwidth share 1 2 3 4
```

## Configuring the Egress Expedite Queue

You can ensure that certain packets have priority over all others by queuing them in the egress expedite queue. SRR services this queue until it is empty before servicing the other queues.

Beginning in privileged EXEC mode, follow these steps to enable the egress expedite queue. This procedure is optional.

	Command	Purpose
Step 1	<b>configure terminal</b>	Enter global configuration mode.
Step 2	<b>mls qos</b>	Enable QoS on a switch.
Step 3	<b>interface</b> <i>interface-id</i>	Specify the egress port, and enter interface configuration mode.
Step 4	<b>priority-queue out</b>	Enable the egress expedite queue, which is disabled by default.  When you configure this command, the SRR weight and queue size ratios are affected because there is one fewer queue participating in SRR. This means that <i>weight1</i> in the <b>srr-queue bandwidth shape</b> or the <b>srr-queue bandwidth share</b> command is ignored (not used in the ratio calculation).
Step 5	<b>end</b>	Return to privileged EXEC mode.
Step 6	<b>show running-config</b>	Verify your entries.
Step 7	<b>copy running-config startup-config</b>	(Optional) Save your entries in the configuration file.

To disable the egress expedite queue, use the **no priority-queue out** interface configuration command. This example shows how to enable the egress expedite queue when the SRR weights are configured. The egress expedite queue overrides the configured SRR weights.

```
Switch(config)# interface gigabitethernet1/0/1
Switch(config-if)# srr-queue bandwidth shape 25 0 0 0
Switch(config-if)# srr-queue bandwidth share 30 20 25 25
Switch(config-if)# priority-queue out
Switch(config-if)# end
```

## Limiting the Bandwidth on an Egress Interface

You can limit the bandwidth on an egress port. For example, if a customer pays only for a small percentage of a high-speed link, you can limit the bandwidth to that amount.



### Note

The egress queue default settings are suitable for most situations. You should change them only when you have a thorough understanding of the egress queues and if these settings do not meet your QoS solution.

Beginning in privileged EXEC mode, follow these steps to limit the bandwidth on an egress port. This procedure is optional.

	Command	Purpose
Step 1	<b>configure terminal</b>	Enter global configuration mode.
Step 2	<b>interface</b> <i>interface-id</i>	Specify the port to be rate limited, and enter interface configuration mode.
Step 3	<b>srr-queue bandwidth limit</b> <i>weight1</i>	Specify the percentage of the port speed to which the port should be limited. The range is 10 to 90.  By default, the port is not rate limited and is set to 100 percent.
Step 4	<b>end</b>	Return to privileged EXEC mode.

	Command	Purpose
Step 5	<b>show mls qos interface</b> <i>[interface-id]</i> <b>queueing</b>	Verify your entries.
Step 6	<b>copy running-config startup-config</b>	(Optional) Save your entries in the configuration file.

To return to the default setting, use the **no srr-queue bandwidth limit** interface configuration command.

This example shows how to limit the bandwidth on a port to 80 percent:

```
Switch(config)# interface gigabitethernet2/0/1
Switch(config-if)# srr-queue bandwidth limit 80
```

When you configure this command to 80 percent, the port is idle 20 percent of the time. The line rate drops to 80 percent of the connected speed, which is 800 Mb/s. These values are not exact because the hardware adjusts the line rate in increments of six.

## Displaying Standard QoS Information

To display standard QoS information, use one or more of the privileged EXEC commands in [Table 36-15](#):

**Table 36-15** Commands for Displaying Standard QoS Information

Command	Purpose
<b>show class-map</b> <i>[class-map-name]</i>	Display QoS class maps, which define the match criteria to classify traffic.
<b>show mls qos</b>	Display global QoS configuration information.
<b>show mls qos aggregate-policer</b> <i>[aggregate-policer-name]</i>	Display the aggregate policer configuration.
<b>show mls qos input-queue</b>	Display QoS settings for the ingress queues.
<b>show mls qos interface</b> <i>[interface-id]</i> [ <b>buffers</b>   <b>policers</b>   <b>queueing</b>   <b>statistics</b> ]	Display QoS information at the port level, including the buffer allocation, which ports have configured policers, the queueing strategy, and the ingress and egress statistics.
<b>show mls qos maps</b> [ <b>cos-dscp</b>   <b>cos-input-q</b>   <b>cos-output-q</b>   <b>dscp-cos</b>   <b>dscp-input-q</b>   <b>dscp-mutation</b> <i>dscp-mutation-name</i>   <b>dscp-output-q</b>   <b>ip-prec-dscp</b>   <b>policed-dscp</b> ]	Display QoS mapping information.
<b>show mls qos queue-set</b> <i>[qset-id]</i>	Display QoS settings for the egress queues.
<b>show mls qos vlan</b> <i>vlan-id</i>	Display the policy maps attached to the specified SVI.
<b>show policy-map</b> <i>[policy-map-name [class class-map-name]]</i>	Display QoS policy maps, which define classification criteria for incoming traffic.  <b>Note</b> Do not use the <b>show policy-map interface</b> privileged EXEC command to display classification information for incoming traffic. The <b>control-plane</b> and <b>interface</b> keywords are not supported, and the statistics shown in the display should be ignored.
<b>show running-config</b>   <b>include rewrite</b>	Display the DSCP transparency setting.



