



Policies

- [Segmentation Policy Basics, on page 1](#)
- [Use Workspaces to Manage Policies, on page 2](#)
- [About Policies, on page 9](#)
- [Create and Discover Policies, on page 11](#)
- [Grouping Workloads: Clusters and Inventory Filters, on page 70](#)
- [Address Policy Complexities, on page 81](#)
- [About Deleting Policies, on page 104](#)
- [Review and Analyze Policies, on page 104](#)
- [Enforce Policies, on page 129](#)
- [Modify Enforced Policies, on page 141](#)
- [About Policy Versions \(v* and p*\), on page 145](#)
- [Conversations, on page 151](#)
- [Automated Load Balancer Config for Automatic Policy Discovery \(F5 Only\), on page 158](#)
- [Policies Publisher, on page 163](#)
- [Application Views, on page 166](#)
- [Policy Chord View, on page 170](#)

Segmentation Policy Basics

The purpose of segmentation and microsegmentation policies is to allow only the traffic your organization needs to conduct business, and block all other traffic. The goal is to reduce your network's attack surface without disrupting business operations.

Secure Workload segmentation policies allow or block traffic based on its source, destination, port, protocol, and a few other attributes that are typically platform-specific.

You can create some policies manually, and use Secure Workload's powerful automatic policy discovery feature to generate other policies based on existing network traffic.

You can review, refine, and analyze your policies, then enforce them when you are confident that they allow only the traffic that your organization needs.



Important Microsegmentation essentially creates a firewall around each workload.

Therefore, for traffic to pass between each consumer-provider pair, both ends of the conversation must allow the conversation to happen: The consumer and the provider must each have a policy that allows the traffic.



Note The terms *firewall rule*, *edge*, and *cluster edge* are sometimes used to mean "policy."

Use Workspaces to Manage Policies

Workspaces (formerly called “Application workspaces” or “Applications”) are where you work with and manage policies.

You can perform all policy-related activities for a particular scope, such as creating, analyzing, and enforcing policies, in the workspace or workspaces associated with that scope.

Each workspace provides an isolated environment, allowing experimentation with no effect on other workspaces.

Controlling User Access to Workspaces

Workspaces are meant to be used by multiple users from the same team as shared documents.

To control access to a workspace, assign user roles for the scope associated with the workspace. See [Roles](#).

Working with Policies: Navigating to the Workspaces Page

- **To work with policies, or to view existing application workspaces or create new ones:**

Choose **Defend** > **Segmentation** from the navigation bar at the left side of the window.

- **To view a particular workspace:**

In the list of scopes at the left side of the Workspaces page, navigate to the scope associated with the workspace, then click the workspace. The current active workspace is highlighted in the list.

- **If you are looking at a workspace and want to return to the list of workspaces:**

Click the **Workspaces** link near the left side of the page you are looking at.

Figure 1: Workspace Management Page

The screenshot displays the 'Segmentation' interface. On the left, a 'Workspaces' panel shows a tree view of 11 scopes and 10 workspaces. The 'Furong:jumphost' workspace is highlighted as the primary workspace. On the right, the 'Furong:jumphost' workspace details are shown, including a table of policies and a 'Parent Scopes' section.

Type	Version	Absolute Policies	Default Policies	Catch All
Enforced	p10	1	10	ALLOW
Analyzed	p10	1	10	ALLOW
Latest Draft	v9	1	10	ALLOW

Scope	Primary Workspace	Analysis	Enforcement
Furong	test	Version: p6 Policies: 4 Catch-all Action: ALLOW	Disabled

Create a Workspace

To create policies for a scope, first create a workspace for that scope.

To create a workspace:

1. From the navigation menu on the left side of the window, choose **Defend** > **Segmentation**.
2. In the scope listing on the left side of the page, search for or scroll to the scope for which you want to create policies.
3. Hover over the scope until you see a blue plus sign, then click it.
4. Complete the form and click **Create** when done.

If a workspace exists for the scope, any additional workspaces is created as a secondary workspaces.

Primary and Secondary Workspaces

For each scope, you can create one Primary workspace and multiple secondary workspaces.

Only a primary workspace can be enforced. Other features that are available only for primary workspaces include the ability to manage policies in which consumer and provider reside in different scopes; live policy analysis; compliance reporting; and collaborative security policy definition.

Use secondary workspaces to experiment with policies when you want to preserve the existing policies in the primary workspace.

To change a workspace to primary or secondary:

You can switch a workspace from primary to secondary and conversely at any time by clicking the menu icon next to the workspace name at the top of the page and selecting **Toggle Primary**.

Figure 2: Switching a Workspace Between Primary and Secondary

The screenshot shows a workspace management interface. At the top left, it says 'Root Scope' followed by a 'SECONDARY' badge and a three-dot menu icon. Below this, there's a breadcrumb 'Furong(3) / Root Scope'. To the right, there are links for 'View Activity Log' and a 'Manage Policies' button, along with a timestamp 'Last Update: Jul 19, 2022 7:26 PM'. A dropdown menu is open from the three-dot icon, showing options: 'Update Workspace', 'Toggle Primary' (highlighted in blue), and 'Delete Workspace'. Below the menu is a table with columns: 'Type', 'Absolute Policies', 'Default Policies', and 'Catch All'. The table has two rows: 'Enforced' and 'Analyzed', with 'N/A' values in the 'Type' column.

Type	Absolute Policies	Default Policies	Catch All
Enforced	N/A	N/A	N/A
Analyzed	N/A	N/A	N/A

Rename a Workspace

To rename a workspace:

Click **...** beside the workspace type (Primary or Secondary) shown near the top of the page and choose **Update Workspace**.

View Workloads in a Scope

In any workspace, click the **Matching Inventories** tab.

Search Within a Workspace

To search within a workspace for workloads, clusters, or policies:

1. Select **Defend > Segmentation**.
2. From the list of scopes on the left, click the scope and workspace of interest.
3. Click **Manage Policies**.
4. Click the magnifying glass.
5. Enter search criteria.

Search Criteria

Multiple criteria are treated as logical AND.

For IP addresses and numeric values:

- Indicate logical OR using a comma: 'port: 80,443'.
- Range queries are also supported for number values: 'port: 3000-3999'.

Filters	Description
Name	Enter a cluster or workload name. Performs case-sensitive substring search.
Description	Searches cluster descriptions.
Approved	Matches approved clusters using the values 'true' or 'false'.

Filters	Description
Address	Enter a subnet or IP address using CIDR notation (for example, 10.11.12.0/24). Matches workloads or clusters which overlap this subnet.
Supernet	Enter a subnet using CIDR notation (for example, 10.11.12.0/24) to match clusters whose workloads are fully contained in this subnet.
Process	Searches workload processes using case-sensitive substring search.
Process UID	Searches workload process usernames.
Port	Searches both workload provider port and policy port.
Protocol	Searches both workload provider protocol and policy protocol.
Consumer Name	Matches a policy's consumer cluster name. Performs a case-sensitive substring match.
Provider Name	Matches a policy's provider cluster name. Performs a case-sensitive substring match.
Consumer Address	Matches policies whose consumer address overlaps with the provided IP or subnet.
Provider Address	Matches policies whose provider address overlaps with the provided IP or subnet.

Search Example

The screenshot shows a search interface with a search bar containing the query "Address = 0.0.0.0/0". Below the search bar, there is a "Search" button and the text "over workloads, clusters.". The results section indicates "Found 81 results page 1". Two cluster results are shown:

- Cluster:** OTHER: rcdn9-dci13n-g
- Description:** [edit icon]
- View Cluster Details:** [link]
- Workloads:** [icon] ?
- IP Addresses:** [icon] ?
- Neighbors:** 13
- Subnets:** 2

The second cluster result is partially visible:

- Cluster:** OTHER: rtp1-dcm02n-b
- Description:** [edit icon]

Filtering Search Results by a Specific Type

Search results may include multiple types of objects, for example workloads and clusters.

To filter search results by a specific type:

1. Click the result total:

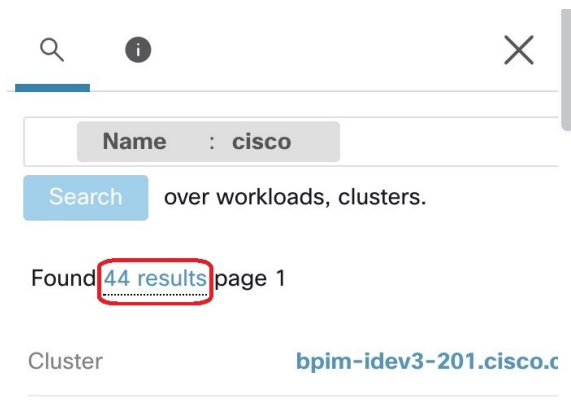

2. Select the type from the dropdown:

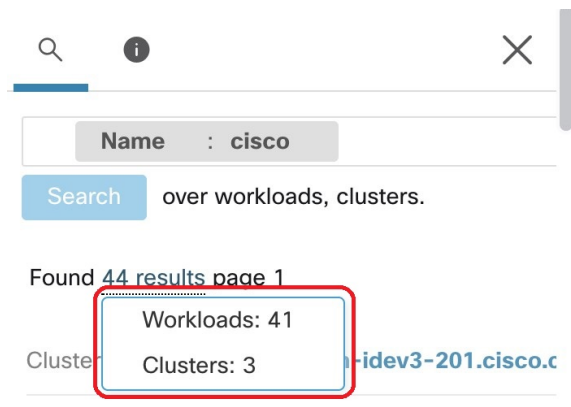

3. A type filter will be added and the search will be rerun.

Deleting Workspaces

Only secondary (nonprimary) workspaces can be deleted. To switch a workspace to secondary, see [Primary and Secondary Workspaces, on page 3](#).

To delete a workspace:

1. Choose **Defend > Segmentation**.
2. In the list of scopes at the left side of the page, navigate to the scope containing the workspace to delete and click it.
3. Click the workspace to delete.
4. Click **...** beside **Secondary** and choose **Delete Workspace**.

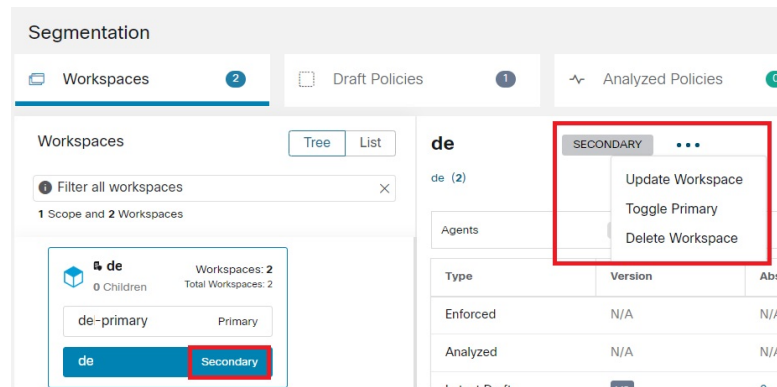

If a workload or cluster in a workspace is referenced by a policy in another workspace as a result of a Provided Service, the dependent workspace cannot be deleted, and a list of the dependencies will be returned. This information can be used to fix the dependency.

Figure 3: List of Items Preventing the Deletion of the Workspace

Applications

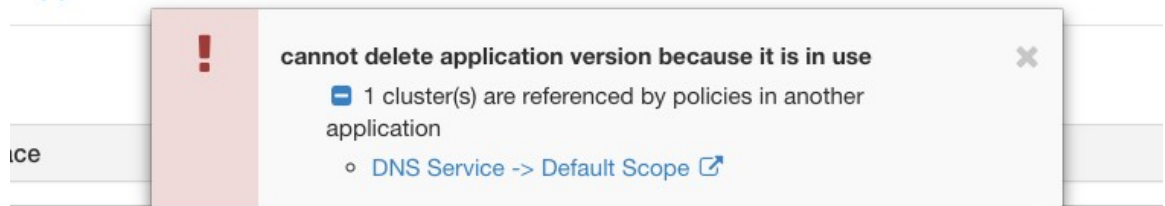

In rare conditions there may be a cross dependency where Workspace A depends on a cluster in Workspace B and a Workspace B depends on a cluster in Workspace A. In this case, the individual policies or published policy versions (p*) must be deleted. The “delete restrictions” error provides links to all the policies so this can be accomplished.

To delete p* versions, see [View, Compare, and Manage Analyzed Policy Versions, on page 127](#) or [View, Compare, and Manage Enforced Policy Versions, on page 142](#).

About Policies

Policy Attributes

Table 1: Policy Properties

Security Policy Property	Description
Scope for which the policy is defined	A policy generally affects only workloads that are members of the scope associated with the workspace in which the policy is defined. (However, see also the topics under Address Policy Complexities, on page 81.) For more information, see Policy Example, on page 11.
Consumer	The client of a service or the initiator of a connection. Any scope, cluster, or inventory filter can be used as the consumer in a policy. See important information in About Consumer and Provider in Policies, on page 10.
Provider	The server or the recipient of a connection. Any scope, cluster, or inventory filter can be used as the provider in a policy. See important information in About Consumer and Provider in Policies, on page 10.
Protocols and Ports	The server (listening) port and IP protocol of the service made available by the provider that should be permitted or blocked.
Action	ALLOW or DENY: Whether to allow or drop traffic from consumer to provider on the given service port/protocol.
Rank and Priority	For more information the rank and priority of policies in a workspace, see Policy Rank: Absolute, Default, and Catch-All, on page 9.

Policy Rank: Absolute, Default, and Catch-All

Policy rank determines whether a policy is overridden by a more specific policy lower in the priority list (or in a scope lower in the scope tree). The lowest priority policy in every scope is always the Catch-all rule.

Policy Rank	Description
Absolute	Absolute policies take effect even if they contradict application-specific policies lower in the policy list (and thus, lower priority) or in scopes lower in the scope tree. Generally, use Absolute policies to enforce best practices, protect different zones, or quarantine-specific workloads. For example, use absolute policies to control traffic to DNS or NTP servers, or to meet regulatory requirements. Absolute policies are listed above default policies in the policy priority list.

Policy Rank	Description
Default	<p>Default policies can be overridden by policies lower in the policy list or in scopes lower in the scope tree. Generally, fine-grained policies are Default policies.</p> <p>Default policies are listed below absolute policies in the policy priority list.</p>
Catch-All	<p>Each workspace has a catch-all policy that handles traffic in each direction that does not match any explicitly specified policies in the workspace. The catch-all action can be Allow or Deny.</p> <p>In general, set the Catch-All policy as follows:</p> <ul style="list-style-type: none"> • Allow traffic in scopes higher in the scope tree, so that policies in scopes lower in the tree can evaluate the traffic. • Deny traffic at the most specific leaf at the bottom of the scope tree. <p>This gives policies in all scopes in the tree the opportunity to match the traffic, while blocking traffic that does not match any policy in any scope.</p> <p>The catch-all rule is applied to all interfaces on each workload in the workspace.</p>

Policy Inheritance and the Scope Tree

Because your workloads are organized into a hierarchical scope tree, you can create general policies once in a scope at or near the top of the tree, and the policies can optionally apply to all workloads in all scopes below that scope in the tree.

You specify whether the general policies can be overridden by more specific policies lower in the tree.

See [Policy Rank: Absolute, Default, and Catch-All, on page 9](#).

About Consumer and Provider in Policies

The consumer and provider that is specified in a policy serve the following purposes:

- They specify the workloads or Secure Workload agents that receive policy or firewall rules.
- They specify the set of IP addresses to which the firewall rules that are installed on the workloads apply.

If a host has multiple interfaces (IP addresses), policies apply to all interfaces.



Important

The above is the default behavior of how firewall rules are programmed on the workloads. If the IP addresses specified in the firewall rules differ from the IP addresses of the workloads that the policy is installed to, you need to separate the two purposes of consumers and providers in a policy. See [Effective Consumer or Effective Provider, on page 101](#).

Policy Example

The following example policy illustrates the importance of the scope in which a policy is defined, the impact of policy inheritance, and the use of inventory filters to create precise policies or policies that apply to workloads in multiple scopes.

Consider the following example involving three scopes:

- **Apps**
and its child scopes
 - **Apps : HR** and
 - **Apps : Commerce**

In addition, the inventory filters PRODUCTION and NON-PRODUCTION specify production and nonproduction hosts, respectively. (You can define an inventory filter to apply to hosts within a scope or across scopes.)

Assume that the following policy is defined in the **Apps** scope:

```
DENY PRODUCTION -> NON-PRODUCTION on TCP port 8000 (Absolute)
```

Since this policy is an absolute policy that is defined in the primary workspace under the **Apps** scope, it affects all PRODUCTION/NONPRODUCTION hosts that are members of the **Apps** scope, including members of its descendant scopes (hosts that belong to the **Apps : HR** and **Apps : Commerce** scopes).

Now consider the case where the exact same policy is defined under the workspace that is associated with the **Apps : HR** scope. In this scenario, the policy can only affect PRODUCTION/NONPRODUCTION hosts that are members of the **Apps : HR** scope. More precisely, this policy results in inbound rules on NONPRODUCTION HR hosts (if any) denying connections on TCP port 8000 from **any** PRODUCTION host, and outbound rules on PRODUCTION HR hosts (if any) dropping connection requests to **any** NONPRODUCTION host.

Create and Discover Policies

Best Practices for Creating Policies

- For an overview of the entire segmentation process, see [Get Started with Segmentation and Microsegmentation](#) and subtopics.
- Manually create policies that apply broadly across your network.

For example, block unwanted traffic to your workloads from outside your network, or quarantine vulnerable hosts.

- Create manual policies in scopes at or near the top of your scope tree.

For example, to block all traffic from outside your network to every host in your network, put the policy into the scope at the top of the tree.

- If you want to be able to override the general policy for some workloads (for example, following the example above, you want to block general access from outside your network but you want some

workloads to be accessible from outside the network), create the high-level policies as Default policies. Then create specific policies for the applicable workloads.

- Consider using templates to speed policy creation.
- See [Manually Create Policies, on page 12](#), [Policies for Specific Purposes, on page 14](#), and [Policy Templates, on page 15](#).

- (Optional) Initially, automatically discover policies at a scope near the top of your tree, for all scopes in a branch of the tree, to create coarse policies that allow all existing traffic and limit future unwanted traffic. You can then build granular policies that protects your network from unnecessary or unwanted traffic.

See [Discover Policies for One Scope or for a Branch of the Scope Tree, on page 22](#) and [Discover Policies Automatically, on page 19](#) for information.

- When you are ready to discover more granular policies, automatically discover policies for scopes at or near the bottom of your scope tree, especially in the scopes for individual applications.

See [Discover Policies for One Scope or for a Branch of the Scope Tree, on page 22](#) and [Discover Policies Automatically, on page 19](#) for information.

- Be sure you have policies that address uncommon or infrequent activities and scenarios, such as failover, restoration from backup, once-yearly activities, and so on.
- After you have identified and allowed the traffic that your applications require, then look for any traffic that shouldn't be occurring and block such instances.

Look first at traffic to and from your most sensitive applications.

For example, if you see traffic from your customer-facing web app to your top-secret research and development app's database, you want to investigate.

- Work with your colleagues to ensure that the correct policies are applied to the correct workloads.
- Initially, when you enforce policies, consider setting the catch-all to Allow. Then, monitor traffic to see what matches the catch-all rule. When no necessary traffic is matching the catch-all rule, you can set the catch-all to Deny.

Manually Create Policies

Typically, you can manually create policies that apply broadly across your network.

For example, you can manually create policies to:

- Allow access from all internal workloads to your NTP, DNS, Active Directory, or vulnerability scanning servers.
- Deny access from all hosts outside your organization to hosts inside your network unless explicitly permitted.
- Quarantine vulnerable workloads.

You can create absolute policies that cannot be overridden by more granularly applied policies, and default policies that can be overridden if a more specific policy exists.

You can create manual policies for scopes nearer the top of your tree.

Before you begin

- (Optional) Consider using one of the templates available from **Defend > Policy Templates**.
- (Optional) If you know you have a set of workloads that receive the same policies, use an inventory filter to group them so you can easily apply policies to the set. The inventory filter can apply to only one scope, or to workloads in any scope. See [Create an Inventory Filter](#).
- Make sure that the workloads in this scope are the workloads that you expect to be in this scope. See [View Workloads in a Scope, on page 4](#).

Step 1 Click **Defend > Segmentation**.

Step 2 In the list on the left, search for or navigate to the scope in which you want to create the policy.

Step 3 Click the scope and workspace in which you want to create the policy.

If you haven't yet created the workspace for this scope, see [Create a Workspace, on page 3](#).

Step 4 Click **Manage Policies**.

Step 5 Click the **Policies** tab if it is not already selected.

Step 6 Click **Add Policy**.

If you don't see an Add Policy button, see [If the Add Policy Button Is Not Available, on page 13](#).

Step 7 Enter information.

- For information about the **Absolute** checkbox, see [Policy Rank: Absolute, Default, and Catch-All, on page 9](#). Generally, if you are creating policies that you don't expect exceptions for, enable this checkbox.
- **Priority** sets the order of the policy in the list. For more information about setting policy order, see [Policy Priorities, on page 81](#) and subtopics. (You can set policy order later.)
- Consumer and provider can be entire scope, or, if you have created groups of workloads using inventory filters (or less optimally, clusters in the same workspace), you can choose those.

What to do next

Make sure the **Catch-all** action is appropriate for the workspace. See [Policy Rank: Absolute, Default, and Catch-All, on page 9](#).

If the Add Policy Button Is Not Available

If you are trying to create a policy and the **Add Policy** button is not available, click the version showing at the top of the page and choose the latest "v" version, which is indicated with a gray square:

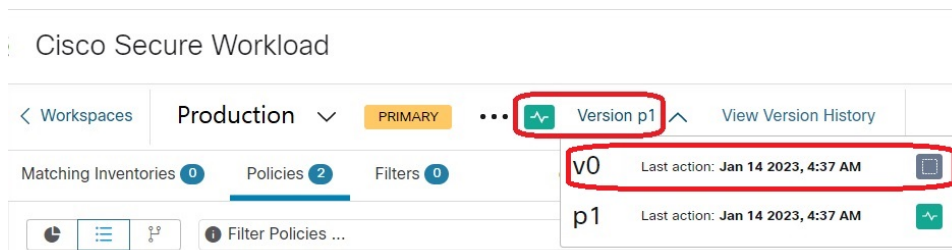

Policies for Specific Purposes

Create Policies to Address Immediate Threats

If you must address an immediate threat, you can manually add a narrowly focused Absolute policy to a scope at or near the top of your scope tree, then enforce the primary workspace for that scope.

After you remediate the threat, you can remove that policy and reinforce the workspace.

Create a Policy to Quarantine Vulnerable Workloads

You can:

- Create policies in advance, to automatically quarantine workloads with specific known vulnerabilities or a vulnerability severity threshold you specify.
- Create policies, to immediately quarantine workloads with detected known vulnerabilities that you deem sufficiently problematic.

This topic outlines the process for doing either.

Before you begin

Look at the [Vulnerability Dashboard](#) to see what policies are required.

Step 1 Create an inventory filter that defines the vulnerabilities or the vulnerability severity threshold that you want to quarantine:

- From the navigation bar at the left of the window, choose **Organize > Inventory Filters**.
- Click **Create Inventory Filter**
- Click the **(i)** button beside **Query** and enter **CVE** to see the relevant filter options.
- Enter filter criteria that determine which workloads you wish to quarantine.
- Be sure **Restrict query to ownership scope** is NOT selected.

Step 2 Create a policy to quarantine affected workloads:

For general instructions, see [Manually Create Policies, on page 12](#).

Recommendations:

- Create the policy in your **Internal** or other scope near the top of your scope tree.
- The policy should be an Absolute policy unless you want to allow exceptions. Be sure to create policies to address any exceptions.
- Create separate policies for consumer and provider.

- Set the priority of each policy to a low number so it will be hit before other policies in the list.
- Set the action to **Deny**.

Step 3 Review, analyze, and enforce the policy or policies.

What to do next

Create an alert so you are notified when traffic hits this policy so you can remediate the problem and restore traffic to the vulnerable workload. See [Configure Alerts](#).

Policy Templates

Policy Templates are used to apply similar sets of policies to multiple workspaces.

Secure Workload includes some predefined templates, and you can create your own templates.

Policy templates require the scope owner capability on the root scope.

System-Defined Policy Templates

To view available policy templates, navigate to **Defend > Policy Templates**.

To use a policy template, see [Applying a Template, on page 18](#).

To modify a system-defined template, download the JSON file, edit it, then upload it.

Create Custom Policy Templates

JSON Schema for Policy Templates

The policy template JSON schema is designed to mimic the schema of [Export a Workspace](#). You can create a set of policies in a workspace, export it as JSON, modify the JSON, then import as a policy template.

Attribute	Type	Description
name	string	(optional) Used as the name of the template during import.
description	string	(optional) Template description that is displayed during the apply process.
parameters	parameters object	Template parameters, see below.
absolute_policies	array of policy objects	(optional) Array of absolute policies.
default_policies	array of policy objects	(required) Array of default policies, can be empty.

Parameters Object

The parameters object is optional but can be used to dynamically define filters as parameters to the template. The parameters are referenced using the `consumer_filter_ref` or `provider_filter_ref` policy attributes.

The keys of the parameters object are the reference names. The values are an object with a required `"type": "Filter"` and an optional description. An example Parameters object is shown below:

```
{
  "parameters": {
    "HTTP Consumer": {
      "type": "Filter",
      "description": "Consumer of the HTTP and HTTPS service"
    },
    "HTTP Provider": {
      "type": "Filter",
      "description": "Provider of the HTTP and HTTPS service"
    }
  }
}
```

The parameters can be referenced in the policy objects, for example: `"consumer_filter_ref": "HTTP Consumer"` or `"provider_filter_ref": "HTTP Provider"`.

Special Parameter References

A few special references automatically map to a filter and do not need to be defined as parameters.

Ref	Description
<code>_workspaceScope</code>	Resolves to the scope of the workspace to which the template is being applied.
<code>_rootScope</code>	Resolves to the root/top level scope.

Policy Object

To maintain compatibility with the workspace export JSON, the policy object contains multiple keys for consumers and providers. They are resolved as follows:

```
if *_filter_ref is defined
  use the filter resolved by that parameter
else if *_filter_id is defined
  use the filter referenced by that id
else if *_filter_name is defined
  use the filter that has that name
else
  use the workspace scope.
```

If a filter cannot be resolved as defined above, an error is returned both at the time of application and at the time of upload.

Attribute	Type	Description
<code>action</code>	string	(optional) Action of the policy, ALLOW, or DENY (default ALLOW).

Attribute	Type	Description
priority	integer	(optional) The priority of the policy (default 100).
consumer_filter_ref	string	Reference to a parameter.
consumer_filter_name	string	Reference to a filter by name.
consumer_filter_id	string	ID of a defined Scope or Inventory Filter.
provider_filter_ref	string	Reference to a parameter.
provider_filter_name	string	Reference to a filter by name.
provider_filter_id	string	ID of a defined Scope or Inventory Filter.
l4_params	array of l4params	List of allowed ports and protocols.
Attribute	Type	Description
proto	integer	Protocol integer value (NULL means all protocols).
port	integer	Inclusive range of ports, for example, [80, 80] or [5000, 6000] (NULL means all ports).

L4param object

Attribute	Type	Description
proto	integer	Protocol integer value (NULL means all protocols).
port	integer	Inclusive range of ports, for example, [80, 80] or [5000, 6000] (NULL means all ports).

Template Sample

```
{
  "name": "Allow HTTP/HTTPS and SSH",
  "parameters": {
    "HTTP Consumer": {
      "type": "Filter",
      "description": "Consumer of the HTTP and HTTPS service"
    },
    "HTTP Provider": {
      "type": "Filter",
      "description": "Provider of the HTTP and HTTPS service"
    }
  }
},
```

```

"default_policies": [
  {
    "action": "ALLOW",
    "priority": 100,
    "consumer_filter_ref": "__rootScope",
    "provider_filter_ref": "__workspaceScope",
    "l4_params": [
      { "proto": 6, "port": [22, 22] },
    ]
  },
  {
    "action": "ALLOW",
    "priority": 100,
    "consumer_filter_ref": "HTTP Consumer",
    "provider_filter_ref": "HTTP Provider",
    "l4_params": [
      { "proto": 6, "port": [80, 80] },
      { "proto": 6, "port": [443, 443] }
    ]
  }
]
}

```

Template Import

Policy Templates shown on the Policy Templates page that can be accessed from the main Segmentation page. This is where templates can be imported/uploaded using the “Import Template” button.

Templates are validated for correctness when they are uploaded. A helpful list of errors is provided to debug any issues.

Once a template is uploaded, it can be applied, downloaded, or have its name and description updated.

Figure 4: Display of Available Templates

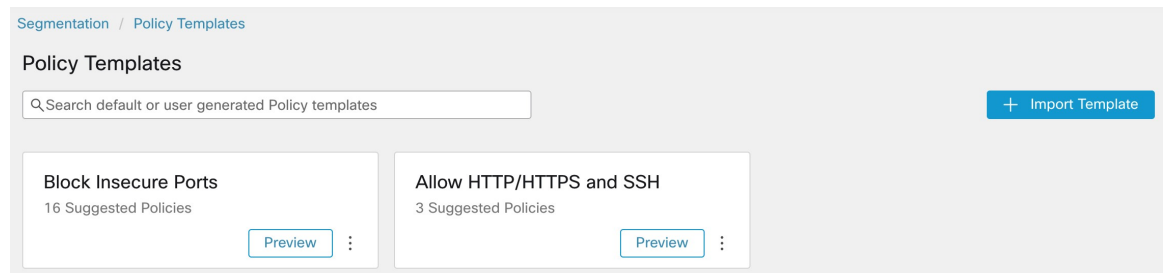

Applying a Template

Applying a template to a workspace takes several steps:

1. Select a template to preview.
2. Select a workspace to apply the template to.
3. Fill in parameters, if necessary.
4. Review the policies.
5. Apply the policies.

The policies will be added to the latest version of the selected workspace. Policies created via a template can be filtered using the `From Template? = true` filter.

Figure 5: Applying a Policy Template

Segmentation / Policy Templates / Allow HTTP/HTTPS and SSH

Allow HTTP/HTTPS and SSH Apply Policies

Select workspace

Default Default ×
Primary Workspace

Parameters

HTTP Consumer ⓘ
Select a scope

HTTP Provider ⓘ
My HTTP/HTTPS Service ×

Policies

3 Suggested Policies

Rank ↑↓	Priority ↑↓	Action ↑↓	Consumer ↑↓	Provider ↑↓	Protocol ↑↓	Port ↑↓
Default	100	ALLOW	Default	Default	TCP	22 (SSH)
Default	100	ALLOW	Defined by HTTP Consumer	My HTTP/HTTPS Service	TCP	80 (HTTP)
Default	100	ALLOW	Defined by HTTP Consumer	My HTTP/HTTPS Service	TCP	443 (HTTPS)

Discover Policies Automatically

Automatic policy discovery, sometimes referred to as policy discovery, and formerly known as Application Dependency Mapping (ADM), uses existing traffic flows and other data to do the following:

- Suggest a set of “allow” policies based on existing successful network activity.

The goal of these policies is to identify the traffic that your organization needs, and block all other traffic.

- Group workloads into clusters based on similarity of their computing behavior

For example, if an application includes multiple web servers, those might be clustered together.

For more information, see [Clusters, on page 71](#).

You can discover policies for each scope. Typically, you discover policies for scopes at or near the bottom of your scope tree, for example at the application level. However, for initial deployment, you might want to discover policies at a higher-level scope, so you have general, temporary policies in place while you create more refined policies.

You can discover policies as often as desired, to refine the suggested policies based on additional information.

You can manually modify suggested policies and clusters, and/or approve any of them so they are carried forward and not modified by subsequent discovery runs.

You can include both manually created policies and discovered policies in a workspace.

After you discover policies, you will review and analyze them before enforcing them.

To get started discovering policies, see [How to Automatically Discover Policies, on page 20](#).

For more information, see [Policy Discovery Details, on page 20](#).

Figure 6: Example: Automatically Discovered Policies

Rank T1	Priority T1	Action T1	Consumer T1	Provider T1	Protocols And Ports T1
Default	10	ALLOW	Internal : datacenter : non-prod : app2	jumpshot	TCP : 12345 (trend-micro-av) ... 1 more
Default	10	ALLOW	Internal : datacenter : non-prod : app2	Internal : datacenter : non-prod : app2	TCP : 443 (HTTPS)
Default	100	ALLOW	wildfire : internal : datacenter : non-prod	wildfire	ICMP ... 5 more
Default	100	ALLOW	Internal : datacenter : non-prod : app2	wildfire : internal	UDP : 53 (DNS) ... 2 more
Default	100	ALLOW	jumpshot	wildfire : internal : datacenter : non-prod	TCP : 22 (SSH)
Default	100	ALLOW	wildfire : internal : datacenter : non-prod	wildfire : internal : datacenter : non-prod	TCP : 22 (SSH)
Default	100	ALLOW	Internal : datacenter : non-prod : app2	wildfire : internal : datacenter : prod : app1	TCP : 22 (SSH)
Default	100	ALLOW	wildfire	Internal : datacenter : non-prod : app2	TCP : 3389 (Remote Desktop)
Default	100	ALLOW	wildfire : internal	Internal : datacenter : non-prod : app2	TCP : 22 (SSH)
Default	100	ALLOW	Internal : datacenter : non-prod : app2	Internal : datacenter : non-prod : app2	TCP : 21 (FTP Control) ... 1 more

Policy Discovery Details

Additional information about automatic policy discovery:

- Automatic policy discovery considers conversations in which at least one end is a member workload of the scope within the time range selected. Membership in the scope is based only on the most current scope definition; former membership is not considered.
- By default, policy discovery produces policies and clusters by analyzing communication flows ("conversations"), but optionally can consider other information such as processes running on workloads or load balancer configurations.

See [Include Data From Load Balancers and Routers When Discovering Policies, on page 34](#).

- You can discover policies in any workspace within the scope. Discovery results in each workspace are independent of the results in other workspaces in the scope.
- For detailed discussions of complex concepts that are related to automatic policy discovery, see [Advanced Features of Automatic Policy Discovery, on page 27](#) and [Address Policy Complexities, on page 81](#).

How to Automatically Discover Policies

Perform the following steps. At any point, you can decide to discover policies again.

Work with colleagues as needed to complete these steps.

Step	Do This	More Information
1	Upload and label your workload inventory, and gather flow data that inform policy discovery.	See Get Started with Segmentation and Microsegmentation and subtopics.
2	Choose whether you discover policies for: <ul style="list-style-type: none"> • Workloads in a single scope • Workloads in all of the scopes in a branch of the scope tree 	See Discover Policies for One Scope or for a Branch of the Scope Tree , on page 22. (You can always discover policies again at any time.)
3	Choose the scope in which you discover policies.	This depends in part on whether you discover policies for a single scope or for a branch of the scope tree.
4	Choose the workspace in which you discover policies.	Generally, you will discover policies in the scope's primary workspace, because you can only analyze policies in a primary workspace. (However, you can always change a workspace to primary later.) If your chosen scope does not yet have a workspace, see Create a Workspace , on page 3.
5	Confirm the inventory that you expect to include in policy discovery.	Verify the Workloads That Policy Discovery Will Apply To , on page 24
6	(Optional) Create inventory filters to group workloads that you want to treat as a group.	See Create an Inventory Filter .
7	Set the Catch-all action for the workspace.	See Policy Rank: Absolute, Default, and Catch-All , on page 9
8	Discover Policies	Discover Policies Automatically , on page 19 Be sure to complete the prerequisites in the "Before You Begin" section.
9	View and manage the clusters (groups of workloads) that policy discovery creates. (This step applies only when you discover policies for a single scope; clusters are not generated when you discover policies for a branch of the tree.)	See Clusters , on page 71 and subtopics. Evaluate the suggested clusters, optionally edit cluster membership as needed, and approve (or better, convert to inventory filters) any clusters that you want to make permanent.
10	Consider complexities such as policy inheritance and cross-scope policies.	See Address Policy Complexities , on page 81.
11	Review generated policies.	See Review Automatically Discovered Policies , on page 104 and subtopics

Step	Do This	More Information
12	Approve policies that you want to keep.	Approve Policies , on page 46
13	Discover policies again as desired, to reflect additional flow data, changes in scope membership, or other changes.	Important: Before You Re-run Automatic Policy Discovery , on page 49 You can rerun policy discovery at any time. Review and approve policies and clusters each time you discover policies.
14	Run live analysis to see how your policies affect your actual traffic.	When you believe that your policies do what you expect them to do, start Live Policy Analysis , on page 118. If you change policies or rediscover policies, restart policy analysis (to analyze the current policies).
15	If you re-discover policies or make other changes, restart live analysis.	See After Changing Policies, Analyze Latest Policies , on page 126.
16	When you are confident that the policies will not block essential traffic, enforce the workspace.	See Enforce Policies and subtopics .
17	Verify that enforcement is working as expected.	See Verify That Enforcement Is Working as Expected , on page 138
18	(Optional) Configure default policy discovery settings that optionally apply when discovering policies in any workspace.	See Default Policy Discovery Config , on page 44 and linked topics. Because these are advanced settings, we recommend that you change them only if you have a specific need to change them. You can change them at any time during your process as you realize a need.

Discover Policies for One Scope or for a Branch of the Scope Tree

Table 2: Discovering Policies For

A Branch of the Scope Tree	A Single Scope
Use this method as a starting point, when you are beginning to use Secure Workload, to quickly generate a temporary set of coarse policies that allow existing traffic while helping to protect your network from future threats.	Use this method to fine-tune segmentation policies and ensure that all allowed flows are expected; the smaller number of policies makes it easier to see any existing anomalies that require investigation.
Typically, you use this method for scopes nearer the top of your scope tree. The top of the branch can be any scope in the tree.	Typically, you use this method for scopes at or near the bottom of your scope tree, for example for scopes dedicated to a single application.

A Branch of the Scope Tree	A Single Scope
Discover policies only in one scope – the scope at the top of the branch that you choose.	Discover policies for each scope in the branch as needed.
All workloads in the chosen scope and all child and descendant scopes are included in discovery.	<p>Workloads that are also members of any child scope are not included in discovery for this scope.</p> <p>Policies are generated only for workloads that appear in the Uncategorized Inventory tab for that scope on the Organize > Scopes and Inventory page.</p> <p>You can discover policies for workloads in child and descendant scopes separately.</p>
All policies for workloads in all scopes in the branch reside in the scope at the top of the branch.	Assuming you also create policies for workloads in child and descendant scopes, policies reside in multiple scopes.
This method typically generates a large number of policies.	This method generates fewer policies in any individual scope.
Discovered policies apply to entire scopes; this option cannot create policies specific to subsets of workloads within scopes.	This option can generate policies that apply to subsets of workloads within the consumer and/or provider scope. (Workloads can be grouped by generated clusters and/or by configured inventory filters, and policies applied just to these subsets.)
All policies are created in a single scope at the top of the branch, so extra steps are not required when a policy's consumer and provider are in different scopes.	<p>Allowing traffic between consumers and providers in different scopes requires extra steps.</p> <p>See When Consumer and Provider Are In Different Scopes: Policy Options, on page 87.</p>
Discovery can run even if a scope does not have any member workloads with installed agents, as long as descendant scopes have agents or external orchestrators or connectors that gather flow data.	The scope must have member workloads with installed agents or external orchestrators or connectors that gather flow data.
This option is available to root scope owners and site admins only.	You must have privileges to create policies for this scope.
The maximum number of agents and conversations is different for each option. See Limits Related to Policies .	
<p>To use this method:</p> <p>When you configure automatic policy discovery, enable Deep policy generation in the Advanced Configurations section of the configuration page.</p> <p>For details, see Deep policy generation, on page 40.</p>	This is the default behavior when discovering policies.

Verify the Workloads That Policy Discovery Will Apply To

Before you automatically discover policies, verify that the workloads on which policy discovery will be based are in fact the set of workloads you expect. Discovered policies will be generated from flow data captured by agents on these workloads.

Before you begin

Decide which of the options in [Discover Policies for One Scope or for a Branch of the Scope Tree](#), on page 22 you can use.

-
- Step 1** From the navigation menu on the left, choose **Defend > Segmentation**.
- Step 2** Click the scope for which you want to discover policies.
- Step 3** Click the workspace in which you want to discover policies.
- Step 4** Click **Manage Policies**.
- Step 5** Click **Matching Inventories**.
- Step 6** If you discover policies for a single scope:
- a) Click **Uncategorized Inventory**

This page shows workloads that are not also members of child scopes. (In standard automatic policy discovery, policies and clusters are generated in this scope only for workloads that are not also members of child scopes.)
 - b) Click **IP addresses**.

IP addresses on this page do not have Secure Workload agents installed.

Because they do not have agents that are installed, these IP addresses are not considered during automatic policy discovery for this scope UNLESS:

 - Policy is being managed via a cloud connector
 - The IP addresses are container-based inventory, in which case individual workloads appear on the **Pods** tab, or
 - The workloads happen to communicate with a workload in this scope that is considered during policy discovery.

Before discovering policies, consider installing agents on workloads that need them and allowing some time to pass for flow data to accumulate.
 - c) Click **Workloads**.

Policies and clusters are generated only for workloads on this page and for IP addresses on the IP addresses tab that meet the criteria specified above for consideration.
 - d) If you have Kubernetes or OpenShift inventory, you will see a **Services** tab and a **Pods** tab.

If you have installed agents on your Kubernetes/OpenShift workloads, check the inventory on those tabs as well.
 - e) If you have load-balancer inventory, that inventory appears on the **Services** tab.
- Step 7** If you discover policies for a branch of the tree:
- a) Click **All Inventory**

This process generates policies (but not clusters) for all workloads in this scope, whether they are also members of child scopes.
 - b) Click **IP addresses**.

IP addresses on this page do not have Secure Workload agents installed.

Because they do not have agents installed, these IP addresses will not be considered during automatic policy discovery for this scope unless:

- Policy is managed via a cloud connector
- The IP addresses are container-based inventory, in which case individual workloads appear on the **Pods** tab, or
- The workloads happen to communicate with a workload in this scope that is considered during policy discovery.

Before discovering policies, consider installing agents on these workloads and allowing some time to pass for flow data to accumulate.

c) Click **Workloads**.

Policies are generated only for workloads on this page and for IP addresses on the IP addresses tab that meet the criteria specified above for consideration.

d) If you have Kubernetes or OpenShift inventory, you will see a **Services** tab and a **Pods** tab.

If you have installed agents on your Kubernetes/OpenShift workloads, check the inventory on those tabs as well.

e) If you have load-balancer inventory, that inventory appears on the **Services** tab.

Step 8 Verify that the workloads are the set you expect.

Automatically Discover Policies

Use this procedure to generate suggested Allow policies based on existing traffic on your network.

You can rediscover policies at any time.

Before you begin

- Gather flow data before you can effectively automatically discover policies.

Typically, this means you have installed agents on the workloads in the scope, or have configured and gathered data using a cloud connector or external orchestrator.

Flow summary data that is used by automatic policy discovery is computed every 6 hours. Thus, upon initial deployment of Secure Workload, automatic policy discovery is not possible until such data is available.

More flow data generally produces more accurate results.

Before you enforce policy, you should gather enough data to include traffic that occurs only periodically (monthly, quarterly, annually, and so on.) For example, if an application generates a quarterly report that gathers information from sources that the application does not access at other times, ensure that the flow data includes at least one instance of that report-generation process.

- Complete the steps up to this point in [How to Automatically Discover Policies, on page 20](#).
- Meet the policy discovery-related [Limits Related to Policies](#).

If necessary, break larger scopes into smaller child scopes.

- Commit any scope changes before discovering policies, or any configured exclusion filters may not match (exclude) flows as expected. See [Commit Changes](#).



Important If you are rerunning policy discovery, see important considerations first: [Important: Before You Re-run Automatic Policy Discovery, on page 49.](#)

-
- Step 1** Choose **Defend > Segmentation**.
- Step 2** In the scope tree or list of scopes in the pane on the left, scroll to or search for the scope for which you want to generate policies.
- Step 3** Click a workspace (primary or secondary) in the scope.
- Step 4** Click **Manage Policies**.
- Step 5** Click **Automatically Discover Policies**.
- Step 6** Choose the time range for the flow data that you want to include.
- Experiment to find the right time range; you can generate policies as often as needed to get optimal results.
- A shorter time range generates results faster, and may generate fewer results.
- In general, a longer time range produces more accurate policies. However, if the scope definition has changed, donot include dates before the change is made.
- Your time range should include traffic that occurs only periodically (monthly, quarterly, annually, and so on.) if applicable. For example, if an application generates a quarterly report that gathers information from sources that it does not access at other times, be sure that the time range includes at least one instance of that report-generation process.
- To configure a time range beyond the last 30 days, select **custom** range, and fill in the desired start and end times under the drop-down time selection widget.
- Step 7** (Optional) Specify advanced settings.
- Generally, we suggest that you don't change advanced settings for initial discovery runs, then make changes only as needed to address specific issues.
- For details, see [Advanced Configurations for Automatic Policy Discovery, on page 33.](#)
- Step 8** Click **Discover Policies**. Generated policies appear on this page.
-

What to do next

- View [Stop Automatic Policy Discovery in Progress, on page 26.](#)
- Return to [How to Automatically Discover Policies, on page 20](#) and continue with the next step in the table.
- You can rediscover policies at any time. For actions you should take first, see [Important: Before You Re-run Automatic Policy Discovery, on page 49.](#)

Stop Automatic Policy Discovery in Progress

Progress of automatic policy discovery is always visible in the header. Navigating to other workspaces does not affect the progress.

To stop the run while it is in progress, click the **abort** button.

Once the run is complete, a message is displayed. If successful, **Click to see results** navigates to a different view showing the changes before and after the run. If automatic policy discovery fails, it is indicated with a different message and a reason.

Figure 7: Automatic Policy Discovery Progress

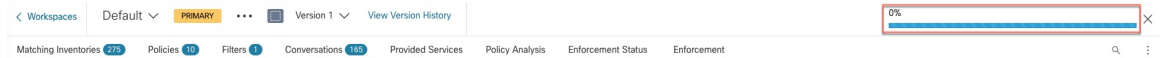

Advanced Features of Automatic Policy Discovery

You must specify a time range for the discovery run. If necessary, you can configure advanced options.

You can configure advanced options for each workspace, or set defaults for all workspaces (the entire root scope), then modify the settings for individual workspaces as needed.

Table 3: Configure Advanced Options for Automatic Policy Discovery

For a Workspace	For All Workspaces
Option descriptions for individual workspaces (in column 1) apply also for all workspaces (column 2)	
External Dependencies, on page 30	Default Policy Discovery Config, on page 44
Advanced Configurations for Automatic Policy Discovery, on page 33	Default Policy Discovery Config, on page 44
Exclusion Filters, on page 27	Default Exclusion Filters, on page 44

Exclusion Filters

If certain flows are generating unwanted policies, you can exclude those flows from automatic policy discovery using exclusion filters.

For example, to disallow certain protocols like ICMP in the final allow list model, you can create an exclusion filter with a protocol field set to ICMP.



Note

- Conversations that match exclusion filters are excluded for the purposes of policy generation and clustering, but remain in the Conversations View with red 'excluded' icon (see the Table View in [Conversations](#)). Likewise, workloads of the workspace incident on such conversations remain viewable as well.
- An exclusion filter that uses a cluster or a filter definition from a workspace is effective only in primary workspaces (otherwise, its cluster definitions are not visible to the label system, and any matching conversations are not excluded).
- Exclusion filters are versioned; to track modifications, see [Activity Logs and Version History](#).
- For limits on the number of exclusion filters, see [Limits Related to Policies](#).

You can create one or both of the following, then enable either or both when discovering policies:

- A list of exclusion filters for each workspace.
- A list of default exclusion filters that is available to all workspaces in your tenant.

You can also enable or disable either or both lists for the Default Policy Discovery Config.

For instructions, see [Configure, Edit, or Delete Exclusion Filters, on page 28](#) and [Enable or Disable Exclusion Filters, on page 29](#).

Configure, Edit, or Delete Exclusion Filters

You can use this procedure to create a list of exclusion filters for a single workspace, or a list of default exclusion filters that are available to all workspaces.

Step 1

Do one of the following:

To	Do This
Configure exclusion filters for a specific workspace	<p>Navigate to the workspace, then do one of the following:</p> <ul style="list-style-type: none"> • Click Manage Policies, then click  near the top right of the page and select Exclusion Filters. • From the automatic policy discovery configuration page, click the Exclusion filters link in the Advanced Configurations section. • Delete a discovered policy; you will see an option to create an exclusion filter.
Configure default exclusion filters that are available to any workspace	<ol style="list-style-type: none"> a. Choose Defend > Segmentation, b. Click the caret at the right side of the page to expand the Tools menu, then choose Default Policy Discovery Config. c. Scroll to the bottom of the page. d. Click Default Exclusion Filters.

Step 2

To create an exclusion filter, click **Add Exclusion Filter**.

Step 3

Specify parameters for the flows to exclude from consideration during policy discovery:

You do not need to enter values for all of the fields. Any empty field is treated as a wildcard for matching flows.

Any conversation that matches all the fields of any exclusion filter is ignored for the purposes of policy creation and clustering.

Option	Description
Consumer	Matches conversations where the consumer address is a member of the selected scope, inventory filter, or (for workspace-specific exclusion filters only, cluster). You can specify any arbitrary address space by creating a new custom filter.
Provider	Matches conversations where the provider address is a member of the selected scope, inventory filter, or (for workspace-specific exclusion filters only, cluster). You can specify any arbitrary address space by creating a new custom filter.
Protocol	Matches conversations with specified protocol.

Option	Description
Port	Matches conversations with provider (server) port matching the specified port, or port range. Enter port ranges using a dash separator, for example, “100-200”

Step 4 To edit or delete an exclusion filter, hover over the applicable row to see the **Edit** and **Delete** buttons.

Step 5 If you are configuring default exclusion filters:

When the configured filters are ready to use, return to the **Default Policy Discovery Config** page, and click **Save** to make the changes available to individual workspaces.

What to do next



Important Exclusion filters are enabled by default in the workspace in which they are configured. Default exclusion filters are enabled by default in all workspaces. Both types of exclusion filters are enabled by default in the Default Policy Discovery Config.

Before discovering policies:

- Enable or disable exclusion filters and default exclusion filters.
 - In each workspace
 - On the Default Policy Discovery Config page

For instructions, see [Enable or Disable Exclusion Filters, on page 29](#).

- Commit any scope changes, or the filters may not match (and therefore exclude) the expected flows. See [Commit Changes](#).

Enable or Disable Exclusion Filters

You can create exclusion filters in each workspace and/or create a set of default exclusion filters that you can apply to all workspaces.

By default, both types of exclusion filters are enabled.

To make changes

- To enable or disable exclusion filters for a single workspace:

In the workspace, click **Manage Policies**, then click **Automatically Discover Policies**, then click **Advanced Configurations**. You can enable exclusion filters and/or default exclusion filters for this workspace.

- To enable or disable exclusion filters in the Default Policy Discovery Config:

Choose **Defend > Segmentation**, then click the caret at the right side of the page to expand the Tools menu. Then choose **Default Policy Discovery Config**. Scroll to or click **Advanced Configurations**. You can enable exclusion filters and/or default exclusion filters.

External Dependencies

External dependencies are relevant only when you use the process that is described in [\(Advanced\) Create Cross-Scope Policies, on page 88](#).

External Dependencies settings apply to automatically discovered policies involving communications to and from workloads that are members of a scope other than the scope in which policies are discovered. (That is, communications involving "external workloads.")

A workload that is not a member of the scope in which the policy exists is an *external workload*. Such workloads are the other end of a conversation with a *target workload* (which is a member of the scope in which the policy exists).

The External Dependencies list is an ordered list of all scopes in your hierarchy. Each scope in the list is set to one of the following:

- Generate specific or refined policies (more secure), or
- Generate coarse policies in higher scopes, which may generalize better (that is, be more likely to allow legitimate flows that were not seen in the time range specified when discovering policies).

During policy discovery, the first scope (or cluster, or inventory filter – see below) that matches the workload will be used to generate the “allow” policy, where the matching order (and consequent granularity level) is determined by the top-down ranking that is displayed in the External Dependencies section.

A default scope order is configured for you, with all scopes set to "Coarse" by default.

Figure 8: Default External Dependencies

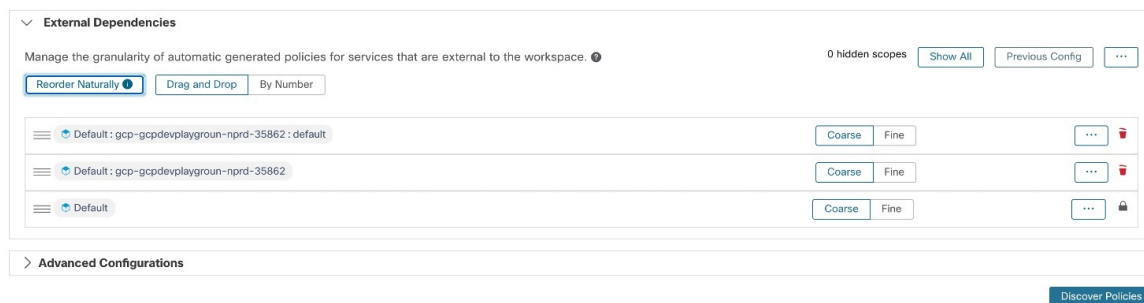

To	Do This
View or fine-tune external dependencies for a workspace:	Navigate to the workspace and click Automatically Discover Policies , then click External Dependencies . To reorder the scopes and choose granularity options for each, see Fine-Tune External Dependencies for a Workspace, on page 31 .
Configure default external dependencies for an entire root scope:	See Default Policy Discovery Config, on page 44 .

External Dependencies: Granular Policies Involving Subsets of Scopes

You can optionally discover policies at a more granular level than scope-to-scope, to control traffic to a specified subset of the workloads in a scope.

For example, you may want to create policies specific to a certain type of host within an application, such as API servers; you can group those workloads into a subset within the application scope.

To generate policies specific to a subset of workloads within a scope, see [Fine-Tune External Dependencies for a Workspace](#), on page 31.

Tips for Exploring External Dependencies

Use the following tips to explore the behavior of automatic policy discovery for policies involving workspaces that are not members of the scope that is associated with the workspace in which the policies reside.



Tip

- You can remove and rearrange the list to generate policies at a desired granularity. For example, removing all Company: RTP subsopes will help generate wide policies to the whole Company:RTP scope, but not its individual components, while maintaining the higher granularity for Company: SJC scope. Furthermore, you can click on the **Fine** button next to any scope and see if there are finer grain candidates defined under that scope.
- By default, the root scope is configured as the lowest entry in the External Dependencies list, so that automatic policy discovery always generates policies to more specific scopes whenever possible. Initially, to view relatively few coarse-grained policies, you can temporarily place the root scope on the top of the external dependencies. This way, after automatic policy discovery, you will see all external policies of the workspace connecting to only one scope, the root scope (as every external workload maps to the root scope). The resulting number of generated policies are smaller and easier to examine and comprehend.
- You can also temporarily bundle all workloads that are members of the scope associated with the workspace ("internal workloads") into one cluster, approve the cluster, and then discover policies. Again, this results in a reduced set of policies, as no clustering (subpartitioning of the workspace/scope) takes place, so you can view policies that are either internal (connect to internal workloads), or external (connect an internal to an external workload). Later, you can view progressively more refined policies by unbundling internal workloads and/or placing one or a few external scopes of interest above the root.
- **Important** Always carefully examine policies involving the root scope, since these policies allow all traffic to and from the entire network. This is especially important when the root scope is placed low in the External Dependencies list and it is not your intention to generate coarse policies. Such policies may not have resulted from network-wide traffic in or out of the workspace scope. Rather they can be triggered by a few external endpoints which failed to receive finer scopes or inventory filter assignments beyond simply the root scope.

While auditing these policies, you should examine the associated conversations (See [Conversations](#)) to identify these endpoints and subsequently categorize them into finer scopes or inventory filters, to avoid less-secure policies at the root-scope level.

Fine-Tune External Dependencies for a Workspace

Use this procedure to create policies between specified subsets of workloads within scopes (rather than between entire scopes) during automatic policy discovery, when the provider of a policy belongs to a different scope than the scope in which policies are being discovered.

Figure 9: Fine-tuning External Dependencies

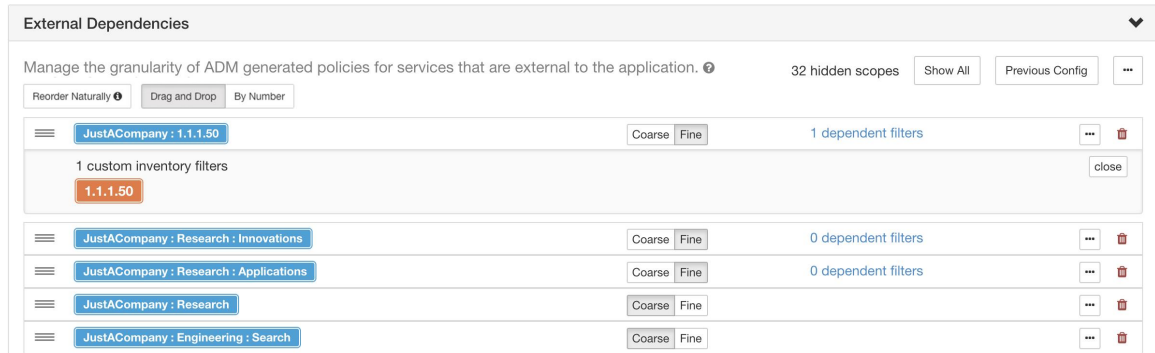

Before you begin

- Configure an inventory filter for each subset of workloads for which you want to generate specific policies. You can create any number of inventory filters, in any scope.

There are several ways to create inventory filters:

- Convert clusters of interest to inventory filters.
(See [Convert a Cluster to an Inventory Filter, on page 76](#)),
and/or
- Create new inventory filters.
See [Create an Inventory Filter](#).

These filters must have the following options enabled:

- **Restrict query to ownership scope**
Provides a service external of its scope
- See also [Tips for Exploring External Dependencies, on page 31](#).

-
- Step 1** Navigate to the workspace in which you will discover policies.
- Step 2** Click **Automatically Discover Policies**.
- Step 3** Click **External Dependencies**.
- Step 4** If necessary, click **Show All** scopes.
- Step 5** (Optional) Leverage previous configurations:
- To reuse the changes you made to the list the last time you discovered policies, click **Previous Config**.
 - If you have set up external dependencies in the global “Default Policy Discovery Config”, you can use the global list by clicking **Default Config**. Or, after obtaining the default list, you can modify it as desired (for that workspace only), and then use the customized version on subsequent runs by clicking **Previous Config** once.
- Step 6** Reorder scopes (and inventory filters, if applicable) as needed.

Policy is applied based on the first scope or inventory filter in the list (starting from the top) that matches the traffic. For this purpose, you generally want to apply the most specific policy that matches traffic, so you want child scopes (more specific) above their parents (less specific).

- If you have recently created new child scopes, which by default are added to the bottom of the list, reorder the entire list to place child scopes above their parents:

(Recommended) Click **Reorder Naturally**.

Figure 10: Reorder naturally

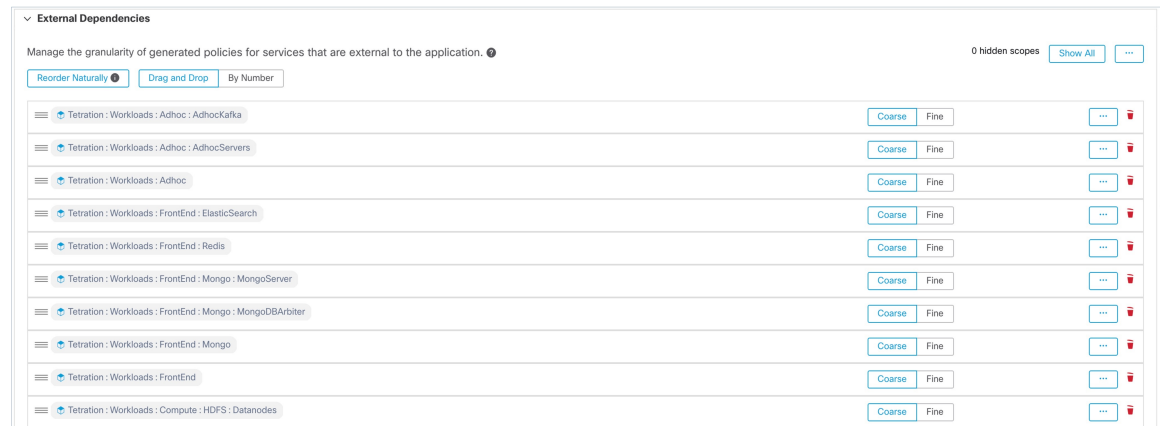

- (If you have a specific reason) To reorder the list manually:

- Click **Drag and Drop**.
- Click **By Number**:

The external dependencies will be assigned priority values in multiples of 10. Change the values to change the order.

Once numbers are modified, click **View** to update the list order and reassign multiples of 10 to each of the priorities.

Step 7 Specify granularity for each row:

- Click **Fine** for each row for which you want to generate policies specific to configured inventory filters or clusters. Click **Coarse** to generate policies that apply to the entire scope.
- To apply granularity to all subscopes of a scope: Click the button at the end of the scope's row.

Advanced Configurations for Automatic Policy Discovery

Use advanced settings to include additional information when discovering policies or to adapt to a particular environment.

- To access these settings for a specific workspace, click **Automatically Discover Policies** in the applicable workspace.
- To change the defaults for all workspaces, see [Default Policy Discovery Config, on page 44](#).

Figure 11: Advanced Automatic Policy Discovery Configurations

Include Data From Load Balancers and Routers When Discovering Policies

You can upload data from load balancers and routers to inform automatic policy discovery.

To access the following options, click **Advanced Configurations** in the automatic policy discovery settings and look at the "Side Information" or "sideinfo" section.

Option	Description
SLB Config (Upload load balancer configurations)	<p>To download data from your load balancer in the correct format, see Retrieving LoadBalancer Configurations for Advanced Policy Discovery Configuration.</p> <p>Supported formats for uploading loadbalancer configs:</p> <ul style="list-style-type: none"> • F5 BIG-IP • Citrix Netscaler • HAProxy • Others: <p>Use the Normalized JSON schema.</p> <p>You must convert any unsupported load balancer config into this schema.</p> <p>This simple schema includes basic information on Virtual IPs (VIPs) and backend IPs.</p> <p>To download a sample JSON file, click the info button beside SLB Config.</p>
Upload Route Labels	<p>You can upload a list of provisioned subnets/routes from the routers to help partition hosts based on pre-provisioned set of subnets. The clustering results generated by automatic policy discovery never span the subnet boundaries as defined by the uploaded data. You can modify the results after automatic policy discovery is complete.</p> <p>To download a sample JSON file, click the info button beside Route Labels.</p>



Note Clusters do not span partition boundaries, meaning a cluster computed by automatic policy discovery does not contain target workloads from two different partitions. Partitions are computed from the uploaded load balancer or router data. However, you can freely move workloads from one cluster to another, for example by changing cluster query definitions (manual cluster editing), or disable the upload of any side info.

To view or delete a previously uploaded Load Balancer (SLB Config) or Route Labels file:

1. Click into the respective box labeled **Select a source for this side information**.

A list of uploaded files will appear.

2. Click the download or trash icon beside the file to view or delete.

Figure 12: Uploaded Side Information

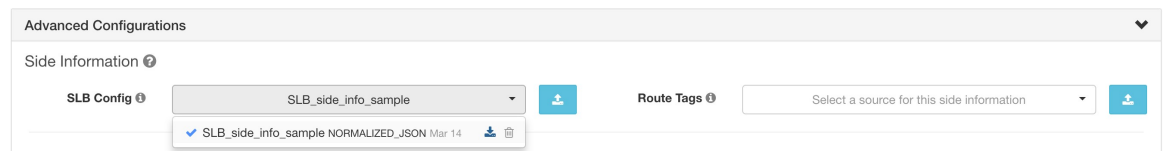

Cluster Granularity

Clustering Granularity allows you to control the size of the clusters generated by automatic policy discovery.

- **Fine** results in more but smaller clusters
- **Coarse** results in fewer but larger clusters



Note You may not observe a significant change in the results due to many other signals that our algorithms take into account. For example, if there is a very high confidence in the generated clusters, changing this control will make little change in the results.

Port Generalization

The **Port Generalization** option in **Advanced Configurations** for automatic policy discovery controls the level of statistical significance required when performing port generalization, i.e., replacing numerous ports being used as server ports on a single workload, with a port interval.

This setting can affect accuracy, number, and compactness of policies and the time required to generate them.

To disable port generalization, move the slider to the extreme left. Note that if disabled, automatic policy discovery and/or automatic policy discovery UI rendering time may be slowed substantially, in case many server ports are used by the workloads.

As the slider is moved to the right toward more aggressive generalization, less evidence is required to create port-intervals and also the criterion for replacing original policies (involving single ports) with port-intervals is relaxed.

Background

Some applications such as Hadoop use and change many server ports in some interval, for instance in 32000 to 61000. Automatic policy discovery attempts to detect such behavior for each workload, using the workload's server port usages in the observed flows: by observing only a fraction of total possible ports (but numerous ports, eg 100s), automatic policy discovery may 'generalize' that any port in, say 32000 to 61000, could be used as a server port by the workload. Ports that fall within intervals are replaced with such intervals (when certain criteria on minimum observed counts are met). This results in fewer, more compact policies. Interval estimation is important for computing accurate policies: without sufficient generalization many legitimate future flows would be dropped if the policy is enforced. By merging numerous ports into one or a few intervals, the rendering time of the UI is sped up significantly as well.

You can control the degree of port generalization including disabling it.

Policy Compression

When policy compression is enabled, if policies in multiple clusters in the workspace are similar, then those policies can be replaced with one or more policies applicable to the entire parent scope. For example, if all or almost all clusters in the workspace provide the same port to the same consumer, then all of those cluster-specific policies are replaced with one policy in the parent scope. This reduces the number of policies significantly, minimizes clutter, and may also allow legitimate future flows that would have been dropped (accurate generalization).

The more aggressive the compression setting, the smaller is the required threshold on policy frequency in order to replace cluster-specific policies with a policy applicable to the entire parent.

With the Deep policy generation option selected:

This knob can be used to alter the level of aggressiveness in [Hierarchical policy compression](#).



Note Currently, the automatic policy discovery conversations page does not support showing the conversations that led to a compressed policy (you may need to disable compression or use flow search).

Hierarchical policy compression

Policy compression can also be done for [Deep policy generation](#). The [Policy Compression](#) knob can be used to alter the level of aggressiveness in hierarchical policy compression. An example of hierarchical policy compression is illustrated below.

- Let A, B, C and D be scopes part of a scope tree, where "C" and "D" are the child scopes of "B". Let "C" → "A" be a TCP "ALLOW" policy on port 5520 and "D" → "A" be TCP "ALLOW" policy on port 5520.

Figure 13: Before hierarchical policy compression

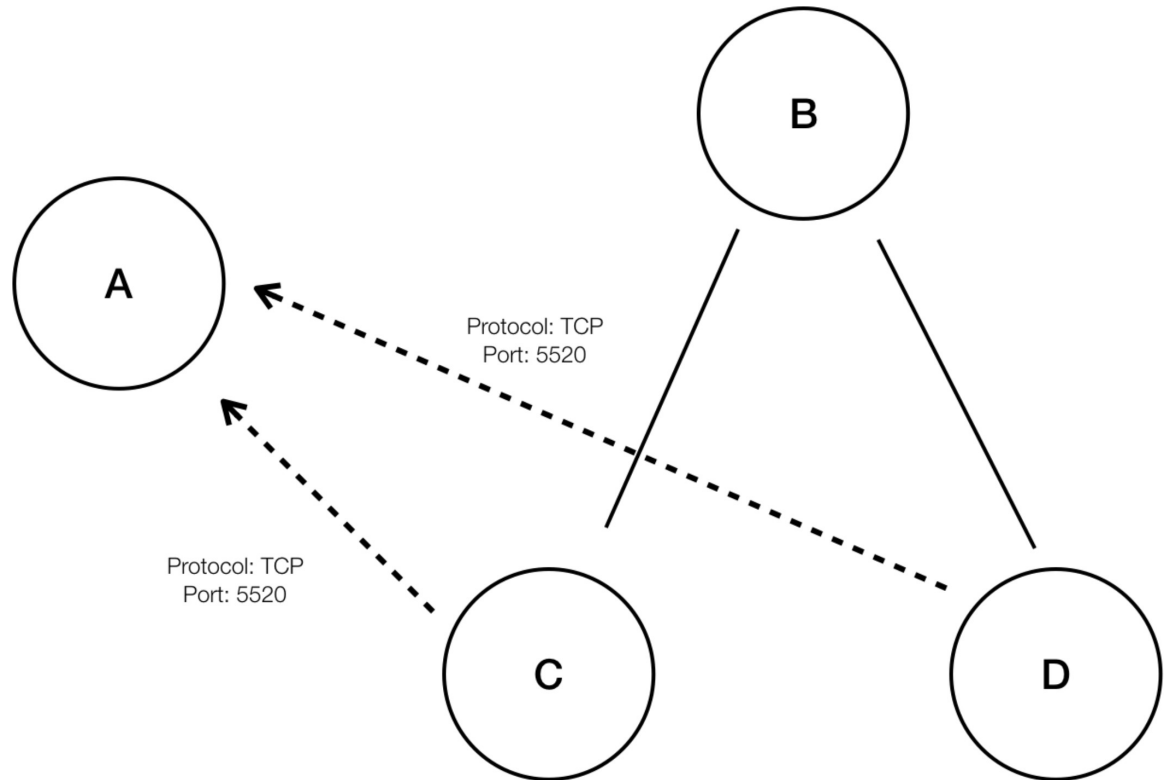

- With hierarchical policy compression if a sufficiently large group child scopes involves in policies sharing the same port, protocol and destination or source, these policies will be replaced by a generalized policy that connects the parent scope to the common source or destination. In the above mentioned case “C” and “D” are child scopes of “B” and the policies “C” → “A” and “D” → “A” share the same destination, port and protocol. Since 100% of child scopes of “B” contain the similar policy the policy will be promoted to be “B” → “A”, resulting in the following. Furthermore, hierarchical compression can be repeated so a generalized policy can go all the way to the root of the subtree (branch of the scope tree) on which deep policy generation is invoked.

Figure 14: After hierarchical policy compression

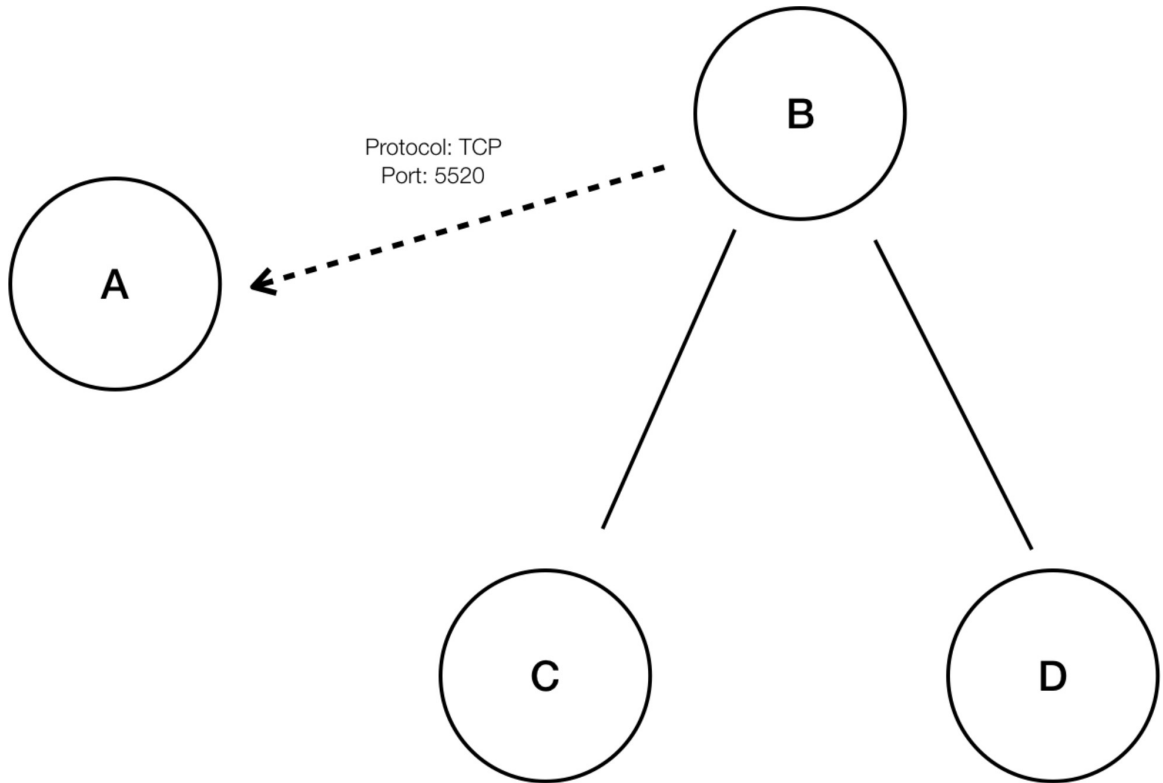

- The policy compression knob allows you to tune the aggressiveness of such compression, by changing the minimum required proportion of the policy-sharing child scopes (usually measured as the fraction of total number of child scopes) to trigger the compression. When disabled, each policy is generated between highest priority scopes based on the External Dependencies list. Subsequently, if you choose to impose the naturally ordered External Dependencies list, the policies generated will be the most granular policies among scopes.

Clustering Algorithm (Input to Clustering)

Advanced users can choose the main source of data for clustering algorithms, that is, live network flows, or running processes, or both.

Auto accept outgoing policy connectors

This option is applicable only when you use automatic policy discovery to create cross-scope policies using the method described in [\(Advanced\) Create Cross-Scope Policies, on page 88](#).

Any outgoing policy requests created during automatic policy discovery will be automatically accepted.

For complete information, see [Auto Accept Policy Connectors, on page 98](#) and [Policy Requests](#).



Note This option is only available for root scope owners and site admins.

Auto Approve Generated Policies

This option is applicable if you want to approve all policies generated by policy discovery.



Note Be aware that if you choose this option, and later on if you need to modify or undo any changes, you can only do so manually.

For more information, see [Auto Accept Policy Connectors, on page 98](#) and [Policy Requests](#).



Note This option is available for root scope owners and site administrators.

Ignore Flows Matching Exclusion Filters

To ignore conversation flows that you specify, enable the applicable option. To view or modify either filters list, click the applicable **Exclusion Filters** link. For more information, see [Exclusion Filters, Default Exclusion Filters, on page 44](#), and [Configure, Edit, or Delete Exclusion Filters, on page 28](#).

Enable service discovery on agent

In certain applications, a large range of ports might be designated for use, but actual traffic might use only a subset of those ports during the time period included in policy discovery. This option allows the entire designated pool of ports for these applications to be included in policies for those applications, rather than just the ports seen in actual traffic.

Enabling this option allows ephemeral port-range information regarding services present on the agent node to be gathered. Policies are then generated based on this port-range information.

Example:

- Windows Active Directory Domain Server uses default Windows ephemeral port-range **49152-65535** to serve requests. When this flag is set this port range information is reported by the agent and policies are generated based on this information.

Figure 15: Service discovery enabled on the agent

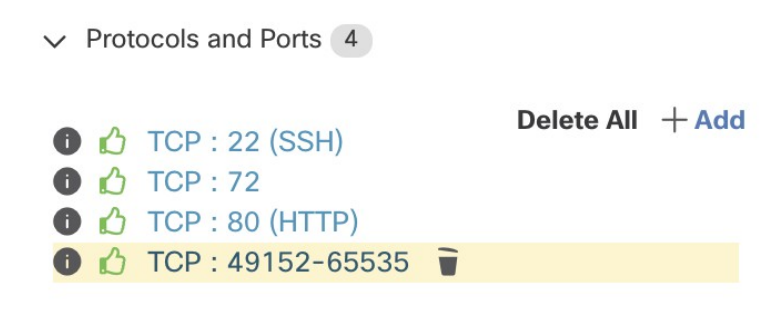
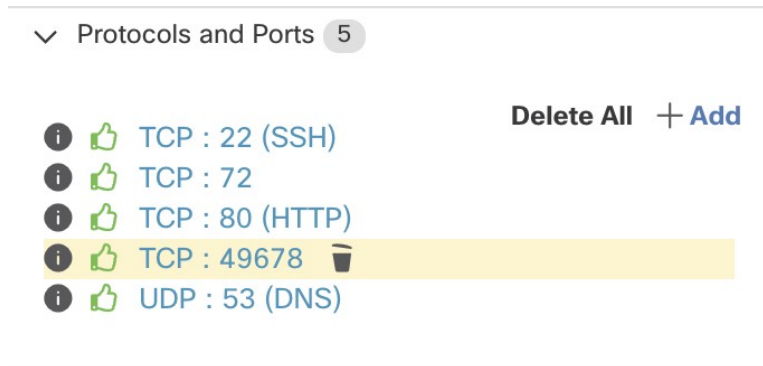

Figure 16: Service discovery not enabled on the agent



Carry over Approved Policies

This option is enabled by default.

When this flag is set, all the policies that you have marked as approved (including those approved using OpenAPI) will be preserved. This helps you to not have to re-define a particular broad DENY rule that should take effect regardless of the “allow” policies that are discovered by automatic policy discovery.

For details, see [Approved Policies, on page 46](#).

Skip clustering and only generate policies

If this option is selected, no new clusters are generated, and policies are generated from any existing approved clusters or inventory filters and otherwise involve the entire scope associated with the workspace (in effect, treating the entire scope as a single cluster). This option can result in substantially fewer (but coarser) policies.

Deep policy generation

By default, this option is NOT enabled, and policy discovery considers only conversations involving, and generates policies only for, workloads in the scope that are NOT also members of a subscope.

Enable the **Deep policy generation** option to generate policies for a branch of your scope tree, in a single scope at or near the top of the scope hierarchy. For a detailed comparison of the default (per-scope) and deep (per-branch) behavior, see [Discover Policies for One Scope or for a Branch of the Scope Tree, on page 22](#).

When deep policy generation is enabled:

- Conversations involving all workloads in the scope (not just those that are not also members of subscopes) are used for policy generation.

Therefore, policies are generated for all workloads that are members of the scope, whether or not they are also members of a subscope.

This allows you to generate policies for an entire branch of the scope tree. Note that this may result in a very large number of policies.

- All policies generated will reside in the workspace in which the deep policy discovery was run, even if the policy involves only workloads in sub-scopes.

All workloads that are conversation endpoints, whether or not they are members of the scope in which policy discovery is run, are assigned the highest matching scope label according to the top-down order given in the external dependencies list.

- Clusters are not created.

For limits when this option is enabled, see [Limits Related to Policies](#).



Note This option is only available for root scope owners and site admins.



Note Currently, the count of workloads shown for automatic policy discovery includes only those that are not also members of a subscope.

Enable redundant policy removal

This option is only available when [Deep policy generation](#) is enabled.

Figure 17: When Deep policy generation option is selected

The screenshot shows the 'Advanced Configurations' section of a web interface. It includes a 'Side Information' section with dropdown menus for 'SLB Config' and 'Route Labels'. Below this are three sliders: 'Cluster Granularity' (set to MEDIUM), 'Port Generalization' (set to VIEW AGGRESSIVE), and 'Policy Compression' (set to MODERATE). On the right side, there are several checkboxes, with 'Deep policy generation' and 'Enable redundant policy removal' both checked and highlighted with a red box. At the bottom right, there is a 'Discover Policies' button.

This option enables/disables removal of redundant granular policies.

Example:

- Let Root, A, B, C, A1 and A2 be scopes part of a scope tree. Let the following be the policies:

1. “Root” → “Root”
2. “B” → “Root”
3. “C” → “Root”
4. “A1” → “Root”

Figure 18: Before removal of redundant policies

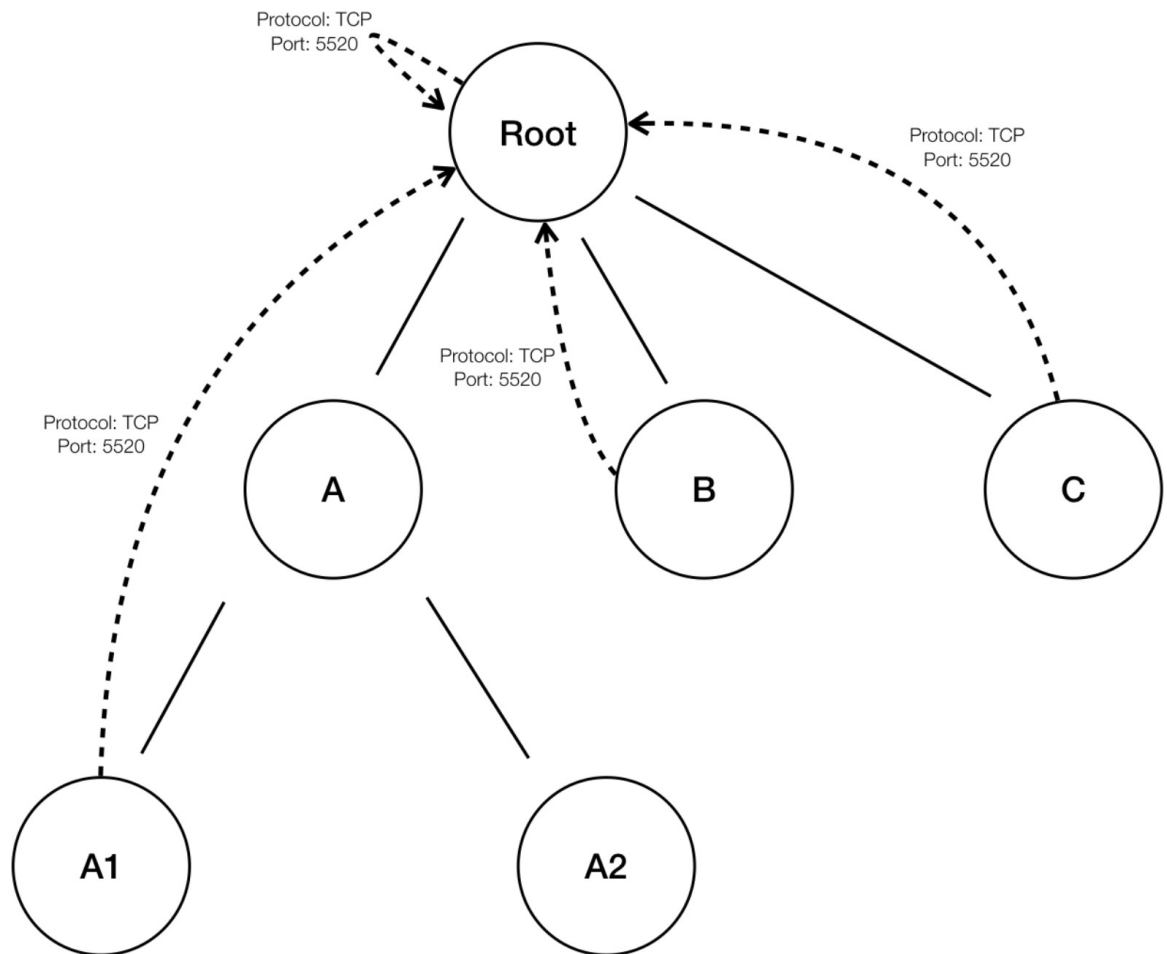

- The policies “B” → “Root”, “C” → “Root” and “A1” → “Root” are redundant as the policy “Root” → “Root” covers these policies. The remove redundant policies feature will check and remove such policies resulting in only one policy “Root” → “Root” as follows.

Figure 19: After removal of redundant policies

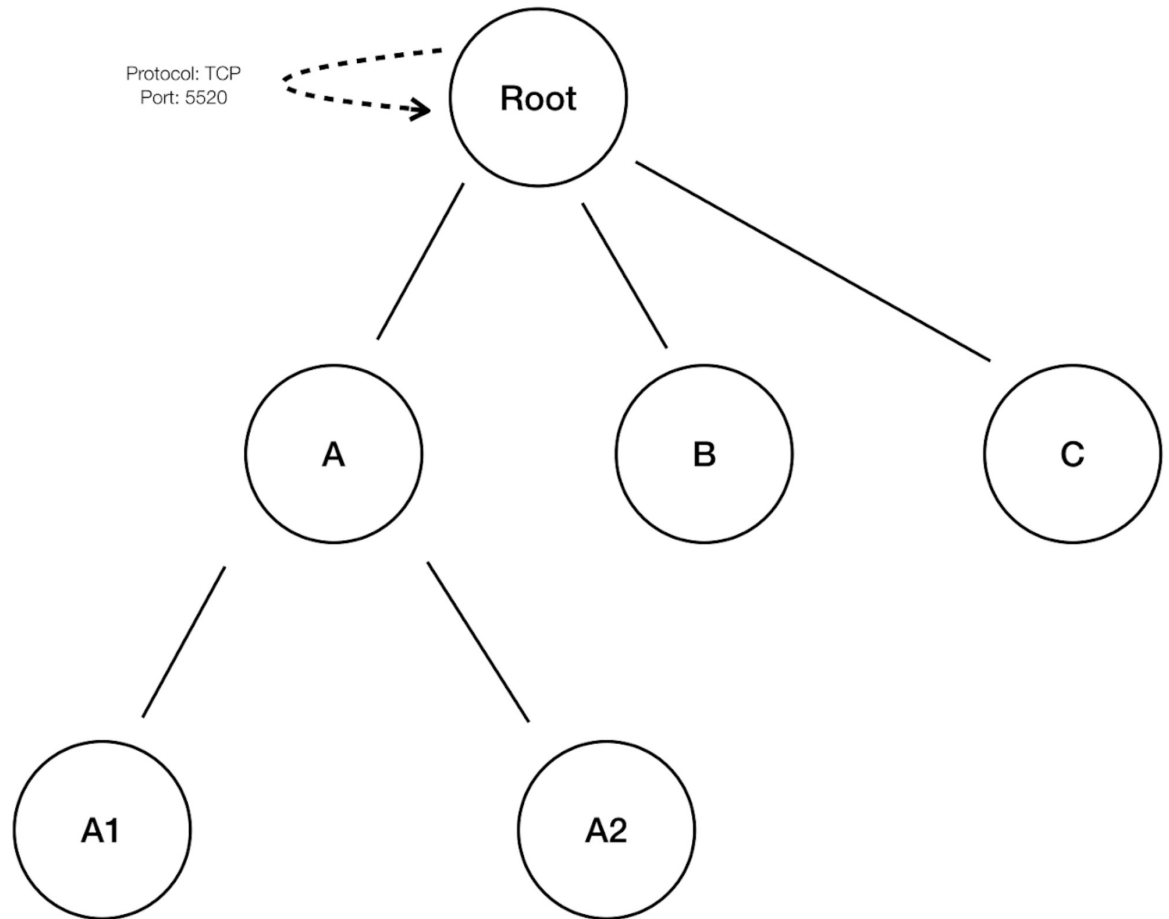

Redundant policy removal can be very useful in maintaining a succinct set of interpretable policies. The reduced policy set contains the minimal number of policies at the chosen compression level to cover all the workload traffic. However, you should always audit the policy through policy analysis and examine the corresponding conversations to evaluate the tightness of the resulting policies. This is especially important when there exists traffic to or from endpoints that are not categorized into finer scopes or inventory filters. Such endpoints may trigger the generation of coarser policies than intended, such as policies involving the root scope. If at the same time, redundant policy removal is enabled, more granular policies will be removed and will not be presented to you. To diagnose the source of (compressed) policies and to view finer level policies, turn off policy compression and redundant policy removal. Also note that currently, the automatic policy discovery conversations page may fail to show the conversations that lead to a compressed/generalized policy; so to get around this, you can turn off compression and redundant policy removal, so it is easier to find the conversations that lead to the generated policies.



Tip Since deep policy generation discovers all policies for the scope subtree rooted at the workspace scope, these policies will cover all the legal traffic seen by automatic policy discovery for all the workloads under the subtree. When analyzing these policies using tools such as Policy Analysis (See [Policies](#)), you should turn off Policy Analysis in all the workspaces associated with the subscopes. This way, the policies (if any) residing in the subscope workspaces (usually receive a high priority due to more specific scope definition) will not take priority and interfere with the results. However, exceptions apply when the policies in the subscope workspaces are configured to cover different sets of traffic that usually involve finer inventory filters or clusters specific to the subscopes.

Default Policy Discovery Config

You can configure default automatic policy discovery settings that can optionally be used in any workspace in the entire root scope.

To configure default options for policy discovery:

Choose **Defend > Segmentation**, then click the caret at the right side of the page to expand the Tools menu. Then choose **Default Policy Discovery Config**.

Figure 20: Navigating to the Default Policy Discovery Config page

Type	Version	Absolute Policies	Default Policies	Catch All
Enforced	N/A	N/A	N/A	N/A
Analyzed	N/A	N/A	N/A	N/A
Latest Draft	0	0	23	ALLOW

For information about options on the Default Policy Discovery Config page, see:

- [External Dependencies, on page 30](#) and subtopics
- [Advanced Configurations for Automatic Policy Discovery, on page 33](#) and subtopics
- [Default Exclusion Filters, on page 44](#)



Important When your default configurations are complete and ready to use in individual workspaces, click **Save**.

Default Exclusion Filters

Exclusion Filters help you fine-tune policies and clusters suggested by automatic policy discovery by specifying traffic flows to exclude from discovery input.

For details, see [Exclusion Filters](#).

You can make a global Default Exclusion Filters list that is available to all workspaces in your tenant, then specify for each workspace whether or not to use this default list when discovering policies.

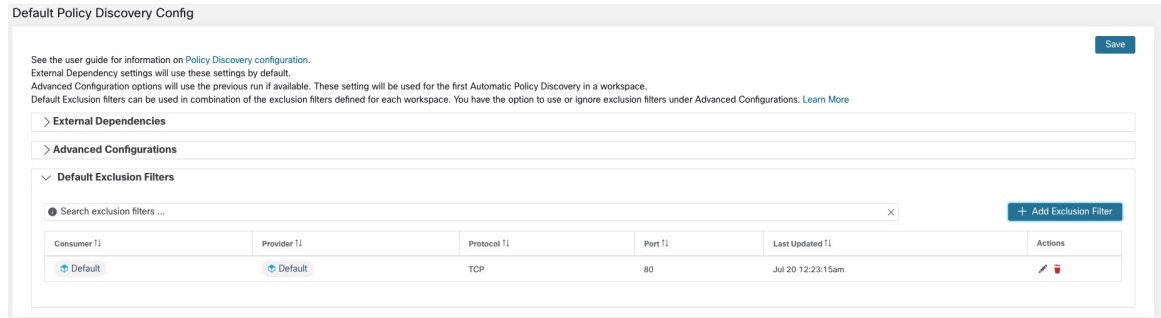
Figure 21: Default Exclusion Filters

To configure default exclusion filters, see [Configure, Edit, or Delete Exclusion Filters, on page 28](#).

To enable or disable default exclusion filters, see [Enable or Disable Exclusion Filters, on page 29](#).

Retrieving LoadBalancer Configurations for Advanced Policy Discovery Configuration

Below are the instructions for retrieving supported load balancer configuration files in a format that can be directly uploaded to Secure Workload for use in policy discovery. For more information, see [Advanced Configurations for Automatic Policy Discovery](#) and [Include Data From Load Balancers and Routers When Discovering Policies, on page 34](#).

Note that all files must be encoded as ASCII.

Citrix Netscaler

Concatenate the output of `show run` in your console and upload the file.

See [Sample config file](#)

F5 BIG-IP

Upload the `bigip.conf` file.



Note If you have a file with a `.UCS` extension, unzip the archive folder and upload only the `bigip.conf` file within the configuration dump. If there are multiple `bigip.conf` files, concatenate and then upload the files.

See [Sample config file](#)

HAProxy

Upload your `haproxy.cfg` file. The path is typically `/etc/haproxy/haproxy.cfg`.

See [Sample config file](#)

Normalized JSON

If you find the above options limiting, convert your configs to the following JSON schema and upload them directly. The example JSON file can be directly downloaded by clicking the **i** icon next to SLB Config in Advanced Run Configurations for automatic policy discovery.

See [Sample config file](#)

Approve Policies

As you review policy discovery results, approve discovered policies that you want to keep, to carry them forward intact when you discover policies in future. For complete details, see [Approved Policies, on page 46](#).

To approve a policy:

1. On the Policies page, for the policy you want to protect, click the value in the **Protocols and Ports** column.
2. In the panel that opens on the right, select the checkbox to the left of each protocol-and-port for which you want to retain the policy during future policy discovery.

Figure 22: Approve Policies

The screenshot shows the 'Approve Policies' interface. At the top, there are tabs for 'Matching Inventories 22', 'Policies 10', 'Filters 2', 'Conversations 16', 'Provided Services', 'Policy Analysis', 'Enforcement Status', and 'Enforcement'. Below the tabs is a search bar and a 'Filter Policies ...' dropdown. There are buttons for 'Run Quick Analysis' and '+ Add Policy'. A 'Catch All' button is set to 'DENY'. The main table has columns: Rank, Priority, Action, Consumer, Provider, Protocol, Port, Confidence, and Actions. The table lists several policies, all with 'ALLOW' actions and 'Very High' confidence. The right-hand panel shows 'Policy Actions' for a selected policy, including 'Priority 100', 'Action ALLOW', 'Consumer Default', and 'Provider Default'. A tooltip explains that approved policies will be carried over during the next automatic policy discovery only if there are matching consumer and provider filters. A legend at the bottom of the panel shows checkboxes for specific protocol and port combinations: TCP: 6443, UDP: 53 (DNS), UDP: 123 (NTP), and UDP: 137 (NETBIOS Name Service).

Rank	Priority	Action	Consumer	Provider	Protocol	Port	Confidence	Actions
Default	100	ALLOW	Default	Default	ICMP	N/A	High	
Default	100	ALLOW	Default	Default	TCP	24333	Very High	
Default	100	ALLOW	Default	Default	UDP	53 (DNS)	Very High	
Default	100	ALLOW	Default	Default	TCP	80 (HTTP)	Very High	
Default	100	ALLOW	Default	Default	UDP	123 (NTP)	High	
Default	100	ALLOW	Default	Default	UDP	137 (NETBIOS Name Service)	Moderate	
Default	100	ALLOW	Default	Default	TCP	443 (HTTPS)	Very High	
Default	100	ALLOW	Default	Default	TCP	5660 (Secure Workload Enforcement)	Very High	
Default	100	ALLOW	Default	Default	TCP	6443	Very High	

You can also use this procedure to remove approval from a policy.

Approved Policies

In general, approved policies are not changed during automatic policy discovery, and automatic policy discovery does not suggest policies that would duplicate or overlap the effects of approved policies.

The following are approved policies:

- Manually created policies.
- Discovered policies that are manually approved.

(When you are satisfied that a policy behaves as intended, you approve it to protect it from changes during future automatic policy discovery. See [Approve Policies, on page 46](#).)
- Uploaded policies, unless explicitly marked as `approved: false`.
- Approved policies defined in parent and ancestor scopes (specifically, from the latest versions of their primary workspaces) that apply to workloads in this scope.
- Policies created when policy requests are accepted from another workspace when cross-scope policies are handled using the advanced method described in [When Consumer and Provider Are In Different Scopes: Policy Options, on page 87](#). For example, this includes policies included from the [Provided Services, on page 100](#) tab.

Approved policies are shown with a thumbs-up icon next to the protocol type when you click a policy's ports/protocols link and view details in the panel at the right side of the page.

Exceptions to Approved Policy Protections

Approved policies are preserved during future automatic policy discovery if *both* ends of the policy are any of: approved cluster; inventory filter; accepted policy request (for cross-scope policies); or a cluster that doesn't significantly change membership. (However, the cluster membership may have changed in the last case.)

Approved policies may not be protected during future automatic policy discovery runs if either end of the policy is a non-approved cluster, and if, upon automatic policy discovery, no newly generated cluster has sufficiently high overlap with such cluster.

To protect a policy that involves an unapproved cluster, you should explicitly approve the cluster(s) at each end of the policy.

There is also an advanced configuration for automatic policy discovery that is enabled by default. If you do not want to protect approved policies from changes, you can deselect this option for a workspace or for the global default policy discovery configuration. See [Carry over Approved Policies, on page 40](#).

Troubleshoot Approved Policies

Approved policies are not being carried forward

If approved policies are not being carried forward as expected, make sure the **Carry over approved policies** option is selected in the advanced and/or default configuration settings for automatic policy discovery.

Finding conversations that are excluded from policy generation

During automatic policy discovery, any conversations that match the criteria for an existing approved policy are excluded from the policy generation. This omission prevents redundant policies covering the same conversations from being generated. (This process differs from the exclusion filters (See [Exclusion Filters](#)), in which you define matching filters instead of policies. Exclusion filters prevent matching conversations from being visible to all parts of automatic policy discovery.)

Note that while redundant policies are not generated from these conversations, the conversations are still considered when automatic policy discovery analyzes and generates clusters.

To see which conversations are excluded from automatic policy discovery by existing approved policies:

In the conversations view (See [Conversations](#)), use the **excluded** flag to filter conversations. You can also explore which existing approved policies result in the exclusion of these conversations in the policy details view that opens on the right side of the page when you click the ports and protocols link in a policy, then click the exclusion icon next to the conversation. (Hover over the icons to find the right icon.)

Iteratively Revise Policies

Defining and refining policies, for a single scope and for an entire network, will be an iterative process.

You can expect to revise both discovered and manually created policies.

Re-running Automatic Policy Discovery

You can rerun automatic policy discovery at any time. The main reasons to rerun automatic policy discovery are to include additional information that was not included in the previous run, or to exclude information that is not helpful. For example, you can:

- Install additional agents or configure additional connectors, and allow some flow data to accumulate.

- Increase the timespan used for discovery, to include more data.
- Approve clusters (with or without editing them first), which can improve the clustering of other workloads upon rerun. See [Approving Clusters, on page 79](#).
- Exclude flows that you know you don't want to influence policy so you don't have to edit them out. See [Exclusion Filters, on page 27](#).
- Change advanced settings (for details, see [Advanced Configurations for Automatic Policy Discovery, on page 33](#).)
- Capture changes after you have made changes to [Address Policy Complexities, on page 81](#).

Automatically discovering policies again on an existing workspace may generate different clusters and policies in the workspace.

If a host is no longer in the scope of the workspace, upon a subsequent automatic policy discovery run, that host will not appear in any cluster; if it were in an approved cluster, it will no longer appear in that cluster. Even with the same set of member workloads but with a different timeframe or configuration, automatic policy discovery may result in different clusters.



Note For a list of the types of policies that are not modified during policy discovery, see [Approved Policies, on page 46](#).



Note *Removal of Redundant Policies* On subsequent automatic policy discovery, approved policies in primary workspaces will remove matching conversations for policy generation, so redundant policies are not generated. Note that, as is the case for exclusion filters, this functionality may not work perfectly on non-primary workspaces if the policy uses a Cluster filter defined in the workspace. Cluster filters from a non-primary workspaces are not active, and will not match any flows, thus redundant policies may still be generated in non-primary workspaces during automatic policy discovery.

Application views ([Application Views](#)) may also be affected by policy discovery reruns. If contents of a cluster change as a result of a rerun, a best effort is made to match the new clusters with the old ones. For example, if one or two members of a cluster with 10 workloads have changed, we consider it the same cluster and application view will remain unchanged. In this scenario the application view will refer to the new cluster and newly generated policies, not the old one as a reference for nodes and edges respectively. However, if the contents of a cluster is significantly changed, for example, a cluster of 10 workloads is split into two clusters of size 5, we consider the old cluster deleted and two new clusters added. In this case, the application view may not show the right graph, and needs to be edited by the user to reflect the correct set of dependencies.

Important: Before You Re-run Automatic Policy Discovery



Important

Address each of the following before re-discovering policies in a workspace:

- By default, each time you discover policies in a particular workspace, the previous set of discovered policies and clusters are overwritten based on the data included in the new discovery period. If you want to keep some policies and clusters but not others, approve those policies and clusters.
- If you want to preserve any existing generated clusters, see [Preventing Cluster Modification During Automatic Policy Discovery Reruns](#) or [Approving Clusters, on page 79](#).
- If you want to preserve any existing generated policies, see [Approve Policies, on page 46](#).
- Any existing **Advanced Configuration** settings configured in the previous discovery run are used unless you change them.

However, any configured *default* External Dependencies will be used over those of the previous run.

- If the currently displayed version of the discovered policies is not the latest version, and you want to keep previously discovered versions, click the version displayed at the top of the page and choose the latest v* version.

If a previous version is displayed, any versions between that version and the new discovered version will be deleted.

For details, see [View, Compare, and Manage Discovered Policy Versions, on page 49](#).

To re-run policy discovery, see [Automatically Discover Policies, on page 25](#). After you have addressed the points in this topic, the process is the same each time you discover policies.

View, Compare, and Manage Discovered Policy Versions

Each time you discover policies in a workspace, the version number (v*) assigned to the set of policies increments.

For information, see [About Policy Versions \(v* and p*\), on page 145](#).

Step 1 Click **Defend > Segmentation**.

Step 2 Navigate to the workspace.

Step 3 Click **Manage Policies**.

Step 4 The currently displayed version of the policies generated by automatic policy discovery is shown at the top of the page:

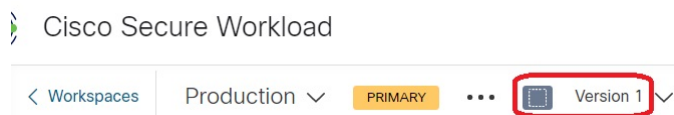

If you have already analyzed or enforced policies, the displayed version may be a policy discovery version, an analyzed policy version, or an enforced version.

Step 5 Do one of the following:

Display a different version of the policies generated by automatic policy discovery:

Click the current version and choose a different v* version.

(If you see p* versions, those are analyzed and/or enforced versions, not versions of discovered policies.)

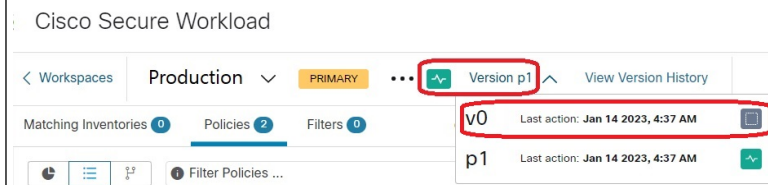

Important!! See the caveat in the What To Do Next section at the end of this procedure.

View details about a version

- a. Click **View Version History** at the top of the page beside the current version.
- b. Click the **Versions** tab to see the versions of discovered policies. (Not the Published Versions tab.)

The list of versions displays:

Figure 23: List of generated policy versions with summary information

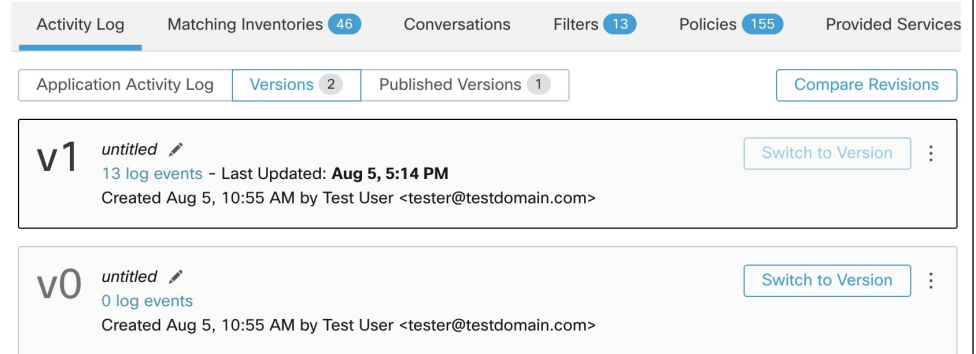



- c. Click the **log events** link in the version.
- d. Click a link in an event row.

Available details include statistics, exclusion filters, external dependencies, and configurations for the run.

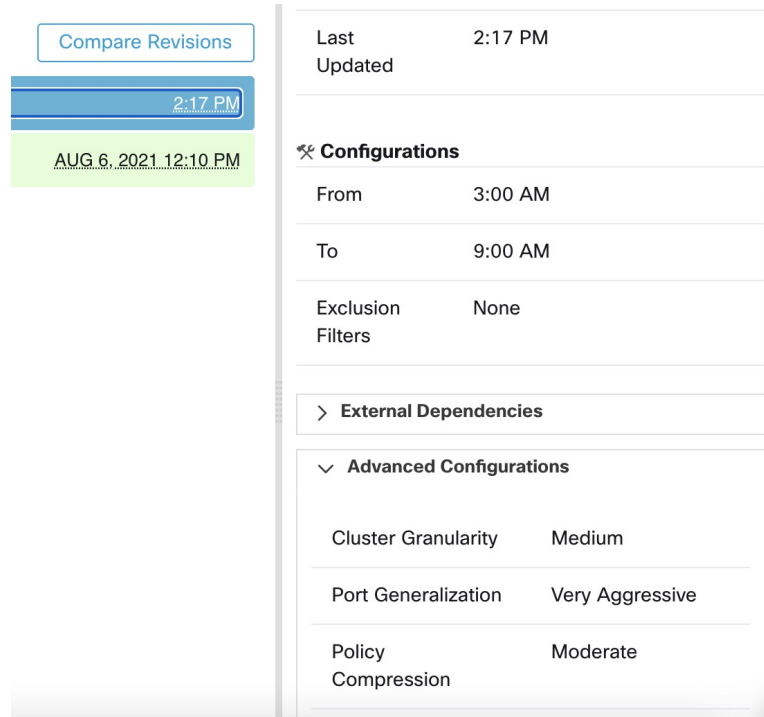
Figure 24: Configurations used for particular automatic policy discovery runs



Compare two versions to see what has changed:	<p>a. Click Compare Revisions.</p> <p>b. Choose the versions to compare.</p> <p>c. For result details, see Comparison of Policy Versions: Policy Diff, on page 147.</p>
Delete an unwanted version:	<p>Click  for the version and choose Delete.</p> <p>You cannot delete the last remaining version generated by automatic policy discovery (v* version).</p>
Export a version:	<p>Click  for the version and choose Export...</p>

What to do next



Important

If you want to preserve previous versions of the discovered policies, always display the current version of the discovered policies when you are done working with older versions.

If the most current version of the discovered policies is not displayed the next time you discover policies for this workspace, older versions may be deleted.

For example, if the most current version of discovered policies is v4, and v2 is displayed when you discover policies again, then the existing v3 and v4 will be deleted and the new discovered policy version will be v3.

This behavior ensures a linear version history, which simplifies reverting to a previous version if desired.

In addition, you can manually create policies only if the latest v* version is displayed.

Import/Export

Export a Workspace

All the relevant contents of clusters and policies in each workspace can be downloaded as a single file in a number of popular structured document formats like JSON, XML and YAML. One can use such files for further in-house processing or ingestion by other policy enforcement or analysis tools.

Navigate to the **...** menu item on the workspace header and click on the **export** item. This will show the export dialog. You can choose whether the exported file should include only the cluster contents or cluster contents as well as the security policies among the clusters generated by automatic policy discovery based on real network flows. Choose the desired format and click download to download the file into the local file system.

Figure 25: Import/Export menu items

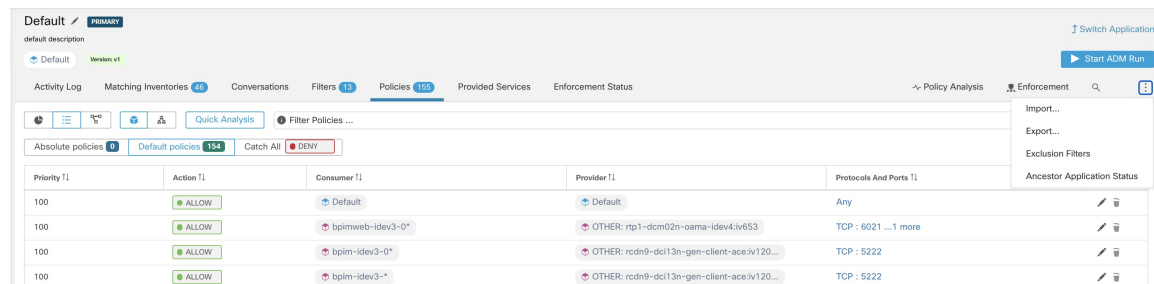
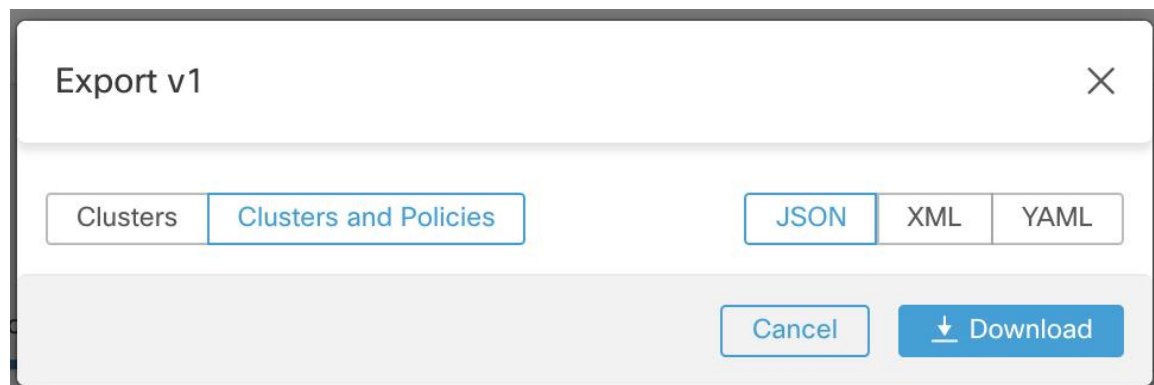

Figure 26: Exporting Policies of a workspace



When you export a workspace, the "Auto accept outgoing policy connectors" setting in the automatic policy discovery configuration is included and will be active in the imported workspace.

Export App View

If a scope is very large with thousands of workloads and hundreds of clusters, it might be desirable to export only the contents of a particular workspace view. Additionally, it may be desirable to export policies at a coarser granularity than generated by automatic policy discovery. You can use many features of the app view to construct a more limited and/or coarser view of policies by collapsing certain scopes. The exported file will have policy definitions that is close to the graph shown on the app view canvas.

To achieve this, navigate to the application view and click on the button on the left toolbar. This will reveal a dropdown menu including an export option. First, make sure the app view is saved by clicking on the **Save** menu item. Clicking the **Export** item shows a similar dialog as the one above.

Figure 27: Exporting a specific App View

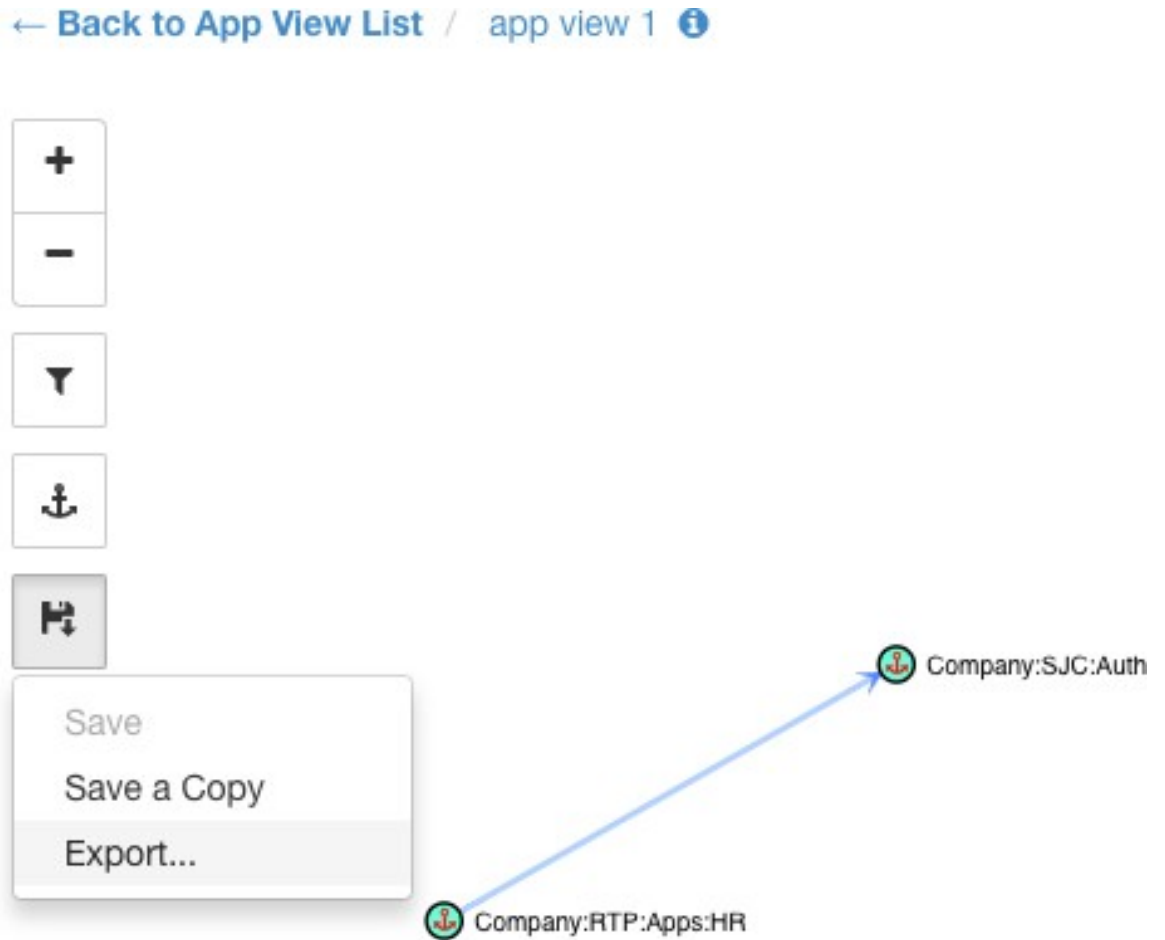
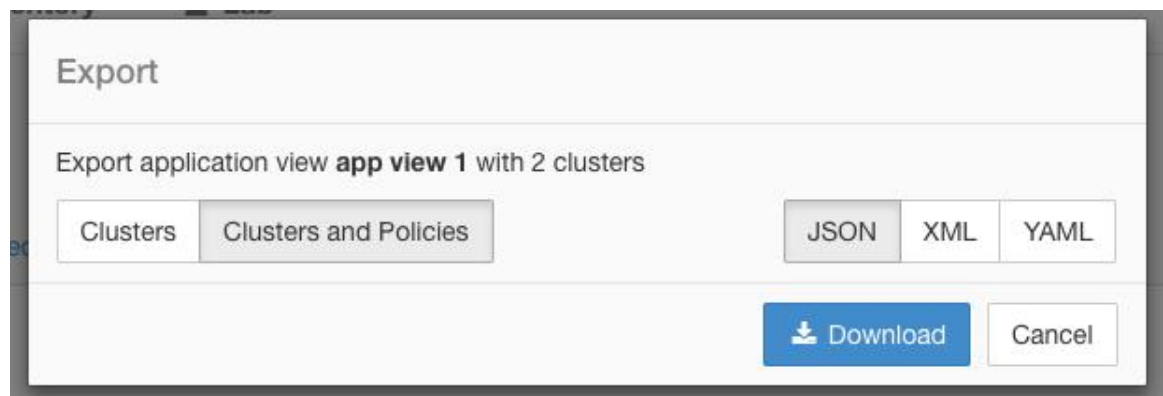

Figure 28: Exporting Policies of an App View



Note The app view does not show DENY policies and self-loops, i.e., policies with the same consumer and provider.

However, the exported file will include all the information related to DENY policies, self-loops and Catch-all action as well.

Import

You can import known cluster and policy definitions into a workspace by directly uploading a JSON file. Similar to automatic policy discovery, uploading policies into an existing workspace creates a new version and places the cluster and policy definitions under the new version. Missing filters and incorrect property values will return an error.

Click on the **Import** menu item from the **...** menu in the workspace header. In the import dialog, you can select a JSON file with a valid format. A small sample JSON file demonstrating the schema for policies and clusters can be found by clicking on the **Sample** button.

Figure 29: Importing Clusters/Policies

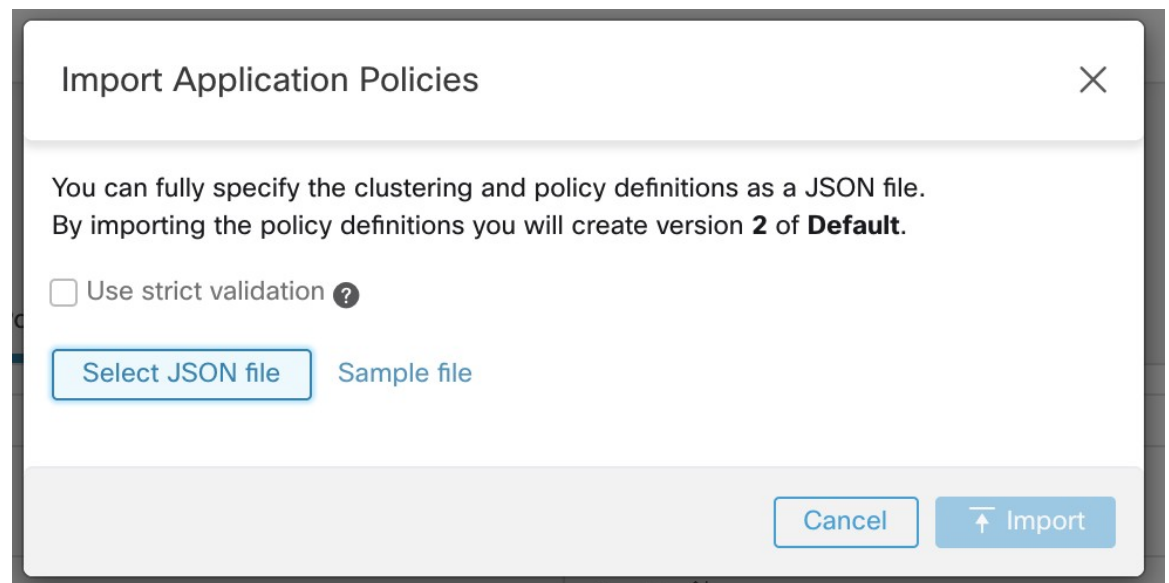

Strict Validation if enabled, will return an error if the JSON contains unrecognized attributes. This is useful for locating typos or incorrectly identified optional fields.



Note All imported policies are marked as approved by default unless explicitly marked as `approved: false`. You have the option to maintain such approved policies during automatic policy discovery to generate a new set of policies. See [Approved Policies, on page 46](#) for more info.

Pro Tip: The schema of the JSON file retrieved by exporting an application workspace or app view is schema-compatible with the expected format for importing policies into a workspace. Therefore, you can clone policies from one application workspace to another using an export followed by an import. Note that many features may not work the same when exporting and then importing policies. For example, the conversations backing the policies are not included in the export and will not be present when importing the policies either.

Platform-Specific Policies

For important details about how agents enforce policy on each platform, see [Policy Enforcement with Agents](#).
For Kubernetes/OpenShift, see [Enforcement on Containers](#), on page 137.

Windows

Recommended Windows OS-Based Policy Configuration

Always specify ports and protocols in policies when possible; we recommend not to allow ANY port, ANY protocol.

For example, a generated policy with port and protocol restrictions might look like this:

```
dst_ports {
  start_port: 22
  end_port: 22
  consumer_filters {
    application_name: "c:\\test\\putty.exe"
  }
}
ip_protocol: TCP
```

In contrast, if you allow network connections that are initiated by iperf.exe with ANY protocol and ANY port, the generated policy looks like this:

```
match_set {
  dst_ports {
    end_port: 65535
    consumer_filters {
      application_name: "c:\\test\\iperf.exe"
    }
  }
  address_family: IPv4
  inspection_point: EGRESS
  match_comment: "PolicyId=61008290755f027a92291b9d:61005f90497d4f47cedacb86:"
}
```

For the above filter, Secure Workload creates a policy rule to allow the network traffic on the provider as follows:

```
match_set {
  dst_ports {
    end_port: 65535
  }
  address_family: IPv4
  inspection_point: INGRESS
  match_comment: "PolicyId=61008290755f027a92291b9d:61005f90497d4f47cedacb86:"
}
```

This network rule opens all the ports on the Provider. We strongly recommend not to create OS-based filters with *Any* protocol.

Configure Policies for Windows Attributes

For more granularity when enforcing a policy on Windows-based workloads, you can filter network traffic by:

- Application Name
- Service Name
- User Names with or without User Groups

This option is supported in both WAF and WFP modes. Windows OS-based filters are categorized as *consumer filters* and *provider filters* in the generated network policy. The Consumer filters filter the network traffic that is initiated on the consumer workload and Provider filters filter the network traffic that is destined for the provider workload.

Before you begin

This procedure assumes you are modifying an existing policy. If you have not yet created the policy to which you want to add a Windows OS-based filter, create that policy first.



Important See [Caveats](#) and [Known limitations](#) for policies involving Windows attributes.

-
- Step 1** In the navigation pane, click **Defend > Segmentation**.
- Step 2** Click the scope that contains the policy for which you want to configure Windows OS-based filters.
- Step 3** Click the workspace in which you want to edit the policy.
- Step 4** Click **Manage Policies**.
- Step 5** Choose the policy to edit.
- Important** Consumer and Provider must include only Windows workloads.
- Step 6** In the table row for the policy to edit, click the existing value in the **Protocols and Ports** column.
- Step 7** In the pane on the right, click the existing value under **Protocols and Ports**.
In the example, click **TCP : 22 (SSH)**.

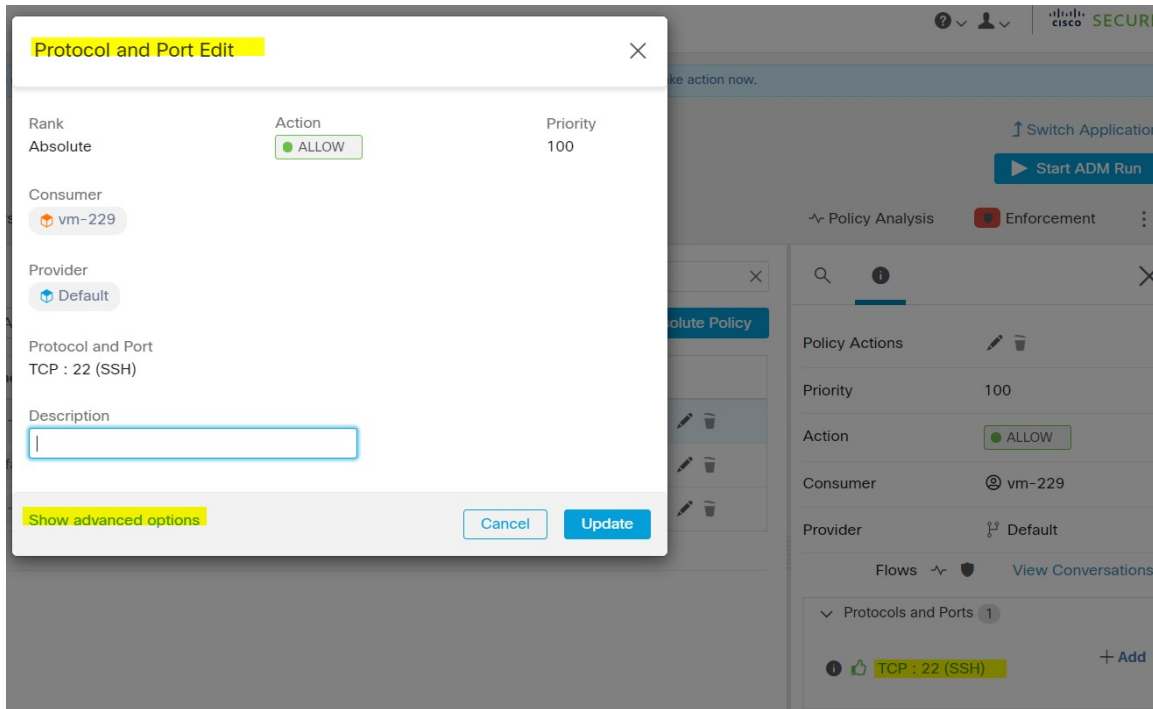

Step 8 Click **Show advanced options**.

While using process level controls a consumer/provider scope or filter should only contain Windows agents. Otherwise, non-Windows OSs (Linux, AIX) will skip the policy and report a sync error in Enforcement Status. See the user guide for more information.

Consumer Service

Consumer Binary Path

Consumer Users or User Groups ⓘ

Provider Service

Provider Binary Path

Provider Users or User Groups ⓘ

Hide advanced options

Step 9 Configure consumer filters based on Application name, Service name, or User name.

- The application name must be a full pathname.
- Service name must be a short service name.

- User name can be a local user name (For example, `tetter`) or domain user name (For example, `sensor-dev@sensor-dev.com` or `sensor-dev\sensor-dev`)
- User group can be local user group (For example, `Administrators`) or domain user group (For example, `domain users\sensor-dev`)
- Multiple user names and/ or user group names can be specified, separated by ",".(For example, `sensor-dev\@sensor-dev.com,domain users\sensor-dev`)
- Service name and User name cannot be configured together.

Step 10 Configure provider filters based on Application name, Service name, or User name.

Follow the same guidelines as given for consumer filters in the previous step.

Step 11 Enter the paths to the binary, as applicable.

For example, enter `c:\test\putty.exe`

Step 12 Click **Update**.

Known limitations

- Windows 2008 R2 does not support Windows OS based filtering policies.
- Network policy can be configured with a single user name whereas MS Firewall UI supports multiple users.

Caveats

- While using the Windows OS-based policies, a consumer/ provider scope or filter should only contain Windows agents. Otherwise, non-Windows OSs (Linux, AIX) skip the policy and report a sync error in Enforcement Status.
- Avoid creating Windows OS filters with *loose* filtering criteria. Such criteria may open unwanted network ports.
- Due to limited or no knowledge of the process context, user context or service context of the network flows, there will be discrepancy in the policy analysis if the policies have Windows OS-based filters.

Verify and Troubleshoot Policies with Windows OS-Based Filtering Attributes

If you use Windows OS-based filtering attributes, the following topics provide you with verification and troubleshooting information.

Cisco TAC can use this information as needed to troubleshoot such policies.

Policies Based on Application Name

Use the following information to verify and troubleshoot policies based on application name on Windows OS workloads.

The following sections describe the way policies should appear on the workload for an application binary entered as `c:\test\putty.exe`.

Sample Policy Based on Application Name

```
dst_ports {
  start_port: 22
  end_port: 22
  consumer_filters {
    application_name: "c:\test\putty.exe"
  }
}
ip_protocol: TCP
address_family: IPv4
inspection_point: EGRESS
```

Generated Firewall Rule

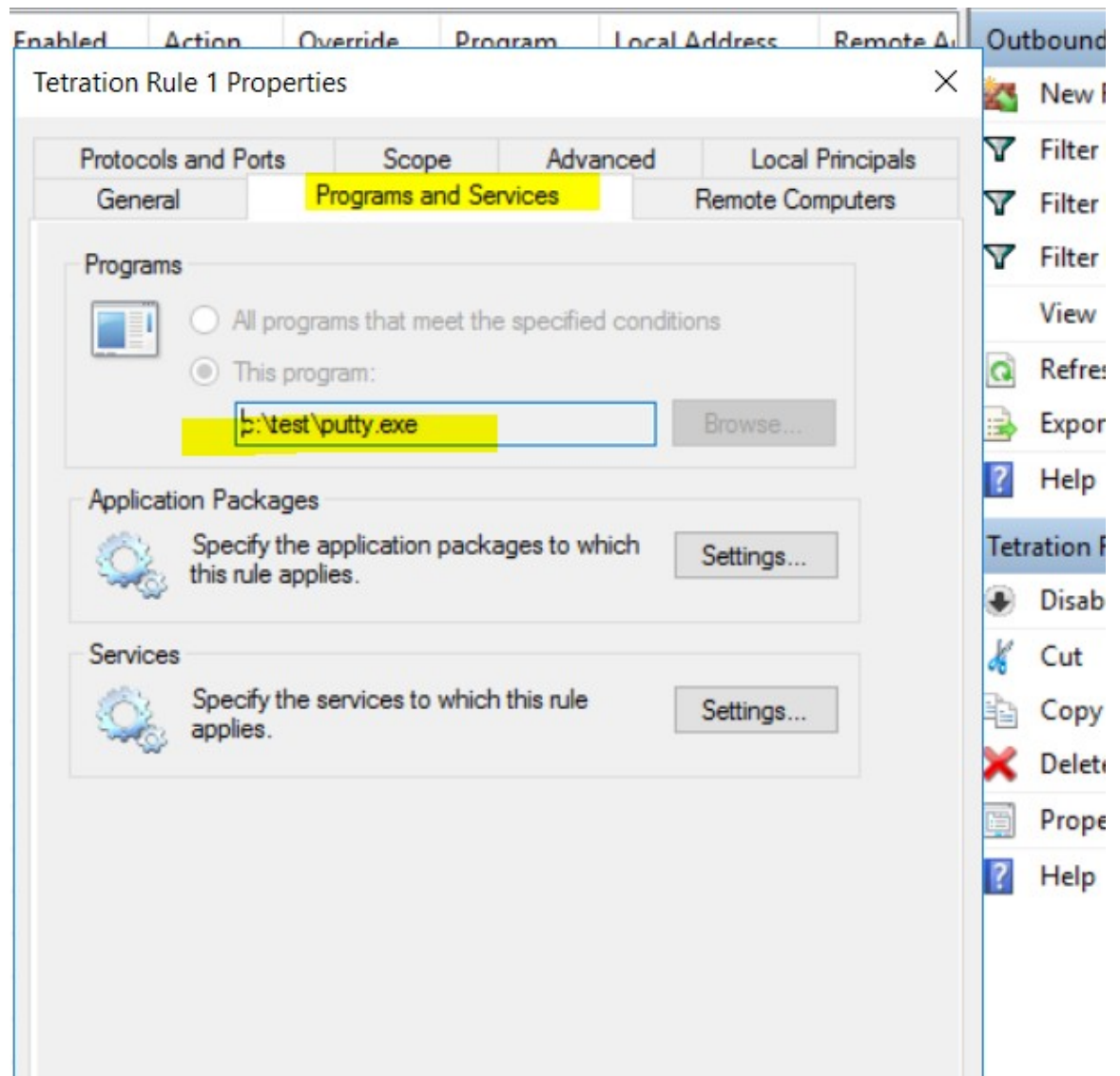

Generated Filter Using netsh

To verify, using native Windows tools, that a filter has been added to an advanced policy:

- With administrative privileges, run `cmd.exe`.
- Run `netsh wfp show filters`.
- The output file, **filters.xml**, is generated in the current directory.
- Check `FWPM_CONDITION_ALE_APP_ID` for the application name in the output file: `filters.xml`.

```
<fieldKey>FWPM_CONDITION_ALE_APP_ID</fieldKey>
  <matchType>FWP_MATCH_EQUAL</matchType>
  <conditionValue>
    <type>FWP_BYTE_BLOB_TYPE</type>
    <byteBlob>
      <data>
        .→5c006400650076006900630065005c0068006100720064006400690073006b0076006f006
        .→</data>
        <asString>\device\harddiskvolume2\temp\putty.exe</
      .→asString>
    </byteBlob>
  </conditionValue>
```

Generated WFP Filter Using `tetenf.exe -l -f`

```
Filter Name:          Secure Workload Rule 1
-----
EffectiveWeight:     18446744073709551592
LayerKey:            FWPM_LAYER_ALE_AUTH_CONNECT_V4
Action:              Permit
RemoteIP:            10.195.210.15-10.195.210.15
Remote Port:         22
Protocol:            6
AppID:               \device\harddiskvolume2\test\putty.exe
```

Invalid Application Name

- In WAF mode, Firewall rule is created for an invalid application name.
- In WFP mode, the WFP filter is not created for an invalid application name but the NPC is not rejected. The agent logs a warning message and configures the rest of the policy rules.

Policies Based on Service Name

Use the following information to verify and troubleshoot policies based on Service name on Windows OS workloads.

The following sections describe the way that the policies should appear on the workload.

Sample Policy Based on Service Name

```
dst_ports {
  start_port: 22
  end_port: 22
  provider_filters {
    service_name: "sshd"
  }
}
ip_protocol: TCP
address_family: IPv4
inspection_point: INGRESS
```

Generated Firewall Rule

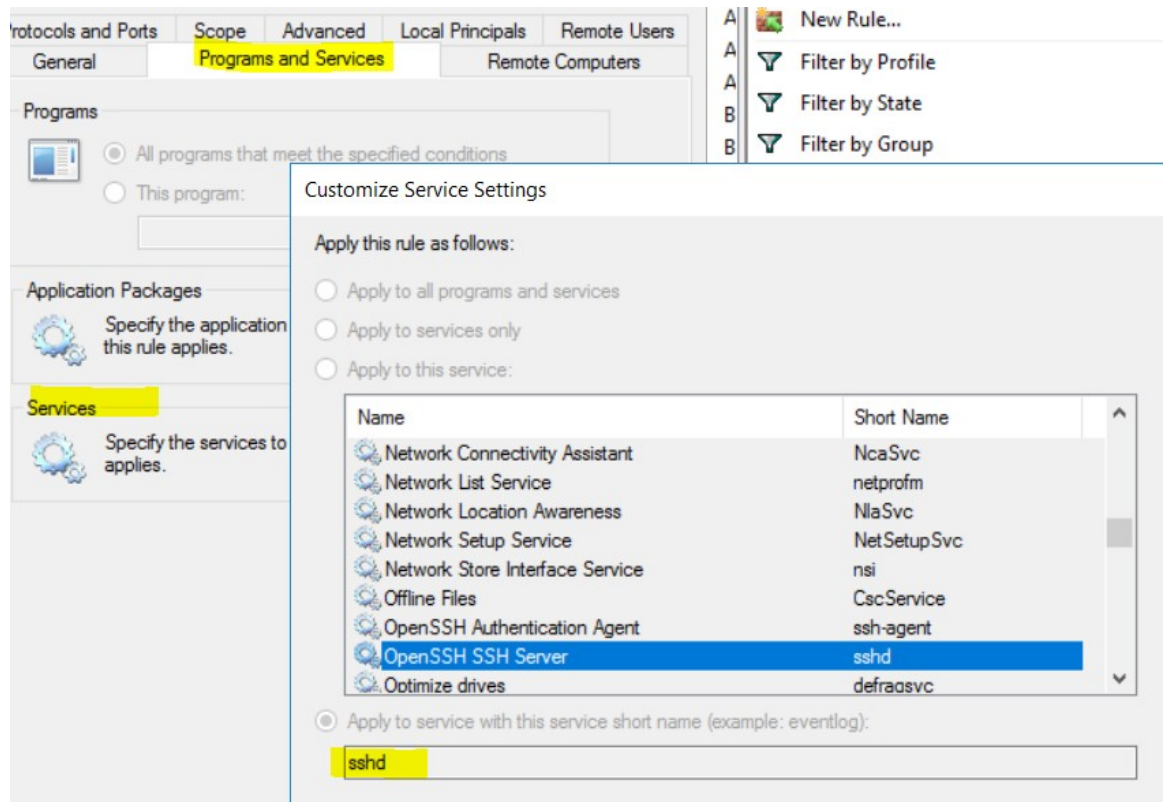

Generated Filter Using netsh

To verify using native Windows tools, that a filter has been added for an advanced policy:

- With administrative privileges, run `cmd.exe`.
- Run `netsh wfp show filters`.
- The output file, **filters.xml**, is generated in the current directory.
- Check `FWPM_CONDITION_ALE_USER_ID` for user name in the output file: `filters.xml`.

```
<item>
    <fieldKey>FWPM_CONDITION_ALE_USER_ID</fieldKey>
    <matchType>FWP_MATCH_EQUAL</matchType>
    <conditionValue>
        <type>FWP_SECURITY_DESCRIPTOR_TYPE</type>
        <sd>0:SYG:SYD: (A;;CCRC;;;S-1-5-80-3847866527-469524349-687026318-
        →516638107)</sd>
    </conditionValue>
</item>
```

Generated WFP Filter Using `tetentf.exe -l -f`

```
Filter Name:          Secure Workload Rule 3
-----
EffectiveWeight:     18446744073709551590
```

```
LayerKey:                FWPM_LAYER_ALE_AUTH_RECV_ACCEPT_V4
Action:                  Permit
Local Port:              22
Protocol:                 6
User or Service:         NT SERVICE\sshd
```

Invalid Service Name

- In WAF mode, the Firewall rule is created for a nonexistent service name.
- In WFP mode, the WFP filter is not created for a nonexistent service name.
- Service SID type must be *Unrestricted* or *Restricted*. If the service type is *None*, the Firewall Rule and WFP filter can be added but they have no effect.

To verify the SID type, run the following command:

```
sc qsidtype <service name>
```

Policies Based on User Group or User Name

Use the following information to verify and troubleshoot policies based on user name (with and without user group name) on Windows OS workloads.

Sections in this topic describe the way that the policies should appear on the workload.

Examples in this topic are based on policies that are configured with the following information:

Description

While using process level controls a consumer/provider scope or filter should only contain Windows agents. Otherwise, non-Windows OSs (Linux, AIX) will skip the policy and report a sync error in Enforcement Status. See the [user guide](#) for more information.

Consumer Service

Consumer Binary Path

Consumer Users or User Groups ⓘ

Provider Service

Provider Binary Path

Provider Users or User Groups ⓘ

Sample Policy Based on User Name

```
dst_ports {
  start_port: 30000
  end_port: 30000
  provider_filters {
    user_name: "sensor-dev\sensor-dev"
  }
}
ip_protocol: TCP
address_family: IPv4
inspection_point: EGRESS
```

Sample Policy Based on User Group and User Name

```
dst_ports {
  start_port: 30000
  end_port: 30000
  provider_filters {
    user_name: "sensor-dev\domain users,sensor-dev\sensor-dev"
  }
}
ip_protocol: TCP
address_family: IPv4
inspection_point: EGRESS
```

Generated Firewall Rule

Firewall Rule Based on User Name

Example: Firewall rule based on User Name, sensor-dev\\sensor-dev

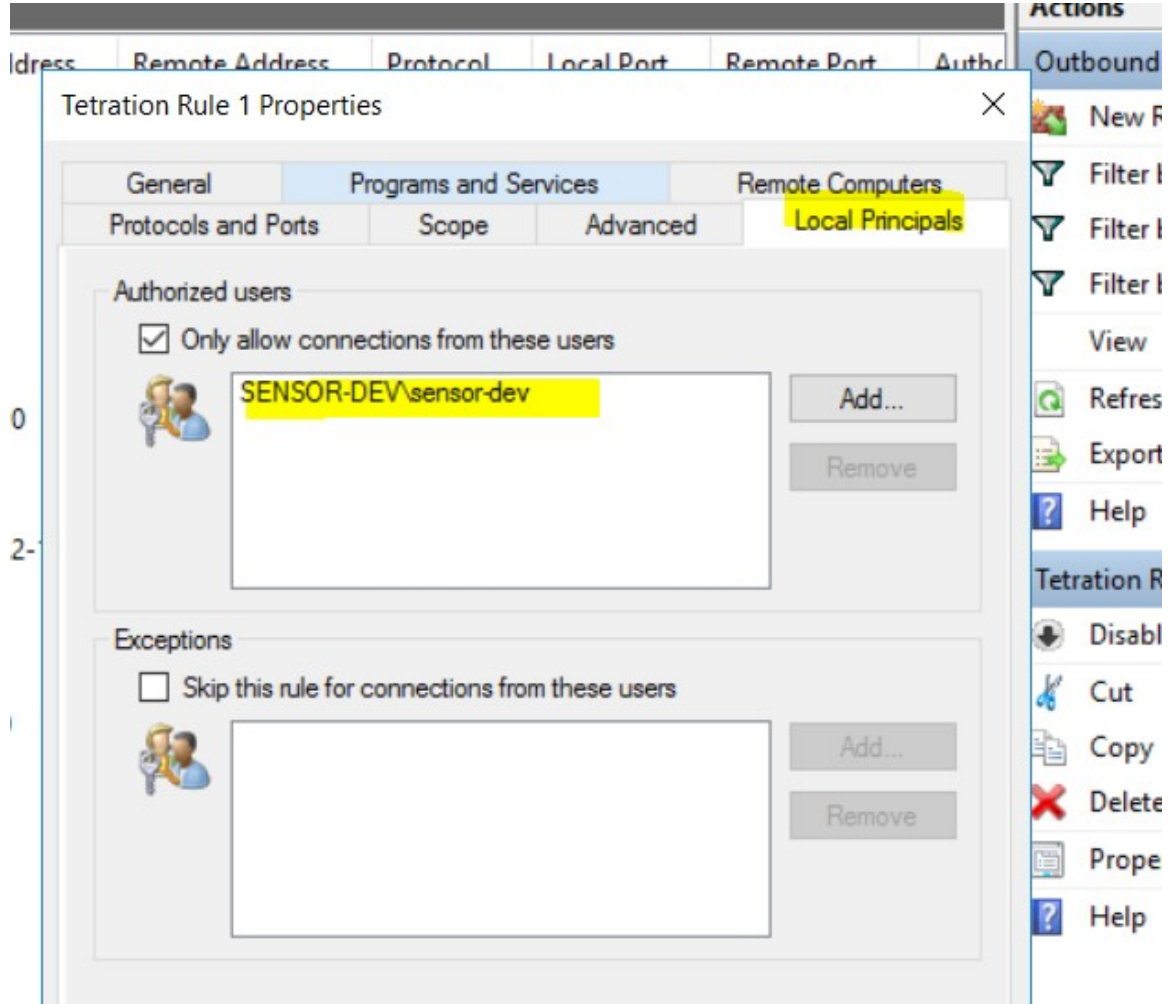

Firewall Rule Based on User Group and User Name

Example: Firewall rule based on User Name, sensor-dev\\sensor-dev and user group, domain users\\sensor-dev

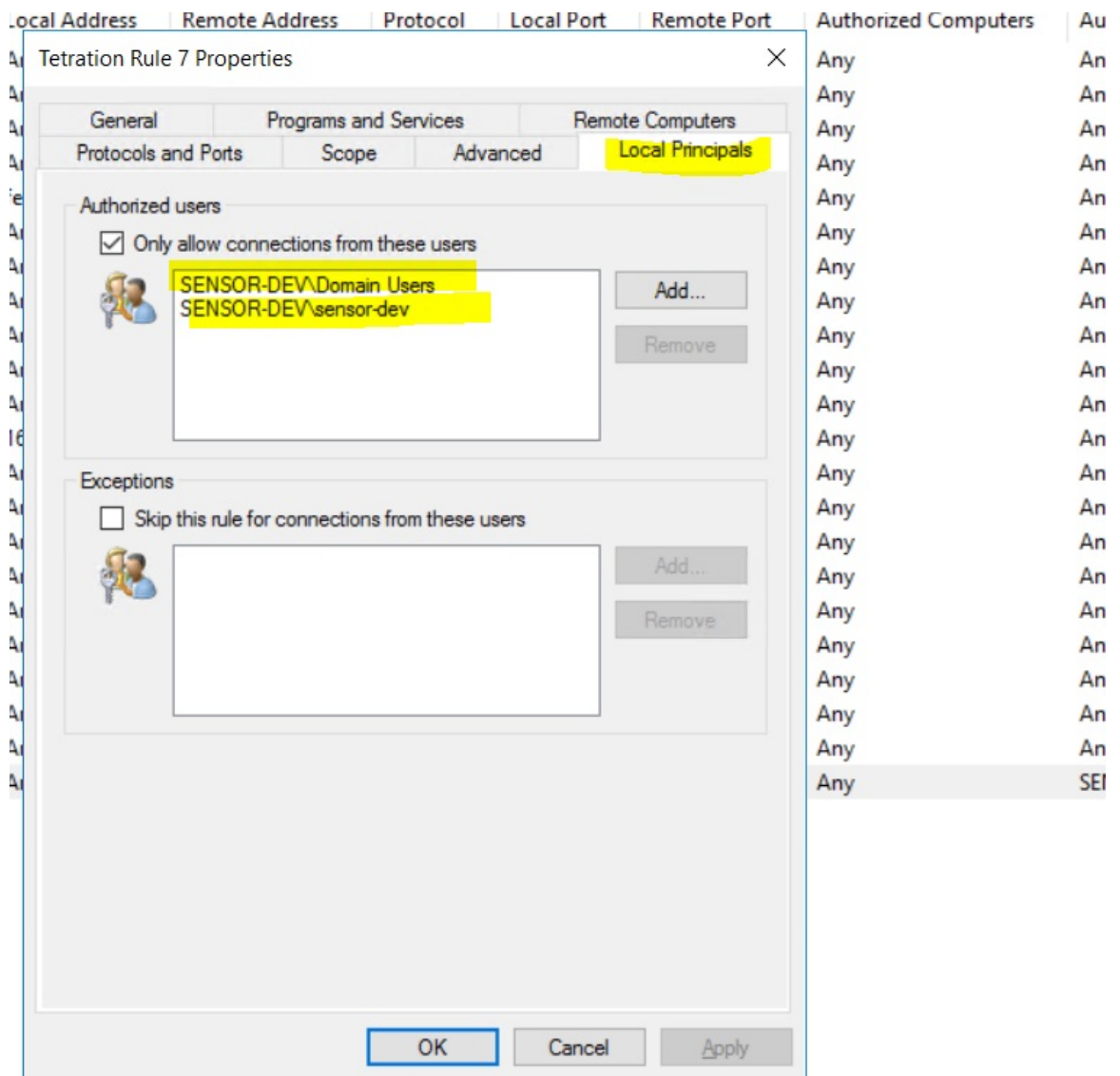

Generated Filter Using netsh

To verify using native Windows tools that a filter has been added for an advanced policy:

- With administrative privileges, run `cmd.exe`.
- Run `netsh wfp show filters`.
- The output file, **filters.xml**, is generated in the current directory.
- Check `FWPM_CONDITION_ALE_USER_ID` for user name in the output file: `filters.xml`.

```
<item>
    <fieldKey>FWPM_CONDITION_ALE_USER_ID</fieldKey>
    <matchType>FWP_MATCH_EQUAL</matchType>
    <conditionValue>
        <type>FWP_SECURITY_DESCRIPTOR_TYPE</type>
```

```

        <sd>O:LSD: (A;;CC;;;S-1-5-21-4172447896-825920244-2358685150)</sd>
    </conditionValue>
</item>

```

Generated WFP Filters Using tetenf.exe -l -f

Filter based on User Name

Example: WFP Rule based on User Name, SENSOR-DEV\sensor-dev

```

Filter Name:                Secure Workload Rule 1
-----
EffectiveWeight:           18446744073709551590
LayerKey:                  FWPM_LAYER_ALE_AUTH_CONNECT_V4
Action:                    Permit
RemoteIP:                  10.195.210.15-10.195.210.15
Remote Port:               30000
Protocol:                   6
User or Service:           SENSOR-DEV\sensor-dev

```

Filter based on User Group and User Name

Example: WFP Rule based on User Name, SENSOR-DEV\sensor-dev and User Group name, SENSOR-DEV\Domain Users

```

Filter Name:                Secure Workload Rule 1
-----
EffectiveWeight:           18446744073709551590
LayerKey:                  FWPM_LAYER_ALE_AUTH_CONNECT_V4
Action:                    Permit
RemoteIP:                  10.195.210.15-10.195.210.15
Remote Port:               30000
Protocol:                   6
User or Service:           SENSOR-DEV\Domain Users, SENSOR-DEV\sensor-dev

```

Service name and user name cannot be configured for a Network policy rule.



Note The network policy is rejected by the Windows agent if the user name or the user group is invalid.

Kubernetes and OpenShift

(Optional) Additional Policies for Kubernetes Workloads

The following procedures are optional, depending on your Kubernetes environment.

Policies for Kubernetes Nginx Ingress controller running in Host- network mode

Secure Workload will enforce policies both at the nginx ingress controller and at the backend pods when the pods are exposed to the external clients using Kubernetes ingress object.



Note If the ingress controller is not running in hostnetwork mode refer IngressControllerAPI



Note IBM-ICP uses Kubernetes Nginx Ingress controller by default and runs on control plane nodes in hostnetwork mode.

Following are the steps to enforce policy using Kubernetes Nginx Ingress controller.

Step 1 Create an external orchestrator for Kubernetes/OpenShift as described here.

```

→ ~
→ ~ k8s get ingress
NAME          HOSTS    ADDRESS          PORTS    AGE
test-ingress  *       192.168.60.100  80       7s

```

Step 2 Create an ingress object in the Kubernetes cluster. A snapshot of the yaml file used to create ingress object is provided in the following picture.

```

▶ k8s get ingress
NAME          HOSTS    ADDRESS          PORTS    AGE
svc-ce2e-teeksitlbiwlc  *       192.168.10.13   80       74s

```

```

~
▶ k8s get ingress -o yaml
apiVersion: v1
items:
- apiVersion: extensions/v1beta1
  kind: Ingress
  metadata:
    annotations:
      virtual-server.f5.com/ip: 192.168.10.13
      virtual-server.f5.com/partition: k8scluster
    creationTimestamp: "2020-06-26T21:31:01Z"
    generation: 1
    labels:
      e2e-test: "yes"
    name: svc-ce2e-teeksitlbiwlc
    namespace: default
    resourceVersion: "1074475"
    selfLink: /apis/extensions/v1beta1/namespaces/default/ingresses/svc-ce2e-teeksitlbiwlc
    uid: 5526b4a3-b7f4-11ea-aa09-525400d58002
  spec:
    backend:
      serviceName: svc-ce2e-teeksitlbiwlc
      servicePort: 80
    status:
      loadBalancer:
        ingress:
          - ip: 192.168.10.13
  kind: List
  metadata:
    resourceVersion: ""
    selfLink: ""

```

Step 3 Deploy Kubernetes Nginx Ingress controller in the Kubernetes cluster. IBM-ICP Ingress controller pods are running on control plane nodes by default.

```

~
▶ k8s get pods -o wide -n ingress-nginx
NAME                                READY   STATUS    RESTARTS   AGE   IP              NODE                                NOMINATED NODE
nginx-ingress-controller-6bc9c6745c-scfzs  1/1     Running   0           2m11s  192.168.10.13  enforcement-scale-16-kube3         <none>

~
▶ k8s get node enforcement-scale-16-kube3 -o wide
NAME                                STATUS   ROLES    AGE   VERSION   INTERNAL-IP   EXTERNAL-IP   OS-IMAGE             KERNEL-VERSION   CONTAINER-RUNTIME
enforcement-scale-16-kube3          Ready   <none>   7d5h  v1.12.3   192.168.10.13 <none>        Ubuntu 16.04.5 LTS   4.4.0-139-generic  docker://18.6.1

```

Step 4 Create a backend service which will be accessed by the consumers outside the cluster. In the example provided below we have created a simple *svc-ce2e-teeksitlbiwlc* (http-echo) service.

```

~
▶ k8s get svc svc-ce2e-teeksitlbiwlc
NAME                                TYPE           CLUSTER-IP   EXTERNAL-IP   PORT(S)   AGE
svc-ce2e-teeksitlbiwlc             ClusterIP      10.102.30.231 <none>        80/TCP    6m11s

```

Step 5 Create a policy between external consumer and backend service.

The screenshot shows a policy management interface. At the top, there are tabs for 'Absolute policies' (1), 'Default policies' (153), and 'Catch All' (DENY). A '+ Add Absolute Policy' button is visible. Below is a table with columns: Priority, Action, Consumer, Provider, and Protocols And Ports. A single policy is listed with Priority 100, Action ALLOW, Consumer OTHER: RCDN9-DCIO3N-ACE-Clien, Provider Default, and Protocols And Ports TCP : Any. To the right, a 'Scope' details panel for 'Default' is shown, including Full Name (Default), Primary App (Tetration), and Query (VRF ID = 1). There are also expandable sections for Workloads and IP Addresses.

Step 6 When you are ready, enforce the policy.

Step 7 In case of Nginx ingress controller Secure Workload software will apply the appropriate allow/drop rule where the source will be consumer specified in the above step and destination will be corresponding Ingress controller pod IP. In case of backend pods, Secure Workload software will apply the appropriate allow/drop rule where the source will be Ingress pod and destination will be the backend pod IP.

Policies for Kubernetes Nginx/Haproxy Ingress controller running as Deployment/Daemonset

Secure Workload will enforce policies both at the ingress controller and at the backend pods when the pods are exposed to the external clients using Kubernetes ingress object.

Following are the steps to enforce policies on Ingress controller.

Step 1 Create/Update an external orchestrator for Kubernetes/OpenShift using OpenAPI. See [Orchestrators](#) for information on creating the external orchestrator using OpenAPI. Add information of Ingress Controllers for External Orchestrator config.

Step 2 Create an ingress object in the Kubernetes cluster.

Step 3 Deploy Ingress controller in the Kubernetes cluster.

Step 4 Create a backend service which will be accessed by the consumers outside the cluster

Step 5 Create a policy between external consumer and backend service.

Step 6 When you are ready, enforce the policy.

Step 7 In case of Ingress controllers Secure Workload software will apply the appropriate allow/drop rule where the source will be consumer specified in the above step and destination will be corresponding Ingress controller pod IP. In case of backend pods, Secure Workload software will apply the appropriate allow/drop rule where the source will be Ingress pod and destination will be the backend pod IP.

Grouping Workloads: Clusters and Inventory Filters

Clusters and inventory filters serve similar purposes, but have some important differences:

Table 4: Comparison of Clusters and Inventory Filters

Clusters	Inventory Filters
Are used to apply policy to a subset of the workloads in a scope.	Can be used to apply policy to a subset of the workloads in a scope. Can also be used to apply policy to workloads regardless of scope (for example, to apply policy to all workloads running a particular operating system.)
Are defined by a query	Are defined by a query.
Can include only workloads in a single scope.	Can have membership restricted to a single scope or include workloads in any scope (for example, if the filter is based on operating system.)
Can only be used by policies in the same workspace and workspace version.	Can be used by policies in any scope and any workspace.
Can be automatically created during automatic policy discovery.	Must be manually created or converted from an existing cluster.
Can be overwritten during automatic policy discovery if not approved. Approving known good clusters can improve accuracy of other clusters in future discovery runs.	Are never modified by automatic policy discovery.
Benefit from important features of automatic policy discovery. They: <ul style="list-style-type: none"> • Have a confidence rating that helps you evaluate whether the workloads in the group belong together. • Can be compared with clusters generated during other policy discovery runs on the same workspace. 	--
Cannot be used when configuring External Dependencies, on page 30 and other features related to cross-scope policies and policy discovery.	Can be used to configure granular policies involving external dependencies and other features related to cross-scope policies, such as auto-pilot rules.
See Clusters, on page 71 and subtopics.	See Create an Inventory Filter and Convert a Cluster to an Inventory Filter, on page 76

Clusters

A cluster is a set of workloads grouped together within a workspace. (A Secure Workload deployment can also be called a cluster, but the two usages are unrelated.)

For example, if your application scope includes several web servers among many other types of servers and hosts that comprise your application, you might want a cluster of web servers within this application scope, so you can assign specific policies only to these web servers.

Automatic policy discovery groups workloads into clusters based on the signals observed in the timeframe specified during the run configuration.

Each cluster is defined by a query

Cluster queries are dynamic unless you define them with specific IP addresses. With dynamic queries, cluster membership can change over time to reflect changes in your inventory: More, fewer, or different workloads can match the query.

For example, if a cluster query is based on hostname containing the substring ‘HR’, and more hosts with hostname containing HR are added to the workspace, the cluster automatically includes the additional hosts.

Automatic policy discovery examines the hostnames and labels associated with workloads. For each cluster, automatic policy discovery generates a short list of candidate queries based on the hostnames and these labels. From these queries, you can select one, possibly edit it, and associate it with the cluster. Note that, in certain cases, when automatic policy discovery cannot formulate simple enough queries based on the hostnames and labels, no (alternate) queries are suggested.

Workloads in approved clusters are not affected by future policy discovery

Only workloads that are not already members of an approved cluster in the relevant workspace are affected by policy discovery. An **approved cluster** is a cluster that you have manually approved. For details, see [Approving Clusters, on page 79](#).

Edit clusters to improve grouping

In the following sections, we describe a few workflows to edit, enhance and approve the clustering results. Note that one can change/approve clusters only in the latest version of a workspace (see [Activity Logs and Version History](#)).

See [Making Changes to Clusters, on page 74](#).

Clusters involving Kubernetes inventory



Note If your workspace includes inventory from multiple Kubernetes namespaces, each cluster query must filter by namespace. Add the namespace filter to each query if it is not already present. If you change any query, automatically discover policies again.

A cluster may consist of a single workload.

You may want to create policies involving just a single workload.

Clusters may be converted to inventory filters

Like approved clusters, clusters promoted to inventory filters are not changed during subsequent policy discovery.

Unlike clusters, inventory filters are not tied to a workspace, but are globally available within your Secure Workload deployment.

For a comparison of clusters and inventory filters, see [Grouping Workloads: Clusters and Inventory Filters, on page 70](#).

See [Convert a Cluster to an Inventory Filter, on page 76](#).

Cluster Confidence

Use the confidence or quality score of a cluster to identify clusters needing improvement.

The confidence for a cluster is the average of the confidences for member workloads. In general, the more similar a workload is to other members of the cluster it was assigned, and the more dissimilar it is to the workloads of the closest (most similar) alternative cluster, the higher the confidence for that workload.

When flows are used for clustering, two workloads are similar when they have a similar pattern of conversations (such as similar sets of neighbors in the conversation graph, i.e., similar sets of consumer and provider workloads and ports).

**Note**

- Cluster confidence is not computed (undefined) for:
 - clusters containing only one workload
 - approved clusters
 - workloads in the scope for which no communication was observed (or no process information is available, if process-based clustering was chosen)
- Clusters do not span partition boundaries (such as subnet boundaries, see route labels in the advanced automatic policy discovery configurations). However, in computing confidence and alternate cluster, such boundaries are ignored. This indicates the potential existence of workloads or clusters that behave very similarly even though they are in different subnets.
- After editing clusters, the confidence scores may become inaccurate as they are NOT recomputed until you discover policies again.

To view cluster confidence, see [View Clusters, on page 73](#).

View Clusters

The clusters view supports query-to-cluster association and query editing.

In the clusters view, you can click a table column heading to sort the clusters based on that column (such as name, the number of workloads, or confidence).

For each cluster, by clicking on its row, you can view further cluster information such as description, suggested or approved queries, and the member workloads in the right panel. Several of these fields are editable.

To view clusters and details about them:

1. Navigate to the scope and workspace of interest.

Clusters are specific to a workspace; each workspace in a scope can have different clusters. To make clusters available outside their current workspace, see [Convert a Cluster to an Inventory Filter, on page 76](#).

2. Click **Manage Policies**.
3. Click **Filters**.
4. Click **Clusters**.
5. To view information about a cluster, click a cluster.
 - a. Look in the panel that opens on the right.
 - b. For more details, click **View cluster details**.

The Cluster Details page opens in a separate browser tab.

Figure 30: Clusters View

The screenshot shows the 'Clusters View' interface. At the top, there are navigation tabs: Activity Log (23), Matching Inventories (48), Conversations, Filters (13), Policies (154), Provided Services, and Enforcement Status. Below these is a search bar 'Enter attributes...' and a 'Create Cluster' button. The main area displays a table of clusters suggested by ADM algorithms. The table has columns for Name, Matching Inventory, Confidence, Dynamic, and Approved. The cluster 'bpim* 2' is highlighted. To the right, a sidebar shows details for 'bpim* 2', including Name, Description, Confidence (Low), and a list of associated entities: Workloads (2), IP Addresses (2), Neighbors (5), and Subnets (2).

Name ↑	Matching Inventory ↓	Confidence ↓	Dynamic ↓	Approved ↓
bpim*	4	N/A		
bpim* 2	4	Low		
bpim-idev3-*	3	N/A		
bpim-idev3-* 2	3	N/A		
bpim-idev3-0*	2	Low		
bpim-idev3-07.cisco.com	1	N/A		
bpim-idev3-201.cisco.com	1	N/A		
bpim-idev3-203.cisco.com	1	N/A		
bpim-idev4-*	3	N/A		
bpim-idev4-* 2	2	N/A		

Making Changes to Clusters

Automatic policy discovery creates one or more candidate queries for each cluster.

If clustering results do not completely match your expectations, you can improve the grouping by editing the query.

To browse and edit clusters: Click on the **clusters** box at the top of the page. To change a cluster (e.g. change the members of a cluster or select/change its query), select/edit the cluster's query, as shown below.

Figure 31: Edit Cluster

You can add or remove explicit IP addresses, or pick another query from the list of alternatives provided and edit that query. A cluster's query can be any query filter expressed in terms of addresses, hostnames, and labels. If you define a query based on labels rather than explicit IP addresses, the cluster will be dynamic, and new, changed, or removed inventory that is properly labeled will automatically be included in or excluded from the cluster.

After query selection and possible editing is done, click save. Note that once the SAVE button is clicked, the cluster is automatically marked approved, the approved thumbs-up icon turns blue (whether or not a change was made). The approved icon can be toggled to change the approved status as desired. See details at [Approving Clusters, on page 79](#).



Important

When a cluster's membership is changed, it may be necessary to discover policies again to get an updated policy accurately reflecting the changes in flows among the changed clusters. This is because cluster memberships may have changed (such as new nodes added to a cluster). A similar situation can occur if the scope corresponding to the workspace is edited or in general when workspace membership changes. Similarly, cluster confidence scores may no longer be accurate with changes to cluster memberships. In all these cases, automatically discovering policies again is useful to get updated policies and cluster confidence scores (updated confidences on unapproved clusters).

If you edit cluster queries, it is possible that clusters associated with queries may overlap.

Convert a Cluster to an Inventory Filter

Convert a cluster to an inventory filter if:

- You do not want the cluster to be modified by future automatic policy discovery runs, as a more versatile alternative to approving the cluster.
- You want the cluster to be independent of the workspace and workspace version.
- You are creating or discovering policies in which the consumer and provider belong to different scopes, and you want to create policies specific to a subset of workloads in a scope, not just policies involving the entire scope.

You must use inventory filters instead of clusters for this purpose if you create cross-scope policies using the advanced method described in [When Consumer and Provider Are In Different Scopes: Policy Options, on page 87](#) and you want policies to be more granular than scope-to-scope.

Step 1 Navigate to the workspace that contains the cluster to promote.

Step 2 Click **Manage Policies**.

Step 3 Click **Filters**.

Step 4 Click **Clusters**.

Step 5 Click the cluster you want to use in the cross-scope policy.

Step 6 In the panel on the right, in the **Cluster Actions** section, click **➤** (Promote to Inventory Filter.)

Step 7 Verify that the name, description, and query are as expected.

Step 8 Select **Restrict Query to Ownership Scope**.

(Inventory filters can cross scope boundaries, but you do not want this behavior for this purpose; you want this filter to include only workloads in this scope.)

Step 9 If you want the application defined by this inventory filter to be the provider in policies generated during automatic policy discovery, select **Provides a service external of its scope**.

If this application is a consumer rather than a provider, or if you will use this inventory filter only for manually created policies, you don't need to enable this option.

Step 10 Click **Promote Cluster**.

Step 11 Verify that the cluster has moved to the **Inventory Filters** tab.

You may need to refresh the page to see this change.

Creating or Deleting Clusters

Click the **Create Cluster** button on the clusters page to create a new empty cluster. Alternatively, you can also create a cluster from the automatic policy discovery page by clicking on **Create Filter** button in Get Started sidebar and selecting Clusters in the modal.

Figure 32: Creating a new Cluster

The new user defined cluster will show up on the side panel to be renamed, if necessary.

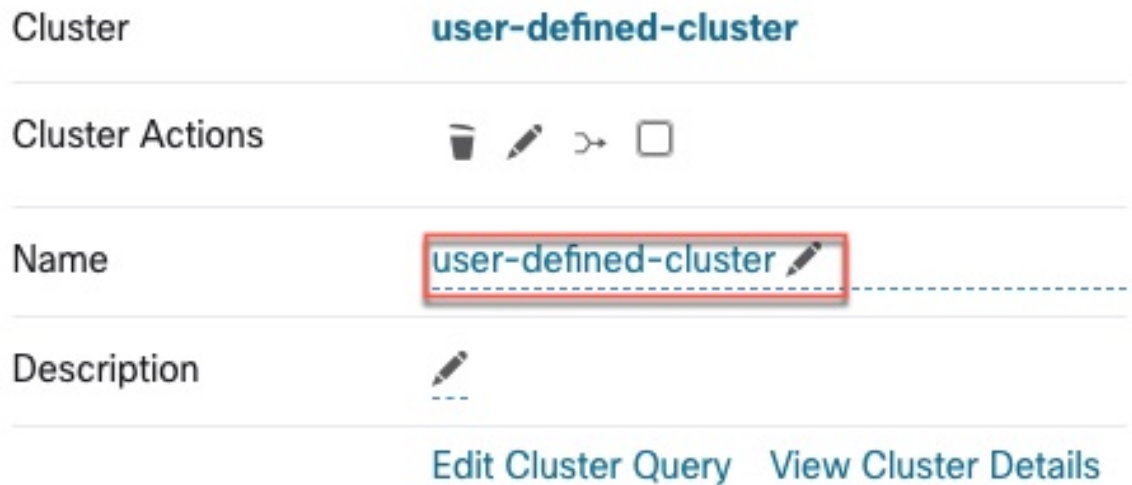
Figure 33: Renaming a Cluster

An empty cluster may be deleted by selecting the cluster in any of the views so that the details appear on the side panel and clicking the trash button on the header of cluster detail view. See figure above.

Comparing Versions of Generated Clusters: Diff Views

After you have automatically discovered policies at least twice for a workspace, you can compare the clusters generated in different discovery runs.

Step 1 Navigate to the clusters diff view using one of the following paths:

- After successfully discovering policies, a message will appear indicating the success with a link that navigates to the diff view showing discovery results. Click the results link.

Figure 34: Successful automatic policy discovery run

- Compare revisions from the versions view:
 - a. Follow the steps in [View, Compare, and Manage Discovered Policy Versions, on page 49](#).
 - b. After you click **Compare Revisions**, click **Clusters**.
- From the version details side panel:

- a. Follow the steps to view version details in [View, Compare, and Manage Discovered Policy Versions](#), on page 49.
- b. From the side panel, when it is showing context information for an automatic policy discovery run, click the double-arrow button on the top right corner of the side panel:

Figure 35: Showing Context Information

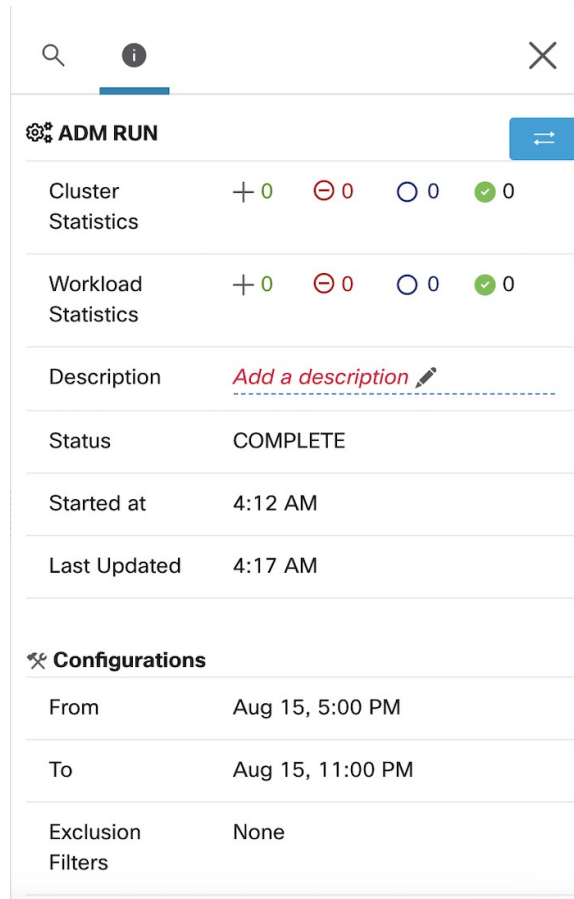

Step 2 Choose the versions to compare.

Step 3 Review the comparison results:

At the top level, the diff view for automatically discovered policies shows high level statistics about changes in clusters and workloads showing the number of added, deleted, modified, and unchanged clusters and workloads.

The rest of the view is organized as a list of clusters in the order of added, deleted, modified and unchanged, each color coded to reflect the status as well as the number of workloads added to or removed from the cluster.

You may search for a particular cluster or workload by name or IP address. To see how the contents of a cluster have changed, click any of the rows representing a cluster to expand that row.

Note By default, unchanged clusters are hidden. To display unchanged clusters, click the button with the eye icon.

Figure 36: Cluster Diff View

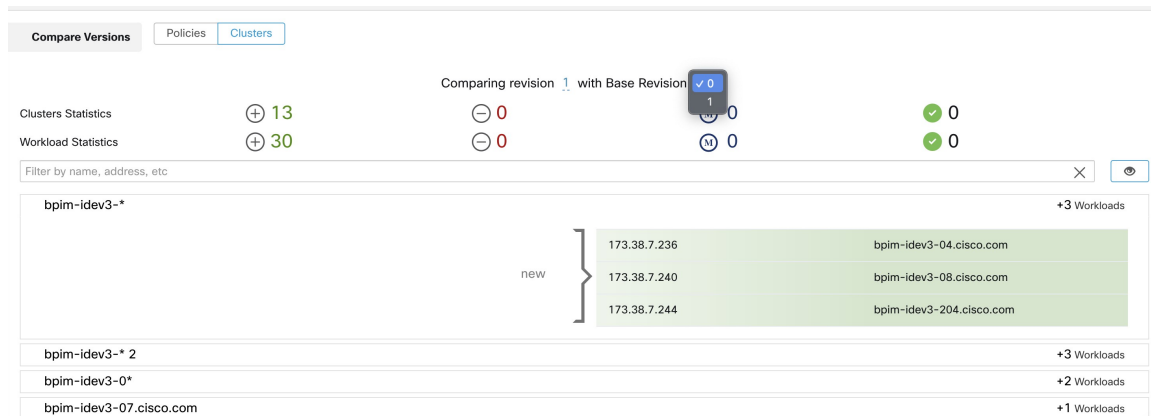

What to do next

To view a similar comparison for policies, see [Comparison of Policy Versions: Policy Diff](#).

Preventing Cluster Modification During Automatic Policy Discovery Reruns

If you do not want automatic policy discovery (formerly known as ADM) to modify a cluster when you automatically discover policies for the workspace in future, approve the cluster.

For example, approve the cluster if you have edited the cluster query, and now you need to add new workloads to the scope and cluster them without affecting the existing policies. Approving the cluster freezes the cluster contents and attributes in the current state. Automatic policy discovery does not change approved clusters.

See [Approving Clusters, on page 79](#).

Alternatively, you can promote the cluster to an inventory filter, which will never be modified by policy discovery. See [Convert a Cluster to an Inventory Filter, on page 76](#).

Approving Clusters



Note See also [Convert a Cluster to an Inventory Filter, on page 76](#), which may be a more appropriate option for your needs.

After you approve a cluster, subsequent automatic policy discovery does not change that cluster's query. Memberships of approved clusters can change only if the members of the workspace change.

Workloads that are members of an approved cluster may be referred to as "approved workloads."

To approve a cluster:

Make sure the cluster of interest is shown on the side panel. You can accomplish this via searching for the cluster, or clicking on the desired cluster on the chart in any of the views. Then select the check box on the top-right corner of the cluster info on the side panel as illustrated below. After a cluster is approved, it indicates that it will remain unchanged by future automatic policy discovery.

Figure 37: Approving Clusters

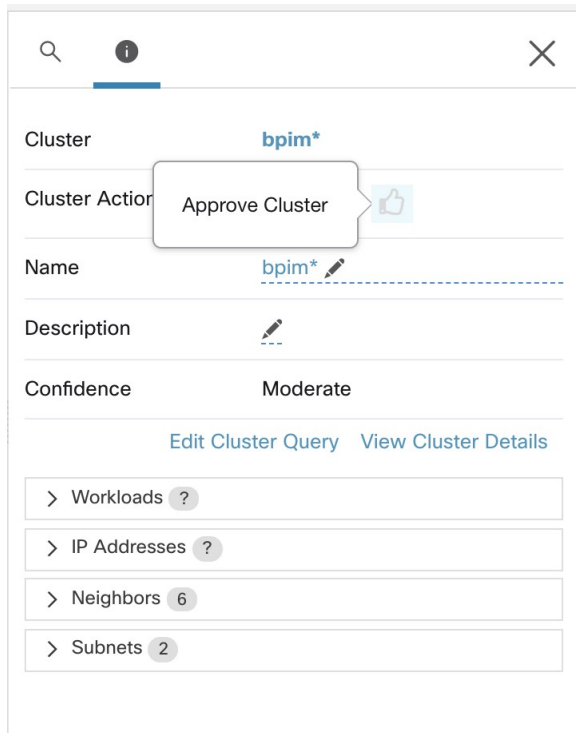

To remove approval of a cluster, click the approval icon.

Figure 38: Removing Approval of a Cluster

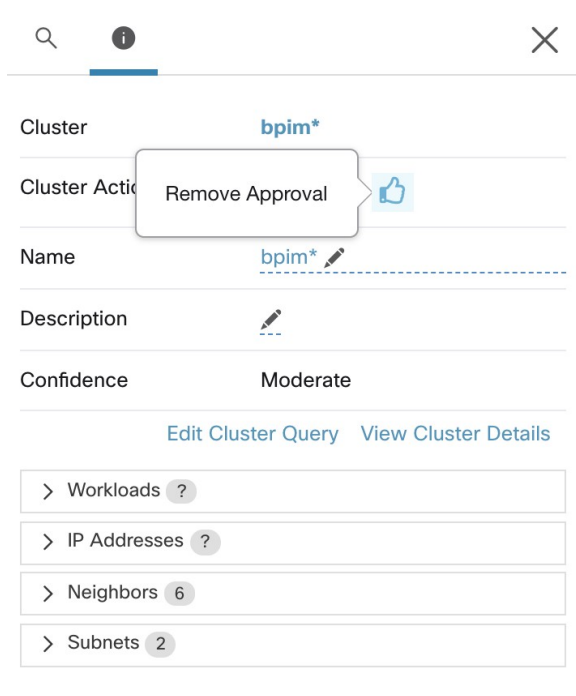

Address Policy Complexities

Enforcement results are impacted by factors including:

- Rule type and rank:
 - Absolute vs Default policies
 - The catch-all setting for the workspace

See [Policy Rank: Absolute, Default, and Catch-All, on page 9](#).

- Order of policies within the workspace

See [Policy Priorities, on page 81](#).

- Policies inherited from parent or ancestor scopes, including the catch-all rule

You will want to ensure that a higher-priority policy is not hitting traffic before the policy that you expect to hit that traffic.

To see the impact of policies in ancestor scopes, run live policy analysis on all involved scopes. See [Live Policy Analysis, on page 118](#).

When you are ready to enforce the policies in a workspace, a wizard shows you which inherited policies impact workloads in the workspace. For information, see [Policy Enforcement Wizard, on page 135](#).

- Cross-scope policy interactions

(When consumer and provider are in different scopes, or one end of the conversation is in a different scope than the policy)

See [When Consumer and Provider Are In Different Scopes: Policy Options, on page 87](#).

- Situations in which the actual consumer or provider in a policy may differ from the default configured consumer and provider, for example in failover scenarios.

See [Effective Consumer or Effective Provider, on page 101](#).

Policy Priorities

Traffic handling is affected by:

- The priority of policies within the scope, and
- [Policy Global Ordering and Conflict Resolution, on page 82](#)

Policy priorities within a scope

Within a workspace, the order of the policies in the list reflects the relative priority of each policy, with the highest priority policy at the top of the list, and the lowest priority policy at the bottom of the list.

In each workspace, Absolute policies have priority over Default policies, and the Catch-All policy is the lowest priority policy in the workspace.

For details, see [Policy Rank: Absolute, Default, and Catch-All, on page 9](#).

Policy Global Ordering and Conflict Resolution

Conflicts can arise between different policies defined under different scopes. More specifically, conflicts arise for workloads (inventory items) that belong to multiple scopes, such as parent/child, when those scopes have contradictory policies).

It is not feasible to resolve such conflicts manually due to the dynamic nature of scope membership; workloads can enter and leave scopes as their properties change. Therefore, the system imposes a global order, as described below, for all policies according to the scope under which they are defined. For each workload, the list of relevant policies (according to consumer/provider/scope) is identified and sorted by the global order. The decision to permit or drop a flow is made based on the *first* matching policy in the sorted list.

By understanding the global ordering scheme of security policies, network admins can define the correct scopes and their priorities to apply the overall desired policies on workloads. Within each scope, application owners maintain their ability to enforce fine-grained policies on their respective workloads.

A global network policy has the following characteristics:

- A set of scopes ordered by priority (highest priority first).
- Each scope's primary workspace has absolute policies, default policies and a catch-all action.
- Each group of absolute or default policies within each workspace is sorted according their local priorities (highest first).

The global order of policies is defined as follows:

- Groups of absolute policies from the primary workspaces of all scopes (arranged from highest to lowest priority).
- Groups of default policies from the primary workspaces all scopes (arranged from lowest to highest priority).
- Catch-all policies from all scopes (arranged from lowest to highest priority).

Note that the scope order applies to groups of policies in category 1 and 2, rather than individual policies. Within each group, individual policies with lower policy priority numbers taking precedence.

For a specific workload, first the subset of scopes it belongs to is determined, then the above order is applied. The catch-all policy from the lowest priority (enforced) workspace to which this workload belongs is the applicable catch- all (but an absolute or default policy may override). For a given flow on that workload, the action of the highest matching policy is applied.

**Note**

- If a workspace has neither Absolute nor Default policies defined, the workspace is ignored. The workspace's catch-all policy will not be included in the global order.
- The order of Default policies in the global order is the reverse of the scope priorities. This lets you define broad policies for all scopes to secure the perimeter of all workspaces including those that do not have policy enforcement enabled. At the same time application owners who have enabled enforcement on their scopes have the ability to override these default policies.
- Overlapping scopes are not recommended; see [Scope Overlap](#) for details. However, if a workload has two or more interfaces, in overlapping or disjoint scopes, the catch-all policy of the lowest priority workspace with enforcement enabled will apply (among all the applicable catch-all policies).

We expand our previous three-scope example to illustrate this ordering scheme. Assume the three scopes are assigned the following priorities (See [Use Workspaces to Manage Policies](#) for instruction on how to change scope priorities):

1. Apps
2. Apps:HR
3. Apps:Commerce

The primary workspace of each of these scopes has absolute policies, default policies and a catch-all action. Each group of absolute or default policies within each workspace is sorted according their local priorities.

The global ordering of the policies will be as follows:

1. Apps Absolute policies
2. Apps:HR Absolute policies
3. Apps:Commerce Absolute policies
4. Apps:Commerce Default policies
5. Apps:HR Default policies
6. Apps Default policies
7. Apps:Commerce Catch-all
8. Apps:HR Catch-all
9. Apps Catch-all

A workload that belongs to the *Apps* scope will receive only the following policies in the given order:

1. Apps Absolute policies that match the workload
2. Apps Default policies
3. Apps Catch-all

A workload that belongs to the *Apps* and *Apps:Commerce* scopes will receive only the following policies in the given order:

1. Apps Absolute policies
2. Apps:Commerce Absolute policies
3. Apps:Commerce Default policies
4. Apps Default policies
5. Apps:Commerce Catch-all

A workload that belongs to the *Apps* and *Apps:HR* scopes will receive only the following policies in the given order:

1. Apps Absolute policies
2. Apps:HR Absolute policies
3. Apps:HR Default policies
4. Apps Default policies
5. Apps:HR Catch-all

Policy Order and Overlapping Scopes



Important The following scenario involves overlapping scopes. You should avoid having overlapping sibling scopes – workloads should not be members of multiple branches of the scope tree. For more information, see [Scope Overlap](#).

A workload that belongs to all three *Apps*, *Apps:HR* and *Apps:Commerce* scopes will receive the following policies in the given order:

1. Apps Absolute policies
2. Apps:HR Absolute policies
3. Apps:Commerce Absolute policies
4. Apps:Commerce Default policies
5. Apps:HR Default policies
6. Apps Default policies
7. Apps:Commerce Catch-all

Note that the relative ordering of the *Apps:HR* and *Apps:Commerce* scopes only matters if the two scopes overlap (that is, there are workloads that belong to both sibling scopes.) This is because policies are always defined under a scope. A workload belonging to one scope only will not be affected by policies from the other scope, thus the order does not matter.

Validate the Order and Priority of Policies

To validate the order and priority of policies in parent/ancestor workspaces, click the **Analyzed Policies** or **Enforced Polices** tab at the top of the Defend > Segmentation page. These views provide a global view of the analyzed and enforced policies respectively.

Figure 39: Example: List of enforced policies in their policy priority order

All Enforced Policies are shown below. They are ordered in the global order in which they are applied to workload firewalls.

Related to: Hide empty policy groups

Last enforcement event: Mar 3 2022 05:08:41 am (IST)

Policy Group	Count	Policy Name	Version	Last Enforcement Event
Absolute Policies	1	Furong:jumphost	Version p10	March 3, 2022
Default Policies	6	Furong:ipv6-domain	Version p10	September 10, 2021
Default Policies	10	Furong:jumphost	Version p10	March 3, 2022
Default Policies	14	Furong:App1	Version p10	May 13, 2021
Catch-All Policies	1	Furong:ipv6-domain	Version p10	DENY

- To limit the list of policies to only those which include a particular scope or filter as a consumer or provider, select a scope or enter a filter.
- Available filters:

Filter Name	Definition
Port	Policy port to match, e.g. 80.
Protocol	Policy protocol to match, e.g. TCP.
Approved	Matches policies that have been marked as Approved Policies .
External?	Policies in which the consumer and provider are in different scopes.
Action	Policy action: Allow or Deny

(Advanced) Change Policy Priorities



Caution

Scope policy priority order rarely needs to be changed. Since changing policy priorities can affect enforcement results on all workspaces, change with caution.

Access to this feature is limited to users with very high privilege roles such as site admin.

Before you begin

Before changing scope priority order:

- Understand policy sorting logic and how policy priorities on scopes translate to ordering of individual policy intents. See [Policy Priorities, on page 81](#).
- Make changes in a secondary workspace until you are confident that your new order will be as expected.
- Plan your changes, considering the following guidelines:

When reordering, keep a parent-first ordering (parent scopes above child scopes) to take advantage of the hierarchical structure of your scope tree.

(If you have overlapping sibling scopes, it may be necessary to reorder sibling scopes and their children. Overlapping sibling scopes are not recommended. Fix these by updating scope queries. See [Scope Overlap](#).)

Step 1 To reorder policy priority, click the menu icon next to **Tools** and select **Policy Order**:

Figure 40: Navigating to Policy Priorities page

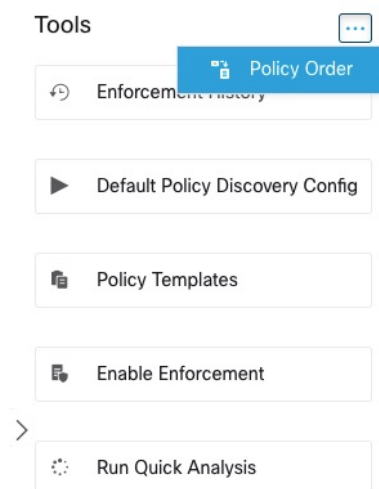

Once on the Policy Order page, you can see the list of all scopes and their corresponding primary workspaces according to the current policy priority.

Step 2 There are several ways to reorder the scopes:

- To reorder the entire list to place parent scopes above child scopes ("pre-order"): Click **Reorder Naturally**. This is the recommended order and any deviation from this should be done with care.
- To reorder the list manually:
 - Drag the rows up and down.
 - Click **By Number** to set a number for each scope to be used for sorting. This can be easier for large lists.

Figure 41: Setting Policy Priorities for Scopes

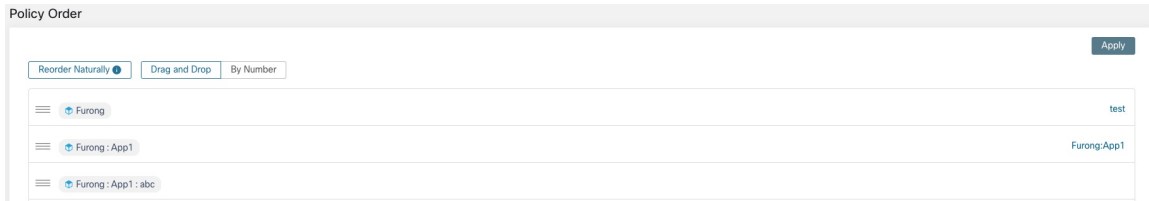

What to do next

Run Quick Analysis to see the results of your changes.

When Consumer and Provider Are In Different Scopes: Policy Options

Example Scenario

The following situation is an example showing cross-scope traffic:

Your scope hierarchy includes a Network Services scope that includes an authentication application (the provider). An HR application, which is a member of a scope on a different branch of the scope hierarchy, is a consumer of the service provided by the authentication application.

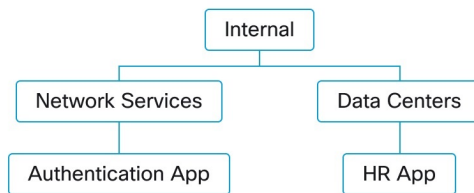

Policy Options

Secure Workload offers several ways to address this situation:

Option	Instructions	Pros and Cons
Create these policies in a parent or ancestor scope that includes both consumer and provider as children or descendants	<ul style="list-style-type: none"> Manually create one or more policies in the common-ancestor scope. <p>(Optional) For more precise policies, group workloads using inventory filters. For examples and instructions, see Create an Inventory Filter.</p> <ul style="list-style-type: none"> Automatically discover policies in the common-ancestor scope, for the entire branch of the scope tree, using the Deep policy generation, on page 40 option. 	<p>These methods are the simplest way to address cross-scope policies.</p> <p>These methods require only one policy per consumer-provider pair.</p> <p>If you are considering using automatic policy discovery, see important additional considerations in Discover Policies for One Scope or for a Branch of the Scope Tree, on page 22.</p>
Use the advanced method for creating cross-scope policies	<p>Automatically discover policies for each individual scope.</p> <p>See (Advanced) Create Cross-Scope Policies, on page 88.</p> <p>(This procedure applies to both manually created policies and discovered policies.)</p>	<p>This method requires two policies for each consumer-provider pair: A policy for the consumer and a policy for the provider.</p> <p>This method allows policy creation when consumer and provider policies are owned by different people.</p> <p>See additional considerations in Discover Policies for One Scope or for a Branch of the Scope Tree, on page 22.</p>

(Advanced) Create Cross-Scope Policies

This procedure describes the advanced method of creating cross-scope policies (policies in which consumer and provider are in different scopes.) It applies to both manually created policies and automatically discovered policies.

This method requires two policies for each consumer-provider pair, because both ends of the conversation must allow the conversation to happen:

- A policy in the consumer's scope must allow conversations with the provider, and
- A policy in the provider's scope must allow conversations with the consumer.

This procedure includes the steps that must be taken by the owner of each scope in order to create cross-scope policies. If your access privileges allow you to modify both scopes, you can perform all steps.

Before you begin

- Consider simpler options for handling cross-scope traffic. See [When Consumer and Provider Are In Different Scopes: Policy Options](#), on page 87.
- Policies using this method must be created in the primary workspace of both consumer and provider.

If the provider scope to be specified in the policy does not yet have a primary workspace, create it before creating cross-scope policies using this method.

- The policies must have ALLOW action in order for policy requests to be created.
- For some additional details related to these requirements, see [Policy Requests, on page 89](#).
- (Optional) Consider options for automatic handling of cross-scope policy requests. See [Automate Handling of Cross-Scope Policy Requests, on page 95](#).
- (Optional) If you want cross-scope policies to apply only to the workloads in a cluster within the consumer or provider scope, and not to the entire scope, see [Convert a Cluster to an Inventory Filter, on page 76](#). Clusters cannot be used in cross-scope policies created using this procedure.

If you are discovering policies automatically, see also [External Dependencies, on page 30](#) and [Fine-Tune External Dependencies for a Workspace, on page 31](#).

Step 1

In the consumer's primary workspace, create the desired policy, either manually or using automatic policy discovery.

For each cross-scope policy created, a policy request will automatically be created for the provider.

To view the policy requests, see [Viewing, Accepting, and Rejecting Policy Requests, on page 91](#).

Note: If an existing policy in the provider application's workspace matches this traffic, a new policy is not needed and a request is not created. This situation is indicated as described in [Resolved Policy Requests, on page 99](#).

Step 2

You (or the owner of the provider application) must respond to each policy request:

See [Viewing, Accepting, and Rejecting Policy Requests, on page 91](#).

Accepting a policy request automatically creates the required policy in the primary workspace of the provider, allowing traffic between the two applications.

If you do not want to allow traffic from the requesting application, reject the request.

Step 3

(Optional) If you are automatically discovering policies, you may want to [Fine-Tune External Dependencies for a Workspace, on page 31](#).

Step 4

Review and analyze both primary workspaces.

What to do next

When you are ready to enforce these policies, you must enforce both primary workspaces.

Policy Requests

Policy requests are generated when you create cross-scope policies using the method described in [\(Advanced\) Create Cross-Scope Policies, on page 88](#). Each time a policy is created in a consumer scope's primary workspace when the provider is a member of a different scope, if the policy does not yet exist in the primary workspace associated with the provider's scope, a policy request is generated.

This policy request alerts the owner of the provider application to allow dependent applications to access necessary services.

See options for viewing and responding to policy requests at [Viewing, Accepting, and Rejecting Policy Requests, on page 91](#) and [Automate Handling of Cross-Scope Policy Requests, on page 95](#).

Additional details about policy requests

- The provided services page (on which policy requests appear) is only available to primary workspaces. This is to ensure that isolated experiments on secondary workspaces do not create notifications on other primary workspaces.
- If an external scope (when the provider specified in the policy belongs to a different scope than the consumer) does not have a primary workspace, no requests are sent (for example, this could be the case for the root scope, or any scope defined for workloads outside the organization). If an external scope has not published any policy, policy analysis and enforcement are carried out on the consumer end only.
- Clusters are not supported when the provider is in a different scope than the consumer. If the policy's consumer is a cluster, the policy request will be made as if the policy request were from the consumer application's scope. Multiple policies consuming the same service from a provider could be grouped together.
- Policy requests are generated only for providers, not for consumers. If a consumer workspace is analyzing or enforcing policies, it has to explicitly include policies that allow all its legitimate consuming flows, either through automatic policy discovery or by explicitly manually crafting policies (no policy requests from external provider workspaces are generated to it).

Example Policy Request

In the following example, the FrontEnd app is creating two policies on TCP port 22 and UDP Port 514 from **FrontEnd** scope to **Tetration** scope. The Serving Layer app is creating two policies on TCP port 90 and UDP Port 92 from **ServingLayer** scope to **Tetration** scope.

Two policy requests are immediately sent to the Tetration Workspace (primary workspace with Tetration scope), and the policies on FrontEnd App and ServingLayer app are shown with a pending status.

Figure 42: Policies created in consumer application's workspace

The policy request status shows as Pending (FrontEnd):

The screenshot displays the Cisco Tetration interface for the 'FrontEnd' workspace. The main table lists policies with columns for Priority, Action, Consumer, Provider, and Services. A tooltip is visible over one of the rows, showing a 'Policy request pending' for 'Request sent at: 2:19 PM' to 'Application: Tetration Workspace' with 'Scope: Tetration'. The right-hand panel shows details for a selected policy, including its Rank (100), Action (ALLOW), Consumer (Tetration:FrontEnd), and Provider (Tetration). It also lists service ports: TCP: 22 (SSH) and UDP: 514.

Priority	Action	Consumer	Provider	Services
100	ALLOW	Tetration : FrontEnd	Tetration	TCP : 22 (SSH) ...1 more
100	ALLOW	appServer-	Tetration	ICMP ...35 more
100	ALLOW	mongodb-	Tetration	UDP : 53 (DNS) ...7 more
100	ALLOW	redis-	Tetration	ICMP ...6 more
100	ALLOW	elasticsearch-	Tetration	UDP : 53
100	ALLOW	Tetration	Tetration : FrontEnd	TCP : 22
100	ALLOW	4.4.2.5	Tetration : FrontEnd	TCP : 500
100	ALLOW	1.1.1.6	Tetration : FrontEnd	TCP : 6000 ...11 more
100	ALLOW	1.1.1.* [2]	Tetration : FrontEnd	UDP : 514
100	ALLOW	1.1.1.*	Tetration : FrontEnd	ICMP
100	ALLOW	orchestrator-77	Tetration : FrontEnd	TCP : 443 (HTTPS) ...6 more
100	ALLOW	datanode-	Tetration : FrontEnd	TCP : 6379 ...3 more
100	ALLOW	enforcementCoordinator-	Tetration : FrontEnd	TCP : 27017 ...1 more
100	ALLOW	launcherHost-	Tetration : FrontEnd	TCP : 27017

Figure 43: Pending Policy Requests on provider application's workspace (Tetration Workspace)

The screenshot shows the 'Tetration Workspace' interface. The 'Provided Services' section is active, displaying a list of services with their status (pending, accepted, rejected). A tooltip is visible over the 'Tetration : FrontEnd' service, showing details for a pending request: 'Consumer Application's Scope: Tetration : FrontEnd', 'Provider: Tetration', and 'Service: UDP : 514'. The right-hand panel shows details for the selected service, including its Scope (FrontEnd), Full Name (Tetration:FrontEnd), Primary App (FrontEnd), and Query (Hostname contains appServer or Hostname contains elastic or Hostname contains redis or Hostname contains mongo).

Provider	Policy Requests	Auto-pilot Rules
Tetration	3	2

Consumer Application's Scope	Pending	Accepted	Rejected
Tetration : FrontEnd	1	0	0
Tetration : Serving Layer	2	0	0

Viewing, Accepting, and Rejecting Policy Requests

When creating cross scope policies using the method described in [\(Advanced\) Create Cross-Scope Policies, on page 88](#), a policy is required in the primary workspace of the provider's scope in addition to the policy in the consumer's scope. When a cross-scope policy is created in the primary workspace of the consumer's scope, a policy request is automatically created in the primary workspace of the provider's scope.

Use the information in this topic to accept the request (to create the required policy in the provider scope) or reject the request (in which case the cross-scope policy will not take effect.)

To view, accept, or reject policy requests:

To	Do This
View all policy requests	<ol style="list-style-type: none"> 1. Choose Defend > Segmentation. 2. Click Policy Requests at the top of the page. 3. Click a consumer scope to see policy requests from that scope.
View policy requests for a particular scope	<p>To view pending policy requests for a provider scope:</p> <ol style="list-style-type: none"> 1. Choose Defend > Segmentation. 2. Click the primary workspace of the applicable scope. 3. Click Manage Policies. 4. Click Provided Services. <p>If the tab does not display a number, there are no policy requests pending for this workspace.</p> <ol style="list-style-type: none"> 5. Click Policy Requests. 6. Click a consumer scope to see policy requests from that scope. <p>Or</p> <p>To view a policy request from the consumer scope:</p> <p>In the Policies tab of the primary workspace of the consumer scope, click the value in the Protocols and Ports column, then look at the panel that opens on the right side of the page. In the Protocols and Ports section, click a yellow dot to see pending policy requests.</p>
Manually accept a request and automatically create the required policy in the Provider scope	From either of the locations above, click Accept next to the policy request.
Manually reject a request	From either of the locations above, click Reject next to the policy request.



To	Do This
View policy request status from the consumer workspace	<p>On the Policies page of the primary consumer workspace, click the policy, then click the port/protocol value. Status is shown in the panel that opens on the right.</p> <p>A pending request is shown with a yellow dot:</p>  <p>When the request is accepted, the dot changes to a green check mark:</p>  <p>mark:</p> <p>Click the indicator for details.</p>
View policy request status from the provider's workspace	View request status in the Provided Services tab described above.
Allow policy discovery to create the required policy for the provider	Automatically discover policies in the provider scope's primary workspace, using a time range that ensures that the corresponding flows are seen, then publish the policy.
See also options for automating handling of policy requests	Automate Handling of Cross-Scope Policy Requests, on page 95

Figure 44: Pending policy requests in the provider's workspace

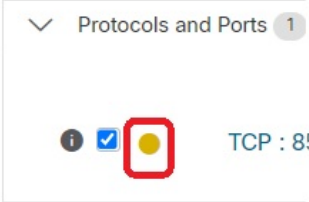

Accepting Policy Requests: Details

Accepting a policy request on a service is equivalent to creating a policy from the requested filter as the consumer to the service as the provider. Additionally, upon accepting a policy request, the original policy

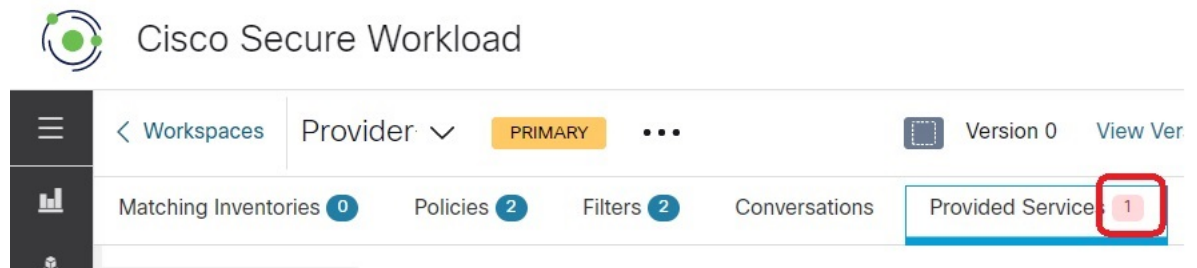
from the consumer application's workspace (in the example, FrontEnd App and Serving Layer) will be marked as accepted (see figures below)

Figure 45: Accepting/Rejecting policy requests

The screenshot shows the 'Provided Services' interface. At the top, there are tabs for 'policy requests' (1), 'auto-pilot rules' (2), and 'Tetration'. Below this, the 'Consumer Application's Scope' is shown with a table of services and their status:

Service	Status	Accepted	Rejected
Tetration : FrontEnd	1 pending	0 accepted	0 rejected
Tetration : Serving Layer	0 pending	1 accepted	1 rejected

Below the table, there are two rows of service details:

From	Port	Status	Time
Tetration : Serving Layer	TCP : 90	Accepted	2:27 PM
Tetration : Serving Layer	TCP : 92	Rejected	2:27 PM

At the bottom, there is a section for 'All Inventory Filters' with a note: 'Filters restricted to the scope of this application and marked as providing a service will be used to create policies during an ADM run. ADM runs in other applications can access these filters/services by setting the external dependency to 'fine'.'

Figure 46: Policy status shown as Accepted

The screenshot shows the 'Serving Layer' interface. At the top, there are tabs for 'Tetration : Serving Layer' (PRIMARY), 'DYNAMIC', and 'Version: v1'. Below this, there is a table of policies:

Priority	Action	Consumer	Provider	Services
100	ALLOW	Tetration : Serving Layer	Tetration	TCP : 90 ...1 more
100	ALLOW	druid*	Tetration	ICMP ...13 more
100	ALLOW	druid*	Tetration : FrontEnd	UDP : 8301 ...2 more
100	ALLOW	druid*	Tetration : Collector	UDP : 123 ...2 more
100	ALLOW	Tetration	druid*	ICMP ...8 more
100	ALLOW	Tetration : FrontEnd	druid*	TCP : 8080 ...2 more
100	ALLOW	Tetration : Collector	druid*	ICMP ...5 more
100	ALLOW	druid*	druid*	TCP : 8080 (HTTP) ...4 more

A tooltip is shown over the first policy row, indicating that a policy request was accepted. The tooltip text is:

```

Policy request accepted
Request sent at: 2:27 PM
to Application: Tetration Workspace
with Scope: Tetration
Accepted at: 2:35 PM
By: You
  
```

The new policy created on the provider application's workspace (in this example, the workspace is named Tetration) is marked with a **plus** icon indicating that this policy was created due to an external policy request.



Note

If the original policy on the consumer side is deleted after the policy request is accepted, the policy on provider side will not be deleted. However, the tooltip next to the policy shows the original policy as deleted with the timestamp of the event:

Figure 47: Provider side policy, created by accepting a policy request

The screenshot shows the Tetration Workspace interface. At the top, it displays 'Tetration Workspace' with a 'PRIMARY' status and a 'Switch Application' button. Below this, there are navigation tabs for 'Tetration', 'DYNAMIC', and 'Workloads: 96'. A 'Last Run: Jul 10, 2:48 PM' timestamp is shown. The main area features a 'Filters' section and a table of policies. The table has columns for Priority, Action, Consumer, Provider, and Services. A tooltip is overlaid on a policy row, showing details: 'Accepted Policy Request', 'from Application: Serving Layer', 'with Scope: Tetration : Serving Layer', 'By: You', and 'Accepted at: 2:35 PM'. To the right, a 'Policy' sidebar shows details for the selected policy, including Rank (Default), Priority (100), Action (ALLOW), Consumer (Tetration:Serving Layer), and Provider (Tetration).

Rejecting Policy Requests: Details

Rejecting a policy request does not create or update any policies. The original policy from the consumer application's workspace (in the example, Serving Layer App) will be marked as rejected, but the policy remains in effect, i.e., outbound traffic still will be allowed. The tooltip next to the reject policy has information about the provider application, the user that rejected the policy request as well as the time of the rejection.

Figure 48: Policy status shown as Rejected

The screenshot shows the Tetration Workspace interface. At the top, it displays 'Tetration Workspace' with a 'PRIMARY' status and a 'Switch Application' button. Below this, there are navigation tabs for 'Tetration', 'DYNAMIC', and 'Workloads: 96'. A 'Last Run: Jul 10, 2:48 PM' timestamp is shown. The main area features a 'Filters' section and a table of policies. The table has columns for Priority, Action, Consumer, Provider, and Services. A tooltip is overlaid on a policy row, showing details: 'Policy request rejected', 'Request sent at: 2:27 PM', 'to Application: Tetration Workspace', 'with Scope: Tetration', 'Rejected at: 2:35 PM', and 'By: You'. To the right, a 'Policy' sidebar shows details for the selected policy, including Rank (Default), Priority (100), Action (ALLOW), Consumer (Tetration:Serving Layer), and Provider (Tetration).

Automate Handling of Cross-Scope Policy Requests

Policy requests are generated when you create cross-scope policies using the method described in [\(Advanced\) Create Cross-Scope Policies](#), on page 88.

There are several options to reduce the number of policy requests that are generated when creating cross-scope policies:

Table 5: Options for Automatically Handling Policy Requests

To	Do This
Specify handling of policy requests between specific consumer-provider pairs	See Auto-pilot Rules, on page 96 . You must have the required privileges.
Automatically create all required policies for providers for all cross-scope policies created during policy discovery in a particular workspace	When you start an automatic policy discovery run, enable the Auto accept outgoing policy connectors option in the Advanced Configurations section. This option is available to root scope owners and site admins only. For details, see: Advanced Configurations for Automatic Policy Discovery, on page 33 and Auto Accept Policy Connectors, on page 98
Specify default handling for all policy requests from all workspaces	On the Default Policy Discovery Config page, enable the Auto accept outgoing policy connectors option in the Advanced Configurations section. This option is available to root scope owners and site admins only. For details, see: Default Policy Discovery Config, on page 44 and Advanced Configurations for Automatic Policy Discovery, on page 33 and Auto Accept Policy Connectors, on page 98

Auto-pilot Rules

This feature is applicable only if you create cross-scope policies using the method described in [\(Advanced\) Create Cross-Scope Policies, on page 88](#).

Infrastructure applications that provide services to many other applications in a datacenter may receive a large number of policy requests from other applications.

You can reduce the volume of policy requests by creating auto-pilot rules to automatically accept or reject future matching policy requests.



Note Auto-pilot rules do not apply to existing policy requests. They affect only future policy requests.

Automatically accept or reject policy requests using Auto-Pilot Rules

Configure auto-pilot rules to automatically accept or reject policy requests between a specified consumer-provider pair, on specified ports. Auto-pilot rules can be broad (scope-to-scope), or apply only to a subset of workloads within each scope (as configured by inventory filters. You can use an inventory filter for the consumer, for the provider, or for each.)

1. If you want your auto-pilot rule to apply to a subset of workloads within a scope rather than to the entire scope:

Create an inventory filter in the relevant scope(s) to group the workloads. Be sure the **Restrict Query to Ownership Scope** option is selected in each inventory filter, to ensure that the filter only includes workloads that are members of the scope.

2. Choose **Defend > Segmentation**.
3. Click the primary workspace of the consumer scope for which you want to automatically accept or reject policy requests related to a specific provider.
4. Click **Manage Policies**.
5. Click **Provided Services**.
6. If you are creating this rule for an inventory filter, perform the following steps for the desired inventory filter (inventory filters are identified by an orange icon.)
Otherwise perform these steps for the scope (scopes are identified by a blue icon.)
Make sure you are clicking in the correct place.
7. Click **No Auto-Pilot Rules** or **auto-pilot rules**, whichever is displayed.
8. Click **New Auto-Pilot Rule**.
9. Configure the auto-pilot rule. Select the scope or inventory filter that represents the provider.
10. Click **OK**.

Example Auto-Pilot Rule

In the example below, we create a new auto-pilot rule to reject TCP policy requests in port range 1-200 from any consumer contained in Tetratation:Adhoc to the provider service Tetratation

Figure 49: Creating/Updating Auto-pilot rules

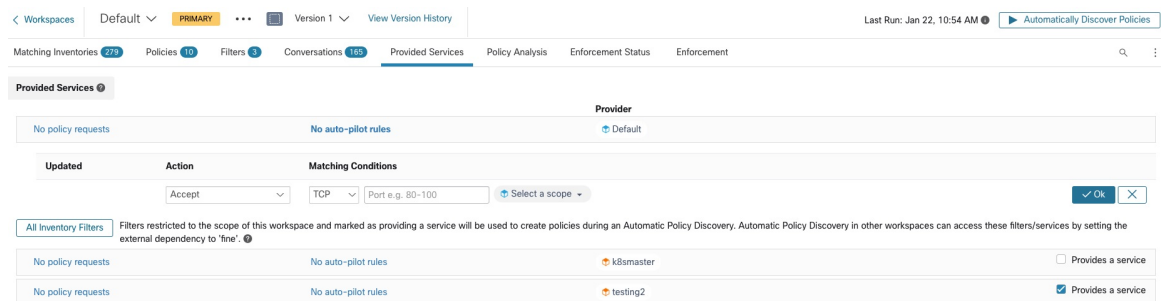

Then we create a new policy in the workspace for the *FrontEnd App* on TCP port 23. Since the policy is a match for the auto-pilot rule, it will be automatically rejected. The status and reason for policy rejection is indicated on the tooltip next to the rejected policy.

Figure 50: Policy automatically getting rejected by Auto-pilot rule

View a count of policies recently created by auto-pilot rules

To view the number of policies created in a workspace by auto-pilot rules since live policy analysis was last initiated (or re-initiated) for the workspace:

Navigate to the Provided Services page for the relevant primary workspace and look for the count of “Auto Created” policies.

Auto Accept Policy Connectors

You can set this option as the default policy discovery configuration, or set it in the automatic policy discovery advanced options for each workspace.

The **Auto accept outgoing policy connectors** option on the automatic policy discovery configuration page allows you to automatically accept any policy requests created as part of automatic policy discovery.

If this option is enabled in Default automatic policy discovery config, policy requests created manually or by importing a workspace will be automatically accepted as well.



Note This option is only available for root scope owners or Site Admins.

Figure 51: The Auto accept outgoing policy connectors option

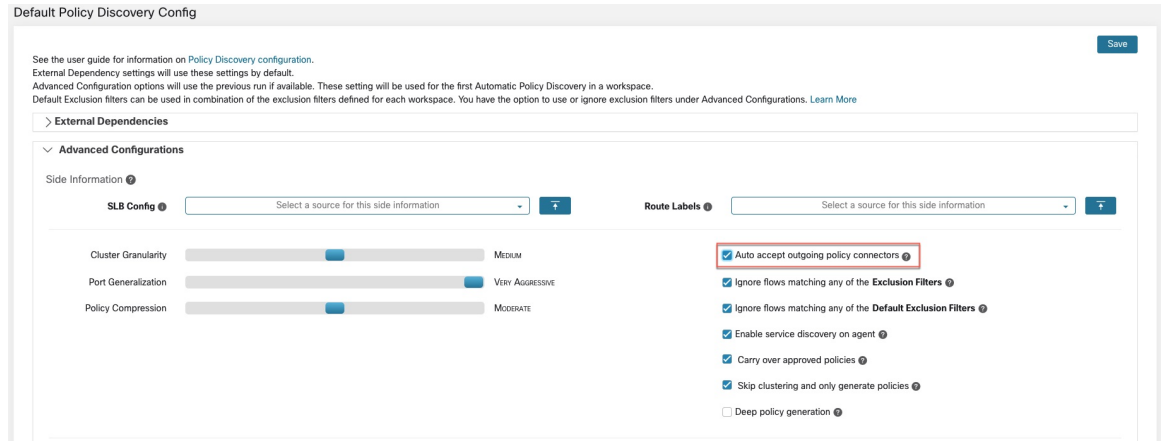

After this option is set, any policy request created in any workspace the root scope or in the applicable workspace will be automatically accepted.

Figure 52: Policy is automatically accepted by Auto accept policy connectors

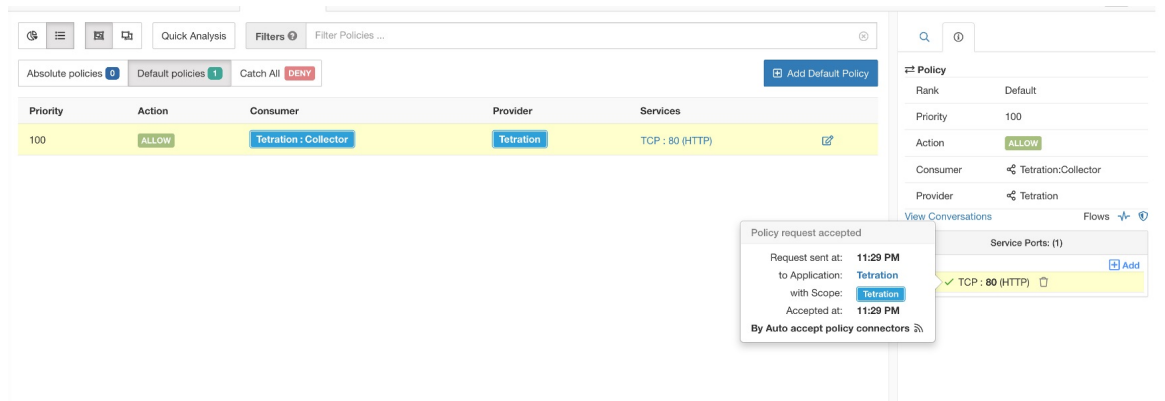

Resolved Policy Requests

If all conditions for creating a policy request are met, but there is already an existing matching policy on the provider application's workspace, the policy created on the consumer application's workspace will be marked as resolved indicating that the provider application's workspace is already allowing the traffic through the requested port.

Figure 53: Policy status shown as Resolved

The screenshot shows the Tetratio console interface. At the top, there are navigation icons, a 'Quick Analysis' button, and a 'Filters' dropdown. Below this, there are statistics for 'Absolute policies' (0) and 'Default policies' (166), along with a 'Catch All DENY' button and an 'Add Default Policy' button. The main area is a table of policies with columns for Priority, Action, Consumer, Provider, and Services. A tooltip is visible over one of the policies, showing 'Policy request resolved' with details: 'Request sent at: 2:19 PM', 'to Application: Tetratio Workspace', 'with Scope: Tetratio', and 'Resolved at: 2:19 PM'. On the right side, there is a 'Policy' sidebar showing details like Rank (Default), Priority (100), Action (ALLOW), Consumer (Tetration:FrontEnd), and Provider (Tetration). Below the sidebar, there are options for 'View Conversations', 'Flows', and 'Service Ports (2)' with 'Delete All' and 'Add' buttons.

Priority	Action	Consumer	Provider	Services
100	ALLOW	Tetration : FrontEnd	Tetration	TCP : 22 (SSH) ... 1 more
100	ALLOW	appServer-*	Tetration	ICMP ... 35 more
100	ALLOW	mongodb*	Tetration	UDP : 53 (DNS) ... 7 more
100	ALLOW	redis-*	Tetration	ICMP ... 6 more
100	ALLOW	elasticsearch-*	Tetration	UDP : 53 (DNS) ... 7 more
100	ALLOW	Tetration	Tetration : FrontEnd	TCP : 22 (SSH) ... 1 more
100	ALLOW	4.4.2.5	Tetration : FrontEnd	TCP : 5000 ... 11 more
100	ALLOW	1.1.1.6*	Tetration : FrontEnd	TCP : 6000 ... 11 more
100	ALLOW	1.1.1.* [2]	Tetration : FrontEnd	UDP : 514

Provided Services

This page is used only for creating policies in which the consumer and provider are in different scopes, and only if you are using the method described in [\(Advanced\) Create Cross-Scope Policies, on page 88](#).

For more information about options on this page, see:

- [Policy Requests, on page 89](#)
- [Auto-pilot Rules, on page 96](#)
- [Create an Inventory Filter and External Dependencies, on page 30](#) (for information about the **Provides a service** option)

To access this page, navigate to a primary workspace, then click **Manage Policies**, then click **Provided Services**.

Troubleshoot Cross-Scope Policies

If cross-scope policies were created using the method described in [\(Advanced\) Create Cross-Scope Policies, on page 88](#), the primary workspaces for the consumer and provider workloads must each have a policy that allows the traffic. Ensure that the required policies exist in both workspaces.

No notification is given if one of the policies is deleted or modified.

If the policy pair was generated during policy discovery, see information about approving policies to protect them from subsequent discovery runs. See [Approve Policies, on page 46](#).

Verify that other requirements are still being met, as listed in [\(Advanced\) Create Cross-Scope Policies, on page 88](#).

Both consumer and provider workspaces that have the required policies must be enforced.

Useful tools for cross-scope policies

- Use the **External?** filter option to find policies in which the provider is in a different scope from the scope in which you discovered policies.
- The policy visual view has an option to display external policies. See [Policy Visual Representation, on page 114](#).

If you are using Default Policy Discovery Config

Make sure you have clicked **Save** on the **Default Policy Discovery Config** page after making changes to make default external dependency configurations available to individual workspaces.

Effective Consumer or Effective Provider

The consumer and provider specified in a policy determine:

- The set of workloads with Secure Workload agents that receive the policy.
- The set of IP addresses that are affected by the installed firewall rules.

By default, these are the same.

However, you may need to specify a group of IP addresses in the firewall rules that is different from the IP addresses of the workloads that receive the policy. (See an example below.)

To address this need, you can configure effective consumer and/or effective provider.

Default behavior for consumer and provider

By default, when a Secure Workload agent receives a policy, the firewall rules are specific to that workload. This is best illustrated with the following example:

Consider an ALLOW policy with provider filter specifying 1.1.1.0/24 subnet. When this policy is programmed on a workload with IP address 1.1.1.2, the firewall rules look like the following:

- For incoming traffic firewall rules allow traffic destined to 1.1.1.2 specifically and not to the whole subnet 1.1.1.0/24.
- For outgoing traffic firewall rules allow traffic sourced from 1.1.1.2 specifically and not from the whole subnet 1.1.1.0/24 (to prevent spoofing).

As a corollary, any agent workloads belonging to the workspace that do not have IP address within 1.1.1.0/24 subnet will not receive the above firewall rules.

Example: Effective Consumer or Effective Provider

In this example, suppose you are configuring policies for a fleet of workloads behind a virtual IP (VIP), similar to keepalived or windows failover clustering solutions. You will use effective consumer and /or effective provider to ensure that traffic is not disrupted during a failover event.

Consider a fleet of workloads with IP addresses (*172.21.95.5* and *172.21.95.7*) that provide a service sitting behind a VIP - *6.6.6.6*. This VIP is a floating VIP and only one workload owns the VIP at any point in time. The goal is to program firewall rules on all the workloads in the fleet to allow traffic to *6.6.6.6*.

In this setup, we have a scope and a corresponding workspace that contain a cluster of workloads that represents the fleet (*172.21.95.5* and *172.21.95.7*) as well as the VIP (*6.6.6.6*).

Figure 54: Scopes including VIP and cluster of workloads

Name	Query	Ability	Total Children	Actions
WinClients	Address = 172.21.95.1 or Address = 172.21.95.3	Owner	0	Edit Delete
WinServers	Address = 172.21.95.5 or Address = 172.21.95.7 or Address = 6.6.6.6	Owner	0	Edit Delete

The VIP is exposed in this workspace as a provided service as shown below:

Figure 55: VIP exposed as a provided service

The screenshot shows the 'Provided Services' section of a management console. It displays a table with columns for 'No policy requests', 'No auto-pilot rules', and 'Provider'. A service named 'Tetration' is listed with a 'Test' button and a 'Provides a service' checkbox. A tooltip or modal window is open over the 'Test' button, showing details for the 'Test' filter action, including 'Filter Actions', 'Query', 'Scope', 'Restricted', and 'Provides Service'.

If we were to add a policy from the clients of this service to the service VIP, then (by default) firewall rules allowing traffic to the VIP will only be programmed on the workload that owns the VIP. However, in case of a failover event, it may take some time for the new workload that subsequently owns the service VIP to get the right firewall rules and traffic may be disrupted for a brief while.

Figure 56: Policy allowing traffic from clients to service VIP

The screenshot shows the 'Policies' section of a management console. It displays a table with columns for 'Priority', 'Action', 'Consumer', 'Provider', and 'Protocols And Ports'. A policy with Action 'ALLOW' and Consumer 'bpimweb-idev3-0*' is highlighted. A red box highlights the edit/delete icons in the 'Policy Actions' panel on the right.

Priority	Action	Consumer	Provider	Protocols And Ports
100	ALLOW	bpimweb-idev3-0*	OTHER: rtp1-dcm02n-oama-idev4	TCP : 6021 ...1 more
100	ALLOW	bpim-idev3-0*	OTHER: rcdn9-dcl13n-gen-client-i	TCP : 5222
100	ALLOW	bpim-idev3-*	OTHER: rcdn9-dcl13n-gen-client-i	TCP : 5222
100	ALLOW	bpim-idev3-07.cisco.com	OTHER: rcdn9-dcl13n-gen-client-i	TCP : 5222
100	ALLOW	bpim-idev3-* 2	OTHER: rcdn9-dcl13n-gen-client-i	TCP : 5222
100	ALLOW	bpim-idev3-201.cisco.com	OTHER: rcdn9-dcl13n-gen-client-i	TCP : 5222
100	ALLOW	bpim-idev3-203.cisco.com	OTHER: rcdn9-dcl13n-gen-client-i	TCP : 5222
100	ALLOW	bpimdmg-idev3-0*	OTHER: rcdn9-dcl13n-gen-client-i	TCP : 443 (HTTPS) ...1 more

To address this issue, we configure the Effective Provider (using the procedure below.) Specifically, we set Effective Provider to include the group of workloads where firewall rules allowing traffic to the service VIP need to be programmed – it does not matter if any of these workloads own the VIP or not.

When Effective Provider is set, we can see on the workloads that firewall rules allowing traffic to 6.6.6.6 are programmed even when a workload does not own the VIP. When all workloads backing the service are programmed with these rules, traffic will not be disrupted during a failover event because the new primary workload (that owns the VIP) will have the necessary firewall rules programmed.

Figure 57: Firewall rules on the host allowing traffic to service VIP

```

$
$ hostname -I | awk '{print $1}' IP Address of
172.21.95.7 the server
$ part of cluster
$
$ sudo iptables -n --list TA_INPUT ← Ingress rules
Chain TA_INPUT (1 references)
target prot opt source destination
ACCEPT tcp -- 0.0.0.0/0 0.0.0.0/0 match-set ta_6c6b4133313438ff5429ca8c14b6 src match-set ta_ac2618d307e4e7dbb76b96c0df3f dst mul
tiport dports 1443 ctstate NEW,ESTABLISHED /* PolicyId=DEFAULT:100:ALLOW:5ed53fe8497d4f26444d50b3:5ed5435b497d4f26414d50b1:6 */
RETURN all -- 0.0.0.0/0 0.0.0.0/0
$
$ sudo iptables -n --list TA_OUTPUT ← Egress rules
Chain TA_OUTPUT (1 references)
target prot opt source destination
ACCEPT tcp -- 0.0.0.0/0 0.0.0.0/0 match-set ta_ac2618d307e4e7dbb76b96c0df3f src match-set ta_6c6b4133313438ff5429ca8c14b6 dst mul
tiport sports 1443 ctstate ESTABLISHED /* PolicyId=DEFAULT:100:ALLOW:5ed53fe8497d4f26444d50b3:5ed5435b497d4f26414d50b1:6 */
RETURN all -- 0.0.0.0/0 0.0.0.0/0
$
$ sudo ipset list ta_ac2618d307e4e7dbb76b96c0df3f
Name: ta_ac2618d307e4e7dbb76b96c0df3f
Type: hash:net
Revision: 3
Header: family inet hashsize 1024 maxelem 65536
Size in memory: 16816
References: 2
Members:
6.6.6.6 ← VIP
$ sudo ipset list ta_6c6b4133313438ff5429ca8c14b6
Name: ta_6c6b4133313438ff5429ca8c14b6
Type: hash:net
Revision: 3
Header: family inet hashsize 1024 maxelem 65536
Size in memory: 16848
References: 2
Members:
172.21.95.1
172.21.95.3 ← Client IPs
$

```

How to Configure Effective Consumer or Effective Provider

1. Click the policy to edit.
2. Click the Edit button at the top right side of the policy to go to advanced policy options.
3. Click **Effective Consumer** or **Effective Provider**.
4. Specify the desired addresses.
5. You may need to specify addresses for both effective consumer and effective provider.

About Deleting Policies



Important

Before you delete a policy, check to be sure it is not one of a pair of policies required when consumer and provider are in different scopes.

To determine this: Click the link for the policy in the Protocols and Ports column. In the panel that opens on the right side of the page, look at the Protocols and Ports section. Policies created by accepting a cross-scope policy request are indicated by a plus sign beside the port and protocol:

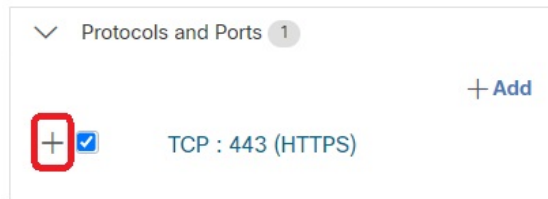

Click the plus sign to see the creator of the cross-scope policy and a link to the corresponding consumer policy.



Note

Policies suggested by automatic policy discovery that have not been approved may not be present after a subsequent policy discovery run, if the traffic flows that produced them are not seen during the subsequent run. To preserve suggested policies, see [Approve Policies, on page 46](#).

Review and Analyze Policies

It is essential that you ensure that your policies will have the intended effects (and not have any unintended effects) before you enforce them.

Review Automatically Discovered Policies

Review policy discovery results on the Policies page of the workspace in which you discovered policies.

Start your review here

We recommend that you start by checking to see if policies address each of the following areas, in this suggested order:

- Critical, common ports
- Internet-facing traffic
- Traffic between different applications (These flows may involve workloads in different scopes)
- Traffic within the same application (These flows are likely to involve workloads in the same scope)

Helpful tools for reviewing policies

- To make this effort more manageable, filter and sort the policies so you can review related policies as a group.
 - Click table headings to sort the columns, for example by consumer, provider, or port/protocol.
 - Use the filter at the top of the policies list to view specific subsets.
 - To see a list of properties that you can filter on, click the (i) button in the Filter Policies box.

- Look at the graphical representation of the generated policies:

Click the Policy Visual View button ()

For more information, see [Policy Visual Representation, on page 114](#).

- To search or filter the rows based on ports, click the **Ungrouped** button.
- By default, the policies are grouped by consumer/provider/action. To return to this view, click the **Grouped** button.
- Use the **External?** filter option to find policies in which the provider is in a different scope from the scope in which you discovered policies.
 - Create policies for this traffic using one of the methods described in [When Consumer and Provider Are In Different Scopes: Policy Options, on page 87](#).
- Look at the confidence level of the generated policies. See [Address Low-Confidence Policies, on page 106](#).
- Look at the Workload Profile for detailed information about a workload. Click the IP address, then click **View Workload Profile** in the pane on the right.
- To view the traffic flows that were used to produce a particular policy, click the value in the **Protocols and Ports** column for that policy, then click **View Conversations** in the side panel that opens.
 - See [Conversations, on page 151](#) for more information.
 - If needed, you can drill down further by clicking **Flow Search** to view the flows for a conversation.

Other things to do and check

- Identify unknown IP addresses (such as failover or other floating IPs) and tag them with labels so you know what they are.
 - You may find helpful details on the Inventory Profile page. Click the IP address, then click **View Inventory Profile** in the pane on the right.
- Look for anything that is obviously not desirable or does not make sense.
- Group workloads using inventory filters so a single policy can address multiple workloads. See [Create an Inventory Filter](#).
- Investigate and contact other network administrators as needed to understand the need for the policies you see.
- See the topics under [Address Policy Complexities, on page 81](#), which can involve manual and approved policies as well as automatically discovered policies.

- In general, it is recommended that the maximum number of policies in a scope is not larger than about 500. If you have many more than this, see if you can consolidate similar policies or consider splitting the scope.
- As you review, approve any policies that you know are correct as-is to preserve them in future discovery runs.

Address Low-Confidence Policies

After automatic policy discovery, confidence ratings indicate the accuracy and appropriateness of each discovered policy for each service (port and protocol) specified in the policy.

To identify low-confidence discovered policies:

1. Navigate to the applicable scope and workspace and click **Manage Policies**.
2. Click the **Policies** tab.
3. Click the **Ungrouped Policy List View** button.
4. Click the **Confidence** column heading to sort the list of policies by confidence level.
5. Click the value in the **Protocols and Ports** column to open a panel on the right side of the window.
6. In the **Protocols and Ports** section, the color of each **C** indicates the confidence for each service (port and protocol) specified in the policy.
To interpret the confidence level, hover over the **C**.
7. Look for low-confidence indicators for any services in the list.
8. If applicable, delete or edit unwanted policies, or add additional policies.

To view the confidence levels for a particular policy:

1. In the Policies tab, click the value in the **Protocols and Ports** column for that policy.
The Policy Side View panel opens at the right side of the window.
2. In the **Protocols and Ports** section, the color of each **C** indicates the confidence for each service (port and protocol) specified in the policy.
To interpret the confidence level, hover over the **C**.

Flow Direction and Policy Confidence

The accuracy of discovered policies depends on correct identification of the flow direction. If flow direction is incorrectly identified, the confidence rating of automatic policy discovery results may be reduced. For information about determination of flow direction for the conversation(s) analyzed for the creation of the policy, see [Client Server Classification](#).

Application Views



Note App View is deprecated and removed in the next Cisco Secure Workload release

Application Views play a central role in automatic policy discovery and help bridge the gap between the network and application teams. In other words, application views provide a bottom up way of exploring automatic policy discovery results with the goal of gaining insight into multitier datacenter applications like a web application. There could be thousands of such applications running in a datacenter. The application view helps you to focus on a particular one and share their view with other users.

Similar to automatic policy discovery workflows, the application list view provides a way to create new application views and view the existing ones by clicking on the tabular view.

Figure 58: App View List

Tetration Infrastructure PRIMARY Switch Application

Tetration Infrastructure Version: 2 Conversations: 209K Endpoints: 152 Last Run: Start ADM Run

Mar 26, 3:30 PM

Zones Clusters (27) Policies (358) Provided Services 74 App View (1) Policy Analysis Enforcement

Create New App View

Name	Description	Date created	Last modified
My App View		Apr 6 12:41:33pm	Apr 6 2:53:43pm

Building Application View Layout

Upon creation of a new application view, an empty canvas with the list of nodes (clusters, user-defined filters and Scopes) is presented. You can choose to **pin** certain nodes to the canvas and start exploring their neighbors in the sense of network policies. This page shows an extra tab on the right side panel with the list of all nodes.

Figure 59: App View Empty Canvas

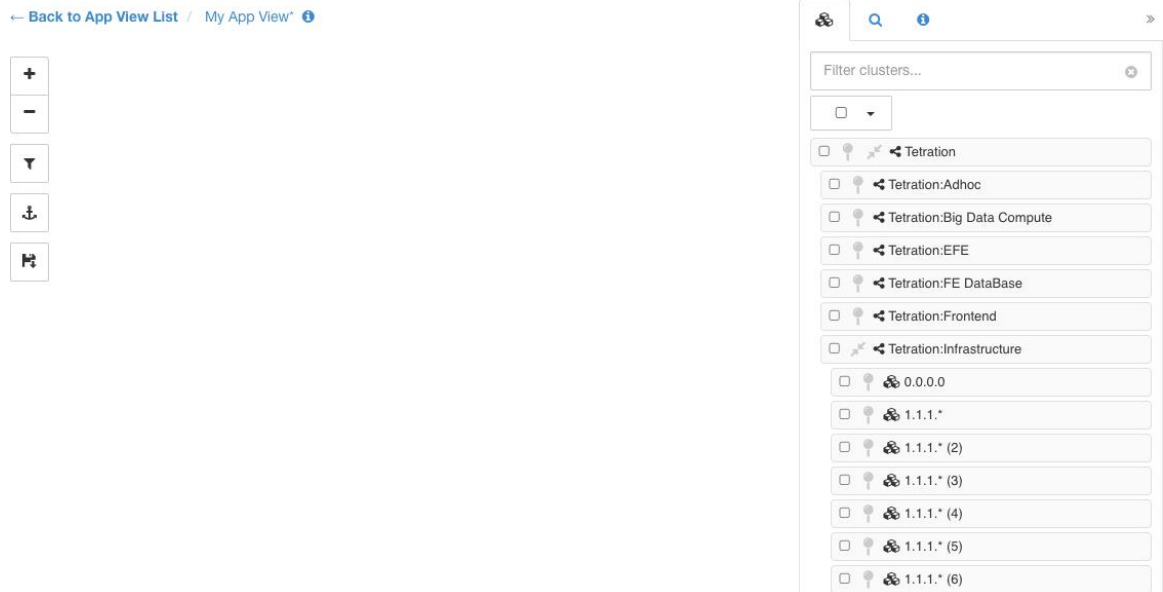

The tools on the left provide the ability to:

- Zoom in
- Zoom out
- Filter visible policies
- Anchor selected node positions
- Save App View state, make a copy or export node/policy data

Adding Nodes to Application View

Click on the **pin** button next to each item to add that node to the canvas, and double-click on any node on the canvas to **show** or **hide** its neighbors.

Figure 60: App View Pinning and Expanding Node

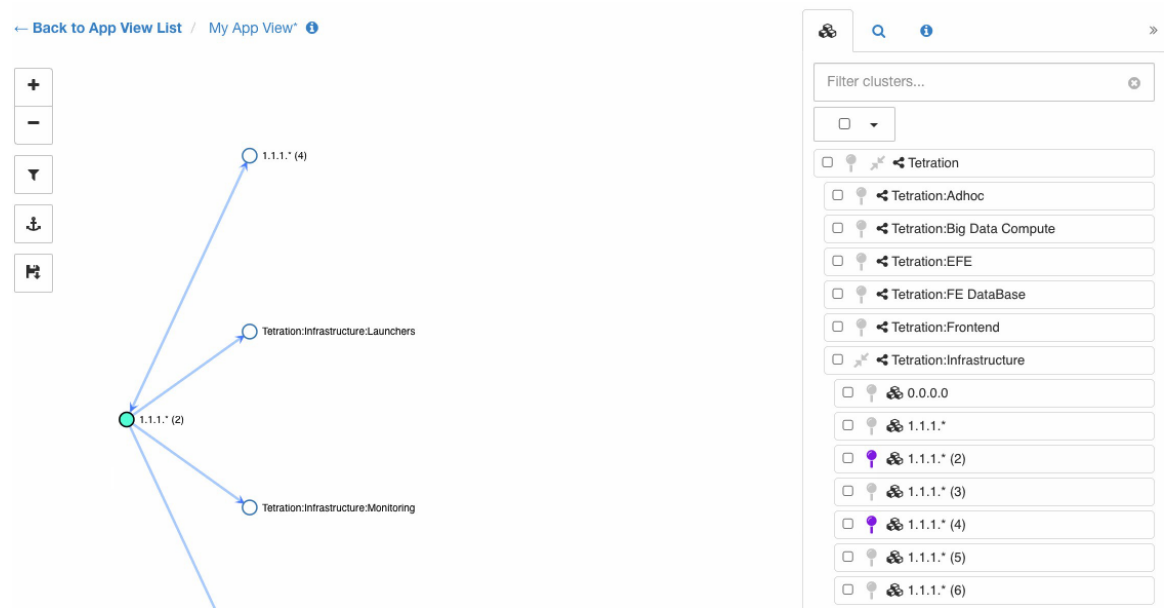

Adjusting Application View Layout



Note An edge between two nodes represents the set of network policies between the nodes. If one or more of the conversations between the nodes is going through a load balancer (defined as part of side information uploaded under advanced automatic policy discovery config), a load balancer icon is shown over the edge. More information can be seen by hovering or clicking over the presented elements.

We can move the nodes to any position to achieve the desired layout. In that case the you will be honored and an anchor icon appears on the node. To reset the position of the **anchored** node, click on the **anchor** button on the toolbar.

The following figure shows a fully expanded graph of our example multi-tier app.

Figure 61: App View Layout with Anchored Nodes

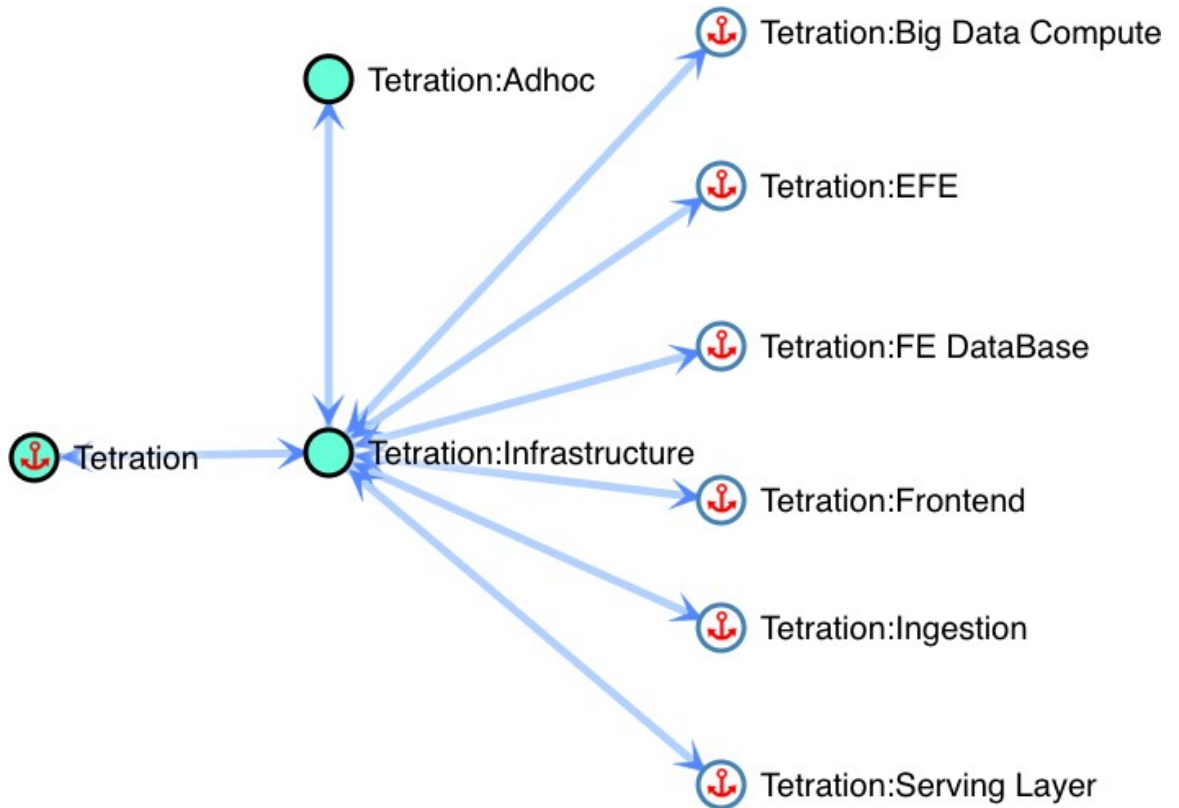

Example Multi-Tier Application

Click on the save button of the toolbar to save the current layout. This way other users can view the exact same layout of this particular workspace.



Note You can move multiple selected nodes all at once by holding the **SHIFT** key and dragging any of the selected nodes.

Expanding and Collapsing Scopes

Expand or **collapse** Scopes using the double-arrow icons within App View. When collapsing, all descendant nodes and their policies will be rolled up into the collapsed Scope. This may create edges between the collapsed Scope and other nodes, even if there isn't a policy directly connecting the two nodes because one of the collapsed Scope's children has a policy to that node. The rolled-up edges are reflected in the App View export, along with aggregated port list.

In new App Views, all Scopes are expanded by default.

Figure 62: App View Collapsing Scopes

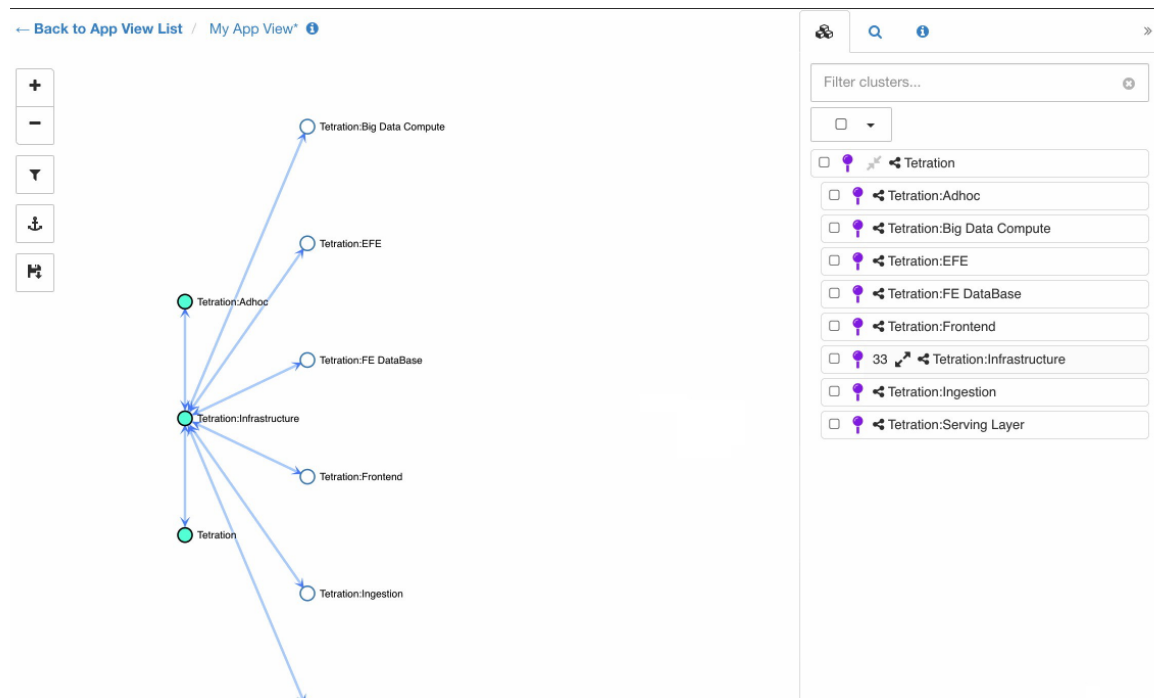

Policy Chord View



Note Policy Chord View is deprecated and will be removed in the next Cisco Secure Workload release.

Policy chord view provides a top-level graph view of all *ALLOW* policies in one chord chart with various ways to drill down and filter information.

The following figure shows some of the basic concepts of the policy chord chart. The arcs around the circumference of the chart represent clusters or partitions (group of clusters). Expanded partitions show up as a glow around all of the member clusters.

The chords represent a group of all policy intents between a pair of clusters, filters, or scopes. If a chord starts or ends at a partition, it represents the union of all policies from all the clusters inside that partition.

The chord represents bidirectional set of policies. The thickness of a chord on each side is proportional to the number of services that are consumed by the corresponding cluster or partition.

Tips:

- You can use the edit clusters view (see [Clusters](#)) to get a quick tabular view of clusters and their content. Use the policy view when you want to see the communications (the edges or policies).

Notes:

- Double-click on a partition arc to expand/collapse that partition.

- Single click on any of the chart elements, that is, partition, cluster, or policy selects or deselects that element. Moreover, the side panel gets updated with context information about the latest clicked element.
- Double-click on the canvas outside the chart to reset the chart to its original state.

Figure 63: Policy Chord View

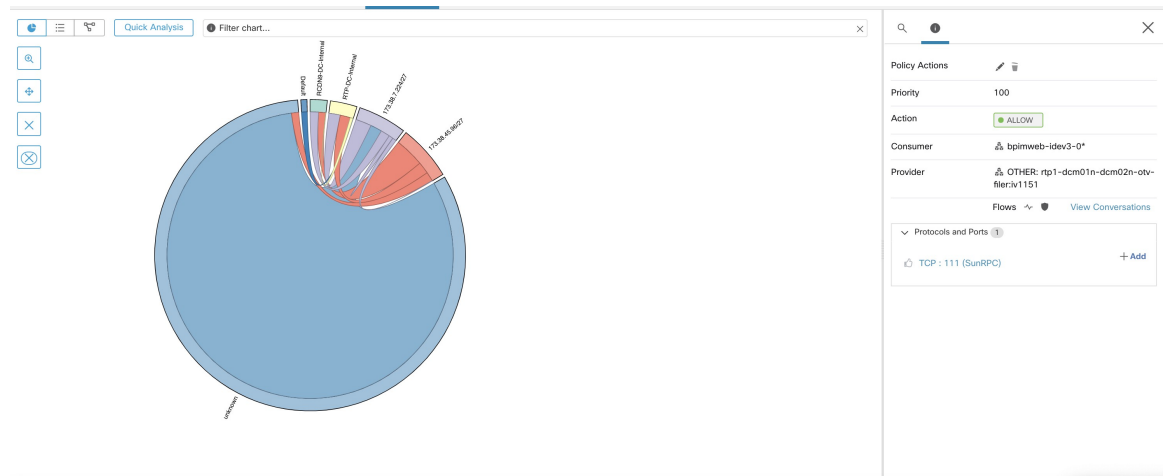

Chord Chart Toolbar

The set of controls or the toolbar on the top-left corner of the policy view page is designed to simplify interaction with large and complex charts by allowing the user to focus on a subset of the clusters and policies.

The **Filter** button helps filter out the policies by port and protocol. Green colored button indicates that the filter is active. Simply click **disable** to remove any filtering. See example below:

Figure 64: Chord Chart Toolbar

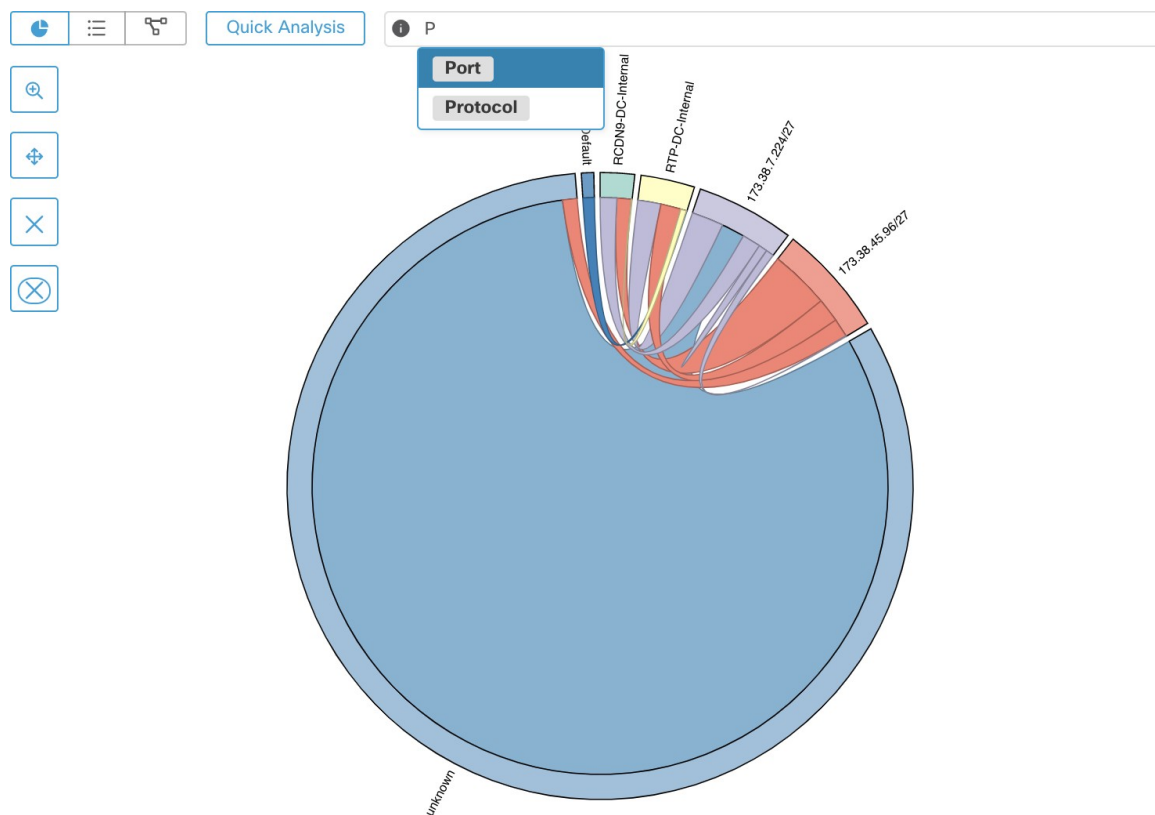

The **Show Cluster Detail** button helps drill down into the content of selected clusters and observe conversations/connections of the hosts inside the clusters.



Note At least one cluster (not partition) needs to be selected to have the ability to drill down into a cluster. The rest of the controls as their names indicate help remove unwanted clusters or policies or limit the chart to only one or more neighbors of a cluster.

Troubleshoot Automatic Policy Discovery Results

If automatic policy discovery results are not what you expect, check the following:

Extend the selected time range to include more data

Extend the time window to include more data and to capture events that happen infrequently. For example, if an application generates a complex quarterly report using data drawn from several provider applications, be sure to include a time range that includes that traffic.

Avoid data gathered before certain changes

If the scope definition has changed, or data gathered before a certain time has become invalid for some other reason, be sure your time range does NOT include data before that point.

Exclude misleading traffic flows

Exclusion filters may need to be configured or modified.

There are multiple places exclusion filters can be configured, and multiple places they can be enabled or disabled. Check each location:

- Check the exclusion filters configured for the workspace.
- Check the default exclusion filters configured at the bottom of the Default Policy Discovery Config page.
- Check which exclusion filters are enabled in the Advanced Configurations section in the workspace's settings for automatic policy discovery.
- Check which exclusion filters are enabled in Advanced Configurations section on the Default Policy Discovery Config page.
- If you are using Default Exclusion Filters, make sure you have clicked **Save** on the **Default Policy Discovery Config** page to make those configurations available to individual workspaces.

For details, see [Exclusion Filters, on page 27](#) and subtopics.

Troubleshoot Policies in which Consumer and Provider Are in Different Scopes

See [Troubleshoot Cross-Scope Policies, on page 100](#).

Check Status of Approved Policies

See [Troubleshoot Approved Policies, on page 47](#).

Policy Visual Representation

Policy visual representation provides a graphical view of the policies.

To navigate to the policy visual representation page: On the Policies page, click the graph icon () to the right of the list icon.

Policy View Elements

The visual elements on the policy view are:

This Element	Represents This
A blue, orange, or purple icon	A node (the consumer or provider of a policy)
Blue icon	A scope
Orange icon	An inventory filter
Purple icon	A cluster
Line connecting two icons	One or more policies.

Policy View Options

To	Do This
View the list of workloads included in a consumer or provider node	Double-click the node's icon.
View policy specifics such as services (ports), action (Allow/Deny) and protocol between a consumer and provider	Double-click the line connecting them. Details appear in the pane on the right.
View the policies entering and leaving a node	Click the icon.
View only the policies between workloads within the scope	Click the Internal button.
View only the policies in which the provider is in a different scope from the consumer	Click the External button.
Use advanced filtering options	Click the (i) button to the left of the filter text input box to see the options, then enter filter criteria.

Figure 65: Filtering policies in graphical view

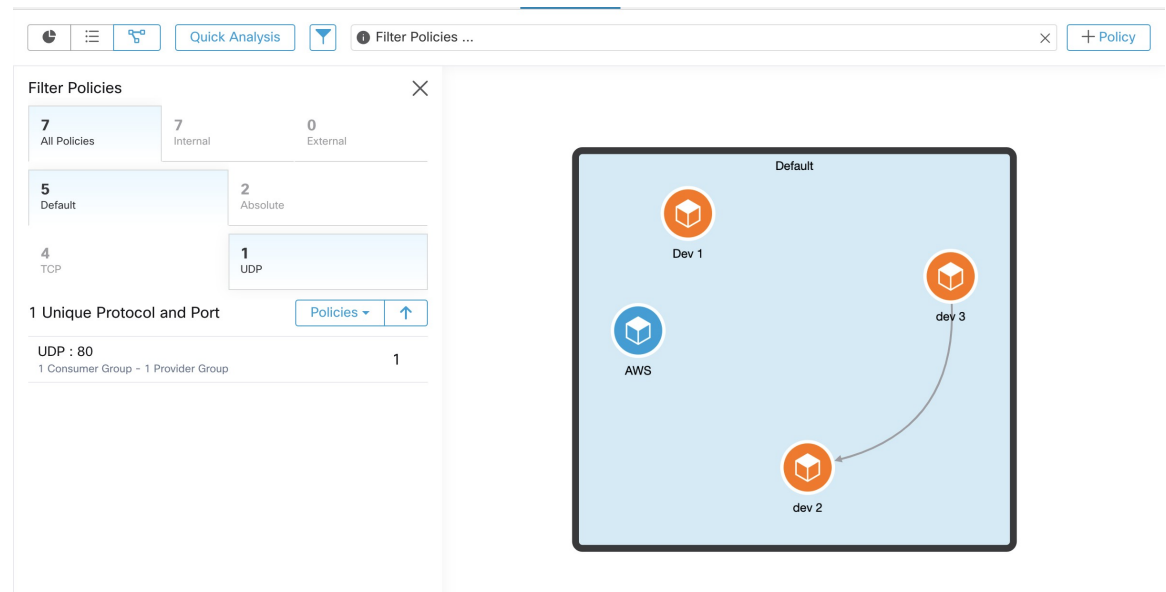

Add a Policy (Policy View Page)

To create a policy, hover over the consumer until you see a “+” sign and then hold and drag the policy onto the provider. To create an Absolute policy, toggle the Absolute checkbox in the modal. Otherwise, the policy is created as a Default policy. Policies can also be managed by clicking a line and selecting a policy from the pop-up list. Policies will be displayed in the sidebar.

Figure 66: Policy creation in graphical view

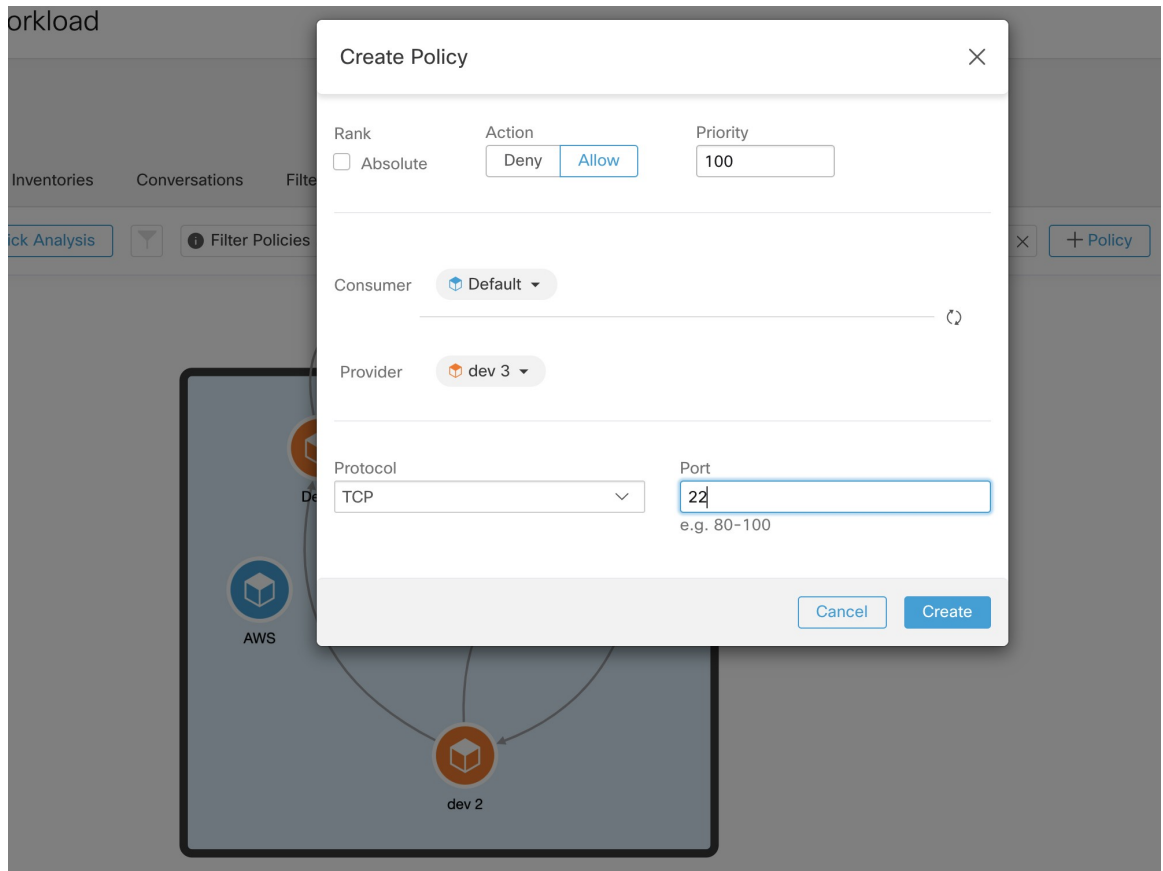

Quick Analysis

Quick analysis enables testing a hypothetical flow against all the policies in the current workspace as well as all other relevant policies from other workspaces. Quick analysis facilitates debugging and experimentation with different security policies, without the need to run live policy analysis for the workspace.



Restriction

- You can run Quick Analysis only on primary workspaces.
- Quick Analysis is not currently supported on flows from Kubernetes services.

Click on the **Run Quick Analysis** tab on the right navigation pane to view the dialog.

Figure 67: Quick Analysis Tab

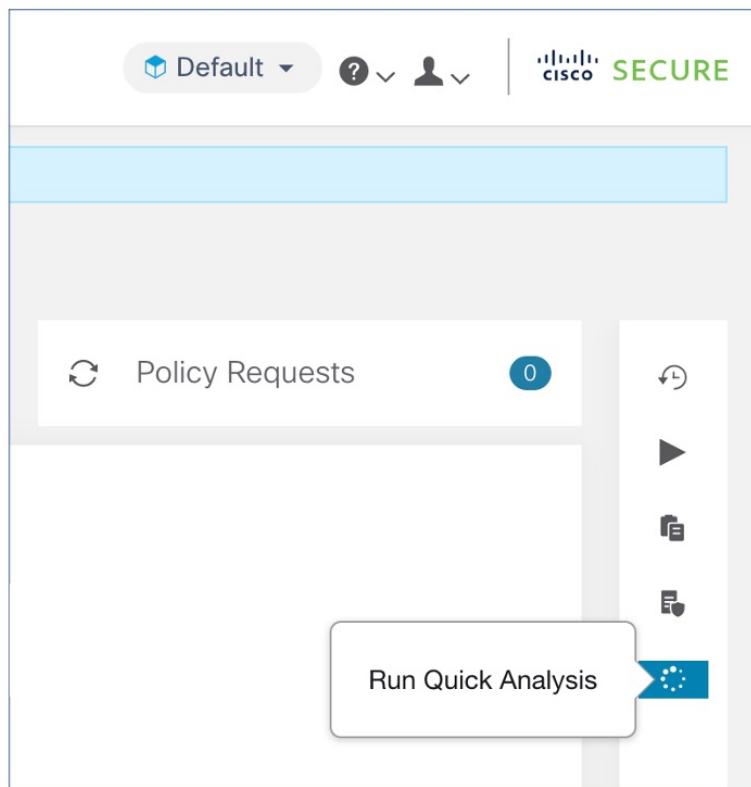

Enter the Consumer (client) IP, Provider (server) IP, port and protocol for the hypothetical flow, then click on **Find Matching Policies** button.

A policy decision will be shown indicating whether the hypothetical flow would be allowed or denied given the policy definitions in the latest version of the workspace and all other policies from relevant workspaces that are already pushed for live policy analysis.

At the bottom of the dialog, we show the matching outbound and inbound policies separately, and in their globally sorted order. It is only the very first row on either side that has any effect. For a connection to successfully get established, we need both the top outbound rule on consumer and the top inbound rule on the provider side to be ALLOW rules.

Showing all other matching policies in their order, provides a valuable debugging tool to help sort out issues in policy definitions when a certain policy seems to not be taking any effect. You can add, update, or delete policies from the workspace, and repeat the analysis immediately without the need to run live policy analysis on the workspaces.

Figure 68: Quick Policy Analysis

Quick Hypothetical Flow Analysis

Match this Hypothetical Flow against

Analyzed Policies Enforced Policies

Replace this application's policies with

Version: v1

Consumer Address: 173.38.45.96

Provider Address: RCON9-DC-Internal

Protocol: TCP

Provider Port: 80

Policy Decision: ✔ ALLOW

Find matching policies

Consumer Outbound Policies	Provider Inbound Policies
OTHER: unknown → bpimdmgr-idev3-0* ALLOW TCP : 22 Default ▲ Tetration [v1] Default	OTHER: unknown → bpimdmgr-idev3-0* ALLOW TCP : 22 Default ▲ Tetration [v1] Default
OTHER: unknown → bpimdmgr-idev3-0* ALLOW TCP : 22 Default ▲ Tetration [v1] Default	OTHER: unknown → bpimdmgr-idev3-0* ALLOW TCP : 22 Default ▲ Tetration [v1] Default

Close

Live Policy Analysis

After you have reviewed and approved the set of network security policies generated by automatic policy discovery, and before you enforce the policies, you should use live policy analysis to observe how the policies would affect actual traffic on your network.

Some questions that live policy analysis can help you answer:

- What would be the impact on this scope's application(s) if the policies in this workspace are enforced now?
- Could we have prevented a previously known security attack/risk by enforcing the new set of policies?
See [Run Policy Experiments to Test Current Policies Against Past Traffic](#), on page 125.
- Are our policies working the way we expect them to?

You should run policy analysis on any workspace that has policies. Because workloads in any particular scope can be affected by policies in other scopes, you should not run policy analysis only for a single scope before enforcing policy for that scope. Consider analyzing policies for all scopes that may affect traffic in a particular scope.

For example:

- Policies defined in scopes above this scope in the tree may apply to workloads in this scope.

- If workloads in this scope communicate with workloads in a different scope, policies in that scope may affect these communications. When policy analysis is started in that scope (or latest policies are analyzed after a policy change there), this can affect this scope's policy analysis results.

You should perform policy analysis any time you revise policies, to ensure that changes don't break applications.

Running live policy analysis on a workspace is sometimes referred to as "publishing" a workspace.

Start Live Policy Analysis

Once you have reviewed the policies generated in a workspace by automatic policy discovery, and you believe that they are as you want them, you can start policy analysis.

Before you begin



Important

Live analysis includes the effects of policies in other workspaces that are also running live analysis. If you have enabled enforcement on any workspace, but analysis is not running on that workspace or the enforced version of the policies is not the same as the analyzed version of the policies, your live analysis results for this workspace may not be accurate.

Step 1 Toggle the workspace to **Primary** by clicking ******* to the right of "Secondary" next to the workspace name in the header.

Step 2 Navigate to the **Policy Analysis** tab.

Step 3 Click **Start Policy Analysis** on the right.

Figure 69: Enable Policy Analysis

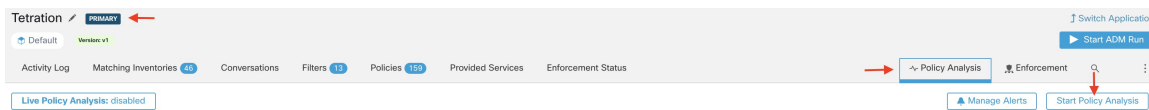

What to do next

- Because policies in other scopes can apply to workloads in this scope, consider simultaneously analyzing policies in other scopes that could affect analysis results in this scope. See [Example: Impact of Policies Analyzed in Other Scopes, on page 121](#).
- If you want to be notified when escaped flows are detected, click **Manage Alerts**.
- Use the tools on the page to filter the data. To see the available filter criteria, click the (i) button in the filter box.
- If you add or change policies after initiating policy analysis, you must re-start analysis in order to include the changes in the analysis. See [After Changing Policies, Analyze Latest Policies, on page 126](#).

Stop Live Policy Analysis

In general, you should let policy analysis continue to run, even after you enforce policies, since the policies in this workspace may affect policy analysis results in other workspaces you are analyzing.

To stop live policy analysis:

Click the **Live Policy Analysis: P<number>** button, then click **Disable policy**:

Figure 70: Disable Live Policy Analysis

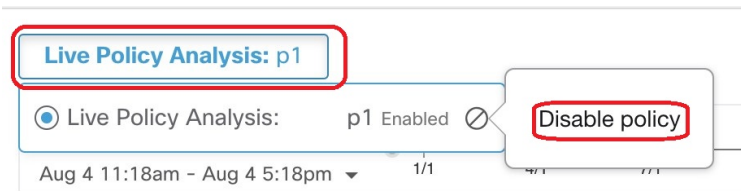

Policy Analysis Results: Understand the Basics

During policy analysis, all flows traveling into, out of, and within the scope associated with the workspace are assigned one of the following results:

- **Permitted:** Flow was allowed by the network, and also by the analyzed policies.
- **Escaped:** Flow was allowed by the network, but should have been dropped according to the analyzed policies.
- **Rejected:** Flow was dropped by the network, and also by the analyzed policies.

Figure 71: Policy Analysis Page

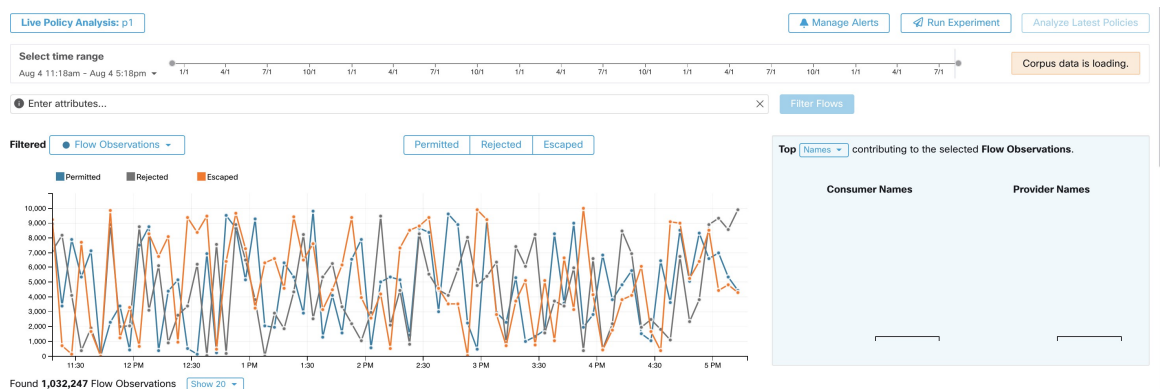

Some things to look at to get oriented:

- You may filter the flow information presented in this page via a faceted filter bar. Clicking the **Filter Flows** button updates all the charts accordingly.
- Hovering on the chart shows the percentage of the aggregate observed flows at that timestamp.
- Clicking on a timestamp reveals a list of all filtered flows in a table below for further analysis.
- You can limit the interactions to one of the three result types by selecting/deselecting the the types at the top of the time series charts.

- The Top N chart on the right shows the top Hostnames, Addresses, Ports, etc. contributing to the data shown in the timeseries chart on the left.

You can limit the timeseries chart to just escaped flows and select “Ports” in the Top N chart to see the top ports contributing to escaped flows.

Example: Impact of Policies Analyzed in Other Scopes

In the following example, there are permitted flows up to about 12pm. At that time, policy analysis was started in a workspace associated with a different scope, affecting traffic with workloads in this scope and causing flows to be marked as escaped. (You know that this change did not result from policy changes newly analyzed in this workspace, because this would have created a label flag.)

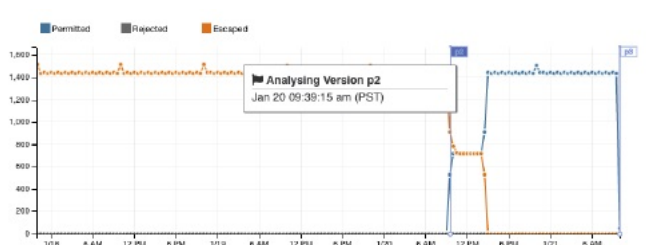

Analysis without Policies

The flows into, out of, and within the scope associated with the workspace may be affected by policies in other workspaces that are being analyzed. If live policy analysis is not enabled on this workspace, the flows will be marked with those of the other workspaces in the system that do have live policy analysis enabled.



Note If no workspaces are running live policy analysis, the timeseries chart will be empty.

Policy Analysis Details

Flow Disposition

In policy live analysis, to decide on whether a flow is **Permitted**, **Escaped**, or **Rejected**, we have to first determine the **Disposition** of the flow from the network perspective. Each flow will receive an **ALLOWED**, **DROPPED** or **PENDING** disposition, based on the signals and observations given by Secure Workload agents. There are a number of scenarios based on the agent configurations along the path of the flow and the flow types.

First, regardless of flow types, if any agent along the path of a flow reports that the flow is **DROPPED**, the flow will receive a **DROPPED** disposition.

When there is no **DROP** reported by any agents along the path of the flow, we consider the case of bidirectional flows and unidirectional flows separately. When bidirectional flows are observed, we look at flows in pairs (forward and reverse) based on their source, destination ports and protocol, and timings. The same cannot be done for unidirectional flows.

For bidirectional flows, if there are agents installed and data plane enabled on both ends, a forward flow will receive an **ALLOWED** disposition if both the source and the destination agent report that the flow is observed. Otherwise, the forward flow will get a **PENDING** disposition. If an agent is installed on either the source or the destination workload, but not both, then the forward flow will received an **ALLOWED** disposition if and

only if the agent observes subsequent reverse flow within a **60**second window. Otherwise a PENDING status will be assigned to the forward flow. The disposition of the reverse part of the bidirectional flow follows the same logic except that now the source and the destination are reversed. For example, if only one side has an agent, whether a reverse flow disposition is PENDING or ALLOWED depends on the observation and timing of its subsequent forward flow based on the same logic.

Note that we assume firewalls implement silent drop. If a reject message is sent on the *same* flow (e.g. rejecting a TCP SYN with RST + ACK), a reverse flow will be detected, and the previous forward flow will be marked as ALLOWED. However if the reject message is sent on a *different* flow (e.g. rejecting a TCP SYN with an ICMP message), the forward flow will remain as PENDING.

For a unidirectional flow, the flow will be considered DROPPED if it is reported as DROPPED by any agent as in the case of bidirectional flows. However, since there is no matching reverse flow, the flow will have PENDING disposition status if both agents observe the flow.

Violation Types

The flow dispositions are checked against the policies being analyzed to determine the final violation types.

A flow's violation type will be

- **Permitted**, if its disposition is ALLOWED or PENDING, and its deciding policy action is ALLOW,
- **Escaped**, if its disposition is ALLOWED, and its deciding policy action is DENY,
- **Rejected**, if its disposition is DROPPED or PENDING, and its deciding policy action is DENY,

A DROPPED status is assigned only to flows whose relevant agents explicitly report their DROPPED status. When there is no explicit report of dropping for agents, the flow receives PENDING status.

When disposition is PENDING:

- and policy action is DENY, then violation type is set to Rejected.
- and policy action is ALLOW, then violation type is set to Permitted.

For a bidirectional flow, if the policy violation types of forward and reverse part of the flow agree, only a single type is shown in the policy analysis or enforcement analysis page. Otherwise, forward and reverse are shown separately, such as PERMITTED:REJECTED.

Example scenarios:

- Packets are dropped at the source-side enforcement
 - In this case, the source side Secure Workload egress agent will report that the flow is DROPPED.
- Packets leave the source.
 - If there is only an agent on the source side, the flow will be reported as ALLOWED by the egress agent if a reverse packet is also observed by the agent within 60 seconds.
 - If there is a visibility-only agent on both the source and the destination side, the flow will be given a DROPPED disposition status, if and only if the ingress agent reports that the flow is DROPPED. Otherwise, the flow will be reported as ALLOWED.
 - Flow packets are received at the destination, but no reverse traffic.

If there is no destination side agent, the flow will receive a PENDING status. Otherwise, it will be assigned ALLOWED status.

Suggested Steps for Investigating Flows

When drilling into specific flows when examining policy results, the following suggestions and filters may be helpful:

1. Focus on *ESCAPED FLOWS* initially:

Escaped flows require special attention as their actual flow dispositions differ from the intended actions based on the currently analyzed policies. Investigate to ensure that enforcing these policies does not block needed flows and adversely impact your applications.

Click the violation type, such as **Escaped**.

(Later, you can look at rejected and permitted flows as needed.)

Escaped flows can occur for many reasons, including but not limited to:

- Another policy higher in the priority order is taking effect
- The traffic is taking a different path than the route that your policies address, or
- The policy that you expect the traffic to hit is in a workspace that is not being analyzed (if you are looking at escaped flows on the Policy Analysis page) or enforced (if you are looking at escaped flows on the Enforcement page), for example in an ancestor scope or even in a secondary workspace in the same scope.

2. Identify flows that matched the catch-all policy (inbound and outbound) :

It is important to understand what flows are matched to catch-all policies, especially in an allow-list policy model. If these flows are legitimate but do not have explicit allow policies configured for them, you may want to add appropriate explicit policies in the corresponding inbound or outbound scopes. On the other hand, if they are suspicious flows, you want to quickly identify them and further investigate their details.

To focus on these flows, apply filters based on the *catch-all* value of **inbound_policy_rank** or **outbound_policy_rank**, depending whether you are looking at the inbound, outbound or both sides, shown below.

Figure 72: Policy Analysis filtering options for Rank

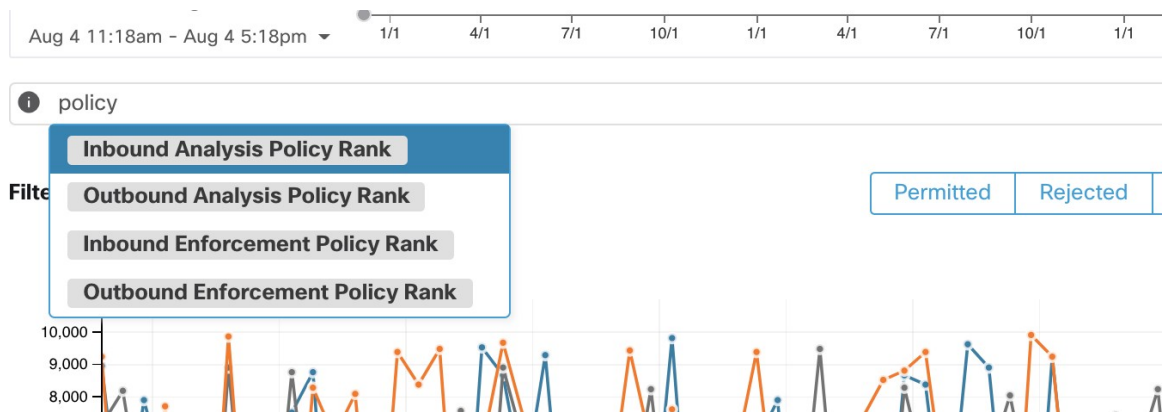

3. Filter out TCP flows with RST: *Fwd flags does not contain RST, Rev flags does not contain RST*

Some escaped TCP flows have RST flags set. These flows are reset by either their consumers or providers. They are essentially unestablished connections without data exchange, but may be reported as **ALLOWED** because the agents see their handshaking packets. Since they do not have established connections to begin

with, they will not be affected when currently analyzed policies are enforced. Filtering out TCP flows that have the RST flag on either side allows you to focus on more meaningful and important escaped flows whose established connection will be blocked by the currently analyzed policies.

4. If most traffic is using IPv4, focus only on IPv4 flows:

Filter using *address type = IPv4, address type != IPv6*. It is also helpful to filter out *link-local* address.

5. Priorize which flows to focus on in the next diagnostic step by identifying the most frequent hostnames, ports, addresses, scopes, etc. involved in the escaped traffic:

Select *Hostname*, *Ports* or *Addresses* from the TopN feature pane. You can usually combine these with other filters to drill down to a particular type of traffic when diagnosing policies.

6. Search flow data for the hostnames, ports, protocols, etc. identified in the previous step

Once you have an idea about the top candidates based on the targeted flows' hostnames, port and etc., you can choose to drill down into the flows by either applying drill-down filters directly from values given in the top N query window, or by manually entering relevant filters into the flow search filters bar. For example, *Consumer Hostname contains {something}, Provider Hostname contains {something}, Provider Port = {some port number}, Protocol = TCP Protocol != ICMP*

7. Check individual flows and quick analysis:

Finally, you can focus on a specific flow to examine its policy result by clicking the table row corresponding to the flow. Pay attention to the policies matched to the flow and the scopes of both the consumer and the provider addresses. If the policy action does not match your intended action, you need to create appropriate policies in workspaces associated with the consumer's and/or the provider's scopes to change the policy action.

The figure below shows an example workflow of narrowing down escaped flows using some of the filtering described above. The search input also supports “,” and “-” for Port, Consumer Address and Provider Address, by translating “-” into range queries.

Figure 73: Policy analysis diagnosis example

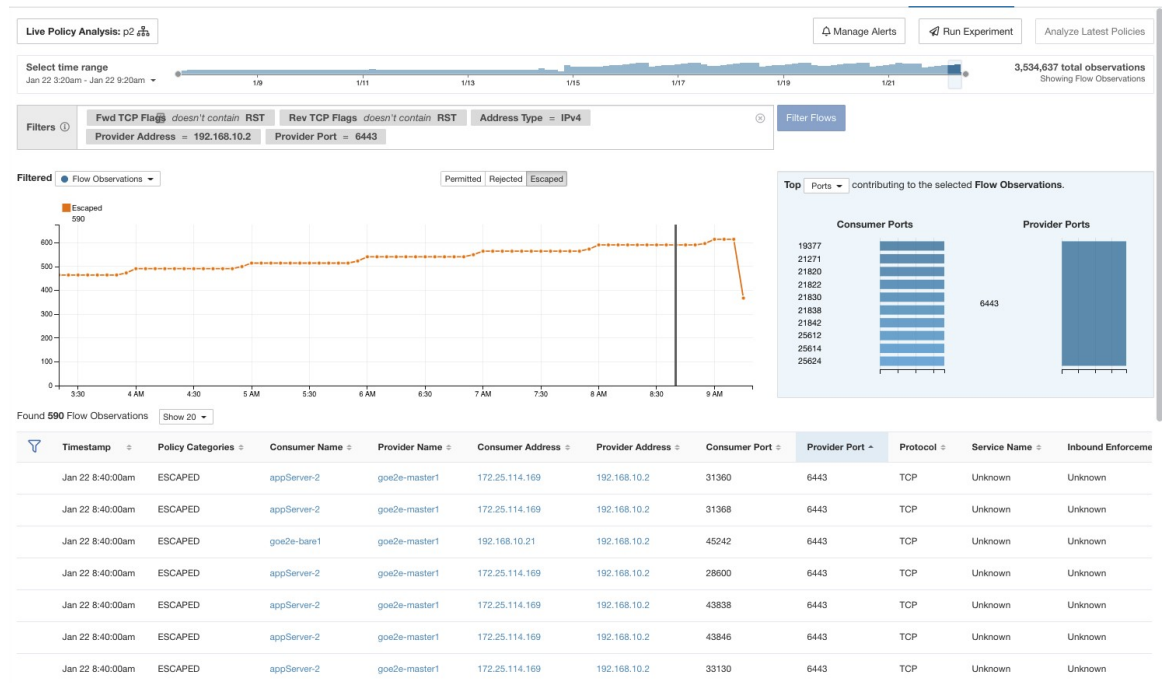

Run Policy Experiments to Test Current Policies Against Past Traffic

If a known attack or other significant short-term traffic pattern occurred in the past, and you want to see how your current policies (or another versioned policy set) would have handled that traffic, you can use the Run Experiments feature.

Before you begin



Tip As an alternative to this procedure, you can run automatic policy discovery again, including the relevant time range, and see what different policies are suggested.

- Step 1** Navigate to the Policy Analysis page of your selected workspace.
- Step 2** From the top of the page, select the policy version to test.
- Step 3** Click the **Run Experiment** button in the right corner of the page.
- Step 4** In the new dialog select a name and a duration for the policy experiment.

After Changing Policies, Analyze Latest Policies

Figure 74: Run Experiment Form

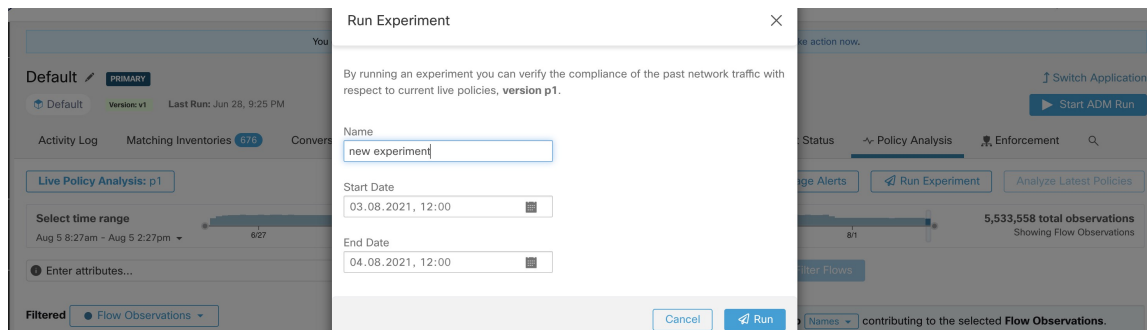

This will start a new policy analysis job which goes back in time and re-analyzes all the flows in the selected duration against the selected versioned policy.

This job may take a few minutes, depending on the selected duration. The progress is shown in the policy selector menu. Once the results are ready to be presented, you should be able to select the policy experiment like any other versioned policy and the time series charts showing different flow categories will be updated accordingly.

Figure 75: View Experiment Status

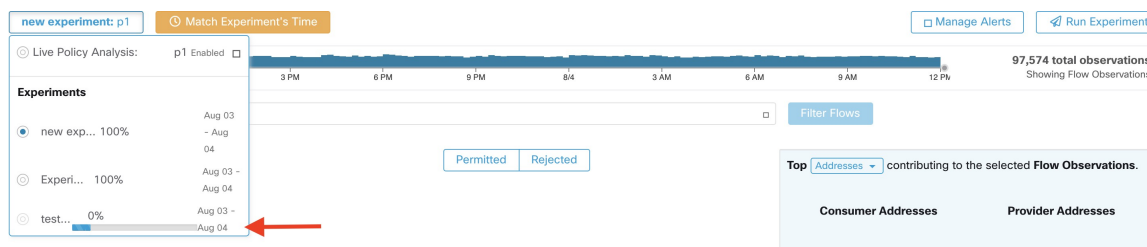

Note If you cannot see any flows when selecting a policy experiment, it might be due to time range mismatch, e.g., the current time range of the charts is the past 1 hour, but the experiment duration is 6 hours in the past. In order to reset the time range to the duration of the experiment, click on the clock icon next to the policy selector.

Figure 76: Match time range

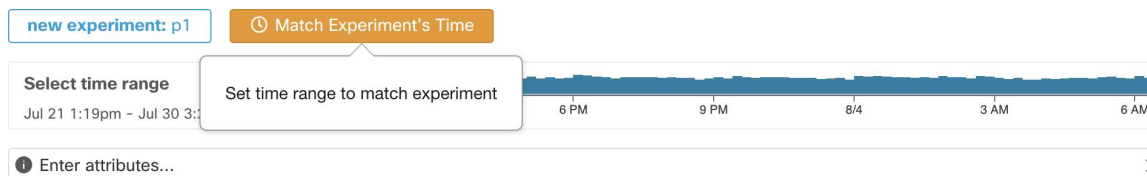

After Changing Policies, Analyze Latest Policies

Policy analysis does not automatically reflect policy changes in the workspace. When you are ready to analyze the current set of policies after making changes, click **Analyze Latest Policies** so policy analysis reflects the changes.

If the policies in the workspace have not changed since policy analysis was last initiated, or if policy analysis is not currently enabled, the Analyze Latest Policies button is not available. If the button is clickable, there are policy changes that have not yet been included in analysis.

See also [View, Compare, and Manage Analyzed Policy Versions](#), on page 127.

Policy Label Flags

On the policy analysis timeseries chart, policy label flags mark the point at which analysis was initiated and at each point analysis was re-initiated to reflect the latest policy and cluster changes.

Click a flag to view the version of the policies associated with that flag:

Figure 77: Policy label flag in timeseries chart

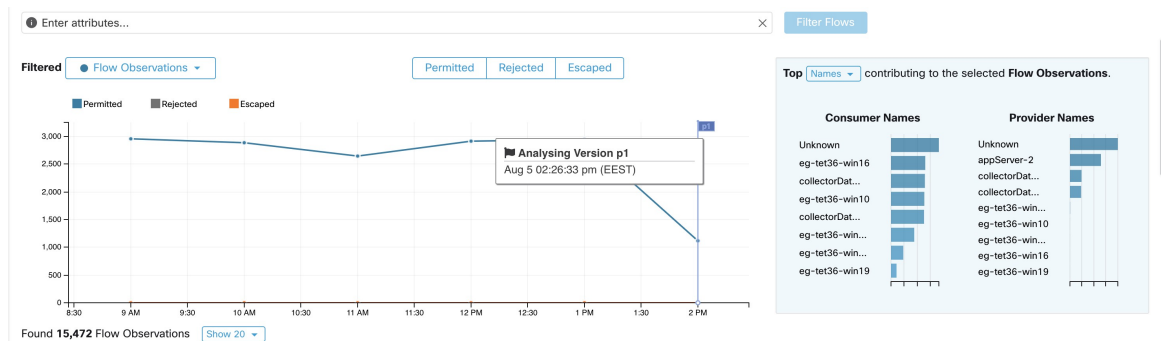

Clicking a policy label flag opens the corresponding version of the Policies page and displays the policies analyzed by that policy analysis version.

View, Compare, and Manage Analyzed Policy Versions

Each time you analyze or re-analyze policies in a workspace after making changes, a new analysis version (p*) is created.

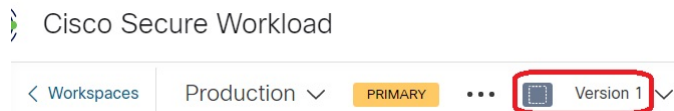

For details about versioning, see [About Policy Versions \(v* and p*\)](#), on page 145.

- Step 1** Click **Defend > Segmentation**.
- Step 2** Navigate to the relevant scope and primary workspace.
- Step 3** Click **Manage Policies**.
- Step 4** The currently displayed version of the policies is shown at the top of the page:



The displayed version may be a policy discovery version, an analyzed policy version, or an enforced version.

- Step 5** You can:

To display a different version of the policies:	<p>Click the current version and choose a different version.</p> <p>For descriptions of the versions, see About Policy Versions (v* and p*), on page 145.</p> <p>Important! If you choose a v* version, see View, Compare, and Manage Discovered Policy Versions, on page 49 instead of this topic, including the important caveat at the end of the topic.</p>
To view details about the analyzed versions:	<ol style="list-style-type: none"> Click View Version History at the top of the page beside the current version. Click the Published Versions tab to see the versions of analyzed and enforced policies. To view log entries for a version, click the link in the version. <p>Pale green rows represent analysis activity.</p> <p>Bright green rows represent enforcement activity.</p>
To compare two versions to see what has changed:	<ol style="list-style-type: none"> Click Compare Revisions. Choose the versions to compare. <p>You can compare the latest draft version, analyzed and enforced versions.</p> <ol style="list-style-type: none"> For result details, see Comparison of Policy Versions: Policy Diff, on page 147.
To delete an unwanted version:	<p>Click  for the version and choose Delete.</p> <p>Published policy versions (p* versions) can be deleted as long as the version is not being actively analyzed or enforced.</p>
To export a version:	<p>Click  for the version and choose Export....</p> <p>See also Export a Workspace, on page 52.</p>

What to do next

When you are done working with versions, change the version at the top of the workspace page to the latest discovered policy version (v*).

This avoids unintentional deletion of discovered policy versions and allows you to manually create policies in the workspace.

Activity Logs of Policy Analysis

All workspace users may view activity logs associated with changes done on the policy analysis page in the workspace history (see [Activity Logs and Version History](#)).

- Enable policy analysis

Figure 78: Enable policy analysis

You started policy analysis to version p1

2:26 PM

- Disable policy analysis

Figure 79: Disable policy analysis

You stopped policy analysis

2:32 PM

- Update policy analysis

Figure 80: Update policy analysis

You updated policy analysis to version p1

2:24 PM

Enforce Policies

Secure Workload can enforce policies using:

- [Software Agents](#) installed on individual workloads:
 - Linux
 - Windows
 - Kubernetes/OpenShift

For technical details about how agents work on each platform, see [Policy Enforcement with Agents and Enforcement on Containers, on page 137](#).

- Cloud connectors:
 - AWS through [AWS Connector](#)
 - Azure through [Azure Connector](#)
- Integrate load balancers through an external orchestrator:
 - [F5 BIG-IP](#)
 - [Citrix Netscaler](#)
- Integration with [Cisco Secure Firewall Management Center](#)
- Streaming to third-party orchestrators for enforcement in third-party infrastructure



Caution

When you enforce policies, the system inserts new firewall rules on affected hosts and deletes any existing rules on the relevant hosts.

Check Agent Health and Readiness to Enforce

Some of these checks can be done before or after enforcing policy.

Permissions may be required to modify agent or connector capability; see the requirements and prerequisites in the relevant chapters.

You do not need to perform these checks for any workloads on which you do not intend to enforce policies.

Verify That:	More Information
Agents are installed on all workloads in the scope that are associated with the enforced workspace	<p>Click Defend > Segmentation and navigate to the relevant scope and workspace. Click Matching Inventories, then click IP Addresses.</p> <p>IP addresses on this tab generally do not have agents that are installed, and agents generally must be installed to enforce policy.</p> <p>Exceptions: Enforcement occurs for the following types of inventory that appears on the IP Addresses tab:</p> <ul style="list-style-type: none"> • Cloud-based inventory on which policy is enforced using a cloud connector. (Installing agents on individual workloads is optional.) • Kubernetes addresses appear in the IP Addresses list if agents are installed on individual workload pods; Kubernetes inventory with installed agents appears on the Pods tab.
The installed agent version is current and supported	<p>For an overview of installed agent versions, click Manage > Agents, then click Distribution and look at the Agent Software Version Distribution chart.</p> <p>For details, click Manage > Agents, then click Agents List.</p>
Installed agents have enforcement capability	<p>Click Manage > Agents, then click Convert to Enforcement Agent.</p> <p>In the Filter box, enter Agent Type = Deep Visibility</p> <p>Convert any agents that must enforce policy.</p>
Enforcement is enabled for all agents	<p>(This requirement is distinct from ensuring that agents have enforcement capability and from enabling enforcement in the workspace.)</p> <p>Important! Depending on your deployment, this may need to be done before or after you enforce the workspace.</p> <p>See that the Verify Enforcement is Enabled for Agents section.</p>
Enforcement is enabled for nonagent enforcement mechanisms	<p>Important!!! Do not enable enforcement on cloud connectors without agents until AFTER you enforce policy on the workspace.</p> <p>External orchestrators that support enforcement must also be enabled before they can enforce.</p>
The Preserve Rules setting in the Agent Config Profile is appropriate for the workload platform	<ul style="list-style-type: none"> • For Kubernetes/OpenShift, see Enforcement on Containers section. • For other platforms, see information for each platform in Software Agents section. <p>Tip: Search this document for "Preserve Rules" to find useful information.</p>
(After the workspace is enforced) All agents have received the applicable policies for the workload	<p>See the Verify Enforced Policies are being pushed to Agents section.</p>

Verify That:	More Information
Agents are healthy	<p>In addition to the sources above, the following locations have information about agent health:</p> <ul style="list-style-type: none"> • Click Manage > Agents, then click Monitor. Look at the information under Enforcement Agents. • Click Manage > Agents, then click Distribution. Choose the agent type from the top of the page. • Click Organize > Scopes and Inventory, filter to find a specific workload of interest, and click the IP address. The Workload Profile page opens in a separate browser window including an Agent Health panel. For details, see Workload Profile section.

Enable Policy Enforcement



Caution Enforcing policies delete existing firewall rules and write new firewall rules on every workload in the scope that is affected by this workspace.

If you have not properly verified that your policies are working correctly, enforcing policies can change the way that your applications work and disrupt business operations.

Before you begin

- Initially, when you enforce policies, consider setting the catch-all to Allow. Then, monitor traffic to see what matches the catch-all rule. When no necessary traffic is matching the catch-all rule, you can set the catch-all to Deny.
- If you enforce workspaces in multiple scopes at once, you can enforce only analyzed workspaces. If you enforce a single workspace using the second method that is described in the procedure below, analyzing the policies in the workspace before you enforce them is recommended but not required.

See [Live Policy Analysis](#) and subtopics.

- The wizard for enforcing a single scope is more detailed than the wizard that offers the option to enforce multiple scopes simultaneously. If you require the features in [Policy Enforcement Wizard, on page 135](#), use the second method that is described in the procedure below.
- **IMPORTANT!** Verify that the policies are correct.

Policy results in any workspace may be affected by enforced policies in other scopes. Before policy enforcement is enabled on a workspace, the Policy Enforcement page shows how flows are affected by enforced policies in the workspaces associated with other scopes. For example, a broad “Production hosts should not talk with Non-Production hosts” policy in the enforced workspace of a parent scope may impact traffic on workloads belonging to an application in a child scope.

If no new information is being shown in the Enforcement charts, make sure that the correct time range is selected.

For information about the information you see on the Enforcement page, see [Live Policy Analysis](#) and subtopics. (The same information for Live Analysis also applies to the Policy Enforcement page.)

If live analysis results differ from results on the Enforcement page, make sure the scopes, policy versions, and time range being analyzed are the same as the scopes, policy versions, and time range being used to generate results on the Enforcement page.

- Understand how agents enforce policies on each platform. See:
 - For Windows and Linux workloads, see [Policy Enforcement with Agents](#) and subtopics.
 - For Kubernetes and OpenShift, see [Enforcement on Containers, on page 137](#).
 - For load balancers, see [Policy enforcement for Citrix Netscaler](#) and [Policy enforcement for F5 BIG-IP](#).
 - For cloud-based workloads configured using cloud connectors, see:
 - [Best Practices When Enforcing Segmentation Policy for AWS Inventory](#) and linked topics.
 - [Best Practices When Enforcing Segmentation Policy for Azure Inventory](#) and linked topics.

- You must have the required permissions to enforce policies:

You must have the Enforce ability or higher for the scope. Users with other abilities on the scope can still view this page but will not be able to enforce (or disable) new policies. For more information, see [Roles](#).

- Verify that all relevant installed agents and other enforcement endpoints such as cloud connectors are ready to enforce policy.

For a list of agent health and readiness checks, see [Check Agent Health and Readiness to Enforce, on page 129](#). (Some of these checks must wait until after enforcement; for example, you should enable enforcement on cloud connectors AFTER you have enabled enforcement in the workspace, NOT before. For installed agents, you will typically enable enforcement in the agent config before you enforce the workspace.)

Step 1 Choose **Defend > Segmentation**.

Step 2 You can enforce policies for one scope or for multiple scopes at the same time:

[To enforce policy for multiple scopes at the same time:](#)

(Only workspaces that have been analyzed can be enforced using this process.)



- a) Click the caret on the right side of the page to display the Tools pane:
- b) Click **Enable Enforcement**.
- c) Click **Next** to start the wizard.
- d) Select one workspace to enforce.
(The option to enforce workspaces for additional scopes is on the last page of the wizard.)
- e) Click **Next**.
- f) Choose the version of that workspace to enforce, then click **Next**.
- g) To simultaneously enforce policies for another scope, click + **Add Another Workspace** and complete the steps.
Repeat as needed for additional scopes.

- h) Click **Accept and Enforce**.

To enforce policies for a single scope:

- a) Navigate to the primary workspace for the scope for which you want to enforce policy.
- b) Click **Manage Policies**.
- c) Click **Enforcement**.
- d) Click **Enforce Policies**.
- e) Step through the wizard.

For wizard details, see [Policy Enforcement Wizard, on page 135](#).

Step 3

After you click **Accept and Enforce** on the final page of the wizard, new firewall rules will be pushed to the assets that are affected by policies in this workspace.

A Label Flag is created at the time of enforcement:

Figure 81: The Policy Enforcement Page with Enforcement Enabled

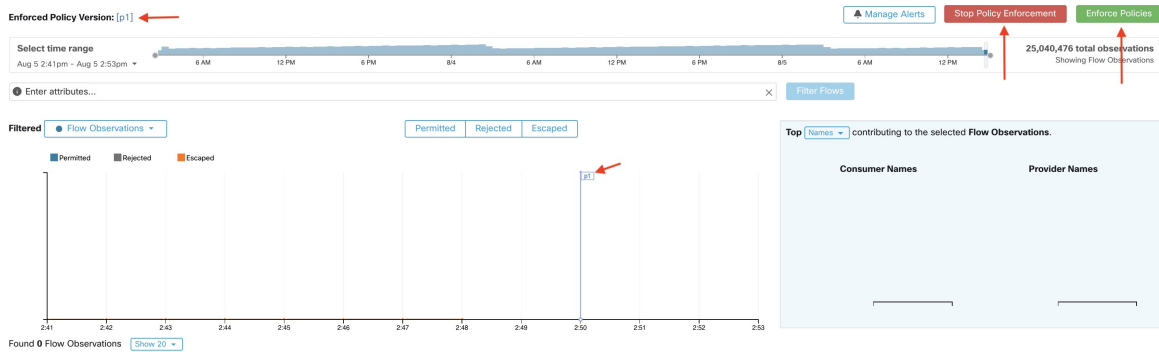

You may need to refresh the page to see the flag.

What to do next

- If you enforced policy for a single workspace, consider whether workspaces for other scopes must also be enforced to achieve the expected enforcement outcomes.
For example, workspaces for ancestor scopes or scopes that include workloads that are involved in cross-scope policies may also need to be enforced.
- Enforcement will not occur until enforcement is enabled for the agents, cloud connectors, and/or external orchestrators that enforce the policies:
 - For workloads with installed agents, enforce policy in the agent config for the relevant scopes and inventory filters. See [Software Agent Config](#) and subtopics.
 - For cloud-based workloads configured using cloud connectors, see:
 - [Best Practices When Enforcing Segmentation Policy for AWS Inventory](#) and linked topics.
 - [Best Practices When Enforcing Segmentation Policy for Azure Inventory](#) and linked topics.
 - For Kubernetes and OpenShift, see:
 - [Enforcement on Containers, on page 137](#)
 - [Software Agent Config](#)
 - For load balancers, see:
 - [Policy enforcement for F5 BIG-IP](#)
[Policy enforcement for F5 ingress controller](#)
 - [Policy enforcement for Citrix Netscaler](#)
- Check to be sure enforcement is working as expected. See [Verify That Enforcement Is Working as Expected, on page 138](#).

- Configure alerts so you are notified of any issues, for example if flows are rejected after enforcement is enabled.

Policy Enforcement Wizard

When you enforce policies for a single workspace from the Enforcement page of the workspace, the policy enforcement wizard lets you:

- Review policies before they are implemented on the workloads.
This includes policies that are inherited from ancestor scopes.
- Download policy changes for review.
- Compare policy versions.
- Choose which analyzed version of the workspace to enforce.
- Roll back policies to a previous version.

Steps in the policy enforcement wizard:

1. Select Policy Updates

You can select which version of policies to be enforced on the workloads.

The difference between the currently enforced policies and policies in the selected version is displayed.

Similarly to the [Comparison of Policy Versions: Policy Diff](#), you can filter and review the policy changes and download them as CSV.

2. Impacted Workloads

This step shows the workloads that will be affected by the new firewall rules generated from the selected policy changes. The result comes from searching all the workloads that have enforcement agents within the union of the consumers/providers of the selected policy changes.

The number of potentially impacted workloads cannot exceed the total number of workloads in the scope. However, the actual impacted workloads might be smaller due to other factors such as agent config intents.

Figure 82: List of Impacted Workloads

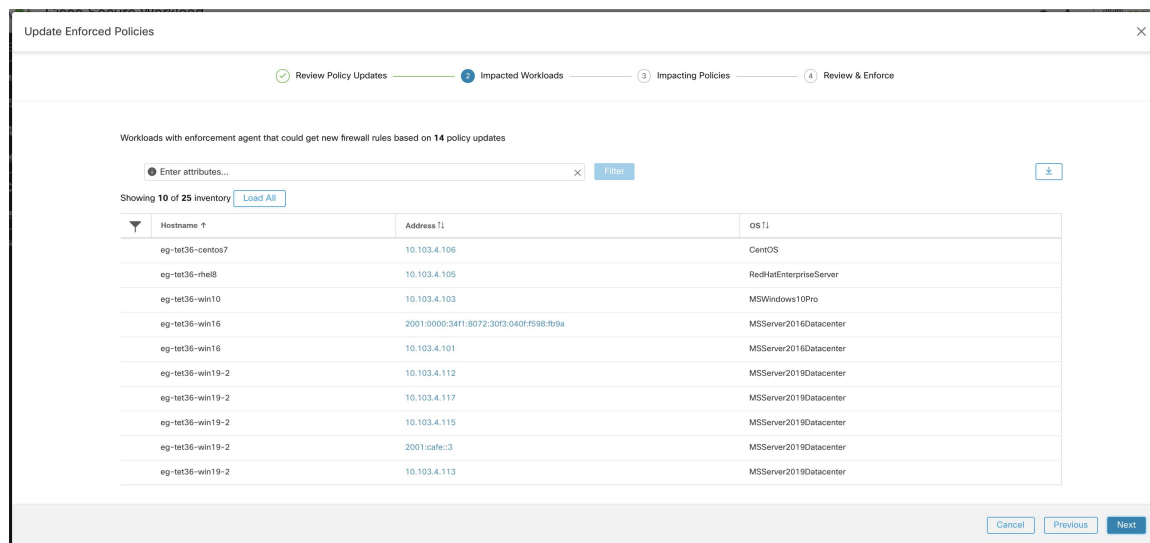

For more details on viewing, filtering, and downloading inventory items, see [Inventory](#).

3. Impacting Policies

Policies from the ancestor workspaces may impact workloads in the current workspace. Therefore, you should make sure the desired allow policies from ancestor workspaces are enforced.

Figure 83: List of ancestor workspaces and enforced versions

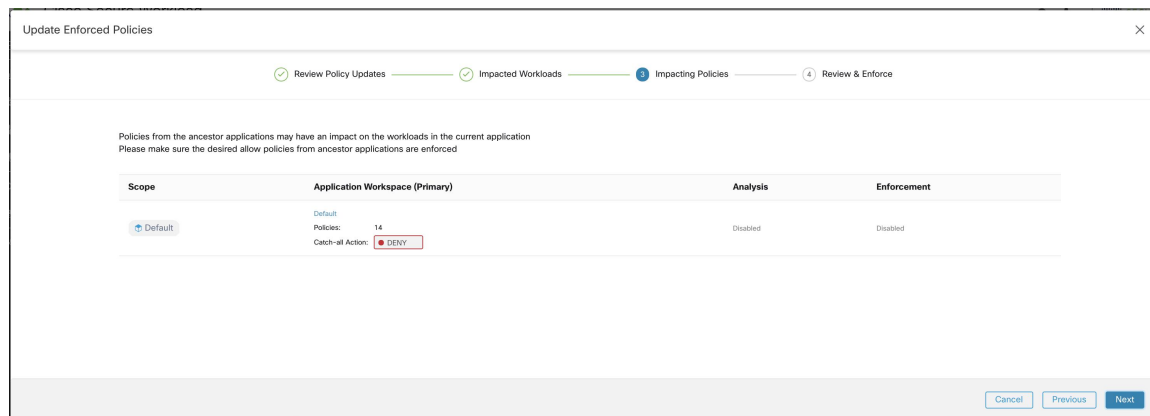

4. Review & Accept

This final step summarizes the policy changes to be enforced, the number of potentially impacted workloads, and the catch-all action that will be enforced. When you click **Accept and Enforce**, the policies in the workspace will be used to calculate the new firewall rules that will be configured on the relevant workloads.

You have the option to provide a name, description, and reason for action for the newly enforced policies for future reference. In case of rollback, you can provide only the reason, as name and description for a past version cannot be changed.

Figure 84: Review the Summary and Enforce Policy Changes

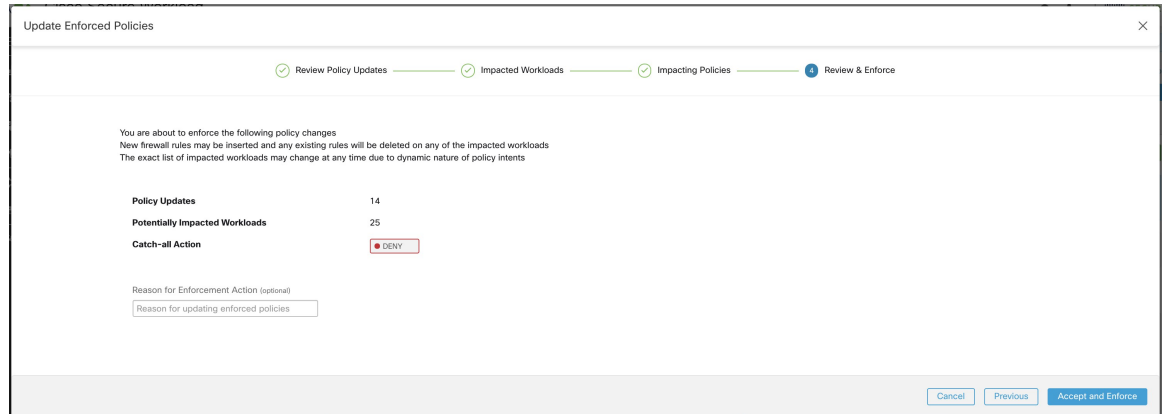

Enforcement on Containers

For an overview of the steps that are required to set up segmentation on container-based workloads that are managed by Kubernetes and OpenShift, see [Set Up Microsegmentation for Kubernetes-Based Workloads](#).



Attention Agents running on Kubernetes/OpenShift hosts must be configured to preserve existing rules.

In order to prevent enforcement from interfering with iptables rules added by Kubernetes, the agent must be configured with a profile that has the **Preserve Rules** option enabled. See [Creating an Agent Config Profile](#)

When enforcing policies on containers, Secure Workload allows Kubernetes/OpenShift service abstractions to be used as providers. Internally, the policies for service abstractions are transformed into rules for the provider pods and the nodes they are running on. This transformation depends on the type of the Kubernetes/OpenShift service, and it is dynamically updated whenever changes are received from the API server.

The following example illustrates the flexibility made possible by this feature. Consider the following policy which allows traffic from all hosts and pods with the label *environment = production* to a Kubernetes service of type *NodePort* with the name *db* which exposes TCP port 27017 on a set of pods.

Consumer	Provider	Protocol/Port	Action
environment = production OR orchestrator_environment = production	orchestrator_system/service_name = db	TCP 27017	Allow

This policy would result in the following firewall rules:

- On hosts and pods that are labeled with *environment = production*, allow outgoing connections to all Kubernetes nodes of the cluster to which the service belongs. This rule uses the node port that is assigned to this service by Kubernetes.

- On pods with the label *environment = production*, allow outgoing connections to the ClusterIP assigned to this service by Kubernetes. This rule uses the port that is exposed by the service (TCP 27017).
- On Kubernetes nodes of the cluster to which the service belongs, allow outgoing connections to the provider pods. This rule uses the target port that is exposed by the service (TCP 27017).
- On pods providing the service db, all incoming connections from all kubernetes nodes and consumer hosts and pods. This rule uses the target port that is exposed by the service (TCP 27017).

Changes to the type of the service, ports, and set of provider pods will immediately be picked up by Secure Workload rule generator and used to update the generated firewall rules.



Caution Policies including Kubernetes/OpenShift inventory must be designed carefully to avoid conflicting with the internal operation of the kubernetes cluster.

Kubernetes/OpenShift items imported by Secure Workload include the pods and services constituting the kubernetes cluster (for example, pods in the kube-system namespace). This allows precise policies to be defined to secure the kubernetes cluster itself, but it also means that badly designed policies can affect the operation of the cluster.

Verify That Enforcement Is Working as Expected

Check Agents

See [Check Agent Health and Readiness to Enforce](#), on page 129.

Check for Escaped and Rejected Flows

In the menu on the left side of the screen, click **Overview**.

On the **Security Dashboard** page, look at the **Segmentation Compliance Score**.

If this is less than 100, you may have escaped or rejected flows, either of which indicates a policy configuration issue.

For details, see [Segmentation Compliance Score](#).

For more information about investigating these situations, see [Policy Analysis Results: Understand the Basics](#), on page 120 and subtopics. (The information in these topics applies to enforced policies shown on the Enforcement tab and to analyzed policies shown on the Policy Analysis tab.)

Add any missing policies, or modify existing policies, for example, by adding additional protocols/ports, to allow required legitimate traffic.

Then reanalyze before reenforcing.

View Enforced Policies for a Specific Workload (Concrete Policies)

Use this procedure to view all enforced policies for a specific workload (that is, the *concrete policies* for that workload). This view is useful because all policies in a workspace may not apply to every workload in the workspace, and because policies in multiple workspaces may apply to a particular workload (for example, inherited policies in parent or ancestor scopes).

Concrete policies are listed in priority order. For more information about the effects of priority, see the Policy Priorities section.

Before you begin



Note Concrete policies include only policies in enforced workspaces. If a workspace is not enforced, any policies that would apply to the workload if the workspace were enforced do not appear in the list.

Step 1 You can navigate to the Concrete Policies page for a workload from the Inventory page or from the workspace:

To navigate from the Scopes and Inventory page:

- a) Choose **Organize > Scopes and Inventory**.
- b) Search for the IP address of the workload of interest and click it.

The Workload Profile opens in a separate tab.

In general, except for cloud-based workloads that are managed without agents, Kubernetes, and OpenShift workloads, if the IP address appears in the **IP Addresses** tab and not in the **Workloads** tab, this means that an agent is not installed on the workload, so policies cannot be enforced, and there is no concrete policies list.

To navigate from the Segmentation page:

- a) Choose **Defend > Segmentation**.
- b) Click the scope.
- c) Click the Primary workspace.
- d) Click **Manage Policies**.
- e) Click the **Matching Inventories** tab.
- f) Search for the IP address of the workload of interest and click it.
- g) In the panel that opens on the right, click **View Workload Profile**.

The Workload Profile opens in a separate tab.

Step 2 From the menu on the left side of the Workload Profile page, click **CONCRETE POLICIES**.

Step 3 Click a row to view details.

For more information, see the Concrete Policies tab.

Step 4 To see the amount of traffic that has hit each policy:

- a) Click **Fetch All Stats**.
- b) Click each policy of interest.

Step 5 To view information about Kubernetes or OpenShift workloads, click **CONTAINER POLICIES**.

What to do next

Choose **Monitor > Enforcement Status** for status of concrete policies, for example to see if any policies have been skipped. For details, see the Enforcement Status section.

Verify That Enforcement Is Enabled for Agents

- Step 1** Click **Defend > Enforcement Status**.
- Step 2** To view only the enforcement status for a specific scope, toggle the **Filter by Scope** control and select a scope.
- Step 3** Look at the **Agent Enforcement Enabled** chart.
- If the chart shows that any agents are **Not Enforced**, continue with this procedure.
- Otherwise, skip the rest of this procedure, as all agents are enabled for enforcement.
- Step 4** Click the orange **Not Enforced** section of the chart to display the affected workloads in the table below the chart.
- Step 5** Enable enforcement on these workloads by modifying the Agent Config profile.
- See [Create an Agent Configuration Profile](#).
-

Verify That Enforced Policies Are Being Pushed to Agents

For enforcement to occur, policies specific to each workload must be successfully pushed to the agent installed on that workload. Status is also shown for policy enforcement that is managed by cloud connectors even if agents are not installed.

Before you begin

Enforce policies for at least one scope.

- Step 1** Click **Defend > Enforcement Status**.
- Step 2** To view only the enforcement status for a specific scope, toggle the **Filter by Scope** control and select a scope.
- Step 3** Look at the **Agent Concrete Policies** chart.
- If the chart shows that any are **Skipped**, continue with this procedure.
- Otherwise, skip the rest of this procedure.
- Step 4** To display the list of workloads affected by this issue, click the red **Skipped** slice of the chart.
- The affected workloads are listed in the table below the charts.
- Step 5** To see the reasons for this issue:
- For each workload in the search results, click the **(i)** button beside **Skipped** in the **Concrete Policies** column.

Error Message	More Information
Agent doesn't have Windows OS	At least one policy that is applicable only to Windows workloads includes consumers and/or providers that are not running Windows OS. Remove those workloads from those policies.

Error Message	More Information
Maximum number of policies has been reached	See If There Are Too Many Policies for the Agent , on page 141.

What to do next

(Optional) Configure an alert so you are notified if this situation occurs in future. See [Configure Alerts](#).

If There Are Too Many Policies for the Agent

If the complete set of applicable concrete policies cannot be pushed to a particular agent, the latest version of the policies is not pushed.

Background: There is a limit to the number of policies supported on each agent. Limits also apply to policies enforced using cloud connectors. You may find the information in [Limits](#) helpful.

Before you begin

Use this procedure to resolve this problem if [Verify That Enforced Policies Are Being Pushed to Agents](#), on page 140 indicates that the agent cannot accommodate the full set of enforced policies.

Step 1 Navigate to the primary workspace for an affected scope.

Step 2 Modify the policies in the primary workspace:

Try to reduce the number of policies and reduce any long lists of IP addresses in consumer or provider.

For example, consolidate existing policies, and/or base policies on subnets rather than on huge lists of IP addresses.

For policies enforced using a cloud connector, you may also be able to increase any limits that are imposed by the platform. See the documentation for your cloud platform.

Step 3 After you have made changes, enforce the latest version of the workspace and check again for skipped policies.

Step 4 Repeat this procedure for any other scopes experiencing this issue.

Modify Enforced Policies

Enforce New and Revised Policies

If you must revise policies after enforcement, generally you will make the changes in the same primary workspace. Then, review your changes carefully, and analyze the workspace again to be sure it has the effect you expect. When you are confident that the changes will have the desired effect, click the **Enforce Latest Policies** button in the upper right of the page.

View, Compare, and Manage Enforced Policy Versions

Each time that you enforce or reenforce policies in a workspace after making changes, a new version (p*) is created.

For detailed information about versioning, see [About Policy Versions \(v* and p*\)](#), on page 145.

- Step 1** Click **Defend > Segmentation**.
- Step 2** Navigate to the relevant scope and primary workspace.
- Step 3** Click **Manage Policies**.
- Step 4** The currently displayed version of the policies is shown at the top of the page:

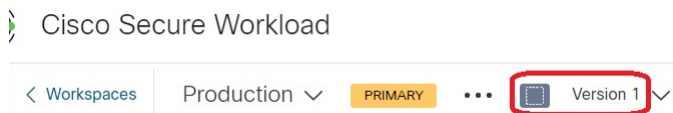

The displayed version may be a policy discovery version, an analyzed policy version, or an enforced version.

- Step 5** Do one of the following:

To display a different version of the policies:	<p>Click the current version and choose a different version.</p> <p>For descriptions of the versions, see About Policy Versions (v* and p*), on page 145.</p> <p>Important! If you choose a v* version, see View, Compare, and Manage Discovered Policy Versions, on page 49 instead of this topic, including the important caveat at the end of the topic.</p>
To view details about the analyzed versions:	<ol style="list-style-type: none"> Click View Version History at the top of the page beside the current version. Click the Published Versions tab to see the versions of analyzed and enforced policies. To view log entries for a version, click the link in the version. <ul style="list-style-type: none"> Pale green rows represent analysis activity. Bright green rows represent enforcement activity.
To compare two versions to see what has changed:	<ol style="list-style-type: none"> Click Compare Revisions. Choose the versions to compare. <ul style="list-style-type: none"> You can compare the latest draft version, analyzed and enforced versions. For result details, see Comparison of Policy Versions: Policy Diff, on page 147.
To delete an unwanted version:	<p>Click  for the version and choose Delete.</p> <p>Published policy versions (p* versions) can be deleted as long as the version is not being actively analyzed or enforced.</p>

To export a version:	Click  for the version and choose Export... See also Export a Workspace, on page 52 .
----------------------	--

What to do next

When you are done working with versions, change the version at the top of the workspace page to the latest discovered policy version (v*).

This avoids unintentional deletion of discovered policy versions and allows you to manually create policies in the workspace.

Revert Enforced Policies to an Earlier Version

To roll back enforced policies to a previous version, follow one of the processes that are described in [Enable Policy Enforcement, on page 131](#) and choose an earlier version to enforce.

Disable Policy Enforcement

- **To disable policy enforcement for multiple scopes simultaneously:**

Follow the procedure for enforcing policy in multiple scopes simultaneously, as described in [Enable Policy Enforcement, on page 131](#). On the Select Version page of the wizard, click **Select a version** and choose **Disable enforcement**.

- **To disable policy enforcement for a single scope:**

Navigate to the Policy Enforcement page for the scope's primary workspace and click the red **Stop Policy Enforcement** button. This writes new firewall rules to assets in the scope based on enforced policies in ancestor workspaces. A Label Flag with an 'x' will be created on the time series chart.

Pause Policy Updates



Caution This option pauses policy updates for ALL workloads in ALL scopes.

This feature requires site admin or customer support privileges.

To pause rule updates for all enforcement endpoints in all scopes:

1. Choose **Defend > Enforcement Status**.
2. Click the status beside **Policy Updates**.
3. Read and accept the caution.

Figure 85: Firewall Rules are being Updated Continuously

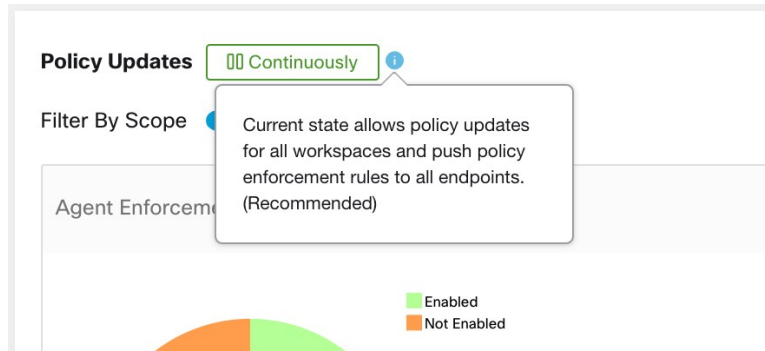
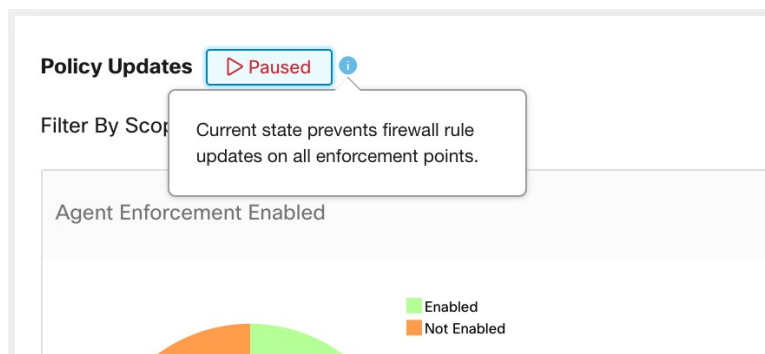

Figure 86: Firewall Rule Updates are Paused



Enforcement History

Enforcement History provides a list of changes to the list of enforced workspaces and their version.

To view the enforcement history:

1. Click the caret at the right side of the Segmentation page to expand the Tools menu.
2. Click **Enforcement History**.

Each section describes an event and displays a summary of what has changed.

3. Click an event for details about all the policies that were enforced at that time.

Figure 87: Enforcement history view

About Policy Versions (v* and p*)

Policy versions are sometimes called workspace versions.

Displayed Version

The version of the policies (and clusters) that you are currently working with is shown at the top of the workspace page:

- V* versions are generated by automatic policy discovery
For details, see below
- P* versions are analyzed and/or enforced versions
For details, see below

The following icons may appear beside the version number:

Table 6: Version Icons

	Indicates the version of the policies that is currently being analyzed
	Indicates the version of the policies that is currently being enforced
	Indicates the latest version of automatically discovered policies
(no icon)	Indicates that the version is not the latest version of its type

Examples:

- Displayed version is the latest discovered version of the policies:

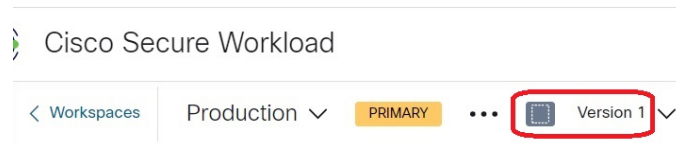

- Displayed version is the version of the policies that is currently being analyzed:

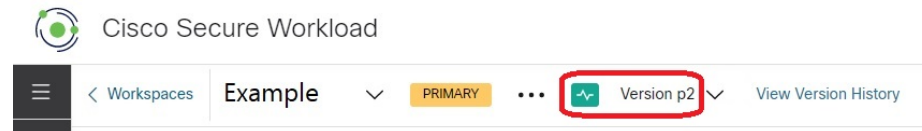

- Displayed version is the version of the policies currently being analyzed and enforced:

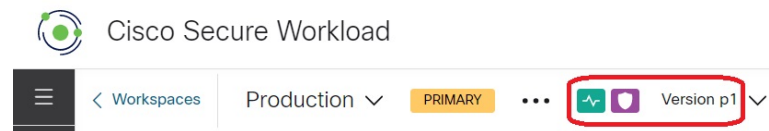

Policy Discovery Version (v*)

Each time you automatically discover policies for a workspace, the version (v*) increments.

The first time you automatically discover policies, version 1 is generated, and all modifications after that run, such as editing or approving clusters (but not a rerun), are also grouped under version 1. When you subsequently automatically discover policies, a new version is generated (unless discovery failed).

The v* version also increments if you import policies.

To work with v* versions, see [View, Compare, and Manage Discovered Policy Versions, on page 49](#).

Published Policy Version (p*)

The term "published" policy version (p*) for a workspace can refer to either:

- The version of the policies that was analyzed, or
- The version of the policies that was enforced

These are two separate but parallel versions that depend on the context:

- Policy version for analysis:

Each time you analyze policies in a workspace, or click **Analyze Latest Policies** after making a change, the system takes a snapshot of all the clusters and policies that are defined in that workspace, and the "published" policy version (p*) number for analysis increments. The latest **Live Policy Analysis** version is shown at the top-left side of the page on the Policy Analysis tab of the primary workspace.



- Policy version for enforcement:

Each time you enable enforcement of the policies in a workspace, or enable enforcement again after making changes, the "published" policy version (p*) for enforcement becomes the number of the analyzed version that you choose in the enforcement wizard. So, if you enforce analyzed version 5, the enforced version is also version 5, even if it is, for example, the first time policy has been enforced for the workspace. The current **Enforced Policy Version** is shown at the top-left side of the page on the Enforcement tab of the primary workspace.



Managing Published (p*) Versions

Published policy versions cannot be edited, only deleted entirely.



Note Published policy versions (p*) are limited to 100 total. Once this limit is reached, you must delete old versions.

To manage and delete p* versions, see [View, Compare, and Manage Analyzed Policy Versions, on page 127](#), or [View, Compare, and Manage Enforced Policy Versions, on page 142](#).

You can also use the API to delete published versions.

Comparison of Policy Versions: Policy Diff

To compare policies, see any of the following topics: [View, Compare, and Manage Discovered Policy Versions, on page 49](#), [View, Compare, and Manage Analyzed Policy Versions, on page 127](#), or [View, Compare, and Manage Enforced Policy Versions, on page 142](#)

Policy changes will be displayed in three categories: Absolute, Default and Catch All. In the comparison table:

- Different services that belongs to the same policy are grouped together
- Filter policy changes by facet or by diff type
- Policy changes and services are paginated
- Download filtered policy changes as CSV

Table 7: Facet filter properties

Property	Description
Priority	e.g. 100
Action	e.g. ALLOW, DENY
Consumer	e.g. Consumer Cluster
Provider	e.g. Provider Cluster
Port	e.g. 80
Protocol	e.g. TCP

Table 8: CSV output columns

Column	Description
Rank	The category of the policy. e.g. ABSOLUTE, DEFAULT, CATCH_ALL
Diff	The diff type of the change. e.g. ADDED, REMOVED, UNCHANGED
Priority	e.g. 100
Action	e.g. ALLOW, DENY
Consumer Name	The name of the consumer cluster.
Consumer ID	The ID of the consumer cluster.
Provider Name	The name of the provider cluster.
Provider ID	The ID of the provider cluster.
Protocol	e.g. TCP
Port	e.g. 80

In the figure below, policy versions p1 and v1 are compared.

Figure 88: Policy Diff View

Compare Policies Clusters

Base Version Latest draft version, Analyzed Version (p1)

p1 X

Name: untitled 9 log events Last Updated: Aug 5, 5:14 PM

Filter Policies ... X

Compare Version Latest Draft Version, Analyzed Version (p1)

v0 X

Absolute: No matching changes

Default Added 0 Removed 153 Unchanged 0

Priority	Action	Consumer	Provider	Service
100	ALLOW	bpimweb-idev4-0*	OTHER: rcdn9-dcl13n-gen-client-ace:iv120...	TCP: 5222
100	ALLOW	bpimweb-idev4-0*	OTHER: RTP-DC-Internal	UDP: 53 (DNS)
				TCP: 80 (HTTP)
				TCP: 111 (SunRPC)
				TCP: 443 (HTTPS)
100	ALLOW	bpimweb-idev4-0*	OTHER: unknown	UDP: 53 (DNS) ...1 more

Figure 89: Policy Diff View Download Button

Download Policy Changes as CSV ↓

Figure 90: Filtering Policy Diff View

Filter Policies ... X

Properties that can be filtered

- Priority e.g. 100
- Action e.g. ALLOW, DENY
- Consumer e.g. Consumer Cluster
- Provider e.g. Provider Cluster
- Port e.g. 80
- Protocol e.g. TCP

Priority	Action	Consumer	Provider	Service
100	ALLOW	bpimweb-idev4-0*	OTHER: RTP-DC-Internal	UDP: 53 (DNS)
				TCP: 80 (HTTP)
				TCP: 111 (SunRPC)
				TCP: 443 (HTTPS)

Figure 91: Policy Diff View Diff Type Filter

Default Added 15 Removed 4 Unchanged 149

Figure 92: Policy Diff View Grouping

100	ALLOW	bpimweb-idev4-0*	OTHER: RTP-DC-Internal	UDP: 53 (DNS)
				TCP: 80 (HTTP)
				TCP: 111 (SunRPC)
				TCP: 443 (HTTPS)

Figure 93: Policy Diff View CSV Output

Rank	Diff	Priority	Action	Consumer Name	Consumer ID	Provider Name	Provider ID	Protocol	Port
DEFAULT	ADDED	100	ALLOW	bpimweb-idev4-0*	610bcda7a51e713db909da40	OTHER: rcdn9-dci13n-gen-client-ace:iv120	610bcda7a51e713db909d9f1	TCP	5222
DEFAULT	ADDED	100	ALLOW	bpimweb-idev4-0*	610bcda7a51e713db909da40	OTHER: RTP-DC-Internal	610bcda7a51e713db909d9fe	UDP	53
DEFAULT	ADDED	100	ALLOW	bpimweb-idev4-0*	610bcda7a51e713db909da40	OTHER: RTP-DC-Internal	610bcda7a51e713db909d9fe	TCP	80
DEFAULT	ADDED	100	ALLOW	bpimweb-idev4-0*	610bcda7a51e713db909da40	OTHER: RTP-DC-Internal	610bcda7a51e713db909d9fe	TCP	111
DEFAULT	ADDED	100	ALLOW	bpimweb-idev4-0*	610bcda7a51e713db909da40	OTHER: RTP-DC-Internal	610bcda7a51e713db909d9fe	TCP	443
DEFAULT	ADDED	100	ALLOW	bpimweb-idev4-0*	610bcda7a51e713db909da40	OTHER: unknown	610bcda7a51e713db909da45	UDP	53
DEFAULT	ADDED	100	ALLOW	bpimweb-idev4-0*	610bcda7a51e713db909da40	OTHER: unknown	610bcda7a51e713db909da45	TCP	443
DEFAULT	ADDED	100	ALLOW	bpimweb-idev3-0*	610bcda7a51e713db909da26	OTHER: rcdn9-dci13n-gen-client-ace:iv120	610bcda7a51e713db909d9f1	TCP	5222



Tip See also [Comparing Versions of Generated Clusters: Diff Views](#), on page 77.

Activity Logs and Version History

Activity logs record the history of modifications that are applied to a workspace by you. The events that are shown include adding, removing, and renaming workloads and clusters, moving workloads between clusters, creating and updating application views, uploading side information, submitting and aborting automatic policy discovery, and so on. The view shows which user has made each modification.

To view the modification history for a workspace, click any **Activity Log** link in the workspace.

For example:

1. Click **Defend > Segmentation**
2. Click the relevant scope and workspace.
3. Click the **View Activity Logs** link.
4. Click the **Workspace Activity Log** tab.

Figure 94: Log of Events Applicable to Version v1 of this Workspace

Activity Log	Matching Inventories 46	Conversations	Filters 13	Policies 155	Provided Services	Enforcement Status	Policy Analysis	Enforcement	Compare Revisions
Application Activity Log									Compare Revisions
You stopped policy enforcement									AUG 5, 5:14 PM
You started policy enforcement on version p1									AUG 5, 4:59 PM
You stopped policy enforcement									AUG 5, 2:50 PM
You started policy enforcement on version p1									AUG 5, 2:50 PM
You stopped policy analysis									AUG 5, 2:39 PM
You started policy experiment on version p1 named s									AUG 5, 2:39 PM
You updated policy analysis to version p1									AUG 5, 2:38 PM
You stopped policy analysis									AUG 5, 2:38 PM
You started policy analysis to version p1									AUG 5, 2:38 PM
You deleted exclusion filter OTHER: RTP-DC-Internal → Default : TCP port 80									AUG 5, 2:05 PM
You updated exclusion filter to Default → OTHER: RTP-DC-Internal : on any port									AUG 5, 2:05 PM

For information about the version-related tabs and options on the page, see:

- [About Policy Versions \(v* and p*\)](#), on page 145
- [View, Compare, and Manage Discovered Policy Versions](#), on page 49

- [View, Compare, and Manage Analyzed Policy Versions, on page 127](#)
- [View, Compare, and Manage Enforced Policy Versions, on page 142](#)

Automatic Deletion of Old Policy Versions

Every week, the following are automatically deleted: Workspace versions that have not been accessed for six months and policy experiments that have not been accessed in the last 30 days.

Conversations

A conversation is defined as a service provided by one host on a particular port and consumed by another host. Such a conversation is materialized from many flows over different times. Automatic policy discovery takes all such flows, ignores the ephemeral/client ports, and deduplicates them to generate the conversation graph. For any given conversation between host A and host B on server (provider) port N, there has been at least one flow observation from A to B on port N in the timeframe for which automatic policy discovery has been performed.

Use flow data to better understand what flows are associated with what process while evaluating clusters generated during automatic policy discovery.

In addition, information that is collected by agents provides visibility of unused L4 ports. Unused ports are the ones for which no communication was seen for the interval selected for automatic policy discovery. This information can be used to open up policies for communication on those ports OR to close those applications binding to the unused ports, thereby reducing the attack surface of the workload.

Note that client-server classification affects the automatic policy discovery conversation view – it dictates which port is dropped (is deemed ephemeral) in the aggregation: See [Client Server Classification](#).

Conversations Table View

The Conversations Table view provides a simple way to view aggregated flows from the duration of automatic policy discovery where the consumer port is removed and there is only one record for all time. While policies go from filter to filter, conversations are from IP address to IP address.

Figure 95: Conversations Table View

Cluster, Scope and Inventory Filter membership is as of the time of this Automatic Policy Discovery.

Consumer: Select a group

Provider: Select a group

Enter attributes... Filter

Found 165 Conversations (20 conversations)

Explore Observations

Consumer Filter	Provider Filter	Consumer Address	Provider Address	Protocol	Port	Flows
Default	Default	172.21.131.11	172.21.131.4	TCP	443 (HTTPS)	
Default	Default	172.21.131.7	173.36.224.108	TCP	80 (HTTP)	
Default	Default	172.31.182.228	172.21.131.9	TCP	5660 (Secure Workload Enforcement)	
Default	Default	10.103.5.213	172.21.131.5	TCP	443 (HTTPS)	
Default	Default	172.21.131.7	173.36.224.109	TCP	80 (HTTP)	
Default	Default	173.37.180.94	172.21.131.12	ICMP		
Default	Default	172.21.131.9	172.21.131.4	TCP	443 (HTTPS)	
Default	Default	173.37.95.210	172.21.131.13	TCP	22 (SSH)	
Default	Default	172.21.131.11	172.21.106.116	ICMP		

Choosing Consumer or Provider

Consumers and Providers can be selected by a typeahead dropdown selector which allows one to choose Inventory Filters, Scopes, and Clusters as shown in the example below. All conversations between the chosen Consumer and Provider are displayed. Note: to delete an existing filter, click on the ‘x’ icon (erasing the filter may not work).

By default, the Consumer and Provider match against all of the inventory filters an IP address is a member of during automatic policy discovery. For example, searching for the “root scope” will match all the conversations even though some IPs may be better matched by more specific scopes. To perform a more specific match, select “Restrict scope filtering to an IP’s best match” from the settings dropdown to the left of the faceted filter input.

Figure 96: Choosing Consumer or Provider

Cluster, Scope and Inventory Filter membership is as of the time of this ADM run (Aug 5, 10:55 AM).

Consumer: OTHER: RTP-DC-Internal

Provider: Select a group

Enter attributes... Filter

Found 200 Conversations (Show 20)

Explore Observations

Consumer Filter	Provider Filter	Consumer Address	Provider Address	Protocol	Port	Flows
OTHER: rtp1-dcm01n-dcm01n-dcm02n-otv-filer-iv11...	1 of 1 matching scopes shown	10.115.184.11	10.115.184.11	TCP	1000	
Default	filter unknown	10.1.1.0	10.2.2.0	TCP	1000	

Conversation Filters

Figure 97: Conversation Filters

Enter attributes... Filter

This is where you define filters to narrow-down the search results. All of the possible dimensions can be found by clicking on the (?) icon next to the word Filters. For any User Labels data, those columns will also be

available for the appropriate intervals. This input also supports and, or, not, and parenthesis keywords, use these to express more complex filters. For example, a direction-agnostic filter between IP 1.1.1.1 and 2.2.2.2 can be written:

Consumer Address = 1.1.1.1 and Provider Address = 2.2.2.2 or Consumer Address = 2.2.2.2 and Provider Address = 1.1.1.1 And to additionally filter on Protocol = TCP:

(Consumer Address = 1.1.1.1 and Provider Address = 2.2.2.2 or Consumer Address = 2.2.2.2 and Provider Address = 1.1.1.1) and Protocol = TCP

The filter input also supports “,” and “-” for Port, Consumer Address and Provider Address, by translating “-” into range queries. The following are examples of a valid filter:

Figure 98: Filter input supports range query for Consumer Address

The screenshot shows the 'Conversations' filter configuration page. At the top, it indicates 'Cluster, Scope and Inventory Filter membership is as of the time of this ADM run (Aug 5, 10:55 AM)'. Below this, there are dropdown menus for 'Consumer' and 'Provider', both set to 'Select a group'. A search bar contains the filter expression: 'Consumer Address = 1.1.1.18 - 1.1.1.26'. Below the search bar, it says 'Found 200 Conversations' and 'Show 20'. There are buttons for 'Explore Observations', '20+ Consumers', and '20+ Providers'. A table below shows the results of the filter:

Consumer Filter ↑	Provider Filter ↓	Consumer Address ↓	Provider Address ↓	Protocol ↓	Port ↓	Flows
Default	filter unknown	10.1.1.0	10.2.2.0	TCP	1000	📊 🔄
Default	filter unknown	10.1.1.1	10.2.2.1	UDP	1020	📊 🔄

Available filters:

Filters	Description
Consumer Address	Enter a subnet or IP Address using CIDR notation (for example, 10.11.12.0/24). Matches conversation flow observations whose consumer address overlaps with provided IP Address or subnet.
Provider Address	Enter a subnet or IP Address using CIDR notation (for example, 10.11.12.0/24) Matches conversation flow observations whose provider address overlaps with provided ip address or subnet.
Port	Matches conversation flow observations whose port overlaps with provided port.
Protocol	Filter conversation flow observations by Protocol type (TCP, UDP, ICMP).
Address Type	Filter conversation flow observations by Address type (IPv4, IPv6, DHCPv4).
Confidence	Indicated the confidence in the direction of flow. Possible values: High, Very High, Moderate.
Excluded?	Match conversations that are excluded by an exclusion filter or approved policy.

Filters	Description
Excluded By	Match conversations excluded by a specific filter. Possible values: Exclusion Filter, Policy.

Explore Observations

Clicking on the Explore Observations button enables a chart view that allows quick exploration of the high-dimensional data via a “Parallel Coordinates” chart. A bit overwhelming at first, this chart can be useful when enabling only the dimensions you’re interested in (by unchecking items in the Dimensions dropdown), and when rearranging the order of the dimensions. A single line in this chart represents a single observation, and where that line intersects with the various axes indicates the value of that observation for that dimension. This can become clearer when hovering over the list of observations below the chart to see the highlighted line representing that observation in the chart:

Figure 99: Explore Observations

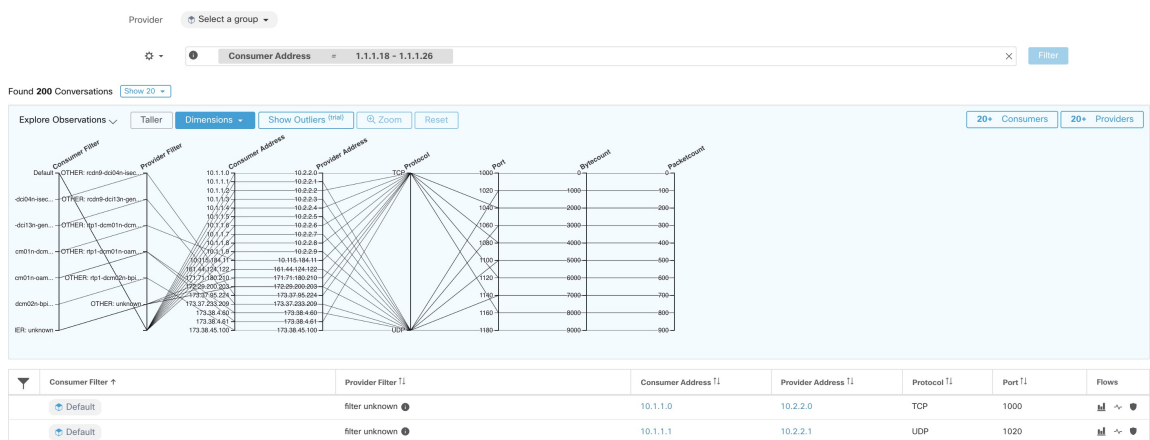

Conversation Observation Hovered

Due to the high-dimensional nature of the conversations data, this chart is wide by default, and requires scrolling right to see the entire chart. For this reason, it’s useful to disable all but the dimensions you are interested in. Hover state in Explore Conversations is provided to map (hover) each conversation with the table list view.

Figure 100: Conversation Observation Hovered

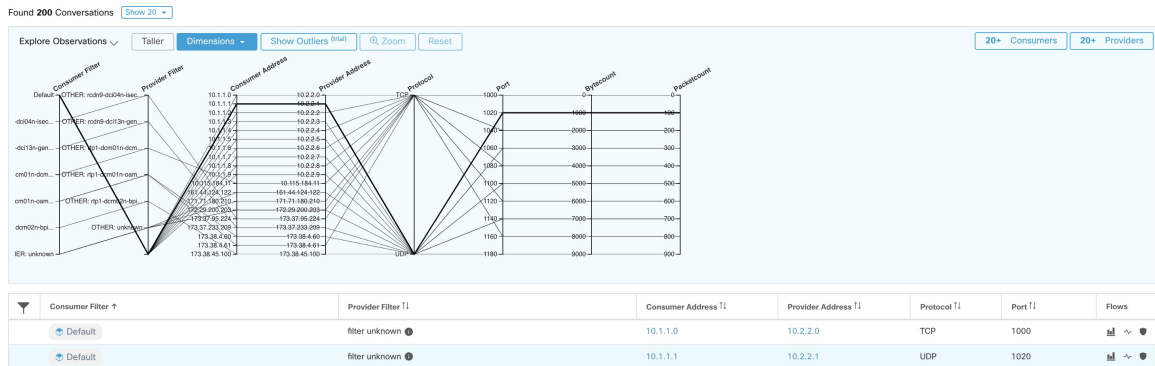

Filtering

Dragging the cursor along any of the axes creates a selection that will show only observations that match that selection. Click again on the axis to remove the selection at any time. Selections can be made on any number of axes at a time. The list of observations will update to show only the selected conversations.

Figure 101: Filtering

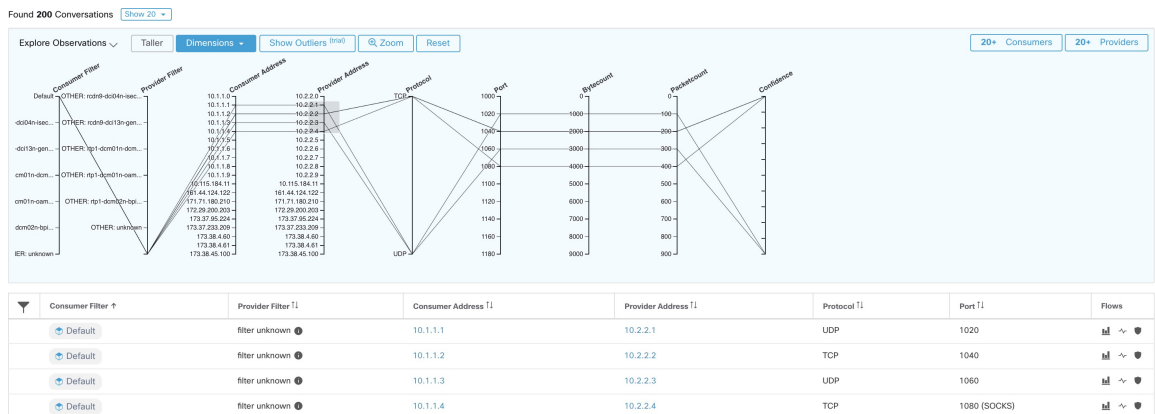

Conversations Chart View

Conversation chart view has a similar look and feel to the policy view page, except that instead of partitions/clusters/policies, it focuses on clusters/workloads/conversations. As illustrated in the figure below, the outer arcs at the high level represent clusters and can be expanded to show the member hosts/workloads as inner arcs. The chords represent the conversations or connections.

The controls and side panel on conversation view behave similarly to the policy view, except for the fact that the side panel information also shows detailed information about selected workloads such as consumed/provided services as well as link to parent cluster and process information, if available.

Figure 102: Conversations Chart View

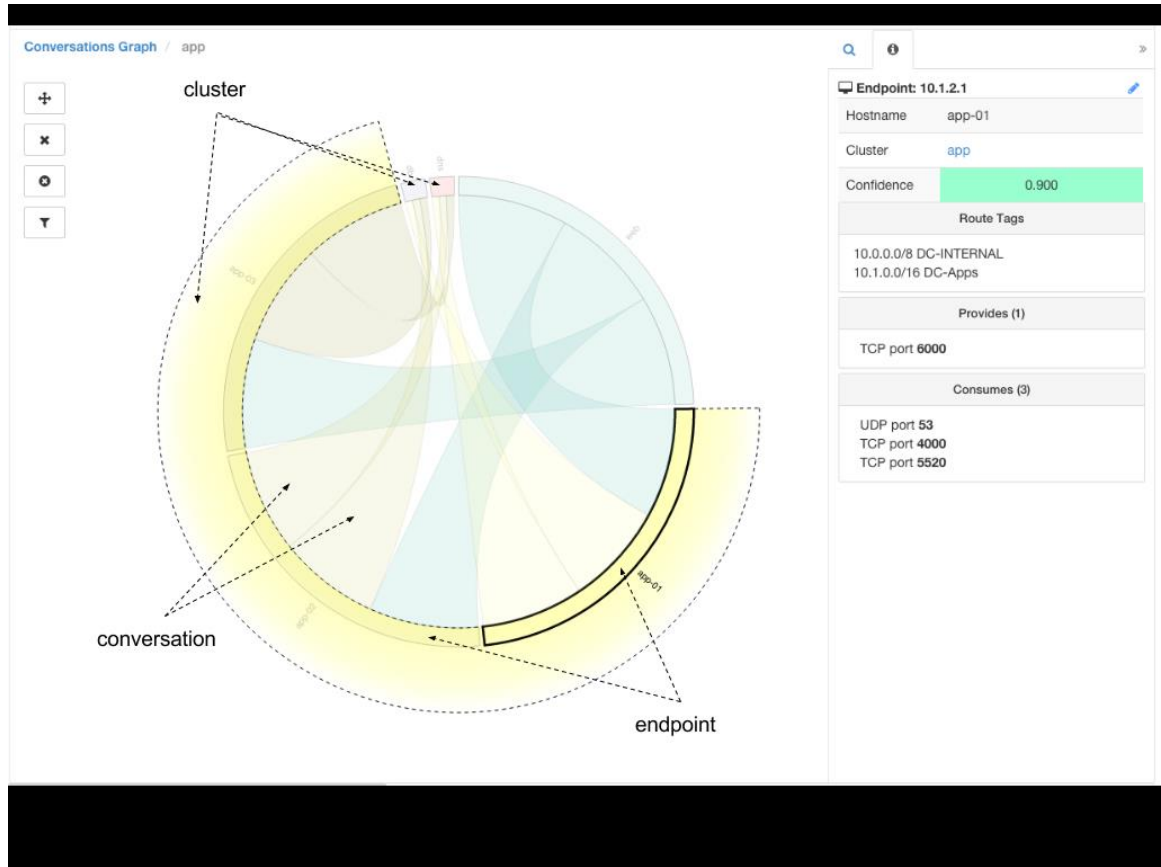

Top Consumers/Providers of Conversations

The number of top Consumers or Providers based on total conversations reflecting chosen filters can be seen from two buttons on top of the Conversations table. Click on each one to see a dialog containing a table with the Conversation Count column along with each Consumer/Provider's Address, Hostname, and other User Annotated columns.

Figure 103: Above the Conversations Table



Figure 104: Top Consumers Modal

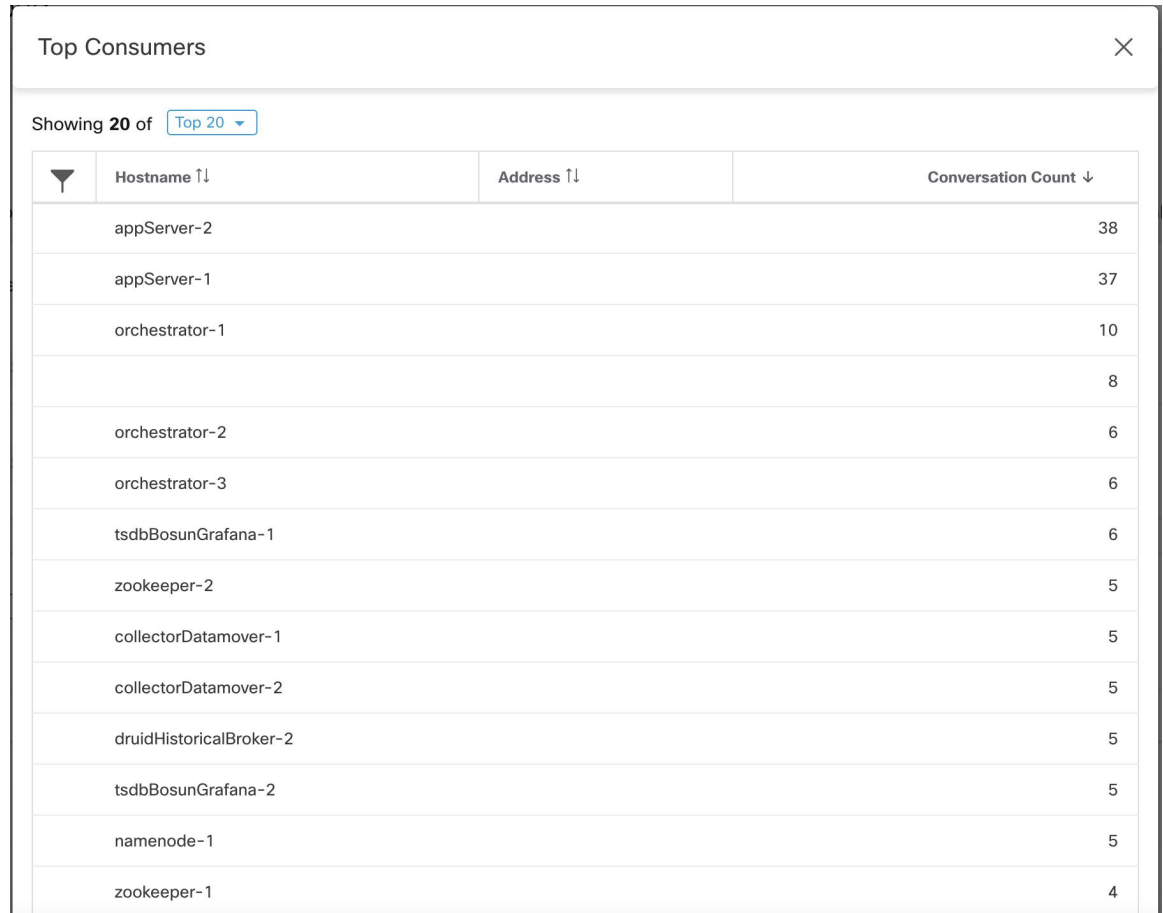

The screenshot shows a modal window titled "Top Consumers" with a close button in the top right corner. Below the title bar, it indicates "Showing 20 of" with a dropdown menu set to "Top 20". The main content is a table with three columns: "Hostname", "Address", and "Conversation Count". The table lists 14 hosts, sorted by their conversation count in descending order.

▼	Hostname ↑↓	Address ↑↓	Conversation Count ↓
	appServer-2		38
	appServer-1		37
	orchestrator-1		10
			8
	orchestrator-2		6
	orchestrator-3		6
	tsdbBosunGrafana-1		6
	zookeeper-2		5
	collectorDatamover-1		5
	collectorDatamover-2		5
	druidHistoricalBroker-2		5
	tsdbBosunGrafana-2		5
	namenode-1		5
	zookeeper-1		4

Figure 105: Top Providers Modal

The screenshot shows a modal window titled 'Top Providers' with a close button (X) in the top right corner. Below the title, it says 'Showing 20 of' followed by a dropdown menu set to 'Top 20'. The main content is a table with the following columns: a funnel icon, 'Hostname ↑↓', 'Address ↑↓', and 'Conversation Count ↓'. The table lists 20 providers, with the top ones being appServer-2 (38), appServer-1 (37), and orchestrator-1 (10).

	Hostname ↑↓	Address ↑↓	Conversation Count ↓
	appServer-2	1.1.1.44	38
	appServer-1	1.1.1.43	37
	orchestrator-1	1.1.1.252	10
		1.1.1.4	8
	orchestrator-2	1.1.1.253	6
	orchestrator-3	1.1.1.254	6
	tsdbBosunGrafana-1	1.1.1.32	6
	zookeeper-2	1.1.1.14	5
	collectorDatamover-1	1.1.1.26	5
	collectorDatamover-2	1.1.1.27	5
	druidHistoricalBroker-2	1.1.1.31	5
	tsdbBosunGrafana-2	1.1.1.33	5
	namenode-1	1.1.1.7	5
	zookeeper-1	1.1.1.13	4
	launcherHost-1	1.1.1.23	4

Automated Load Balancer Config for Automatic Policy Discovery (F5 Only)



Important This is an experimental feature.

This feature and its APIs are in **ALPHA** and are subject to changes and enhancements in future releases.

Automatic policy discovery generates policies from configuration for load balancers connected to an external orchestrator. Generating policies from configuration minimizes reliance on flow data and improves the accuracy of discovered clusters and policies.

It relies on clients to report flows to the load balancer for generating policies to permit this traffic.

Terminology

VIP Virtual IP: IP to which the client sends traffic that is destined for a service.

SNIP SNAT IP: IP used by the load balancer for sending traffic to backend hosts.

BE Backend Endpoint: IP of the backend host.

HIP Health-check IP: Source IP used by the load balancer for sending health-check traffic to backend hosts.



Note HIPs are the same as SNIPs in automap mode. However, HIPs and SNIPs can differ when a SNAT pool is configured.

Deployment

Figure 106: Deployment

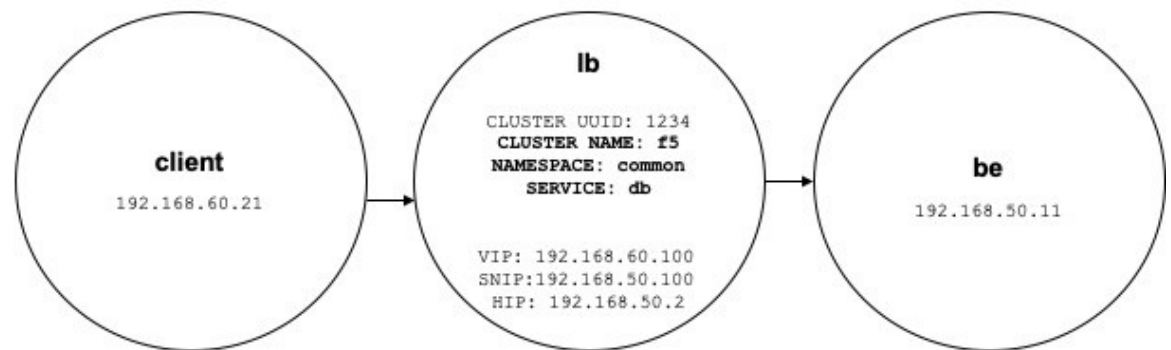

Consider the following deployment where load balancer VIPs, SNIPs, and HIPs are part of the *lb* scope, and BEs are part of the *be* scope. Scopes are created as follows.

- Client

The client scope includes clients communicating with the load balancer. For the example above, the *client* scope query is as follows:

```
address eq 192.168.60.21 or address eq 192.168.60.22
```

- lb

The F5 external orchestrator labels VIPs, SNIPs, HIPs, and BEs used by the load balancer. These labels can be used to construct scope queries, where *orchestrator_system/service_name* is used for selecting VIPs, *orchestrator_system/service_startpoint* SNIPs, and *orchestrator_system/service_healthcheck_startpoint* HIPs for the service. For the example above, a scope query that includes VIPs, SNIPs, and HIPs for service *db* is as follows:

```
user_orchestrator_system/cluster_id eq 1234 and
(user_orchestrator_system/service_name eq db or
user_orchestrator_system/service_startpoint eq db or
user_orchestrator_system/service_healthcheck_startpoint eq db)
```



Note It is required that SNIPs and VIPs be part of the same scope.

- **Be**

`user_orchestrator_system/service_endpoint` selects BEs for a service. For the example above, a scope query that includes BEs for service `db` is as follows:

```
user_orchestrator_system/cluster_id eq 1234 and
user_orchestrator_system/service_endpoint eq db
```

Clusters

Each service generates up to four discovered clusters, of which only the service cluster is visible to the user. SNIP, HIP, and BE clusters appear as related clusters for the service cluster. HIP and BE clusters are generated only when HIPs and BEs are present in the `lb` scope.

For the example above, automatic policy discovery generates a SNIP cluster and HIP cluster in the `lb` scope that include SNIPs and HIPs for service. Since BEs lie outside the `lb` scope, automatic policy discovery does not generate a backend cluster but instead adds the `be` scope to the list of related clusters for `db`.

Clusters are generated as follows:

- **Service**

The service cluster includes VIPs for service. The query for the service cluster as follows:

```
user_orchestrator_system/cluster_id eq 1234 and
user_orchestrator_system/namespace eq common and
user_orchestrator_system/service_name eq db
```

- **SNIP**

SNIPs for a service are included in the SNIP cluster. The query for the SNIP cluster is as follows:

```
user_orchestrator_system/cluster_id eq 1234 and
user_orchestrator_system/service_startpoint eq db
```

- **HIP**

HIPs for a service are included in the HIP cluster. The query for the HIP cluster is as follows:

```
user_orchestrator_system/cluster_id eq 1234 and
user_orchestrator_system/service_healthcheck_startpoint eq db
```

- **Backend**

A backend cluster for the service is generated when one or more BEs are part of the `lb` scope. This doesn't apply to the example above, resulting in a backend cluster not being generated in the `lb` scope.

Policies

Figure 107: Policy Generation

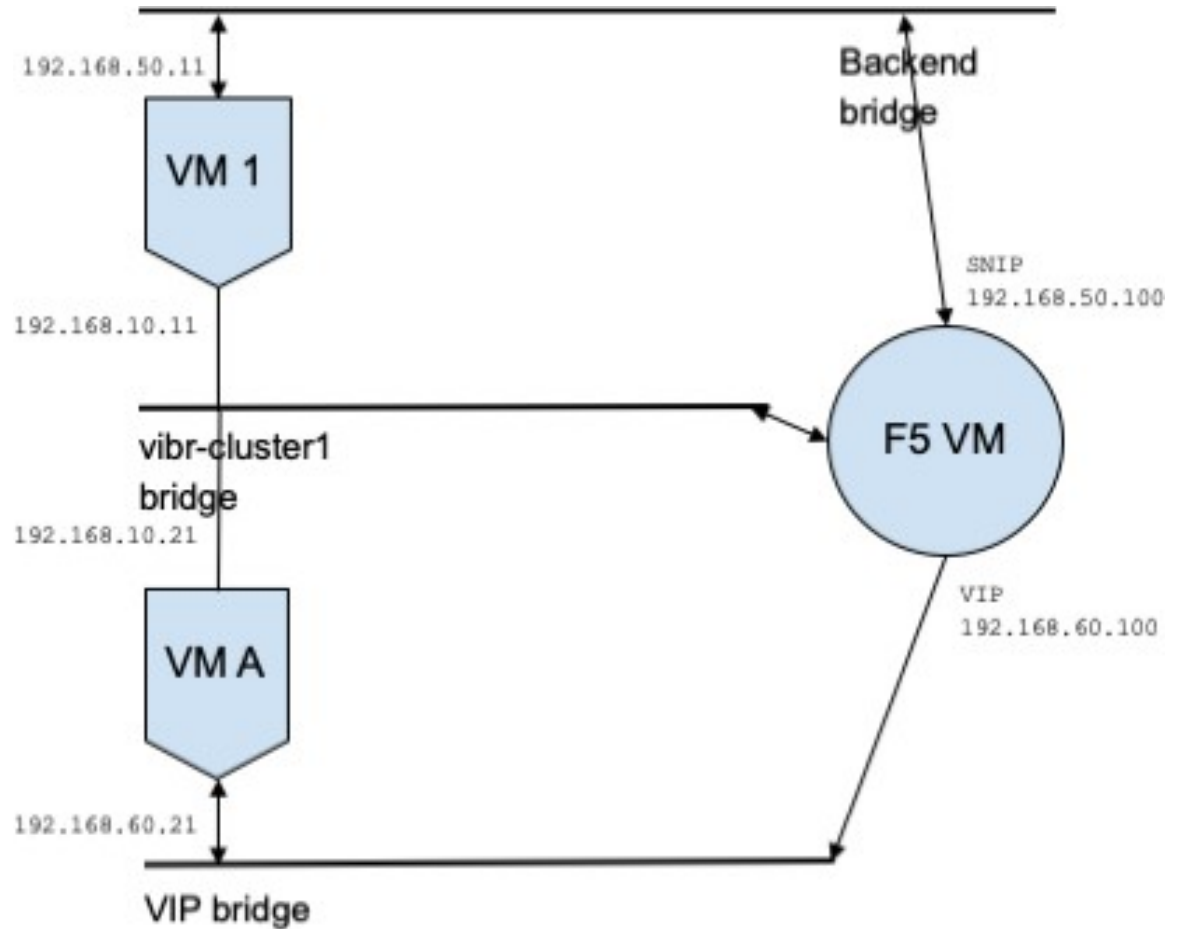

Assume we have a service *db* with VIP `192.168.60.100`, SNIP `192.168.50.100`, and a backend VM with IP `192.168.50.11` listening on port 10000. Traffic from client VM `192.168.60.21` to *db* results in the following policies:

- Policy from client to VIP

The following policy permits from the client VM to service *db*.

```
{
  "src": "<uuid of client scope>",
  "dst": "<uuid of service cluster>",
  "l4_params": [
    {
      "port": [
        10000,
        10000
      ],
      "proto": 6,
    }
  ]
}
```

- Policy from SNIP to BE.

A policy permitting traffic from the SNIP to the BE is autogenerated from configuration, and shows up as a related policy for *db*.

```
{
  "src": "<uuid of SNIP cluster>",
  "dst": "<uuid of be scope>",
  "l4_params": [
    {
      "port": [
        10000,
        10000
      ],
      "proto": 6,
    }
  ]
}
```

A policy connector from the *lb* scope to the *be* scope pushes the following policy to it.

Consumer	Provider	Port	Protocol	Action
SNIP	be	10000	TCP	Allow

This generates firewall rules on BE host 192.168.50.11 allowing incoming traffic from LB SNIP 192.168.50.100 on port 10000.

- Policy from HIP to BE.

A policy permitting traffic from the HIP to the BE is autogenerated from configuration, and shows up as a related policy for *db*.

```
{
  "src": "<uuid of HIP cluster>",
  "dst": "<uuid of be scope>",
  "l4_params": [
    {
      "port": [
        0,
        0
      ],
      "proto": ICMP,
    }
  ]
}
```

A policy connector from the *lb* scope to the *be* scope pushes the following policy to it.

Consumer	Provider	Port	Protocol	Action
HIP	be	0	ICMP	Allow

This generates firewall rules on BE host 192.168.50.11 allowing incoming ICMP traffic from LB HIP 192.168.50.2.

Caveats

- When multiple services from the same load balancer instance have the same name, backend rules generated for any of these services will include backend pools for all of them, i.e. rules will be more permissive than needed.

Policies Publisher

Policies Publisher is an advanced Cisco Secure Workload feature allowing third-party vendor to implement their own enforcement algorithms that are optimized for network appliances such as load balancers or firewalls. This feature is realized by publishing defined policies to a Kafka instance residing within Secure Workload cluster and by providing customers with Kafka client certificates, which allows third-party vendor code to retrieve policies from Kafka and to translate them into their network appliances configuration appropriately.

This section aims to describe the procedure third-party vendors, in short users in the following, must perform to exploit the *Policies Publisher* feature with Java on Linux.

Prerequisites

The following software packages are installed on a Linux system, such as Ubuntu 16.04.

- Java 8 JDK
- [Apache Kafka Clients](#): kafka-clients-1.0.0.jar
- [Protocol Buffers Core](#): protobuf-java-3.4.1.jar
- [Apache Log4j](#): log4j-1.2.17.jar
- [Simple Logging Facade for Java](#): slf4j-api-1.7.25.jar, slf4j-log4j12-1.7.25.jar
- [Snappy compressor/decompressor for Java](#): snappy-java-1.1.4.jar

Getting Kafka Client Certificates

- Create a user role with capability “*Owner*” and assign it to a user account of choice:

Figure 108: User Role Configuration to Receive Policies from Kafka

The screenshot shows a 'Role Details' form for a role named 'Policies Subscription'. The form includes fields for 'Name' (filled with 'Policies Subscription') and 'Description' (with a placeholder 'Enter a description (optional)'). Below these is a 'Scope' section with a dropdown menu currently set to 'Policies Subscription'. At the bottom of the form are two buttons: a blue 'Update' button with a checkmark icon and an orange 'Delete Role' button with a trash icon. Below the form is a 'Capabilities' table with two rows. The first row has 'Policies Subscription' in the 'Scope' column, 'Enforce' in the 'Ability' column, and a trash icon in the 'Action' column. The second row has 'Policies Subscription' in the 'Scope' column, 'Owner' in the 'Ability' column, and a trash icon in the 'Action' column. There is an 'Add Capability' button in the top right of the table area.

- Perform policies enforcement as described in [Enforce Policies](#). This first step is necessary as it creates a Kafka topic that is associated with active scope.
- Navigate to **Manage > Data Tap Admin**
- Select the tab “Data Taps” and download Kafka client certificates by clicking on the download button under column “Actions”. Make sure to select the *Java Keystore* format in the download dialog.

Figure 109: Data Taps View

The screenshot shows the 'Data Tap Admin - Data Taps' interface. It features a table with columns: Name, Topic, Description, Kafka Broker, Type, Status, and Actions. There are three rows of data. The first row is 'Alerts' with topic 'topic-611847e5497d4f628667761f', description 'DataTap Managed by Tetration', and Kafka Broker '172.31.178.25:4... and 2 more'. The second row is 'DataExport' with topic 'DataExportTopic-611847e5497d4f628', description 'DataTap Managed by Tetration', and Kafka Broker '172.31.178.25:4... and 2 more'. The third row is 'Policy Stream 676767' with a red 'ALPHA' badge, topic 'Policy-Stream-676767', description 'Tetration Network policy for Tenant676', and Kafka Broker '172.31.178.25:4... and 2 more'. All rows have 'Internal' type and 'Active' status. Each row has a download icon in the 'Actions' column. A '+ New Data Tap' button is in the top right.

Name	Topic	Description	Kafka Broker	Type	Status	Actions
Alerts	topic-611847e5497d4f628667761f	DataTap Managed by Tetration	172.31.178.25:4... and 2 more	Internal	Active	↓
DataExport	DataExportTopic-611847e5497d4f628	DataTap Managed by Tetration	172.31.178.25:4... and 2 more	Internal	Active	↓
Policy Stream 676767 ALPHA	Policy-Stream-676767	Tetration Network policy for Tenant676	172.31.178.25:4... and 2 more	Internal	Active	↓

- The downloaded clients certificates file usually has a name like *Policy-Stream-10-Policies-Subscription.jks.tar.gz*. Create a directory and unpack it underneath the created directory as below:

```
mkdir Policy-Stream-10-Policies-Subscription
tar -C Policy-Stream-10-Policies-Subscription -zxf
Policy-Stream-10-Policies-Subscription.jks.tar.gz
```

Protobuf Definition File

The network policies exposed by Secure Workload backend to Kafka are encoded in [Google Protocol Buffers](#) format. Refer to [this guide](#) for instructions how to download and install it on your Linux system.

The proto file of Secure Workload network policy can be downloaded from [here](#).

Data Model of Secure Workload Network Policy

Picture below shows a simplified UML diagram of Secure Workload entities exposed to Kafka:

Figure 110: Data Model of Secure Workload Network Policy

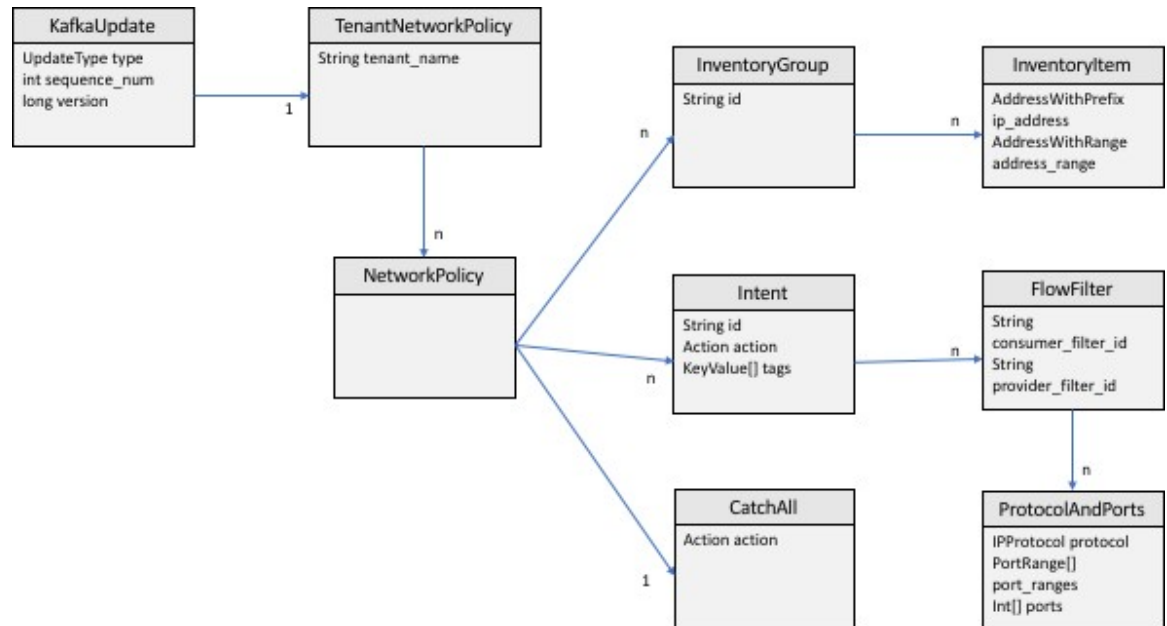

A *Secure Workload Network Policy* as modeled in protobuf consists of a list of *InventoryGroups*, a list of *Intents* and a *CatchAll* policy. Each policy contains all the items belonging to one root scope. An *InventoryGroup* contains a list of *InventoryItems*, which represent Secure Workload entities such as servers or appliances by specifying their network address, be it a singular network address, subnet or address range. An *Intent* describes action (allow or deny) to be taken when a network flow matches with the given consumer's *InventoryGroup*, provider's *InventoryGroup* and network protocols and ports. The *CatchAll* represents the catch-all action that is defined for the root scope inside Secure Workload. If no workspace with enforcement enabled exists for the root scope, a default policy of *ALLOW* is written to the produced policy.

When an enforcement is triggered by the users or by a change of inventory groups, Secure Workload backend sends a full snapshot of defined network policies to Kafka as a sequence of messages that are represented as *KafkaUpdates*. Refer to *KafkaUpdate*'s comments in *tetration_network_policy.proto* file for details how to reconstruct those messages to a full snapshot and how to handle error conditions.

In case *KafkaUpdate* message size is greater than 10MB, Secure Workload backend splits this message into multiple fragments, each of size 10MB. If there is multiple fragments, only the first fragment has the *ScopeInfo* field of *TenantNetworkPolicy*. The *ScopeInfo* will be set to nil in the remaining fragments of *KafkaUpdate* message.

Reference Implementation of Secure Workload Network Policies Client

For implementation and instructions on how to compile and run a demo client, see [tnp-enforcement-client](#) in Java.

This implementation provides common code to read network policies from Secure Workload policy stream via Kafka only. Vendor-specific code to program the actual policies to a network device can be plugged in by implementing the required interface [PolicyEnforcementClient](#).

Application Views



Note App View is deprecated and removed in the next Cisco Secure Workload release

Application Views play a central role in automatic policy discovery and help bridge the gap between the network and application teams. In other words, application views provide a bottom up way of exploring automatic policy discovery results with the goal of gaining insight into multitier datacenter applications like a web application. There could be thousands of such applications running in a datacenter. The application view helps you to focus on a particular one and share their view with other users.

Similar to automatic policy discovery workflows, the application list view provides a way to create new application views and view the existing ones by clicking on the tabular view.

Figure 111: App View List

Name	Description	Date created	Last modified
My App View		Apr 6 12:41:33pm	Apr 6 2:53:43pm

Building Application View Layout

Upon creation of a new application view, an empty canvas with the list of nodes (clusters, user-defined filters and Scopes) is presented. You can choose to **pin** certain nodes to the canvas and start exploring their neighbors in the sense of network policies. This page shows an extra tab on the right side panel with the list of all nodes.

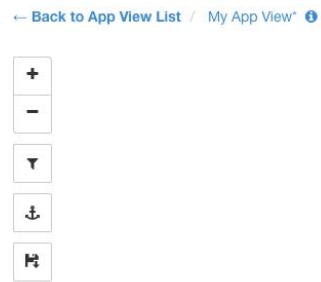
Figure 112: App View Empty Canvas

The tools on the left provide the ability to:

- Zoom in
- Zoom out
- Filter visible policies
- Anchor selected node positions
- Save App View state, make a copy or export node/policy data

Adding Nodes to Application View

Click on the **pin** button next to each item to add that node to the canvas, and double-click on any node on the canvas to **show** or **hide** its neighbors.

Figure 113: App View Pinning and Expanding Node

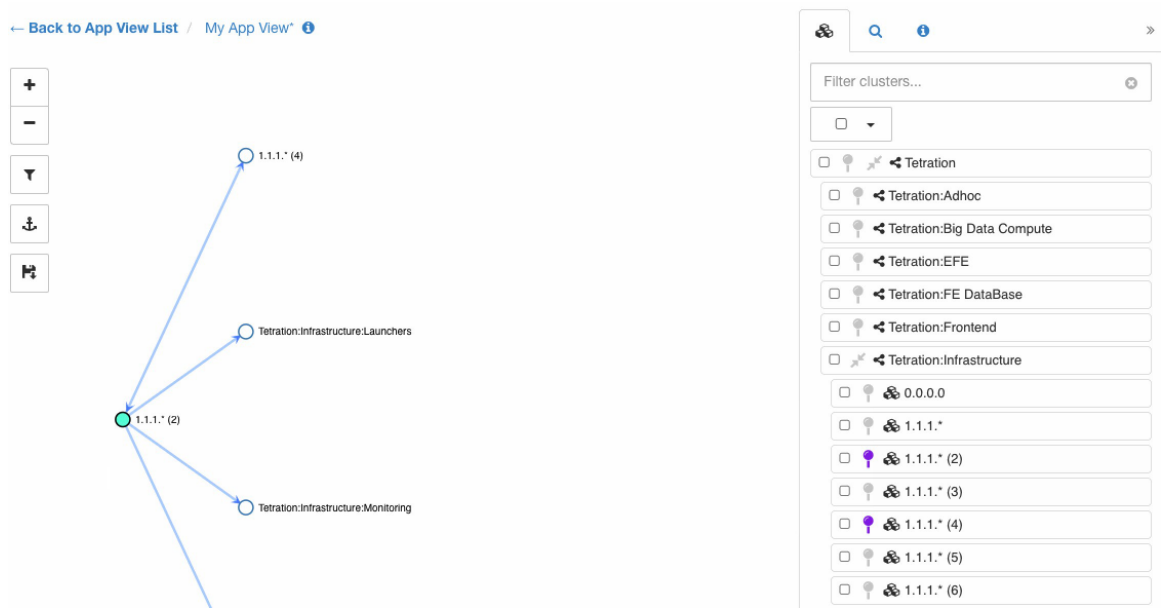

Adjusting Application View Layout



Note An edge between two nodes represents the set of network policies between the nodes. If one or more of the conversations between the nodes is going through a load balancer (defined as part of side information uploaded under advanced automatic policy discovery config), a load balancer icon is shown over the edge. More information can be seen by hovering or clicking over the presented elements.

We can move the nodes to any position to achieve the desired layout. In that case the you will be honored and an anchor icon appears on the node. To reset the position of the **anchored** node, click on the **anchor** button on the toolbar.

The following figure shows a fully expanded graph of our example multi-tier app.

Figure 114: App View Layout with Anchored Nodes

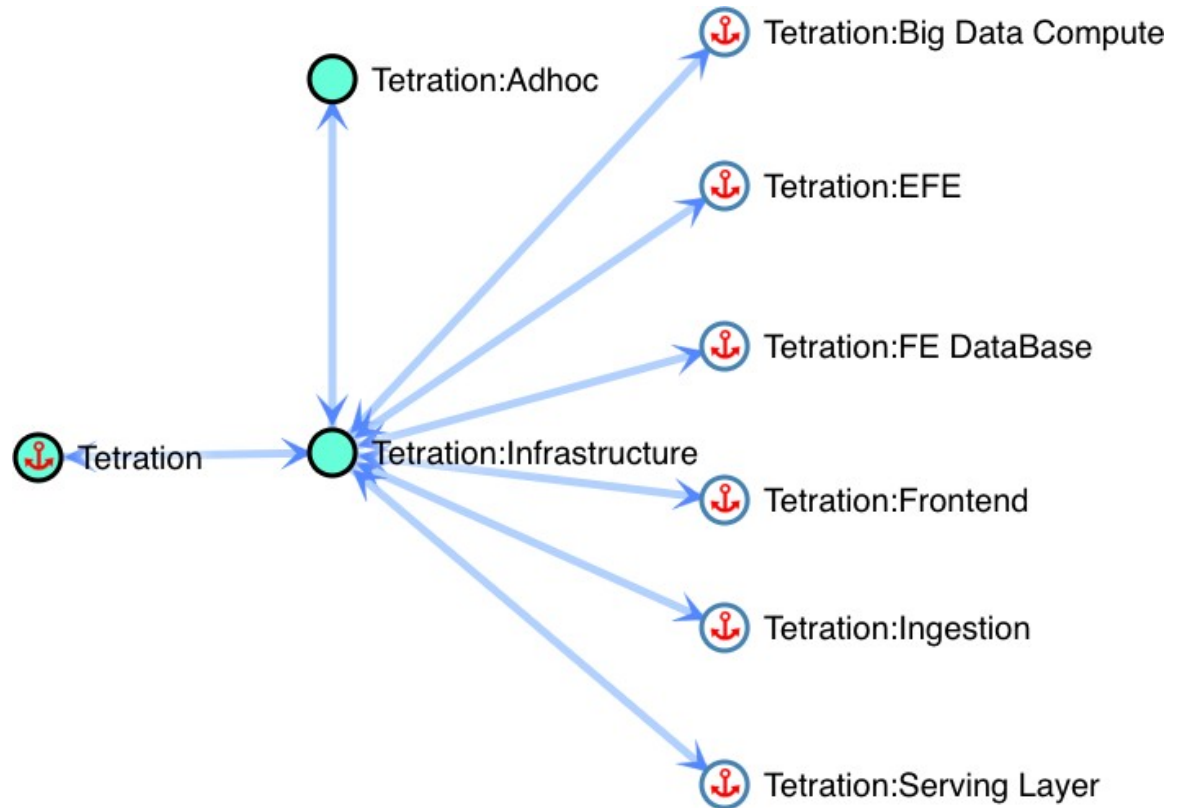

Example Multi-Tier Application

Click on the save button of the toolbar to save the current layout. This way other users can view the exact same layout of this particular workspace.



Note You can move multiple selected nodes all at once by holding the **SHIFT** key and dragging any of the selected nodes.

Expanding and Collapsing Scopes

Expand or **collapse** Scopes using the double-arrow icons within App View. When collapsing, all descendant nodes and their policies will be rolled up into the collapsed Scope. This may create edges between the collapsed Scope and other nodes, even if there isn't a policy directly connecting the two nodes because one of the collapsed Scope's children has a policy to that node. The rolled-up edges are reflected in the App View export, along with aggregated port list.

In new App Views, all Scopes are expanded by default.

Figure 115: App View Collapsing Scopes

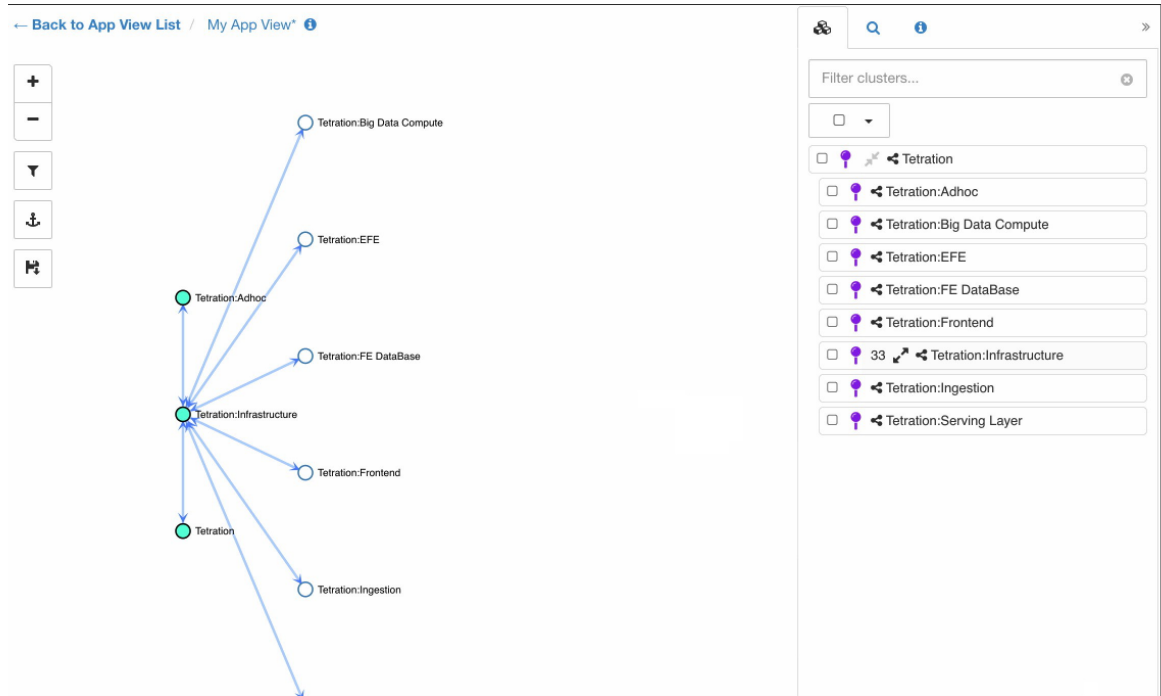

Policy Chord View



Note Policy Chord View is deprecated and will be removed in the next Cisco Secure Workload release.

Policy chord view provides a top-level graph view of all *ALLOW* policies in one chord chart with various ways to drill down and filter information.

The following figure shows some of the basic concepts of the policy chord chart. The arcs around the circumference of the chart represent clusters or partitions (group of clusters). Expanded partitions show up as a glow around all of the member clusters.

The chords represent a group of all policy intents between a pair of clusters, filters, or scopes. If a chord starts or ends at a partition, it represents the union of all policies from all the clusters inside that partition.

The chord represents bidirectional set of policies. The thickness of a chord on each side is proportional to the number of services that are consumed by the corresponding cluster or partition.

Tips:

- You can use the edit clusters view (see [Clusters](#)) to get a quick tabular view of clusters and their content. Use the policy view when you want to see the communications (the edges or policies).

Notes:

- Double-click on a partition arc to expand/collapse that partition.
- Single click on any of the chart elements, that is, partition, cluster, or policy selects or deselects that element. Moreover, the side panel gets updated with context information about the latest clicked element.
- Double-click on the canvas outside the chart to reset the chart to its original state.

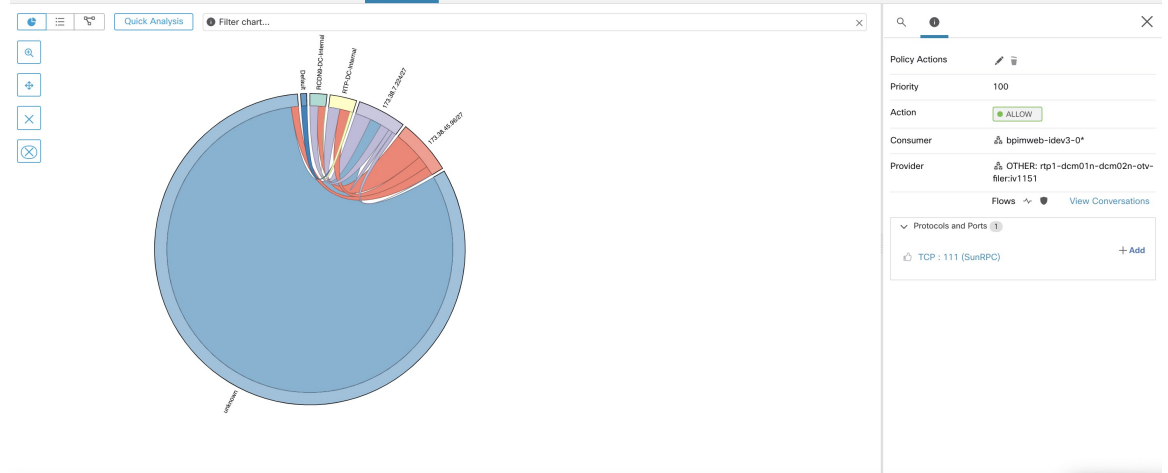
Figure 116: Policy Chord View

Chord Chart Toolbar

The set of controls or the toolbar on the top-left corner of the policy view page is designed to simplify interaction with large and complex charts by allowing the user to focus on a subset of the clusters and policies.

The **Filter** button helps filter out the policies by port and protocol. Green colored button indicates that the filter is active. Simply click **disable** to remove any filtering. See example below:

Figure 117: Chord Chart Toolbar

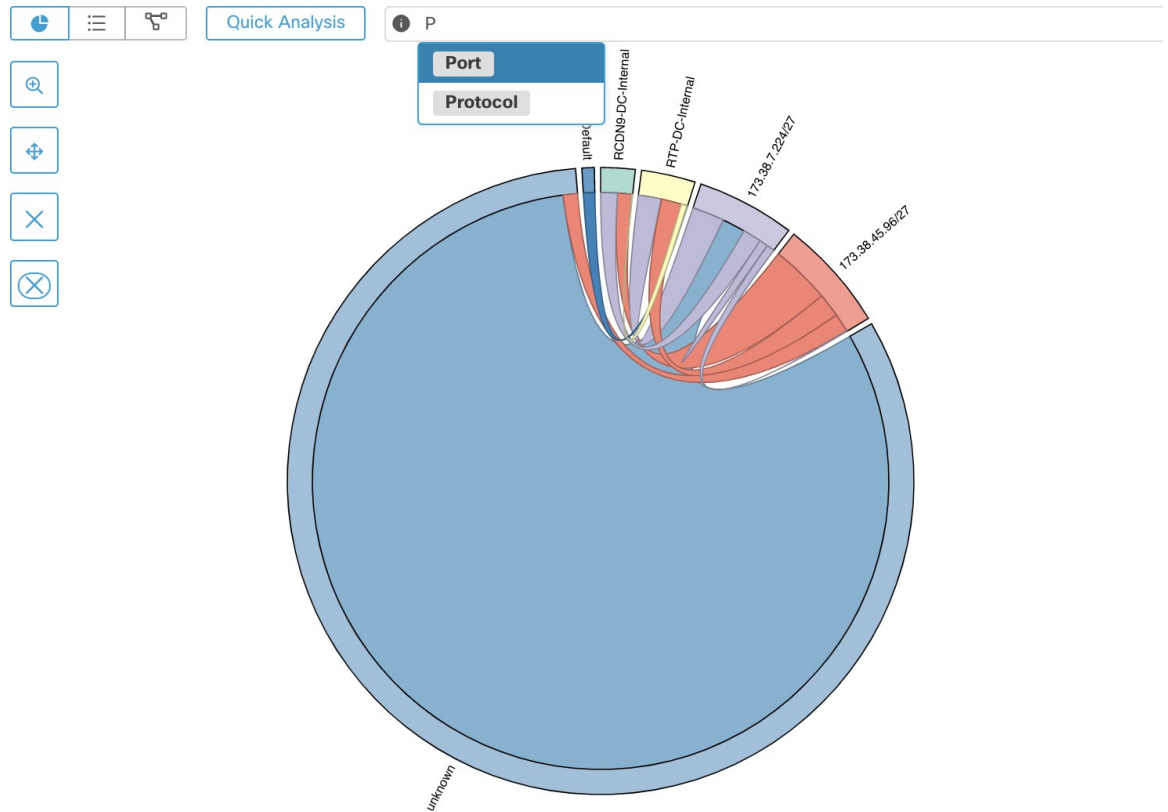

The **Show Cluster Detail** button helps drill down into the content of selected clusters and observe conversations/connections of the hosts inside the clusters.



Note At least one cluster (not partition) needs to be selected to have the ability to drill down into a cluster. The rest of the controls as their names indicate help remove unwanted clusters or policies or limit the chart to only one or more neighbors of a cluster.