



Implementing MPLS Label Distribution Protocol

The Multiprotocol Label Switching (MPLS) is a standards-based solution driven by the Internet Engineering Task Force (IETF) that was devised to convert the Internet and IP backbones from best-effort networks into business-class transport mediums.

MPLS, with its label switching capabilities, eliminates the need for an IP route look-up and creates a virtual circuit (VC) switching function, allowing enterprises the same performance on their IP-based network services as with those delivered over traditional networks such as Frame Relay or ATM.

Label Distribution Protocol (LDP) performs label distribution in MPLS environments. LDP provides the following capabilities:

- LDP performs hop-by-hop or dynamic path setup; it does not provide end-to-end switching services.
- LDP assigns labels to routes using the underlying Interior Gateway Protocols (IGP) routing protocols.
- LDP provides constraint-based routing using LDP extensions for traffic engineering.

Finally, LDP is deployed in the core of the network and is one of the key protocols used in MPLS-based Layer 2 and Layer 3 virtual private networks (VPNs).

Feature History for Implementing MPLS LDP

Release	Modification
Release 2.0	This feature was introduced.
Release 3.0	No modification.
Release 3.2	Support was added for conceptual and configuration information about LDP label advertisement control (Outbound label filtering).
Release 3.3.0	Support was added for these features: <ul style="list-style-type: none">• Inbound Label Filtering• Local Label Allocation Control• Session Protection• LDP-IGP Synchronization
Release 3.4.0	No modification.

Release	Modification
Release 3.4.1	No modification.
Release 3.5.0	Support was added for LDP Auto-configuration.
Release 3.6.0	Support was added for LDP nonstop routing (NSR).
Release 3.7.0	No modification.
Release 3.8.0	The feature LDP IGP Synchronization Process Restart Delay was introduced.
Release 3.9.0	No modification.
Release 4.0.1	Support was added for these features: <ul style="list-style-type: none"> • IP LDP Fast Reroute Loop Free Alternate • Downstream on Demand
Release 4.2.1	Support was added for LDP Implicit Null for IGP Routes.
Release 5.1	Support was added for MPLS over IRB.
Release 5.1.1	The feature MPLS LDP Carrier Supporting Carrier for Multiple VRFs was introduced.
Release 5.3.0	IPv6 Support in MPLS LDP was introduced.

- [Prerequisites for Implementing Cisco MPLS LDP, on page 2](#)
- [Information About Implementing Cisco MPLS LDP, on page 3](#)
- [How to Implement MPLS LDP, on page 30](#)
- [Configuration Examples for Implementing MPLS LDP, on page 89](#)
- [Additional References, on page 113](#)

Prerequisites for Implementing Cisco MPLS LDP

These prerequisites are required to implement MPLS LDP:

- You must be in a user group associated with a task group that includes the proper task IDs. The command reference guides include the task IDs required for each command. If you suspect user group assignment is preventing you from using a command, contact your AAA administrator for assistance.
- You must be running Cisco IOS XR software.
- You must install a composite mini-image and the MPLS package.
- You must activate IGP.
- We recommend to use a lower session holdtime bandwidth such as neighbors so that a session down occurs before an adjacency-down on a neighbor. Therefore, the following default values for the hello times are listed:
 - Holdtime is 15 seconds.
 - Interval is 5 seconds.

For example, the LDP session holdtime can be configured as 30 seconds by using the **holdtime** command.

Information About Implementing Cisco MPLS LDP

To implement MPLS LDP, you should understand these concepts:

Overview of Label Distribution Protocol

LDP performs label distribution in MPLS environments. LDP uses hop-by-hop or dynamic path setup, but does not provide end-to-end switching services. Labels are assigned to routes that are chosen by the underlying IGP routing protocols. The Label Switched Paths (LSPs) that result from the routes, forward labeled traffic across the MPLS backbone to adjacent nodes.

Label Switched Paths

LSPs are created in the network through MPLS. They can be created statically, by RSVP traffic engineering (TE), or by LDP. LSPs created by LDP perform hop-by-hop path setup instead of an end-to-end path.

LDP Control Plane

The control plane enables label switched routers (LSRs) to discover their potential peer routers and to establish LDP sessions with those peers to exchange label binding information.

Related Topics

[Configuring LDP Discovery Parameters](#), on page 30

[Configuring LDP Discovery Over a Link](#), on page 33

[Configuring LDP Link: Example](#), on page 89

[Configuring LDP Discovery for Active Targeted Hellos](#), on page 35

[Configuring LDP Discovery for Passive Targeted Hellos](#), on page 37

[Configuring LDP Discovery for Targeted Hellos: Example](#), on page 89

Exchanging Label Bindings

LDP creates LSPs to perform the hop-by-hop path setup so that MPLS packets can be transferred between the nodes on the MPLS network.

Figure 1: Setting Up Label Switched Paths

This figure illustrates the process of label binding exchange for setting up LSPs.

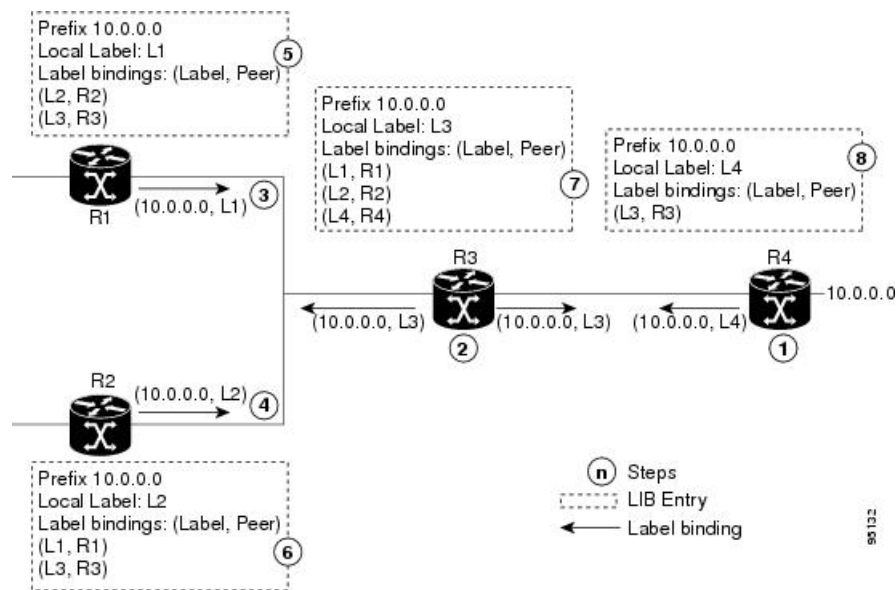

For a given network (10.0.0.0), hop-by-hop LSPs are set up between each of the adjacent routers (or, nodes) and each node allocates a local label and passes it to its neighbor as a binding:

1. R4 allocates local label L4 for prefix 10.0.0.0 and advertises it to its neighbors (R3).
2. R3 allocates local label L3 for prefix 10.0.0.0 and advertises it to its neighbors (R1, R2, R4).
3. R1 allocates local label L1 for prefix 10.0.0.0 and advertises it to its neighbors (R2, R3).
4. R2 allocates local label L2 for prefix 10.0.0.0 and advertises it to its neighbors (R1, R3).
5. R1's label information base (LIB) keeps local and remote labels bindings from its neighbors.
6. R2's LIB keeps local and remote labels bindings from its neighbors.
7. R3's LIB keeps local and remote labels bindings from its neighbors.
8. R4's LIB keeps local and remote labels bindings from its neighbors.

Related Topics

[Setting Up LDP Neighbors](#), on page 40

[Configuring LDP Neighbors: Example](#), on page 91

LDP Forwarding

Once label bindings are learned, the LDP control plane is ready to setup the MPLS forwarding plane as shown in the following figure.

Figure 2: Forwarding Setup

Once label bindings are learned, the LDP control plane is ready to setup the MPLS forwarding plane as shown in this figure.

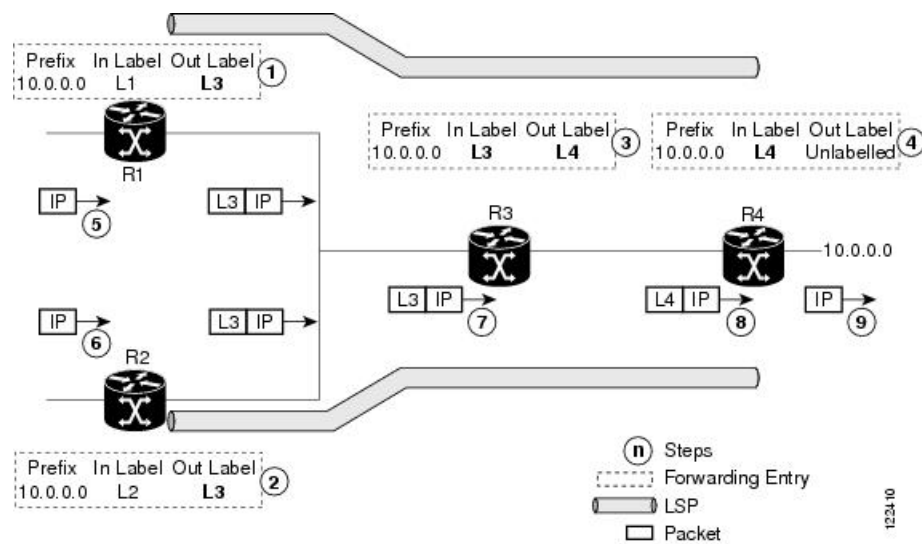

1. Because R3 is next hop for 10.0.0.0 as notified by the FIB, R1 selects label binding from R3 and installs forwarding entry (Layer 1, Layer 3).
2. Because R3 is next hop for 10.0.0.0 (as notified by FIB), R2 selects label binding from R3 and installs forwarding entry (Layer 2, Layer 3).
3. Because R4 is next hop for 10.0.0.0 (as notified by FIB), R3 selects label binding from R4 and installs forwarding entry (Layer 3, Layer 4).
4. Because next hop for 10.0.0.0 (as notified by FIB) is beyond R4, R4 uses NO-LABEL as the outbound and installs the forwarding entry (Layer 4); the outbound packet is forwarded IP-only.
5. Incoming IP traffic on ingress LSR R1 gets label-imposed and is forwarded as an MPLS packet with label L3.
6. Incoming IP traffic on ingress LSR R2 gets label-imposed and is forwarded as an MPLS packet with label L3.
7. R3 receives an MPLS packet with label L3, looks up in the MPLS label forwarding table and switches this packet as an MPLS packet with label L4.
8. R4 receives an MPLS packet with label L4, looks up in the MPLS label forwarding table and finds that it should be Unlabelled, pops the top label, and passes it to the IP forwarding plane.
9. IP forwarding takes over and forwards the packet onward.



Note For local labels, only up to 12000 rewrites are supported. If the rewrites exceed this limit, MPLS LSD or MPLS LDP or both the processes may crash.

Related Topics

[Setting Up LDP Forwarding](#), on page 43

[Configuring LDP Forwarding: Example](#), on page 91

LDP Graceful Restart

LDP (Label Distribution Protocol) graceful restart provides a control plane mechanism to ensure high availability and allows detection and recovery from failure conditions while preserving Nonstop Forwarding (NSF) services. Graceful restart is a way to recover from signaling and control plane failures without impacting forwarding.

Without LDP graceful restart, when an established session fails, the corresponding forwarding states are cleaned immediately from the restarting and peer nodes. In this case LDP forwarding restarts from the beginning, causing a potential loss of data and connectivity.

The LDP graceful restart capability is negotiated between two peers during session initialization time, in FT SESSION TLV. In this typed length value (TLV), each peer advertises the following information to its peers:

Reconnect time

Advertises the maximum time that other peer will wait for this LSR to reconnect after control channel failure.

Recovery time

Advertises the maximum time that the other peer has on its side to reinstate or refresh its states with this LSR. This time is used only during session reestablishment after earlier session failure.

FT flag

Specifies whether a restart could restore the preserved (local) node state for this flag.

Once the graceful restart session parameters are conveyed and the session is up and running, graceful restart procedures are activated.

When configuring the LDP graceful restart process in a network with multiple links, targeted LDP hello adjacencies with the same neighbor, or both, make sure that graceful restart is activated on the session before any hello adjacency times out in case of neighbor control plane failures. One way of achieving this is by configuring a lower session hold time between neighbors such that session timeout occurs before hello adjacency timeout. It is recommended to set LDP session hold time using the following formula:

```
Session Holdtime <= (Hello holdtime - Hello interval) * 3
```

This means that for default values of 15 seconds and 5 seconds for link Hello holdtime and interval respectively, session hold time should be set to 30 seconds at most.

For more information about LDP commands, see *MPLS Label Distribution Protocol Commands* module of the *MPLS Command Reference for the Cisco CRS Router*.

Related Topics

[Phases in Graceful Restart](#), on page 7

[Recovery with Graceful-Restart](#), on page 8

[Setting Up LDP NSF Using Graceful Restart](#), on page 47

[Configuring LDP Nonstop Forwarding with Graceful Restart: Example](#), on page 91

Control Plane Failure

When a control plane failure occurs, connectivity can be affected. The forwarding states installed by the router control planes are lost, and the in-transit packets could be dropped, thus breaking NSF.

Figure 3: Control Plane Failure

This figure illustrates a control plane failure and shows the process and results of a control plane failure leading to loss of connectivity.

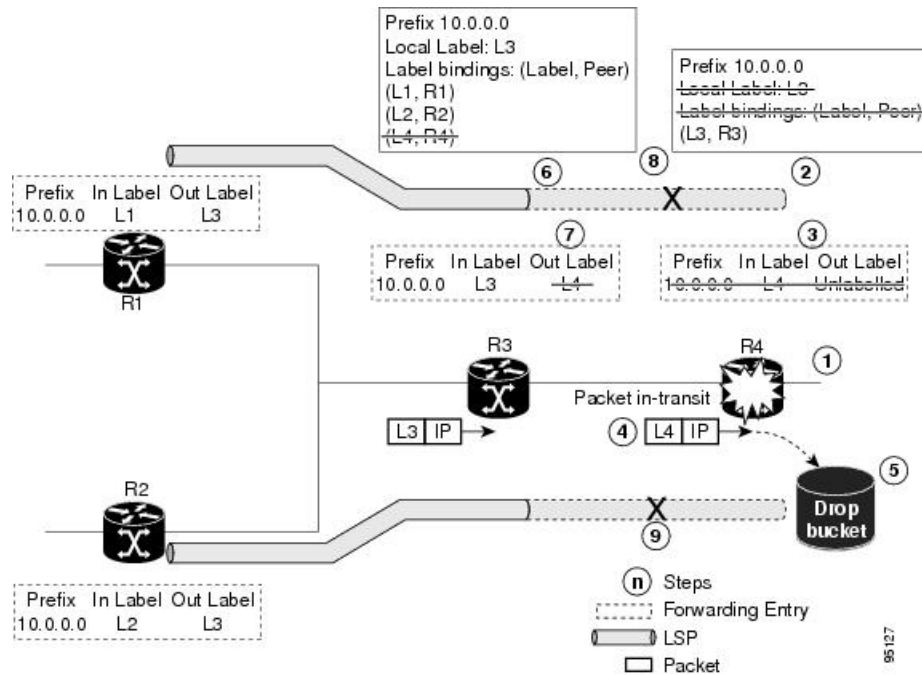

1. The R4 LSR control plane restarts.
2. LIB is lost when the control plane restarts.
3. The forwarding states installed by the R4 LDP control plane are immediately deleted.
4. Any in-transit packets flowing from R3 to R4 (still labeled with L4) arrive at R4.
5. The MPLS forwarding plane at R4 performs a lookup on local label L4 which fails. Because of this failure, the packet is dropped and NSF is not met.
6. The R3 LDP peer detects the failure of the control plane channel and deletes its label bindings from R4.
7. The R3 control plane stops using outgoing labels from R4 and deletes the corresponding forwarding state (rewrites), which in turn causes forwarding disruption.
8. The established LSPs connected to R4 are terminated at R3, resulting in broken end-to-end LSPs from R1 to R4.
9. The established LSPs connected to R4 are terminated at R3, resulting in broken LSPs end-to-end from R2 to R4.

Phases in Graceful Restart

The graceful restart mechanism is divided into different phases:

Control communication failure detection

Control communication failure is detected when the system detects either:

- Missed LDP hello discovery messages
- Missed LDP keepalive protocol messages
- Detection of Transmission Control Protocol (TCP) disconnection a with a peer

Forwarding state maintenance during failure

Persistent forwarding states at each LSR are achieved through persistent storage (checkpoint) by the LDP control plane. While the control plane is in the process of recovering, the forwarding plane keeps the forwarding states, but marks them as stale. Similarly, the peer control plane also keeps (and marks as stale) the installed forwarding rewrites associated with the node that is restarting. The combination of local node forwarding and remote node forwarding plane states ensures NSF and no disruption in the traffic.

Control state recovery

Recovery occurs when the session is reestablished and label bindings are exchanged again. This process allows the peer nodes to synchronize and to refresh stale forwarding states.

Related Topics

- [LDP Graceful Restart](#), on page 6
- [Recovery with Graceful-Restart](#), on page 8
- [Setting Up LDP NSF Using Graceful Restart](#), on page 47
- [Configuring LDP Nonstop Forwarding with Graceful Restart: Example](#), on page 91

Recovery with Graceful-Restart

Figure 4: Recovering with Graceful Restart

This figure illustrates the process of failure recovery using graceful restart.

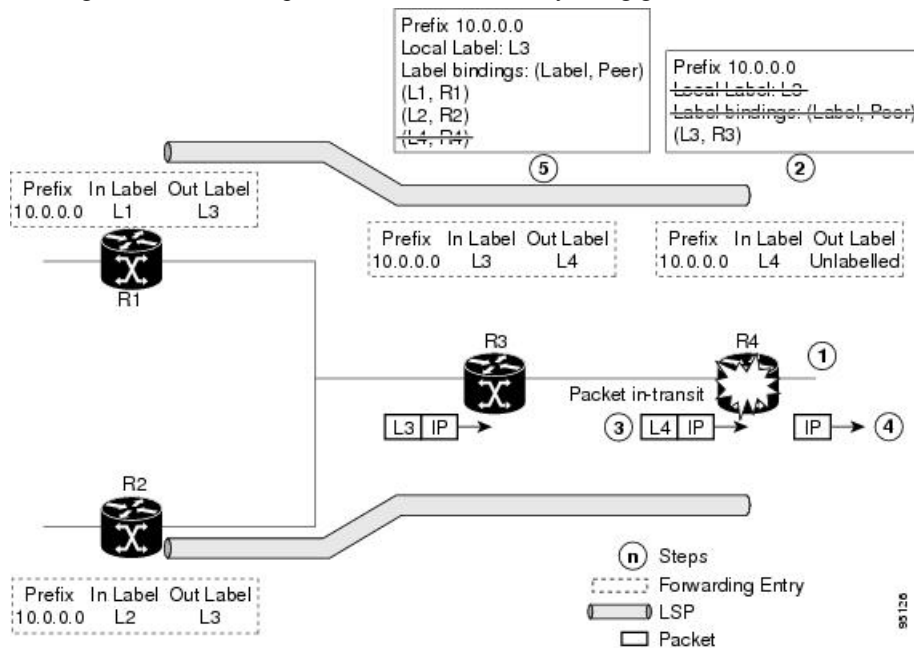

1. The router R4 LSR control plane restarts.

2. With the control plane restart, LIB is gone but forwarding states installed by R4's LDP control plane are not immediately deleted but are marked as stale.
3. Any in-transit packets from R3 to R4 (still labeled with L4) arrive at R4.
4. The MPLS forwarding plane at R4 performs a successful lookup for the local label L4 as forwarding is still intact. The packet is forwarded accordingly.
5. The router R3 LDP peer detects the failure of the control plane and channel and deletes the label bindings from R4. The peer, however, does not delete the corresponding forwarding states but marks them as stale.
6. At this point there are no forwarding disruptions.
7. The peer also starts the neighbor reconnect timer using the reconnect time value.
8. The established LSPs going toward the router R4 are still intact, and there are no broken LSPs.

When the LDP control plane recovers, the restarting LSR starts its forwarding state hold timer and restores its forwarding state from the checkpointed data. This action reinstates the forwarding state and entries and marks them as old.

The restarting LSR reconnects to its peer, indicated in the FT Session TLV, that it either was or was not able to restore its state successfully. If it was able to restore the state, the bindings are resynchronized.

The peer LSR stops the neighbor reconnect timer (started by the restarting LSR), when the restarting peer connects and starts the neighbor recovery timer. The peer LSR checks the FT Session TLV if the restarting peer was able to restore its state successfully. It reinstates the corresponding forwarding state entries and receives binding from the restarting peer. When the recovery timer expires, any forwarding state that is still marked as stale is deleted.

If the restarting LSR fails to recover (restart), the restarting LSR forwarding state and entries will eventually timeout and is deleted, while neighbor-related forwarding states or entries are removed by the Peer LSR on expiration of the reconnect or recovery timers.

Related Topics

[LDP Graceful Restart](#), on page 6

[Phases in Graceful Restart](#), on page 7

[Setting Up LDP NSF Using Graceful Restart](#), on page 47

[Configuring LDP Nonstop Forwarding with Graceful Restart: Example](#), on page 91

Label Advertisement Control (Outbound Filtering)

By default, LDP advertises labels for all the prefixes to all its neighbors. When this is not desirable (for scalability and security reasons), you can configure LDP to perform outbound filtering for local label advertisement for one or more prefixes to one more peers. This feature is known as *LDP outbound label filtering*, or *local label advertisement control*.

Related Topics

[Configuring Label Advertisement Control \(Outbound Filtering\)](#), on page 39

[Configuring Label Advertisement \(Outbound Filtering\): Example](#), on page 90

Label Acceptance Control (Inbound Filtering)

By default, LDP accepts labels (as remote bindings) for all prefixes from all peers. LDP operates in liberal label retention mode, which instructs LDP to keep remote bindings from all peers for a given prefix. For security reasons, or to conserve memory, you can override this behavior by configuring label binding acceptance for set of prefixes from a given peer.

The ability to filter remote bindings for a defined set of prefixes is also referred to as *LDP inbound label filtering*.



Note Inbound filtering can also be implemented using an outbound filtering policy; however, you may not be able to implement this system if an LDP peer resides under a different administration domain. When both inbound and outbound filtering options are available, we recommend that you use outbound label filtering.

Related Topics

[Configuring Label Acceptance Control \(Inbound Filtering\)](#), on page 50

[Configuring Label Acceptance \(Inbound Filtering\): Example](#), on page 92

Local Label Allocation Control

By default, LDP allocates local labels for all prefixes that are not Border Gateway Protocol (BGP) prefixes¹. This is acceptable when LDP is used for applications other than Layer 3 virtual private networks (L3VPN) core transport. When LDP is used to set up transport LSPs for L3VPN traffic in the core, it is not efficient or even necessary to allocate and advertise local labels for, potentially, thousands of IGP prefixes. In such a case, LDP is typically required to allocate and advertise local label for loopback /32 addresses for PE routers. This is accomplished using LDP local label allocation control, where an access list can be used to limit allocation of local labels to a set of prefixes. Limiting local label allocation provides several benefits, including reduced memory usage requirements, fewer local forwarding updates, and fewer network and peer updates.



Tip You can configure label allocation using an IP access list to specify a set of prefixes that local labels can allocate and advertise.

Related Topics

[Configuring Local Label Allocation Control](#), on page 51

[Configuring Local Label Allocation Control: Example](#), on page 92

Session Protection

When a link comes up, IP converges earlier and much faster than MPLS LDP and may result in MPLS traffic loss until MPLS convergence. If a link flaps, the LDP session will also flap due to loss of link discovery. LDP session protection minimizes traffic loss, provides faster convergence, and protects existing LDP (link) sessions by means of “parallel” source of targeted discovery hello. An LDP session is kept alive and neighbor label bindings are maintained when links are down. Upon reestablishment of primary link adjacencies, MPLS convergence is expedited as LDP need not relearn the neighbor label bindings.

¹ For L3VPN Inter-AS option C, LDP may also be required to assign local labels for some BGP prefixes.

LDP session protection lets you configure LDP to automatically protect sessions with all or a given set of peers (as specified by peer-acl). When configured, LDP initiates backup targeted hellos automatically for neighbors for which primary link adjacencies already exist. These backup targeted hellos maintain LDP sessions when primary link adjacencies go down.

The Session Protection figure illustrates LDP session protection between neighbors R1 and R3. The primary link adjacency between R1 and R3 is directly connected link and the backup; targeted adjacency is maintained between R1 and R3. If the direct link fails, LDP link adjacency is destroyed, but the session is kept up and running using targeted hello adjacency (through R2). When the direct link comes back up, there is no change in the LDP session state and LDP can converge quickly and begin forwarding MPLS traffic.

Figure 5: Session Protection

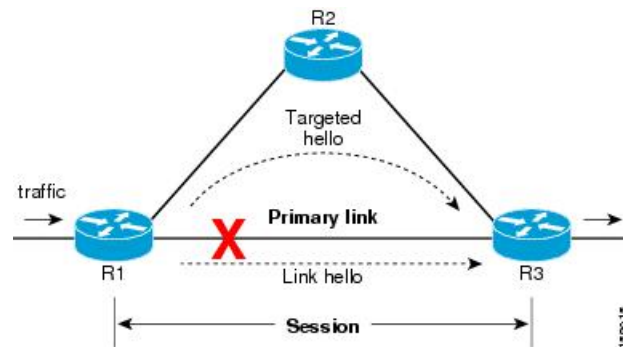

Note When LDP session protection is activated (upon link failure), protection is maintained for an unlimited period time.

Related Topics

[Configuring Session Protection](#), on page 52

[Configuring LDP Session Protection: Example](#), on page 92

IGP Synchronization

Lack of synchronization between LDP and IGP can cause MPLS traffic loss. Upon link up, for example, IGP can advertise and use a link before LDP convergence has occurred; or, a link may continue to be used in IGP after an LDP session goes down.

LDP IGP synchronization synchronizes LDP and IGP so that IGP advertises links with regular metrics only when MPLS LDP is converged on that link. LDP considers a link converged when at least one LDP session is up and running on the link for which LDP has sent its applicable label bindings and received at least one label binding from the peer. LDP communicates this information to IGP upon link up or session down events and IGP acts accordingly, depending on sync state.

In the event of an LDP graceful restart session disconnect, a session is treated as converged as long as the graceful restart neighbor is timed out. Additionally, upon local LDP restart, a checkpointed recovered LDP graceful restart session is used and treated as converged and is given an opportunity to connect and resynchronize.

Under certain circumstances, it might be required to delay declaration of resynchronization to a configurable interval. LDP provides a configuration option to delay declaring synchronization up for up to 60 seconds. LDP communicates this information to IGP upon linkup or session down events.



Note The configuration for LDP IGP synchronization resides in respective IGPs (OSPF and IS-IS) and there is no LDP-specific configuration for enabling of this feature. However, there is a specific LDP configuration for IGP sync delay timer.

Related Topics

[Configuring LDP IGP Synchronization: OSPF](#), on page 53

[Configuring LDP IGP Synchronization—OSPF: Example](#), on page 93

[Configuring LDP IGP Synchronization: IS-IS](#), on page 56

[Configuring LDP IGP Synchronization—IS-IS: Example](#), on page 93

[Configuring LDP IGP Synchronization Delay Interval](#), on page 57

IGP Auto-configuration

To enable LDP on a large number of interfaces, IGP auto-configuration lets you automatically configure LDP on all interfaces associated with a specified IGP interface; for example, when LDP is used for transport in the core network. However, there needs to be one IGP set up to enable LDP auto-configuration.

Typically, LDP assigns and advertises labels for IGP routes and must often be enabled on all active interfaces by an IGP. Without IGP auto-configuration, you must define the set of interfaces under LDP, a procedure that is time-intensive and error-prone.



Note LDP auto-configuration is supported for IPv4 unicast family in the default VRF. The IGP is responsible for verifying and applying the configuration.

You can also disable auto-configuration on a per-interface basis. This permits LDP to enable all IGP interfaces except those that are explicitly disabled and prevents LDP from enabling an interface when LDP auto-configuration is configured under IGP.

Related Topics

[Enabling LDP Auto-Configuration for a Specified OSPF Instance](#), on page 59

[Enabling LDP Auto-Configuration in an Area for a Specified OSPF Instance](#), on page 60

[Disabling LDP Auto-Configuration](#), on page 61

[Configuring LDP Auto-Configuration: Example](#), on page 93

IGP Synchronization Process Restart Delay

In the LDP IGP synchronization process, failures and restarts bear a heavy stress on the network. Multiple IGP synchronization notifications from LDP to IGP, and potential generation of multiple SPF and LSAs are known to effect the CPU load considerably. This results in considerable traffic loss when the LDP process fails.

The LDP IGP Synchronization Process Restart Delay is a feature that enables a process-level delay for synchronization events when the LDP fails or restarts. This delay defers the sending of sync-up events to the

IGP until most or all the LDP sessions converge and also allows the LDP to stabilize. This allows the LDP process failure to be less stressful, since IGP's receive all the sync-up events in one bulk. This means that IGP is required to run the SPF and LSAs only one time with an overall view of the sync-up events.



Note By default the IGP Synchronization Process Restart Delay is disabled and can be enabled by running the configuration command `mpls ldp igp sync delay on-proc-restart`.

Related Topics

[Configuring LDP IGP Synchronization Process Restart Delay](#), on page 58

LDP Nonstop Routing

LDP nonstop routing (NSR) functionality makes failures, such as Route Processor (RP) or Distributed Route Processor (DRP) failover, invisible to routing peers with minimal to no disruption of convergence performance. By default, NSR is globally enabled on all LDP sessions except AToM.

A disruption in service may include any of these events:

- Route processor (RP) or distributed route processor (DRP) failover
- LDP process restart
- In-service system upgrade (ISSU)
- Minimum disruption restart (MDR)



Note Unlike graceful restart functionality, LDP NSR does not require protocol extensions and does not force software upgrades on other routers in the network, nor does LDP NSR require peer routers to support NSR.

Process failures of active TCP or LDP results in session loss and, as a result, NSR cannot be provided unless RP switchover is configured as a recovery action. For more information about how to configure switchover as a recovery action for NSR, see *Configuring Transports* module in *IP Addresses and Services Configuration Guide for Cisco CRS Routers*.

Related Topics

[Configuring LDP Nonstop Routing](#), on page 62

IP LDP Fast Reroute Loop Free Alternate

The IP Fast Reroute is a mechanism that enables a router to rapidly switch traffic, after an adjacent link failure, node failure, or both, towards a pre-programmed loop-free alternative (LFA) path. This LFA path is used to switch traffic until the router installs a new primary next hop again, as computed for the changed network topology.

The goal of LFA FRR is to reduce failure reaction time to 50 milliseconds by using a pre-computed alternate next hop, in the event that the currently selected primary next hop fails, so that the alternate can be rapidly used when the failure is detected.

This feature targets to address the fast convergence ability by detecting, computing, updating or enabling prefix independent pre-computed alternate loop-free paths at the time of failure.

IGP pre-computes a backup path per IGP prefix. IGP selects one and only one backup path per primary path. RIB installs the best path and download path protection information to FIB by providing correct annotation for protected and protecting paths. FIB pre-installs the backup path in dataplane. Upon the link or node failure, the routing protocol detects the failure, all the backup paths of the impacted prefixes are enabled in a prefix-independent manner.

Prerequisites

The Label Distribution Protocol (LDP) can use the loop-free alternates as long as these prerequisites are met:

The Label Switching Router (LSR) running LDP must distribute its labels for the Forwarding Equivalence Classes (FECs) it can provide to all its neighbors, regardless of whether they are upstream, or not.

There are two approaches in computing LFAs:

- **Link-based (per-link)**--In link-based LFAs, all prefixes reachable through the primary (protected) link share the same backup information. This means that the whole set of prefixes, sharing the same primary, also share the repair or fast reroute (FRR) ability. The per-link approach protects only the next hop address. The per-link approach is suboptimal and not the best for capacity planning. This is because all traffic is redirected to the next hop instead of being spread over multiple paths, which may lead to potential congestion on link to the next hop. The per-link approach does not provide support for node protection.
- **Prefix-based (per-prefix)**--Prefix-based LFAs allow computing backup information per prefix. It protects the destination address. The per-prefix approach is the preferred approach due to its greater applicability, and the greater protection and better bandwidth utilization that it offers.



Note The repair or backup information computed for a given prefix using prefix-based LFA may be different from the computed by link-based LFA.

The per-prefix LFA approach is preferred for LDP IP Fast Reroute LFA for these reasons:

- Better node failure resistance
- Better capacity planning and coverage

Features Not Supported

These interfaces and features are not supported for the IP LDP Fast Reroute Loop Free Alternate feature:

- BVI interface (IRB) is not supported either as primary or backup path.
- GRE tunnel is not supported either as primary or backup path.
- In a multi-topology scenerio, the route in topology T can only use LFA within topology T. Hence, the availability of a backup path depends on the topology.

For more information about configuring the IP Fast Reroute Loop-free alternate , see Implementing IS-IS on Cisco IOS XR Software module of the *Routing Configuration Guide for Cisco CRS Routers*.

Related Topics

[Configure IP LDP Fast Reroute Loop Free Alternate: Examples](#), on page 94

[Verify IP LDP Fast Reroute Loop Free Alternate: Example](#), on page 96

Downstream on Demand

This Downstream on demand feature adds support for downstream-on-demand mode, where the label is not advertised to a peer, unless the peer explicitly requests it. At the same time, since the peer does not automatically advertise labels, the label request is sent whenever the next-hop points out to a peer that no remote label has been assigned.

To enable downstream-on-demand mode, this configuration must be applied at mpls ldp configuration mode:

```
mpls ldp downstream-on-demand with ACL
```

The ACL contains a list of peer IDs that are configured for downstream-on-demand mode. When the ACL is changed or configured, the list of established neighbors is traversed. If a session's downstream-on-demand configuration has changed, the session is reset in order that the new downstream-on-demand mode can be configured. The reason for resetting the session is to ensure that the labels are properly advertised between the peers. When a new session is established, the ACL is verified to determine whether the session should negotiate for downstream-on-demand mode. If the ACL does not exist or is empty, downstream-on-demand mode is not configured for any neighbor.

For it to be enabled, the Downstream on demand feature has to be configured on both peers of the session. If only one peer in the session has downstream-on-demand feature configured, then the session does not use downstream-on-demand mode.

If, after, a label request is sent, and no remote label is received from the peer, the router will periodically resend the label request. After the peer advertises a label after receiving the label request, it will automatically readvertise the label if any label attribute changes subsequently.

Related Topics

[Configuring LDP Downstream on Demand mode](#), on page 64

Explicit-Null and Implicit-Null Labels

Cisco MPLS LDP uses null label, implicit or explicit, as local label for routes or prefixes that terminate on the given LSR. These routes include all local, connected, and attached networks. By default, the null label is **implicit-null** that allows LDP control plane to implement penultimate hop popping (PHOP) mechanism.

When this is not desirable, you can configure **explicit-null** that allows LDP control plane to implement ultimate hop popping (UHOP) mechanism. You can configure this explicit-null feature on the ultimate hop LSR. This configuration knob includes an access-list to specify the IP prefixes for which PHOP is desired.

This new enhancement allows you to configure implicit-null local label for **non-egress (ultimate hop LSR)** prefixes by using the **implicit-null-override** command. This enforces implicit-null local label for a specific prefix even if the prefix requires a non-null label to be allocated by default. For example, by default, an LSR allocates and advertises a non-null label for an IGP route. If you wish to terminate LSP for this route on penultimate hop of the LSR, you can enforce implicit-null label allocation and advertisement for this prefix using **implicit-null-override** feature.



Note If a given prefix is permitted in both explicit-null and implicit-null-override feature, then implicit-null-override supercedes and an implicit-null label is allocated and advertised for the prefix.

In order to enable implicit-null-override mode, this configuration must be applied at MPLS LDP label configuration mode:

```
mpls ldp
  label
    implicit-null-override for <prefix><ACL>

!
```

This feature works with any prefix including static, IGP, and BGP, when specified in the ACL.

MPLS over IRB

The Integrated Routing and Bridging (IRB) feature in Cisco IOS XR Software enables routing of a given protocol between routed interfaces and bridge groups within a single router. IRB support for MPLS introduces these capabilities:

- Bridge-Group Virtual Interface (BVI) support under MPLS LDP
- Targeted LDP session to BVI neighbor
- MPLS OAM for BVI interfaces
- Netflow for BVI interfaces while MPLS is enabled
- L2VPN using targeted MPLS LDP to BVI destination
- L3VPN
- 6PE/6VPE

MPLS over IRB is supported completely on ASR 9000 Enhanced Ethernet Line Card and Cisco ASR 9001. MPLS over IRB is not supported on ASR 9000 Ethernet Line Card.

For more information on MPLS over IRB, see the *Implementing MPLS Label Distribution Protocol* chapter in the *MPLS Configuration Guide for the Cisco CRS Routers*. For more information on MPLS over IRB commands, see the *MPLS Label Distribution Protocol Commands* chapter in the *MPLS Command Reference for the Cisco CRS Router*.

MPLS LDP Carrier Supporting Carrier for Multiple VRFs

The carrier supporting carrier (CSC) support for MPLS LDP feature enables MPLS label distribution protocol (LDP) to provide CSC support for Layer 3 Virtual Private Networks (L3VPN). To support LDP as label distribution protocol between PE-CE devices in an MPLS CSC L3VPN, LDP is required to operate in multiple Virtual Private Network routing and forwarding (VRF) contexts.

MPLS Carrier Supporting Carrier L3VPN: Introduction

The carrier supporting carrier feature enables one MPLS VPN-based service provider to allow other service providers to use a segment of its backbone network. The service provider that provides the segment of the backbone network to the other provider is called the *backbone carrier*. The service provider that uses the segment of the backbone network is called the *customer carrier*.

A backbone carrier offers Border Gateway Protocol and Multiprotocol Label Switching (BGP/MPLS) VPN services. The customer carrier can be either:

- An Internet service provider (ISP)
- A BGP/MPLS VPN service provider

In either case, MPLS is run in the backbone network and between the backbone and customer carrier (the PE-CE link).

Figure 6: MPLS Carrier Supporting Carrier L3VPN

This figure illustrates an MPLS CSC L3VPN.

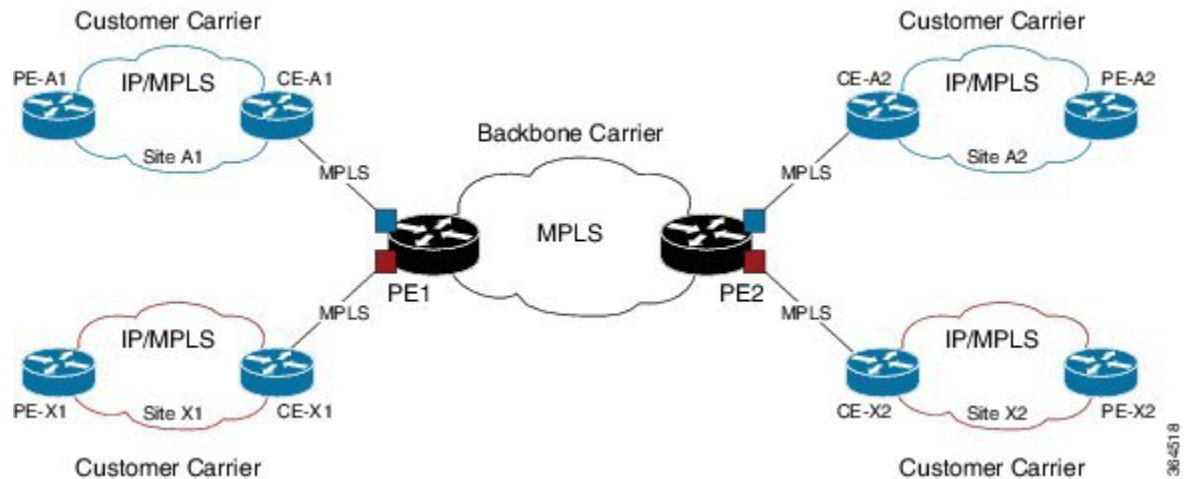

The figure shows two customers, A and X, connecting their remote sites through the backbone carrier. The PE device of the backbone network connects with both customers through MPLS but under different VRFs according to interface-VRF mapping. The MPLS label distribution protocol for PE-CE connectivity can be either BGP or LDP, and requires them to run in a customer VRF context on the PE device.

Benefits of MPLS LDP CSC

The MPLS LDP CSC provides the following benefits to service providers who are backbone carriers and to customer carriers.

Benefits to the Backbone Carrier

- The backbone carrier can accommodate many customer carriers and give them access to its backbone. The backbone carrier does not need to create and maintain separate backbones for its customer carriers. Using one backbone network to support multiple customer carriers simplifies the backbone carrier's VPN operations. The backbone carrier uses a consistent method for managing and maintaining the backbone network. This is also cheaper and more efficient than maintaining separate backbones.
- The MPLS LDP CSC feature is scalable. CSC can change the VPN to meet changing bandwidth and connectivity needs. The feature can accommodate unplanned growth and changes. The CSC feature enables tens of thousands of VPNs to be configured over the same network, and it allows a service provider to offer both VPN and internet services.
- The MPLS LDP CSC feature is a flexible solution. The backbone carrier can accommodate many types of customer carriers. The backbone carrier can accept customer carriers who are ISPs or VPN service providers or both. The backbone carrier can accommodate customer carriers that require security and various bandwidths.

Benefits to the Customer Carriers

- The MPLS LDP CSC feature removes from the customer carrier the burden of configuring, operating, and maintaining its own backbone. The customer carrier uses the backbone network of a backbone carrier, but the backbone carrier is responsible for network maintenance and operation.
- Customer carriers who use the VPN services provided by the backbone carrier receive the same level of security that Frame Relay or ATM-based VPNs provide. Customer carriers can also use IPSec in their VPNs for a higher level of security; it is completely transparent to the backbone carrier.
- Customer carriers can use any link layer technology (SONET, Digital Subscriber Line, Frame Relay, and so on) to connect the CE routers to the PE routers and the PE routers to the P routers. The MPLS LDP CSC feature is link layer independent. The CE routers and PE routers use IP or MPLS to communicate, and the backbone carrier uses MPLS.
- The customer carrier can use any addressing scheme and still be supported by a backbone carrier. The customer address space and routing information are independent of the address space and routing information of other customer carriers or the backbone provider.

Multiple VRF Support

To support multiple VRFs, IOS XR LDP configuration model is extended to allow VRF submode and per-VRF configuration and feature or interface enabling.

IOS XR LDP process is not distributed nor it is multi-instance, hence the single LDP process services all the configured VRFs. In large scale VRF deployment, it is recommended to enable VRF under LDP with appropriate policies and label filtering.

RSI

To obtain VRF and routing tables' related information, LDP interacts with the router space infrastructure (RSI) server. For every LDP enabled non-default VRF, LDP registers with RSI to get notifications upon VRF default (IPv4/IPv6) tables getting created or deleted, and populate the LDP VRF database accordingly.

VRF Table ID Database

A new database is added in the LDP process to keep track of all VRFs enabled under LDP. This database holds both active as well as forward-reference VRF records. In addition to serving as an LDP context, each active record of this database also holds VRF's default (IPv4/IPv6 unicast) table IDs.

VRF-Interface Mapping

To enable LDP on an interface for a given address family under a VRF context, it is required to list interface and its address family explicitly under a LDP VRF submode. LDP does not enforce or check correctness of the interface and VRF mapping at the time of configuration, and hence configuration may be accepted by LDP. The interface with incorrect VRF mapping is not made operational by LDP and remains down from the LDP point of view.

This means that an interface remains LDP operationally down for which either:

- LDP has not received any address update, or
- LDP has received update with different table-id (VRF) than configured under LDP.

Also, a user must not configure the same LDP interface under more than one VRF.

Context Isolation

Each active VRF under LDP points to a separate context under which LDP runs. This means that various variables, database, tables, FSM are kept separate in their respective VRF contexts and do not interfere or interact with each other. This allows the LDP to provide per-VRF isolation and support CSC with customers with overlapping addresses or routing information.

Default Context

The default (global) context is enabled at the time of the LDP process startup and remains enabled always. It is not possible to disable IPv4 for the default context. Also, it is required to explicitly enable IPv4 for non-default context. Therefore you can effectively disable IPv4 for non-default context by not configuring it. This means that, it is possible to enable or disable the non-default context under LDP, whereas the same is not possible for a default context.

Restrictions and Recommendations

The following restrictions and recommendations apply to the MPLS LDP CSC feature:

- Only IPv4 address family is supported for a default or a non-default VRF.
- No T-LDP support in a VRF context.
- An address family under VRF and VRF interface must be configured for non-default VRFs.
- Following scenarios are not supported :
 - Different VRFs between a given PE-CE device pair (VRFs configured on different links and interfaces)
 - LDP/BGP CSC co-existence on a given VRF between a given PE-CE device pair:
 - Single link
 - Parallel links: LDP CSC on one link and BGP CSC on the other
- LDP router-id must be configured per-VRF. If not configured for non-default VRF, LDP computes router-id from available loopback interfaces under the VRF.
- It is recommended to configure a routable discovery transport address under a VRF IPv4 address-family submode for deterministic transport endpoint and connection.
- When LDP CSC is configured and in use:
 - BGP label allocation policy for VRF prefixes must be per-prefix
 - Selective VRF Download (SVD) feature must be disabled

IPv6 Support in MPLS LDP

Internet Protocol version 6 (IPv6) support in MPLS LDP (Label Distribution Protocol) feature makes the LDP control plane to run on IPv6 in order to setup LSPs for IPv6 prefixes. This support enables most of the LDP functions supported on IPv4 to be extended to IPv6. In this context, support for native MPLS LDP over IPv6 is provided in order to seamlessly continue providing existing services while enabling new ones.

LDP associates a forwarding equivalence class (FEC) with each label switched path (LSP) it creates. The FEC associated with an LSP specifies which packets are mapped to that LSP. LDP establishes sessions with peers and exchanges FEC label bindings with them to enable creation of LSPs to carry MPLS traffic destined to IP prefixes.

LDP base specification, RFC 5036 defines procedures and messages for exchanging bindings for IPv4 and IPv6 addresses and routing prefixes. LDP IPv6 specification (draft-ietf-mpls-ldp-ipv6) updates LDP base specifications for IPv6 support, and further clarifies and focuses on the procedures for supporting LDP IPv6 control plane and binding advertisement.

The procedures of address bindings, label bindings, and forwarding setup are same for IPv4 and IPv6 address families in LDP. The only difference is that, a different address format is used according to the IP address family. While a single-stack IP address family (IPv4-only or IPv6-only) enabled interfaces between a set of routers is the most typical deployment, scenarios for LSR interconnections using both IPv4 and IPv6 interfaces are also supported.

IPv6 support in MPLS LDP implements draft-ietf-mpls-ldp-ipv6 version12 issued by the Internet Engineering Task Force (IETF).



Note The Cisco CRS-X, CRS-1 and CRS-3 cards support the LDP IPv6 feature.

LDP IPv6 Functionality

LDP functionality can be broadly divided into two categories:

- Control Plane

Control plane includes functions such as: neighbor discovery (hello adjacencies), transport connection/endpoint (TCP connection), session and peering, and bindings exchange.

- LSP Setup

LSP setup includes functions such as: acquire FEC information through RIB, assign and advertise local label bindings for FEC, advertise local (interface) IP address bindings and setup forwarding rewrites.

For the control plane, the underlying address family can be either IPv4-only, IPv6-only or both. Whereas for the LSP setup, an LSP is setup for IPv4 or IPv6 FEC prefix.

Figure 7: LDP IPv6 Architecture

This figure illustrates the main components that collaborate to achieve the required functionality for the LDP IPv6 feature.

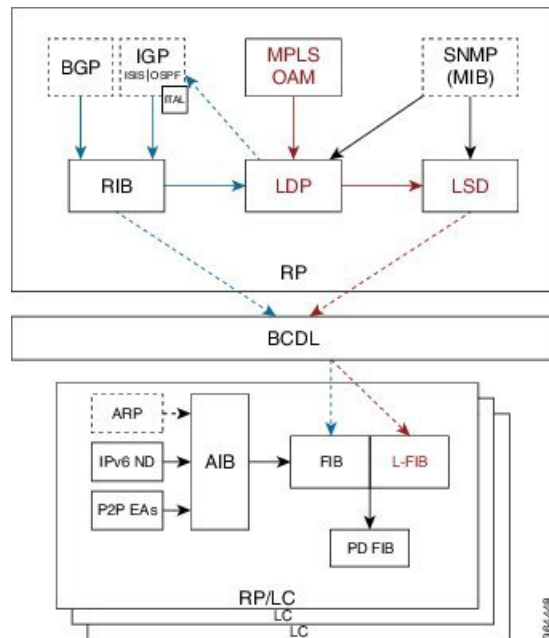

The functions of LDP in the MPLS LDP IPv6 setup are as follows:

- Receive routing updates from routing information base (RIB) for global IPv6 prefixes
- Assign local labels for IPv6 prefixes
- Receive IPv6 address or state notifications for local IPv6 enabled interfaces from IP Address Repository Manager (IP-ARM/IM) and LAS for IPv6 link-local unicast addresses
- Advertise/Accept IPv6 label bindings and address bindings to/from peers
- Setup MPLS forwarding to create IPv6 LSPs
- Provide IPv6 LSP information to MPLS OAM as and when requested
- Service MIB requests for IPv6 control plane queries and generate MIB traps
- Provide LDPv6 convergence status for a link to IGP for LDP-IGP Sync feature for IPv6
- Support IPv6 address family for all existing LDP features that intersect with prefixes and/or addresses

Figure 8: LDP IPv6 Control Plane and LSP Setup

This figure illustrates the high level functionality of LDP in terms of control plane and LSP setup in an IPv6 environment.

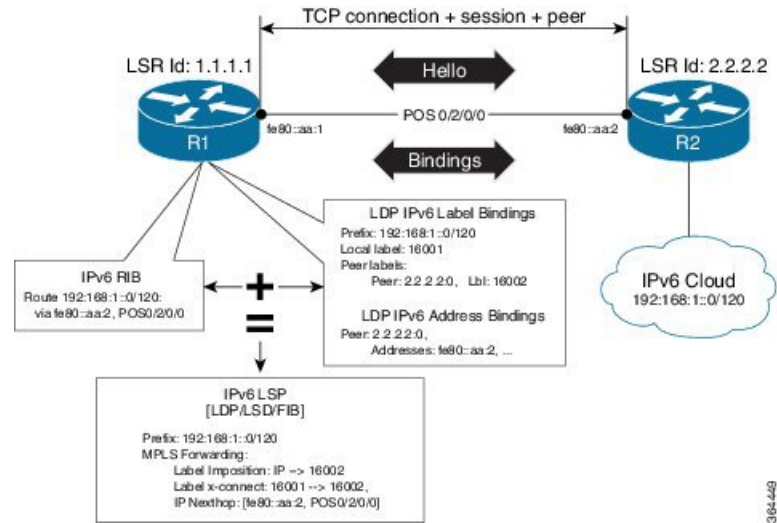

Topological Scenarios

A typical deployment scenario consists of single-stack IP address-family (IPv4-only or IPv6-only) enabled interfaces between a set of routers.

Three topology scenarios in which the LSRs are connected through one or more dual-stack LDP enabled interfaces, or one or more single-stack LDP enabled interfaces are defined as follows:



Note R2 is the main router.

1. One dual-stack interface/same neighbor:

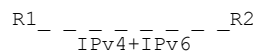

2. Two single-stack interfaces/same neighbor:

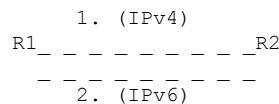

3. Two single-stack interfaces/different neighbors with different address families:



Case Study

A description of the control plane and LSP setup scenarios for the previously shown three configurations are as follows:

Case 1:

Neighbor Discovery: Both IPv4 and IPv6 Hellos sent on the interface to R1.

Transport Connection: IPv4 endpoints or IPv6 endpoints (as per user preference).

Label binding exchange: Both IPv4 and IPv6 prefixes.

Address binding exchange: Both IPv4 and IPv6 addresses.

LSPs: Both IPv4 and IPv6 over the same nexthop interface to R1.

Case 2:

Neighbor Discovery: IPv4 Hellos on interface-1 to R1 and IPv6 Hellos on interface-2 to R1.

Transport Connection: IPv4 endpoints or IPv6 endpoints (as per user preference).

Label binding exchange: Both IPv4 and IPv6 prefixes.

Address binding exchange: Both IPv4 and IPv6 addresses.

LSPs: IPv4 over nexthop interface-1 to R1 and IPv6 over nexthop interface-2 to R1.

Case 3:

Neighbor Discovery: IPv4 Hellos on interface-1 to R1 and IPv6 Hellos on interface-2 to R3.

Transport Connection: IPv4 endpoints with R1 and IPv6 endpoints with R3.

Label binding exchange: Both IPv4 and IPv6 prefixes to R1 and R3.



Note Even if all the three LSRs are dual-stack, traffic from R1 to R3 will not be completely labeled.

- If there is IPv6 traffic, it is unlabeled from R1 to R2. Labels are imposed only at R2 (although in this specific case implicit null imposition) to R3.
- If there is IPv4 traffic, it is labeled from R1 to R2. But the traffic will go unlabeled between R2 and R3 given that no IPv4 adjacency exists between R2 and R3.

Address binding exchange: Both IPv4 and IPv6 addresses to R1 and R3.

LSPs: IPv4 over nexthop interface-1 to R1 and IPv6 over nexthop interface-2 to R3.

Restrictions

IPv6 support in MPLS LDP has the following restrictions and constraints:

- IPv6 address family is supported only under default VRF
- Implicit enabling of IPv6 address family is not allowed. It needs explicit enabling.
- It is recommended to configure a routable IPv6 **discovery transport address** when only LDP IPv6 is configured without explicitly specifying a router-id

Features Supported in LDP IPv6

The following features are supported in LDP IPv6:

- Single-stack (native IPv6) and dual-stack (IPv4+IPv6) topologies
- New operating modes in LDP:
 - Native LDP IPv6
 - LDP IPv6 over IPv4 and LDP IPv4 over IPv6 connection endpoints

LDP Hellos carry optional transport address type length value (TLV) to notify a peer about TCP or transport connection endpoint. An LSR can include either IPv4 or IPv6 transport address TLV in an IPv4 or IPv6 Hello message. There is no difference in the TLV format of transport address for IPv4 and IPv6.

Only one transport connection is established between two discovered peers, whether there be single address family Hello adjacencies or multi-address family (both IPv4 and IPv6) Hello adjacencies.

In a dual-stack setup, when LDP has the option to establish transport connection either using IPv4 endpoints or IPv6 endpoints, IPv6 connection is preferred over IPv4 connection. If LDP is locally enabled for both IPv4 and IPv6 address families, every new session is treated as potential dual-stack connection. Under such circumstances, IPv6 preference is kept in place for maximum fifteen seconds for the session to establish, after which the LDP tries to establish a connection with the peer using IPv4. A user can override this default behavior by specifying the preference for a set of dual-stack peers to use IPv4 transport for the connection. Furthermore, a user may also specify maximum wait time to wait to establish the preferred transport connection. If the preferred transport establishment times out, LDP tries to establish connection with other non-preferred transport address families. This applies to both the cases when an LSR acts as active side or passive side for the TCP connection.

To override default IPv6 transport preference for dual-stack cases, use the **mpls ldp neighbor dual-stack transport-connection prefer ipv4 for-peers** command. To specify the maximum time the preferred address family connection must wait to establish a connection before resorting to a non-preferred address family, use the **mpls ldp neighbor dual-stack transport-connection max-wait** command.

Once a transport connection is established, it is not torn down depending on preferences. If the address family related to established transport connection is disabled under LDP, the corresponding transport connection is reset to reestablish the connection.

For a single-stack setup, there is no contention; the transport connection uses the given address family.

- LDP Control Plane is IPv6 aware
- LDP IPv6 LSP forwarding setup

LDP interacts with LSD in order to setup IPv6 LSP forwarding. The steps involved in this interaction are:

- Label allocation for an IPv6 prefix is learnt from RIB.
- Setup imposition and label switching forwarding path for given IPv6 prefix by creating IPv6 forwarding rewrites.
- Like LDP IPv4, rewrite delete and label free operations are performed when a route disappears or is disallowed under LDP due to label policy.

- There is no new requirement related to MPLS enabling or disabling. LDP also MPLS-enables in LSD (if not already) any LDP enabled interface, which is in the *UP* state for IP4 and/or IPv6 and has IPv4 and/or IPv6 addresses assigned.
- In case of dual-stack LDP, a single Resource-Complete is sent by LDP to LSD once RIB-Converged notification is received for both IPv4 and IPv6 redistribute tables.
- Distribution of IPv4 and IPv6 bindings over a single LDP session established over IPv4 or IPv6
- LDP Downstream on Demand
- LDP session protection

LDP session protection is a feature to protect an IPv6 LDP session. In case of dual-stack hello adjacencies with a peer, there is only a single targeted hello adjacency to protect the session. Session protection forms targeted adjacency of address family same as the transport connection. For IPv6, the target of the session protection is the remote transport connection endpoint. For IPv4, the target of the session protection is remote LSR ID.

- LDP IGPv6 sync on IPv6 interface

This feature lets IGP support LDP IGP Sync feature for IPv6 address family. This means that Intermediate System-to-Intermediate System (IS-IS) allows IGP under an interface's IPv6 address family, whereas OSPFv3 implements it just like existing support in OSPF for IPv4. When the IGP Sync feature is enabled, LDP convergence status on an interface is considered by the IGP under the context of a given address family. This behavior applies to IGP Sync for both non-TE as well as TE tunnel interfaces.

- LDP Typed Wildcard for IPv6 prefix FEC

This feature adds support for Typed Wildcard for IPv6 Prefix FEC. The support includes:

- Being able to send or receive IPv6 Prefix Typed Wildcard FEC element in label messages.
- Respond to Typed Wildcard Label Requests received from peer by replaying its label database for IPv6 prefixes.
- Make use of Typed Wildcard Label Requests towards peers to request replay of peer label database for IPv6 prefixes. For example, on local inbound policy changes.

- Label allocation, advertisement and accept policies for IPv6 prefixes
- Local label assignment and advertisement for IPv6 default-route (::/0)
- Session MD5 authentication for IPv6 transport
- IPv6 Explicit-Null label

IPv6 explicit null label feature support includes:

- Advertisement and receipt of IPv6 explicit-null label to and from peers.
- IPv6 explicit-null outgoing label in forwarding setup.
- Explicit-null advertisement policy for a set of IPv6 prefixes and/or set of peers.
- Explicit-null configuration change. Change in explicit-null configuration is handled by first transferring a wildcard withdraw with null label to peer(s), followed by advertising the appropriate null (implicit or explicit) label to the peer(s) again. This works without any issue as long as a single IP address family is enabled. In case of a dual-stack LSR peer, a change of configuration related to

explicit-null advertisement for a given address family may cause unnecessary mix-up in the other address family.

- LDP IPv6 LFA FRR

Local LFA FRR for IPv6 is supported. However, it is required that the primary and backup paths are of the same address family type, that is, an IPv4 primary path must not have an IPv6 backup path.

- NSF for LDP IPv6 traffic

Non-stop forwarding (NSF) support is either provided through LDP NSR or graceful restart mechanisms.

- IGP/LDP NSR for IPv6

- IGP/LDP Graceful Restart for IPv6

- LDP ICCP IPv6 neighbor node

LDP Inter-Chassis Communication Protocol (ICCP) is supported with IPv6 neighbor node. ICCP is used as a mechanism for multi-chassis LACP.

- SSO/ISSU for LDP IPv6

- MPLS OAM: New FECs

LSPV supports two new FECs.

- LDP IPv6 Prefix FEC Encoding/Decoding

Label Switched Path Verification (LSPV) encodes/decodes the LDP IPv6 Prefix FEC. Prefix is in the network byte order and the trailing bits are to be set to zero when prefix length is shorter than 128 bits.

- Generic IPv6 Prefix FEC Encoding/Decoding

LSPV encodes/decodes the generic IPv6 Prefix FEC. Prefix is in the network byte order and the trailing bits are to be set to zero when prefix length is shorter than 128 bits.

Generic IPv6 FEC is used in addition to the LDP IPv6 FEC. This serves the following primary purposes:

- Allows user to perform LSP ping and traceroute to verify data plane without involving control plane of the FEC in echo request and response.
- If support for a new FEC is preferred in the future, the generic FEC can be used until corresponding control plane is explicitly supported by LSPV.

- IPv6 LSR MIB

MPLS OAM LDP MIBS is extended to support IPv6. All LSR MIB objects that reference an InSegment prefix and OutSegment next hop address are modified to support IPv6.

- LSP ping support for LDP IPv6

- LSP trace-route support for LDP IPv6

- LSP tree-trace support for LDP IPv6

The following features are not supported in LDP IPv6:

- LDPv6 over TEv4 (traffic engineering)
- L2VPN/PW (over IPv6 LSPs)
- L3VPN (over IPv6 LSPs)
- LDP auto-config for IPv6 IGP/Interfaces
- LDP ICCP with IPv6 neighbor node
- Multicast extension to LDP (mLDP) for IPv6 FEC with label binding through IPv4 and IPv6 transport
- Native IPv4 and IPv6 L3VPN over LDP IPv6 core
- L2VPN signaling with LDP when the nexthop address is IPv6
- IPv6 LDP CSC

Implicit IPv4 Disable

The LDP configuration model was changed with the introduction of explicit address family enabling under LDP (VRF) global and LDP (VRF) interfaces. However, in order to support backward compatibility, the old configuration model was still supported for default VRF. There was, however, no option to disable the implicitly enabled IPv4 address family under default VRF's global or interface level.

A new configuration **`mpls ldp default-vrf implicit-ipv4 disable`** is now available to the user to disable the implicitly enabled IPv4 address family for the default VRF. The new configuration provides a step towards migration to new configuration model for the default VRF that mandates enabling address family explicitly. This means that if the new option is configured, the user has to explicitly enable IPv4 address family for default VRF global and interface levels. It is recommended to migrate to this explicitly enabled IPv4 configuration model.

For detailed configuration steps, see [Disabling Implicit IPv4, on page 85](#)

IPv6 Label Bindings

LDP stores label bindings associated with FEC prefix in its Label Information Base (LIB) [TIB in Cisco LDP]. An entry in LIB corresponds to a prefix and holds the following bindings:

- Local binding: Local label assigned for this prefix (which is learnt through local RIB).
- Remote bindings: Array of peer labels (prefix-label bindings received in label mapping message from peer(s)).

An entry in LIB can exist due to local binding presence, or due to remote binding(s) presence, or due to both local and remote bindings presence. The forwarding setup, however, mandates that local binding be present for a prefix.

Extensions have been implemented to support IPv6 prefixes for LIB in LDP. For per-address family convergence or preference reasons, separate or new LIB is implemented to keep and maintain IPv6 prefixes. In case of dual-stack LDP, LIBv4 is preferred over LIBv6 wherever possible. For example, during background *housekeeping* function, LIBv4 is processed before LIBv6.

IPv6 Address Bindings

LDP needs to maintain IPv6 address database for local and peer interface addresses. The IPv4 address module for local/peer addresses is extended to keep IPv4/IPv6 addresses in their respective databases, much like LIB

database. In case of a dual-stack LDP, IPv4 local address database function is preferred over IPv6 local address database function where ever possible.

Default Transport Address

LDP computes default local transport address for IPv6 from its IPv6 interface or address database by picking the lowest operational loopback interface with global unicast IPv6 address. This means that any change in this loopback state or address, flaps or changes the default transport address for IPv6 and may cause session flaps using such an address as transport endpoint. For example, if a session is currently active on Loopback2 as during its inception it was the lowest loopback with an IPv6 address, and a lower loopback, Loopback0, is configured with an IPv6 address, the session does not flap. However, if it does flap, the next time the session is attempted, Loopback0 is used.

The session flaps when configuring discovery transport address explicitly.

Use the **discovery transport-address** command under the LDP address family submode to specify the global transport address for IPv4 or IPv6.

It is recommended to configure global transport-address for IPv6 address family to avoid a potentially unstable default transport address.

LDP Control Plane: Bindings Advertisement

LDP base specification allows exchange of IPv4/IPv6 bindings (address/label) on an established session. When both IPv4 and IPv6 address families are enabled under LDP, LDP distributes address/label bindings for both address families to its established peer according to local policies. Following are a few significant points pertaining to bindings support for IPv6:

- LDP allocates/advertises local label bindings for link-local IPv6 address prefixes. If received, such FEC bindings are ignored.
- LDP sends only the Prefix FEC of the single address family type in a FEC TLV and not include both. If such a FEC binding is received, the entire message is ignored.
- LDP sends only the addresses belonging to same address family in a single address list TLV (in address or address withdraw message).

If an address family is not enabled on receiving LSR, LDP discards any bindings received from peer(s) for the address family. This means that when address family is enabled, LDP needs to reset existing sessions with the peers in order to re-learn the discarded bindings. The implementation is optimized to reset only those sessions which were previously known to be dual-stack and had sent bindings for both address families.

LSP Mapping

LDP uses IPv6 adjacency information instead of IP address to map an IPv6 link-local nexthop to an LDP peer.

In addition to other usual checks before using a label from nexthop LDP peer, LDP uses the nexthop label for a prefix of a given address family, if there are one or more LDP hello adjacencies of the same address family type established with the peer.

Label Policies

LDP allows a user to configure label policies for allocation, acceptance, receipt, and advertisement of labels for the given prefixes.

Following are the significant points pertaining to the IPv6 support for label policies:

- Label policies and their configurations are allowed under address family IPv6.
- Any policy that specifies prefix or a set of prefixes through an ACL, supports both IPv4 and IPv6 variants for address(s) or ACLs.
- Any policy that specifies peer address or set of peer addresses through an ACL, supports both IPv4 and IPv6 variant for peer address(s) or ACL.
- Any policy that specifies the peer's LSR ID in a peer ACL continues to take IPv4 ACL based policy irrespective of the feature configuration.

IS-IS

Intermediate System-to-Intermediate System (IS-IS) is an Interior Gateway Protocol (IGP) that advertises link-state information throughout the network to create a picture of the network topology. IPv6 IS-IS extends the address families supported by IS-IS to include IPv6, in addition to IPv4.

Previously, IS-IS supported registration of only LDP IPv4 sync status change. This has now been enhanced to support registration of notifications of LDP IPv6 sync status change. IS-IS determines the link-metrics to be advertised based on the LDP-IGP sync status on the IPv4 and IPv6 address families.

IS-IS supports non-stop forwarding (NSF) by preserving the LDPv6-IGP sync status across high availability (HA) events of IS-IS process restarts and failover.

IS-IS also supports LDPv6-IGP sync for LFA-FRR by checking the sync status of the backup interface (if it is configured with LDP IPv6 sync).

Dual-Stack Capability TLV

Clear rules are specified in RFC 5036 to determine transport connection roles in setting up a TCP connection for single-stack LDP. But RFC 5036 is not clear about dual-stack LDP, in which an LSR may assume different roles for different address families, causing issues in establishing LDP sessions.

To ensure a deterministic transport connection role for the dual-stack LDP, the dual-stack LSR conveys its transport connection preference in every LDP Hello message. This preference is encoded in a new TLV (Type Length Value) called the Dual-Stack Capability TLV. Dual-stack LSR always checks for the presence of the dual-stack capability TLV in the received LDP Hello messages and takes appropriate action for establishing or maintaining sessions.

RFC 7552 specifies more details about updates to LDP for IPv6.

Dual-Stack Capability TLV Format

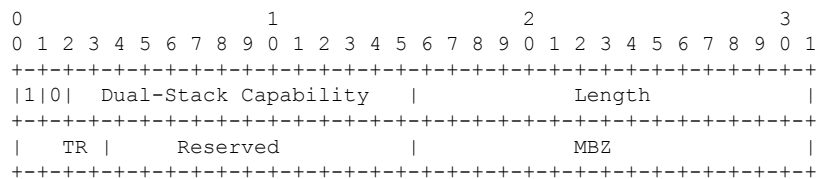

Dual-Stack Capability TLV Fields

Field	Description
U and F bits	1 and 0 (as specified by RFC 5036)
Dual-Stack Capability	TLV code point (0x0701)
TR: Transport Connection Preference	TR: Transport Connection Preference: <ul style="list-style-type: none"> • 0100: LDPoIPv4 connection • 0110: LDPoIPv6 connection (default)
Reserved	This field is reserved. It must be set to zero on transmission and ignored on receipt
MBZ	Must be zero

Compliance Check

The compliance check prevents sessions being formed with prior RFC 7552 implementation of LDP IPv6.

If the dual-stack capability TLV is not present in the received Hellos and the compliance check is configured, the local and remote preferences must match to establish a session. If the preferences do not match, the LDP Hellos are dropped and the session is not established. Compliance check has therefore been disabled by default.

Use the command **neighbor dual-stack tlv-compliance** in MPLS LDP configuration to enable the compliance check.

How to Implement MPLS LDP

A typical MPLS LDP deployment requires coordination among several global neighbor routers. Various configuration tasks are required to implement MPLS LDP :

Configuring LDP Discovery Parameters

Perform this task to configure LDP discovery parameters (which may be crucial for LDP operations).



Note

The LDP discovery mechanism is used to discover or locate neighbor nodes.

SUMMARY STEPS

1. **configure**
2. **mpls ldp**
3. **[vrf vrf-name] router-id ip-address lsr-id**
4. **discovery { hello | targeted-hello } holdtime seconds**
5. **discovery { hello | targeted-hello } interval seconds**
6. **commit**
7. (Optional) **show mpls ldp [vrf vrf-name] parameters**

DETAILED STEPS

	Command or Action	Purpose
Step 1	configure	
Step 2	mpls ldp Example: RP/0/RP0/CPU0:router(config)# mpls ldp	Enters MPLS LDP configuration mode.
Step 3	[vrf vrf-name] router-id ip-address lsr-id Example: RP/0/RP0/CPU0:router(config-ldp)# router-id 192.168.70.1	(Optional) Specifies a non-default VRF. Specifies the router ID of the local node. • In Cisco IOS XR software, the router ID is specified as an interface IP address. By default, LDP uses the global router ID (configured by the global router ID process).
Step 4	discovery { hello targeted-hello } holdtime seconds Example: RP/0/RP0/CPU0:router(config-ldp)# discovery hello holdtime 30 RP/0/RP0/CPU0:router(config-ldp)# discovery targeted-hello holdtime 180	Specifies the time that a discovered neighbor is kept without receipt of any subsequent hello messages. The default value for the <i>seconds</i> argument is 15 seconds for link hello and 90 seconds for targeted hello messages.
Step 5	discovery { hello targeted-hello } interval seconds Example: RP/0/RP0/CPU0:router(config-ldp)# discovery hello interval 15 RP/0/RP0/CPU0:router(config-ldp)# discovery targeted-hello interval 20	Selects the period of time between the transmission of consecutive hello messages. The default value for the <i>seconds</i> argument is 5 seconds for link hello messages and 10 seconds for targeted hello messages.
Step 6	commit	
Step 7	(Optional) show mpls ldp [vrf vrf-name] parameters Example: RP/0/RP0/CPU0:router # show mpls ldp parameters RP/0/RP0/CPU0:router # show mpls ldp vrf red parameters	Displays all the current MPLS LDP parameters. Displays the LDP parameters for the specified VRF.

Related Topics

[LDP Control Plane](#), on page 3

Configure Label Distribution Protocol Targeted Neighbor

LDP session between LSRs that are not directly connected is known as targeted LDP session. For LDP neighbors which are not directly connected, you must manually configure the LDP neighborhood on both the routers.

Configuration Example

This example shows how to configure LDP for non-directly connected routers.

```
RP/0/RSP0/CPU0:router# configure
RP/0/RSP0/CPU0:router(config)# mpls ldp
RP/0/RSP0/CPU0:router(config-ldp)# router-id 192.0.2.1
RP/0/RSP0/CPU0:router(config-ldp)# neighbor 198.51.100.1:0 password encrypted 13061E010803
RP/0/RSP0/CPU0:router(config-ldp)# address-family ipv4
RP/0/RSP0/CPU0:router(config-ldp-af)# discovery targeted-hello accept
RP/0/RSP0/CPU0:router(config-ldp-af)# neighbor 198.51.100.1 targeted
RP/0/RSP0/CPU0:router(config-ldp-af)# commit
```

Running Configuration

This section shows the LDP targeted neighbor running configuration.

```
mpls ldp
router-id 192.0.2.1
neighbor 198.51.100.1:0 password encrypted 13061E010803
address-family ipv4
  discovery targeted-hello accept
  neighbor 198.51.100.1 targeted
!
```

Verification

Verify LDP targeted neighbor configuration.

```
RP/0/RSP0/CPU0:router#show mpls ldp discovery
Wed Nov 28 04:30:31.862 UTC

Local LDP Identifier: 192.0.2.1:0
Discovery Sources:
  Targeted Hellos: <<< targeted hellos based session
    192.0.2.1 -> 198.51.100.1(active/passive), xmit/rcv <<< both transmit and receive
of targeted hellos between the neighbors
  LDP Id: 198.51.100.1:0
    Hold time: 90 sec (local:90 sec, peer:90 sec)
    Established: Nov 28 04:19:55.340 (00:10:36 ago)

RP/0/RSP0/CPU0:router#show mpls ldp neighbor
Wed Nov 28 04:30:38.272 UTC

Peer LDP Identifier: 198.51.100.1:0
TCP connection: 198.51.100.1:0:13183 - 192.0.2.1:646; MD5 on
Graceful Restart: No
Session Holdtime: 180 sec
State: Oper; Msgs sent/rcvd: 20/20; Downstream-Unsolicited
Up time: 00:10:30
LDP Discovery Sources:
  IPv4: (1)
```



```

    Targeted Hello (192.0.2.1 -> 198.51.100.1, active/passive) <<< targeted LDP based
session
IPv6: (0)
Addresses bound to this peer:
IPv4: (4)
  198.51.100.1      10.0.0.1      172.16.0.1      192.168.0.1
IPv6: (0)

```

Configuring LDP Discovery Over a Link

Perform this task to configure LDP discovery over a link.



Note There is no need to enable LDP globally.

Before you begin

A stable router ID is required at either end of the link to ensure the link discovery (and session setup) is successful. If you do not assign a router ID to the routers, the system will default to the global router ID. Default router IDs are subject to change and may cause an unstable discovery.

SUMMARY STEPS

1. **configure**
2. **mpls ldp**
3. **[vrf vrf-name] router-id ip-address lsr-id**
4. **interface type interface-path-id**
5. **commit**
6. (Optional) **show mpls ldp discovery**
7. (Optional) **show mpls ldp vrf vrf-name discovery**
8. (Optional) **show mpls ldp vrf all discovery summary**
9. (Optional) **show mpls ldp vrf all discovery brief**
10. (Optional) **show mpls ldp vrf all ipv4 discovery summary**
11. (Optional) **show mpls ldp discovery summary all**

DETAILED STEPS

	Command or Action	Purpose
Step 1	configure	
Step 2	mpls ldp Example: RP/0/RP0/CPU0:router(config)# mpls ldp	Enters MPLS LDP configuration mode.
Step 3	[vrf vrf-name] router-id ip-address lsr-id Example:	(Optional) Specifies a non-default VRF. Specifies the router ID of the local node.

	Command or Action	Purpose
	<pre>RP/0/RP0/CPU0:router(config-ldp)# router-id 192.168.70.1</pre>	<ul style="list-style-type: none"> In Cisco IOS XR software, the router ID is specified as an interface name or IP address. By default, LDP uses the global router ID (configured by the global router ID process).
Step 4	<p>interface <i>type interface-path-id</i></p> <p>Example:</p> <pre>RP/0/RP0/CPU0:router(config-ldp)# interface tunnel-te 12001 RP/0/RP0/CPU0:router(config-ldp-if)#</pre>	Enters interface configuration mode for the LDP protocol. Interface type must be Tunnel-TE.
Step 5	commit	
Step 6	<p>(Optional) show mpls ldp discovery</p> <p>Example:</p> <pre>RP/0/RP0/CPU0:router# show mpls ldp discovery</pre>	Displays the status of the LDP discovery process. This command, without an interface filter, generates a list of interfaces over which the LDP discovery process is running. The output information contains the state of the link (xmt/rcv hellos), local LDP identifier, the discovered peer's LDP identifier, and holdtime values.
Step 7	<p>(Optional) show mpls ldp vrf vrf-name discovery</p> <p>Example:</p> <pre>RP/0/RP0/CPU0:router# show mpls ldp vrf red discovery</pre>	Displays the status of the LDP discovery process for the specified VRF.
Step 8	<p>(Optional) show mpls ldp vrf all discovery summary</p> <p>Example:</p> <pre>RP/0/RP0/CPU0:router# show mpls ldp vrf all discovery summary</pre>	Displays the summarized status of the LDP discovery process for all VRFs.
Step 9	<p>(Optional) show mpls ldp vrf all discovery brief</p> <p>Example:</p> <pre>RP/0/RP0/CPU0:router# show mpls ldp vrf all discovery brief</pre>	Displays the brief status of the LDP discovery process for all VRFs.
Step 10	<p>(Optional) show mpls ldp vrf all ipv4 discovery summary</p> <p>Example:</p> <pre>RP/0/RP0/CPU0:router# show mpls ldp vrf all ipv4 discovery summary</pre>	Displays the summarized status of the LDP discovery process for all VRFs for the IPv4 address family.
Step 11	<p>(Optional) show mpls ldp discovery summary all</p> <p>Example:</p>	Displays the aggregate summary across all the LDP discovery processes.

	Command or Action	Purpose
	RP/0/RP0/CPU0:router# <code>show mpls ldp discovery summary all</code>	

Related Topics

[LDP Control Plane](#), on page 3

[Configuring LDP Link: Example](#), on page 89

Configuring LDP Discovery for Active Targeted Hellos

Perform this task to configure LDP discovery for active targeted hellos.



Note The active side for targeted hellos initiates the unicast hello toward a specific destination.

Before you begin

These prerequisites are required to configure LDP discovery for active targeted hellos:

- Stable router ID is required at either end of the targeted session. If you do not assign a router ID to the routers, the system will default to the global router ID. Please note that default router IDs are subject to change and may cause an unstable discovery.
- One or more MPLS Traffic Engineering tunnels are established between non-directly connected LSRs.

SUMMARY STEPS

1. **configure**
2. **mpls ldp**
3. **[vrf vrf-name] router-id ip-address lsr-id**
4. **interface type interface-path-id**
5. **commit**
6. (Optional) **show mpls ldp discovery**
7. (Optional) **show mpls ldp vrf vrf-name discovery**
8. (Optional) **show mpls ldp vrf all discovery summary**
9. (Optional) **show mpls ldp vrf all discovery brief**
10. (Optional) **show mpls ldp vrf all ipv4 discovery summary**
11. (Optional) **show mpls ldp discovery summary all**

DETAILED STEPS

	Command or Action	Purpose
Step 1	configure	
Step 2	mpls ldp Example:	Enters MPLS LDP configuration mode.

	Command or Action	Purpose
	<code>RP/0/RP0/CPU0:router(config)# mpls ldp</code>	
Step 3	<p>[vrf vrf-name] router-id ip-address lsr-id</p> <p>Example:</p> <pre>RP/0/RP0/CPU0:router(config-ldp)# router-id 192.168.70.1</pre>	<p>(Optional) Specifies a non-default VRF.</p> <p>Specifies the router ID of the local node.</p> <p>In Cisco IOS XR software, the router ID is specified as an interface name or IP address or LSR ID. By default, LDP uses the global router ID (configured by global router ID process).</p>
Step 4	<p>interface type interface-path-id</p> <p>Example:</p> <pre>RP/0/RP0/CPU0:router(config-ldp)# interface tunnel-te 12001</pre>	Enters interface configuration mode for the LDP protocol.
Step 5	commit	
Step 6	<p>(Optional) show mpls ldp discovery</p> <p>Example:</p> <pre>RP/0/RP0/CPU0:router# show mpls ldp discovery</pre>	Displays the status of the LDP discovery process. This command, without an interface filter, generates a list of interfaces over which the LDP discovery process is running. The output information contains the state of the link (xmt/rcv hellos), local LDP identifier, the discovered peer's LDP identifier, and holdtime values.
Step 7	<p>(Optional) show mpls ldp vrf vrf-name discovery</p> <p>Example:</p> <pre>RP/0/RP0/CPU0:router# show mpls ldp vrf red discovery</pre>	Displays the status of the LDP discovery process for the specified VRF.
Step 8	<p>(Optional) show mpls ldp vrf all discovery summary</p> <p>Example:</p> <pre>RP/0/RP0/CPU0:router# show mpls ldp vrf all discovery summary</pre>	Displays the summarized status of the LDP discovery process for all VRFs.
Step 9	<p>(Optional) show mpls ldp vrf all discovery brief</p> <p>Example:</p> <pre>RP/0/RP0/CPU0:router# show mpls ldp vrf all discovery brief</pre>	Displays the brief status of the LDP discovery process for all VRFs.
Step 10	<p>(Optional) show mpls ldp vrf all ipv4 discovery summary</p> <p>Example:</p> <pre>RP/0/RP0/CPU0:router# show mpls ldp vrf all ipv4 discovery summary</pre>	Displays the summarized status of the LDP discovery process for all VRFs for the IPv4 address family.

	Command or Action	Purpose
Step 11	(Optional) show mpls ldp discovery summary all Example: <pre>RP/0/RP0/CPU0:router# show mpls ldp discovery summary all</pre>	Displays the aggregate summary across all the LDP discovery processes.

Related Topics

[LDP Control Plane](#), on page 3

[Configuring LDP Discovery for Targeted Hellos: Example](#), on page 89

Configuring LDP Discovery for Passive Targeted Hellos

Perform this task to configure LDP discovery for passive targeted hellos.

A passive side for targeted hello is the destination router (tunnel tail), which passively waits for an incoming hello message. Because targeted hellos are unicast, the passive side waits for an incoming hello message to respond with hello toward its discovered neighbor.

Before you begin

Stable router ID is required at either end of the link to ensure that the link discovery (and session setup) is successful. If you do not assign a router ID to the routers, the system defaults to the global router ID. Default router IDs are subject to change and may cause an unstable discovery.

SUMMARY STEPS

1. **configure**
2. **mpls ldp**
3. **[vrf vrf-name] router-id ip-address lsr-id**
4. **discovery targeted-hello accept**
5. **commit**
6. (Optional) **show mpls ldp discovery**
7. (Optional) **show mpls ldp vrf vrf-name discovery**
8. (Optional) **show mpls ldp vrf all discovery summary**
9. (Optional) **show mpls ldp vrf all discovery brief**
10. (Optional) **show mpls ldp vrf all ipv4 discovery summary**
11. (Optional) **show mpls ldp discovery summary all**

DETAILED STEPS

	Command or Action	Purpose
Step 1	configure	
Step 2	mpls ldp Example: <pre>RP/0/RP0/CPU0:router(config)# mpls ldp</pre>	Enters MPLS LDP configuration mode.

	Command or Action	Purpose
Step 3	<p>[vrf vrf-name] router-id ip-address lsr-id</p> <p>Example:</p> <pre>RP/0/RP0/CPU0:router(config-ldp)# router-id 192.168.70.1</pre>	<p>(Optional) Specifies a non-default VRF.</p> <p>Specifies the router ID of the local node.</p> <ul style="list-style-type: none"> In Cisco IOS XR software, the router ID is specified as an interface IP address or LSR ID. By default, LDP uses the global router ID (configured by global router ID process).
Step 4	<p>discovery targeted-hello accept</p> <p>Example:</p> <pre>RP/0/RP0/CPU0:router(config-ldp)# discovery targeted-hello accept</pre>	<p>Directs the system to accept targeted hello messages from any source and activates passive mode on the LSR for targeted hello acceptance.</p> <ul style="list-style-type: none"> This command is executed on the receiver node (with respect to a given MPLS TE tunnel). You can control the targeted-hello acceptance using the discovery targeted-hello accept command.
Step 5	commit	
Step 6	<p>(Optional) show mpls ldp discovery</p> <p>Example:</p> <pre>RP/0/RP0/CPU0:router# show mpls ldp discovery</pre>	<p>Displays the status of the LDP discovery process. This command, without an interface filter, generates a list of interfaces over which the LDP discovery process is running. The output information contains the state of the link (xmt/rcv hellos), local LDP identifier, the discovered peer's LDP identifier, and holdtime values.</p>
Step 7	<p>(Optional) show mpls ldp vrf vrf-name discovery</p> <p>Example:</p> <pre>RP/0/RP0/CPU0:router# show mpls ldp vrf red discovery</pre>	<p>Displays the status of the LDP discovery process for the specified VRF.</p>
Step 8	<p>(Optional) show mpls ldp vrf all discovery summary</p> <p>Example:</p> <pre>RP/0/RP0/CPU0:router# show mpls ldp vrf all discovery summary</pre>	<p>Displays the summarized status of the LDP discovery process for all VRFs.</p>
Step 9	<p>(Optional) show mpls ldp vrf all discovery brief</p> <p>Example:</p> <pre>RP/0/RP0/CPU0:router# show mpls ldp vrf all discovery brief</pre>	<p>Displays the brief status of the LDP discovery process for all VRFs.</p>
Step 10	<p>(Optional) show mpls ldp vrf all ipv4 discovery summary</p> <p>Example:</p>	<p>Displays the summarized status of the LDP discovery process for all VRFs for the IPv4 address family.</p>

	Command or Action	Purpose
	RP/0/RP0/CPU0:router# <code>show mpls ldp vrf all ipv4 discovery summary</code>	
Step 11	(Optional) <code>show mpls ldp discovery summary all</code> Example: RP/0/RP0/CPU0:router# <code>show mpls ldp discovery summary all</code>	Displays the aggregate summary across all the LDP discovery processes.

Related Topics

[LDP Control Plane](#), on page 3

[Configuring LDP Discovery for Targeted Hellos: Example](#), on page 89

Configuring Label Advertisement Control (Outbound Filtering)

Perform this task to configure label advertisement (outbound filtering).

By default, a label switched router (LSR) advertises all incoming label prefixes to each neighboring router. You can control the exchange of label binding information using the `mpls ldp label advertise` command. Using the optional keywords, you can advertise selective prefixes to all neighbors, advertise selective prefixes to defined neighbors, or disable label advertisement to all peers for all prefixes.



Note Prefixes and peers advertised selectively are defined in the access list.

Before you begin

Before configuring label advertisement, enable LDP and configure an access list.

SUMMARY STEPS

1. `configure`
2. `mpls ldp`
3. `[vrf vrf-name] address-family { ipv4 | ipv6 }`
4. `label local advertise [to ldp-id for prefix-acl | interface type interface-path-id]`
5. `commit`

DETAILED STEPS

	Command or Action	Purpose
Step 1	<code>configure</code>	
Step 2	<code>mpls ldp</code> Example: RP/0/RP0/CPU0:router(config)# <code>mpls ldp</code>	Enters MPLS LDP configuration mode.

	Command or Action	Purpose
Step 3	<p>[vrf <i>vrf-name</i>] address-family { ipv4 ipv6 }</p> <p>Example:</p> <pre>RP/0/RP0/CPU0:router(config-ldp)# address-family ipv4</pre> <pre>RP/0/RP0/CPU0:router(config-ldp)# address-family ipv6</pre>	<p>(Optional) Specifies a non-default VRF.</p> <p>Enables the LDP IPv4 or IPv6 address family.</p>
Step 4	<p>label local advertise [to <i>ldp-id</i> for <i>prefix-acl</i> interface <i>type interface-path-id</i>]</p> <p>Example:</p> <pre>RP/0/RP0/CPU0:router(config-ldp-af)# label local advertise to 1.1.1.1:0 for pfx_acl1</pre> <pre>RP/0/RP0/CPU0:router(config-ldp-af)# label local advertise interface POS 0/1/0/0</pre>	<p>Configures outbound label advertisement control by specifying one of the following options:</p> <p>interface</p> <p>Specifies an interface for label advertisement.</p> <p>to <i>ldp-id</i> for <i>prefix-acl</i></p> <p>Specifies neighbors to advertise and receive label advertisements.</p>
Step 5	commit	

Related Topics

[Label Advertisement Control \(Outbound Filtering\)](#), on page 9

[Configuring Label Advertisement \(Outbound Filtering\): Example](#), on page 90

Setting Up LDP Neighbors

Perform this task to set up LDP neighbors.

Before you begin

Stable router ID is required at either end of the link to ensure the link discovery (and session setup) is successful. If you do not assign a router ID to the routers, the system will default to the global router ID. Default router IDs are subject to change and may cause an unstable discovery.

SUMMARY STEPS

- 1.** **configure**
- 2.** **mpls ldp**
- 3.** **interface** *type interface-path-id*
- 4.** **address-family** { **ipv4** | **ipv6** }
- 5.** **discovery transport-address** [*ip-address* | **interface**]
- 6.** **exit**
- 7.** **holdtime** *seconds*
- 8.** [vrf *vrf-name*] **neighbor** *ldp-id* **password** [**encrypted**] *password*

9. **backoff** *initial maximum*
10. **commit**
11. (Optional) **show mpls ldp neighbor**
12. (Optional) **show mpls ldp vrf** *vrf-name* **neighbor**
13. (Optional) **show mpls ldp vrf all neighbor brief**
14. (Optional) **clear mpls ldp neighbor**
15. (Optional) **clear mpls ldp vrf all neighbor**
16. (Optional) **clear mpls ldp vrf** *vrf-name* **neighbor**

DETAILED STEPS

	Command or Action	Purpose
Step 1	configure	
Step 2	mpls ldp Example: RP/0/RP0/CPU0:router (config)# mpls ldp	Enters MPLS LDP configuration mode.
Step 3	interface <i>type interface-path-id</i> Example: RP/0/RP0/CPU0:router (config-ldp)# interface POS 0/1/0/0	Enters interface configuration mode for the LDP protocol.
Step 4	address-family { ipv4 ipv6 } Example: RP/0/RP0/CPU0:router (config-ldp-if)# address-family ipv4 OR RP/0/RP0/CPU0:router (config-ldp-if)# address-family ipv6	Enables the LDP IPv4 or IPv6 address family.
Step 5	discovery transport-address [<i>ip-address</i> interface] Example: RP/0/RP0/CPU0:router (config-ldp-if-af)# discovery transport-address 192.168.1.42 RP/0/RP0/CPU0:router (config-ldp-if-af)# discovery transport-address 5:6::78 OR RP/0/RP0/CPU0:router (config-ldp-if-af)# discovery transport-address interface	Provides an alternative transport address for a TCP connection. <ul style="list-style-type: none"> • Default transport address advertised by an LSR (for TCP connections) to its peer is the router ID. • Transport address configuration is applied for a given LDP-enabled interface. • If the interface version of the command is used, the configured IP address of the interface is passed to its neighbors as the transport address.

	Command or Action	Purpose
Step 6	exit Example: RP/0/RP0/CPU0:router(config-ldp-if) # exit	Exits the current configuration mode.
Step 7	holdtime <i>seconds</i> Example: RP/0/RP0/CPU0:router(config-ldp) # holdtime 30	Changes the time for which an LDP session is maintained in the absence of LDP messages from the peer. <ul style="list-style-type: none"> • Outgoing keepalive interval is adjusted accordingly (to make three keepalives in a given holdtime) with a change in session holdtime value. • Session holdtime is also exchanged when the session is established. • In this example holdtime is set to 30 seconds, which causes the peer session to timeout in 30 seconds, as well as transmitting outgoing keepalive messages toward the peer every 10 seconds.
Step 8	[vrf vrf-name] neighbor ldp-id password [encrypted] password Example: RP/0/RP0/CPU0:router(config-ldp) # neighbor 192.168.2.44:0 password secretpasswd	(Optional) Specifies a non-default VRF. Configures password authentication (using the TCP MD5 option) for a given neighbor.
Step 9	backoff <i>initial maximum</i> Example: RP/0/RP0/CPU0:router(config-ldp) # backoff 10 20	Configures the parameters for the LDP backoff mechanism. The LDP backoff mechanism prevents two incompatibly configured LSRs from engaging in an unthrottled sequence of session setup failures. If a session setup attempt fails due to such incompatibility, each LSR delays its next attempt (backs off), increasing the delay exponentially with each successive failure until the maximum backoff delay is reached.
Step 10	commit	
Step 11	(Optional) show mpls ldp neighbor Example: RP/0/RP0/CPU0:router# show mpls ldp neighbor	Displays the status of the LDP session with its neighbors. This command can be run with various filters as well as with the brief option.
Step 12	(Optional) show mpls ldp vrf vrf-name neighbor Example: RP/0/RP0/CPU0:router# show mpls ldp vrf red neighbor	Displays the status of the LDP session with its neighbors for the specified VRF. This command can be run with the brief option.

	Command or Action	Purpose
Step 13	(Optional) show mpls ldp vrf all neighbor brief Example: RP/0/RP0/CPU0:router# show mpls ldp vrf all neighbor brief	Displays the brief LDP session neighbor information for all VRFs.
Step 14	(Optional) clear mpls ldp neighbor Example: RP/0/RP0/CPU0:router# clear mpls ldp neighbor	Resets an LDP session.
Step 15	(Optional) clear mpls ldp vrf all neighbor Example: RP/0/RP0/CPU0:router# clear mpls ldp vrf all neighbor	Resets LDP session for all VRFs.
Step 16	(Optional) clear mpls ldp vrf vrf-name neighbor Example: RP/0/RP0/CPU0:router# clear mpls ldp vrf red neighbor	Resets LDP session for the specified VRF.

Related Topics

[Configuring LDP Neighbors: Example](#), on page 91

Setting Up LDP Forwarding

Perform this task to set up LDP forwarding.

By default, the LDP control plane implements the penultimate hop popping (PHOP) mechanism. The PHOP mechanism requires that label switched routers use the implicit-null label as a local label for the given Forwarding Equivalence Class (FEC) for which LSR is the penultimate hop. Although PHOP has certain advantages, it may be required to extend LSP up to the ultimate hop under certain circumstances (for example, to propagate MPL QoS). This is done using a special local label (explicit-null) advertised to the peers after which the peers use this label when forwarding traffic toward the ultimate hop (egress LSR).

Before you begin

Stable router ID is required at either end of the link to ensure the link discovery (and session setup) is successful. If you do not assign a router ID to the routers, the system will default to the global router ID. Default router IDs are subject to change and may cause an unstable discovery.

SUMMARY STEPS

1. **configure**
2. **mpls ldp**
3. **[vrf vrf-name] address-family {ipv4 | ipv6 }**

4. **label local advertise explicit-null**
5. **commit**
6. (Optional) **show mpls ldp forwarding**
7. (Optional) **show mpls ldp vrf all forwarding**
8. (Optional) **show mpls ldp vrf all forwarding summary**
9. (Optional) **show mpls ldp vrf *vrf-name* ipv4 forwarding**
10. (Optional) **show mpls ldp forwarding summary all**
11. (Optional) **clear mpls ldp vrf *vrf-name* ipv4 forwarding**
12. (Optional) **clear mpls ldp [ipv4 | ipv6]forwarding**
13. (Optional) **show mpls ldp afi-all forwarding**
14. (Optional) **show mpls ldp ipv6 forwarding**
15. (Optional) **show mpls forwarding**
16. (Optional) **ping *ip-address***

DETAILED STEPS

	Command or Action	Purpose
Step 1	configure	
Step 2	mpls ldp Example: RP/0/RP0/CPU0:router(config)# mpls ldp	Enters MPLS LDP configuration mode.
Step 3	[vrf <i>vrf-name</i>] address-family {ipv4 ipv6 } Example: RP/0/RP0/CPU0:router(config-ldp)# address-family ipv4 or RP/0/RP0/CPU0:router(config-ldp)# address-family ipv6	(Optional) Specifies a non-default VRF. Enables the LDP IPv4 or IPv6 address family.
Step 4	label local advertise explicit-null Example: RP/0/RP0/CPU0:router(config-ldp-af)# label local advertise explicit-null	Causes a router to advertise an explicit null label in situations where it normally advertises an implicit null label (for example, to enable an ultimate-hop disposition instead of PHOP).
Step 5	commit	
Step 6	(Optional) show mpls ldp forwarding Example: RP/0/RP0/CPU0:router# show mpls ldp forwarding	Displays the MPLS LDP view of installed forwarding states (rewrites). Note For local labels, only up to 12000 rewrites are supported. If the rewrites exceed this limit, MPLS LSD or MPLS LDP or both the processes may crash.

	Command or Action	Purpose
Step 7	(Optional) show mpls ldp vrf all forwarding Example: RP/0/RP0/CPU0:router# show mpls ldp vrf all forwarding	Displays the forwarding setup information of all LDP configured VRFs.
Step 8	(Optional) show mpls ldp vrf all forwarding summary Example: RP/0/RP0/CPU0:router# show mpls ldp vrf all forwarding summary	Displays the forwarding setup summary of all LDP configured VRFs.
Step 9	(Optional) show mpls ldp vrf vrf-name ipv4 forwarding Example: RP/0/RP0/CPU0:router# show mpls ldp vrf red ipv4 forwarding	Displays the forwarding setup information for the specified VRF for IPv4.
Step 10	(Optional) show mpls ldp forwarding summary all Example: RP/0/RP0/CPU0:router# show mpls ldp forwarding summary all	Displays the aggregate summary across LDP processes and all VRFs.
Step 11	(Optional) clear mpls ldp vrf vrf-name ipv4 forwarding Example: RP/0/RP0/CPU0:router# clear mpls ldp vrf red ipv4 forwarding	Resets the MPLS forwarding rewrites for the specified VRF for IPv4.
Step 12	(Optional) clear mpls ldp [ipv4 ipv6]forwarding Example: RP/0/RP0/CPU0:router# clear mpls ldp ipv4 forwarding or RP/0/RP0/CPU0:router# clear mpls ldp ipv6 forwarding	Resets the MPLS forwarding rewrites for either IPv4 or IPv6 addresses.
Step 13	(Optional) show mpls ldp afi-all forwarding Example: RP/0/RP0/CPU0:router# show mpls ldp afi-all forwarding	Displays the forwarding setup information of all address families.

	Command or Action	Purpose
Step 14	(Optional) show mpls ldp ipv6 forwarding Example: RP/0/RP0/CPU0:router# show mpls ldp ipv6 forwarding	Displays the MPLS LDP view of installed forwarding states (rewrites) for IPv6.
Step 15	(Optional) show mpls forwarding Example: RP/0/RP0/CPU0:router# show mpls forwarding	Displays a global view of all MPLS installed forwarding states (rewrites) by various applications (LDP, TE, and static).
Step 16	(Optional) ping ip-address Example: RP/0/RP0/CPU0:router# ping 192.168.2.55	Checks for connectivity to a particular IP address (going through MPLS LSP as shown in the show mpls forwarding command).

Related Topics

[LDP Forwarding](#), on page 4

[Configuring LDP Forwarding: Example](#), on page 91

Configuring Global Transport Address

Perform this task to configure global transport address for the IPv4 address family.

SUMMARY STEPS

1. **configure**
2. **mpls ldp**
3. **address-family ipv4**
4. **discovery transport-address ip-address**
5. **end** or **commit**

DETAILED STEPS

	Command or Action	Purpose
Step 1	configure	
Step 2	mpls ldp Example: RP/0/RP0/CPU0:router(config)# mpls ldp	Enters MPLS LDP configuration mode.
Step 3	address-family ipv4 Example: RP/0/RP0/CPU0:router(config-ldp)# address-family	Enables LDP IPv4 address family.

	Command or Action	Purpose
	<code>ipv4</code>	
Step 4	<p>discovery transport-address <i>ip-address</i></p> <p>Example:</p> <pre>RP/0/RP0/CPU0:router(config-ldp-af)# discovery transport-address 192.168.1.42</pre>	<p>Provides an alternative transport address for a TCP connection.</p> <ul style="list-style-type: none"> • Default transport address advertised by an LSR (for TCP connections) to its peer is the router ID.
Step 5	<p>end or commit</p> <p>Example:</p> <pre>RP/0/RP0/RP0/CPU0:router (config-ldp-af)# end or RP/0/RP0/RP0/CPU0:router (config-ldp-af)# commit</pre>	<ul style="list-style-type: none"> • When you issue the end command, the system prompts you to commit changes: <p style="margin-left: 20px;">Uncommitted changes found, commit them before exiting (yes/no/cancel)? [cancel]:</p> • Entering yes saves configuration changes to the running configuration file, exits the configuration session, and returns the router to EXEC mode. • Entering no exits the configuration session and returns the router to EXEC mode without committing the configuration changes. • Entering cancel leaves the router in the current configuration session without exiting or committing the configuration changes. • Use the commit command to save the configuration changes to the running configuration file and remain within the configuration session.

Setting Up LDP NSF Using Graceful Restart

Perform this task to set up NSF using LDP graceful restart.

LDP graceful restart is a way to enable NSF for LDP. The correct way to set up NSF using LDP graceful restart is to bring up LDP neighbors (link or targeted) with additional configuration related to graceful restart.

Before you begin

Stable router ID is required at either end of the link to ensure the link discovery (and session setup) is successful. If you do not assign a router ID to the routers, the system will default to the global router ID. Default router IDs are subject to change and may cause an unstable discovery.

SUMMARY STEPS

1. **configure**
2. **mpls ldp**
3. **interface** *type interface-path-id*
4. **exit**

5. **graceful-restart**
6. **graceful-restart forwarding-state-holdtime** *seconds*
7. **graceful-restart reconnect-timeout** *seconds*
8. **commit**
9. (Optional) **show mpls ldp** [*vrf vrf-name*] **parameters**
10. (Optional) **show mpls ldp neighbor**
11. (Optional) **show mpls ldp graceful-restart**
12. (Optional) **show mpls ldp vrf all graceful-restart**
13. (Optional) **show mpls ldp vrf** *vrf-name* **graceful-restart**

DETAILED STEPS

	Command or Action	Purpose
Step 1	configure	
Step 2	mpls ldp Example: RP/0/RP0/CPU0:router(config)# mpls ldp	Enters MPLS LDP configuration mode.
Step 3	interface <i>type interface-path-id</i> Example: RP/0/RP0/CPU0:router(config-ldp)# interface POS 0/1/0/0 RP/0/RP0/CPU0:router(config-ldp-if)#	Enters interface configuration mode for the LDP protocol.
Step 4	exit Example: RP/0/RP0/CPU0:router(config-ldp-if)# exit	Exits the current configuration mode.
Step 5	graceful-restart Example: RP/0/RP0/CPU0:router(config-ldp)# graceful-restart	Enables the LDP graceful restart feature.
Step 6	graceful-restart forwarding-state-holdtime <i>seconds</i> Example: RP/0/RP0/CPU0:router(config-ldp)# graceful-restart forwarding-state-holdtime 180	Specifies the length of time that forwarding can keep LDP-installed forwarding states and rewrites, and specifies when the LDP control plane restarts. <ul style="list-style-type: none"> • After restart of the control plane, when the forwarding state holdtime expires, any previously installed LDP forwarding state or rewrite that is not yet refreshed is deleted from the forwarding. • Recovery time sent after restart is computed as the current remaining value of the forwarding state hold timer.

	Command or Action	Purpose
Step 7	graceful-restart reconnect-timeout <i>seconds</i> Example: RP/0/RP0/CPU0:router (config-ldp) # graceful-restart reconnect-timeout 169	Specifies the length of time a neighbor waits before restarting the node to reconnect before declaring an earlier graceful restart session as down. This command is used to start a timer on the peer (upon a neighbor restart). This timer is referred to as <i>Neighbor Liveness</i> timer.
Step 8	commit	
Step 9	(Optional) show mpls ldp [vrf vrf-name] parameters Example: RP/0/RP0/CPU0:router # show mpls ldp parameters RP/0/RP0/CPU0:router # show mpls ldp vrf red parameters	Displays all the current MPLS LDP parameters. Displays the LDP parameters for the specified VRF.
Step 10	(Optional) show mpls ldp neighbor Example: RP/0/RP0/CPU0:router# show mpls ldp neighbor	Displays the status of the LDP session with its neighbors. This command can be run with various filters as well as with the brief option.
Step 11	(Optional) show mpls ldp graceful-restart Example: RP/0/RP0/CPU0:router# show mpls ldp graceful-restart	Displays the status of the LDP graceful restart feature. The output of this command not only shows states of different graceful restart timers, but also a list of graceful restart neighbors, their state, and reconnect count.
Step 12	(Optional) show mpls ldp vrf all graceful-restart Example: RP/0/RP0/CPU0:router# show mpls ldp vrf all graceful-restart	Displays the status of the LDP graceful restart for all VRFs.
Step 13	(Optional) show mpls ldp vrf vrf-name graceful-restart Example: RP/0/RP0/CPU0:router# show mpls ldp vrf red graceful-restart	Displays the status of the LDP graceful restart for the specified VRF.

Related Topics

[LDP Graceful Restart](#), on page 6

[Phases in Graceful Restart](#), on page 7

[Recovery with Graceful-Restart](#), on page 8

[Configuring LDP Nonstop Forwarding with Graceful Restart: Example](#), on page 91

Configuring Label Acceptance Control (Inbound Filtering)

Perform this task to configure LDP inbound label filtering.



Note By default, there is no inbound label filtering performed by LDP and thus an LSR accepts (and retains) all remote label bindings from all peers.

SUMMARY STEPS

1. **configure**
2. **mpls ldp**
3. **label accept for** *prefix-acl* **from** *ip-address*
4. [**vrf** *vrf-name*] **address-family** { **ipv4** | **ipv6**}
5. **label remote accept from** *ldp-id* **for** *prefix-acl*
6. **commit**

DETAILED STEPS

	Command or Action	Purpose
Step 1	configure	
Step 2	mpls ldp Example: RP/0/RP0/CPU0:router(config)# mpls ldp	Enters the MPLS LDP configuration mode.
Step 3	label accept for <i>prefix-acl</i> from <i>ip-address</i> Example: RP/0/RP0/CPU0:router(config-ldp)# label accept for pfx_acl_1 from 192.168.1.1 RP/0/RP0/CPU0:router(config-ldp)# label accept for pfx_acl_2 from 192.168.2.2	Configures inbound label acceptance for prefixes specified by prefix-acl from neighbor (as specified by its IP address).
Step 4	[vrf <i>vrf-name</i>] address-family { ipv4 ipv6 }	(Optional) Specifies a non-default VRF.
	Example: RP/0/RP0/CPU0:router(config-ldp)# address-family ipv4 RP/0/RP0/CPU0:router(config-ldp)# address-family ipv6	Enables the LDP IPv4 or IPv6 address family.

	Command or Action	Purpose
Step 5	label remote accept from <i>ldp-id</i> for <i>prefix-acl</i> Example: <pre>RP/0/RP0/CPU0:router(config-ldp-af)# label remote accept from 192.168.1.1:0 for pfx_acl_1</pre>	Configures inbound label acceptance control for prefixes specified by prefix-acl from neighbor (as specified by its LDP ID).
Step 6	commit	

Related Topics

[Label Acceptance Control \(Inbound Filtering\)](#), on page 10

[Configuring Label Acceptance \(Inbound Filtering\): Example](#), on page 92

Configuring Local Label Allocation Control

Perform this task to configure label allocation control.



Note By default, local label allocation control is disabled and all non-BGP prefixes are assigned local labels.

SUMMARY STEPS

1. **configure**
2. **mpls ldp**
3. **[vrf vrf-name] address-family { ipv4 | ipv6}**
4. **label local allocate for prefix-acl**
5. **commit**

DETAILED STEPS

	Command or Action	Purpose
Step 1	configure	
Step 2	mpls ldp Example: <pre>RP/0/RP0/CPU0:router(config)# mpls ldp</pre>	Enters the MPLS LDP configuration mode.
Step 3	[vrf vrf-name] address-family { ipv4 ipv6} Example: <pre>RP/0/RP0/CPU0:router(config-ldp)# address-family ipv4 RP/0/RP0/CPU0:router(config-ldp)# address-family</pre>	(Optional) Specifies a non-default VRF. Enables the LDP IPv4 or IPv6 address family.

	Command or Action	Purpose
	ipv6	
Step 4	label local allocate for <i>prefix-acl</i> Example: <pre>RP/0/RP0/CPU0:router(config-ldp-af)# label local allocate for pfx_acl_1</pre>	Configures label allocation control for prefixes as specified by <i>prefix-acl</i> .
Step 5	commit	

Related Topics

[Local Label Allocation Control](#), on page 10

[Configuring Local Label Allocation Control: Example](#), on page 92

Configuring Session Protection

Perform this task to configure LDP session protection.

By default, there is no protection is done for link sessions by means of targeted hellos.

SUMMARY STEPS

1. **configure**
2. **mpls ldp**
3. **session protection [for *peer-acl*] [duration *seconds*]**
4. **commit**

DETAILED STEPS

	Command or Action	Purpose
Step 1	configure	
Step 2	mpls ldp Example: <pre>RP/0/RP0/CPU0:router(config)# mpls ldp</pre>	Enters the MPLS LDP configuration mode.
Step 3	session protection [for <i>peer-acl</i>] [duration <i>seconds</i>] Example: <pre>RP/0/RP0/CPU0:router(config-ldp)# session protection for peer_acl_1 duration 60</pre>	Configures LDP session protection for peers specified by <i>peer-acl</i> with a maximum duration, in seconds.
Step 4	commit	

Related Topics[Session Protection](#), on page 10[Configuring LDP Session Protection: Example](#), on page 92

Configuring LDP IGP Synchronization: OSPF

Perform this task to configure LDP IGP Synchronization under OSPF.



Note By default, there is no synchronization between LDP and IGP.

SUMMARY STEPS

1. **configure**
2. **router ospf** *process-name*
3. (Optional) **vrf** *vrf-name*
4. Use one of the following commands:
 - **mpls ldp sync**
 - **area** *area-id* **mpls ldp sync**
 - **area** *area-id* **interface** *name* **mpls ldp sync**
5. (Optional) Use one of the following commands:
 - **mpls ldp sync**
 - **area** *area-id* **mpls ldp sync**
 - **area** *area-id* **interface** *name* **mpls ldp sync**
6. **commit**
7. (Optional) **show mpls ldp vrf** *vrf-name* **ipv4 igp sync**
8. (Optional) **show mpls ldp vrf all ipv4 igp sync**
9. (Optional) **show mpls ldp { ipv4 | ipv6 } igp sync**

DETAILED STEPS

	Command or Action	Purpose
Step 1	configure	
Step 2	router ospf <i>process-name</i> Example: RP/0/RP0/CPU0:router(config)# router ospf 100	Identifies the OSPF routing process and enters OSPF configuration mode.
Step 3	(Optional) vrf <i>vrf-name</i> Example: RP/0/RP0/CPU0:router(config-ospf)# vrf red	Specifies the non-default VRF.

	Command or Action	Purpose
Step 4	<p>Use one of the following commands:</p> <ul style="list-style-type: none"> • mpls ldp sync • area <i>area-id</i> mpls ldp sync • area <i>area-id</i> interface <i>name</i> mpls ldp sync <p>Example:</p> <pre>RP/0/RP0/CPU0:router (config-ospf) # mpls ldp sync</pre>	Enables LDP IGP synchronization on an interface.
Step 5	<p>(Optional) Use one of the following commands:</p> <ul style="list-style-type: none"> • mpls ldp sync • area <i>area-id</i> mpls ldp sync • area <i>area-id</i> interface <i>name</i> mpls ldp sync <p>Example:</p> <pre>RP/0/RP0/CPU0:router (config-ospf-vrf) # mpls ldp sync</pre> <pre>RP/0/RP0/CPU0:router (config-ospf-vrf) # area 1 mpls ldp sync</pre> <pre>RP/0/RP0/CPU0:router (config-ospf-vrf) # area 1 interface POS 0/2/0/0 mpls ldp sync</pre>	Enables LDP IGP synchronization on an interface for the specified VRF.
Step 6	commit	
Step 7	<p>(Optional) show mpls ldp vrf <i>vrf-name</i> ipv4 igp sync</p> <p>Example:</p> <pre>RP/0/RP0/CPU0:router# show mpls ldp vrf red ipv4 igp sync</pre>	Displays the LDP IGP synchronization information for the specified VRF for address family IPv4.
Step 8	<p>(Optional) show mpls ldp vrf all ipv4 igp sync</p> <p>Example:</p> <pre>RP/0/RP0/CPU0:router# show mpls ldp vrf all ipv4 igp sync</pre>	Displays the LDP IGP synchronization information for all VRFs for address family IPv4.
Step 9	<p>(Optional) show mpls ldp { ipv4 ipv6 } igp sync</p> <p>Example:</p> <pre>RP/0/RP0/CPU0:router# show mpls ldp ipv4 igp sync</pre> <pre>RP/0/RP0/CPU0:router# show mpls ldp ipv6 igp sync</pre>	Displays the LDP IGP synchronization information for IPv4 or IPv6 address families.

Related Topics

[IGP Synchronization](#), on page 11

[Configuring LDP IGP Synchronization—OSPF: Example](#), on page 93

Disabling LDP IGP Synchronization: OSPF

Perform this task to disable LDP IGP Synchronization under OSPF.

You can disable LDP IGP synchronization on a per-interface basis. This lets LDP enable all IGP interfaces except those that are explicitly disabled.

SUMMARY STEPS

1. **configure**
2. **router ospf** *process-name*
3. (Optional) **vrf** *vrf-name*
4. Use one of the following commands:
 - **area** *area-id* **mpls ldp sync disable**
 - **area** *area-id* **interface** *name* **mpls ldp sync disable**
5. (Optional) Use one of the following commands:
 - **area** *area-id* **mpls ldp sync disable**
 - **area** *area-id* **interface** *name* **mpls ldp sync disable**
6. **commit**

DETAILED STEPS

	Command or Action	Purpose
Step 1	configure	
Step 2	router ospf <i>process-name</i> Example: RP/0/RP0/CPU0:router(config)# router ospf 109	Identifies the OSPF routing process and enters OSPF configuration mode.
Step 3	(Optional) vrf <i>vrf-name</i> Example: RP/0/RP0/CPU0:router(config-ospf)# vrf red	Specifies the non-default VRF.
Step 4	Use one of the following commands: <ul style="list-style-type: none">• area <i>area-id</i> mpls ldp sync disable• area <i>area-id</i> interface <i>name</i> mpls ldp sync disable Example: RP/0/RP0/CPU0:router(config-ospf)# area 1 mpls ldp sync disable	Disables LDP IGP synchronization on an interface.

	Command or Action	Purpose
	RP/0/RP0/CPU0:router(config-ospf)# area 1 interface POS 0/2/0/0 mpls ldp sync disable	
Step 5	(Optional) Use one of the following commands: <ul style="list-style-type: none"> • area <i>area-id</i> mpls ldp sync disable • area <i>area-id</i> interface <i>name</i> mpls ldp sync disable Example: RP/0/RP0/CPU0:router(config-ospf-vrf)# area 1 mpls ldp sync disable RP/0/RP0/CPU0:router(config-ospf-vrf)# area 1 interface POS 0/2/0/0 mpls ldp sync disable	Disables LDP IGP synchronization on an interface for the specified VRF.
Step 6	commit	

Configuring LDP IGP Synchronization: ISIS

Perform this task to configure LDP IGP Synchronization under ISIS.



Note By default, there is no synchronization between LDP and ISIS.

SUMMARY STEPS

1. **configure**
2. **router isis** *instance-id*
3. **interface** *type interface-path-id*
4. **address-family** {**ipv4** | **ipv6**} **unicast**
5. **mpls ldp sync**
6. **commit**

DETAILED STEPS

	Command or Action	Purpose
Step 1	configure	
Step 2	router isis <i>instance-id</i> Example: RP/0/RP0/CPU0:router(config)# router isis 100 RP/0/RP0/CPU0:router(config-isis)#	Enables the Intermediate System-to-Intermediate System (IS-IS) routing protocol and defines an IS-IS instance.

	Command or Action	Purpose
Step 3	interface <i>type interface-path-id</i> Example: <pre>RP/0/RP0/CPU0:router(config-isis)# interface POS 0/2/0/0 RP/0/RP0/CPU0:router(config-isis-if)#</pre>	Configures the IS-IS protocol on an interface and enters ISIS interface configuration mode.
Step 4	address-family { ipv4 ipv6 } unicast Example: <pre>RP/0/RP0/CPU0:router(config-isis-if)# address-family ipv4 unicast RP/0/RP0/CPU0:router(config-isis-if-af)# RP/0/RP0/CPU0:router(config-isis-if)# address-family ipv6 unicast RP/0/RP0/CPU0:router(config-isis-if-af)#</pre>	Enters address family configuration mode for configuring IS-IS routing for a standard IP version 4 (IPv4) or IP version 6 (IPv6) address prefix.
Step 5	mpls ldp sync Example: <pre>RP/0/RP0/CPU0:router(config-isis-if-af)# mpls ldp sync</pre>	Enables LDP IGP synchronization.
Step 6	commit	

Related Topics

[IGP Synchronization](#), on page 11

[Configuring LDP IGP Synchronization—ISIS: Example](#), on page 93

Configuring LDP IGP Synchronization Delay Interval

Perform this task to configure the LDP IGP synchronization delay interval.

By default, LDP does not delay declaring sync up as soon as convergence conditions are met.

SUMMARY STEPS

1. **configure**
2. **mpls ldp**
3. **igp sync delay** *delay-time*
4. **commit**

DETAILED STEPS

	Command or Action	Purpose
Step 1	configure	

	Command or Action	Purpose
Step 2	mpls ldp Example: RP/0/RP0/CPU0:router(config)# mpls ldp	Enters the MPLS LDP configuration mode.
Step 3	igp sync delay <i>delay-time</i> Example: RP/0/RP0/CPU0:router(config-ldp)# igp sync delay 30	Configures LDP IGP synchronization delay in seconds.
Step 4	commit	

Related Topics

[IGP Synchronization](#), on page 11

Configuring LDP IGP Synchronization Process Restart Delay

Perform this task to enable process restart delay when an LDP fails or restarts.



Note By default, the LDP IGP Synchronization Process Restart Delay feature is disabled.

SUMMARY STEPS

1. **configure**
2. **mpls ldp**
3. Use one of the following commands:
 - **igp sync delay** *seconds*
 - **igp sync delay on-proc-restart** *delay-time*
4. **commit**

DETAILED STEPS

	Command or Action	Purpose
Step 1	configure	
Step 2	mpls ldp Example: RP/0/RP0/CPU0:router(config)# mpls ldp	Enters the MPLS LDP configuration mode.
Step 3	Use one of the following commands: • igp sync delay <i>seconds</i>	Configures LDP IGP delay in seconds.

	Command or Action	Purpose
	<ul style="list-style-type: none"> • <code>igp sync delay on-proc-restart delay-time</code> <p>Example:</p> <pre>RP/0/RP0/CPU0:router(config-ldp)# igp sync delay 30</pre>	
Step 4	commit	

Related Topics

[IGP Synchronization Process Restart Delay](#), on page 12

Enabling LDP Auto-Configuration for a Specified OSPF Instance

Perform this task to enable IGP auto-configuration globally for a specified OSPF process name.

You can disable auto-configuration on a per-interface basis. This lets LDP enable all IGP interfaces except those that are explicitly disabled.



Note This feature is supported for IPv4 unicast family in default VRF only.

SUMMARY STEPS

1. **configure**
2. **router ospf** *process-name*
3. **mpls ldp auto-config**
4. **area** *area-id*
5. **interface** *type interface-path-id*
6. **commit**

DETAILED STEPS

	Command or Action	Purpose
Step 1	configure	
Step 2	<p>router ospf <i>process-name</i></p> <p>Example:</p> <pre>RP/0/RP0/CPU0:router(config)# router ospf 190 RP/0/RP0/CPU0:router(config-ospf)#</pre>	Enters a uniquely identifiable OSPF routing process. The process name is any alphanumeric string no longer than 40 characters without spaces.
Step 3	<p>mpls ldp auto-config</p> <p>Example:</p> <pre>RP/0/RP0/CPU0:router(config-ospf)# mpls ldp auto-config</pre>	Enables LDP auto-configuration.

	Command or Action	Purpose
Step 4	area <i>area-id</i> Example: RP/0/RP0/CPU0:router(config-ospf)# area 8	Configures an OSPF area and identifier. area-id Either a decimal value or an IP address.
Step 5	interface <i>type interface-path-id</i> Example: RP/0/RP0/CPU0:router(config-ospf-ar)# interface pos 0/6/0/0	Enables LDP auto-configuration on the specified interface. Note LDP configurable limit for maximum number of interfaces does not apply to IGP auto-configuration interfaces.
Step 6	commit	

Related Topics

[IGP Auto-configuration](#), on page 12

[Configuring LDP Auto-Configuration: Example](#), on page 93

[Disabling LDP Auto-Configuration](#), on page 61

Enabling LDP Auto-Configuration in an Area for a Specified OSPF Instance

Perform this task to enable IGP auto-configuration in a defined area with a specified OSPF process name.

You can disable auto-configuration on a per-interface basis. This lets LDP enable all IGP interfaces except those that are explicitly disabled.



Note This feature is supported for IPv4 unicast family in default VRF only.

SUMMARY STEPS

1. **configure**
2. **router ospf** *process-name*
3. **area** *area-id*
4. **mpls ldp auto-config**
5. **interface** *type interface-path-id*
6. **commit**

DETAILED STEPS

	Command or Action	Purpose
Step 1	configure	

	Command or Action	Purpose
Step 2	router ospf <i>process-name</i> Example: RP/0/RP0/CPU0:router(config)# router ospf 100 RP/0/RP0/CPU0:router(config-ospf)#	Enters a uniquely identifiable OSPF routing process. The process name is any alphanumeric string no longer than 40 characters without spaces.
Step 3	area <i>area-id</i> Example: RP/0/RP0/CPU0:router(config-ospf)# area 8 RP/0/RP0/CPU0:router(config-ospf-ar)#	Configures an OSPF area and identifier. area-id Either a decimal value or an IP address.
Step 4	mpls ldp auto-config Example: RP/0/RP0/CPU0:router(config-ospf-ar)# mpls ldp auto-config	Enables LDP auto-configuration.
Step 5	interface <i>type interface-path-id</i> Example: RP/0/RP0/CPU0:router(config-ospf-ar)# interface pos 0/6/0/0 RP/0/RP0/CPU0:router(config-ospf-ar-if)	Enables LDP auto-configuration on the specified interface. The LDP configurable limit for maximum number of interfaces does not apply to IGP auto-config interfaces.
Step 6	commit	

Related Topics

[IGP Auto-configuration](#), on page 12

[Configuring LDP Auto-Configuration: Example](#), on page 93

[Disabling LDP Auto-Configuration](#), on page 61

Disabling LDP Auto-Configuration

Perform this task to disable IGP auto-configuration.

You can disable auto-configuration on a per-interface basis. This lets LDP enable all IGP interfaces except those that are explicitly disabled.

SUMMARY STEPS

1. **configure**
2. **mpls ldp**
3. **interface** *type interface-path-id*
4. **igp auto-config disable**
5. **commit**

DETAILED STEPS

	Command or Action	Purpose
Step 1	configure	
Step 2	mpls ldp Example: RP/0/RP0/CPU0:router(config)# mpls ldp RP/0/RP0/CPU0:router(config-ldp)#	Enters the MPLS LDP configuration mode.
Step 3	interface <i>type interface-path-id</i> Example: RP/0/RP0/CPU0:router(config-ldp)# interface pos 0/6/0/0	Enters interface configuration mode and configures an interface.
Step 4	igp auto-config disable Example: RP/0/RP0/CPU0:router(config-ldp-if)# igp auto-config disable	Disables auto-configuration on the specified interface.
Step 5	commit	

Related Topics

[IGP Auto-configuration](#), on page 12

[Configuring LDP Auto-Configuration: Example](#), on page 93

Configuring LDP Nonstop Routing

Perform this task to configure LDP NSR.



Note By default, NSR is globally-enabled on all LDP sessions except AToM.

SUMMARY STEPS

1. **configure**
2. **mpls ldp**
3. **nsr**
4. **commit**
5. (Optional) **show mpls ldp [vrf vrf-name] nsr statistics**
6. (Optional) **show mpls ldp vrf vrf-name nsr statistics neighbor**
7. (Optional) **show mpls ldp [vrf vrf-name] nsr summary**
8. (Optional) **show mpls ldp [vrf vrf-name] nsr pending**
9. (Optional) **show mpls ldp vrf vrf-name nsr pending neighbor**
10. (Optional) **show mpls ldp vrf all nsr summary**

11. (Optional) **show mpls ldp nsr summary all**
12. (Optional) **clear mpls ldp vrf vrf-name nsr statistics neighbor**

DETAILED STEPS

	Command or Action	Purpose
Step 1	configure	
Step 2	mpls ldp Example: RP/0/RP0/CPU0:router(config)# mpls ldp	Enters the MPLS LDP configuration mode.
Step 3	nsr Example: RP/0/RP0/CPU0:router(config-ldp)# nsr	Enables LDP nonstop routing.
Step 4	commit	
Step 5	(Optional) show mpls ldp [vrf vrf-name] nsr statistics Example: RP/0/RP0/CPU0:router# show mpls ldp nsr statistics RP/0/RP0/CPU0:router# show mpls ldp vrf red nsr statistics	Displays MPLS LDP NSR statistics. Displays LDP NSR statistics for the specified VRF.
Step 6	(Optional) show mpls ldp vrf vrf-name nsr statistics neighbor Example: RP/0/RP0/CPU0:router# show mpls ldp vrf red nsr statistics neighbor 1.1.1.1	Displays LDP NSR statistics for the specified VRF for a given neighbor.
Step 7	(Optional) show mpls ldp [vrf vrf-name] nsr summary Example: RP/0/RP0/CPU0:router# show mpls ldp nsr summary RP/0/RP0/CPU0:router# show mpls ldp vrf red nsr summary	Displays MPLS LDP NSR summarized information. Displays LDP NSR summarized information for the specified VRF.
Step 8	(Optional) show mpls ldp [vrf vrf-name] nsr pending Example: RP/0/RP0/CPU0:router# show mpls ldp nsr pending	Displays MPLS LDP NSR pending information. Displays LDP NSR pending information for the specified VRF.

	Command or Action	Purpose
	<code>RP/0/RP0/CPU0:router# show mpls ldp vrf red nsr pending</code>	
Step 9	(Optional) show mpls ldp vrf <i>vrf-name</i> nsr pending neighbor Example: <code>RP/0/RP0/CPU0:router# show mpls ldp vrf red nsr pending neighbor 2.2.2.2</code>	Displays LDP NSR pending information for the specified VRF for a given neighbor.
Step 10	(Optional) show mpls ldp vrf all nsr summary Example: <code>RP/0/RP0/CPU0:router# show mpls ldp vrf all nsr summary</code>	Displays all LDP configured VRF (including default VRF) summarized information.
Step 11	(Optional) show mpls ldp nsr summary all Example: <code>RP/0/RP0/CPU0:router# show mpls ldp nsr summary all</code>	Displays aggregate summary across LDP processes and all VRFs.
Step 12	(Optional) clear mpls ldp vrf <i>vrf-name</i> nsr statistics neighbor Example: <code>RP/0/RP0/CPU0:router# clear mpls ldp vrf red nsr statistics neighbor</code>	Resets LDP NSR statistics for the specified VRF for neighbor.

Related Topics

[LDP Nonstop Routing](#), on page 13

Configuring LDP Downstream on Demand mode

SUMMARY STEPS

1. **configure**
2. **mpls ldp**
3. [**vrf *vrf-name* session**] **downstream-on-demand**
4. **commit**

DETAILED STEPS

	Command or Action	Purpose
Step 1	configure	

	Command or Action	Purpose
Step 2	mpls ldp Example: RP/0/RP0/CPU0:router(config)# mpls ldp	Enters MPLS LDP configuration mode.
Step 3	[vrf vrf-name session] downstream-on-demand Example: RP/0/RP0/CPU0:router(config-ldp)# vrf red session downstream-on-demand with ABC	(Optional) Enters downstream on demand label advertisement mode under the specified non-default VRF. Enters downstream on demand label advertisement mode. The ACL contains the list of peer IDs that are configured for downstream-on-demand mode. When the ACL is changed or configured, the list of established neighbor is traversed.
Step 4	commit	

Related Topics

[Downstream on Demand](#), on page 15

Setting Up Implicit-Null-Override Label

Perform this task to configure implicit-null label for non-egress prefixes.

SUMMARY STEPS

1. **configure**
2. **mpls ldp**
3. **[vrf vrf-name] address-family {ipv4 | ipv6 }**
4. **label**
5. **local implicit-null-override for access-list**
6. **commit**

DETAILED STEPS

	Command or Action	Purpose
Step 1	configure	
Step 2	mpls ldp Example: RP/0/RP0/CPU0:router(config)# mpls ldp	Enters MPLS LDP configuration mode.
Step 3	[vrf vrf-name] address-family {ipv4 ipv6 } Example: RP/0/RP0/CPU0:router(config-ldp)# address-family ipv4	(Optional) Specifies a non-default VRF. Enables the LDP IPv4 or IPv6 address family.

	Command or Action	Purpose
	or RP/0/RP0/CPU0:router(config-ldp)# address-family ipv6	
Step 4	label Example: RP/0/RP0/CPU0:router(config-ldp-af)# label	Configures the allocation, advertisement, and acceptance of labels.
Step 5	local implicit-null-override for access-list Example: RP/0/RP0/CPU0:router(config-ldp-af-lbl)# local implicit-null-override for 70	Configures implicit-null local label for non-egress prefixes. Note This feature works with any prefix including static, IGP, and BGP, when specified in the ACL.
Step 6	commit	

Redistributing MPLS LDP Routes into BGP

Perform this task to redistribute Border Gateway Protocol (BGP) autonomous system into an MPLS LDP.

SUMMARY STEPS

1. **configure**
2. **mpls ldp**
3. **redistribute bgp**
4. **end** or **commit**
5. **show run mpls ldp**

DETAILED STEPS

	Command or Action	Purpose
Step 1	configure Example: RP/0/RP0/CPU0:router# configure	Enters Global Configuration mode.
Step 2	mpls ldp Example: RP/0/RP0/CPU0:router(config)# mpls ldp	Enters MPLS LDP configuration mode.
Step 3	redistribute bgp Example:	Allows the redistribution of BGP routes into an MPLS LDP processes.

	Command or Action	Purpose
	<pre>RP/0/RP0/CPU0:router(config-ldp)# redistribute bgp advertise-to acl_1</pre>	<p>Note Autonomous system numbers (ASNs) are globally unique identifiers used to identify autonomous systems (ASs) and enable ASs to exchange exterior routing information between neighboring ASs. A unique ASN is allocated to each AS for use in BGP routing. ASNs are encoded as 2-byte numbers and 4-byte numbers in BGP.</p>
Step 4	end or commit	<ul style="list-style-type: none"> When you issue the end command, the system prompts you to commit changes: <pre>Uncommitted changes found, commit them before exiting (yes/no/cancel)? [cancel]:</pre> Entering yes saves configuration changes to the running configuration file, exits the configuration session, and returns the router to EXEC mode. Entering no exits the configuration session and returns the router to EXEC mode without committing the configuration changes. Entering cancel leaves the router in the current configuration session without exiting or committing the configuration changes. Use the commit command to save the configuration changes to the running configuration file and remain within the configuration session.
Step 5	show run mpls ldp Example: <pre>RP/0/RP0/CPU0:router# show run mpls ldp</pre>	Displays information about the redistributed route information.

Enabling MLDP

Perform this task to enable Multicast Label Distribution Protocol (MLDP) in MPLS LDP.

SUMMARY STEPS

1. **configure**
2. **mpls ldp**
3. **mldp**
4. **end** or **commit**

DETAILED STEPS

	Command or Action	Purpose
Step 1	configure	
Step 2	mpls ldp Example: RP/0/RP0/CPU0:router (config) # mpls ldp	Enters the MPLS LDP configuration mode.
Step 3	mldp Example: RP/0/RP0/CPU0:router (config-ldp) # mldp RP/0/RP0/CPU0:router (config-ldp-mldp) #	Enables MLDP.
Step 4	end or commit Example: RP/0/RP0/RP0/CPU0:router (config-ldp-mldp) # end or RP/0/RP0/RP0/CPU0:router (config-ldp-mldp) # commit	<ul style="list-style-type: none"> When you issue the end command, the system prompts you to commit changes: Uncommitted changes found, commit them before exiting (yes/no/cancel)? [cancel]: Entering yes saves configuration changes to the running configuration file, exits the configuration session, and returns the router to EXEC mode. Entering no exits the configuration session and returns the router to EXEC mode without committing the configuration changes. Entering cancel leaves the router in the current configuration session without exiting or committing the configuration changes. Use the commit command to save the configuration changes to the running configuration file and remain within the configuration session.

Enabling MLDP Make-Before-Break

Perform this task to enable the make-before-break (MBB) feature in MPLS MLDP.

SUMMARY STEPS

1. **configure**
2. **mpls ldp**
3. **mldp**
4. **address-family ipv4**
5. **make-before-break** [delay *seconds*]

6. end or commit

DETAILED STEPS

	Command or Action	Purpose
Step 1	configure Example: RP/0/RP0/CPU0:router# configure	Enters Global Configuration mode.
Step 2	mpls ldp Example: RP/0/RP0/CPU0:router(config)# mpls ldp	Enters MPLS LDP configuration mode.
Step 3	mldp Example: RP/0/RP0/CPU0:router(config-ldp)# mldp	Enables MLDP.
Step 4	address-family ipv4 Example: RP/0/RP0/CPU0:router(config-ldp-mldp)# address-family ipv4	Enables MLDP for IPv4 address family.
Step 5	make-before-break [delay seconds] Example: RP/0/RP0/CPU0:router(config-ldp-mldp-af)# make-before-break delay 10	Enables the make-before-break feature. (Optional) Configures the MBB forwarding delay in seconds. Range is 0 to 600.
Step 6	end or commit Example: RP/0/RP0/RP0/CPU0:router (config-ldp-mldp-af)# end or RP/0/RP0/RP0/CPU0:router (config-ldp-mldp-af)# commit	<ul style="list-style-type: none"> When you issue the end command, the system prompts you to commit changes: Uncommitted changes found, commit them before exiting (yes/no/cancel)? [cancel]: Entering yes saves configuration changes to the running configuration file, exits the configuration session, and returns the router to EXEC mode. Entering no exits the configuration session and returns the router to EXEC mode without committing the configuration changes.

	Command or Action	Purpose
		<ul style="list-style-type: none"> • Entering cancel leaves the router in the current configuration session without exiting or committing the configuration changes. • Use the commit command to save the configuration changes to the running configuration file and remain within the configuration session.

Enabling MLDP MoFRR

Perform this task to enable multicast only fast reroute (MoFRR) support in MPLS MLDP.

SUMMARY STEPS

1. **configure**
2. **mpls ldp**
3. **mldp**
4. **address-family ipv4**
5. **mofrr**
6. **end** or **commit**

DETAILED STEPS

	Command or Action	Purpose
Step 1	configure Example: RP/0/RP0/CPU0:router# configure	Enters Global Configuration mode.
Step 2	mpls ldp Example: RP/0/RP0/CPU0:router(config)# mpls ldp	Enters MPLS LDP configuration mode.
Step 3	mldp Example: RP/0/RP0/CPU0:router(config-ldp)# mldp	Enables MLDP.
Step 4	address-family ipv4 Example: RP/0/RP0/CPU0:router(config-ldp-mldp)# address-family ipv4	Enables MLDP for IPv4 address family.

	Command or Action	Purpose
Step 5	<p>mofrr</p> <p>Example:</p> <pre>RP/0/RP0/CPU0:router(config-ldp-mldp-af)# mofrr</pre>	Enables MoFRR support.
Step 6	<p>end or commit</p> <p>Example:</p> <pre>RP/0/RP/0/RP0/CPU0:router (config-ldp-mldp-af)# end</pre> <p>OR</p> <pre>RP/0/RP/0/RP0/CPU0:router (config-ldp-mldp-af)# commit</pre>	<ul style="list-style-type: none"> When you issue the end command, the system prompts you to commit changes: <pre>Uncommitted changes found, commit them before exiting (yes/no/cancel)? [cancel]:</pre> Entering yes saves configuration changes to the running configuration file, exits the configuration session, and returns the router to EXEC mode. Entering no exits the configuration session and returns the router to EXEC mode without committing the configuration changes. Entering cancel leaves the router in the current configuration session without exiting or committing the configuration changes. Use the commit command to save the configuration changes to the running configuration file and remain within the configuration session.

Enabling MLDP Recursive FEC

Perform this task to enable recursive forwarding equivalence class (FEC) support in MPLS MLDP.

SUMMARY STEPS

1. **configure**
2. **mpls ldp**
3. **mldp**
4. **address-family ipv4**
5. **recursive-fec**
6. **end** or **commit**

DETAILED STEPS

	Command or Action	Purpose
Step 1	<p>configure</p> <p>Example:</p>	Enters Global Configuration mode.

	Command or Action	Purpose
	RP/0/RP0/CPU0:router# configure	
Step 2	mpls ldp Example: RP/0/RP0/CPU0:router(config)# mpls ldp	Enters MPLS LDP configuration mode.
Step 3	mldp Example: RP/0/RP0/CPU0:router(config-ldp)# mldp	Enables MLDP.
Step 4	address-family ipv4 Example: RP/0/RP0/CPU0:router(config-ldp-mldp)# address-family ipv4	Enables MLDP for IPv4 address family.
Step 5	recursive-fec Example: RP/0/RP0/CPU0:router(config-ldp-mldp-af)# recursive-fec	Enables recursive FEC support.
Step 6	end or commit Example: RP/0/RP0/RP0/CPU0:router (config-ldp-mldp-af)# end OR RP/0/RP0/RP0/CPU0:router (config-ldp-mldp-af)# commit	<ul style="list-style-type: none"> When you issue the end command, the system prompts you to commit changes: Uncommitted changes found, commit them before exiting (yes/no/cancel)? [cancel]: Entering yes saves configuration changes to the running configuration file, exits the configuration session, and returns the router to EXEC mode. Entering no exits the configuration session and returns the router to EXEC mode without committing the configuration changes. Entering cancel leaves the router in the current configuration session without exiting or committing the configuration changes. Use the commit command to save the configuration changes to the running configuration file and remain within the configuration session.

Enabling MLDP Static Multipoint to Multipoint LSP

Perform this task to enable static multipoint to multipoint (MP2MP) LSP support in MPLS MLDP.

SUMMARY STEPS

1. **configure**
2. **mpls ldp**
3. **mldp**
4. **address-family ipv4**
5. **static mp2mp ip-address**
6. **end** or **commit**

DETAILED STEPS

	Command or Action	Purpose
Step 1	configure Example: RP/0/RP0/CPU0:router# configure	Enters Global Configuration mode.
Step 2	mpls ldp Example: RP/0/RP0/CPU0:router(config)# mpls ldp	Enters MPLS LDP configuration mode.
Step 3	mldp Example: RP/0/RP0/CPU0:router(config-ldp)# mldp	Enables MLDP.
Step 4	address-family ipv4 Example: RP/0/RP0/CPU0:router(config-ldp-mldp)# address-family ipv4	Enables MLDP for IPv4 address family.
Step 5	static mp2mp ip-address Example: RP/0/RP0/CPU0:router(config-ldp-mldp-af)# static mp2mp 10.10.10.10 1	Enables static MP2MP LSP support and specifies MP2MP LSP root IP address followed by the number of LSPs in the range 1 to 1000.
Step 6	end or commit Example:	<ul style="list-style-type: none"> • When you issue the end command, the system prompts you to commit changes:

	Command or Action	Purpose
	<pre>RP/0/RP/0/RP0/CPU0:router (config-ldp-mldp-af) # end</pre> <p>or</p> <pre>RP/0/RP/0/RP0/CPU0:router (config-ldp-mldp-af) # commit</pre>	<p>Uncommitted changes found, commit them before exiting (yes/no/cancel)? [cancel]:</p> <ul style="list-style-type: none"> • Entering yes saves configuration changes to the running configuration file, exits the configuration session, and returns the router to EXEC mode. • Entering no exits the configuration session and returns the router to EXEC mode without committing the configuration changes. • Entering cancel leaves the router in the current configuration session without exiting or committing the configuration changes. • Use the commit command to save the configuration changes to the running configuration file and remain within the configuration session.

Enabling MLDP Static Point to Multipoint LSP

Perform this task to enable static point to multipoint (P2MP) LSP support in MPLS MLDP.

SUMMARY STEPS

1. **configure**
2. **mpls ldp**
3. **mldp**
4. **address-family ipv4**
5. **static p2mp** *ip-address*
6. **end** or **commit**

DETAILED STEPS

	Command or Action	Purpose
Step 1	<p>configure</p> <p>Example:</p> <pre>RP/0/RP0/CPU0:router# configure</pre>	Enters Global Configuration mode.
Step 2	<p>mpls ldp</p> <p>Example:</p> <pre>RP/0/RP0/CPU0:router (config) # mpls ldp</pre>	Enters MPLS LDP configuration mode.

	Command or Action	Purpose
Step 3	mldp Example: <pre>RP/0/RP0/CPU0:router(config-ldp)# mldp</pre>	Enables MLDP.
Step 4	address-family ipv4 Example: <pre>RP/0/RP0/CPU0:router(config-ldp-mldp)# address-family ipv4</pre>	Enables MLDP for IPv4 address family.
Step 5	static p2mp ip-address Example: <pre>RP/0/RP0/CPU0:router(config-ldp-mldp-af)# static p2mp 1.1.1.1 1</pre>	Enables static P2MP LSP support and specifies P2MP LSP root IP address followed by the number of LSPs in the range 1 to 1000.
Step 6	end or commit Example: <pre>RP/0/RP0/RP0/CPU0:router (config-ldp-mldp-af)# end</pre> <p>OR</p> <pre>RP/0/RP0/RP0/CPU0:router (config-ldp-mldp-af)# commit</pre>	<ul style="list-style-type: none"> When you issue the end command, the system prompts you to commit changes: <pre>Uncommitted changes found, commit them before exiting (yes/no/cancel)? [cancel]:</pre> Entering yes saves configuration changes to the running configuration file, exits the configuration session, and returns the router to EXEC mode. Entering no exits the configuration session and returns the router to EXEC mode without committing the configuration changes. Entering cancel leaves the router in the current configuration session without exiting or committing the configuration changes. Use the commit command to save the configuration changes to the running configuration file and remain within the configuration session.

Disabling MLDP

Perform this task to disable MLDP on Label Distribution Protocol (LDP) enabled interfaces.

SUMMARY STEPS

1. configure

2. `mpls ldp`
3. `interface type interface-path-id`
4. `address-family {ipv4 | ipv6 }`
5. `igp mldp disable`
6. `commit`

DETAILED STEPS

	Command or Action	Purpose
Step 1	configure Example: RP/0/RP0/CPU0:router# configure	Enters Global Configuration mode.
Step 2	mpls ldp Example: RP/0/RP0/CPU0:router(config)# mpls ldp	Enters MPLS LDP configuration mode.
Step 3	interface type interface-path-id Example: RP/0/RP0/CPU0:router(config-ldp)# interface POS 0/1/0/0	Enters interface configuration mode for the LDP protocol.
Step 4	address-family {ipv4 ipv6 } Example: RP/0/RP0/CPU0:router(config-ldp-if)# address-family ipv4 OR RP/0/RP0/CPU0:router(config-ldp-if)# address-family ipv6	Enables the LDP IPv4 or IPv6 address family.
Step 5	igp mldp disable Example: RP/0/RP0/CPU0:router(config-ldp-if-af)# igp mldp disable	Disables MLDP.
Step 6	commit	

LDP IPv6 Configuration

The LDP configuration model is extended to introduce IPv6 as an option under the address family submodes that reside under LDP global and interface configurations. Address family IPv6 is available as a submode under LDP global, LDP VRF global and interface configurations. LDP IPv6 is supported only under default VRF.

Enabling LDP IPv6 Native

Perform this task to enable LDP IPv6 native under LDP.

The user must enable IPv6 address family under LDP submodes.

SUMMARY STEPS

1. **configure**
2. **mpls ldp**
3. **address-family ipv6**
4. **end** or **commit**

DETAILED STEPS

	Command or Action	Purpose
Step 1	configure Example: RP/0/RP0/CPU0:router# configure	Enters global configuration mode.
Step 2	mpls ldp Example: RP/0/RP0/CPU0:router(config)# mpls ldp	Enters MPLS LDP configuration mode.
Step 3	address-family ipv6 Example: RP/0/RP0/CPU0:router(config-ldp)# address-family ipv6 RP/0/RP0/CPU0:router(config-ldp-af)#	Enables native LDP IPv6 address family.
Step 4	end or commit Example: RP/0/RP0/RP0/CPU0:router (config-ldp-af)# end or	<ul style="list-style-type: none"> • When you issue the end command, the system prompts you to commit changes: Uncommitted changes found, commit them before exiting (yes/no/cancel)? [cancel]:

	Command or Action	Purpose
	RP/0/RP0/CPU0:router (config-ldp-af)# commit	<ul style="list-style-type: none"> • Entering yes saves configuration changes to the running configuration file, exits the configuration session, and returns the router to EXEC mode. • Entering no exits the configuration session and returns the router to EXEC mode without committing the configuration changes. • Entering cancel leaves the router in the current configuration session without exiting or committing the configuration changes. • Use the commit command to save the configuration changes to the running configuration file and remain within the configuration session.

Enabling LDP IPv6 Control Plane

Perform this task to enable LDP IPv6 control plane on an LDP interface.

SUMMARY STEPS

1. **configure**
2. **mpls ldp**
3. **interface** *type interface-path-id*
4. **address-family ipv6**
5. **end** or **commit**

DETAILED STEPS

	Command or Action	Purpose
Step 1	configure Example: RP/0/RP0/CPU0:router# configure	Enters global configuration mode.
Step 2	mpls ldp Example: RP/0/RP0/CPU0:router (config)# mpls ldp	Enters MPLS LDP configuration mode.
Step 3	interface <i>type interface-path-id</i> Example: RP/0/RP0/CPU0:router (config-ldp)# interface pos 0/6/0/0	Enters interface configuration mode for the LDP protocol.

	Command or Action	Purpose
Step 4	<p>address-family ipv6</p> <p>Example:</p> <pre>RP/0/RP0/CPU0:router(config-ldp-if)# address-family ipv6</pre>	Enables LDP IPv6 control plane.
Step 5	<p>end or commit</p> <p>Example:</p> <pre>RP/0/RP0/RP0/CPU0:router (config-ldp-if-af)# end or RP/0/RP0/RP0/CPU0:router (config-ldp-if-af)# commit</pre>	<p>Note This configuration will be rejected if (mpls-ldp-af) for the given address family is not already enabled.</p> <ul style="list-style-type: none"> • When you issue the end command, the system prompts you to commit changes: <pre>Uncommitted changes found, commit them before exiting (yes/no/cancel)? [cancel]:</pre> • Entering yes saves configuration changes to the running configuration file, exits the configuration session, and returns the router to EXEC mode. • Entering no exits the configuration session and returns the router to EXEC mode without committing the configuration changes. • Entering cancel leaves the router in the current configuration session without exiting or committing the configuration changes. • Use the commit command to save the configuration changes to the running configuration file and remain within the configuration session.

Configuring IPv6-only LSR

Perform this task to configure IPv6-only LSR.

IPv4 is implicitly enabled under default VRF and any LDP interface under default VRF. In order to operate as an IPv6-only LSR, the user must also explicitly disable IPv4 address family.

SUMMARY STEPS

1. **configure**
2. **interface loopback** *number*
3. **ipv6 address** *prefix*
4. **exit**
5. **interface type** *interface-path-id*
6. **ipv6 address** *prefix*
7. **exit**

8. **router isis** *process-id*
9. **net** *network-entity-title*
10. **interface loopback** *number*
11. **address-family ipv6 unicast**
12. **exit**
13. **exit**
14. **interface type** *interface-path-id*
15. **address-family ipv6 unicast**
16. **exit**
17. **exit**
18. **mpls ldp**
19. **default-vrf implicit-ipv4 disable**
20. **router-id** *lsr id*
21. **address-family ipv6**
22. **exit**
23. **interface type** *interface-path-id*
24. **address-family ipv6**
25. **end** or **commit**

DETAILED STEPS

	Command or Action	Purpose
Step 1	configure Example: RP/0/RP0/CPU0:router# configure	Enters global configuration mode.
Step 2	interface loopback <i>number</i> Example: RP/0/RP0/CPU0:router(config)# interface Loopback 0	Enters interface configuration mode.
Step 3	ipv6 address <i>prefix</i> Example: RP/0/RP0/CPU0:router(config-if)# ipv6 address 6:6:6::6/128	Configures IPv6 address on interface.
Step 4	exit Example: RP/0/RP0/CPU0:router(config-if)# exit	Exits interface configuration mode and enters global configuration mode.

	Command or Action	Purpose
Step 5	interface <i>type interface-path-id</i> Example: RP/0/RP0/CPU0:router (config) # interface GigabitEthernet 0/0/0/0	Enters interface configuration mode for the LDP protocol.
Step 6	ipv6 address <i>prefix</i> Example: RP/0/RP0/CPU0:router (config-if) # ipv6 address 16:1::6/120	Configures IPv6 address on interface.
Step 7	exit Example: RP/0/RP0/CPU0:router (config-if) # exit	Exits interface configuration mode and enters global configuration mode.
Step 8	router isis <i>process-id</i> Example: RP/0/RP0/CPU0:router (config) # router isis 100	Enables IS-IS routing for the specified routing process.
Step 9	net <i>network-entity-title</i> Example: RP/0/RP0/CPU0:router (config-isis) # net 49.0000.0000.0000.0006.00	Configures the NET on the router. The NET identifies the router for IS-IS.
Step 10	interface loopback <i>number</i> Example: RP/0/RP0/CPU0:router (config-isis) # interface Loopback 0	Enters interface configuration mode.
Step 11	address-family ipv6 unicast Example: RP/0/RP0/CPU0:router (config-isis-if) # address-family ipv6 unicast	Enters the IS-IS interface IPv6 address family configuration submode. Specifies unicast topology.
Step 12	exit Example:	Exits address family configuration submode and enters interface configuration mode.

	Command or Action	Purpose
	RP/0/RP0/CPU0:router(config-isis-if-af)# exit	
Step 13	exit Example: RP/0/RP0/CPU0:router(config-isis-if)# exit	Exits interface configuration mode.
Step 14	interface <i>type interface-path-id</i> Example: RP/0/RP0/CPU0:router(config-isis)# interface GigabitEthernet 0/0/0/0	Enters interface configuration mode for the LDP protocol.
Step 15	address-family ipv6 unicast Example: RP/0/RP0/CPU0:router(config-isis-if)# address-family ipv6 unicast	Enters the IS-IS interface IPv6 address family configuration submode. Specifies unicast topology.
Step 16	exit Example: RP/0/RP0/CPU0:router(config-isis-if-af)# exit	Exits address family configuration submode and enters interface configuration mode.
Step 17	exit Example: RP/0/RP0/CPU0:router(config-isis-if)# exit	Exits interface configuration mode.
Step 18	mpls ldp Example: RP/0/RP0/CPU0:router(config-isis)# mpls ldp	Enters MPLS LDP configuration mode.
Step 19	default-vrf implicit-ipv4 disable Example: RP/0/RP0/CPU0:router(config-ldp)# default-vrf implicit-ipv4 disable	Disables the implicitly enabled IPv4 address family for default VRF.

	Command or Action	Purpose
Step 20	router-id <i>lsr id</i> Example: RP/0/RP0/CPU0:router (config-ldp) # router-id 5.5.5.5	Configures router ID.
Step 21	address-family ipv6 Example: RP/0/RP0/CPU0:router (config-ldp) # address-family ipv6	Enables native LDP IPv6 address family.
Step 22	exit Example: RP/0/RP0/CPU0:router (config-ldp-af) # exit	Exits the current configuration mode.
Step 23	interface <i>type interface-path-id</i> Example: RP/0/RP0/CPU0:router (config-ldp) # interface GigabitEthernet 0/0/0/0	Enters interface configuration mode for the LDP protocol.
Step 24	address-family ipv6 Example: RP/0/RP0/CPU0:router (config-ldp-if) # address-family ipv6	Enables LDP IPv6 control plane.
Step 25	end or commit Example: RP/0/RP0/RP0/CPU0:router (config-ldp-if-af) # end or RP/0/RP0/RP0/CPU0:router (config-ldp-if-af) # commit	<ul style="list-style-type: none"> When you issue the end command, the system prompts you to commit changes: Uncommitted changes found, commit them before exiting (yes/no/cancel)? [cancel]: <ul style="list-style-type: none"> Entering yes saves configuration changes to the running configuration file, exits the configuration session, and returns the router to EXEC mode. Entering no exits the configuration session and returns the router to EXEC mode without committing the configuration changes.

	Command or Action	Purpose
		<ul style="list-style-type: none"> • Entering cancel leaves the router in the current configuration session without exiting or committing the configuration changes. • Use the commit command to save the configuration changes to the running configuration file and remain within the configuration session.

Example

Configuring Global Transport Address for IPv6

Perform this task to configure global transport address for IPv6 address family.

SUMMARY STEPS

1. **configure**
2. **mpls ldp**
3. **address-family ipv6**
4. **discovery transport-address** *ip-address*
5. **end** or **commit**

DETAILED STEPS

	Command or Action	Purpose
Step 1	configure Example: RP/0/RP0/CPU0:router# configure	Enters Global Configuration mode.
Step 2	mpls ldp Example: RP/0/RP0/CPU0:router(config)# mpls ldp	Enters MPLS LDP configuration mode.
Step 3	address-family ipv6 Example: RP/0/RP0/CPU0:router(config-ldp)# address-family ipv6	Enables native LDP IPv6 address family.
Step 4	discovery transport-address <i>ip-address</i> Example:	Configures the global transport address for the specified IPv6 address.

	Command or Action	Purpose
	RP/0/RP0/CPU0:router(config-ldp-af)# discovery transport-address 5:6::78	
Step 5	<p>end or commit</p> <p>Example:</p> <pre>RP/0/RP/0/RP0/CPU0:router (config-ldp-af)# end</pre> <p>or</p> <pre>RP/0/RP/0/RP0/CPU0:router (config-ldp-af)# commit</pre>	<ul style="list-style-type: none"> When you issue the end command, the system prompts you to commit changes: <pre>Uncommitted changes found, commit them before exiting (yes/no/cancel)? [cancel]:</pre> Entering yes saves configuration changes to the running configuration file, exits the configuration session, and returns the router to EXEC mode. Entering no exits the configuration session and returns the router to EXEC mode without committing the configuration changes. Entering cancel leaves the router in the current configuration session without exiting or committing the configuration changes. Use the commit command to save the configuration changes to the running configuration file and remain within the configuration session.

Disabling Implicit IPv4

Perform this task to disable the implicitly enabled IPv4 address family for default VRF.

SUMMARY STEPS

1. **configure**
2. **mpls ldp**
3. **default-vrf implicit-ipv4 disable**
4. **end** or **commit**

DETAILED STEPS

	Command or Action	Purpose
Step 1	<p>configure</p> <p>Example:</p> <pre>RP/0/RP0/CPU0:router# configure</pre>	Enters global configuration mode.
Step 2	<p>mpls ldp</p> <p>Example:</p>	Enters MPLS LDP configuration mode.

	Command or Action	Purpose
	RP/0/RP0/CPU0:router(config)# mpls ldp	
Step 3	default-vrf implicit-ipv4 disable Example: RP/0/RP0/CPU0:router(config-ldp)# default-vrf implicit-ipv4 disable	Disables the implicitly enabled IPv4 address family for default VRF.
Step 4	end or commit Example: RP/0/RP0/RP0/CPU0:router (config-ldp)# end or RP/0/RP0/RP0/CPU0:router (config-ldp)# commit	<ul style="list-style-type: none"> • When you issue the end command, the system prompts you to commit changes: Uncommitted changes found, commit them before exiting (yes/no/cancel)? [cancel]: • Entering yes saves configuration changes to the running configuration file, exits the configuration session, and returns the router to EXEC mode. • Entering no exits the configuration session and returns the router to EXEC mode without committing the configuration changes. • Entering cancel leaves the router in the current configuration session without exiting or committing the configuration changes. • Use the commit command to save the configuration changes to the running configuration file and remain within the configuration session.

Configuring IPv4 as Transport Preference

Perform this task to configure IPv4 as the preferred transport (overriding the default setting of IPv6 as preferred transport) to establish connection for a set of dual-stack peers.

SUMMARY STEPS

1. **configure**
2. **mpls ldp**
3. **neighbor dual-stack transport-connection prefer ipv4 for-peers** *peer lsr-id*
4. **end or commit**

DETAILED STEPS

	Command or Action	Purpose
Step 1	configure Example: RP/0/RP0/CPU0:router# configure	Enters global configuration mode.
Step 2	mpls ldp Example: RP/0/RP0/CPU0:router(config)# mpls ldp	Enters MPLS LDP configuration mode.
Step 3	neighbor dual-stack transport-connection prefer ipv4 for-peers peer lsr-id Example: RP/0/RP0/CPU0:router(config-ldp)# neighbor dual-stack transport-connection prefer ipv4 for-peers 5.5.5.5	Configures IPv4 as the preferred transport connection for the specified peer.
Step 4	end or commit Example: RP/0/RP0/RP0/CPU0:router (config-ldp)# end or RP/0/RP0/RP0/CPU0:router (config-ldp)# commit	<ul style="list-style-type: none"> When you issue the end command, the system prompts you to commit changes: <pre>Uncommitted changes found, commit them before exiting (yes/no/cancel)? [cancel]:</pre> Entering yes saves configuration changes to the running configuration file, exits the configuration session, and returns the router to EXEC mode. Entering no exits the configuration session and returns the router to EXEC mode without committing the configuration changes. Entering cancel leaves the router in the current configuration session without exiting or committing the configuration changes. Use the commit command to save the configuration changes to the running configuration file and remain within the configuration session.

Configuring Transport Preference Maximum Wait Time

Perform this task to configure the maximum time (in seconds) the preferred address family connection must wait to establish transport connection before resorting to non-preferred address family.

SUMMARY STEPS

1. **configure**
2. **mpls ldp**
3. **neighbor dual-stack transport-connection max-wait *seconds***
4. **end** or **commit**

DETAILED STEPS

	Command or Action	Purpose
Step 1	configure Example: RP/0/RP0/CPU0:router# configure	Enters global configuration mode.
Step 2	mpls ldp Example: RP/0/RP0/CPU0:router (config)# mpls ldp	Enters MPLS LDP configuration mode.
Step 3	neighbor dual-stack transport-connection max-wait <i>seconds</i> Example: RP/0/RP0/CPU0:router (config-ldp)# neighbor dual-stack transport-connection max-wait 5	Configures the maximum wait time.
Step 4	end or commit Example: RP/0/RP0/RP0/CPU0:router (config-ldp)# end or RP/0/RP0/RP0/CPU0:router (config-ldp)# commit	<ul style="list-style-type: none"> • When you issue the end command, the system prompts you to commit changes: Uncommitted changes found, commit them before exiting (yes/no/cancel)? [cancel]: • Entering yes saves configuration changes to the running configuration file, exits the configuration session, and returns the router to EXEC mode. • Entering no exits the configuration session and returns the router to EXEC mode without committing the configuration changes. • Entering cancel leaves the router in the current configuration session without exiting or committing the configuration changes. • Use the commit command to save the configuration changes to the running configuration file and remain within the configuration session.

Configuration Examples for Implementing MPLS LDP

These configuration examples are provided to implement LDP:

Configuring LDP with Graceful Restart: Example

The example shows how to enable LDP with graceful restart on the POS interface 0/2/0/0.

```
mpls ldp
 graceful-restart
 interface pos0/2/0/0
 !
```

Configuring LDP Discovery: Example

The example shows how to configure LDP discovery parameters.

```
mpls ldp
 router-id 192.168.70.1
 discovery hello holdtime 15
 discovery hello interval 5
 !

show mpls ldp parameters
show mpls ldp discovery
```

Configuring LDP Link: Example

The example shows how to configure LDP link parameters.

```
mpls ldp
 interface pos 0/1/0/0
 !
 !

show mpls ldp discovery
```

Related Topics

[Configuring LDP Discovery Over a Link](#), on page 33

[LDP Control Plane](#), on page 3

Configuring LDP Discovery for Targeted Hellos: Example

The examples show how to configure LDP Discovery to accept targeted hello messages.

Active (tunnel head)

```
mpls ldp
  router-id 192.168.70.1
  interface tunnel-te 12001
  !
  !
```

Passive (tunnel tail)

```
mpls ldp
  router-id 192.168.70.2
  discovery targeted-hello accept
  !
```

Related Topics

- [Configuring LDP Discovery for Active Targeted Hellos](#), on page 35
- [Configuring LDP Discovery for Passive Targeted Hellos](#), on page 37
- [LDP Control Plane](#), on page 3

Configuring Label Advertisement (Outbound Filtering): Example

The example shows how to configure LDP label advertisement control.

```
mpls ldp
  address-family ipv4
    label local advertise
      disable
      for pfx_acl_1 to peer_acl_1
      for pfx_acl_2 to peer_acl_2
      for pfx_acl_3
      interface POS 0/1/0/0
      interface POS 0/2/0/0
    !
  !

  ipv4 access-list pfx_acl_1
    10 permit ipv4 host 1.0.0.0 any
  !
  ipv4 access-list pfx_acl_2
    10 permit ipv4 host 2.0.0.0 any
  !
  ipv4 access-list peer_acl_1
    10 permit ipv4 host 1.1.1.1 any
    20 permit ipv4 host 1.1.1.2 any
  !
  ipv4 access-list peer_acl_2
    10 permit ipv4 host 2.2.2.2 any
  !
  !

  show mpls ldp binding
```

Related Topics

- [Configuring Label Advertisement Control \(Outbound Filtering\)](#), on page 39

[Label Advertisement Control \(Outbound Filtering\)](#), on page 9

Configuring LDP Neighbors: Example

The example shows how to disable label advertisement.

```
mpls ldp
  address-family ipv4
    label local advertise
      disable
  !
!
```

Related Topics

[Setting Up LDP Neighbors](#), on page 40

Configuring LDP Forwarding: Example

The example shows how to configure LDP forwarding.

```
mpls ldp
  address-family ipv4
    label local advertise explicit-null
  !

show mpls ldp forwarding
show mpls forwarding
```

Related Topics

[Setting Up LDP Forwarding](#), on page 43

[LDP Forwarding](#), on page 4

Configuring LDP Nonstop Forwarding with Graceful Restart: Example

The example shows how to configure LDP nonstop forwarding with graceful restart.

```
mpls ldp
  log
  graceful-restart
  !
  graceful-restart
  graceful-restart forwarding state-holdtime 180
  graceful-restart reconnect-timeout 15
  interface pos0/1/0/0
  !

show mpls ldp graceful-restart
show mpls ldp neighbor gr
show mpls ldp forwarding
show mpls forwarding
```

Related Topics

- [Setting Up LDP NSF Using Graceful Restart](#), on page 47
- [LDP Graceful Restart](#), on page 6
- [Phases in Graceful Restart](#), on page 7
- [Recovery with Graceful-Restart](#), on page 8

Configuring Label Acceptance (Inbound Filtering): Example

The example shows how to configure inbound label filtering.

```

mpls ldp
 label
  accept
  for pfx_acl_2 from 192.168.2.2
  !
  !
  !

mpls ldp
 address-family ipv4
  label remote accept from 192.168.1.1:0 for pfx_acl_2
  !
  !
  !

```

Related Topics

- [Configuring Label Acceptance Control \(Inbound Filtering\)](#), on page 50
- [Label Acceptance Control \(Inbound Filtering\)](#), on page 10

Configuring Local Label Allocation Control: Example

The example shows how to configure local label allocation control.

```

mpls ldp
 address-family ipv4
  label local allocate for pfx_acl_1
  !
  !

```

Related Topics

- [Configuring Local Label Allocation Control](#), on page 51
- [Local Label Allocation Control](#), on page 10

Configuring LDP Session Protection: Example

The example shows how to configure session protection.

```

mpls ldp
 session protection for peer_acl_1 duration

```

```
60
!
```

Related Topics

[Configuring Session Protection](#), on page 52

[Session Protection](#), on page 10

Configuring LDP IGP Synchronization—OSPF: Example

The example shows how to configure LDP IGP synchronization for OSPF.

```
router ospf 100
mpls ldp sync
!
mpls ldp
  igp sync delay 30
!
```

Related Topics

[Configuring LDP IGP Synchronization: OSPF](#), on page 53

[IGP Synchronization](#), on page 11

Configuring LDP IGP Synchronization—ISIS: Example

The example shows how to configure LDP IGP synchronization.

```
router isis 100
  interface POS 0/2/0/0
  address-family ipv4 unicast
  mpls ldp sync
  !
  !
  !
mpls ldp
  igp sync delay 30
!
```

Related Topics

[Configuring LDP IGP Synchronization: ISIS](#), on page 56

[IGP Synchronization](#), on page 11

Configuring LDP Auto-Configuration: Example

The example shows how to configure the IGP auto-configuration feature globally for a specific OSPF interface ID.

```
router ospf 100
mpls ldp auto-config
area 0
  interface pos 1/1/1/1
```

The example shows how to configure the IGP auto-configuration feature on a given area for a given OSPF interface ID.

```
router ospf 100
  area 0
    mpls ldp auto-config
    interface pos 1/1/1/1
```

Related Topics

[Enabling LDP Auto-Configuration for a Specified OSPF Instance](#), on page 59

[Enabling LDP Auto-Configuration in an Area for a Specified OSPF Instance](#), on page 60

[Disabling LDP Auto-Configuration](#), on page 61

[IGP Auto-configuration](#), on page 12

Configure IP LDP Fast Reroute Loop Free Alternate: Examples

This example shows how to configure LFA FRR with default tie-break configuration:

```
router isis TEST
  net 49.0001.0000.0000.0001.00
  address-family ipv4 unicast
  metric-style wide

  interface GigabitEthernet0/6/0/13
    point-to-point
    address-family ipv4 unicast
    fast-reroute per-prefix
    # primary path GigabitEthernet0/6/0/13 will exclude the interface
    # GigabitEthernet0/6/0/33 in LFA backup path computation.
    fast-reroute per-prefix exclude interface GigabitEthernet0/6/0/33
  !
  interface GigabitEthernet0/6/0/23
    point-to-point
    address-family ipv4 unicast
  !
  interface GigabitEthernet0/6/0/24
    point-to-point
    address-family ipv4 unicast
  !
  interface GigabitEthernet0/6/0/33
    point-to-point
    address-family ipv4 unicast
  !
```

This example shows how to configure TE tunnel as LFA backup:

```
router isis TEST
  net 49.0001.0000.0000.0001.00
  address-family ipv4 unicast
  metric-style wide
```

```

interface GigabitEthernet0/6/0/13
  point-to-point
  address-family ipv4 unicast
  fast-reroute per-prefix
  # primary path GigabitEthernet0/6/0/13 will exclude the interface
  # GigabitEthernet0/6/0/33 in LFA backup path computation. TE tunnel 1001
  # is using the link GigabitEthernet0/6/0/33.
  fast-reroute per-prefix exclude interface GigabitEthernet0/6/0/33
  fast-reroute per-prefix lfa-candidate interface tunnel-te1001
!
interface GigabitEthernet0/6/0/33
  point-to-point
  address-family ipv4 unicast
!

```

This example shows how to configure LFA FRR with configurable tie-break configuration:

```

router isis TEST
  net 49.0001.0000.0000.0001.00
  address-family ipv4 unicast
  metric-style wide
  fast-reroute per-prefix tiebreaker ?
  downstream          Prefer backup path via downstream node
  lc-disjoint          Prefer line card disjoint backup path
  lowest-backup-metric Prefer backup path with lowest total metric
  node-protecting     Prefer node protecting backup path
  primary-path        Prefer backup path from ECMP set
  secondary-path      Prefer non-ECMP backup path

  fast-reroute per-prefix tiebreaker lc-disjoint index ?
  <1-255> Index
  fast-reroute per-prefix tiebreaker lc-disjoint index 10

```

Sample configuration:

```

router isis TEST
  net 49.0001.0000.0000.0001.00
  address-family ipv4 unicast
  metric-style wide
  fast-reroute per-prefix tiebreaker downstream index 60
  fast-reroute per-prefix tiebreaker lc-disjoint index 10
  fast-reroute per-prefix tiebreaker lowest-backup-metric index 40
  fast-reroute per-prefix tiebreaker node-protecting index 30
  fast-reroute per-prefix tiebreaker primary-path index 20
  fast-reroute per-prefix tiebreaker secondary-path index 50
!
interface GigabitEthernet0/6/0/13
  point-to-point
  address-family ipv4 unicast
  fast-reroute per-prefix
!
interface GigabitEthernet0/1/0/13
  point-to-point
  address-family ipv4 unicast
  fast-reroute per-prefix
!
interface GigabitEthernet0/3/0/0.1
  point-to-point
  address-family ipv4 unicast
!
interface GigabitEthernet0/3/0/0.2
  point-to-point
  address-family ipv4 unicast

```

Related Topics

[IP LDP Fast Reroute Loop Free Alternate](#), on page 13

Verify IP LDP Fast Reroute Loop Free Alternate: Example

The following examples show how to verify the IP LDP FRR LFA feature on the router.

The following example shows how to verify ISIS FRR output:

```
RP/0/RP0/CPU0:router#show isis fast-reroute summary
IS-IS 1 IPv4 Unicast FRR summary
```

	Critical Priority	High Priority	Medium Priority	Low Priority	Total
Prefixes reachable in L1					
All paths protected	0	0	4	1008	1012
Some paths protected	0	0	0	0	0
Unprotected	0	0	0	0	0
Protection coverage	0.00%	0.00%	100.00%	100.00%	100.00%
Prefixes reachable in L2					
All paths protected	0	0	1	0	1
Some paths protected	0	0	0	0	0
Unprotected	0	0	0	0	0
Protection coverage	0.00%	0.00%	100.00%	0.00%	100.00%

The following example shows how to verify the IGP route 211.1.1.1/24 in ISIS Fast Reroute output:

```
RP/0/RP0/CPU0:router#show isis fast-reroute 211.1.1.1/24
L1 211.1.1.1/24 [40/115]
  via 12.0.0.2, GigabitEthernet0/6/0/13, NORTH
  FRR backup via 14.0.2.2, GigabitEthernet0/6/0/0.3, SOUTH

RP/0/RP0/CPU0:router#show isis fast-reroute 211.1.1.1/24 detail
L1 211.1.1.1/24 [40/115] low priority
  via 12.0.0.2, GigabitEthernet0/6/0/13, NORTH
  FRR backup via 14.0.2.2, GigabitEthernet0/6/0/0.3, SOUTH
  P: No, TM: 130, LC: No, NP: Yes, D: Yes
  src srl.00-00, 173.1.1.2
  L2 adv [40] native, propagated
```

The following example shows how to verify the IGP route 211.1.1.1/24 in RIB output:

```
RP/0/RP0/CPU0:router#show route 211.1.1.1/24
Routing entry for 211.1.1.0/24
  Known via "isis 1", distance 115, metric 40, type level-1
  Installed Nov 27 10:22:20.311 for 1d08h
  Routing Descriptor Blocks
    12.0.0.2, from 173.1.1.2, via GigabitEthernet0/6/0/13, Protected
    Route metric is 40
    14.0.2.2, from 173.1.1.2, via GigabitEthernet0/6/0/0.3, Backup
    Route metric is 0
```

No advertising protos.

The following example shows how to verify the IGP route 211.1.1.1/24 in FIB output:

```
RP/0/RP0/CPU0:router#show cef 211.1.1.1/24
211.1.1.0/24, version 0, internal 0x40040001 (ptr 0x9d9e1a68) [1], 0x0 \
(0x9ce0ec40), 0x4500 (0x9e2c69e4)
Updated Nov 27 10:22:29.825
remote adjacency to GigabitEthernet0/6/0/13
Prefix Len 24, traffic index 0, precedence routine (0) \
via 12.0.0.2, GigabitEthernet0/6/0/13, 0 dependencies, weight 0, class 0, \
protected [flags 0x400]
  path-idx 0, bkup-idx 1 [0x9e5b71b4 0x0]
  next hop 12.0.0.2
    local label 16080      labels imposed {16082}
  via 14.0.2.2, GigabitEthernet0/6/0/0.3, 3 dependencies, weight 0, class 0, \
backup [flags 0x300]
  path-idx 1
  next hop 14.0.2.2
  remote adjacency
    local label 16080      labels imposed {16079}

RP/0/RP0/CPU0:router#show cef 211.1.1.1/24 detail
211.1.1.0/24, version 0, internal 0x40040001 (ptr 0x9d9e1a68) [1], 0x0 \
(0x9ce0ec40), 0x4500 (0x9e2c69e4)
Updated Nov 27 10:22:29.825
remote adjacency to GigabitEthernet0/6/0/13
Prefix Len 24, traffic index 0, precedence routine (0) \
gateway array (0x9cc622f0) reference count 1158, flags 0x28000d00, source lsd \
(2),
      [387 type 5 flags 0x101001 (0x9df32398) ext 0x0 (0x0)]
LW-LDI[type=5, refc=3, ptr=0x9ce0ec40, sh-ldi=0x9df32398]
via 12.0.0.2, GigabitEthernet0/6/0/13, 0 dependencies, weight 0, class 0, \
protected [flags 0x400]
  path-idx 0, bkup-idx 1 [0x9e5b71b4 0x0]
  next hop 12.0.0.2
    local label 16080      labels imposed {16082}
  via 14.0.2.2, GigabitEthernet0/6/0/0.3, 3 dependencies, weight 0, class 0, \
backup [flags 0x300]
  path-idx 1
  next hop 14.0.2.2
  remote adjacency
    local label 16080      labels imposed {16079}

Load distribution: 0 (refcount 387)

Hash OK Interface Address
0 Y GigabitEthernet0/6/0/13 remote
```

The following example shows how to verify the IGP route 211.1.1.1/24 in MPLS LDP output:

```
RP/0/RP0/CPU0:router#show mpls ldp forwarding 211.1.1.1/24
```

Prefix	Label In	Label Out	Outgoing Interface	Next Hop	GR Stale
211.1.1.0/24	16080	16082	Gi0/6/0/13	12.0.0.2	Y N

```
16079      Gi0/6/0/0.3  14.0.2.2 (!)      Y  N
```

```
RP/0/RP0/CPU0:router#show mpls ldp forwarding 211.1.1.1/24 detail
```

Prefix	Label In	Label Out	Outgoing Interface	Next Hop	GR Stale
211.1.1.0/24	16080	16082	Gi0/6/0/13	12.0.0.2	Y N
			[Protected; path-id 1 backup-path-id 33; peer 20.20.20.20:0]		
		16079	Gi0/6/0/0.3	14.0.2.2 (!)	Y N
			[Backup; path-id 33; peer 40.40.40.40:0]		
Routing update : Nov 27 10:22:19.560 (1d08h ago)					
Forwarding update: Nov 27 10:22:29.060 (1d08h ago)					

Related Topics

[IP LDP Fast Reroute Loop Free Alternate](#), on page 13

MPLS LDP CSC for Multiple VRFs Configuration: Examples

This figure shows a L3VPN LDP CSC topology that uses either BGP or LDP between PE and CE routers to distribute routes and MPLS labels.

L3VPN CSC VPN: LDP / BGP

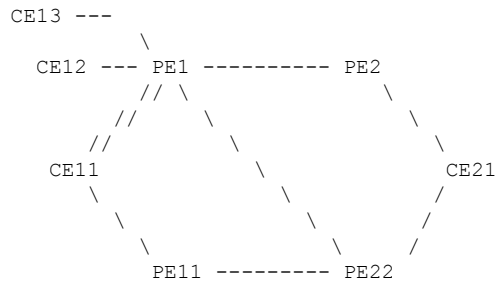

VRF red: CE11, CE21

VRF blue: CE12, CE13 (local only switching)

Multi-home CEs: CE11, CE21

LDP CSC: PE1/PE11 with CE1x

BGP CSC: PE2/PE22 with CE2x

CSC-CE11 Configuration

```
hostname cell1

interface Loopback0
  ipv4 address 11.11.11.11 255.255.255.255
!
interface POS0/2/0/0
  ipv4 address 192.168.1.11 255.255.255.0
```

```

!
interface POS0/2/0/1
  ipv4 address 192.168.2.11 255.255.255.0
!
interface POS0/2/0/2
  ipv4 address 192.168.3.11 255.255.255.0
!
router ospf 100
  log adjacency changes
  router-id 11.11.11.11
  area 0
    interface Loopback0
    !
    interface POS0/2/0/0
    !
    interface POS0/2/0/1
    !
    interface POS0/2/0/2
    !
  !
!
mpls ldp
  log
  adjacency
  neighbor
!
  router-id 11.11.11.11
  address-family ipv4
  !
  interface POS0/2/0/0
    address-family ipv4
  !
  !
  interface POS0/2/0/1
    address-family ipv4
  !
  !
  interface POS0/2/0/2
    address-family ipv4
  !
  !
!
no interface POS0/2/0/0 shut
no interface POS0/2/0/1 shut
no interface POS0/2/0/2 shut
end

```

CSC-CE12 Configuration

```

hostname ce12

interface Loopback0
  ipv4 address 11.11.11.12 255.255.255.255
!
interface POS0/2/0/0
  ipv4 address 192.169.1.12 255.255.255.0
!
router ospf 100
  log adjacency changes
  router-id 11.11.11.12
  area 0
    interface Loopback0

```

```

!
interface POS0/2/0/0
!
!
!
mpls ldp
log
adjacency
neighbor
!
router-id 11.11.11.12
address-family ipv4
!
interface POS0/2/0/0
address-family ipv4
!
!
!
no interface POS0/2/0/0 shut
end

```

CSC-CE13 Configuration

```

hostname ce13

interface Loopback0
ipv4 address 11.11.11.11 255.255.255.255
!
interface POS0/2/0/0
ipv4 address 192.170.1.12 255.255.255.0
!
router ospf 100
log adjacency changes
router-id 11.11.11.11
area 0
interface Loopback0
!
interface POS0/2/0/0
!
!
!
mpls ldp
log
adjacency
neighbor
!
router-id 11.11.11.11
address-family ipv4
!
interface POS0/2/0/0
address-family ipv4
!
!
!
no interface POS0/2/0/0 shut
end

```

CSC-CE21 Configuration

```

hostname ce21

interface Loopback0
  ipv4 address 21.21.21.21 255.255.255.255
  !
interface POS0/2/0/0
  ipv4 address 193.168.1.21 255.255.255.0
  !
interface POS0/2/0/1
  ipv4 address 193.169.1.21 255.255.255.0
  !
route-policy pass-all
  pass
end-policy
!
router static
  address-family ipv4 unicast
    193.168.1.2/32 POS0/2/0/0
    193.169.1.2/32 POS0/2/0/1
  !
  address-family ipv6 unicast
    1::1::1/128 POS0/2/0/0
  !
!
router bgp 2
  bgp router-id 21.21.21.21
  address-family ipv4 unicast
    redistribute connected
    allocate-label all
  !
  neighbor 193.168.1.2
    remote-as 100
    address-family ipv4 labeled-unicast
      route-policy pass-all in
      route-policy pass-all out
  !
!
  neighbor 193.169.1.22
    remote-as 100
    address-family ipv4 labeled-unicast
      route-policy pass-all in
      route-policy pass-all out
  !
!
no interface POS0/2/0/0 shut
no interface POS0/2/0/1 shut
end

```

CSC-PE1 Configuration

```

hostname pe1

vrf red
  address-family ipv4 unicast
    import route-target
      100:1
    !
    export route-target
      100:1
    !
  !
!

```

```

!
vrf blue
  address-family ipv4 unicast
  !
!
interface Loopback0
  ipv4 address 1.1.1.1 255.255.255.255
  ipv6 address 1::1/128
!
interface Loopback1
  vrf red
  ipv4 address 1.1.1.1 255.255.255.255
!
interface Loopback2
  vrf blue
  ipv4 address 1.1.1.1 255.255.255.255
!
interface Loopback11
  ipv4 address 1.1.1.2 255.255.255.255
  ipv6 address 1::2/128
!
interface Loopback112
  vrf blue
  ipv4 address 1.1.1.112 255.255.255.255
!
interface POS0/2/0/0
  vrf red
  ipv4 address 192.168.1.1 255.255.255.0
!
interface POS0/2/0/1
  vrf red
  ipv4 address 192.168.2.1 255.255.255.0
!
interface POS0/2/0/2
  vrf blue
  ipv4 address 192.169.1.1 255.255.255.0
!
interface POS0/2/0/3
  vrf blue
  ipv4 address 192.170.1.1 255.255.255.0
!
interface POS0/2/0/4
  ipv4 address 12.1.0.1 255.255.255.0
  ipv6 address 12::1/120
!
interface POS0/2/0/5
  ipv4 address 122.1.0.1 255.255.255.0
!
router static
  address-family ipv6 unicast
  2:2:2::2/128 POS0/2/0/4
  !
!
router ospf 100
  log adjacency changes
  router-id 1.1.1.1
  area 0
    interface Loopback0
    !
    interface POS0/2/0/4
    !
    interface POS0/2/0/5
    !
  !
!

```

```
vrf red
  router-id 1.1.1.1
  redistribute bgp 100
  area 0
    interface Loopback1
    !
    interface POS0/2/0/0
    !
    interface POS0/2/0/1
    !
    !
  !
vrf blue
  router-id 1.1.1.1
  area 0
    interface Loopback2
    !
    interface POS0/2/0/2
    !
    interface POS0/2/0/3
    !
    !
  !
!
router bgp 100
  address-family ipv4 unicast
  !
  address-family vpnv4 unicast
  !
  neighbor 2.2.2.2
    remote-as 100
    update-source Loopback0
    address-family vpnv4 unicast
  !
  !
  neighbor 2.2.2.22
    remote-as 100
    update-source Loopback0
    address-family vpnv4 unicast
  !
  !
vrf red
  rd 1:1
  address-family ipv4 unicast
    maximum-paths eibgp 8
  redistribute ospf 100
  !
  !
!
mpls ldp
  log
  adjacency
  neighbor
  !
  nsr
  router-id 1.1.1.1
  address-family ipv4
    label
    local
    advertise
    explicit-null
  !
  !
  !
```

```

!
interface POS0/2/0/4
 address-family ipv4
!
!
interface POS0/2/0/5
 address-family ipv4
!
!
vrf red
 address-family ipv4
!
 interface POS0/2/0/0
  address-family ipv4
!
!
 interface POS0/2/0/1
  address-family ipv4
!
!
vrf blue
 router-id 1.1.1.2
 address-family ipv4
  discovery transport-address 1.1.1.1
  label
   local
    allocate for host-routes
!
!
!
 interface POS0/2/0/2
  address-family ipv4
!
!
 interface POS0/2/0/3
  address-family ipv4
!
!
!
no interface POS0/2/0/0 shut
no interface POS0/2/0/1 shut
no interface POS0/2/0/2 shut
no interface POS0/2/0/3 shut
no interface POS0/2/0/4 shut
no interface POS0/2/0/5 shut
end

```

CSC-PE2 Configuration

```

hostname pe2

vrf red
 address-family ipv4 unicast
  import route-target
   100:1
!
 export route-target
  100:1
!
!
```



```
!  
interface Loopback0  
  ipv4 address 2.2.2.2 255.255.255.255  
  ipv6 address 2:2:2::2/128  
!  
interface Loopback1  
  vrf red  
  ipv4 address 2.2.2.2 255.255.255.255  
!  
interface POS0/2/0/0  
  ipv4 address 12.1.0.2 255.255.255.0  
  ipv6 address 12:1::2/120  
!  
interface POS0/2/0/1  
  vrf red  
  ipv4 address 193.168.1.2 255.255.255.0  
!  
route-policy pass-all  
  pass  
end-policy  
!  
router static  
  address-family ipv6 unicast  
    1:1:1::1/128 POS0/2/0/0  
    1:1:1::2/128 POS0/2/0/0  
  !  
  vrf red  
    address-family ipv4 unicast  
      193.168.1.21/32 POS0/2/0/1  
  !  
!  
router ospf 100  
  log adjacency changes  
  router-id 2.2.2.2  
  area 0  
    interface Loopback0  
    !  
    interface POS0/2/0/0  
    !  
  !  
!  
router bgp 100  
  address-family ipv4 unicast  
  !  
  address-family vpnv4 unicast  
  !  
  neighbor 1.1.1.1  
    remote-as 100  
    update-source Loopback0  
    address-family vpnv4 unicast  
  !  
!  
vrf red  
  rd 1:1  
  address-family ipv4 unicast  
    allocate-label all  
  !  
  neighbor 193.168.1.21  
    remote-as 2  
    address-family ipv4 labeled-unicast  
    route-policy pass-all in  
    route-policy pass-all out  
  !
```

```

!
!
!
mpls ldp
log
  adjacency
  neighbor
!
router-id 2.2.2.2
address-family ipv4
  label
    local
      advertise
      explicit-null
    !
  !
!
!
interface POS0/2/0/0
  address-family ipv4
!
!
no interface POS0/2/0/0 shut
no interface POS0/2/0/1 shut
end

```

CSC-PE11 Configuration

```

hostname pe11

vrf red
  address-family ipv4 unicast
  import route-target
    100:1
  !
  export route-target
    100:1
  !
!
!
interface Loopback0
  ipv4 address 1.1.1.11 255.255.255.255
!
interface Loopback1
  vrf red
  ipv4 address 1.1.1.11 255.255.255.255
!
interface POS0/2/0/0
  vrf red
  ipv4 address 192.168.3.1 255.255.255.0
!
interface POS0/2/0/1
  ipv4 address 112.1.0.1 255.255.255.0
!
router ospf 100
log adjacency changes
router-id 1.1.1.11
area 0
  interface Loopback0
  !
  interface POS0/2/0/1

```

```

!
!
vrf red
  router-id 1.1.1.11
  redistribute bgp 100
  area 0
    interface Loopback1
    !
    interface POS0/2/0/0
    !
  !
!
router bgp 100
  address-family ipv4 unicast
  !
  address-family vpnv4 unicast
  !
  neighbor 2.2.2.22
  remote-as 100
  update-source Loopback0
  address-family vpnv4 unicast
  !
!
vrf red
  rd 1:1
  address-family ipv4 unicast
  maximum-paths eibgp 8
  redistribute ospf 100
  !
!
mpls ldp
  log
  adjacency
  neighbor
  !
  router-id 1.1.1.11
  address-family ipv4
  !
  interface POS0/2/0/1
  address-family ipv4
  !
!
vrf red
  address-family ipv4
  !
  interface POS0/2/0/0
  address-family ipv4
  !
!
!
no interface POS0/2/0/0 shut
no interface POS0/2/0/1 shut
end

```

CSC-PE22 Configuration

```

hostname pe22

vrf red

```

```

address-family ipv4 unicast
import route-target
 100:1
!
export route-target
 100:1
!
!
!
interface Loopback0
ipv4 address 2.2.2.22 255.255.255.255
!
interface Loopback1
vrf red
ipv4 address 2.2.2.22 255.255.255.255
!
interface POS0/2/0/0
ipv4 address 122.1.0.22 255.255.255.0
!
interface POS0/2/0/1
vrf red
ipv4 address 193.169.1.22 255.255.255.0
!
interface POS0/2/0/2
ipv4 address 112.1.0.22 255.255.255.0
!
route-policy pass-all
pass
end-policy
!
router static
vrf red
address-family ipv4 unicast
 193.169.1.21/32 POS0/2/0/1
!
!
!
router ospf 100
log adjacency changes
router-id 2.2.2.22
area 0
interface Loopback0
!
interface POS0/2/0/0
!
interface POS0/2/0/2
!
!
!
router bgp 100
address-family ipv4 unicast
!
address-family vpnv4 unicast
!
neighbor 1.1.1.1
remote-as 100
update-source Loopback0
address-family vpnv4 unicast
!
!
neighbor 1.1.1.11
remote-as 100
update-source Loopback0
address-family vpnv4 unicast

```

```

!
!
vrf red
 rd 1:1
  address-family ipv4 unicast
   allocate-label all
  !
  neighbor 193.169.1.21
   remote-as 2
   address-family ipv4 labeled-unicast
    route-policy pass-all in
    route-policy pass-all out
  !
!
!
!
mpls ldp
 router-id 2.2.2.22
 address-family ipv4
 !
 interface POS0/2/0/0
  address-family ipv4
  !
 !
 interface POS0/2/0/2
  address-family ipv4
  !
 !
!
no interface POS0/2/0/0 shut
no interface POS0/2/0/1 shut
no interface POS0/2/0/2 shut
end

```

The following example shows the output for the **show running-config mpls ldp** command.

```
RP/0/RSP0/CPU0:router# show running-config mpls ldp
```

```

mpls ldp
 log
  adjacency
  neighbor
  nsr
  graceful-restart
  session-protection
 !
 nsr
 graceful-restart
 graceful-restart reconnect-timeout 60
 graceful-restart forwarding-state-holdtime 180
 igp sync delay on-proc-restart 300
 igp sync delay on-session-up 15
 discovery
  quick-start disable
  instance-tlv disable
  hello holdtime 30
  hello interval 10
  targeted-hello holdtime 180
  targeted-hello interval 20
 !
 session backoff 5 15
 session holdtime 300

```

```

signalling dscp 48
mldp
 logging notifications
 address-family ipv4
   static p2mp 1.1.1.1 1
   static mp2mp 10.10.10.10 1
   make-before-break delay 10
   mofrr
   recursive-fec
!
!
router-id 1.1.1.1
neighbor
 password encrypted 01100F17580454
 2.2.2.2:0 password disable
 3.3.3.3:0 password encrypted 02050D480809
!
session downstream-on-demand with peer_acl1
session protection for peer_acl2 duration 30
address-family ipv4
 discovery targeted-hello accept from peer_acl1
 neighbor 2.2.2.2 targeted
 traffic-eng
   auto-tunnel mesh
     group all
     group 10
     group 20
!
!
redistribute
 bgp
   as 100
   advertise-to peer_acl1
!
!
label
 local
 default-route
 implicit-null-override for pfx_acl1
 allocate for pfx_acl
 advertise
   disable
   for pfx_acl1 to peer_acl1
   for pfx_acl2 to peer_acl2
 interface GigabitEthernet0/0/0/0
   explicit-null for pfx_acl1 to peer_acl1
!
!
remote
 accept
   from 2.2.2.2:0 for pfx_acl2
   from 3.3.3.3:0 for pfx_acl3
!
!
!
interface GigabitEthernet0/0/0/0
 igp sync delay on-session-up disable
 discovery quick-start disable
 discovery hello holdtime 30
 discovery hello interval 10
 address-family ipv4
   igp auto-config disable
   discovery transport-address interface

```

```

    mldp disable
    !
    !
interface GigabitEthernet0/0/0/1
    igp sync delay on-session-up 10
    address-family ipv4
        discovery transport-address 1.1.1.1
    !
    !
interface GigabitEthernet0/0/0/2
    !
    !
!

```

LDP IPv6 Configuration: Examples

The following example shows how to enable LDP IPv6 native under LDP. The user must enable IPv6 address family under LDP submodes.

```

configure
    mpls ldp
        address-family ipv6
    !
    !

```

The following example shows how to enable LDP IPv6 control plane on an LDP interface:

```

configure
    mpls ldp
        interface pos 0/6/0/0
            address-family ipv6
        !
    !

```

The following examples shows how to configure IPv6-only LSR:



Note IPv4 is implicitly enabled under default VRF and any LDP interfaces under default VRF. In order to operate as an IPv6-only LSR, the user must also explicitly disable IPv4 address family.

Example 1:



Note In this example, there is no explicit IPv6 export address. The loopback's IPv6 address is used as the export address (6:6:6::6/128).

The router ID configured in MPLS LDP is not used in anyway for export. It is used only for LDP LSR identification.

```

configure
interface Loopback0
    ipv6 address 6:6:6::6/128
!

```

```

interface GigabitEthernet0/0/0/0
  ipv6 address 16:1::6/120
  !
router isis 100
  net 49.0000.0000.0000.0006.00
  interface Loopback0
    address-family ipv6 unicast
    !
  !
  interface GigabitEthernet0/0/0/0
    address-family ipv6 unicast
    !
  !
mpls ldp
  default-vrf implicit-ipv4 disable
  router-id 6.6.6.6
  address-family ipv6
  !
  interface GigabitEthernet0/0/0/0
    address-family ipv6
  !
  !

```

Example 2:

Note In this example, there is an explicit IPv6 export address. However, there is no IPv6 loopback. There is no router-id configured, but the loopback IPv4 address is used.

```

configure
interface Loopback0
  ipv4 address 6.6.6.6/32
  !
interface GigabitEthernet0/0/0/0
  ipv6 address 16:1::6/120
  !
router isis 100
  net 49.0000.0000.0000.0006.00
  interface Loopback0
    address-family ipv6 unicast
    !
  !
  interface GigabitEthernet0/0/0/0
    address-family ipv6 unicast
    !
  !
mpls ldp
  default-vrf implicit-ipv4 disable
  address-family ipv6
  discovery transport-address 6:6:6::6
  !
  interface GigabitEthernet0/0/0/0
    address-family ipv6
  !
  !

```

Additional References

For additional information related to Implementing MPLS Label Distribution Protocol, refer to the following references:

Related Documents

Related Topic	Document Title
LDP Commands	<i>MPLS Label Distribution Protocol Commands</i> module in <i>MPLS Command Reference for the Cisco CRS Router</i> .

Standards

Standards	Title
No new or modified standards are supported by this feature, and support for existing standards has not been modified by this feature.	—

MIBs

MIBs	MIBs Link
—	To locate and download MIBs using Cisco IOS XR software, use the Cisco MIB Locator found at the following URL and choose a platform under the Cisco Access Products menu: http://cisco.com/public/sw-center/netmgmt/cmtk/mibs.shtml

RFCs

RFCs	Title
Note Not all supported RFCs are listed.	
RFC 3031	<i>Multiprotocol Label Switching Architecture</i>
RFC 3036	<i>LDP Specification</i>
RFC 3037	<i>LDP Applicability</i>
RFC 3478	<i>Graceful Restart Mechanism for Label Distribution Protocol</i>
RFC 3815	<i>Definitions of Managed Objects for MPLS LDP</i>
RFC 5036	<i>Label Distribution and Management Downstream on Demand Label Advertisement</i>
RFC 5286	<i>Basic Specification for IP Fast Reroute: Loop-Free Alternates</i>

Technical Assistance

Description	Link
The Cisco Technical Support website contains thousands of pages of searchable technical content, including links to products, technologies, solutions, technical tips, and tools. Registered Cisco.com users can log in from this page to access even more content.	http://www.cisco.com/techsupport