



Cisco Outdoor Omnidirectional Antenna for 2G/3G/4G Cellular (ANT-4G-OMNI-OUT-N)

The Cisco Outdoor Omnidirectional Antenna for 2G/3G/4G Cellular antenna is designed to cover domestic LTE700/Cellular/PCS/AWS/MDS, WiMAX 2300/2500, and GSM900/GSM1800/UMTS/LTE2600 bands. The Omnidirectional Outdoor Antenna is compatible with Cisco 2G, 3G, and 4G cellular devices that use a Type N connector and requires a mast-mounted outdoor antenna. This document provides the antenna specifications and mounting instructions.

CAUTION: Read the information in [Safety Warnings](#) before installing or replacing antennas.

This chapter covers the following topics:

- [Technical Specifications](#)
- [Antenna Kit](#)
- [Safety Warnings](#)
- [Antenna Installation](#)
- [Obtaining Documentation and Submitting a Service Request](#)

Technical Specifications

The Outdoor Omnidirectional Stick antenna features the following:

- UV stable radome
- Mastmounting bracket
- Applicable for both 2G and 3G solutions
- Domestic LTE 700 band and Global LTE 2600 band
- Domestic cellular and global GSM
- WiMAX 2300/2500

Figure 1 Outdoor Omnidirectional Antenna

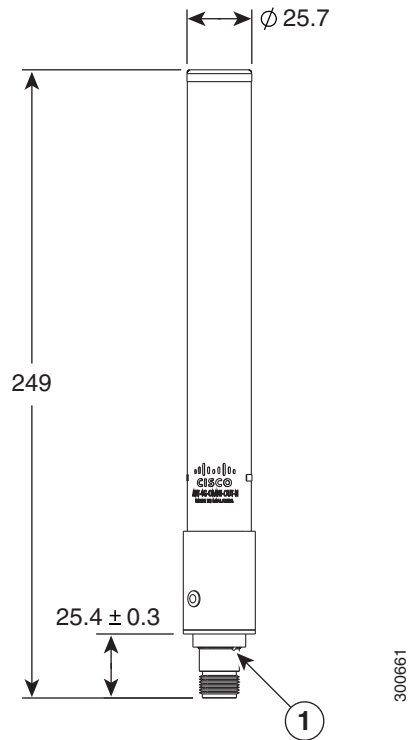

1	2x drain slot		
---	---------------	--	--

RF Specifications

Specification	Description
Frequency ranges	<ul style="list-style-type: none"> ■ 698 to 960 MHz ■ 1710 to 2170 MHz ■ 2300 to 2700 MHz
Nominal gain (dBi)	<ul style="list-style-type: none"> ■ 698 to 960 MHz—1.5 dBi ■ 1448-1511MHz—2dBi ■ 1710 to 2700 MHz—3.5 dBi
3 dB beamwidth (E plane)	<ul style="list-style-type: none"> ■ 698 to 960 MHz—81 degrees ■ 1710 to 2170 MHz—75 degrees ■ 2300 to 2700 MHz—100 degrees
3 dB beamwidth (H plane)	360 degrees, omnidirectional
Efficiency	Antennas were designed and tested to high RF efficiency in all supported cellular bands. Detailed technical specifications can be obtained through your Cisco authorized partner or Cisco account representative.

Specification	Description
Polarization	Vertical, linear
Normal impedance	50 ohms
VSWR	<ul style="list-style-type: none"> ■ < 2.5:1 (698 to 960 MHz) ■ < 1.5:1 (1448 to 1511 MHz) ■ < 2.0:1 (1710 to 2690 MHz)
Radiation Pattern	Omnidirectional

Mechanical Specifications

Specification	Description
Mount style	Mast mount, upright position only, connector on bottom (due to drain holes located only on antenna bottom)
Environment	Outdoor IP55 with drain holes
Connector	N-Type female
Antenna length (height)	9.8" x 1" (24.9 cm x 2.45 cm)
Weight	1.5 lbs (.68 kg)
Dimensions (height x outside dimensions)	9.8" x 1" (24.8 x 24.5 mm)
Operating temperature range	-22 to 158-degrees F (-30 to +70-degrees C)
Storage temperature	-40 to 185 degrees F (-40 to 85 degrees C)
Maximum power	20 watts
Radome	Polycarbonate, UV, white
Material substance compliance	ROHS compliant

The Outdoor Omnidirectional Antenna has a Azimuth radiation pattern:

Figure 2 Outdoor Omnidirectional Antenna Radiation Patterns (1 of 2)

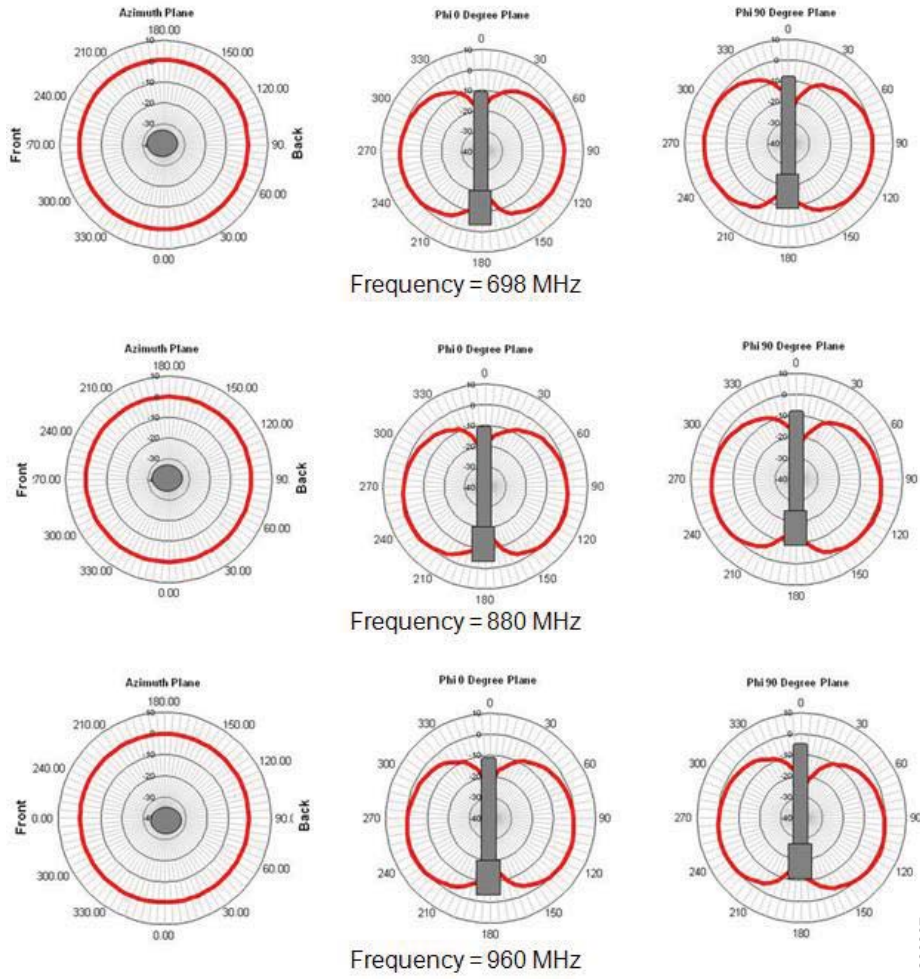
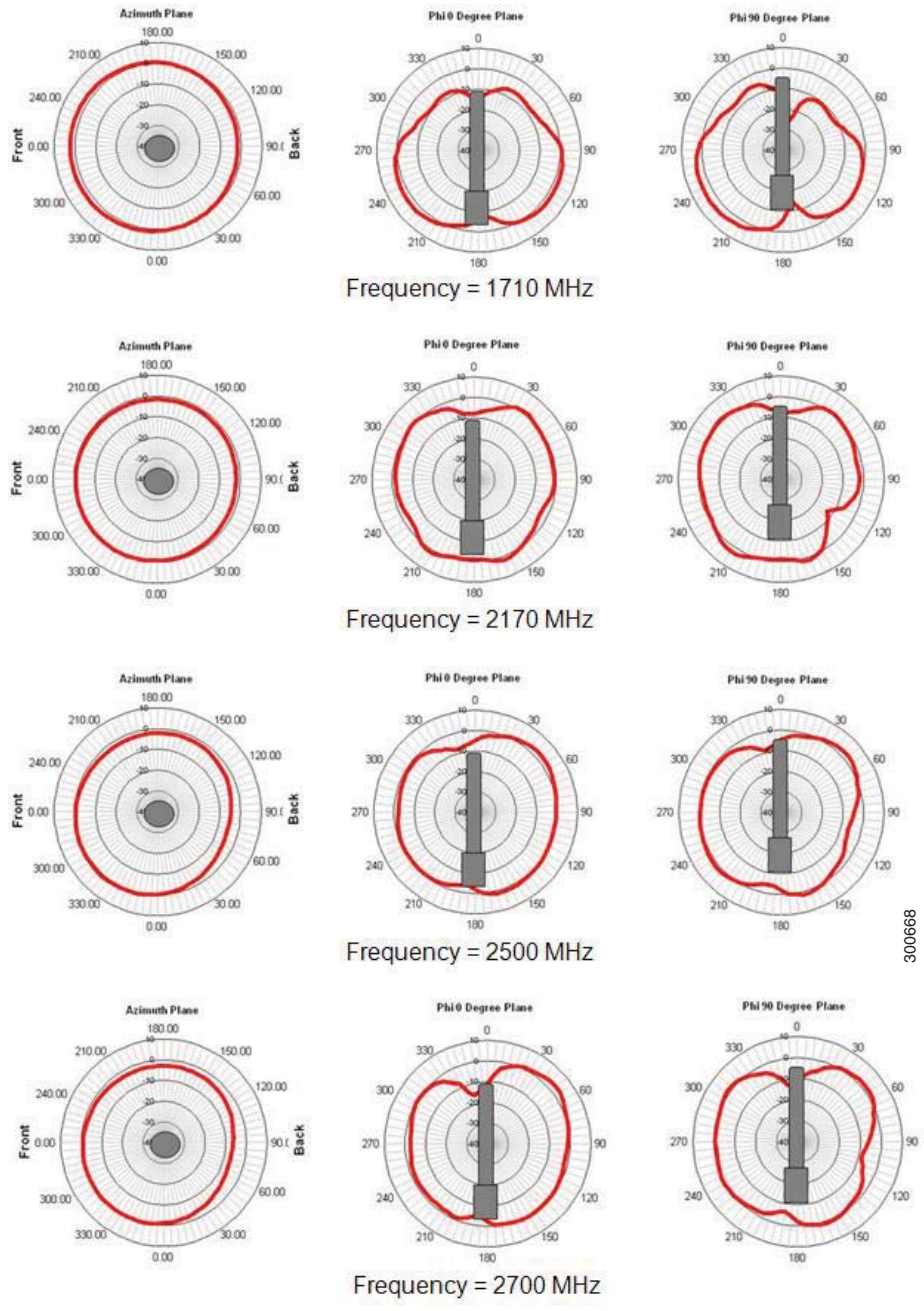

Figure 3 Outdoor Omnidirectional Antenna Radiation Patterns (2 of 2)



300668

300669

Antenna Kit

The contents of the multi-purpose integrated antenna are listed in [Table 1](#):

Table 1 **Antenna Kit Contents**

Quantity	Description
1	Antenna-mount bracket
4	1/4"-20x3/4 carriage bolt
6	1/4"-20 hex nut
6	1/4"-20 spring lock washer
6	1/4"-20 flat washer
2	Pipe clamps
1	ANT-4G-OMNI-OUT-N Antenna

Safety Warnings

WARNING: Avoid using or servicing any equipment that has outdoor connections during an electrical storm. There may be a risk of electric shock from lightning. Statement 1088

WARNING: Do not work on the system, or connect or disconnect cables, during periods of lightning activity. Statement 1001

WARNING: Do not locate the outdoor antenna near overhead power lines or other electric light or power circuits, or where it can come into contact with such circuits. When installing the antenna, take extreme care not to come into contact with such circuits, as they may cause serious injury or death. For proper installation and grounding of the antenna, please refer to national and local codes (for example, U.S.:NFPA 70, National Electrical Code, Article 810, Canada:Canadian Electrical Code, Section 54). Statement 1052

WARNING: This equipment must be grounded. Never defeat the ground conductor or operate the equipment in the absence of a suitably installed ground conductor. Contact the appropriate electrical inspection authority or an electrician if you are uncertain that suitable grounding is available. Statement 1024

WARNING: Only trained and qualified personnel should be allowed to install, replace, or service this equipment. Statement 1030

WARNING: To report a gas leak, do not use a telephone in the vicinity of the leak. Statement 1039

WARNING: This warning symbol means danger. You are in a situation that could cause bodily injury. Before you work on any equipment, be aware of the hazards involved with electrical circuitry and be familiar with standard practices for preventing accidents. Use the statement number provided at the end of each warning to locate its translation in the translated safety warnings that accompanied this device. Statement 1071. **SAVE THESE INSTRUCTIONS.**

WARNING: This product is not intended to be directly connected to the Cable Distribution System. Additional regulatory compliance and legal requirements may apply for direct connection to the Cable Distribution System. This product may connect to the Cable Distribution System ONLY through a device that is approved for direct connection. Statement 1078

Safety Precautions

WARNING: Installation of this antenna near power lines is dangerous. For your safety, follow the installation directions.

Each year hundreds of people are killed or injured when attempting to install an antenna. In many of these cases, the victim was aware of the danger of electrocution, but did not take adequate steps to avoid the hazard.

For your safety, and to help you achieve a good installation, please read and follow these safety precautions. **They may save your life!**

For your safety, read and follow these safety precautions.

- If you are installing an antenna for the first time, for your own safety as well as others, seek professional assistance. Your Cisco sales representative can explain which mounting method to use for the size and type antenna you are about to install.
- Before you install an antenna, contact your Cisco account representative to explain which mounting method to use for the size and type of antenna that you are about to install.

- Find someone to help you—installing an antenna is often a two-person job.
- Select your installation site with safety, as well as performance, in mind. Remember that electric power lines and phone lines look alike. For your safety, assume that any overhead line can kill you.
- Contact your electric power company. Tell them your plans and ask them to come look at your proposed installation.
- Plan your installation carefully and completely before you begin. Each person involved in an installation should be assigned to a specific task, and should know what to do and when to do it. One person should be in charge of the operation to issue instructions and watch for signs of trouble.
- When installing your antenna, follow these guidelines:
 - Do not use a metal ladder.
 - Do not work on a wet or windy day.
 - Do dress properly—wear shoes with rubber soles and heels, rubber gloves, and a long-sleeved shirt or jacket.
- If the assembly starts to drop, move away from it and let it fall. Because the antenna, mast, cable, and metal guy wires are all excellent conductors of electrical current, even the slightest touch of any of these parts to a power line completes an electrical path through the antenna and the installer.
- If any part of the antenna system should come in contact with a power line, do not touch it or try to remove it yourself. Call your local power company to have it removed safely.
- If an accident should occur with the power lines, call for qualified emergency help immediately.

Antenna Installation

The antenna installation includes the following procedures:

- [Tools and Equipment Required](#)
- [Installing the Antenna](#)

Tools and Equipment Required

In addition to the parts included in the antenna kit described in the section [Antenna Kit](#), you must provide the following tool to install the antenna on the router:

- A flathead screwdriver
- 3/4 in. open-end wrench

NOTE: This list does not include the tools and equipment required to assemble and erect the tower, mast, or other structure you intend to mount your antenna on.

Installing the Antenna

The antenna is provided with a mounting kit consisting of a mounting bracket and hose clamp. This kit allows you to mount the antenna to masts from 1.25 inches (3.2 centimeters) to 2 inches (5.1 cm). Cisco recommends that a 1.5 inch (3.8 centimeter) or larger tubing mast be used.

The antenna is vertically polarized. Since the antenna has vertical gain, it is very important to mount the antenna in a vertical (not leaning) position for optimal performance.

Follow these steps to mount the antenna onto a mast:

1. Place the connector end of the antenna through the hole in the antenna bracket.

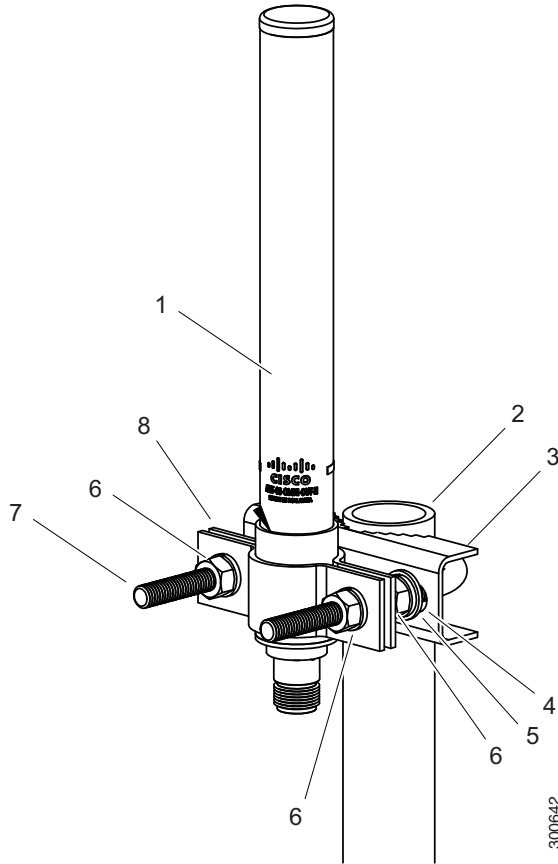

1	Outdoor omnidirectional antenna—aluminum tube (mast/pipe)	2	Aluminum pipe/mast—31.8 mm to 54.0 mm mast diameter. (For optimum performance, mast height should sit lower than aluminum tube)
3	Antenna bracket	4	Flat washer
5	Lock washer	6	Hex nut
7	Carriage bolt	8	Pipe clamps

2. Place the pipe clamps into the grooves on the bracket.
3. Attach the bracket to the top of the mast. The top surface of the mounting mast must not exceed the top surface of the mounting bracket. Securely tighten hose clamps.
4. Route the cable to the router and attach the cable to the antenna port of the router.

Installing the Module into the Router

If the corresponding module is not already installed in the router, install it according to the installation and configuration guide for the module.

Obtaining Documentation and Submitting a Service Request

For information on obtaining documentation, submitting a service request, and gathering additional information, see the monthly What's New in Cisco Product Documentation, which also lists all new and revised Cisco technical documentation, at:

<http://www.cisco.com/en/US/docs/general/whatsnew/whatsnew.html>

Subscribe to the *What's New in Cisco Product Documentation* as an RSS (Really Simple Syndication) feed, and set it so content is delivered directly to your desktop using a reader application. The RSS feeds are a free service and Cisco currently supports RSS Version 2.0.

Cisco and the Cisco Logo are trademarks of Cisco Systems, Inc. and/or its affiliates in the U.S. and other countries. A listing of Cisco's trademarks can be found at www.cisco.com/go/trademarks. Third party trademarks mentioned are the property of their respective owners. The use of the word partner does not imply a partnership relationship between Cisco and any other company. (1005R)

