



Cisco Dual Polarization Base Station Antenna (IW-ANT-SS9-516-N)

This chapter contains the following sections:

- [Overview, on page 1](#)
- [Electrical Specifications, on page 2](#)
- [Mechanical Specifications, on page 3](#)
- [Environmental Specifications, on page 3](#)
- [Mechanical Drawing, on page 4](#)
- [Installation Instructions, on page 5](#)
- [Radiation Patterns, on page 5](#)

Overview

The Cisco Dual Polarization Base Station Antenna (IW-ANT-SS9-516-N) is designed to cover a frequency range of 4.9 to 6.425 GHz. This antenna is designed for point-to-multipoint connectivity in smart cities (coverage for parking lots, building-to-building connectivity etc), or ports and mines.

Figure 1: IW-ANT-SS9-516-N Antenna



Features include the following:

- Compact size
- Relative high gain

Electrical Specifications

The following table is a summary of the electrical specifications:

Antenna Type	Dual Polarization Base Station
Frequency Range	4.9 - 6.425 GHz
Input Impedance	50 Ω
Gain	16 dBi (typ)
VSWR	1.7:1 (typ) 2:1 (max)
Polarization	Dual Linear Vertical + Horizontal
-3dB Elevation Beamwidth	7° (typ)
-3dB Azimuth Beamwidth	90° (typ)
Azimuth Side Lobe Level	Port V- ETSI EN 302 326-3 V1.3.1 CS2 Port H-ETSI EN 302 326-3 V1.3.1 CS2

F/B Ratio	30 dB (min)
Cross Polarization	-20 dB (typ)
Port to Port Isolation	45 dB (typ) 42 dB (min)
Power	6W (max)
Lightning Protection	DC Grounded

Mechanical Specifications

The following table is a summary of the mechanical specifications:

Dimensions (L x W x D)	371 x 371 x 40 mm (max)
Weight	2 kg (max)
Radome Material	Plastic
Base Plate Material	Aluminum with chemical conversion coating
Connector type	2X N-Type Female

Environmental Specifications

The following table is a summary of the mechanical specifications:

Test	Standard	Duration	Temperature	Notes
Low Temperature	IEC 68-2-1	72 hours	-55° C	—
High Temperature	IEC 68-2-2	72 hours	+71° C	—
Temperature Cycling	IEC 68-2-14	1 hour	-45°C +70°C	3 Cycles
Vibration	IEC 60721-3-4	30 min/axis	—	Random 4M3
Mechanical Shock	IEC 60721-3-4	4M3	—	4M3
Humidity	ETSI EN300-2-4 T4.1E	144 hours	—	95%
Water Tightness	IEC 529	—	—	IP67
Solar Radiation	ASTM G53	1000 hours	—	—
Flamibility	UL 94	—	—	Class HB

Test	Standard	Duration	Temperature	Notes
Salt Spray	IEC 68-2-11 Ka	500 hours	—	—
Ice and Snow	—	—	—	25mm Radial
Wind Speed Survival	—	—	—	220 Km/h
Wind Speed Operation	—	—	—	160 Km/h
Wind Load (Survival)	—	—	—	Front Thrust 39.6 kg Side Thrust 4.3 kg

Mechanical Drawing

The following diagram provides mechanical details of the antenna.



Note All measurements are in millimeters.

Figure 2: Mechanical Drawing

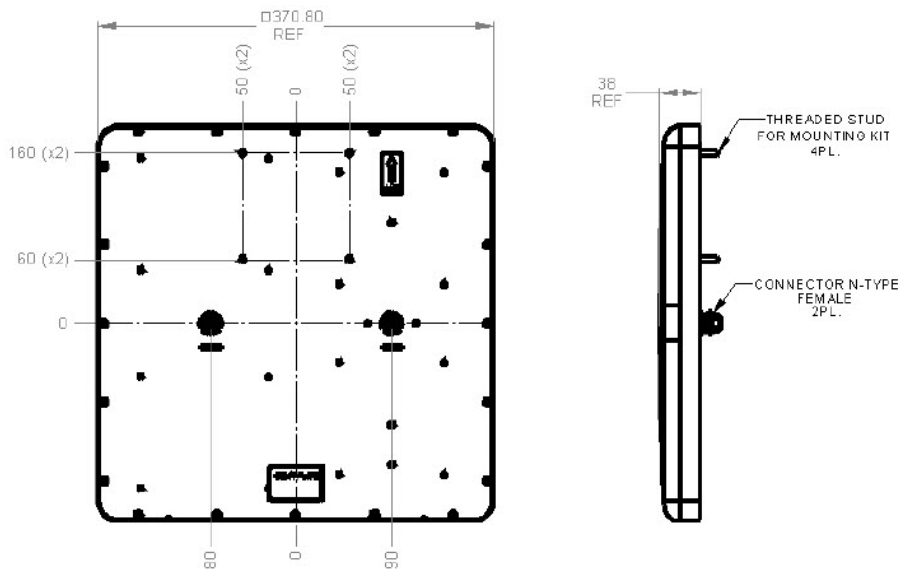

Installation Instructions

This antenna uses the [ATLAS MTI RFID Antenna Mounting Kit - MT-120018](#). Follow the link for complete installation instructions.

Radiation Patterns

The following figures show the antenna radiation patterns.

4.9 GHz

Figure 3: Horizontal

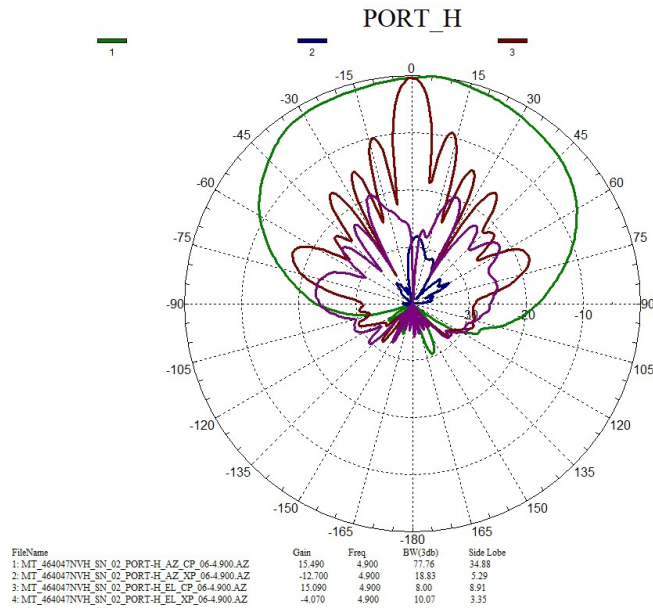
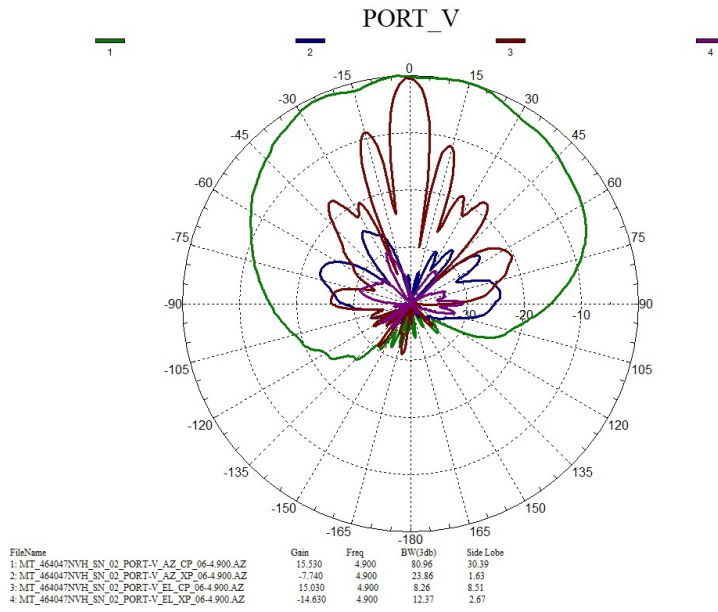

Figure 4: Vertical



5.1 GHz

Figure 5: Horizontal

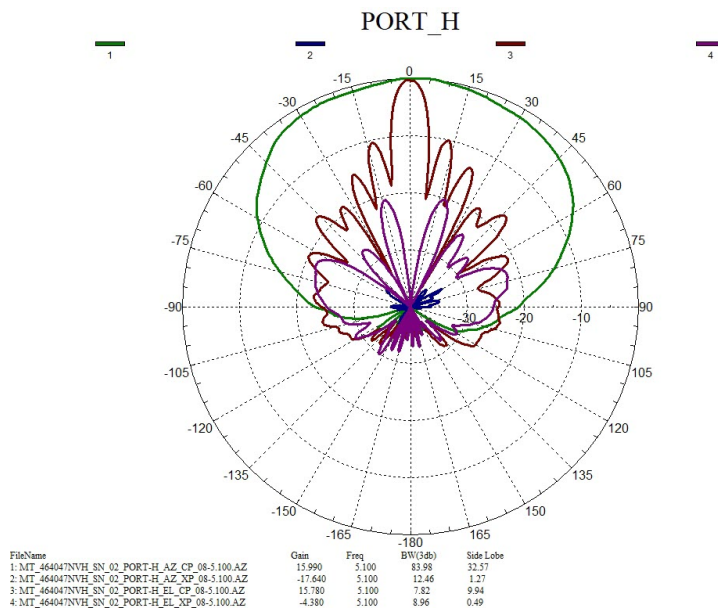
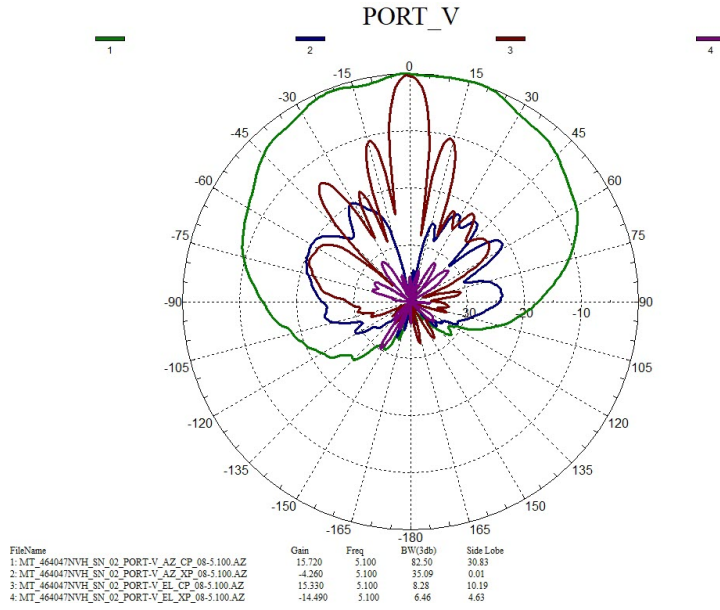

Figure 6: Vertical



5.3 GHz

Figure 7: Horizontal

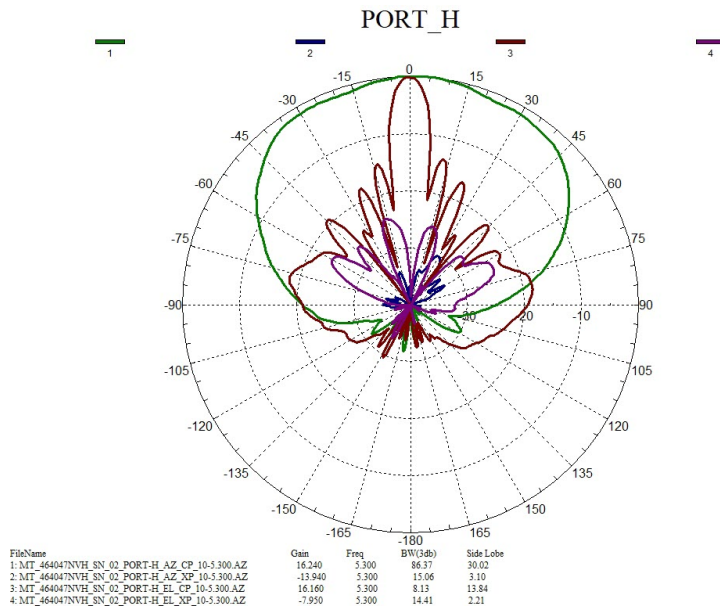
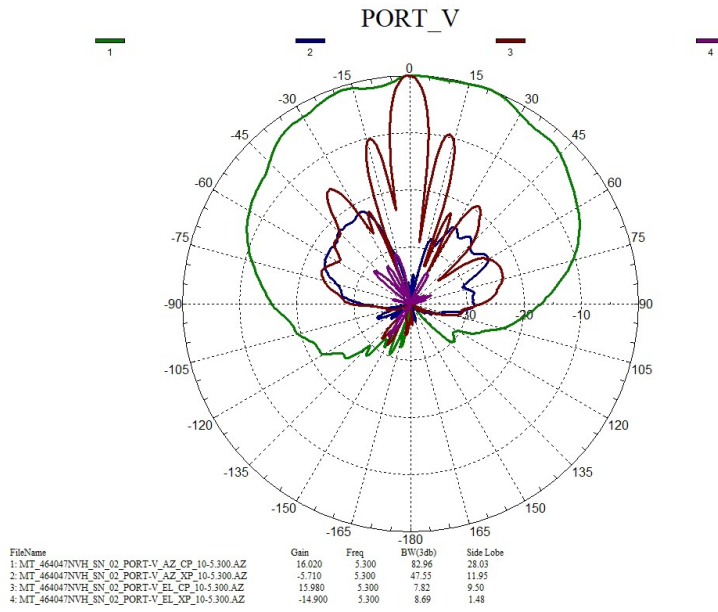

Figure 8: Vertical



5.5 GHz

Figure 9: Horizontal

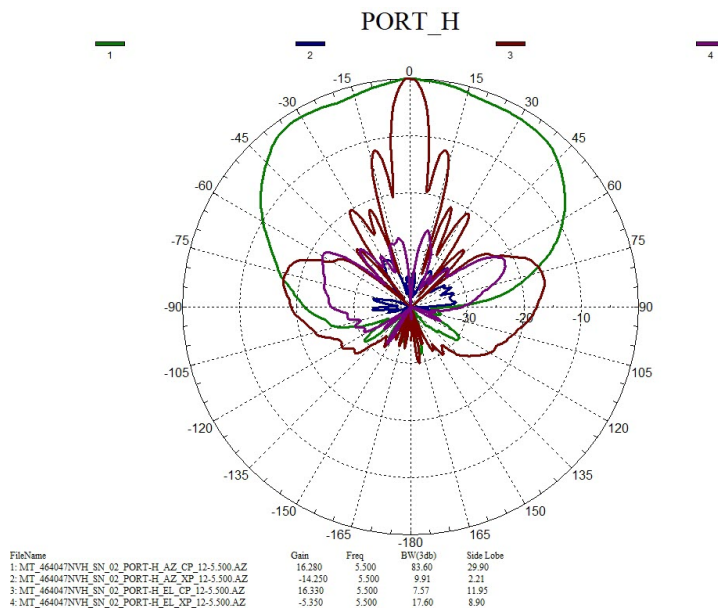
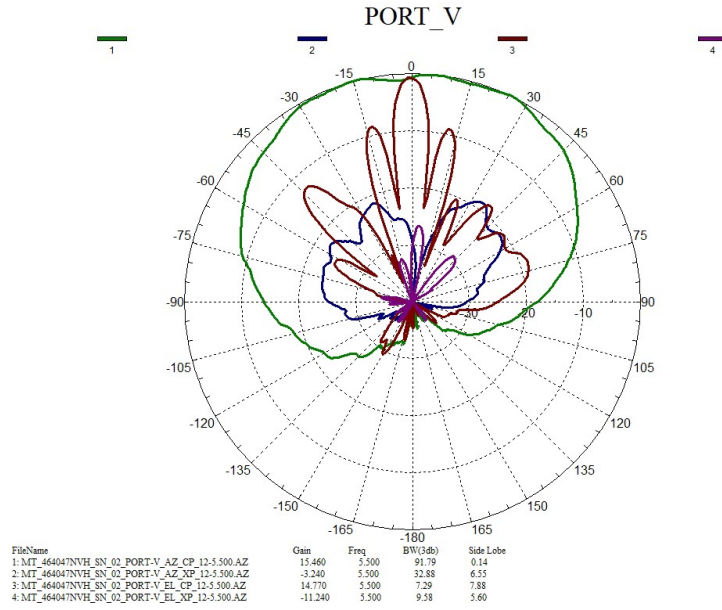

Figure 10: Vertical



5.7 GHz

Figure 11: Horizontal

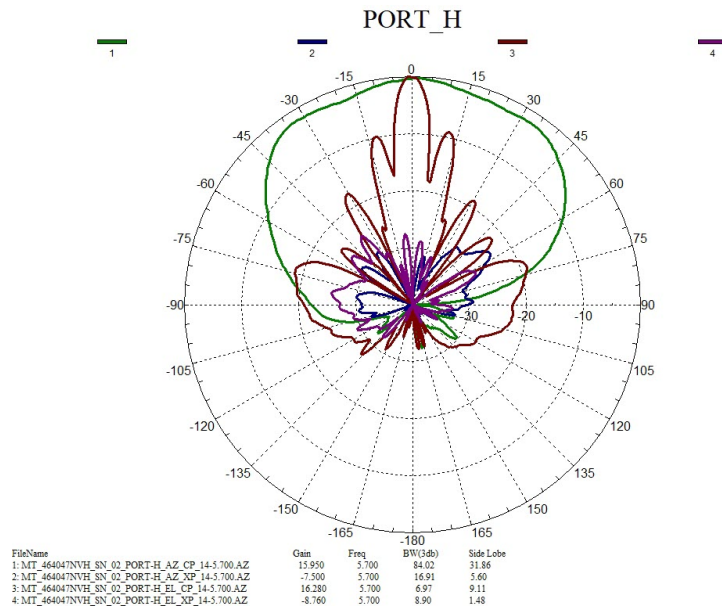
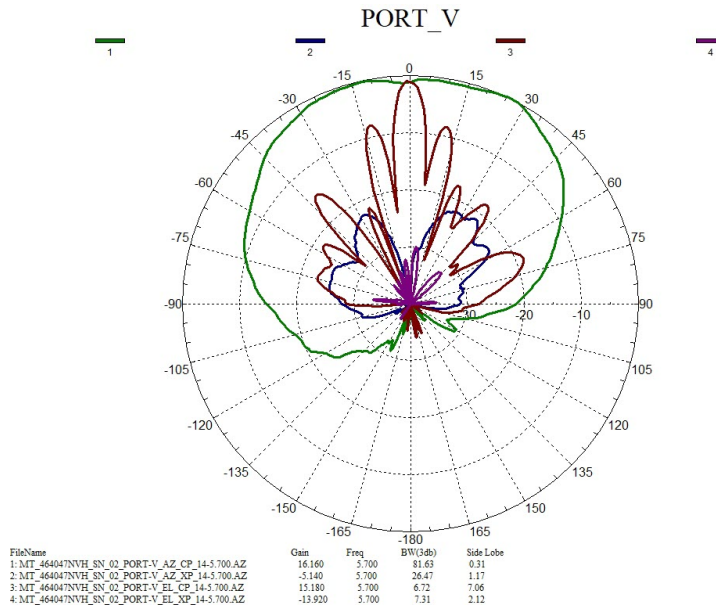

Figure 12: Vertical



5.9 GHz

Figure 13: Horizontal

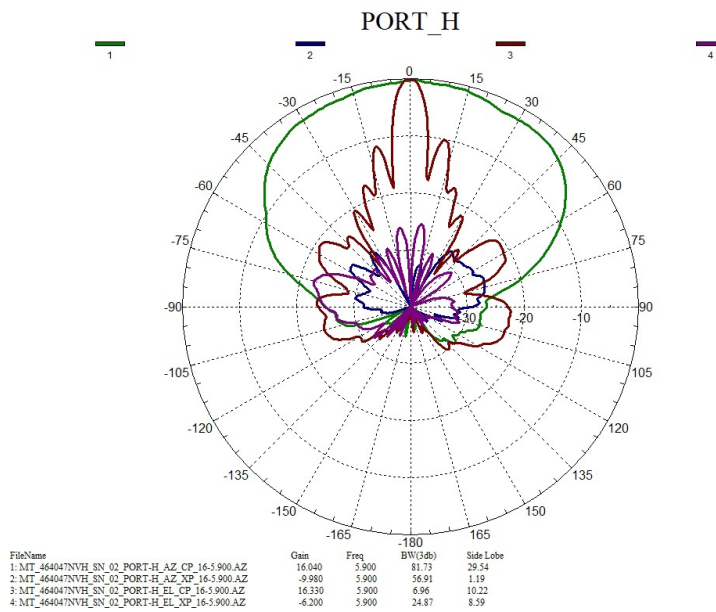
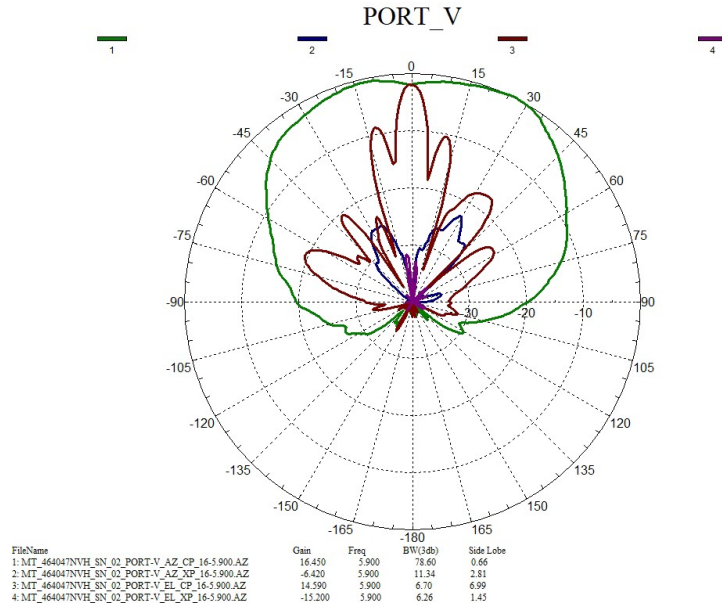

Figure 14: Vertical



6.1 GHz

Figure 15: Horizontal

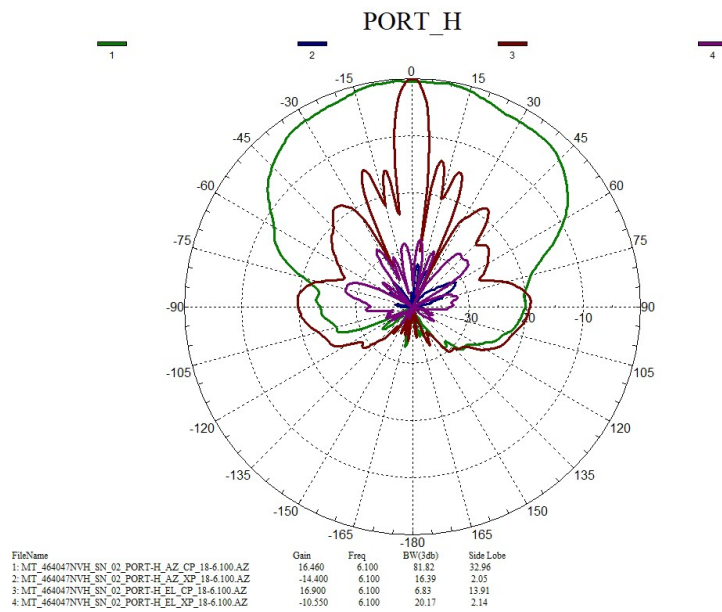
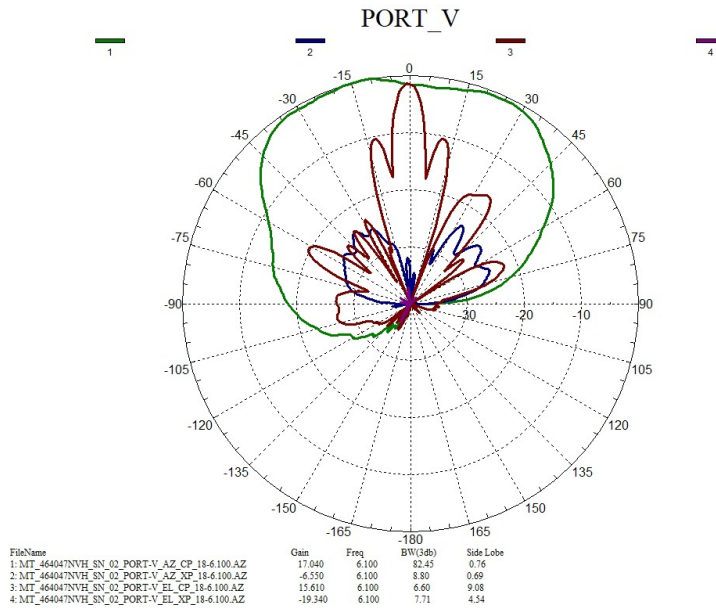

Figure 16: Vertical



6.3 GHz

Figure 17: Horizontal

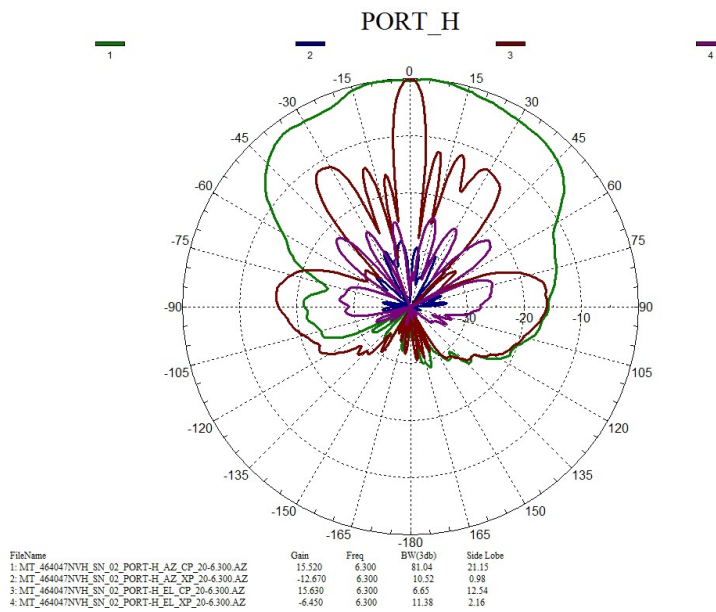
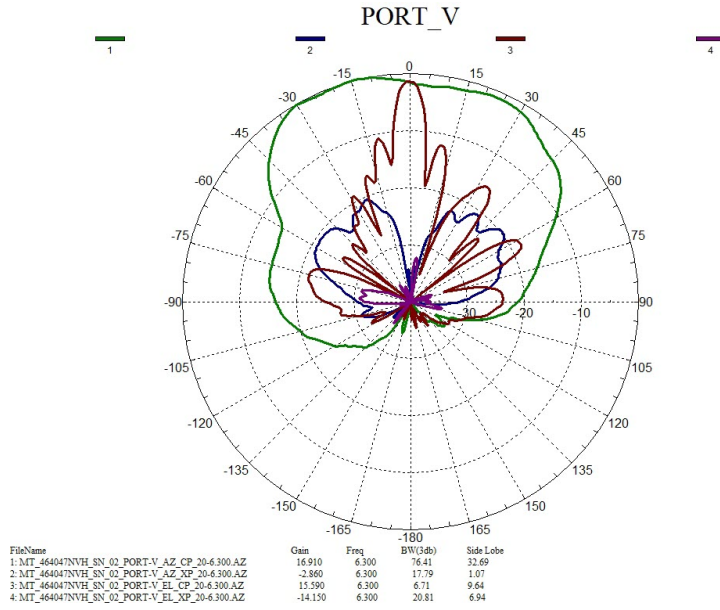

Figure 18: Vertical



6.5 GHz

Figure 19: Horizontal

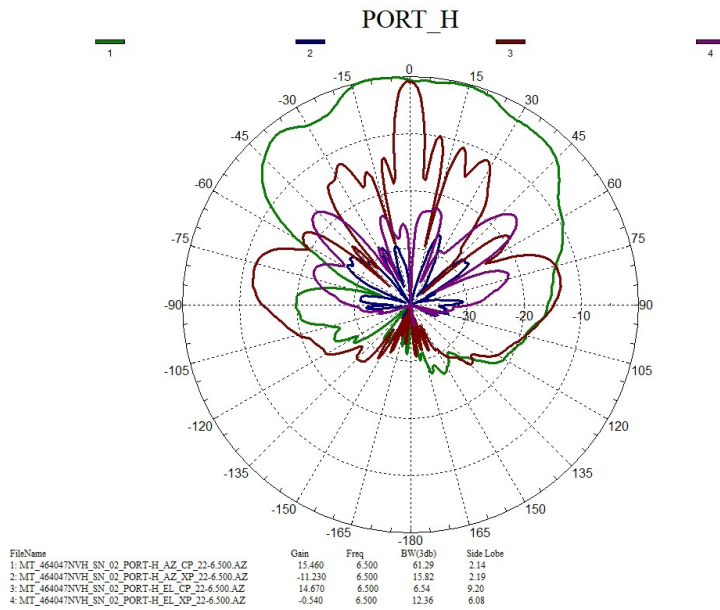

Figure 20: Vertical

