



Cisco Spot-S 2x2 Wi-Fi MIMO Antenna (IW-ANT-PNL-59-N)

This chapter contains the following sections:

- [Overview, on page 1](#)
- [Electrical Specifications, on page 2](#)
- [Mechanical Specifications, on page 3](#)
- [Environmental Specifications, on page 3](#)
- [Mechanical Drawing, on page 3](#)
- [Antenna Installation, on page 4](#)
- [Antenna Gain, on page 7](#)
- [Antenna S Patterns, on page 7](#)
- [Antenna Radiation Patterns, on page 8](#)

Overview

The Cisco Spot-S 2x2 MIMO Antenna (IW-ANT-PNL-59-N) is a small directional, planar, linear polarized antenna.

Features include the following:

- Dual-slant +/- 45° for MIMO antenna configuration
- WLAN IEEE 802.11 a/h/p/n
- Rugged design, meets EN 50155 and EN 50125-3 railway standards
- Ingress protection IP66 & IP67
- For outdoor and indoor applications
- Wall mounting material is included

Figure 1: IW-ANT-PNL-59-N Antenna



Electrical Specifications

The following table is a summary of the electrical specifications:

Frequency	5150 - 5935 MHz
Nominal Impedance	50 Ω
VSWR	2
Gain	9 dBi
3dB beamwidth (h)	70°
3dB beamwidth (v)	60°
Composite power max	30 W
Front to back ratio	20 dB
Vertical electrical tilt	0°
Port Isolation	20 dB

Mechanical Specifications

The following table is a summary of the mechanical specifications:

Dimensions	101 x 81 x 36 mm (Height x Width x Depth)
Weight	0.11 kg
Color	RAL 7044 (Grey)
Material	PC (Polycarbonate)
Windload	Frontal: 15 N at 160 km/h Wind speed survival: 220 km/h
Connectors	N, jack (female)
Polarization	Port 1: -45° slant Port 2: +45° slant
DC Grounded	Yes

Environmental Specifications

The following table is a summary of the environmental specifications:

Operating Temperature	-40 to 85° C
Storage Temperature	-40 to 85° C
Transport Temperature	-40 to 85° C
Ingress Protection	IP66 & IP67
RoHS Compliant	2011/65/EU including 2015/863 and 2017/2102

Mechanical Drawing

The following diagrams provides mechanical details of the antenna.



Note All measurements are in millimeters.

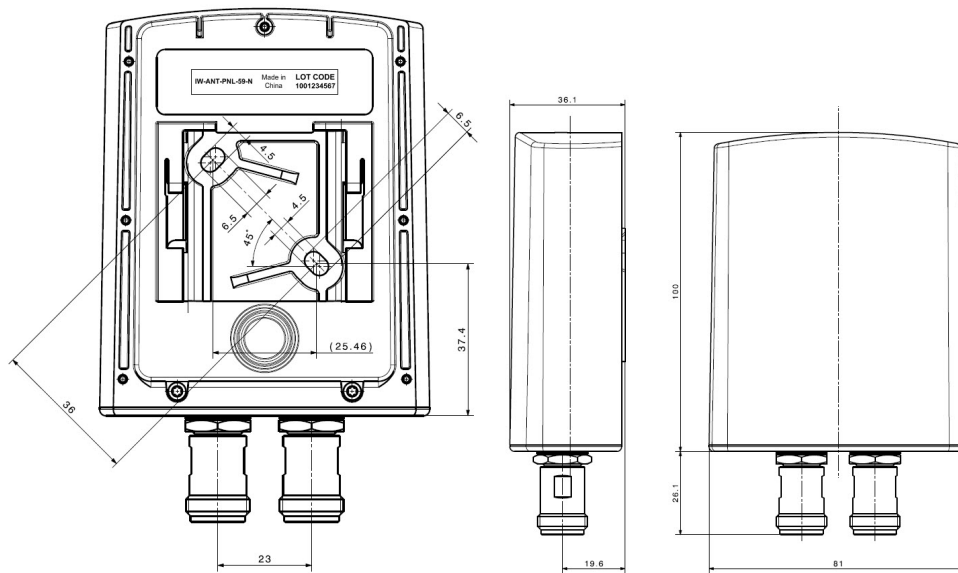

Antenna Installation

Follow these steps to properly install the antenna.

- Step 1** Mount the antenna holding plate on a wall with anchor bolts.
Use the holding plate as a template for marking the hole locations.

Figure 2: Anchor Holes

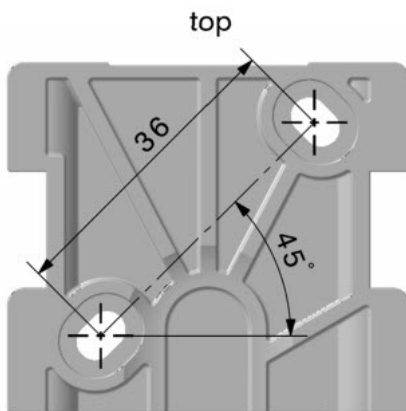

Drill two holes and mount the holding plate on the wall using the following figure for guidance:

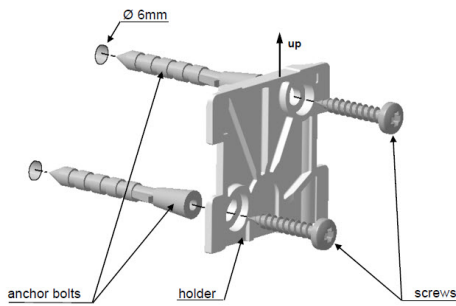
Figure 3: Attach Holding Plate to Wall With Anchor Bolts

- Step 2** Mount the antenna holding plate on a wall with screws.
Use the holding plate as a template for marking the hole locations.

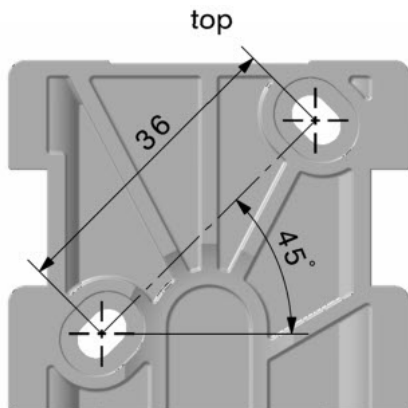
Figure 4: Anchor Holes

Drill two holes and mount the anchor plate on the wall using the following figure for guidance:

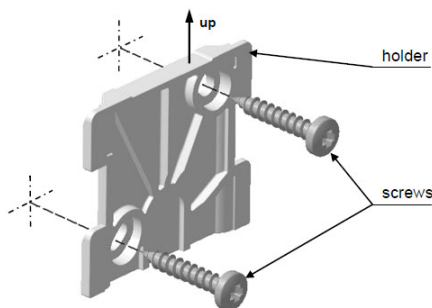
Figure 5: Attach Holding Plate to Wall with Screws

- Step 3** Mount the antenna onto the holding plate.
Place the antenna onto the holding plate and slide it down until it engages.

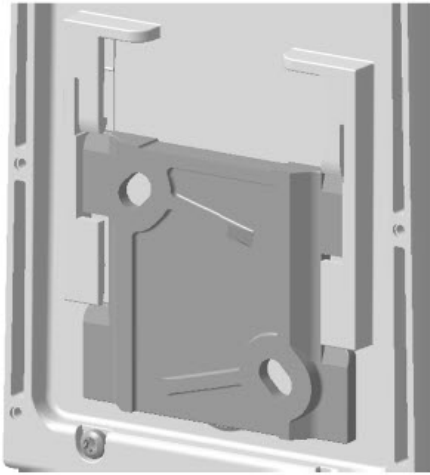

Step 4 Finish the installation by noting the following details.

Figure 6: Installation Details

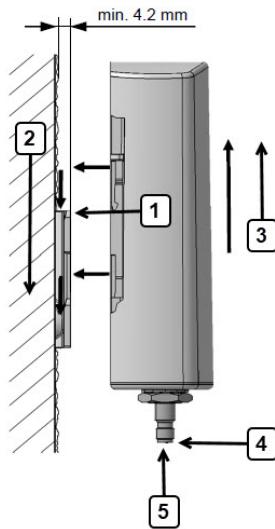

Table 1: Installation Details

Item	Description
1	Align the antenna with the mounting plate and place it on the holding plate.
2	Slide the antenna down until it engages.
3	To release the antenna, slide it upwards.
4	Maximum coupling nut torque is defined by the connector (interface specification) but should not exceed 2 Nm.

Item	Description
5	When attaching the cable, make sure to avoid any bending or tension of the cable.

Antenna Gain

The following figure shows the Antenna Gain:

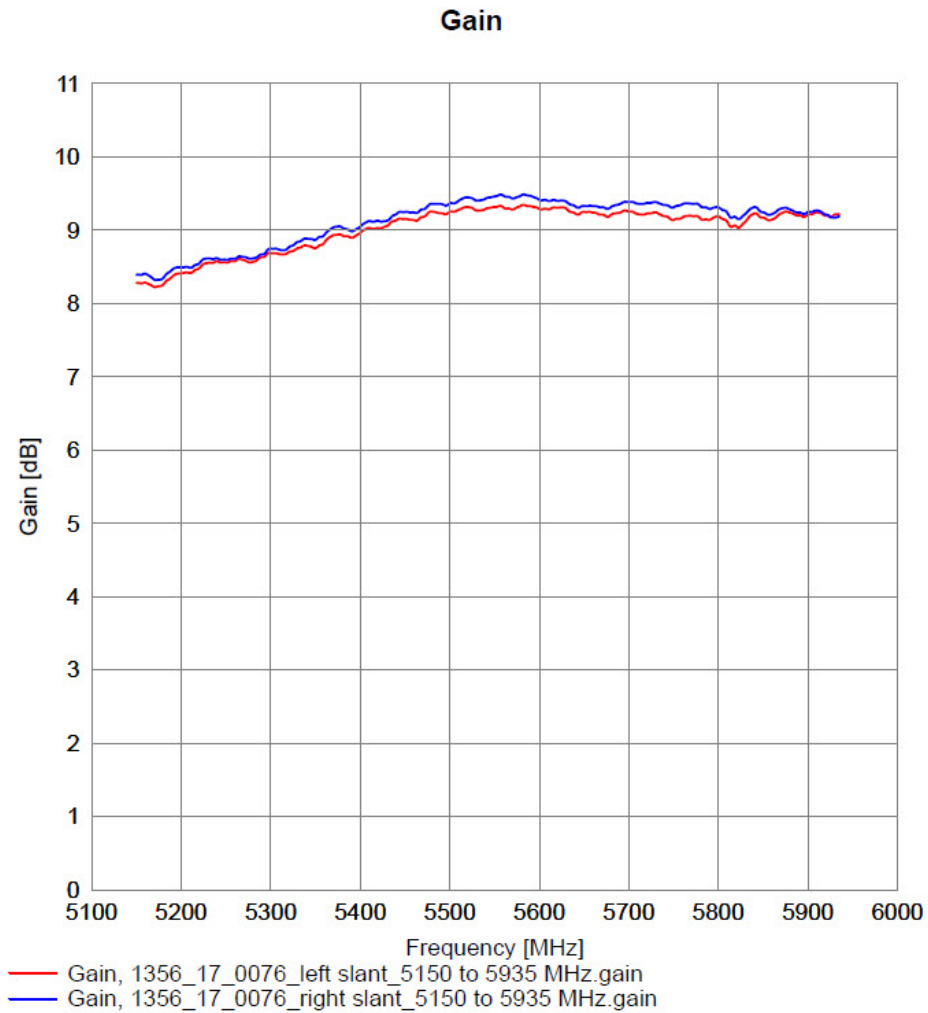

Antenna S Patterns

The following figure shows the Antenna S-Patterns:

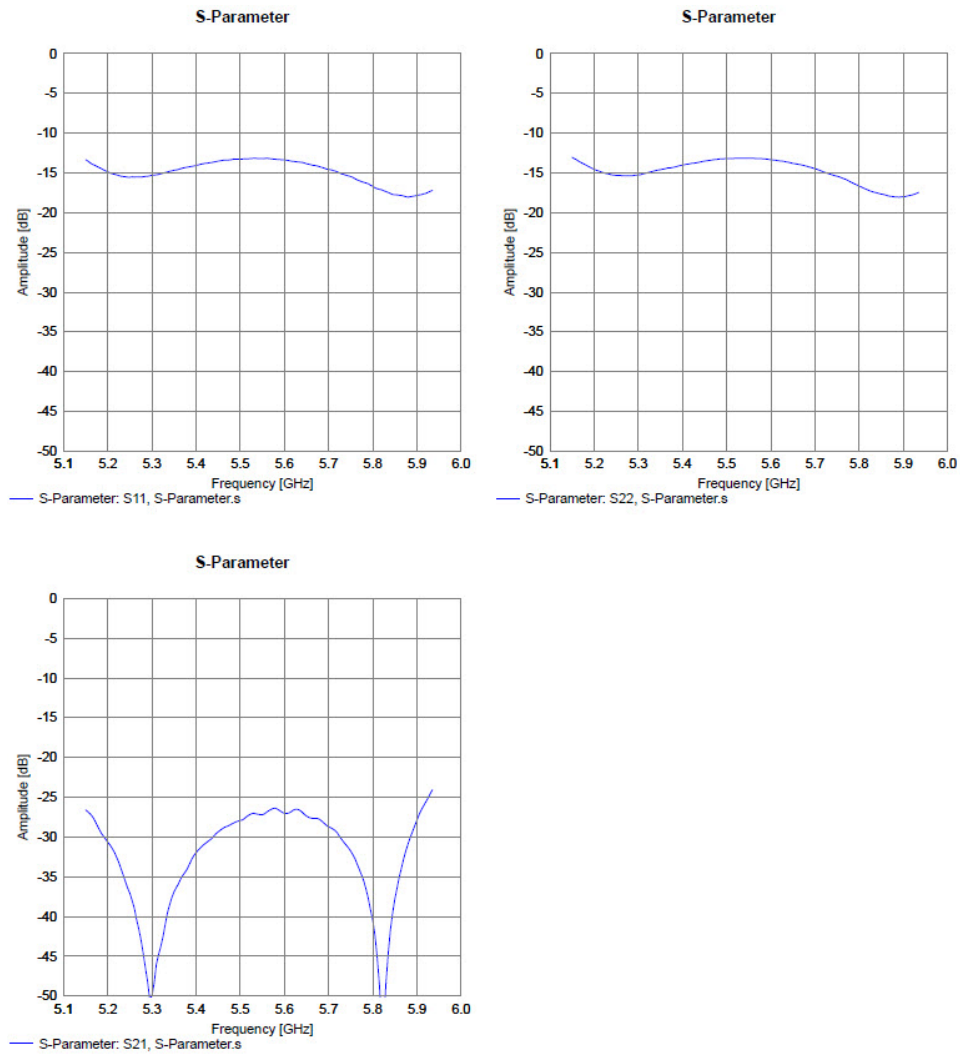

Antenna Radiation Patterns

The following series of figures show the Antenna Radiation patterns:

5150 MHz

Port: left slant
 Frequency: 5150 MHz

Port: right slant
 Frequency: 5150 MHz

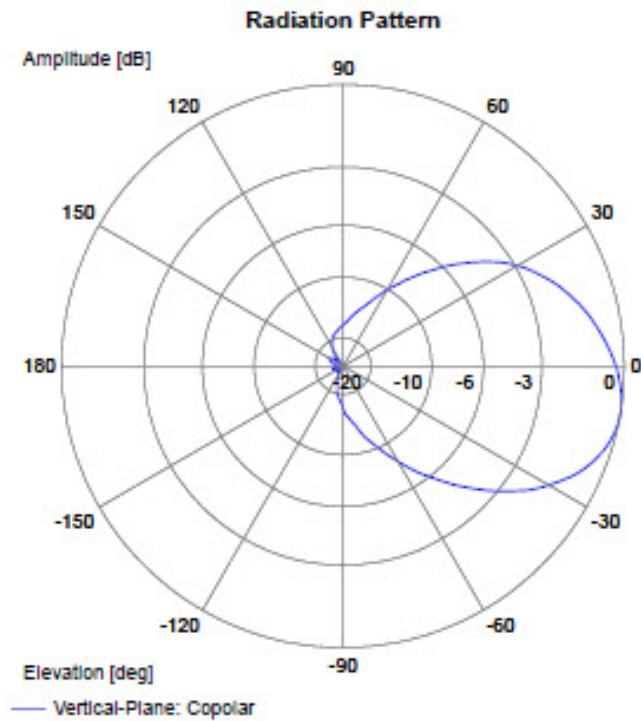
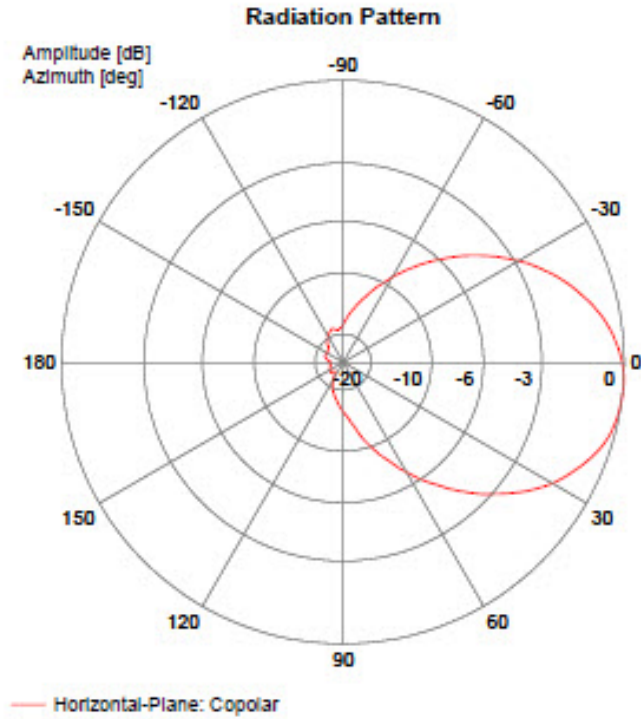

5200 MHz

Port: left slant
 Frequency: 5200 MHz

Port: right slant
 Frequency: 5200 MHz

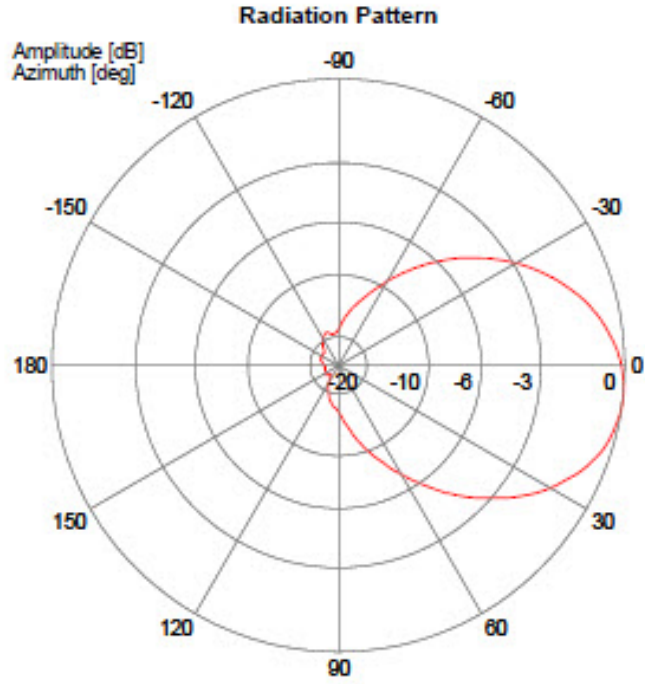

— Horizontal-Plane: Copolar

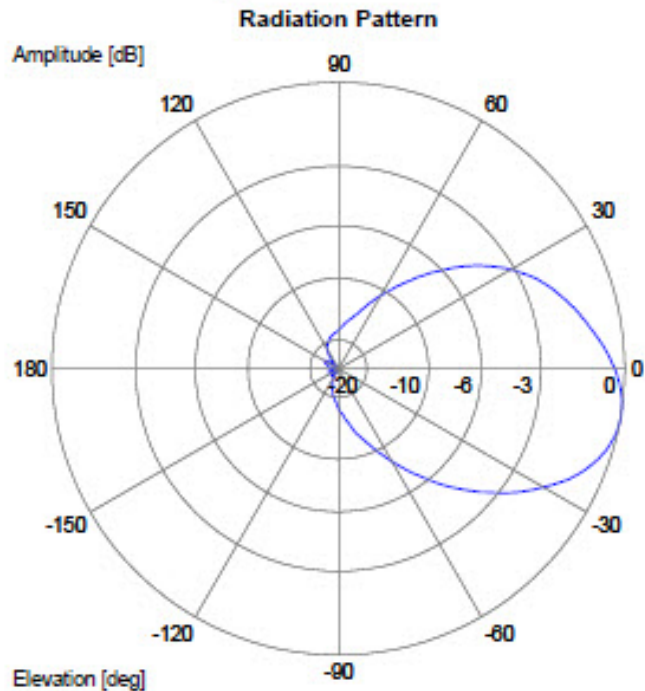

— Vertical-Plane: Copolar

5250 MHz

Port: left slant
Frequency: 5250 MHz

Port: right slant
Frequency: 5250 MHz

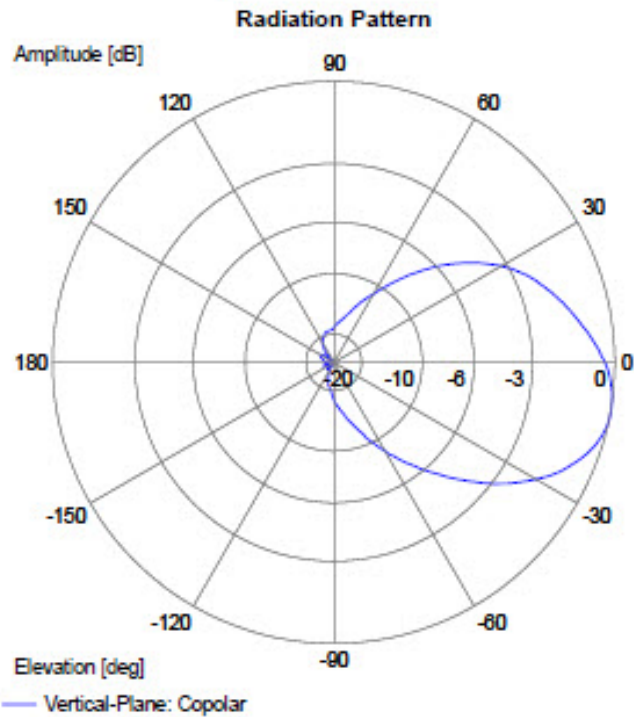
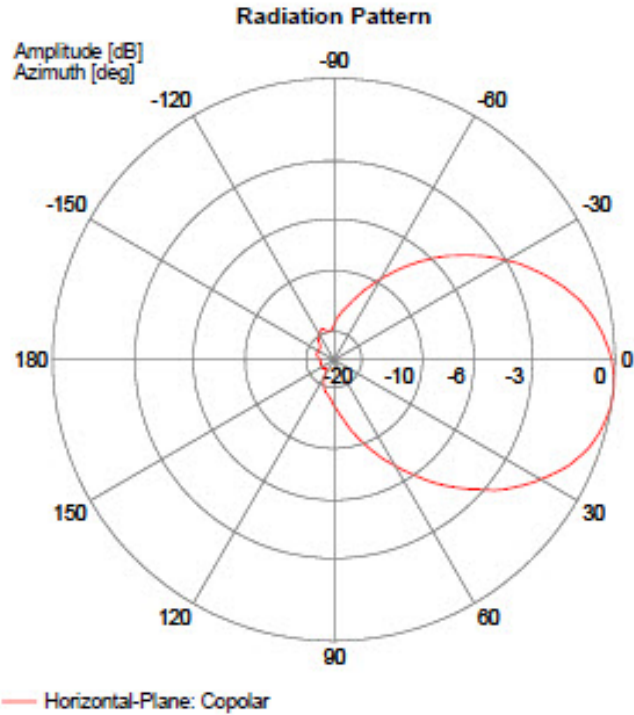

5300 MHz

Antenna Radiation Patterns

Port: left slant
 Frequency: 5300 MHz

Port: right slant
 Frequency: 5300 MHz

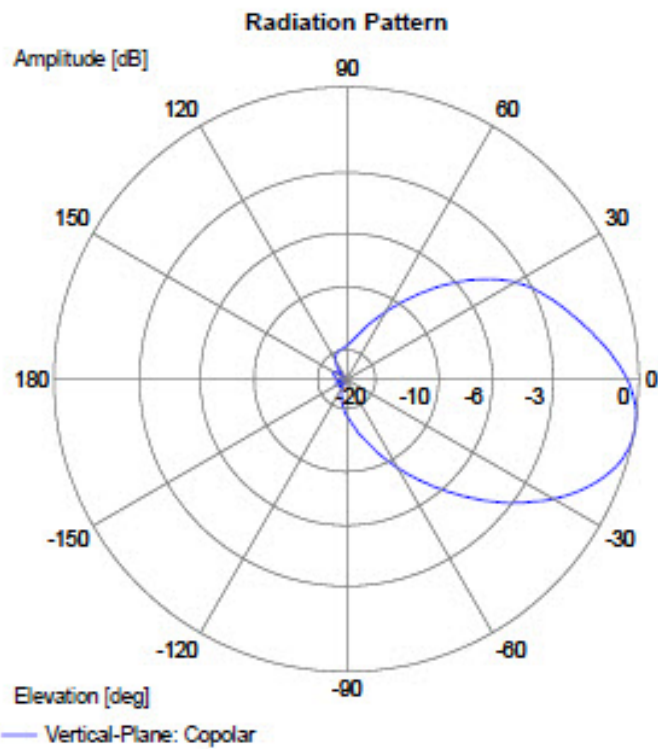
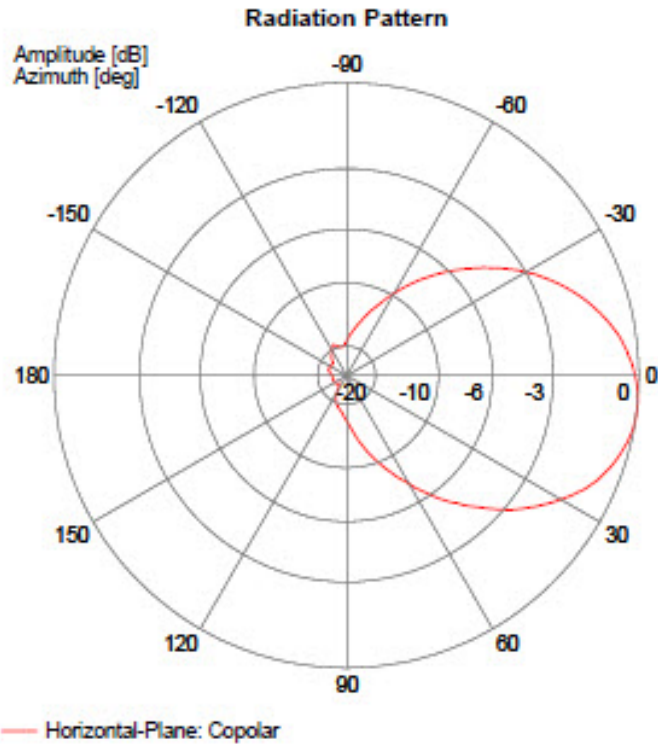

5470 MHz

Antenna Radiation Patterns

Port: left slant
 Frequency: 5470 MHz

Port: right slant
 Frequency: 5470 MHz

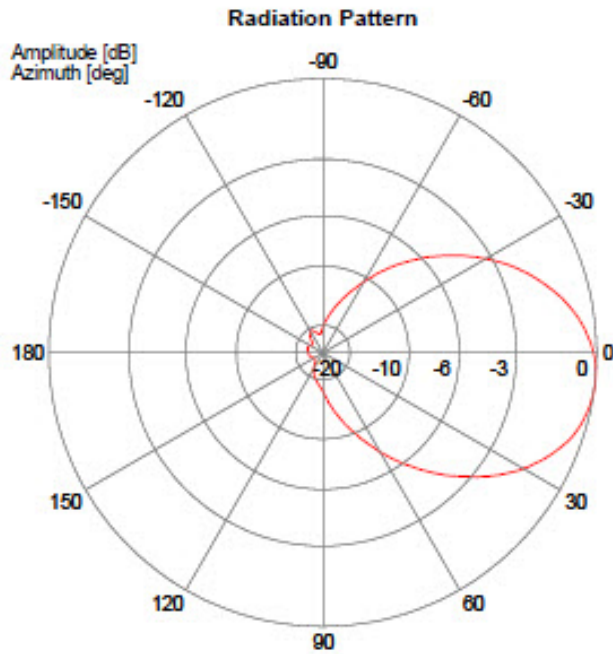

— Horizontal-Plane: Copolar

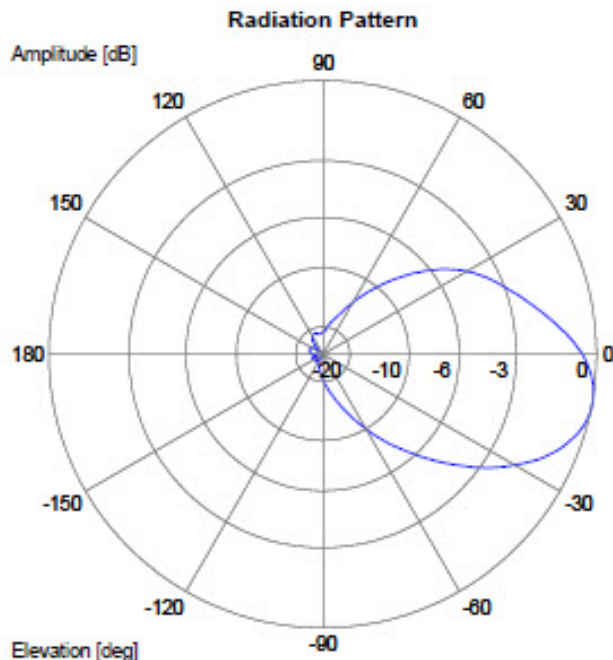

— Vertical-Plane: Copolar

5500 MHz

Antenna Radiation Patterns

Port: left slant
 Frequency: 5500 MHz

Port: right slant
 Frequency: 5500 MHz

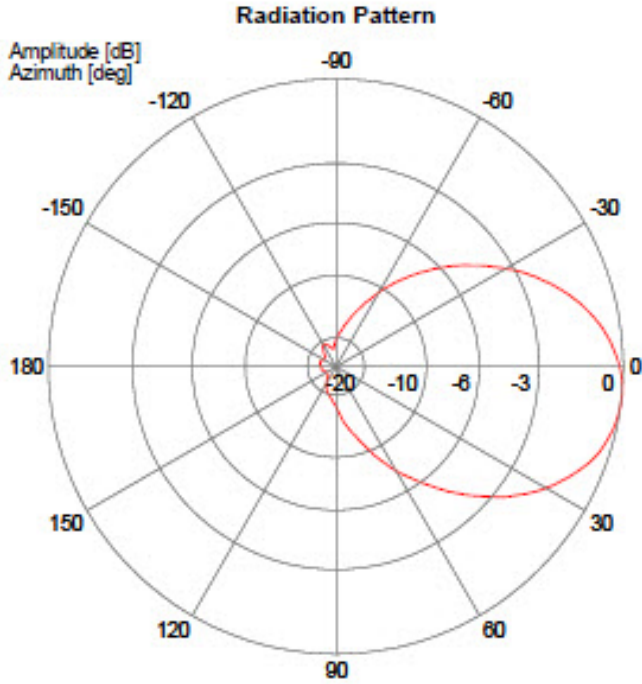

— Horizontal-Plane: Copolar

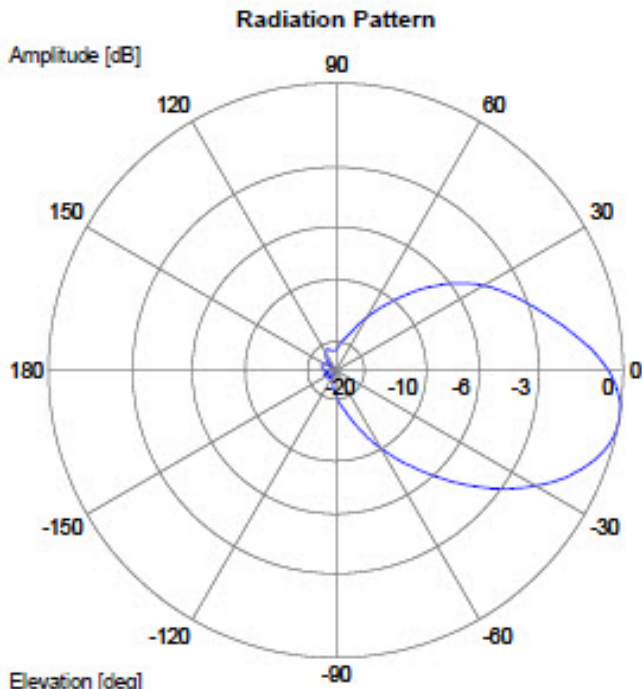

— Vertical-Plane: Copolar

5550 MHz

Antenna Radiation Patterns

Port: left slant
 Frequency: 5550 MHz

Port: right slant
 Frequency: 5550 MHz

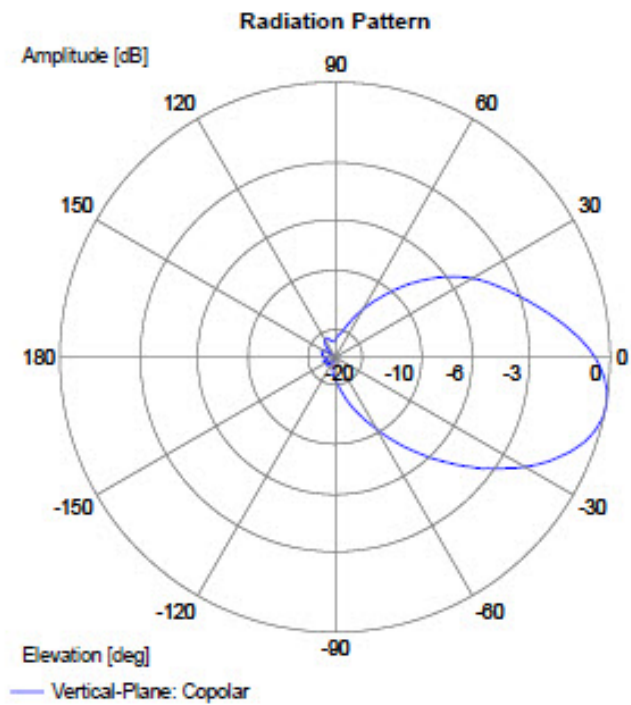
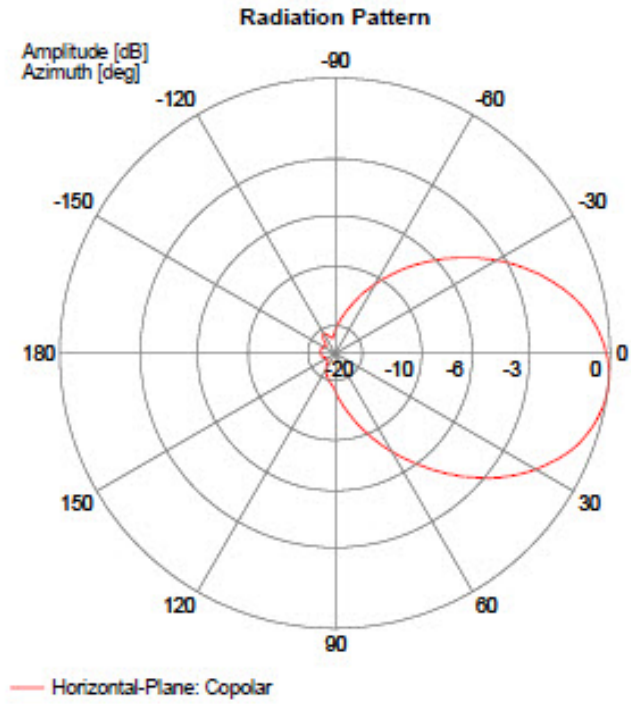

5600 MHz

Antenna Radiation Patterns

Port: left slant
 Frequency: 5600 MHz

Port: right slant
 Frequency: 5600 MHz

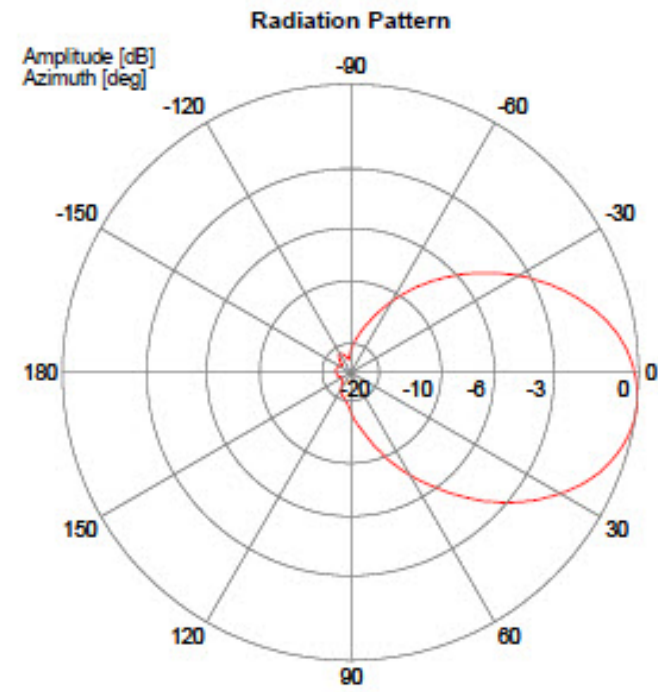

— Horizontal-Plane: Copolar

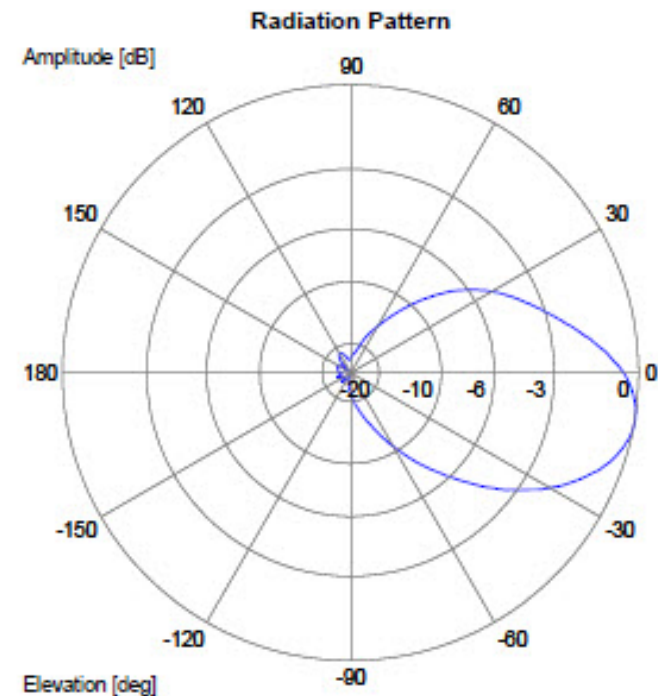

— Vertical-Plane: Copolar

5650 MHz

5700 MHz

Port: left slant
 Frequency: 5700 MHz

Port: right slant
 Frequency: 5700 MHz

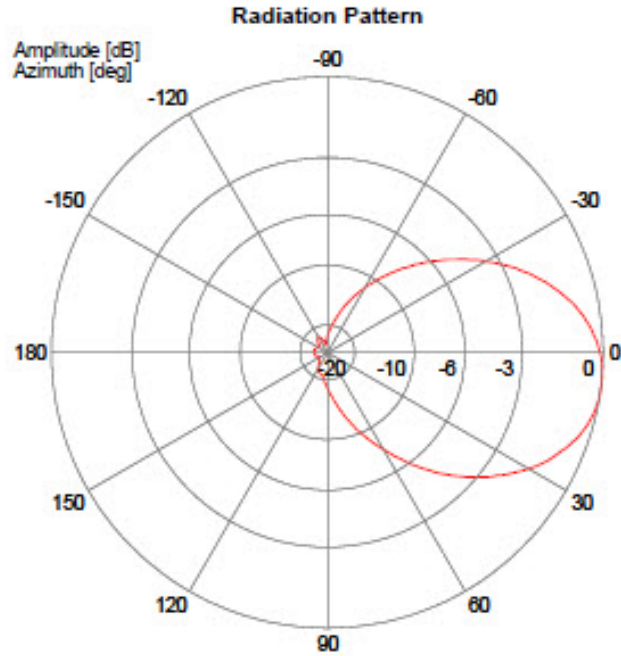

— Horizontal-Plane: Copolar

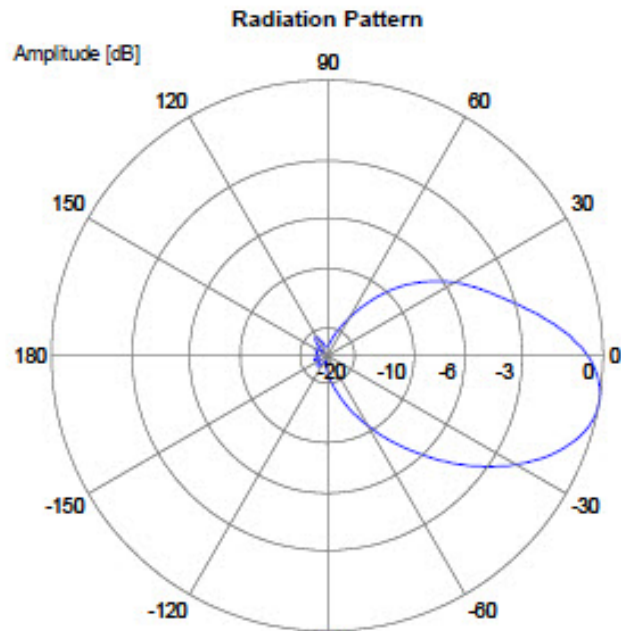

— Vertical-Plane: Copolar

5750 MHz

Antenna Radiation Patterns

Port: left slant
 Frequency: 5750 MHz

Port: right slant
 Frequency: 5750 MHz

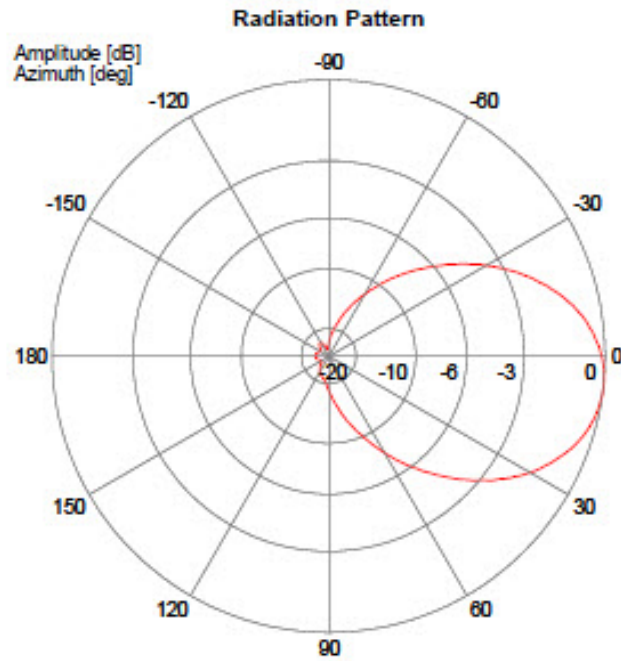

— Horizontal-Plane: Copolar

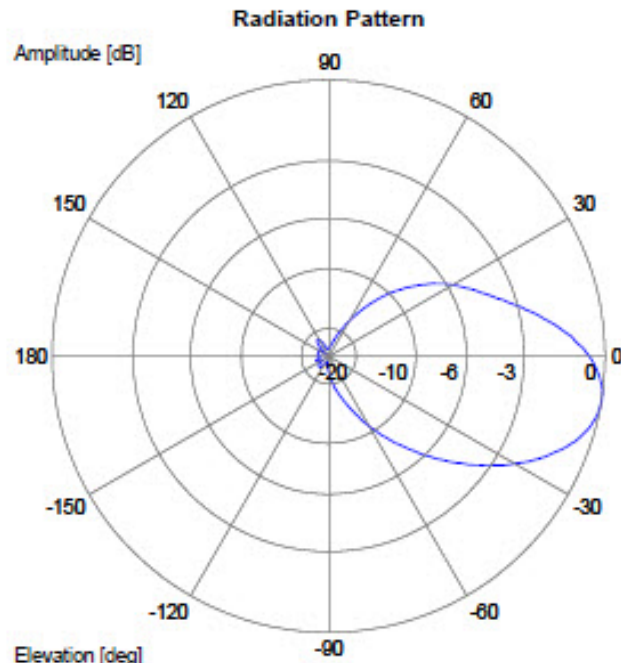

— Vertical-Plane: Copolar

5800 MHz

Port: left slant
 Frequency: 5800 MHz

Port: right slant
 Frequency: 5800 MHz

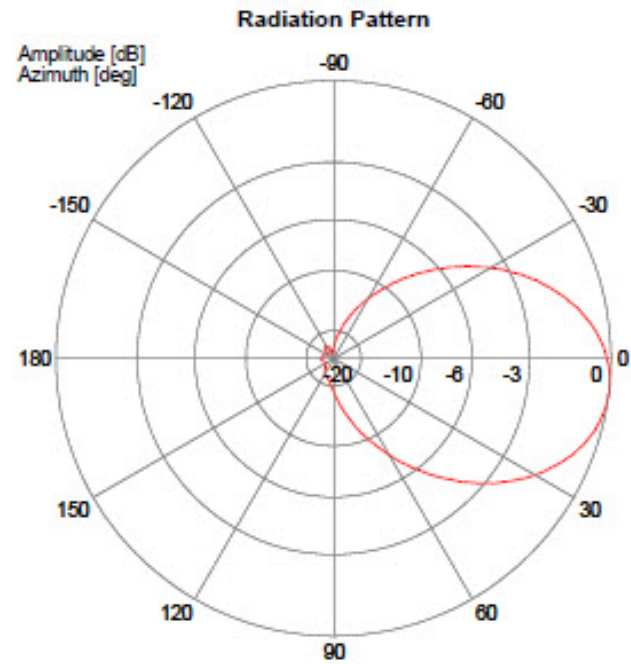

— Horizontal-Plane: Copolar

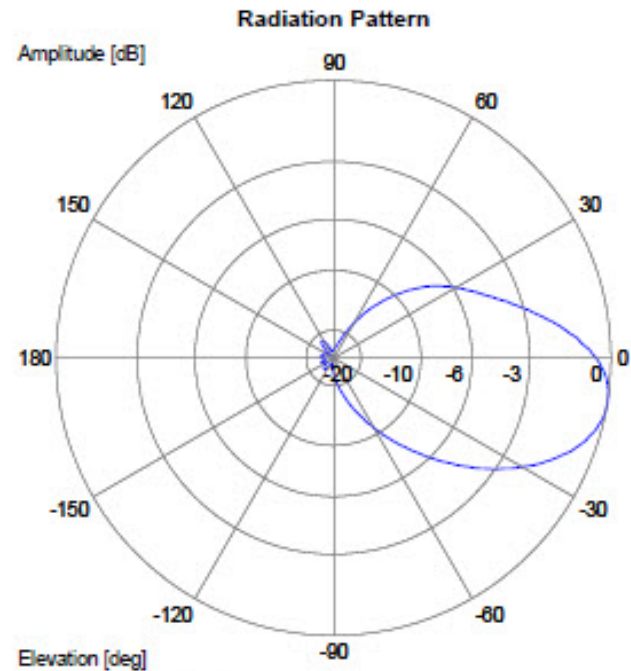

— Vertical-Plane: Copolar

5850 MHz

Port: left slant
 Frequency: 5850 MHz

Port: right slant
 Frequency: 5850 MHz

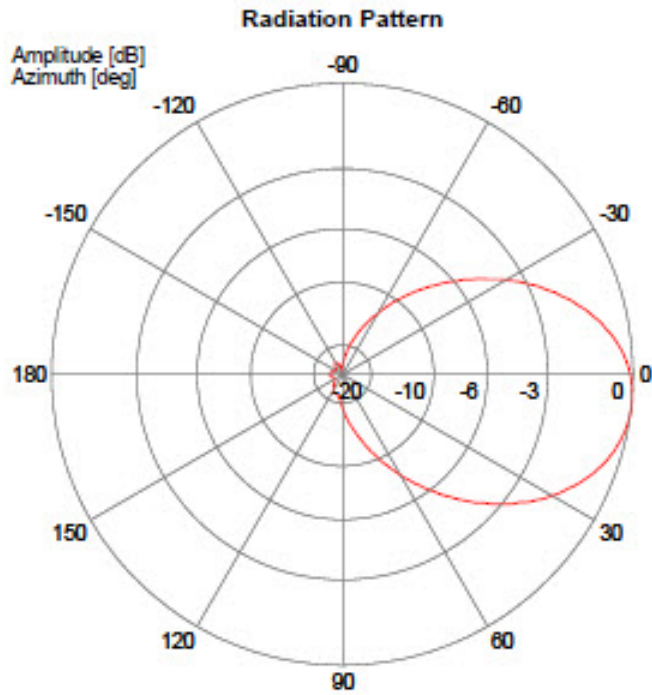

— Horizontal-Plane: Copolar

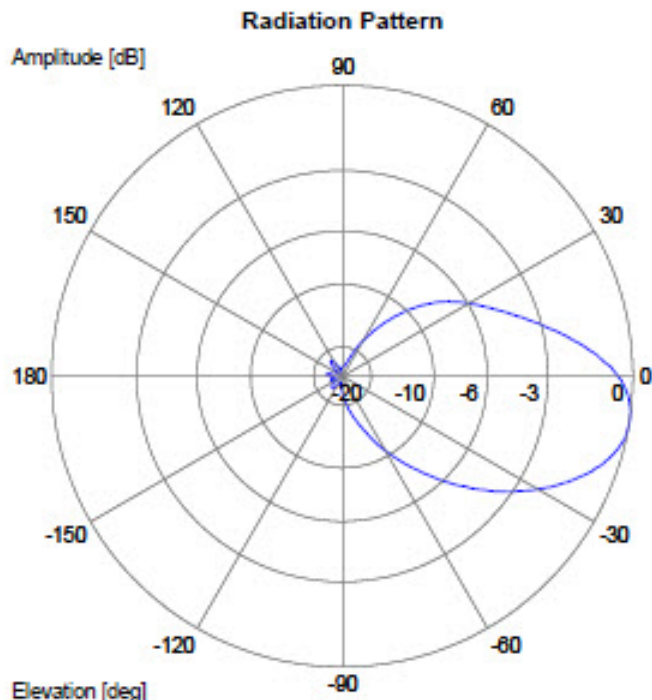

— Vertical-Plane: Copolar

5900 MHz

Port: left slant
 Frequency: 5900 MHz

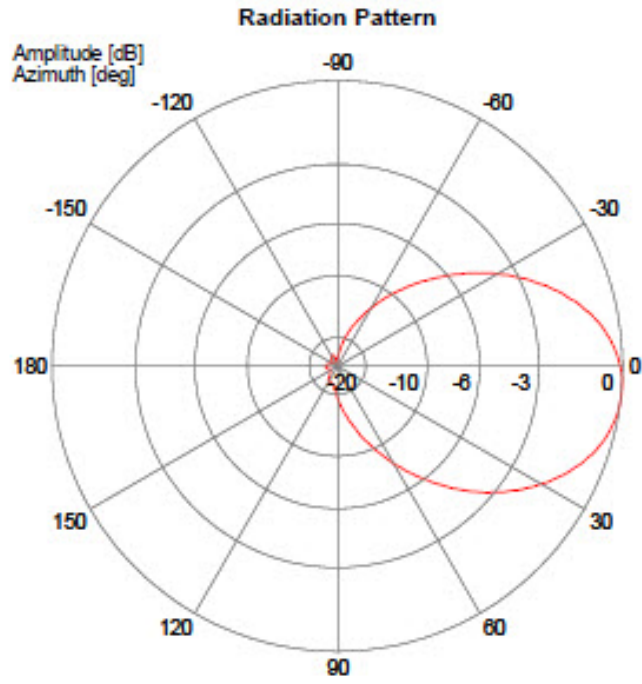

Port: right slant
 Frequency: 5900 MHz

— Horizontal-Plane: Copolar

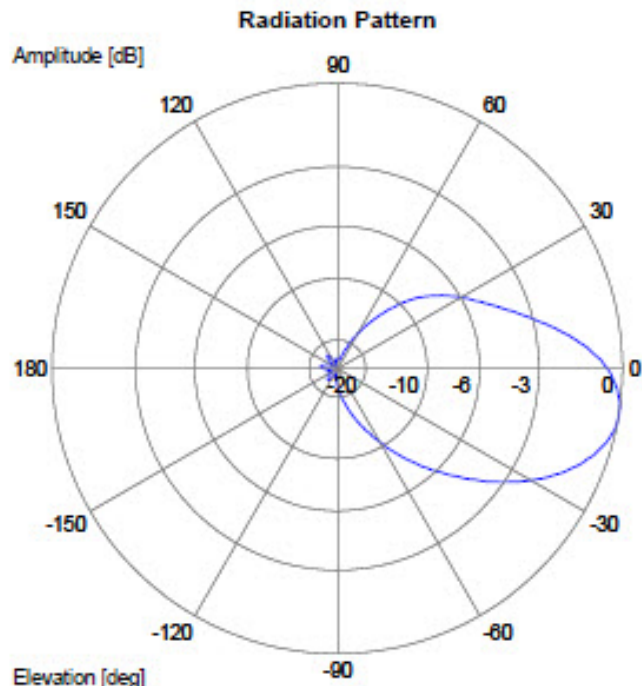

— Vertical-Plane: Copolar

5925 MHz

5935 MHz

Port: left slant
Frequency: 5935 MHz

Port: right slant
Frequency: 5935 MHz

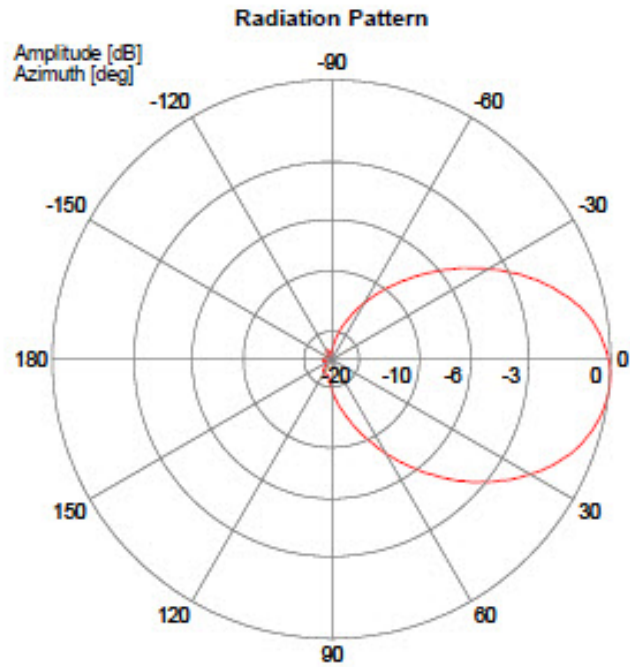

— Horizontal-Plane: Copolar

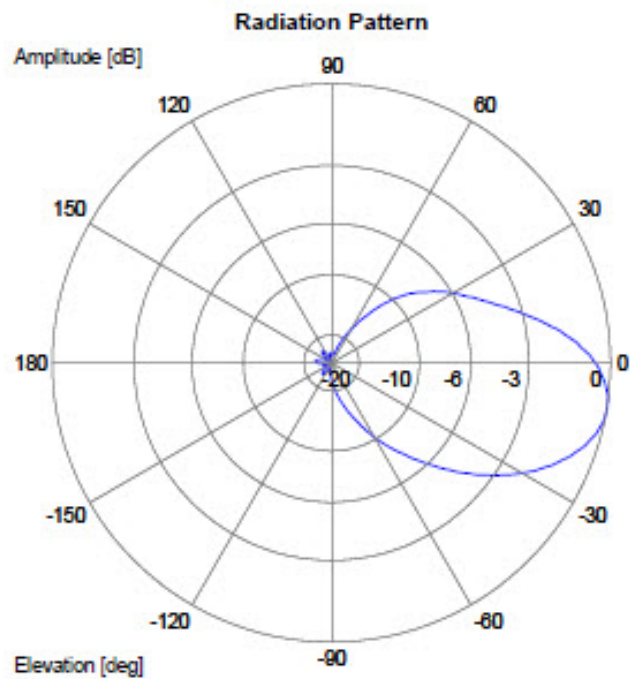

— Vertical-Plane: Copolar