



## Overview

The Cisco ASR 920 Series Aggregation Services Router is a family of modular and fixed configuration routers that enables Service Providers to provide business, residential, and mobile access services to their users. It is the Carrier Ethernet access platform providing Ethernet services.

The Cisco ASR 920 Series Routers family complement and extend Cisco's current and planned Carrier Ethernet routing portfolio providing a cost optimized, and extended temperature range access platform.

- [Cisco ASR 920 Series Routers Features, on page 1](#)

## Cisco ASR 920 Series Routers Features

The Cisco ASR 920 Series Routers family includes:

- ASR 920-Modular [ASR-920-24SZ-IM]—This sub-family with 1.5 RU form factor has fixed ENET interfaces (four 10GE and twenty-four 1GE Fiber), one slot for modular interface card and redundant modular power supplies (AC/DC). The interface modules from ASR 900 family of routers can be leveraged for use with this model.
- ASR 920-Fixed [ASR-920-24SZ-M/ASR-920-24TZ-M]—This sub-family with 1 RU form factor has fixed ENET interfaces (four 10GE and twenty-four 1GE Copper or SFP) and redundant modular power supplies (AC/DC).

The following table provides a snapshot of the number and type of supported ports:

**Table 1: Supported Ports on Cisco ASR 920-24SZ-IM, ASR-920-24SZ-M, ASR-920-24TZ-M Router**

ASR 920 Sub-family	1 GE Port	10 GE Port	Type of 1 GE Port	Type of 10 GE Port	Timing Ports
ASR-920-24SZ-IM	24	4	24 Fiber	Built in 4 SFP+	ToD and BITS/GPS 1 PPS and GPS 10 MHz
ASR-920-24SZ-M/ASR-920-24TZ-M	24	4	24 Fiber 24 Copper	Built in 4 SFP+	NA



**Note** Due to EMC restrictions, only a maximum of 8 DS1 TPoP is supported out of the 12 ports on the top row (1–23) of the router.

## GigabitEthernet Copper Ports

Fixed copper GigabitEthernet (GE) interfaces are provided through standard RJ-45 connectors. These ports support the following features:

- Standard 10/100/1000Base-T/TX operation with forced or auto-negotiation for speed and duplex.
- Automatic crossover (auto-MDIX) for straight-through and crossover connections.
- Pause flow control as defined by the 802.3x standard.
- Frame size of 9216 bytes.
- Synchronous ENET operation that provides its recovered receive clock as an input clock source for the SETS as well as uses the system-wide reference clock to derive its transmit clock.

## GE SFP Ports

The GE SFP ports support the following features:

- 100Base-FX and 1000Base-X SFP modules.
- Copper SFP modules
- Digital optical monitoring as specified by the SFP.
- Any mix of SFPs is supported unless specifically noted.
- Pause flow control as defined by the 802.3x standard.
- Frame size of 9216 bytes.
- Synchronous ENET operation that provides its recovered receive clock as an input clock source for the SETS as well as uses the system-wide reference clock to derive its transmit clock.



---

**Note**

Copper based SFPs do not support synchronous ENET operations.

---

## SFP+ Ports

The SFP+ ports support the following features:

- Digital optical monitoring as specified by the optical transceiver module.
- Any mix of SFPs is supported unless specifically noted.
- Pause flow control as defined by the 802.3x standard.
- Frame size of 9216 bytes.

## Interface Modules

The Cisco ASR-920-24SZ-IM Router interface modules are field-replaceable units. In addition to the ports provided on an RSP, the Cisco ASR-920-24SZ-IM Router supports the interface modules.

### Gigabit Ethernet RJ45 Interface Module (A900-IMA8T)

The Gigabit Ethernet RJ45 interface module provides eight Gigabit Ethernet copper ports. The figure below shows the interface module.

**Figure 1: 8 x 1-Gigabit Ethernet RJ45 (Copper) Interface Module**

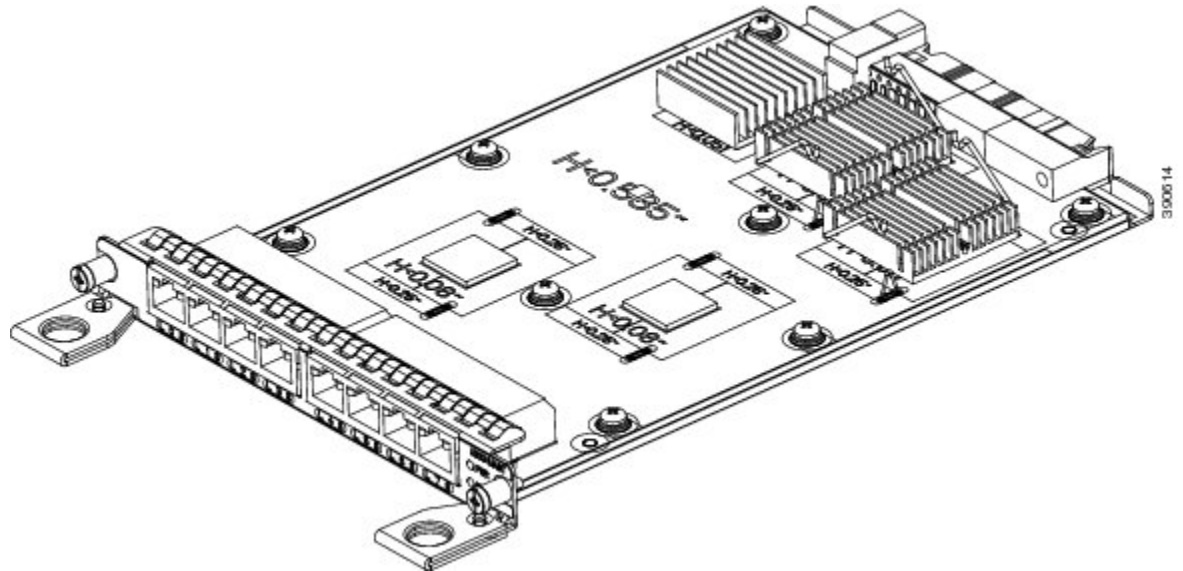

- For more information about installing an RJ45 Gigabit Ethernet module, see the *Installing the Interface Module* section.
- To determine interfaces available on the RJ45 Gigabit Ethernet module, see the *Interface Availability on Interface Modules* section.

## 10-Gigabit Ethernet XFP Interface Module (A900-IMA1X)

The 10-Gigabit Ethernet XFP interface module provides a single port supporting a 10-Gigabit Ethernet XFP module. The following figure shows the interface module.

**Figure 2: 1 x 10-Gigabit Ethernet XFP Interface Module**

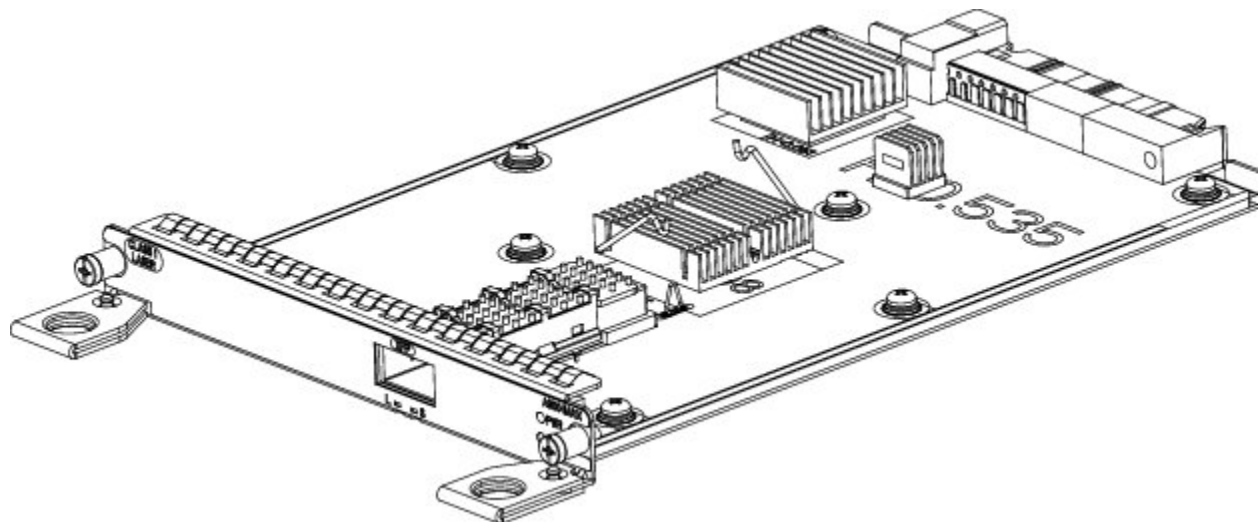

- For more information about installing a 10-Gigabit Ethernet XFP module, see the *Installing the Interface Module* section.

- To determine interfaces available on the 10-Gigabit Ethernet XFP module, see the *Interface Availability on Interface Modules* section.
- For information on supported SFPs, see the Cisco ASR 900 Series Aggregation Services Router Interface Modules Data Sheet at <http://www.cisco.com/c/en/us/products/routers/asr-903-series-aggregation-services-routers/datasheet-listing.html>.

## 2x1 10 Gigabit Ethernet SFP+ Interface Module (A900-IMA2Z)

The 2-port 10-Gigabit Ethernet interface module provides a dual port supporting a 10-Gigabit Ethernet SFP+ and XFP module.

**Figure 3: 2X10 Gigabit Ethernet Interface Module**

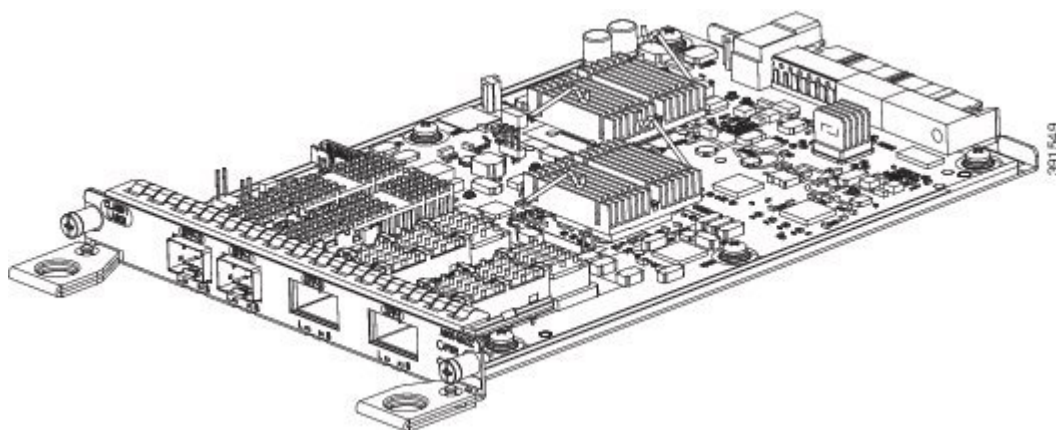

- For more information about installing the 2X10 GE SFP Gigabit Ethernet module, see the *Installing the Interface Module* section.
- To determine interfaces available on the 2X10 GE SFP Gigabit Ethernet module, see the *Interface Availability on Interface Modules* section.
- For information on supported SFPs, see the Cisco ASR 900 Series Aggregation Services Router Interface Modules Data Sheet at <http://www.cisco.com/c/en/us/products/routers/asr-903-series-aggregation-services-routers/datasheet-listing.html>.

## 8-Port 1 Gigabit Ethernet + 1-Port 10 Gigabit Ethernet SFP+ Combination Interface Module (A900-IMA8T1Z)

This 8-port 1 Gigabit Ethernet (RJ45 Copper) interface module with the 1-port 10 Gigabit Ethernet interface module is a high density combination interface module. This module supports 8 Gigabit Ethernet Copper ports and 1 10 Gigabit Ethernet SFP+ port.

**Figure 4: 8-port 1 GE (RJ45) + 1-port 10 GE SFP+ Interface Module**

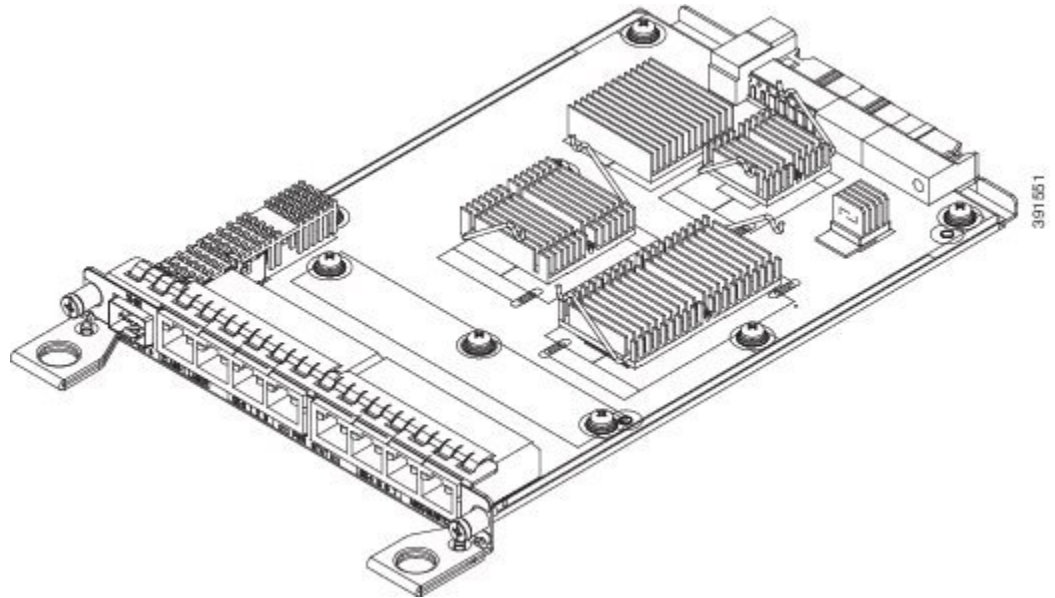

## 8 Port T1/E1 Interface Module (A900-IMA8D)

The 8T1/E1 interface module provides connectivity for up to 8 x T1/E1 ports through RJ48C connectors on the front panel. The following figure shows the interface module.

**Figure 5: 8 x T1/E1 Interface Module**

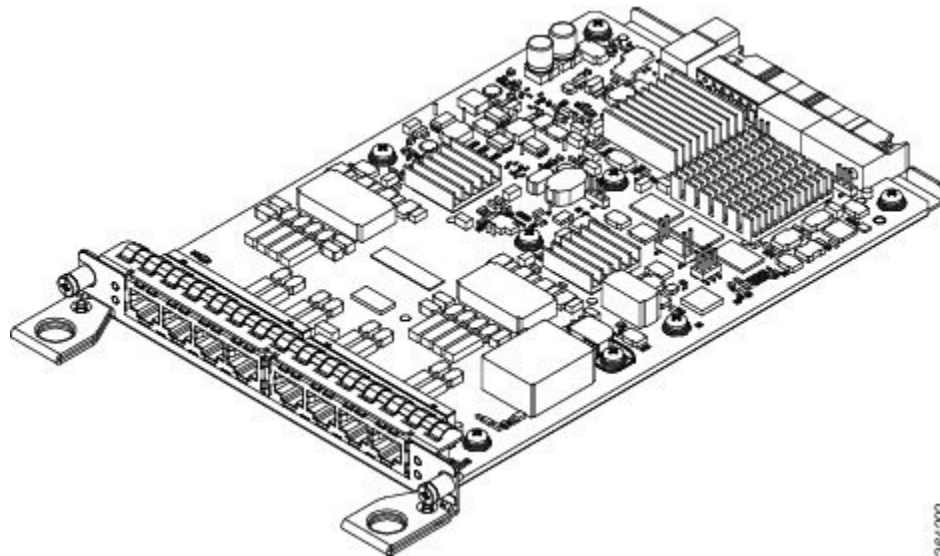

- For more information about installing a 8 Port T1/E1 interface module, see the *Installing the Interface Module* section.
- To determine interfaces available on the 8 Port T1/E1 interface module, see the *Interface Availability on Interface Modules* section.

- For LED indicator information on the 8 Port T1/E1 interface module, see the *8 T1/E1 Interface Module LEDs* section.
- For RJ45C pinout information on the 8 Port T1/E1 interface module, see the *RJ45C Port Pinouts* section.

## Interface Availability on Interface Modules



**Note** Cisco ASR-920-24SZ-IM Router does not support over-subscription mode. You must disable the ports as appropriate to restrict the system usage to 64 Gbps. Enabling all the interfaces in over-subscription mode can result in an unpredictable system performance.

The following table provides a snapshot of the interfaces available on supported interface modules:

**Table 2: Interface Availability on Supported Interface Modules**

Interface Module	Quantity	Interfaces in Resulting System	System Oversubscribed	Front Panel Ports Disabled				
	Cu	SFP	10GE	T1/E1	OC3/OC12	DS3/E3		
None	0	0	24	4	0	0	0	
A900-IMA8T	1	8	16	4	0	0	0	No 16 to 23
A900-IMA2Z	1	0	24	6	0	0	0	Yes
A900-IMA1X	1	0	24	5	0	0	0	Yes
A900-IMA8D	1	0	20	4	8	0	0	No 20 to 23

## Front and Back Panel

The following figures show the port numbering for the Cisco ASR-920-24SZ-IM Router:

Figure 6: Front Panel of Cisco ASR-920-24SZ-IM Router

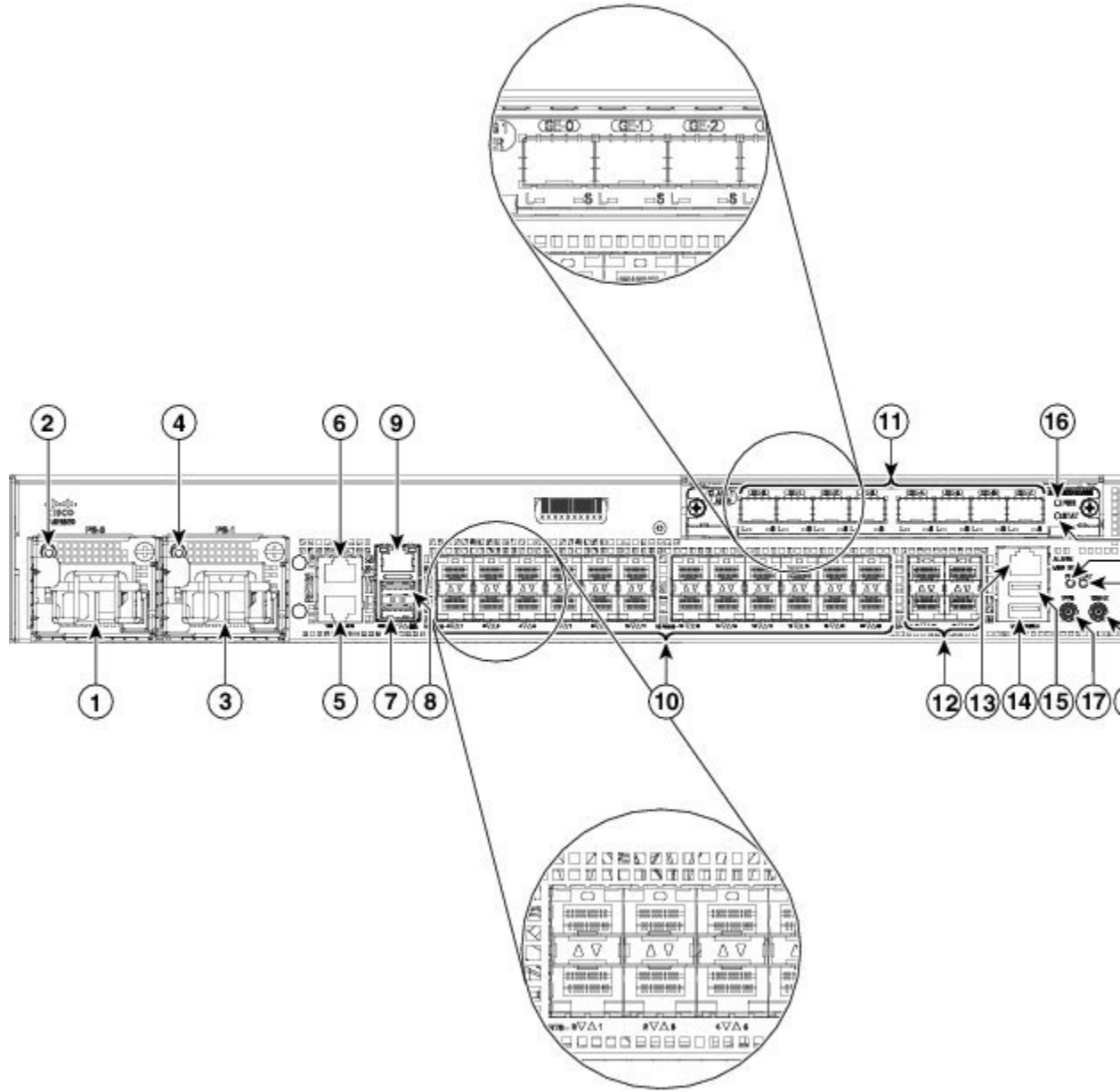

1	Power Supply 0 (AC or DC)	12	4x10GE SFP+
2	Power Supply 0 LED (AC or DC)	13	Alarm port
3	Power Supply 1 (AC or DC)	14	USB Console port
4	Power Supply 1 LED (AC or DC)	15	USB Memory port

5	RJ-48 slot for ToD	16	Interface Module (IM) power LED
6	RJ-48 slot for BITS	17	1 PPS co-axial connector
7	Console port (TIA/EIA-232F)	18	10 MHz co-axial connector
8	Auxiliary Console port	19	IM Status LED
9	Management port	20	System Status LED
10	24x1GE SFP Fiber ports <b>Note</b> Port 0 is located at the bottom left, port 1 is located at the top left, and so on.	21	Board power LED
11	Slot for ports on the interface module	-	-

Figure 7: Back Panel of Cisco ASR-920-24SZ-IM Router

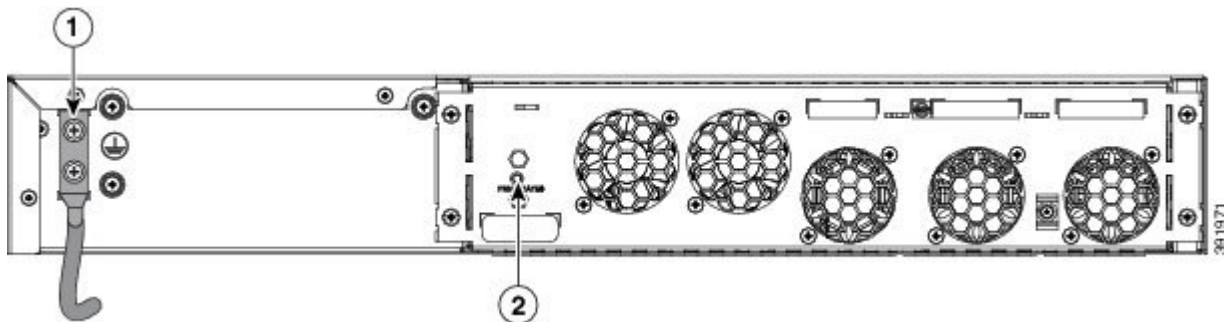

1	Grounding lugs	2	Fan status LED
---	----------------	---	----------------



Figure 8: Front Panel of Cisco ASR-920-24SZ-M, ASR-920-24TZ-M Router

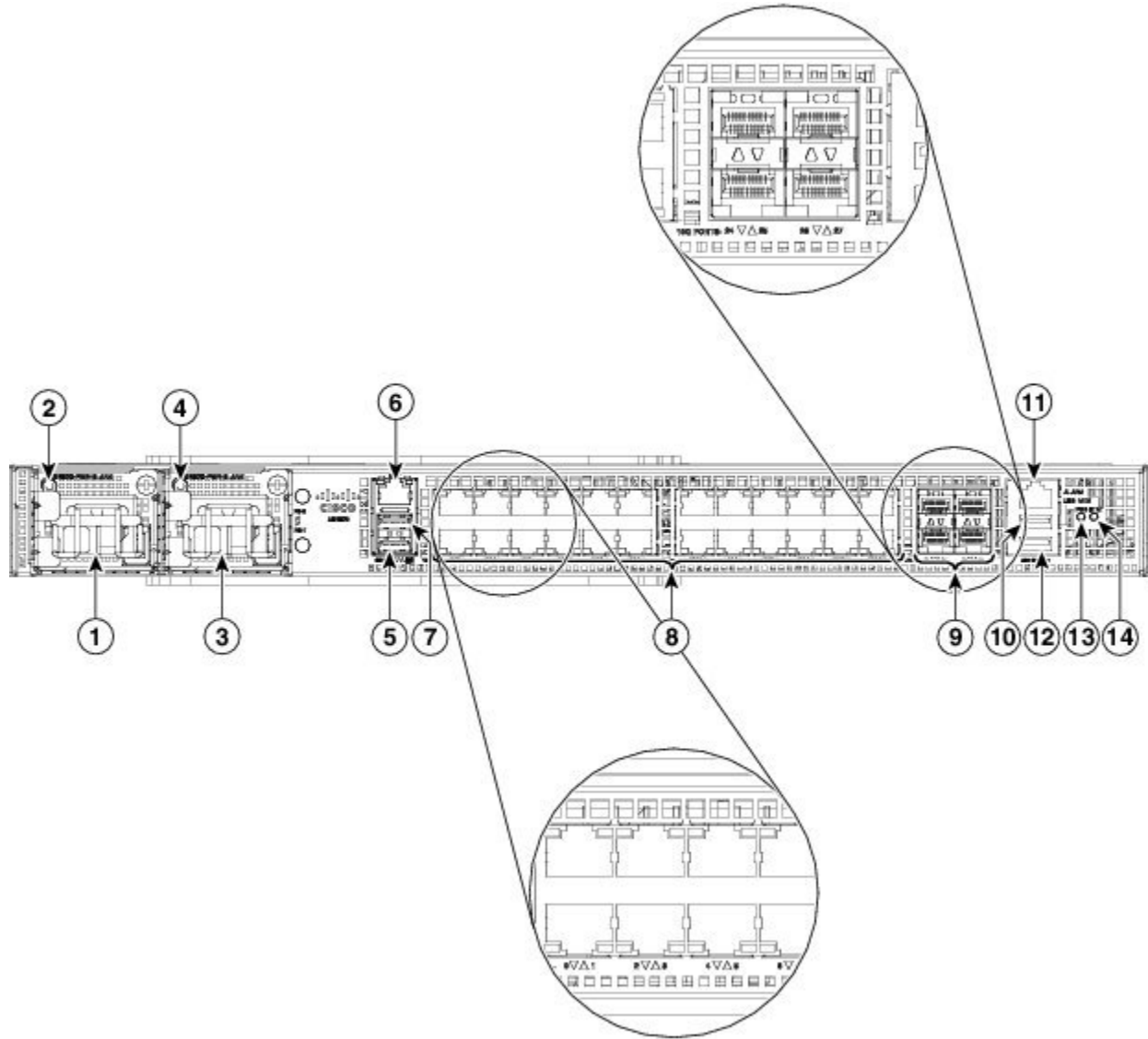

1	Power Supply 0 (AC or DC)	8	24x1GE SFP Fiber (Cisco ASR-920-24SZ-M) 24x1GE SFP Copper (Cisco ASR-920-24TZ-M)
2	Power Supply 0 LED (AC or DC)	9	4x10GE SFP+
3	Power Supply 1 (AC or DC)	10	USB Memory port
4	Power Supply 1 LED (AC or DC)	11	Alarm port
5	Console port (TIA/EIA-232F)	12	USB Console port

6	Management port	13	Board power LED
7	Auxiliary Console port	14	System Status LED

Figure 9: Back Panel of Cisco ASR-920-24SZ-M, ASR-920-24TZ-M Router

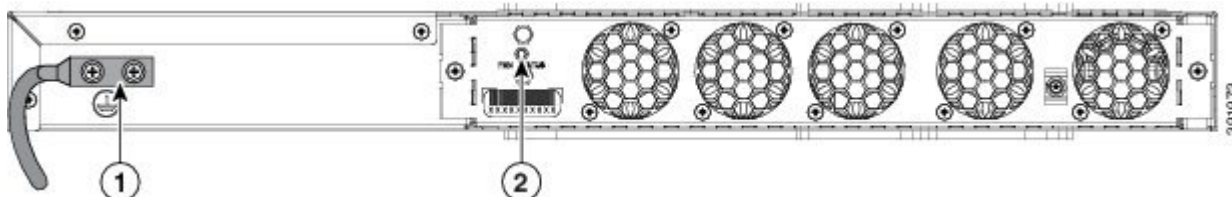

1	Grounding lugs	2	Fan status LED
---	----------------	---	----------------

## Specifications

The table below describes the other features of Cisco ASR-920-24SZ-IM Router (AC and DC) and Cisco ASR-920-24SZ-M, ASR-920-24TZ-M Router (AC and DC) Routers.

Table 3: Cisco ASR 920-24SZ-IM, ASR-920-24SZ-M, ASR-920-24TZ-M Router Specifications

Specification	ASR-920-24SZ-IM	ASR-920-24SZ-M, ASR-920-24TZ-M
DimensionWidth x Depth x Height	17.5 x 9.43 x 2.6 inches <b>Note</b> Dimensions exclude the PSU and IM handle.	17.5 x 9.43 x 1.72 inches <b>Note</b> Dimensions exclude the PSU and IM handle.
Weight	7.08 kg (inclusive of rack brackets, twenty-four SFP and four SFP+ optics, two AC PSUs and an IM card)	ASR-920-24SZ-M: 5.53 kg ASR-920-24TZ-M: 4.90 kg (inclusive of rack brackets, twenty-four SFP (only for ASR-920-24SZ-M) and four SFP+ optics and two AC PSUs)
Rack Unit	One and a half RU	One RU
Airflow	Front to back and side to back	Front to back
Cable access	Front cable access	Front cable access
System throughput	64 Gbps	64 Gbps
Modularity	Interface module	None
<b>Power Supply</b>		
Redundant	Yes	Yes
AC	Yes	Yes
Power Specification	250 W Maximum	250 W Maximum

Specification	ASR-920-24SZ-IM	ASR-920-24SZ-M, ASR-920-24TZ-M
DC	Yes	Yes
Power Specification	250 W Maximum	250 W Maximum
System Power Consumption	180 W Maximum, 130 W Typical (including installed IM)	ASR-920-24SZ-M: 145 W Maximum, 110 W Typical ASR-920-24TZ-M: 130 W Maximum, 100 W Typical
Power Dissipation	614.18 BTU/hr Maximum, 443.57 BTU/hr Typical (including installed IM)	ASR-920-24SZ-M: 494.76 BTU/hr Maximum, 375.33 BTU/hr Typical ASR-920-24TZ-M: Max: 443.57 BTU/hr Maximum, 341.21 BTU/hr Typical
Operating Temperature/Humidity	-40° C to 70° C 5-95% RH	-40° C to 70° C 5-95% RH
Alarms	<ul style="list-style-type: none"> <li>• 4 alarm dry contact inputs (normally open)</li> <li>• LED indicators for critical, major and minor alarms</li> </ul>	<ul style="list-style-type: none"> <li>• 4 alarm dry contact inputs (normally open)</li> <li>• LED indicators for critical, major and minor alarms</li> </ul>
TDM Support	Supported through IM card	None
Mounting option	<ul style="list-style-type: none"> <li>• Front or rear rail 19 inches or 23 inches</li> <li>• ETSI 300 mm cabinet</li> <li>• Wall Mount (with only side mount option).</li> </ul> <p><b>Note</b> For more information, see <i>Wall Mounting the Routers</i> section.</p>	<ul style="list-style-type: none"> <li>• Front or rear rail 19 inches or 23 inches</li> <li>• ETSI 300 mm cabinet</li> <li>• Wall Mount (with only side mount option).</li> </ul> <p><b>Note</b> For more information, see <i>Wall Mounting the Routers</i> section.</p>
Port Configuration	24x1G and 4x10G ports and IM card ports	24x1G and 4x10G ports
Port Numbering	24x1G SFP – Port [0:23] 4x10G SFP+ – Port [24:27]	24x1G SFP (Fiber) – Port [0:23](ASR-920-24SZ-M) 24x1G SFP (Copper) – Port [0:23](ASR-920-24TZ-M) 4x10G SFP+ – Port [24:27]
Combo Ports	No combo ports	No combo ports

Specification	ASR-920-24SZ-IM	ASR-920-24SZ-M, ASR-920-24TZ-M
LEDs	Data Port LEDs System Status LED Management Port LED PSU LED Fan Tray LED	System Status LED Management Port LED PSU LED Fan Tray LED
Temperature Sensors	Five temperature sensors for Board Two temperature sensors for each PSU	Five temperature sensors for Board Two temperature sensors for each PSU
Timing Interfaces	External ports for BITS/ToD SMA ports for 1 PPS and 10 M 1588v2 and SyncE feature supported	No external timing ports 1588v2 and SyncE feature supported

## External Interfaces

The Cisco ASR 920-24SZ-IM, ASR-920-24SZ-M, ASR-920-24TZ-M Router have these external physical interfaces on the front panel:

## Network Interfaces

The network interfaces are provided through fixed ports.

- GE SFP ports (fiber)—supports 100/1000 modes (ASR 920-24SZ-IM and ASR-920-24SZ-M)
- GE SFP ports (copper)—supports 10/100/1000 operation (ASR-920-24TZ-M)
- 10GE SFP+—supports 10G mode.

## Network Timing Interfaces



**Note** Network timing interface is available only on Cisco ASR-920-24SZ-IM Router.

- BITS input or output—The BITS interfaces support clock recovery from either a T1 at 1.544 MHz or an E1 at 2.048 MHz, configurable by software. BITS interface is provided through a standard RJ-48 connector on the front panel.
- 1PPS input or output and ToD input or output—This shielded RJ-45 interface is used for input or output of time-of-day (ToD) and 1PPS pulses. ToD format includes both NTP and IEEE 1588-2008 time formats.

The same RS422 pins for 1PPS and TOD are shared between input and output directions. The direction for each can be independently configurable through software.

- GPS 10 Mhz input and output—10 MHz input for GPS Synchronization. This connector on the front panel can provide 10MHz output as well from Cisco ASR-920-24SZ-IM Router. The direction can be configured using software.

- GPS 1 PPS input and output—1 PPS input for GPS Synchronization. This connector on the front panel can provide 1 PPS output as well from Cisco ASR-920-24SZ-IM Router. The direction can be configured using software.

## External Alarm Inputs

The Cisco ASR 920-24SZ-IM, ASR-920-24SZ-M, ASR-920-24TZ-M Router supports four dry contact alarm inputs through an RJ-45 jack on the front panel.

- Normally Open—indicates that no current flows through the alarm circuit and the alarm is generated when the current is flowing.

Each alarm input can be provisioned as critical, major, or minor.

## Management Interfaces

The Cisco ASR 920-24SZ-IM, ASR-920-24SZ-M, ASR-920-24TZ-M Router have the following management interfaces:

## Power Supply and Fans

The Cisco ASR 920-24SZ-IM, ASR-920-24SZ-M, ASR-920-24TZ-M Router support either AC or DC power supplies in a 1+1 redundant configuration. One AC and one DC power supply in the same router is also a supported configuration. The PSUs are hot-swappable. Load is shared between PSUs when both the PSUs are inserted and powered-up. Status LED provided on both AC and DC PSU indicates the status and output condition.

**Table 4: Power Supply Specification**

Specification	AC	DC
Voltage	100 V – 240 V, 50/60Hz	-48/-60 V or 24 V
Current	2.6 A through a standard C16 type receptacle	5.5 A –48/-60 V 11 A –24 V through a two-position terminal block
Input Power	260 W (ASR-920-PWR-A)	260 W (ASR-920-PWR-D)



**Note** DC PSU can be switched on or off using a switch on the front panel of the DC PSU.



**Note** For DC PSU, the UVP and OVP limits vary depending on the input voltage applied at power up: For -48/-60 V: UVP= -36 Vdc and OVP = -72 Vdc For 24 V: UVP =18 Vdc and OVP = 32 Vdc



**Note** This product requires surge protection as part of the building installation. To comply with the Telcordia GR-1089 NEBS standard for electromagnetic compatibility and safety, an external surge protective device (SPD) is required at the AC power service equipment.



**Note** For DC systems, if a surge of more than 1KV is expected, add an appropriate external surge protective device.

The Cisco ASR 920-24SZ-IM, ASR-920-24SZ-M, ASR-920-24TZ-M Router have removable fan tray as part of the system. The fan tray is hot-swappable. The system is designed to operate at its maximum operating temperature of 70° C and at 65° C in case of failure of a single fan, for a maximum of four hours.

## Check LED Indicators

This section describes the different types of front panel LEDs and their behavior.

### PWR and STAT LEDs

The PWR and STAT LEDs are available on the front panel. These LEDs provide power on the board (PWR) and overall router health (STAT) status. During power up state, these LEDs provide booting status and report errors.



**Note** The digital code signing functionality validates the integrity and authenticity of the ROMMON image before booting it.

**Table 5: PWR and STAT LED Indications**

PWR LED State	STAT LED state	Indication	Comment
Amber	Off	Power in the system is all right and FPGA configuration is taking place.	Permanent Amber/Off indicates FPGA configuration failure.
Amber	Red	FPGA Image Validation Error.	System is in unresponsive state. No console messages.
Flashing Amber and Green alternatively	Amber	Upgrade FPGA image error, continuing with Golden FPGA image.	—
Flashing Amber and Green alternatively	Off	FPGA configuration successful and Digital code signing successfully validated FPGA image. Digital code signing passed the control to Microloader to boot ROMMON.	—
Flashing Amber and Green alternatively	Red	Digital code signing reported failure in ROMMON image validation.	System is in unresponsive state. No console messages.
Green	Flashing Amber	ZTP process has begun.	Both LEDs turn Green once provisioning is complete.

PWR LED State	STAT LED state	Indication	Comment
Green	Off	IOS-XE image is booting.	
Green	Green	Successfully booted and system is operating normally.	—
Green	Amber	A minor alarm or synchronization is in Holdover or free-running mode	—
Green	Red	A major or critical alarm (high temperature reported for any sensor) or multiple fan failure.	—

### CPU Management Port LEDs

The LED for the 10/100/1000 Management port is integrated on the connector itself. There are two LEDs in the connector—the LED on the left indicates the Link/Activity status and the LED on the right indicates the duplex status of the link.

**Table 6: CPU Management Port LED Indication**

LED	LED State	Indication
Left	Green	Link up in 1000 Mbps
	Blinking Green	Activity in 1000 Mbps
	Amber/Orange	Link up in 100/10 Mbps
	Blinking Amber/Orange	Activity in 100/10 Mbps
	Off	Link down
Right	Green	Link up in full duplex
	Off	Link up in half duplex

### SFP LEDs

Each SFP port has an LED indicator. The LED is configured such that the up arrow indicates the port on the upside and the down arrow indicates the port on the downside.

**Table 7: SFP Port LED Indication**

LED	LED State	Indication
Labeled same as the SFP port number	Green	Link up in 1000Base-X/100Base-FX
	Blinking Green	Activity in 1000 Base-X/100Base-FX
	Yellow	Fault/Error
	Off	Link down

## SFP+ LEDs

Each SFP+ port has an LED indicator.

**Table 8: SFP+ Port LED Indication**

LED	LED State	Indication
Labeled same as the SFP port number	Green	Link up in 10G
	Blinking Green <sup>1</sup>	Activity in 10G
	Yellow	Fault/Error
	Off	Link down

<sup>1</sup> For A900-IMA8T1Z and A900-IMA2Z, LED status would be Green for Activity in 10G/1G port.

## 8 T1/E1 Interface Module LEDs

The table below summarizes the LEDs for the 8 x T1/E1 interface module.

**Table 9: 8 x T1/E1 Interface Module LEDs**

LED	LED State	Indication
Active	Green	Active
	Off	Operationally down; card is disabled or shot
Blinking green	All ports up and one or more ports in a loopback state	
Amber	One or more configured ports are down	
Blinking Amber	One or more configured ports are down and at least one configured port is in a loopback state	
Power	Green	All power rails are within supported range
	Red	Disabled
	Off	No power to the interface Module
Operating Status (STAT)	Red	Failed
	Off	Disabled or power down
	Blinking red	Booting
	Green	Active
Off	All ports are disabled or shut down	



## RJ-45 LEDs

Each RJ-45 port has two LED indicators. Left LED indicates the Link status; right LED indicates the status of the duplex LED.

**Table 10: RJ-45 LED Indication**

LED	LED State	Indication
Left	Green	Link up in 10/100/1000Base-T
	Blinking Green	Activity in 10/100/1000Base-T
	Yellow	Fault/Error/Link down
	Off	Administratively down
Right	Green	Link up in full duplex
	Off	Link up in half duplex

## Power Supply Unit LEDs

Each power supply unit has a corresponding LED on the front panel.

**Table 11: PSU LED Indication**

ID	LED State	Indication
CK	Green	Power Supply is working and 12V output is alright.
	Red	12V output failure (Either input not present or fault in the power supply unit).

## System-Interface LED Behavior

**Table 12: 1G Copper and 1G SFP LED Indication**

Event	1G Copper Port LEDs (Link/Duplex)	1G SFP Port LEDs
ROMMON	Off/Off	Off
IOS Shut	Off/Off	Off
IOS No shut (cable disconnect)	Yellow/Off	Yellow
IOS No shut (cable connect) (media-type RJ-45)	Green/Green	Off
IOS No shut (cable connect) (media-type SFP)	Off/Off	Green
IOS No shut (cable connect) (media-type auto)	Off/Off	Green

Table 13: Management Port LED Indication

Event	10G Port LEDs	Management Port LEDs (Link/Duplex)
ROMMON (cable connect)	Off	Green/Green (1000 Mbps, Full Duplex) Orange/Green (100/10 Mbps, Full Duplex)
ROMMON (cable disconnect)	Off	Off/Off
IOS Shut	Off	Off/Off
IOS No shut (cable disconnect)	Orange	Off/Off
IOS No shut (cable connect)	Green	Green/Green in 1G mode Orange/Green in 100/10M mode

## Fan Tray LEDs

Table 14: Fan Tray LEDs

Color/ State	Description
Off	System is not powered on
Green	All fans are working normally
Amber	Single or multiple fan failures and critical error
Off	ROMMON

## Online Insertion and Removal

The Cisco ASR 920-24SZ-IM, ASR-920-24SZ-M, ASR-920-24TZ-M Router supports the following OIR operations:

- When an SFP is removed, there is no effect on traffic flowing on other ports.
- When an SFP is installed, the system initializes that port for operation based upon the current configuration. If the inserted SFP is incompatible with the current configuration for that port, the port does not become operational until the configuration is updated.
- Both power supplies are installed and active and the load may be shared between them or a single PSU could support the whole load. When a power supply is not working or the input cable is removed, the remaining power supply takes the entire load without disruption.
- Except for TDM IM, you can hot-swap an interface module with a similar interface module on Cisco ASR-920-24SZ-IM Router. For more information, see *Hot-Swapping the Interface Module* section.
- When a fan tray is removed or replaced, there is no need to power down the router. However, when the fan tray is removed from chassis the router shuts down automatically after some time, depending on the ambient temperature. The time duration before the router shuts down is shown in the table below:

Table 15: Cisco ASR-920-24SZ-IM Router Shut Down Time Table

Sl.	Inlet Ambient Temperature (°Celsius)	Shut Down Time (Minimum)
1	-10 to -5	14 minutes
2	-4 to 15	8 minutes
3	16 to 29	6 minutes 30 seconds
4	30 to 40	4 minutes 30 seconds
5	41 to 44	3 minutes 20 seconds
6	45 to 49	2 minutes 50 seconds
7	50 to 54	2 minutes 10 seconds
8	55 to 59	1 minutes 35 seconds
9	60 to 64	1 minute
10	65 and above	35 seconds

## Licensing the Router

The Cisco ASR 920-24SZ-IM, ASR-920-24SZ-M, ASR-920-24TZ-M Router support the following types of licenses:

- Port Licensing—Port Upgrade license is available as a "Pay as you Grow" model.
  - 1G upgrade license
  - 10G upgrade license
- Bulk licensing—Bulk port licensing allows you to enable all the ports with a single license.
- Timing license (1588)—Timing license is required if the router is used as a master clock.
- Advanced Metro IP Access
- Metro IP Access
- Metro Access (default)

The following methods are used to activate the above licenses:

- Cisco Software Licensing—The Cisco Software License Activation feature is a set of processes and components to activate Cisco software feature sets by obtaining and validating fee-based Cisco software licenses.



---

**Note** Licenses generated by the Cisco Software Licensing are tied to the UDI of the chassis and a corresponding watchtower device certificate (WDC) is stored in the system.

---

- Cisco Smart Licensing—Smart Licensing is usage-based licensing where devices register with the Cisco Secure server.

