



Cisco 4G/3G Omnidirectional Dipole Antenna (4G-LTE-ANTM-D)

This document outlines the specifications, describes the Cisco 4G/3G Omnidirectional Dipole Antenna (4G-LTE-ANTM-D), and contains the following sections:

- [Overview, page 1](#)
- [Specifications, page 3](#)
- [System Requirements, page 9](#)
- [Installation Notes, page 9](#)
- [Safety Instructions, page 11](#)
- [Obtaining Documentation and Submitting a Service Request, page 11](#)

Overview

The 4G-LTE-ANTM-D omnidirectional dipole antenna is designed for indoor use with Cisco 4G and Cisco 3G wireless Integrated Services Routers Generation 2 (ISRs G2) and Enhanced High-Speed WAN Interface Cards (EHWICs).

The 4G-LTE-ANTM-D antenna is marked with a green band and the product ID (PID) to indicate that it supports 4G Long Term Evolution (LTE) networks. It has the following hardware features:

- **Articulating Joint**—It can be rotated 360 degrees and is capable of maneuvering into three stop positions: 0 degrees, 45 degrees, and 90 degrees.
- **Male threaded Neill-Concelman (TNC) Connector**—It lets you directly mount the antenna to any Cisco 4G and Cisco 3G wireless Integrated Services Router (ISR) EHWIC with a TNC connector ([Figure 1](#)). The threads on the connector must comply with the ANSI 7/16-28 UNEF 2B thread specification.



Figure 1 Cisco 4G-LTE-ANTM-D Omnidirectional Dipole Antenna, TNC Connector, and Articulation Joint

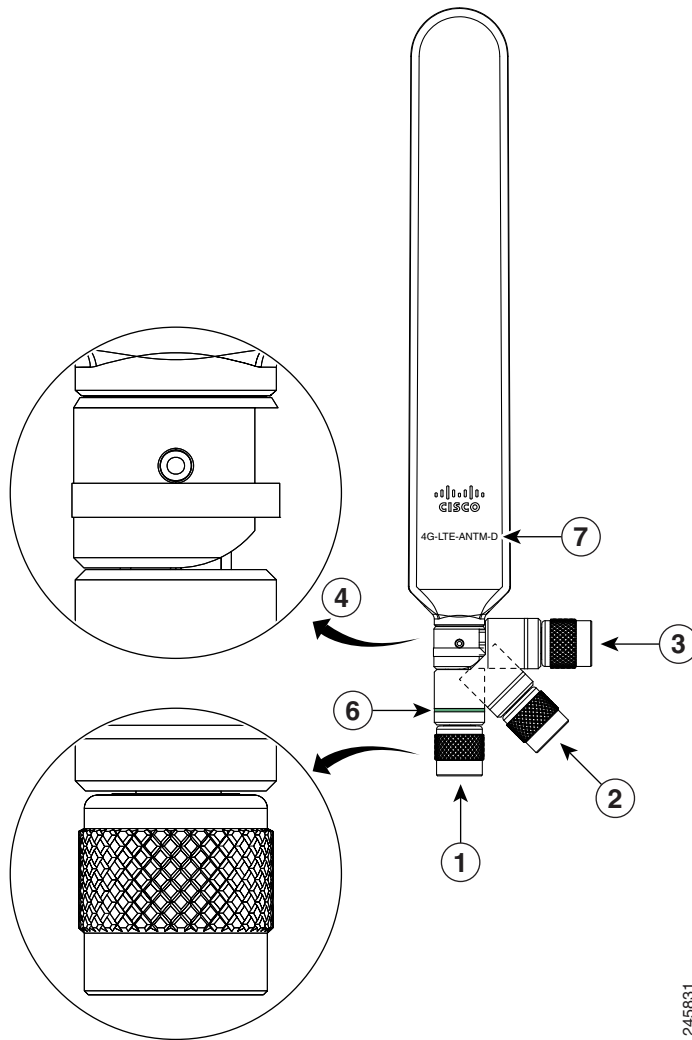

1	0 degree position	5	TNC connector
2	45 degree position	6	Green band
3	90 degree position	7	Product ID
4	Articulating joint		

Specifications

Table 1 **Specifications for Cisco 4G-LTE-ANTM-D Antenna**

Specification	Description
Maximum input power	3W
Connector	TNC male
VSWR ¹	2.5:1 or less
Characteristic impedance	50 ohm
Antenna base and radome color	Cisco Raven Black
Antenna dimensions	9 (L) x 1.2 (W) x 7/16 in (D) (229 x 30.5 x 11 mm)
Operating temperature	-22° to 158°F (-30° to 70°C)
Operating frequency ranges	<ul style="list-style-type: none"> • 698–806 MHz • 824–894 MHz • 925–960 MHz • 1710–1885 MHz • 1920–1980 MHz • 2110–2170 MHz • 2500–2690 MHz
Maximum Peak Gain	2 dBi

1. VSWR = voltage standing-wave ratio.

Figure 2 Elevation Cut (AMPS) Phi 0 Degree Plane for Cisco 4G-LTE-ANTM-D

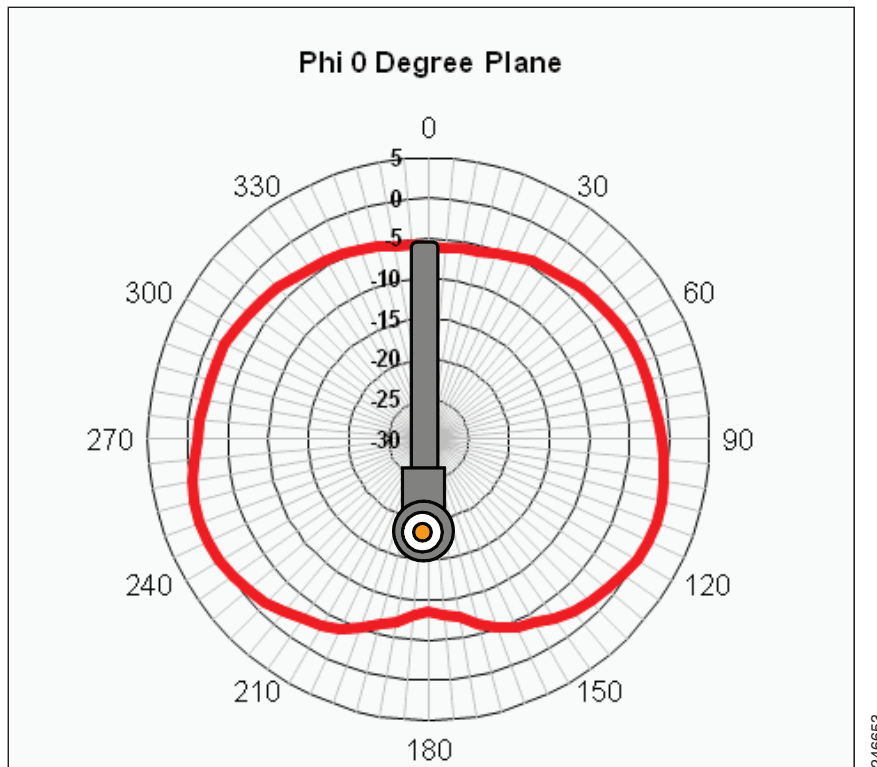

Figure 3 Elevation Cut (AMPS) Phi 90 Degree Plane for Cisco 4G-LTE-ANTM-D

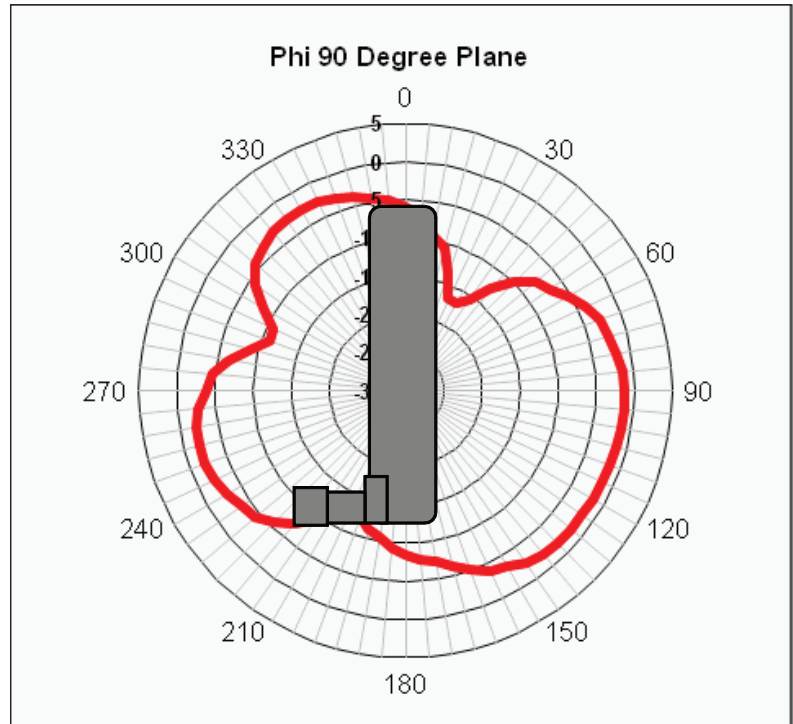

Figure 4 Azimuth Cut (AMPS) for Cisco 4G-LTE-ANTM-D

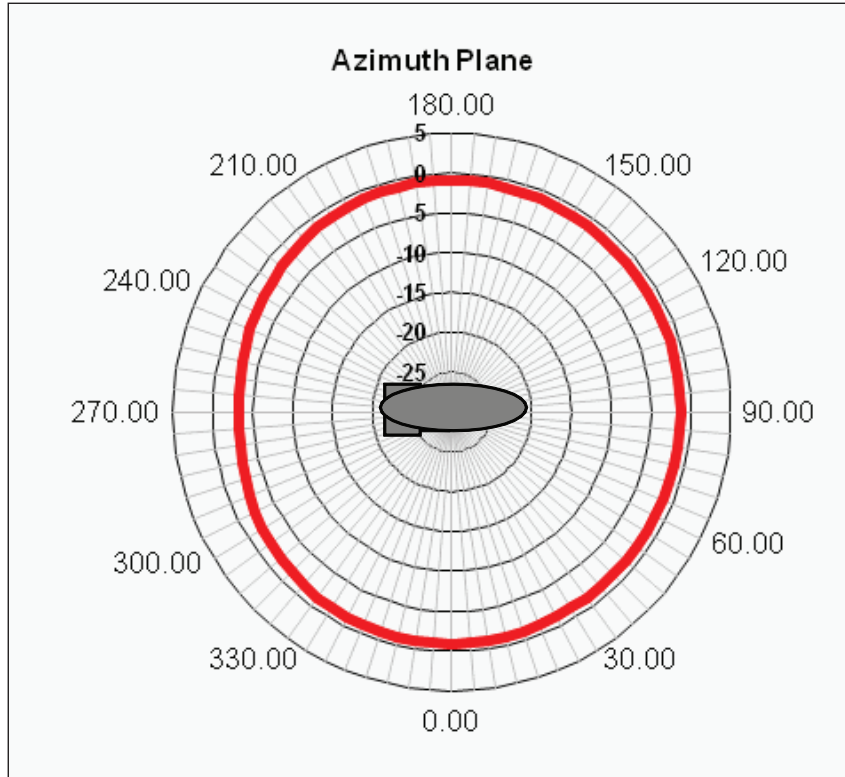
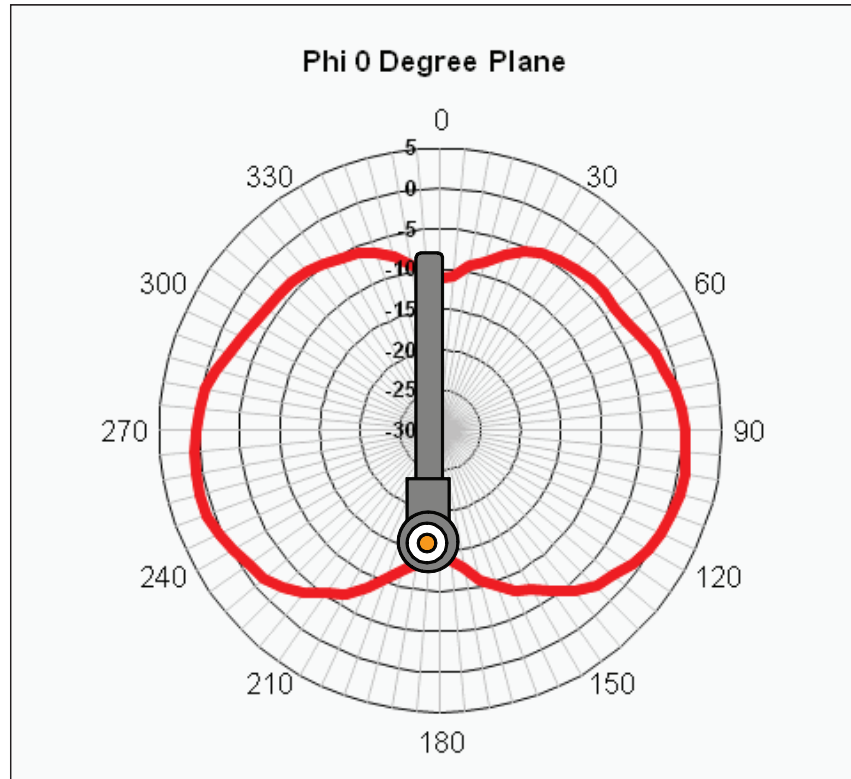
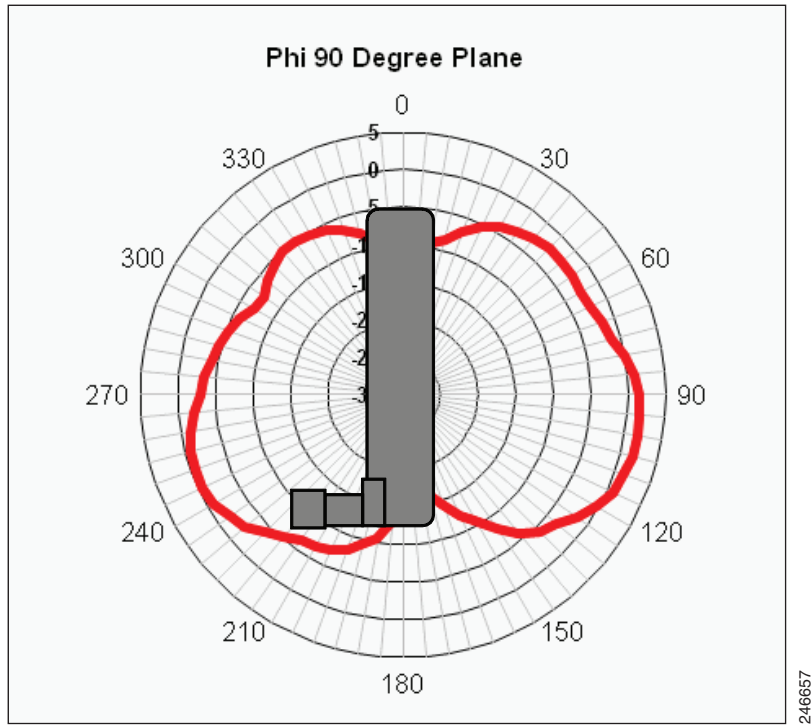

Figure 5 Elevation Cut (PCS) Phi 0 Degree Plane for Cisco 4G-LTE-ANTM-D



246656

Figure 6 Elevation Cut (PCS) Phi 90 Degree Plane for Cisco 4G-LTE-ANTM-D



246657

Figure 7 Azimuth Cut (PCS) for Cisco 4G-LTE-ANTM-D

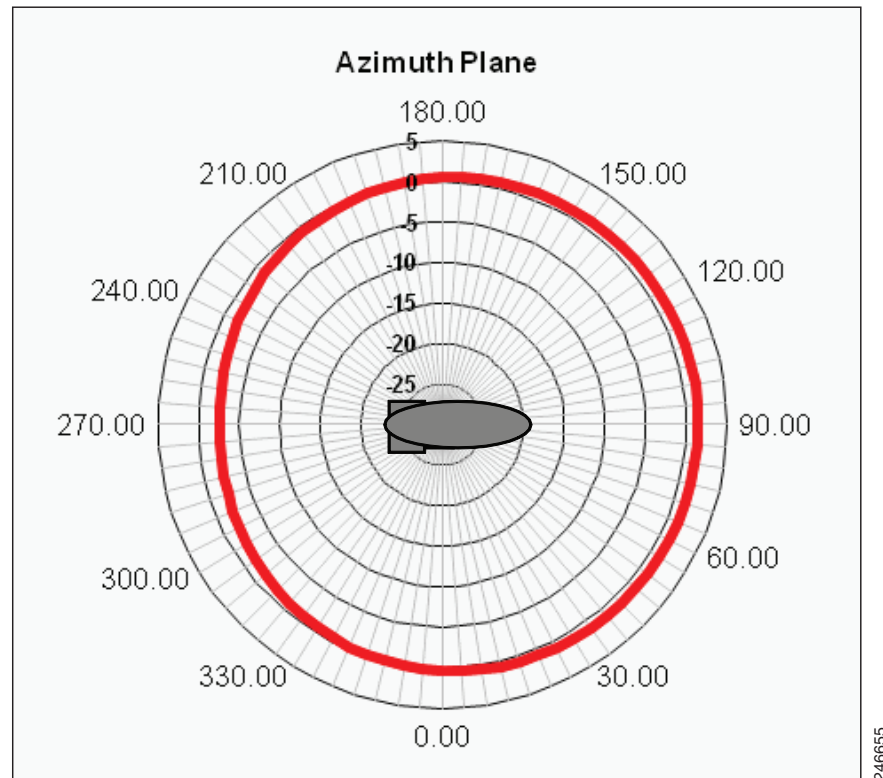

System Requirements

The Cisco 4G/3G omnidirectional dipole antenna is designed to be used with any Cisco 4G and Cisco 3G wireless ISRs G2 and EHWICs with a TNC antenna connector. The threads on this connector must comply with ANSI 7/16-28 UNEF 2B thread specification. The antenna is designed to be used only indoors.

Installation Notes

This antenna is designed to be mounted directly to any Cisco 4G and Cisco 3G wireless ISR and EHWIC with a TNC connector by simply threading it onto the mating connector. Mount and deploy the antenna at the 0-degree position, 45-degree position, or the 90-degree position, and then change that position at will. The rotation of the antenna into the proper position can take place while the antenna is still loose on the mating connector. No software is required for this installation.



Caution

Do not install this antenna in an outdoor environment.

In addition to the antenna orientation, the installation location of the wireless EHWIC plays a significant role in determining overall network performance with respect to all the wireless clients. Clients at the farthest coverage points might have 10 to 50 percent of the bandwidth available to clients close to the antenna. Wireless network coverage in one area or location might need to be lowered to improve the performance for clients in other areas or locations.

Because antennas both transmit and receive radio signals, their performance can be adversely affected by the surrounding environment, including physical obstructions or radio frequency (RF) interference.

Follow these guidelines to ensure the best possible performance:

- When used on an EHWIC, always mount the antenna on an appropriate extension cable and antenna stand. The antenna performance will not be optimal if mounted directly to an EHWIC. Mounting directly to a fixed router (without an EHWIC) is allowed.
- Space multiple antennas apart by at least 17 inches (43 cm). Interference may occur when placed closely together.
- Observe the radiation patterns in Figures 2 through 7 to position the antennas for best coverage.
- Wherever possible, mount the EHWIC and antenna where the wireless devices are within sight and without physical obstructions. Barriers along the line of sight between the device and the local base station will degrade the wireless radio signals. EHWICs and antennas should be installed above floor level in office environments or near the ceiling for better performance because most obstructions tend to be near floor level.
- The density of the materials used in a building's construction determines the number of walls the signal must pass through while still maintaining adequate coverage. Consider the following before choosing the location for installing your antenna:
 - Paper and vinyl walls have very little effect on signal penetration.
 - Solid and precast concrete walls limit signal penetration to one or two walls without degradation of coverage.
 - Concrete and wood block walls limit signal penetration to three or four walls.
 - A signal can penetrate five or six walls constructed of drywall or wood.
 - A thick metal wall or wire-mesh stucco wall causes signals to reflect back and causes poor penetration.
- Avoid mounting the antenna next to a column or vertical support that could create a shadow zone and reduce the coverage area.
- Keep the antenna away from reflective metal objects such as heating and air-conditioning ducts, large ceiling trusses, building superstructures, and major power cabling runs. If necessary, use an extension cable to relocate the antenna away from these obstructions.

**Caution**

Install the EHWIC and any antennas away from appliances that share the same frequency bands. Microwave ovens, cordless telephones, and security monitors can temporarily interfere with wireless performance.

**Caution**

We recommend avoiding installing wireless antennas in or near rack-mounted equipment that include networking equipment and computer servers whose radiated noise emissions can severely degrade radio performance.

**Note**

If the desired installation site has a marginally acceptable level of radiated noise emissions, consider using a remote-mounted antenna, such as a wall-mount or ceiling-mount antenna, for better radio performance and coverage.

Safety Instructions

Follow these safety instructions when installing your antenna.

**Warning**

In order to comply with FCC radio frequency (RF) exposure limits, antennas should be located at a minimum of 7.9 inches (20 cm) or more from the body of all persons. Statement 332

**Warning**

This equipment must be connected to an indoor antenna only. Statement 373

- Plan your installation procedure carefully and completely before you begin.
- If you are installing an antenna for the first time, for your own safety as well as that of others, *seek professional assistance*. Consult your dealer, who can explain which mounting method to use for the location where you intend to install the antenna.
- Choose your installation site with both safety and performance in mind.

**Caution**

Remember that electric power cables and telephone lines look alike. For your safety, assume that any line is an electric power line until determined otherwise.

- Call your local power company or building maintenance organization if you are unsure about cables close to your mounting location.
- When installing your antenna, *do not* use a metal ladder. *Do* dress properly: wear shoes with rubber soles and heels, rubber gloves, and a long-sleeved shirt or jacket.
- If an accident or emergency occurs with the power lines, call for qualified emergency help immediately.

Obtaining Documentation and Submitting a Service Request

For information on obtaining documentation, submitting a service request, and gathering additional information, see the monthly *What's New in Cisco Product Documentation*, which also lists all new and revised Cisco technical documentation.

Cisco and the Cisco logo are trademarks or registered trademarks of Cisco and/or its affiliates in the U.S. and other countries. To view a list of Cisco trademarks, go to this URL: www.cisco.com/go/trademarks. Third-party trademarks mentioned are the property of their respective owners. The use of the word partner does not imply a partnership relationship between Cisco and any other company. (1110R)

Any Internet Protocol (IP) addresses used in this document are not intended to be actual addresses. Any examples, command display output, and figures included in the document are shown for illustrative purposes only. Any use of actual IP addresses in illustrative content is unintentional and coincidental.

© 2011 Cisco Systems, Inc. All rights reserved.

