



Cisco 3G/4G LTE and LTEA Omnidirectional Dipole Antenna (LTE-ANTM-D)

First Published: 2017-02-17

Last Updated: 2017-12-05

This document provides the description, supported features, and installation instructions for the Cisco 3G/4G LTE and LTEA Omnidirectional Dipole Antenna (LTE-ANTM-D).

Caution: Read the information in [Safety Instructions, page 9](#) before installing or replacing antennas.

This document contains the following sections:

- [Overview, page 1](#)
- [Specifications, page 3](#)
- [Antenna Radiation Patterns, page 4](#)
- [Safety Instructions, page 9](#)
- [Installation Instructions, page 10](#)
- [Related Documentation, page 11](#)
- [Obtain Documentation and Submit a Service Request, page 11](#)

Overview

The LTE-ANTM-D omnidirectional dipole antenna is designed for indoor use with Cisco 4G Long Term Evolution (LTE) and Long Term Evolution Advanced (LTEA) Network Interface Modules (NIMs), 4G and 4G LTE Enhanced High-Speed WAN Interface Cards (EHWICs) as well as Cisco 4G and 3G Integrated Service Routers (ISRs).

The LTE-ANTM-D antenna is marked with a dual green band to indicate that it supports Cisco LTEA routers and modules.

This antenna has the following features:

- Support for frequencies of 698–960, 1448–1511, and 1710–2690 MHz.
- Standalone antenna peak gain of less than 3.7 dBi in the supported frequency bands.
- Articulating joint that can maneuver into three stop positions: 0°, 45°, and 90°.
- Male Threaded Neill-Concelman (TNC) connector that allows direct mounting of the antenna to any Cisco supported router with a female TNC connector.

For optimal performance, we strongly recommend that you use two antennas to take full advantage of MIMO technology on all Cisco cellular routers that support MIMO (4G LTE and later releases).

Figure 1 Cisco LTE-ANTM-D Omnidirectional Dipole Antenna, TNC Connector and Articulating Joint:

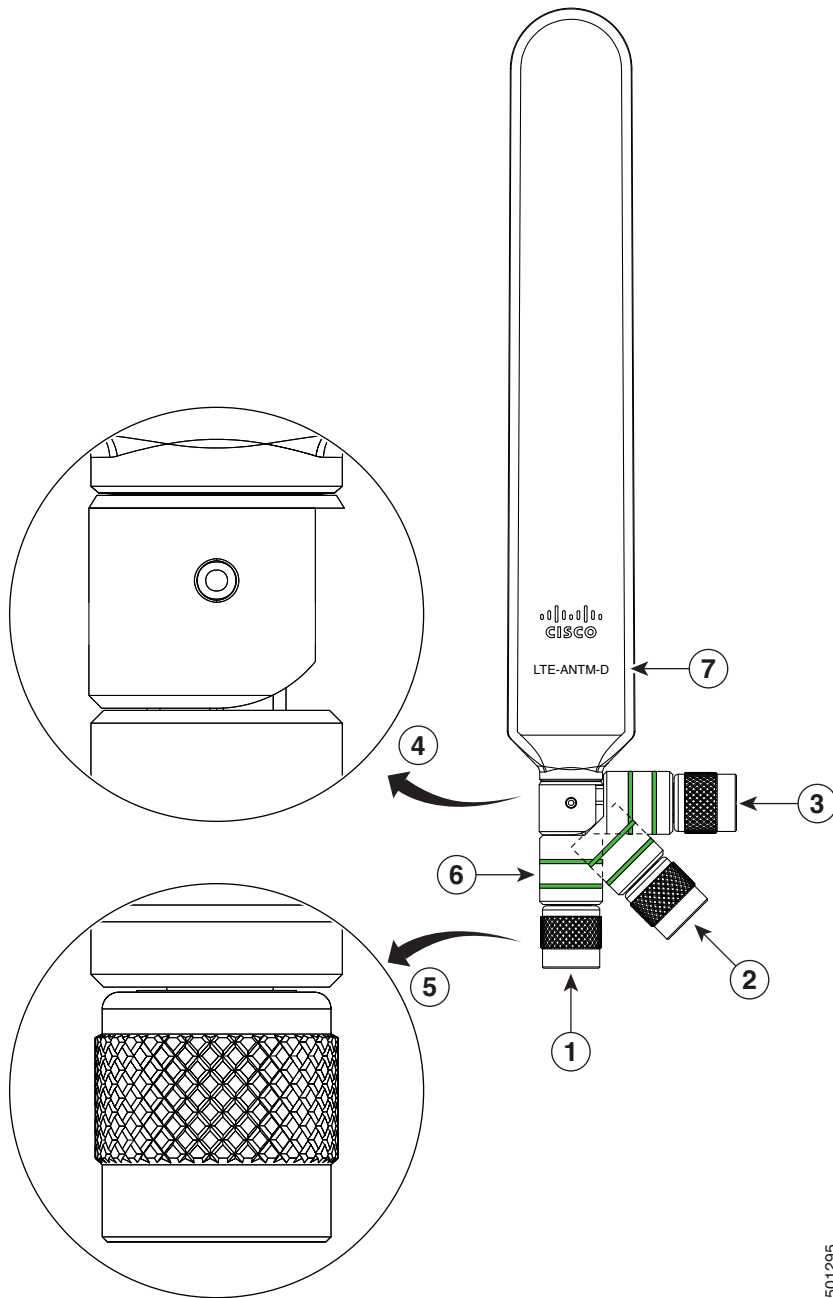

- 1 0° position
- 2 45° position
- 3 90° position
- 4 Articulating joint
- 5 TNC(m) connector
- 6 Dual green band
- 7 Product ID

501295

Specifications

Table 1 Specifications of the LTE-ANTM-D antenna:

Operating Frequencies	698-960 MHz 1447-1511 MHz 1710-2690 MHz
Polarization	Vertical, linear
Nominal Impedance	50 Ohms
Peak Gain	2.0 dBi (698-960 MHz) 2.8 dBi (1447-1511 MHz) 3.7 dBi (1710-2690 MHz) Note: The standalone antenna peak gain numbers are provided above. When you install an antenna close to metallic objects or directly on chassis, the peak gain will be affected. We recommend that you keep antennas away from very large chassis and metallic objects. You can install antennas directly on smaller or medium size chassis. In all cases, we recommend that you keep different antennas away from each other and from various known sources of electromagnetic radiation.
VSWR	≤ 2.5:1 (698-960 MHz) ≤ 2.5:1 (1447-1511 MHz) ≤ 2.0:1 (1710-2690 MHz)
Maximum RF Input Power	5 W
DC Power	No DC power required for LTE-ANTM-D antenna operation.
Dimensions	9" (L) x 1.46" (W) x 0.43" (D) (229 x 37 x 11 mm)
Weight	56.8 grams
Efficiency	LTE-ANTM-D antennas have high standalone efficiency, and maintain high efficiency when directly installed on front plate of a small or medium size Cisco router. However, depending on chassis size and a variety of other electromagnetic considerations, installing the antenna directly on the chassis is not always recommended.
Temperature Range	-30° C to + 70° C (Operating) -40° C to + 85° C (Storage)

Antenna Radiation Patterns

Figure 2 698, 824, 960 MHz Cellular Antenna Radiation Pattern (dBi), Azimuth

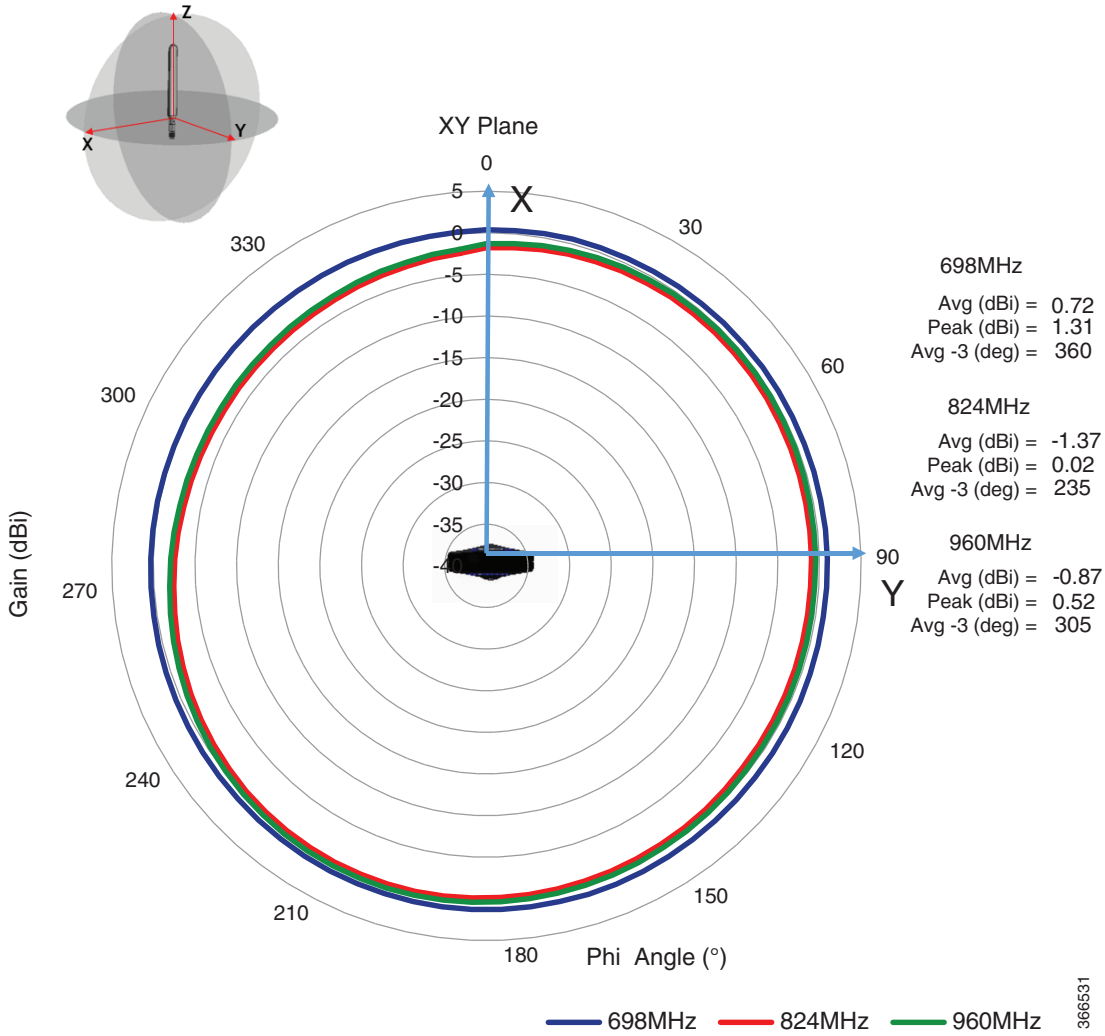

Figure 3 698, 824, 960 MHz Cellular Antenna Radiation Pattern (dBi), Elevation, Phi = 0

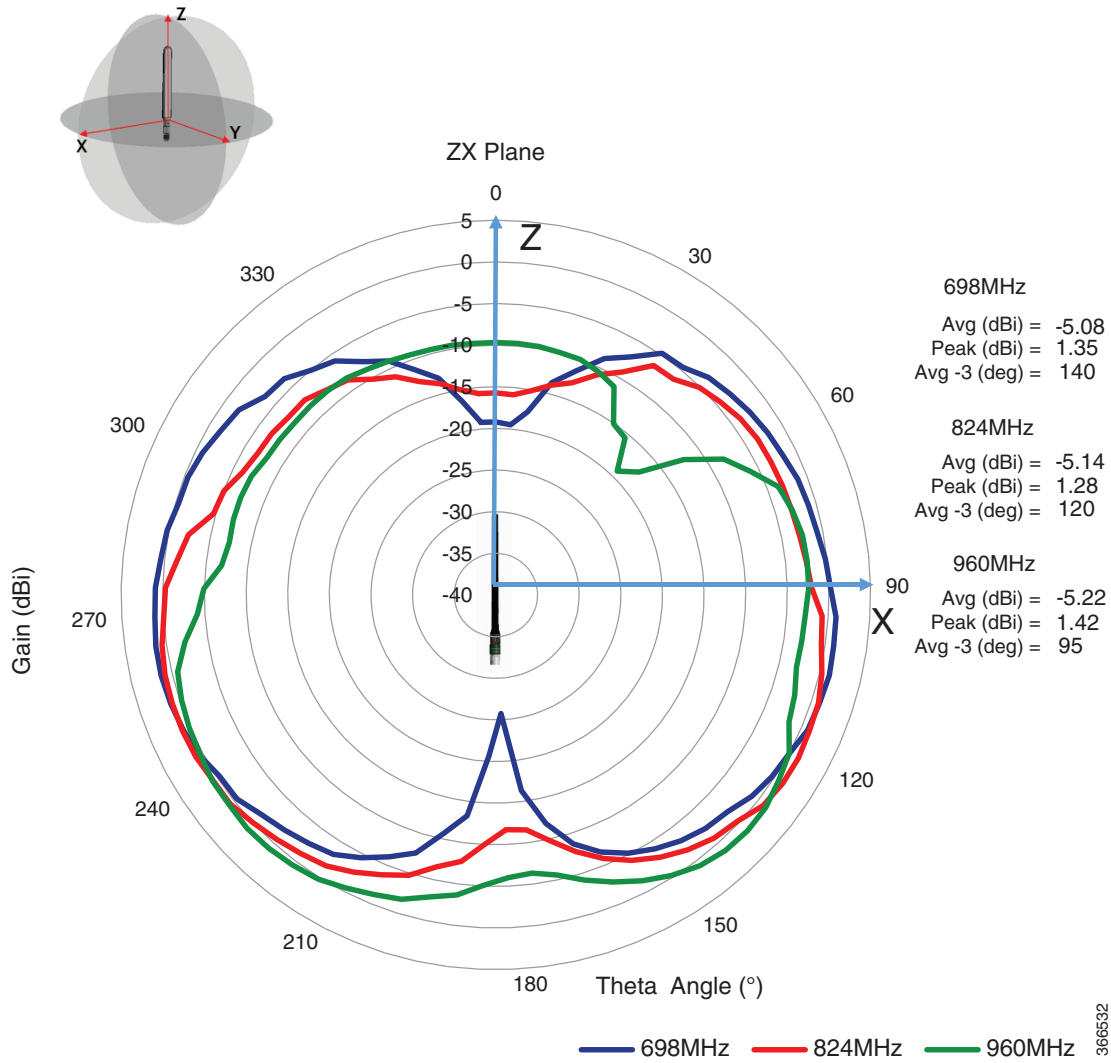

Figure 4 698, 824, 960 MHz Cellular Antenna Radiation Pattern (dBi), Elevation, Phi = 90

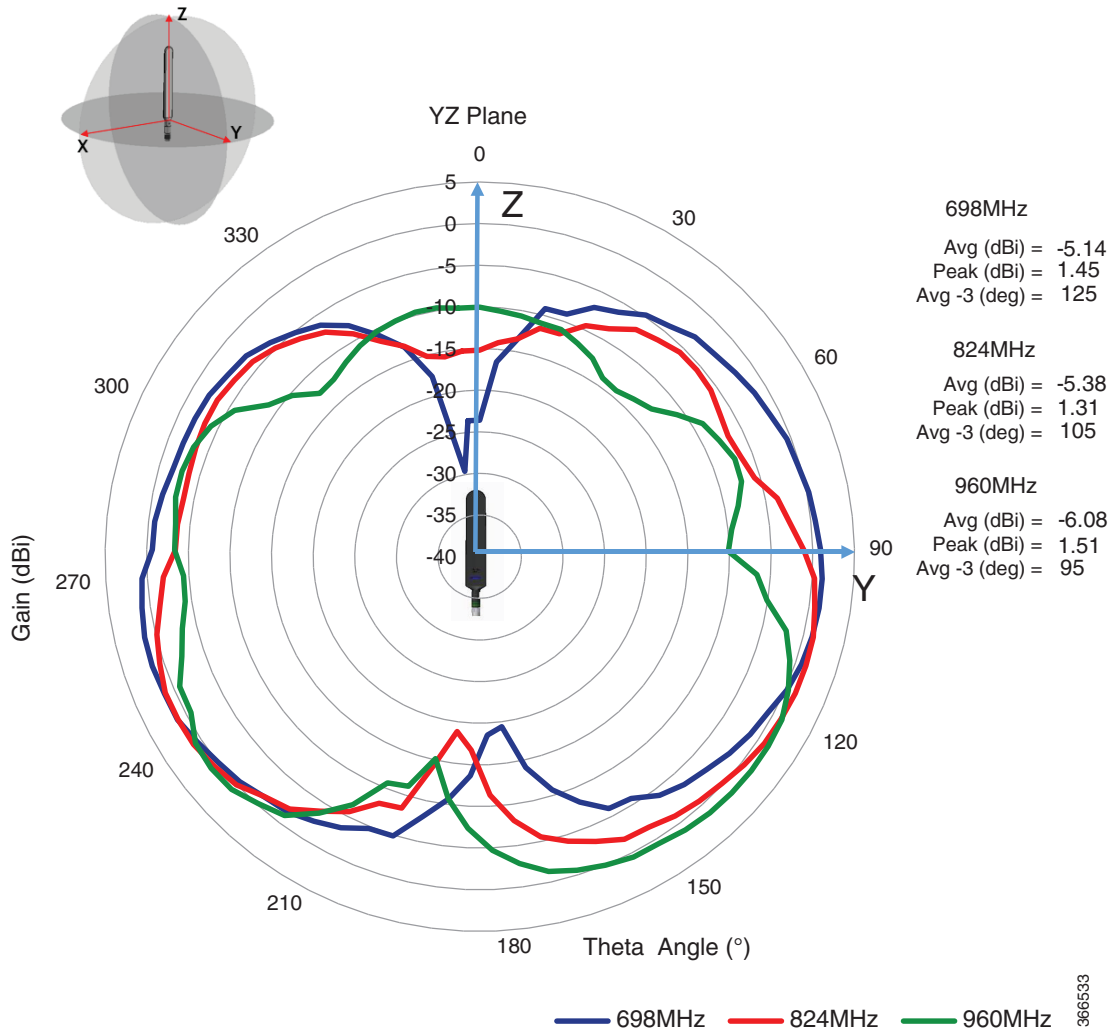
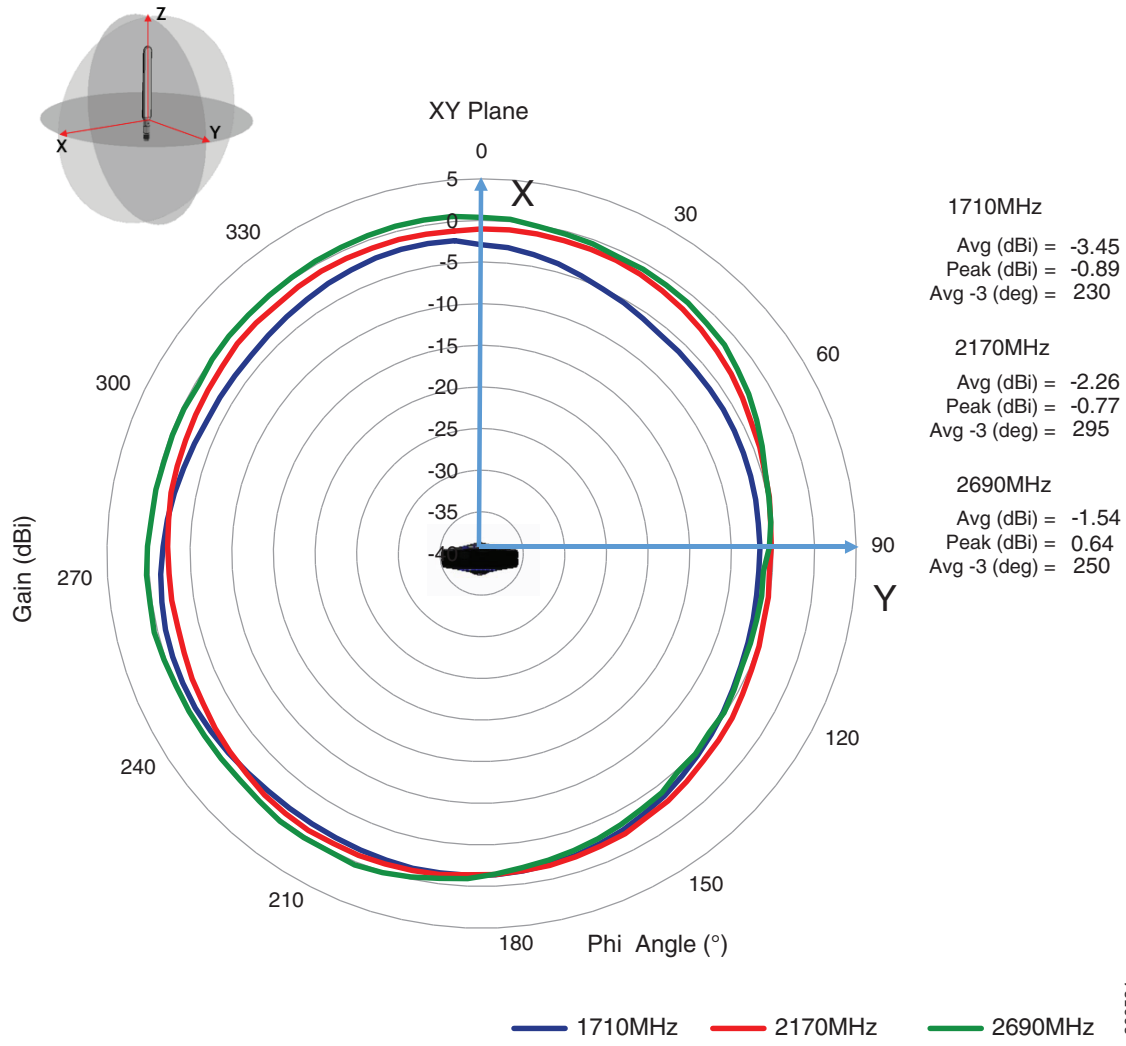

Figure 5 1710, 2170, 2690 MHz Antenna Radiation Pattern (dBi), Azimuth



366534

Figure 6 1710, 2170, 2690 MHz Antenna Radiation Pattern (dBi), Elevation, Phi = 0

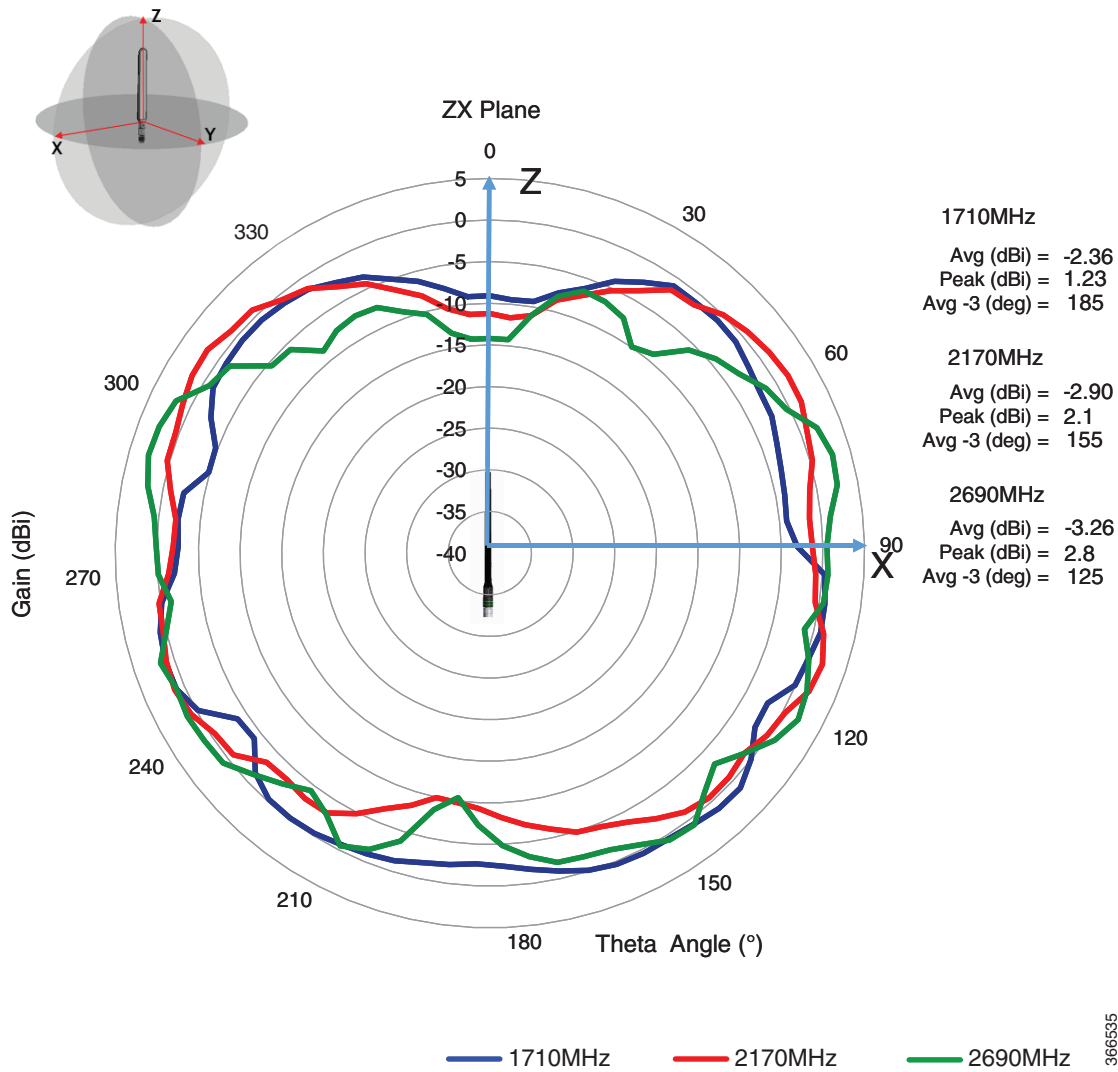
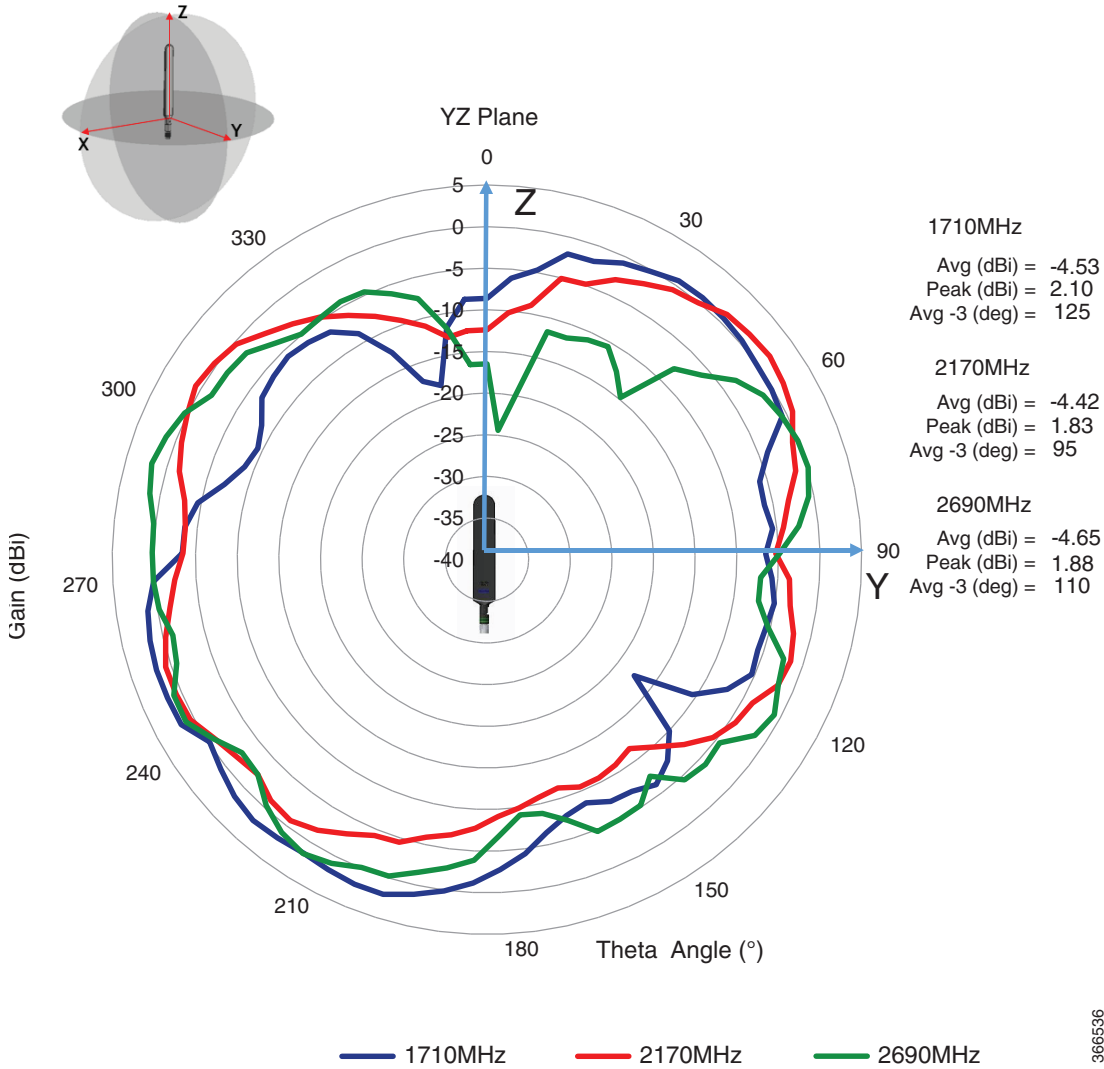

Figure 7 1710, 2170, 2690 MHz Antenna Radiation Pattern (dBi), Elevation, Phi = 90



Safety Instructions

Warning: IMPORTANT SAFETY INSTRUCTIONS

A warning means danger. You are in a situation that could cause bodily injury. Before you work on any equipment, be aware of the hazards involved with electrical circuitry and be familiar with standard practices for preventing accidents.

SAVE THESE INSTRUCTIONS

Follow these safety instructions when installing the antenna.

Antenna Installation Warning

Warning: In order to comply with FCC radio frequency (RF) exposure limits, antennas should be located at a minimum of 7.9 inches (20 cm) or more from the body of all persons.

Warning: When installing or replacing the unit, the ground connection must always be made first and disconnected last.

Caution: Do not install the antenna in an outdoor environment.

Caution: For your physical safety, and to help you install your antenna successfully, follow these safety precautions.

- Plan your installation procedure carefully and completely before you begin.
- Choose your installation site with both safety and performance in mind.
- If you are installing an antenna for the first time, for your own safety as well as others, seek professional assistance. Your Cisco sales representative can explain which mounting method to use for the size and type of antenna you are about to install.
- Before you install an antenna, contact your Cisco account representative to explain which mounting method to use for the size and type of antenna that you are about to install.

Installation Instructions

The following section contains information for installing the LTE-ANTM-D antenna:

This antenna is designed to be mounted either directly or on an antenna extension stand to any Cisco 3G/4G wireless ISR, LTE and LTEA NIMs and 3G/4G EHWICs with a TNC connector by threading it onto the mating connector. Refer to the routers technical documentation for recommendations of direct mounting of antenna to the router versus installing the antenna on an antenna extension stand. Mount and deploy the antenna at the 0° position, 45° position, or the 90° position, and then change that position at will. The rotation of the antenna into the proper position can take place while the antenna is still loose on the mating connector. No software is required for this installation.

In addition to the antenna orientation, the installation location of 4G routers wireless EHWIC plays a significant role in determining overall network performance. Routers located at the farthest coverage points might have 10 to 50 percent of the bandwidth available compared to routers located closer to the cellular base station tower.

Because antennas transmit and receive radio signals, their performance can be adversely affected by the surrounding environment, including physical obstructions. Radio frequency (RF) interference may occur between wireless systems located close to each other, especially if the antennas of these systems are located close to each other.

Follow these guidelines to ensure the best possible performance:

- When used on a modular router with an EHWIC or a NIM module, always mount the antenna on an appropriate extension cable and antenna stand. The antenna performance, and hence that of the router, will not be optimal if mounted directly to an EHWIC or NIM module.
- Mounting of the antenna directly to smaller physical size routers is allowed.
- For optimal performance, space multiple antennas apart by at least 17 inches (43 cm).
- Wherever possible, mount the EHWIC (or NIM) and antenna where the cellular base station or tower are within sight and without physical obstructions. Barriers along the line of sight between the device and the local base station will degrade the wireless radio signals. EHWICs, NIMs and antennas should be installed above floor level in office environments or near the ceiling for better performance because most obstructions tend to be near floor level.
- The density of the materials used in a building's construction determines the number of walls the signal must pass through while still maintaining adequate coverage. Consider the following before choosing the location for installing your antenna:
 - Paper and vinyl walls have very little effect on signal penetration.
 - Solid and precast concrete walls limit signal penetration to one or two walls without degradation of coverage.
 - Concrete and wood block walls limit signal penetration to three or four walls.
 - A signal can penetrate five or six walls constructed of drywall or wood.

Obtain Documentation and Submit a Service Request

- A thick metal wall or wire-mesh stucco wall causes signals to reflect back and causes poor penetration.
- Avoid mounting the antenna next to a column or vertical support that could create a shadow zone and reduce the coverage area.
- Keep the antenna away from reflective metal objects such as heating and air-conditioning ducts, large ceiling trusses, building superstructures, and major power cabling runs. If necessary, use an extension cable to relocate the antenna away from these obstructions.

Related Documentation

- For information about antennas and modules, see:
<http://www.cisco.com/go/cg-modules>
- For information about omnidirectional and directional antennas, see:
http://www.cisco.com/en/US/tech/tk722/tk809/technologies_tech_note09186a00807f34d3.shtml

Obtain Documentation and Submit a Service Request

For information on obtaining documentation, using the Cisco Bug Search Tool (BST), submitting a service request, and gathering additional information, see [What's New in Cisco Product Documentation](#).

To receive new and revised Cisco technical content directly to your desktop, you can subscribe to the [What's New in Cisco Product Documentation RSS feed](#). The RSS feeds are a free service.

Cisco and the Cisco logo are trademarks or registered trademarks of Cisco and/or its affiliates in the U.S. and other countries. To view a list of Cisco trademarks, go to this URL: www.cisco.com/go/trademarks. Third-party trademarks mentioned are the property of their respective owners. The use of the word partner does not imply a partnership relationship between Cisco and any other company. (1721R)

Any Internet Protocol (IP) addresses used in this document are not intended to be actual addresses. Any examples, command display output, and figures included in the document are shown for illustrative purposes only. Any use of actual IP addresses in illustrative content is unintentional and coincidental.

© 2017 Cisco Systems, Inc. All rights reserved.

Obtain Documentation and Submit a Service Request