



SDH Topologies

This chapter explains Cisco ONS 15454 SDH topologies. To provision topologies, refer to the *Cisco ONS 15454 SDH Procedure Guide*.

Chapter topics include:

- [11.1 SDH Rings and TCC2 Cards, page 11-2](#)
- [11.2 Multiplex Section-Shared Protection Rings, page 11-2](#)
- [11.3 Subnetwork Connection Protection, page 11-13](#)
- [11.4 SNCP Dual Ring Interconnect, page 11-18](#)
- [11.5 Subtending Rings, page 11-21](#)
- [11.6 Linear ADM Configurations, page 11-23](#)
- [11.7 Extended SNCP Mesh Networks, page 11-23](#)
- [11.8 Four Node Configurations, page 11-25](#)
- [11.9 STM-N Speed Upgrades, page 11-25](#)

11.1 SDH Rings and TCC2 Cards

Table 11-1 shows the SDH rings that can be created on each ONS 15454 SDH node using redundant TCC2 cards.

Table 11-1 ONS 15454 SDH Rings with Redundant TCC2 Cards

Ring Type	Maximum Rings per Node
MS-SPRings ¹	5
2-Fiber MS-SPRings	5
4-Fiber MS-SPRings	1
SNCP with SDCC	34 ² 3
SNCP with LDCC	14 ⁴ 5
SNCP with LDCC and SDCC	26 ⁶

1. MS-SPRing = multiplex section-shared protection ring
2. Total SDCC usage must be equal to or less than 68 SDCCs.
3. See the “[11.3 Subnetwork Connection Protection](#)” section on page 11-13.
4. Total LDCC usage must be equal to or less than 28 LDCCs.
5. See the “[11.3 Subnetwork Connection Protection](#)” section on page 11-13.
6. Total LDCC and SDCC usage must be equal to or less than 73. When LDCC is provisioned, an SDCC termination is allowed on the same port, but is not recommended. Using SDCC and LDCC on the same port is only needed during a software upgrade if the other end of the link does not support LDCC. You can provision SDCCs and LDCCs on different ports in the same node.

11.2 Multiplex Section-Shared Protection Rings

There are two types of MS-SPRings: two-fiber and four-fiber. Two-fiber MS-SPRings share service and protection equally, but only two physical fibers are required. For more information, see the “[11.2.1 Two-Fiber MS-SPRings](#)” section on page 11-3. With four-fiber MS-SPRings, the nodes on both sides of the failed span perform a span switch and use the second pair of fibers as the new working route. For more information, see the “[11.2.2 Four-Fiber MS-SPRings](#)” section on page 11-5.

The ONS 15454 SDH can support five concurrent MS-SPRings in one of the following configurations:

- Five two-fiber MS-SPRings
- Four two-fiber and one four-fiber MS-SPRings

Each MS-SPRing can have up to 32 ONS 15454 SDH nodes. Because the working and protect bandwidths must be equal, you can create only STM-4 (two-fiber only), STM-16, or STM-64 MS-SPRings. For information about MS-SPRing protection channels, see the “[10.8 MS-SPRing Protection Channel Access Circuits](#)” section on page 10-13.



Note MS-SPRings with 16 or fewer nodes have a switch time of 50ms. MS-SPRings with 16 or more nodes have a switch time of 100 ms.

**Note**

For best performance, MS-SPRings should have one LAN connection for every ten nodes in the MS-SPRing.

11.2.1 Two-Fiber MS-SPRings

In two-fiber MS-SPRings, each fiber is divided into working and protect bandwidths. For example, in an STM-16 MS-SPRing (Figure 11-1), VC4s 1 to 8 carry the working traffic, and VC4s 9 to 16 are reserved for protection. Working traffic (VC4s 1 to 8) travels in one direction on one fiber and in the opposite direction on the second fiber. The Cisco Transport Controller (CTC) circuit routing routines calculate the “shortest path” for circuits based on many factors, including user requirements, traffic patterns, and distance. For example, in Figure 11-1, circuits going from Node 0 to Node 1 typically travel on Fiber 1, unless that fiber is full, in which case circuits are routed on Fiber 2 through Node 3 and Node 2. Traffic from Node 0 to Node 2 (or Node 1 to Node 3), can be routed on either fiber, depending on circuit provisioning requirements and traffic loads.

Figure 11-1 Four-Node, Two-Fiber MS-SPRing

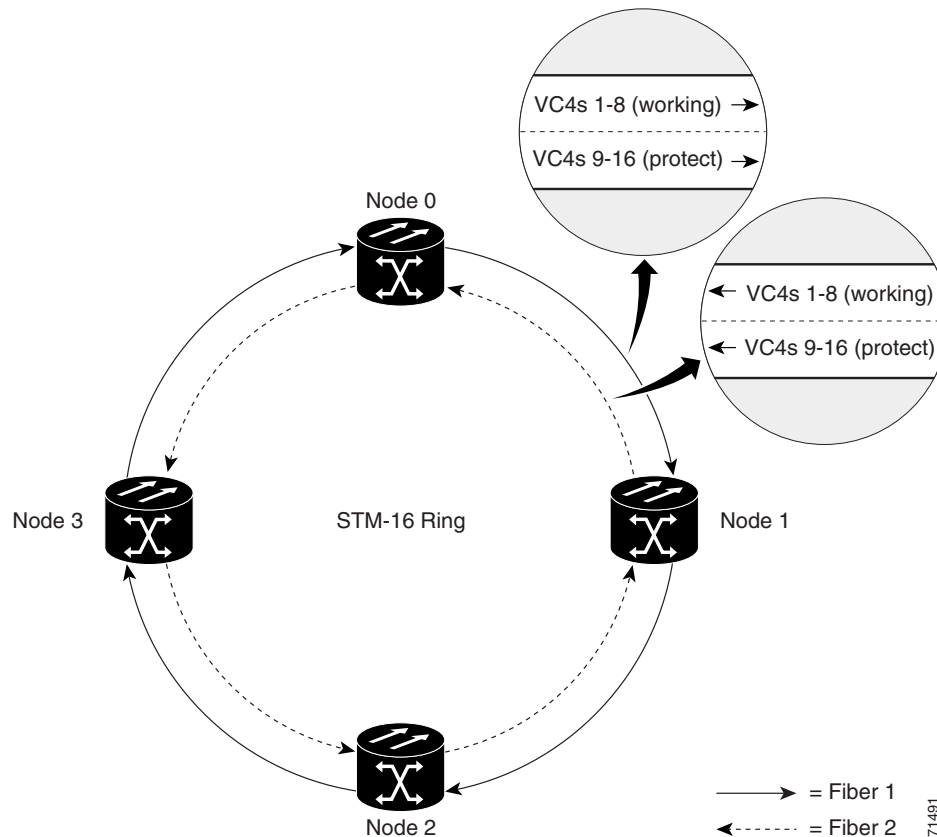

The SDH K1, K2, and K3 bytes carry the information that governs MS-SPRing protection switches. Each MS-SPRing node monitors the K bytes to determine when to switch the SDH signal to an alternate physical path. The K bytes communicate failure conditions and actions taken between nodes in the ring.

If a break occurs on one fiber, working traffic targeted for a node beyond the break switches to the protect bandwidth on the second fiber. The traffic travels in a reverse direction on the protect bandwidth until it reaches its destination node. At that point, traffic is switched back to the working bandwidth.

Figure 11-2 shows a sample traffic pattern on a four-node, two-fiber MS-SPRing.

Figure 11-2 Four-Node, Two-Fiber MS-SPRing Traffic Pattern

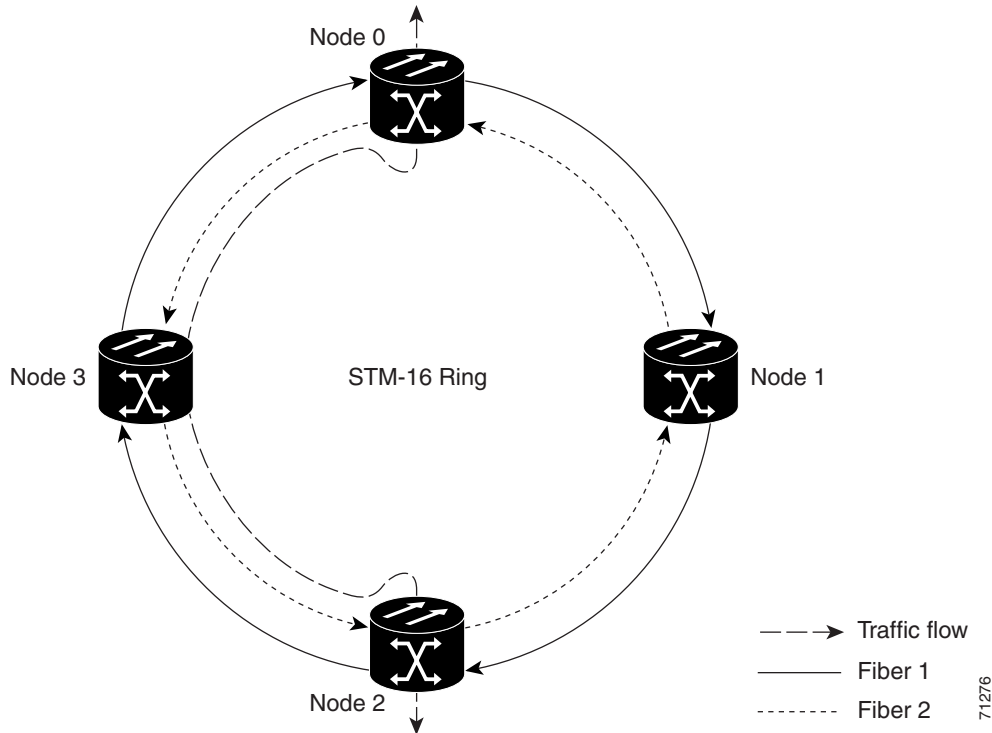
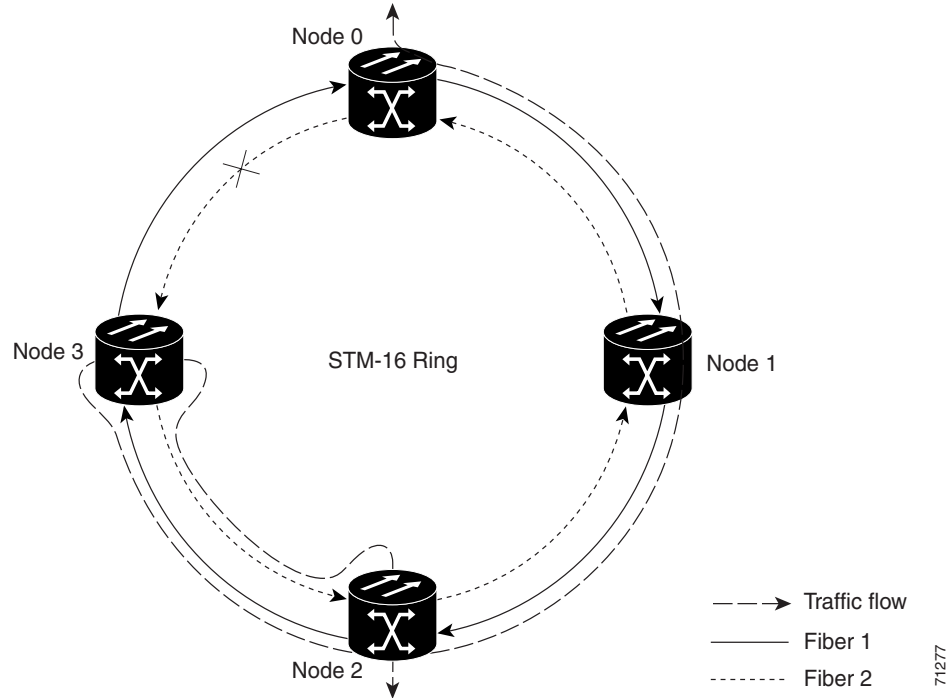

Figure 11-3 shows how traffic is rerouted after a line break between Node 0 and Node 3.

- All circuits originating on Node 0 and carried to Node 2 on Fiber 2 are switched to the protect bandwidth of Fiber 1. For example, a circuit carried on VC4-1 on Fiber 2 is switched to VC4-9 on Fiber 1. A circuit carried on VC4-2 on Fiber 2 is switched to VC4-10 on Fiber 1. Fiber 1 carries the circuit to Node 3 (the original routing destination). Node 3 switches the circuit back to VC4-1 on Fiber 2 where it is routed to Node 2 on VC4-1.
- Circuits originating on Node 2 that were normally carried to Node 0 on Fiber 1 are switched to the protect bandwidth of Fiber 2 at Node 3. For example, a circuit carried on VC4-2 on Fiber 1 is switched to VC4-10 on Fiber 2. Fiber 2 carries the circuit to Node 0 where the circuit is switched back to VC4-2 on Fiber 1 and then dropped to its destination.

Figure 11-3 Four-Node, Two-Fiber MS-SPRing Traffic Pattern After Line Break



11.2.2 Four-Fiber MS-SPRings

Four-fiber MS-SPRings double the bandwidth of two-fiber MS-SPRings. Because they allow span switching as well as ring switching, four-fiber MS-SPRings increase the reliability and flexibility of traffic protection. Two fibers are allocated for working traffic and two fibers for protection, as shown in [Figure 11-4](#). To implement a four-fiber MS-SPRing, you must install four STM-16 cards or four STM-64 cards at each MS-SPRing node.

Figure 11-4 Four-Node, Four-Fiber MS-SPRing

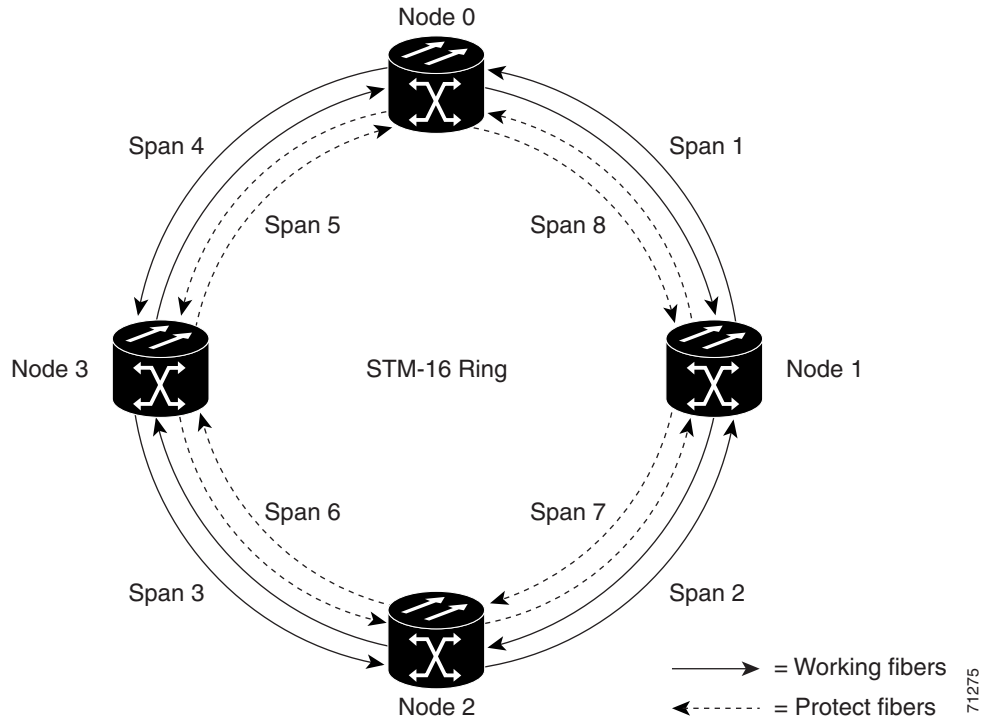

Four-fiber MS-SPRings provide span and ring switching.

Span switching occurs when a working span fails (Figure 11-5). Traffic switches to the protect fibers between the nodes (Node 0 and Node 1 in the Figure 11-5 example) and then returns to the working fibers that did not fail. Multiple span switches can occur at the same time.

Figure 11-5 Four-Fiber MS-SPRing Span Switch

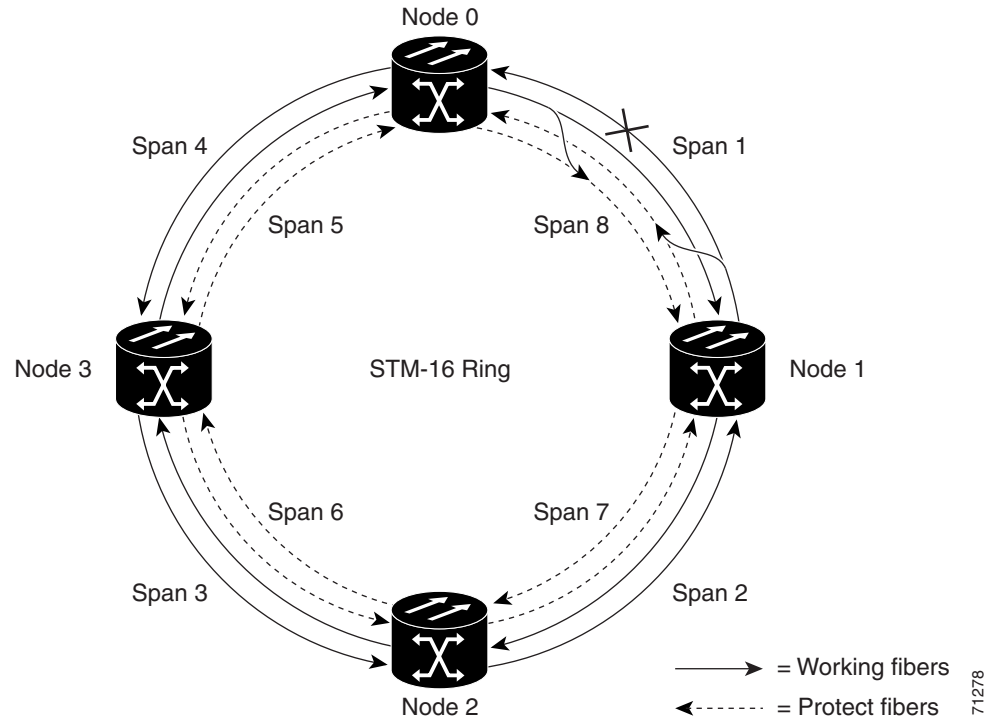

Ring switching occurs when a span switch cannot recover traffic (Figure 11-6), such as when both the working and protect fibers fail on the same span. In a ring switch, traffic is routed to the protect fibers throughout the full ring.

Figure 11-6 Four-Fiber MS-SPRing Switch

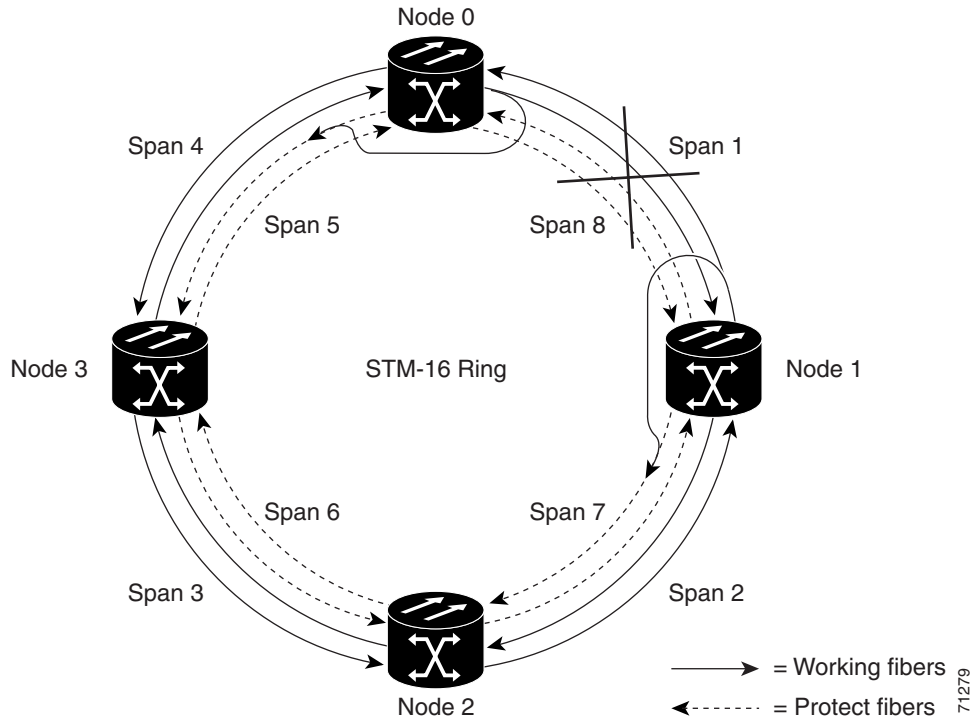

11.2.3 MS-SPRing Bandwidth

An MS-SPRing node can terminate traffic it receives from either side of the ring. Therefore, MS-SPRings are suited for distributed node-to-node traffic applications such as interoffice networks and access networks.

MS-SPRings share the ring bandwidth equally between working and protection traffic. Half of the payload bandwidth is reserved for protection in each direction, making the communication pipe half-full under normal operation.

MS-SPRings allow bandwidth to be reused around the ring and can carry more traffic than a network with traffic flowing through one central hub. MS-SPRings can also carry more traffic than an SNCP ring operating at the same STM-N rate. Table 11-2 shows the bidirectional bandwidth capacities of two-fiber MS-SPRings. The capacity is the STM-N rate divided by two, multiplied by the number of nodes in the ring and minus the number of pass-through VC4 circuits.

Table 11-2 Two-Fiber MS-SPRing Capacity

STM Rate	Working Bandwidth	Protection Bandwidth	Ring Capacity
STM-4	VC4 1-2	VC4 3-4	$2 \times N^1 - PT^2$
STM-16	VC4 1-8	VC4 9-16	$8 \times N - PT$
STM-64	VC4 1-32	VC4 33-64	$32 \times N - PT$

1. N equals the number of ONS 15454 SDH nodes configured as MS-SPRing nodes.
2. PT equals the number of VC4 circuits passed through ONS 15454 SDH nodes in the ring. (Capacity can vary depending on the traffic pattern.)

Table 11-3 shows the bidirectional bandwidth capacities of four-fiber MS-SPRings.

Table 11-3 Four-Fiber MS-SPRing Capacity

STM Rate	Working Bandwidth	Protection Bandwidth	Ring Capacity
STM-16	VC4 1-16 (Fiber 1)	VC4 1-16 (Fiber 2)	16 x N – PT
STM-64	VC4 1-64 (Fiber 1)	VC4 1-64 (Fiber 2)	64 x N – PT

Figure 11-7 shows an example of MS-SPRing bandwidth reuse. The same VC4 carries three different traffic sets simultaneously on different spans on the ring: one set from Node 3 to Node 1, one set from Node 1 to Node 2, and another set from Node 2 to Node 3.

Figure 11-7 MS-SPRing Bandwidth Reuse

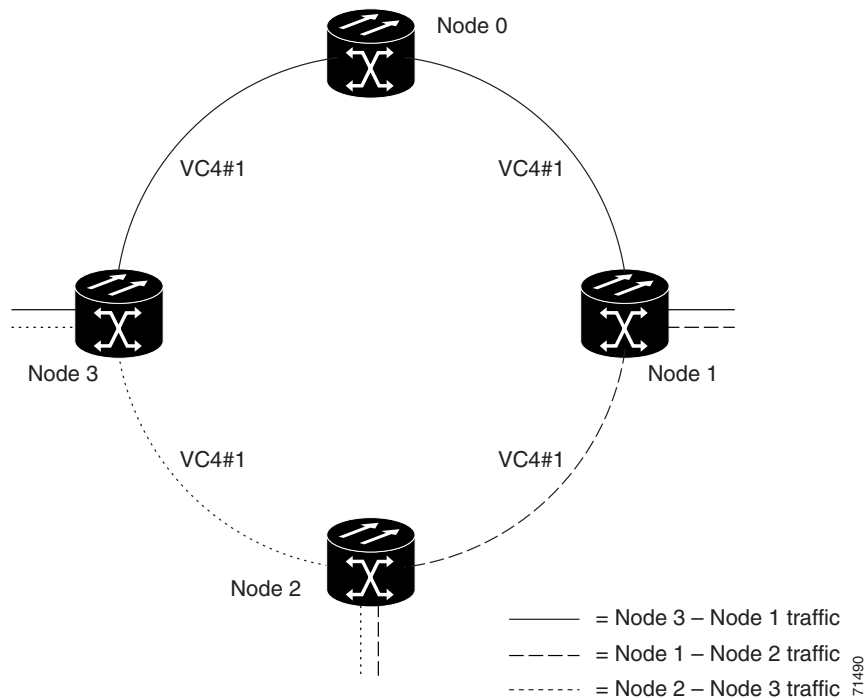

11.2.4 MS-SPRing Application Sample

Figure 11-8 shows a sample two-fiber MS-SPRing implementation with five nodes. A regional long-distance network connects to other carriers at Node 0. Traffic is delivered to the service provider's major hubs.

- Carrier 1 delivers six E-3s over two STM-1 spans to Node 0. Carrier 2 provides twelve E-3s directly. Node 0 receives the signals and delivers them around the ring to the appropriate node.
- The ring also brings 14 E-1s back from each remote site to Node 0. Intermediate nodes serve these shorter regional connections.
- The ONS 15454 SDH STM-1 card supports a total of four STM-1 ports so that two additional STM-1 spans can be added at little cost.

Figure 11-8 Five-Node, Two-Fiber MS-SPRing

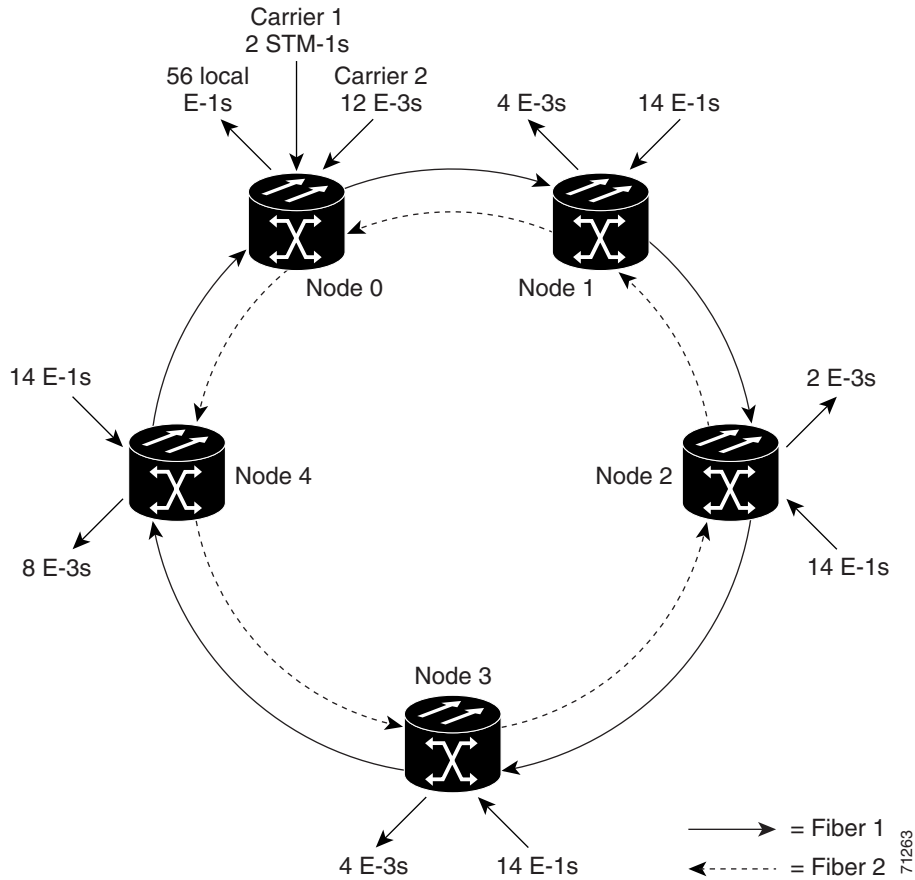

Figure 11-9 shows the shelf assembly layout for Node 0, which has one free slot. Figure 11-10 shows the shelf assembly layout for the remaining sites in the ring. In this MS-SPRing configuration, an additional eight E-3s at Node IDs 1 and 3 can be activated. An additional four E-3s can be added at Node ID 4, and ten E-3s can be added at Node ID 2. Each site has free slots for future traffic needs.

Figure 11-9 Shelf Assembly Layout for Node 0 in Figure 11-8

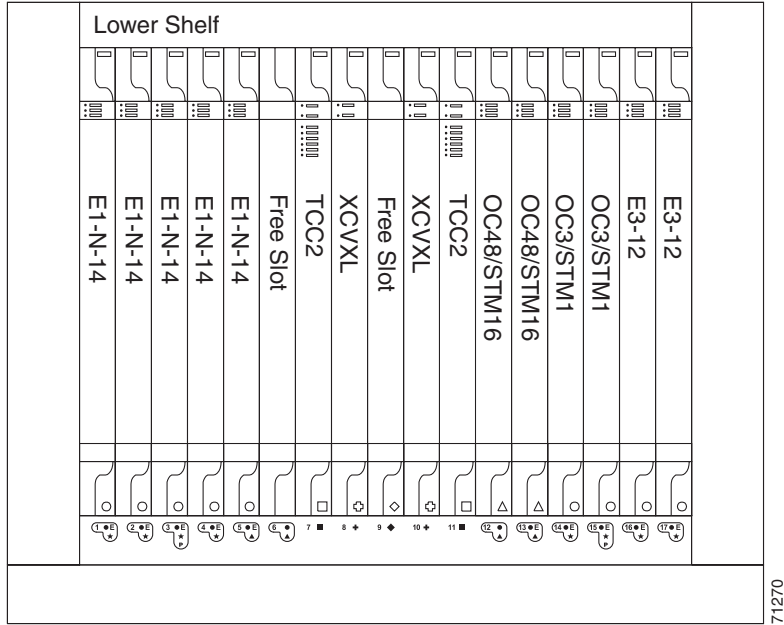
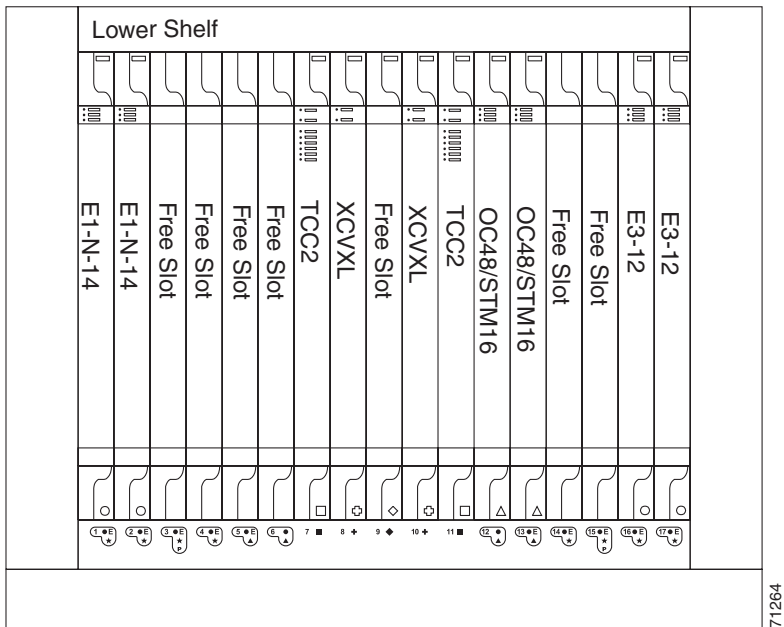

Figure 11-10 Shelf Assembly Layout for Nodes 1 to 4 in Figure 11-8



11.2.5 MS-SPRing Fiber Connections

Plan your fiber connections and use the same plan for all MS-SPRing nodes. For example, make the east port the farthest slot to the right and the west port the farthest slot to the left. Plug fiber connected to an east port at one node into the west port on an adjacent node. [Figure 11-11](#) shows fiber connections for a two-fiber MS-SPRing with trunk cards in Slot 5 (west) and Slot 12 (east). Refer to the *Cisco ONS 15454 SDH Procedure Guide* for fiber connection procedures.



Note Always plug the transmit (Tx) connector of an STM-N card at one node into the receive (Rx) connector of an STM-N card at the adjacent node. Cards display an SF LED when Tx and Rx connections are mismatched.

Figure 11-11 Connecting Fiber to a Four-Node, Two-Fiber MS-SPRing

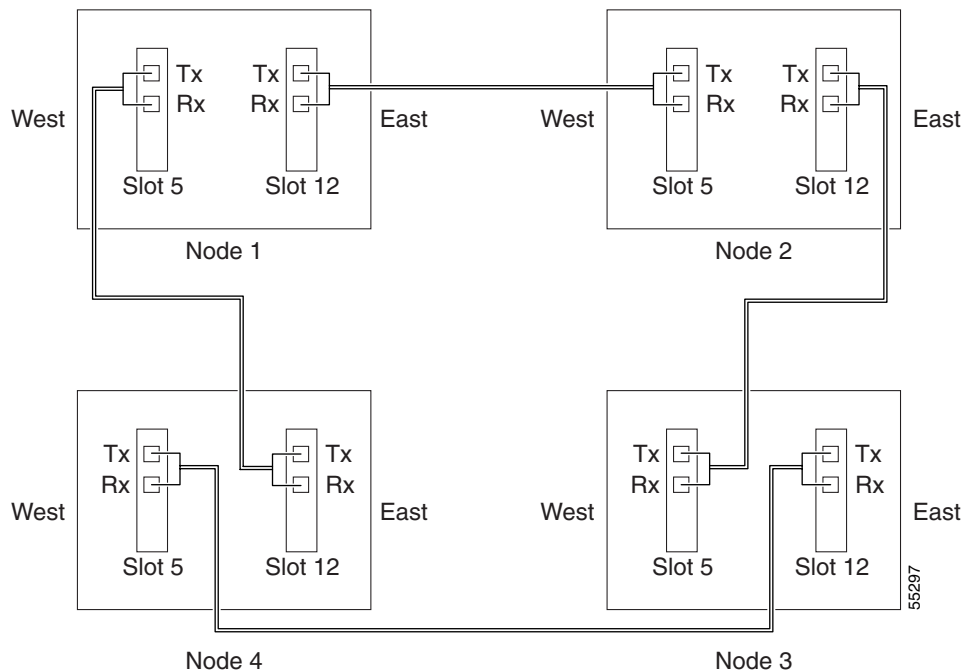

For four-fiber MS-SPRings, use the same east-west connection pattern for the working and protect fibers. Do not mix working and protect card connections. The MS-SPRing does not function if working and protect cards are interconnected. [Figure 11-12](#) shows fiber connections for a four-fiber MS-SPRing. Slot 5 (west) and Slot 12 (east) carry the working traffic. Slot 6 (west) and Slot 13 (east) carry the protect traffic.

Figure 11-12 Connecting Fiber to a Four-Node, Four-Fiber MS-SPRing

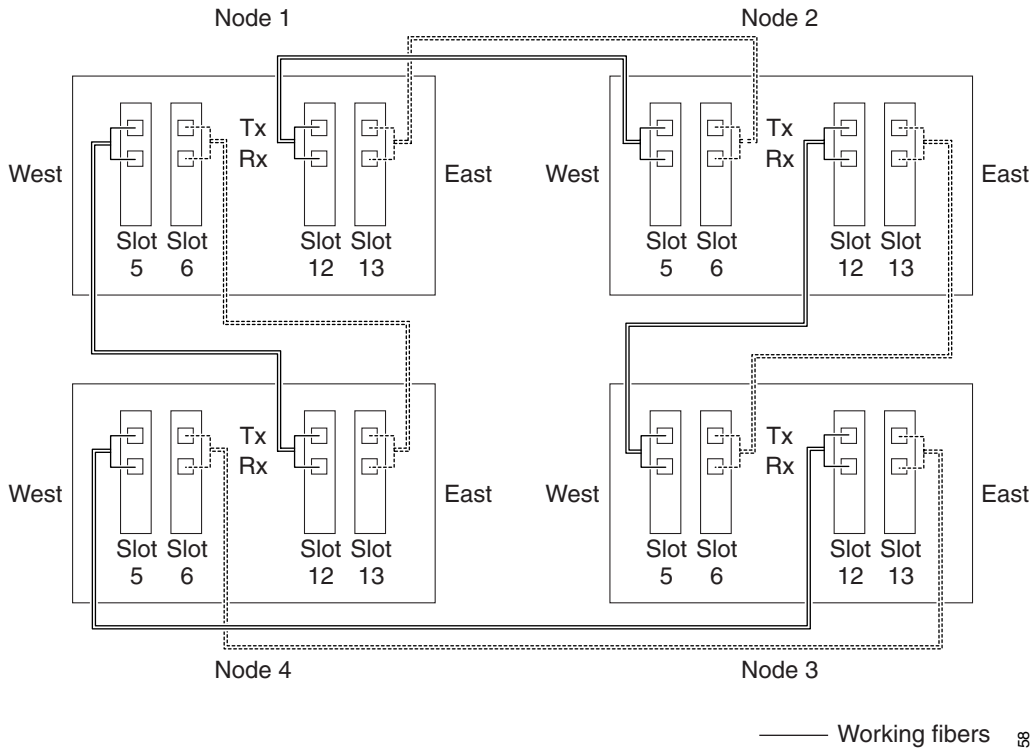

11.2.6 Two-Fiber MS-SPRing to Four-Fiber MS-SPRing Conversion

Two-fiber STM-16 or STM-64 MS-SPRings can be converted to four-fiber MS-SPRings. To convert the MS-SPRing, install two STM-16 or STM-64 cards at each two-fiber MS-SPRing node, then log into CTC and convert each node from two-fiber to four-fiber. The fibers that were divided into working and protection bandwidths for the two-fiber MS-SPRing are now fully allocated for working MS-SPRing traffic. Refer to the *Cisco ONS 15454 SDH Procedure Guide* for MS-SPRing conversion procedures.

11.3 Subnetwork Connection Protection

Subnetwork connection protection (SNCP) rings provide duplicate fiber paths in the network. Working traffic flows in one direction and protection traffic flows in the opposite direction. If a problem occurs in the working traffic path, the receiving node switches to the path coming from the opposite direction. With SNCP ring networks, switching occurs at the end of the path and is triggered by defects or alarms along the path.

The network can be divided into a number of interconnected subnetworks. Within each subnetwork, protection is provided at the path level and the automatic protection switching between two paths is provided at the subnetwork boundaries. The node at the end of the path and the intermediate nodes in the path select the best traffic signal. The virtual container is not terminated at the intermediate node; instead, it compares the quality of the signal on the two incoming ports and selects the better signal.

CTC automates ring configuration. SNCP ring network traffic is defined within the ONS 15454 SDH on a circuit-by-circuit basis. If an extended SNCP ring mesh network circuit is not defined within a 1+1 or MS-SPRing line protection scheme and path protection is available and specified, CTC uses an SNCP ring as the default protection mechanism.

An SNCP ring circuit requires two DCC-provisioned optical spans per node. SNCP ring circuits can be created across these spans until their bandwidth is consumed.

The span bandwidth consumed by an SNCP ring circuit is two times the circuit bandwidth because the circuit is duplicated. The cross-connection bandwidth consumed by an SNCP ring circuit is three times the circuit bandwidth at the source and destination nodes only. The cross-connection bandwidth consumed by an intermediate node has a factor of one.

The SNCP ring circuit limit is the sum of the optical bandwidth containing 68 section data communication channels (SDCCs) or 28 line data communication channels (LDCCs), divided by two. The spans can be of any bandwidth from STM-1 to STM-64.

Figure 11-13 shows a basic SNCP ring configuration. If Node A sends a signal to Node C, the working signal travels on the working traffic path through Node B. The same signal is also sent on the protect traffic path through Node D. If a fiber break occurs (Figure 11-14), Node C switches its active receiver to the protect signal coming through Node D.

Figure 11-13 Basic Four-Node SNCP Ring

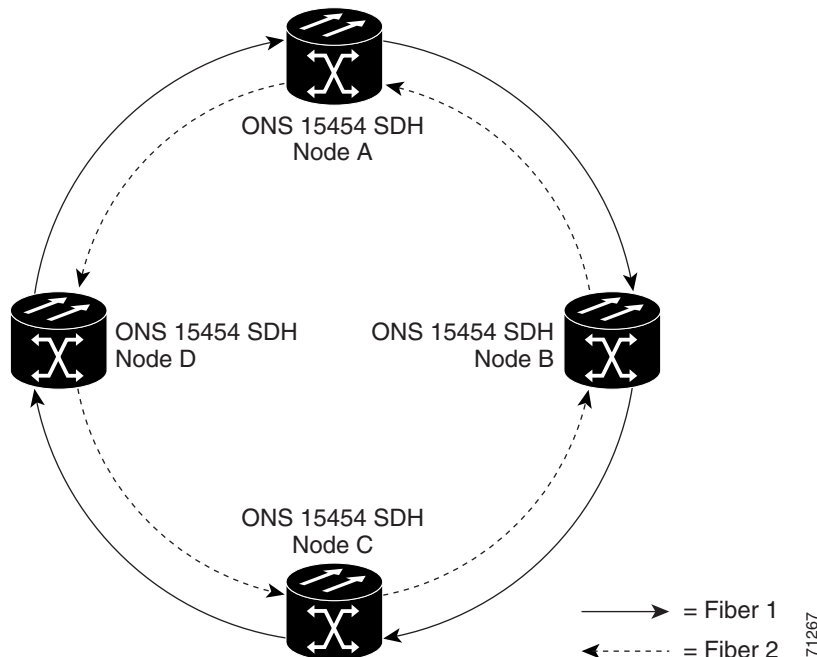
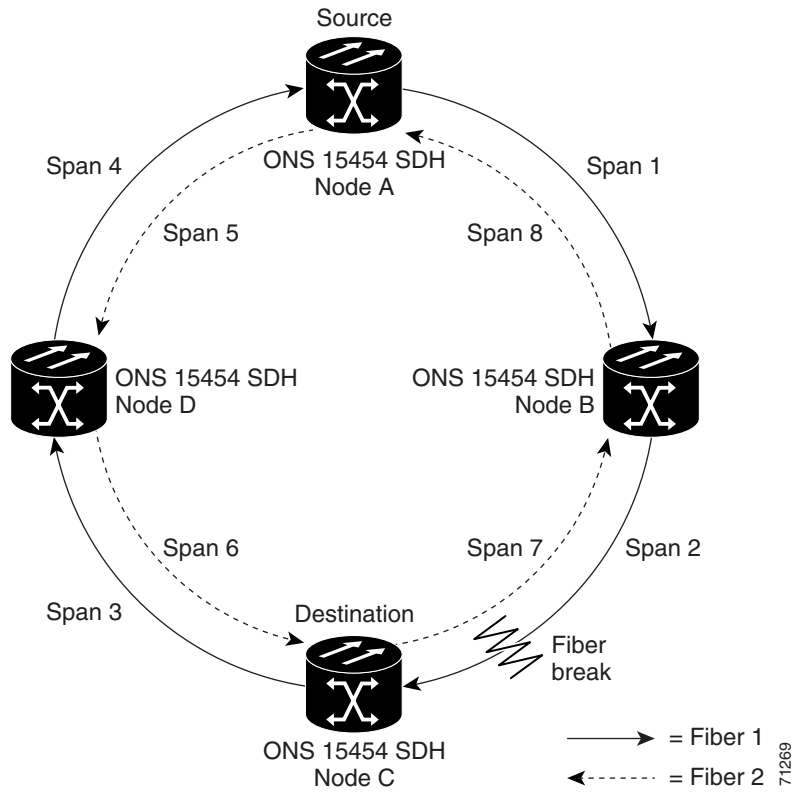

Figure 11-14 SNCP Ring with a Fiber Break



Because each traffic path is transported around the entire ring, SNCP rings are best suited for networks where traffic concentrates at one or two locations and is not widely distributed. SNCP ring capacity is equal to its bit rate. Services can originate and terminate on the same SNCP ring, or they can be passed to an adjacent access or interoffice ring for transport to the service-terminating node.

Figure 11-15 shows a common SNCP ring application. STM-1 path circuits provide remote switch connectivity to a host V5.x switch. In the example, each remote switch requires eight E-1s to return to the host switch. Figure 11-16 on page 11-17 and Figure 11-17 on page 11-17 show the shelf layout for each node in the example.

Figure 11-15 STM-1 SNCP Ring

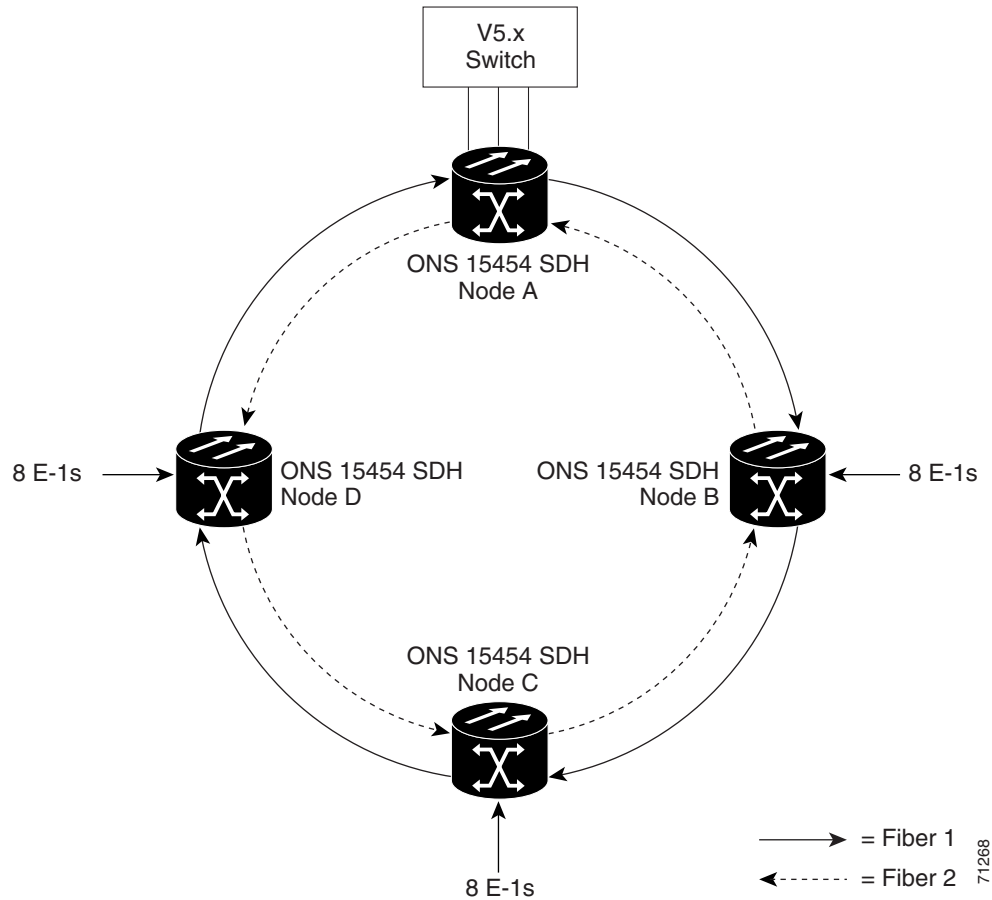

Node A has four E1-14 cards to provide 42 active E-1 ports. The other sites only require two E1-14 cards to carry the eight E-1s to and from the remote switch. You can use the other half of each ONS 15454 SDH shelf assembly to provide support for a second or third ring to other existing or planned remote sites.

In this sample STM-1 SNCP ring, Node A contains four E1-14 cards and two STM-1 cards. Six free slots are available, which you can provision with cards or leave empty.

**Note**

Fill unused card slots with a blank faceplate (Cisco P/N 15454E-BLANK). The blank faceplate ensures proper airflow when operating the ONS 15454 SDH.

Figure 11-16 shows the shelf setup for this sample configuration.

Figure 11-16 Card Setup of Node A in the STM-1 SNCP Ring Example

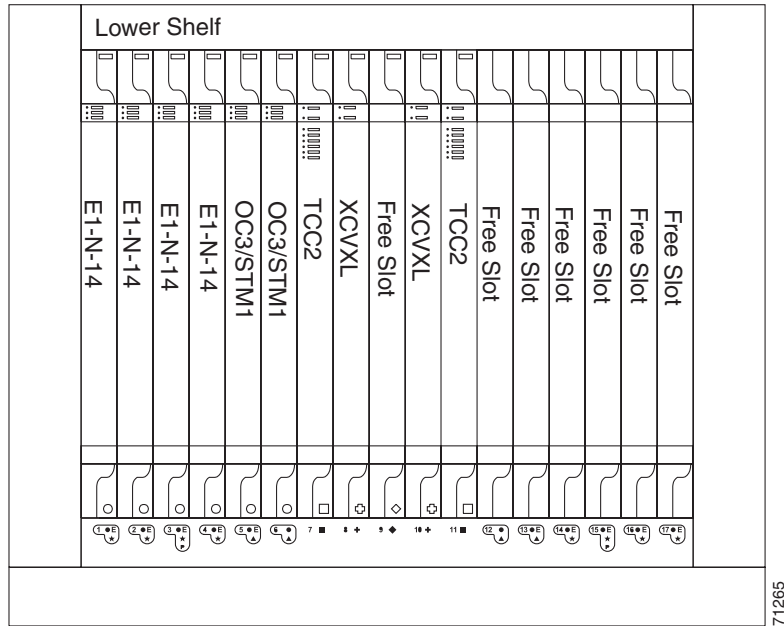

In Figure 11-15 on page 11-16, Nodes B through D each contain two E1-14 cards and two STM-1 cards. Eight free slots are available that you can provision with other cards or leave empty. Figure 11-17 shows the shelf assembly setup for this sample configuration.

Figure 11-17 Card Setup of Nodes B-D in the STM-1 SNCP Ring Example

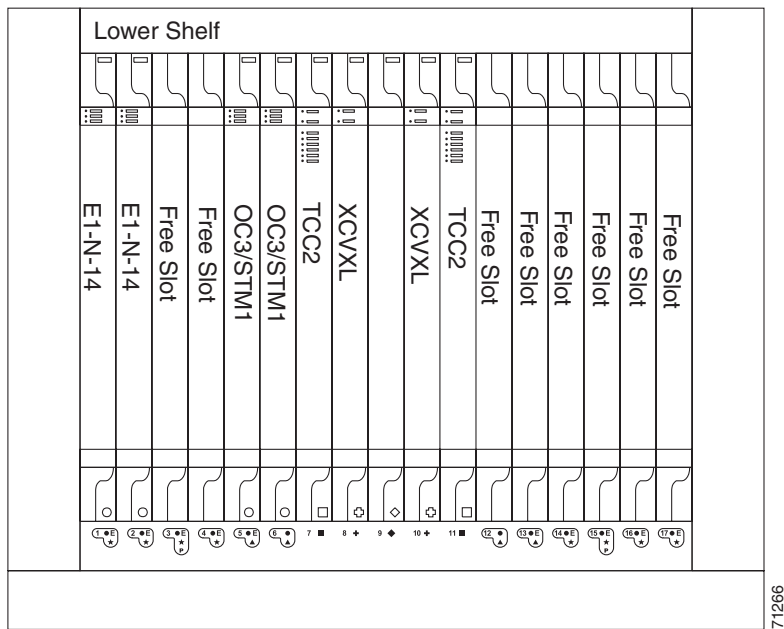

11.4 SNCP Dual Ring Interconnect

The SNCP dual ring interconnect topology (SNCP DRI) provides an extra level of path protection between interconnected SNCP rings. In DRIs, traffic is dropped and continued at the interconnecting nodes to eliminate single points of failure. Two DRI topologies can be implemented on the ONS 15454 SDH. The traditional DRI uses four ONS 15454 SDHs at the interconnect nodes, while the integrated DRI uses two nodes.

[Figure 11-18](#) shows ONS 15454 SDHs in a traditional DRI topology. In Ring 1, Nodes 4 and 5 are the interconnect nodes, and in Ring 2, Nodes 6 and 7 are the interconnect nodes. Duplicate signals are sent from Node 4 (Ring 1) to Node 6 (Ring 2), and between Node 5 (Ring 1) and Node 7 (Ring 2). In Ring 1, traffic at Node 4 is dropped (to Node 6) and continued (to Node 5). Similarly, at Node 5, traffic is dropped (to Node 7) and continued (to Node 4).

To route circuits on the DRI, you must choose the DRI option during circuit provisioning. Circuits with the DRI option enabled are routed on the DRI path.

Figure 11-18 ONS 15454 Traditional SDH Dual Ring Interconnect

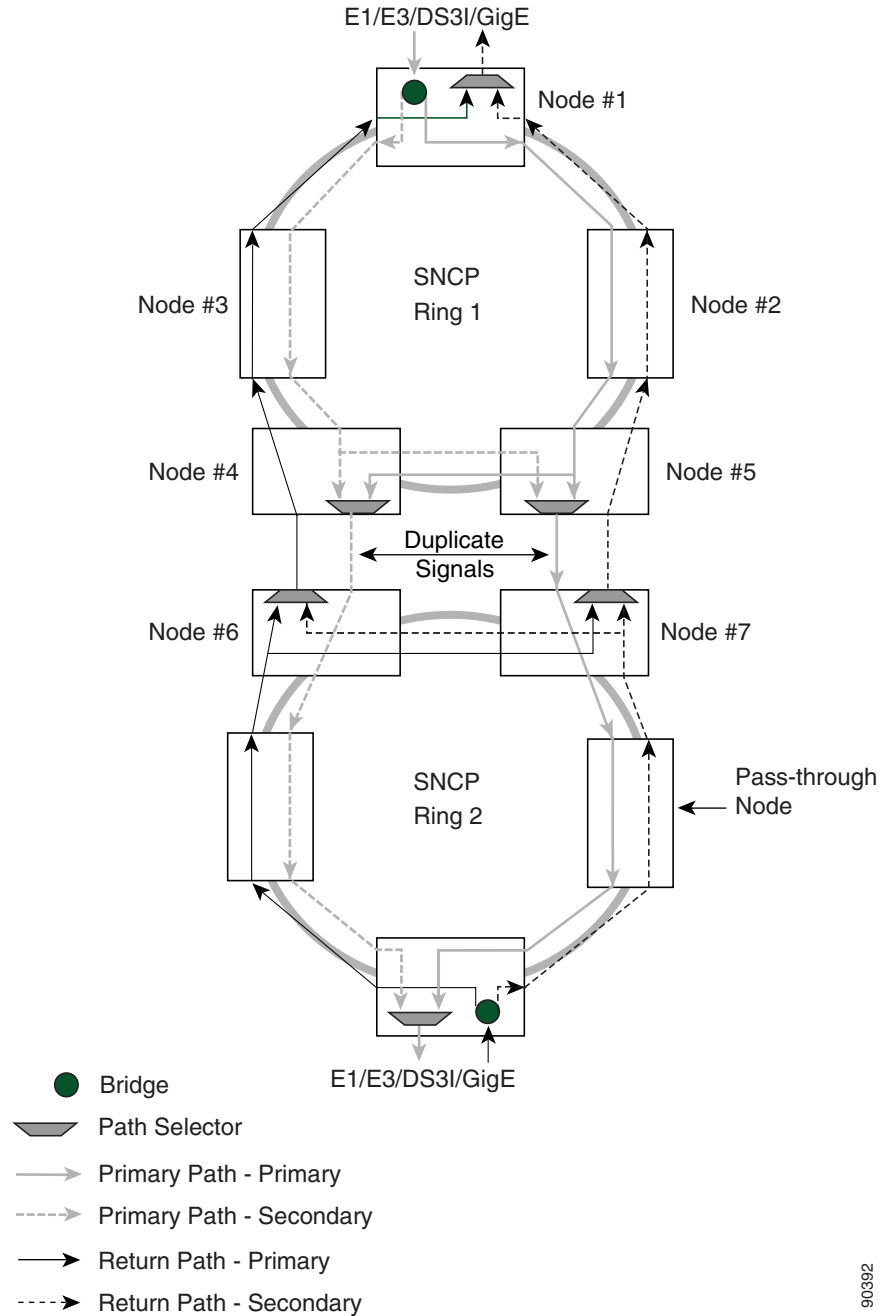
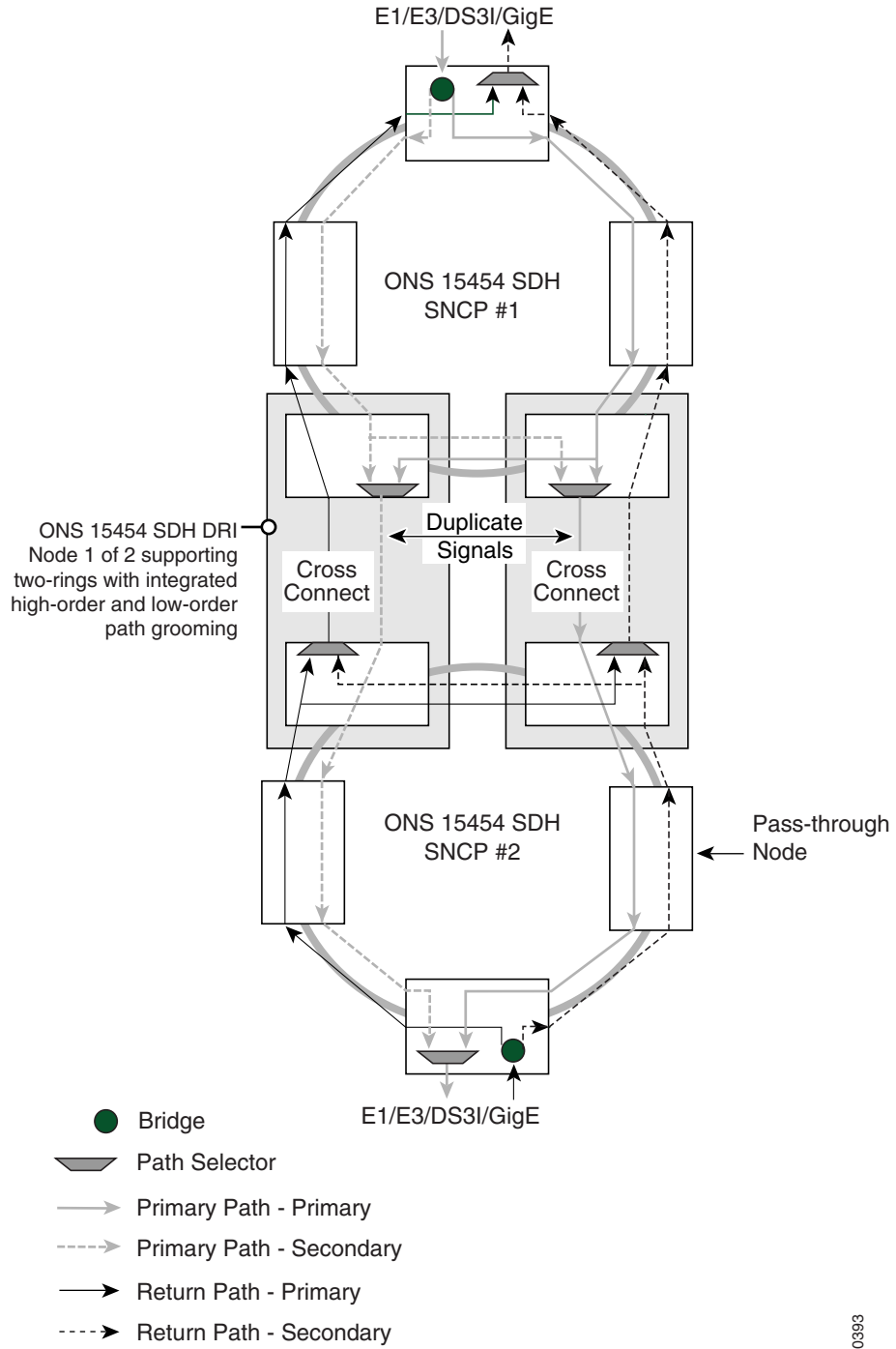

Figure 11-19 shows ONS 15454 SDHs in an integrated DRI topology. The same drop and continue traffic routing occurs at two nodes, rather than four. This is achieved by installing an additional STM-N trunk at the two interconnect nodes.

90392

Figure 11-19 ONS 15454 SDH Integrated Dual Ring Interconnect



90393

11.5 Subtending Rings

The ONS 15454 SDH supports up to 68 SDH regenerator SDCCs or 28 LDCCs with TCC2 cards. See [Table 11-1 on page 11-2](#) for ring and regenerator SDCC and LDCC information.

Subtending rings reduce the number of nodes and cards required and reduce external shelf-to-shelf cabling. [Figure 11-20](#) shows an ONS 15454 SDH with multiple subtending rings.

Figure 11-20 ONS 15454 SDH with Multiple Subtending Rings

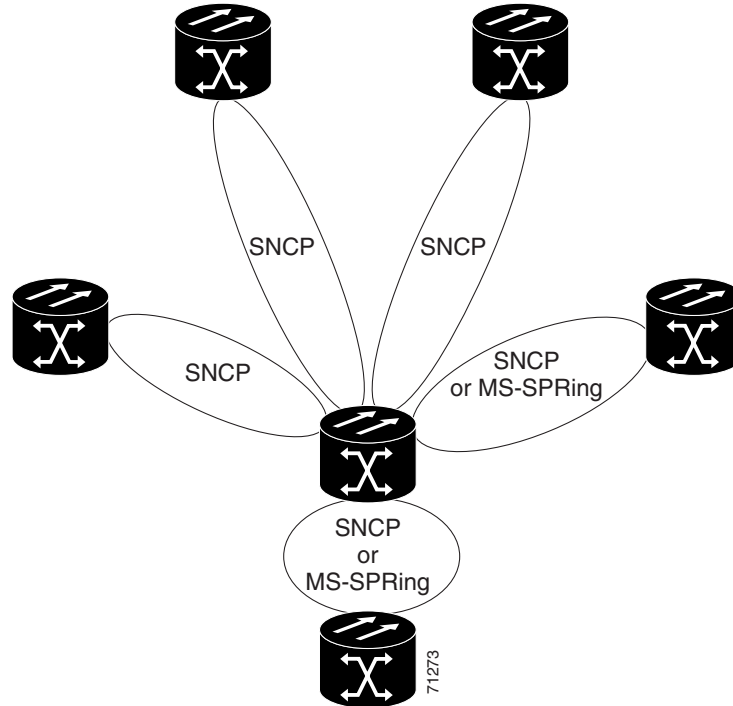

[Figure 11-21](#) shows an SNCP ring subtending from an MS-SPRing. In this example, Node 3 is the only node serving both the MS-SPRing and SNCP ring. STM-N cards in Slots 5 and 12 serve the MS-SPRing, and STM-N cards in Slots 6 and 13 serve the SNCP ring.

Figure 11-21 SNCP Ring Subtending from an MS-SPRing

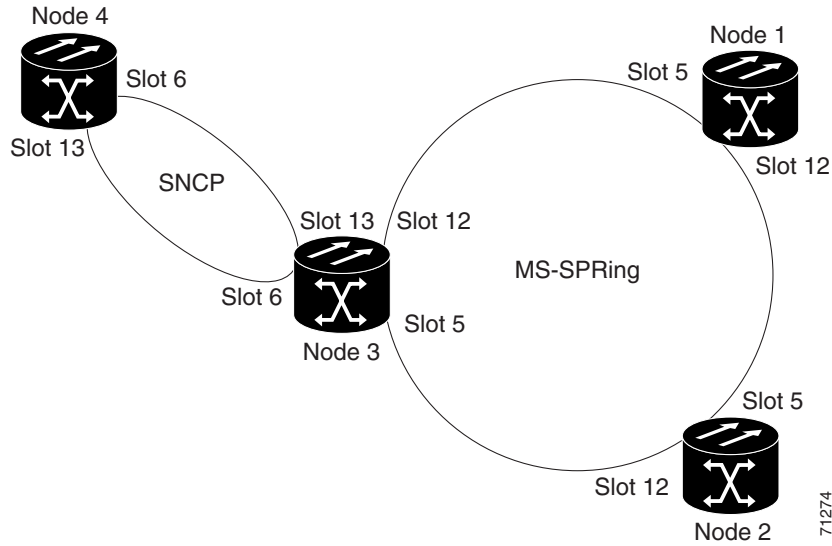

The ONS 15454 SDH can support five MS-SPRings on the same node. This allows you to deploy an ONS 15454 SDH in applications requiring SDH Digital Cross-connect Systems (DCSs) or multiple SDH add/drop multiplexers (ADMs).

Figure 11-22 shows two MS-SPRings shared by one ONS 15454 SDH. Ring 1 runs on Nodes 1, 2, 3, and 4. Ring 2 runs on Nodes 4, 5, 6, and 7. Two MS-SPRing, Ring 1 and Ring 2, are provisioned on Node 4. Ring 1 uses cards in Slots 5 and 12, and Ring 2 uses cards in Slots 6 and 13.

Note

Nodes in different MS-SPRings can have the same or different node IDs.

Figure 11-22 MS-SPRing Subtending from an MS-SPRing

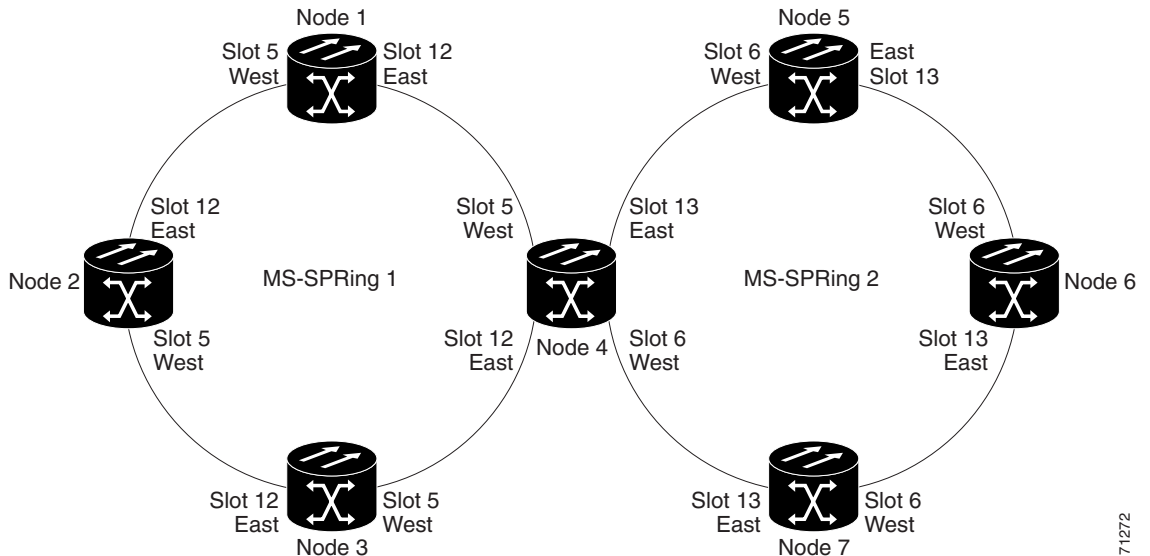

After subtending two MS-SPRings, you can route circuits from nodes in one ring to nodes in the second ring. For example, in [Figure 11-22](#) you can route a circuit from Node 1 to Node 7. The circuit would normally travel from Node 1 to Node 4 to Node 7. If fiber breaks occur, for example between Nodes 1 and 4 and Nodes 4 and 7, traffic is rerouted around each ring: in this example, Nodes 2 and 3 in Ring 1 and Nodes 5 and 6 in Ring 2.

11.6 Linear ADM Configurations

You can configure ONS 15454 SDHs as a line of add/drop multiplexers (ADMs) by configuring one set of STM-N cards as the working path and a second set as the protect path. Unlike rings, linear (point-to-point) ADMs require that the STM-N cards at each node be in 1+1 protection to ensure that a break to the working line is automatically routed to the protect line.

[Figure 11-23](#) shows three ONS 15454 SDH nodes in a linear ADM configuration. Working traffic flows from Node 1/Slot 5 to Node 2/Slot 5, and from Node 2/Slot 12 to Node 3/Slot 12. You create the protect path by placing Slot 6 in 1+1 protection with Slot 5 at Nodes 1 and 2, and placing Slot 12 in 1+1 protection with Slot 13 at Nodes 2 and 3.

Figure 11-23 Linear (Point-to-Point) ADM Configuration

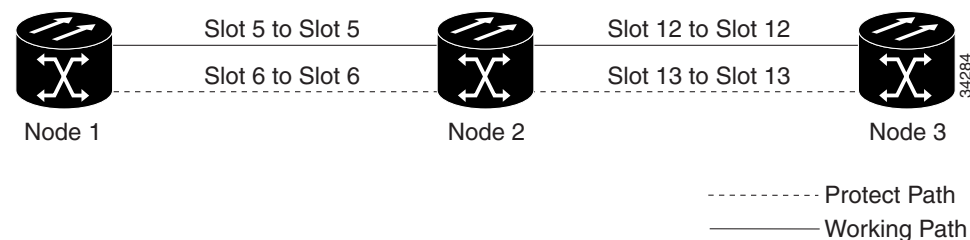

11.7 Extended SNCP Mesh Networks

In addition to single MS-SPRings, SNCP rings, and ADMs, you can extend ONS 15454 SDH traffic protection by creating extended SNCP mesh networks. Extended SNCP rings include multiple ONS 15454 SDH topologies and extend the protection provided by a single SNCP ring to the meshed architecture of several interconnecting rings.

In an extended SNCP ring, circuits travel diverse paths through a network of single or multiple meshed rings. When you create circuits, you can provision CTC to automatically route circuits across the Extended SNCP ring, or you can manually route them. You can also choose levels of circuit protection. For example, if you choose full protection, CTC creates an alternate route for the circuit in addition to the main route. The second route follows a unique path through the network between the source and destination and sets up a second set of cross-connections.

For example, in [Figure 11-24](#), a circuit is created from Node 3 to Node 9. CTC determines that the shortest route between the two nodes passes through Node 8 and Node 7, shown by the dotted line, and automatically creates cross-connections at Nodes, 3, 8, 7, and 9 to provide the primary circuit path.

If full protection is selected, CTC creates a second unique route between Nodes 3 and 9 which, in this example, passes through Nodes 2, 1, and 11. Cross-connections are automatically created at Nodes 3, 2, 1, 11, and 9, shown by the dashed line. If a failure occurs on the primary path, traffic switches to the second circuit path. In this example, Node 9 switches from the traffic coming in from Node 7 to the traffic coming in from Node 11 and service resumes. The switch occurs within 50 ms.

Figure 11-24 Extended SNCP Mesh Network

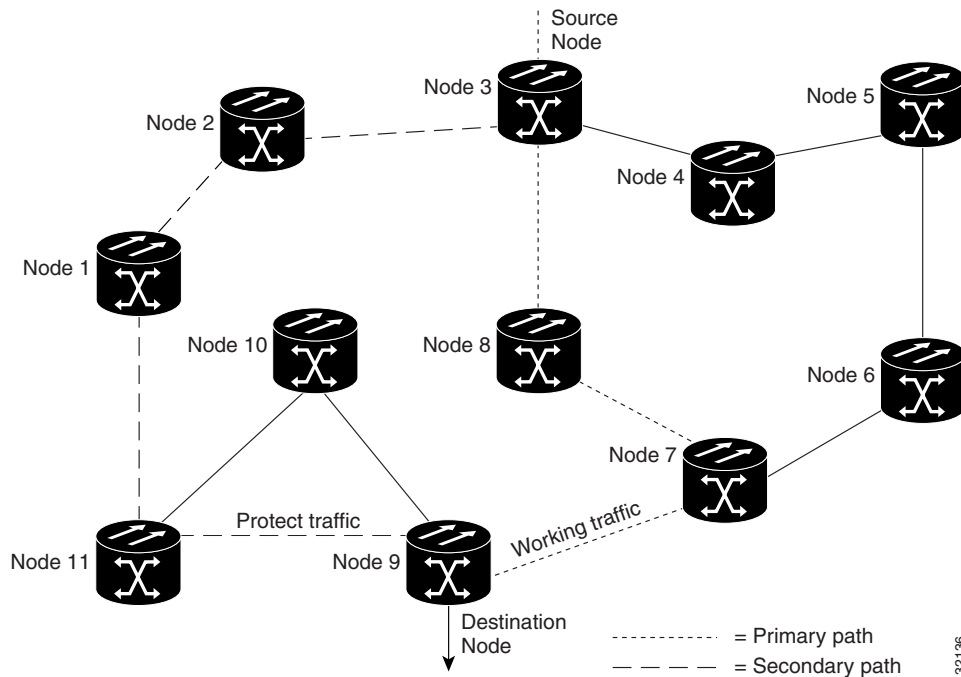

Extended SNCP rings also allow spans with different SDH speeds to be mixed together in “virtual rings.” [Figure 11-25](#) shows Nodes 1, 2, 3, and 4 in a standard STM-16 ring. Nodes 5, 6, 7, and 8 link to the backbone ring through STM-4 fiber. The “virtual ring” formed by Nodes 5, 6, 7, and 8 uses both STM-16 and STM-4 cards.

Figure 11-25 Extended SNCP Virtual Ring

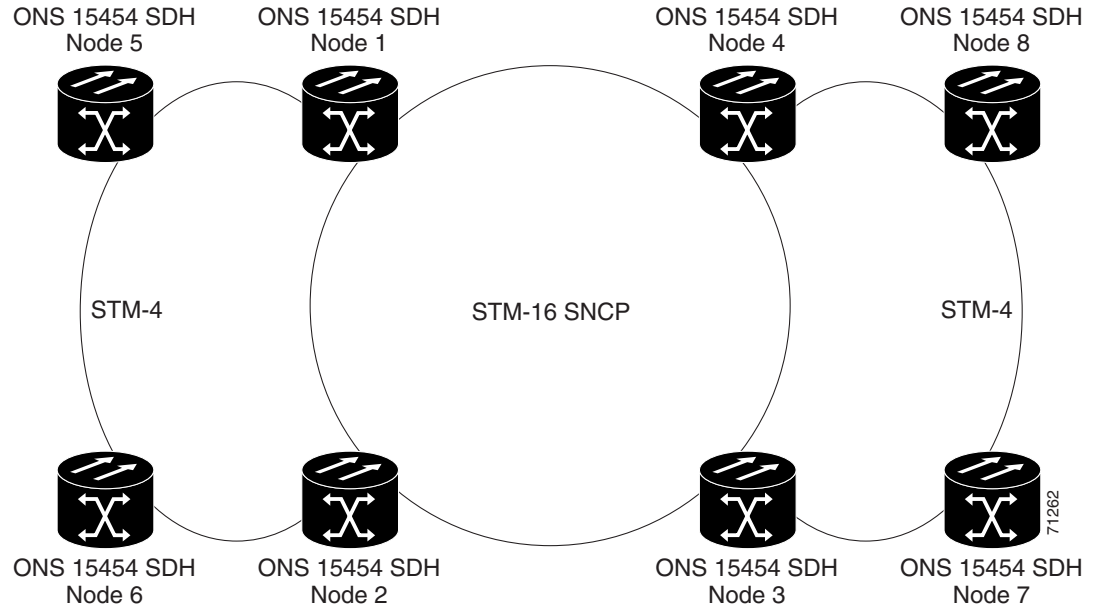

11.8 Four Node Configurations

You can link multiple ONS 15454 SDHs using their STM-N cards (that is, create a fiber-optic bus) to accommodate more access traffic than a single ONS 15454 SDH can support. Refer to the *Cisco ONS 15454 SDH Procedure Guide* for more information. You can link nodes with STM-4 or STM-16 fiber spans as you would link any other two network nodes. The nodes can be grouped in one facility to aggregate more local traffic. Each shelf assembly is recognized as a separate node in the ONS 15454 SDH software interface and traffic is mapped using CTC cross-connect options.

11.9 STM-N Speed Upgrades

A span is the optical fiber connection between two ONS 15454 SDH nodes. In a span (optical speed) upgrade, the transmission rate of a span is upgraded from a lower to a higher STM-N signal but all other span configuration attributes remain unchanged. With multiple nodes, a span upgrade is a coordinated series of upgrades on all nodes in the ring or protection group. You can perform in-service span upgrades for the following ONS 15454 SDH cards:

- Single-port STM-4 to STM-16
- Single-port STM-4 to STM-64
- STM-16 to STM-64

You can also perform in-service card upgrades for the following ONS15454 cards:

- Four-port STM-1 to eight-port STM-1
- Single-port STM-4 to four-port STM-4

**Note**

Since the four-port STM-1 to eight-port STM-1 cards and the single-port STM-4 to four-port STM-4 cards are the same speed, they are not considered span upgrades.

To perform a span upgrade, the higher-rate optical card must replace the lower-rate card in the same slot. If the upgrade is conducted on spans residing in an MS-SPRing, all spans in the ring must be upgraded. The protection configuration of the original lower-rate optical card (two-fiber MS-SPRing, four-fiber MS-SPRing, SNCP ring, and 1+1) is retained for the higher-rate STM-N card.

When performing span upgrades on a large number of nodes, we recommend that you upgrade all spans in a ring consecutively and in the same maintenance window. Until all spans are upgraded, mismatched card types are present.

We recommend using the Span Upgrade Wizard to perform span upgrades. Although you can also use the manual span upgrade procedures, the manual procedures are mainly provided as error recovery for the wizard. The Span Upgrade Wizard and the Manual Span Upgrade procedures require at least two technicians (one at each end of the span) who can communicate with each other during the upgrade. Upgrading a span is non-service affecting and causes no more than three switches, each of which is less than 50 ms in duration.

**Note**

Span upgrades do not upgrade SDH topologies, for example, a 1+1 group to a two-fiber MS-SPRing. Refer to the *Cisco ONS 15454 SDH Procedure Guide* for topology upgrade procedures.

11.9.1 Span Upgrade Wizard

The Span Upgrade Wizard automates all steps in the manual span upgrade procedure (MS-SPRing, SNCP ring, and 1+1). The wizard can upgrade both lines on one side of a four-fiber MS-SPRing or both lines of a 1+1 group; the wizard upgrades SNCP rings and two-fiber MS-SPRings one line at a time. The Span Upgrade Wizard requires that spans have DCCs enabled.

The Span Upgrade Wizard provides no way to back out of an upgrade. In the case of an error, you must exit the wizard and initiate the manual procedure to either continue with the upgrade or back out of it. To continue with the manual procedure, examine the standing conditions and alarms to identify the stage in which the wizard failure occurred.

11.9.2 Manual Span Upgrades

Manual Span Upgrades are mainly provided as error recovery for the Span Upgrade Wizard, but they can be used to perform span upgrades. Downgrading can be performed to back out of a span upgrade. The procedure for downgrading is the same as upgrading except that you choose a lower-rate card type. You cannot downgrade if circuits exist on the VCs that will be removed (the higher VCs).

Procedures for manual span upgrades can be found in the “Upgrade Cards and Spans” chapter in the *Cisco ONS 15454 SDH Procedure Guide*. Five manual span upgrade options are available:

- Upgrade on a two-fiber MS-SPRing
- Upgrade on a four-fiber MS-SPRing
- Upgrade on an SNCP ring
- Upgrade on a 1+1 protection group
- Upgrade on an unprotected span