



Implementing MPLS Traffic Engineering

Traditional IP routing emphasizes on forwarding traffic to the destination as fast as possible. As a result, the routing protocols find out the least-cost route according to its metric to each destination in the network and every router forwards the packet based on the destination IP address and packets are forwarded hop-by-hop. Thus, traditional IP routing does not consider the available bandwidth of the link. This can cause some links to be over-utilized compared to others and bandwidth is not efficiently utilized. Traffic Engineering (TE) is used when the problems result from inefficient mapping of traffic streams onto the network resources. Traffic engineering allows you to control the path that data packets follow and moves traffic flows from congested links to non-congested links that would not be possible by the automatically computed destination-based shortest path.

Multiprotocol Label Switching (MPLS) with its label switching capabilities, eliminates the need for an IP route look-up and creates a virtual circuit (VC) switching function, allowing enterprises the same performance on their IP-based network services as with those delivered over traditional networks such as Frame Relay or Asynchronous Transfer Mode (ATM). MPLS traffic engineering (MPLS-TE) relies on the MPLS backbone to replicate and expand upon the TE capabilities of Layer 2 ATM and Frame Relay networks.

MPLS-TE learns the topology and resources available in a network and then maps traffic flows to particular paths based on resource requirements and network resources such as bandwidth. MPLS-TE builds a unidirectional tunnel from a source to a destination in the form of a label switched path (LSP), which is then used to forward traffic. The point where the tunnel begins is called the tunnel headend or tunnel source, and the node where the tunnel ends is called the tunnel tailend or tunnel destination. A router through which the tunnel passes is called the mid-point of the tunnel.

MPLS uses extensions to a link-state based Interior Gateway Protocol (IGP), such as Intermediate System-to-Intermediate System (IS-IS) or Open Shortest Path First (OSPF). MPLS calculates TE tunnels at the LSP head based on required and available resources (constraint-based routing). If configured, the IGP automatically routes the traffic onto these LSPs. Typically, a packet that crosses the MPLS-TE backbone travels on a single LSP that connects the ingress point to the egress point. MPLS TE automatically establishes and maintains the LSPs across the MPLS network by using the Resource Reservation Protocol (RSVP).



Note Combination of unlabelled paths protected by labelled paths is not supported.

- [Overview of MPLS-TE Features, on page 2](#)
- [How MPLS-TE Works, on page 3](#)
- [Configuring MPLS-TE, on page 4](#)
- [Configure Autoroute Tunnel as Designated Path, on page 22](#)
- [MPLS-TE Features - Details, on page 25](#)

Overview of MPLS-TE Features

In MPLS traffic engineering, IGP extensions flood the TE information across the network. Once the IGP distributes the link attributes and bandwidth information, the headend router calculates the best path from head to tail for the MPLS-TE tunnel. This path can also be configured explicitly. Once the path is calculated, RSVP-TE is used to set up the TE LSP (Labeled Switch Path).

To forward the traffic, you can configure autoroute, forward adjacency, or static routing. The autoroute feature announces the routes assigned by the tailend router and its downstream routes to the routing table of the headend router and the tunnel is considered as a directly connected link to the tunnel.

If forward adjacency is enabled, MPLS-TE tunnel is advertised as a link in an IGP network with the link's cost associated with it. Routers outside of the TE domain can see the TE tunnel and use it to compute the shortest path for routing traffic throughout the network.

MPLS-TE provides protection mechanism known as fast reroute to minimize packet loss during a failure. For fast reroute, you need to create back up tunnels. The autotunnel backup feature enables a router to dynamically build backup tunnels when they are needed instead of pre-configuring each backup tunnel and then assign the backup tunnel to the protected interfaces.

DiffServ Aware Traffic Engineering (DS-TE) enables you to configure multiple bandwidth constraints on an MPLS-enabled interface to support various classes of service (CoS). These bandwidth constraints can be treated differently based on the requirement for the traffic class using that constraint.

The MPLS traffic engineering autotunnel mesh feature allows you to set up full mesh of TE tunnels automatically with a minimal set of MPLS traffic engineering configurations. The MPLS-TE auto bandwidth feature allows you to automatically adjust bandwidth based on traffic patterns without traffic disruption.

The MPLS-TE interarea tunneling feature allows you to establish TE tunnels spanning multiple Interior Gateway Protocol (IGP) areas and levels, thus eliminating the requirement that headend and tailend routers should reside in a single area.

For detailed information about MPLS-TE features, see [MPLS-TE Features - Details, on page 25](#).



Note MPLS-TE Nonstop Routing (NSR) is enabled by default without any user configuration and cannot be disabled. MPLS-TE NSR means the application is in hot-standby mode and standby MPLS-TE instance is ready to take over from the active instance quickly on RP failover.

Note that the MPLS-TE does not do routing. If there is standby card available then the MPLS-TE instance is in a hot-standby position.

The following output shows the status of MPLS-TE NSR:

```
Router#show mpls traffic-eng nsr status

TE Process Role           : V1 Active
Current Status            : Ready
  Ready since              : Tue Nov 01 10:42:34 UTC 2022 (1w3d ago)
  IDT started              : Tue Nov 01 03:28:48 UTC 2022 (1w3d ago)
  IDT ended                : Tue Nov 01 03:28:48 UTC 2022 (1w3d ago)
Previous Status          : Not ready
  Not ready reason         : Collaborator disconnected
  Not ready since          : Tue Nov 01 10:42:34 UTC 2022 (1w3d ago)
```

During any issues with the MPLS-TE, the NSR on the router gets affected which is displayed in the show redundancy output as follows:

```
Router#show mpls traffic-eng nsr status details
.
.
.

Current active rmf state: 4 (I_READY)
All standby not-ready bits clear - standby should be ready

Current active rmf state for NSR: Not ready
<jid> <node> <name> Reason for standby not NSR-ready
1082 0/RP0/CPU0 te_control TE NSR session not synchronized
Not ready set Wed Nov 19 17:28:14 2022: 5 hours, 23 minutes ago
1082 0/RP1/CPU0 te_control Standby not connected
Not ready set Wed Nov 19 17:29:11 2022: 5 hours, 22 minutes ago
```

How MPLS-TE Works

MPLS-TE automatically establishes and maintains label switched paths (LSPs) across the backbone by using RSVP. The path that an LSP uses is determined by the LSP resource requirements and network resources, such as bandwidth. Available resources are flooded by extensions to a link state based Interior Gateway Protocol (IGP). MPLS-TE tunnels are calculated at the LSP headend router, based on a fit between the required and available resources (constraint-based routing). The IGP automatically routes the traffic to these LSPs. Typically, a packet crossing the MPLS-TE backbone travels on a single LSP that connects the ingress point to the egress point.

The following sections describe the components of MPLS-TE:

Tunnel Interfaces

From a Layer 2 standpoint, an MPLS tunnel interface represents the headend of an LSP. It is configured with a set of resource requirements, such as bandwidth and media requirements, and priority. From a Layer 3 standpoint, an LSP tunnel interface is the headend of a unidirectional virtual link to the tunnel destination.

MPLS-TE Path Calculation Module

This calculation module operates at the LSP headend. The module determines a path to use for an LSP. The path calculation uses a link-state database containing flooded topology and resource information.

RSVP with TE Extensions

RSVP operates at each LSP hop and is used to signal and maintain LSPs based on the calculated path.

MPLS-TE Link Management Module

This module operates at each LSP hop, performs link call admission on the RSVP signaling messages, and keep track on topology and resource information to be flooded.

Link-state IGP

Either Intermediate System-to-Intermediate System (IS-IS) or Open Shortest Path First (OSPF) can be used as IGPs. These IGPs are used to globally flood topology and resource information from the link management module.

Label Switching Forwarding

This forwarding mechanism provides routers with a Layer 2-like ability to direct traffic across multiple hops of the LSP established by RSVP signaling.

Configuring MPLS-TE

MPLS-TE requires co-ordination among several global neighbor routers. RSVP, MPLS-TE and IGP are configured on all routers and interfaces in the MPLS traffic engineering network. Explicit path and TE tunnel interfaces are configured only on the head-end routers. MPLS-TE requires some basic configuration tasks explained in this section.

Building MPLS-TE Topology

Building MPLS-TE topology, sets up the environment for creating MPLS-TE tunnels. This procedure includes the basic node and interface configuration for enabling MPLS-TE. To perform constraint-based routing, you need to enable OSPF or IS-IS as IGP extension.

Before You Begin

Before you start to build the MPLS-TE topology, the following pre-requisites are required:

- Stable router ID is required at either end of the link to ensure that the link is successful. If you do not assign a router ID, the system defaults to the global router ID. Default router IDs are subject to change, which can result in an unstable link.

- Enable RSVP on the port interface.

Example

This example enables MPLS-TE on a node and then specifies the interface that is part of the MPLS-TE. Here, OSPF is used as the IGP extension protocol for information distribution.

```
RP/0/RP0/CPU0:router# configure
RP/0/RP0/CPU0:router(config)# mpls traffic-eng
RP/0/RP0/CPU0:router(config-mpls-te)# interface hundredGigE0/0/1/0
RP/0/RP0/CPU0:router(config)# router ospf area 1
RP/0/RP0/CPU0:router(config-ospf)# area 0
RP/0/RP0/CPU0:router(config-ospf-ar)# mpls traffic-eng
RP/0/RP0/CPU0:router(config-ospf-ar)# interface hundredGigE0/0/1/0
RP/0/RP0/CPU0:router(config-ospf-ar-if)# exit
RP/0/RP0/CPU0:router(config-ospf)# mpls traffic-eng router-id 192.168.70.1
RP/0/RP0/CPU0:router(config)# commit
```

Example

This example enables MPLS-TE on a node and then specifies the interface that is part of the MPLS-TE. Here, IS-IS is used as the IGP extension protocol for information distribution.

```
RP/0/RP0/CPU0:router# configure
RP/0/RP0/CPU0:router(config)# mpls traffic-eng
RP/0/RP0/CPU0:router(config-mpls-te)# interface hundredGigE0/0/1/0
RP/0/RP0/CPU0:router(config)# router isis 1
RP/0/RP0/CPU0:router(config-isis)# net 47.0001.0000.0000.0002.00
RP/0/RP0/CPU0:router(config-isis)# address-family ipv4 unicast
RP/0/RP0/CPU0:router(config-isis-af)# metric-style wide
RP/0/RP0/CPU0:router(config-isis-af)# mpls traffic-eng level 1
RP/0/RP0/CPU0:router(config-isis-af)# exit
RP/0/RP0/CPU0:router(config-isis)# interface hundredGigE0/0/1/0
RP/0/RP0/CPU0:router(config-isis-if)# exit
RP/0/RP0/CPU0:router(config)# commit
```

Related Topics

- [How MPLS-TE Works, on page 3](#)
- [Creating an MPLS-TE Tunnel, on page 5](#)

Creating an MPLS-TE Tunnel

Creating an MPLS-TE tunnel is a process of customizing the traffic engineering to fit your network topology. The MPLS-TE tunnel is created at the headend router. You need to specify the destination and path of the TE LSP.

To steer traffic through the tunnel, you can use the following ways:

- Static Routing
- Autoroute Announce
- Forwarding Adjacency

From the 7.1.1 release, IS-IS autoroute announce function is enhanced to redirect traffic from a source IP address prefix to a matching IP address assigned to an MPLS-TE tunnel destination interface.



Note Configuring Segment Routing and [Autoroute Destination](#) together is not supported. If autoroute functionality is required in an Segment Routing network, we recommend you to configure Autoroute Announce.

Before You Begin

The following prerequisites are required to create an MPLS-TE tunnel:

- You must have a router ID for the neighboring router.
- Stable router ID is required at either end of the link to ensure that the link is successful. If you do not assign a router ID to the routers, the system defaults to the global router ID. Default router IDs are subject to change, which can result in an unstable link.

Configuration Example

This example configures an MPLS-TE tunnel on the headend router with a destination IP address 192.168.92.125. The bandwidth for the tunnel, path-option, and forwarding parameters of the tunnel are also configured. You can use static routing, autoroute announce or forwarding adjacency to steer traffic through the tunnel.

```
RP/0/RP0/CPU0:router# configure
RP/0/RP0/CPU0:router(config)# interface tunnel-te 1
RP/0/RP0/CPU0:router(config-if)# destination 192.168.92.125
RP/0/RP0/CPU0:router(config-if)# ipv4 unnumbered Loopback0
RP/0/RP0/CPU0:router(config-if)# path-option 1 dynamic
RP/0/RP0/CPU0:router(config-if)# autoroute announce or forwarding adjacency
RP/0/RP0/CPU0:router(config-if)# signalled-bandwidth 100
RP/0/RP0/CPU0:router(config)# commit
```

Verification

Verify the configuration of MPLS-TE tunnel using the following command.

```
RP/0/RP0/CPU0:router# show mpls traffic-engineering tunnels brief

Signalling Summary:
  LSP Tunnels Process: running
  RSVP Process:       running
  Forwarding:         enabled
  Periodic reoptimization: every 3600 seconds, next in 2538 seconds
  Periodic FRR Promotion: every 300 seconds, next in 38 seconds
  Auto-bw enabled tunnels: 0 (disabled)
  TUNNEL NAME          DESTINATION          STATUS  STATE
-----
  tunnel-te1          192.168.92.125      up      up
Displayed 1 up, 0 down, 0 recovering, 0 recovered heads
```

Automatic Modification Of An MPLS-TE Tunnel's Metric

If the IGP calculation on a router results in an equal cost multipath (ECMP) scenario where next-hop interfaces are a mix of MPLS-TE tunnels and physical interfaces, you may want to ensure that a TE tunnel is preferred. Consider this topology:

Figure 1: MPLS-TE Tunnel

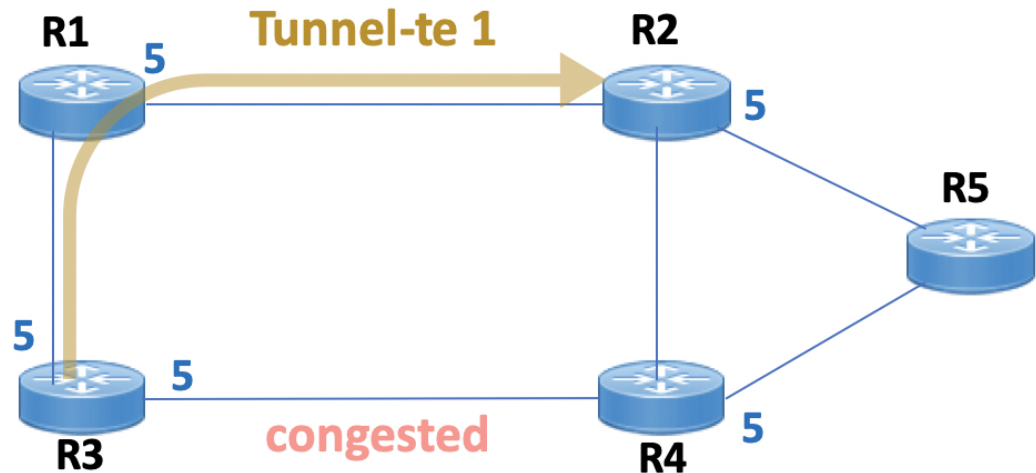

1. All links in the network have a metric of 5.
2. To offload a congested link between R3 and R4, an MPLS-TE tunnel is created from R3 to R2.
3. If the metric of the tunnel is also 5, traffic from R3 to R5 is load-balanced between the tunnel and the physical R3-R4 link.

To ensure that the MPLS-TE tunnel is preferred in such scenarios, configure the **autoroute metric** command on the tunnel interface. The modified metric is applied in the routing information base (RIB), and the tunnel is preferred over the physical path of the same metric. Sample configuration:

```
Router# configure
Router(config)# interface tunnel-te 1
Router(config-if)# autoroute metric relative -1
```

The **autoroute metric** command syntax is **autoroute metric {absolute|relative} value**

- **absolute** enables the absolute metric mode, for a metric range between 1 and 2147483647.
- **relative** enables the relative metric mode, for a metric range between -10 and 10, including zero.



Note Since the **relative** metric is not saved in the IGP database, the advertised metric of the MPLS-TE tunnel remains 5, and doesn't affect SPF calculation outcomes on other nodes.

Related Topics

- [How MPLS-TE Works, on page 3](#)
- [Building MPLS-TE Topology, on page 4](#)

Configuring Fast Reroute

Fast reroute (FRR) provides link protection to LSPs enabling the traffic carried by LSPs that encounter a failed link to be rerouted around the failure. The reroute decision is controlled locally by the router connected to the failed link. The headend router on the tunnel is notified of the link failure through IGP or through RSVP. When it is notified of a link failure, the headend router attempts to establish a new LSP that bypasses the failure. This provides a path to reestablish links that fail, providing protection to data transfer. The path of the backup tunnel can be an IP explicit path, a dynamically calculated path, or a semi-dynamic path. For detailed conceptual information on fast reroute, see [MPLS-TE Features - Details, on page 25](#)

Before You Begin

The following prerequisites are required to create an MPLS-TE tunnel:

- You must have a router ID for the neighboring router.
- Stable router ID is required at either end of the link to ensure that the link is successful. If you do not assign a router ID to the routers, the system defaults to the global router ID. Default router IDs are subject to change, which can result in an unstable link.

Configuration Example

This example configures fast reroute on an MPLS-TE tunnel. Here, tunnel-te 2 is configured as the back-up tunnel. You can use the **protected-by** command to configure path protection for an explicit path that is protected by another path.

```
RP/0/RP0/CPU0:router # configure
RP/0/RP0/CPU0:router(config)# interface tunnel-te 1
RP/0/RP0/CPU0:router(config-if)# fast-reroute
RP/0/RP0/CPU0:router(config-if)# exit
RP/0/RP0/CPU0:router(config)# mpls traffic-eng
RP/0/RP0/CPU0:router(config-mpls-te)# interface HundredGigabitEthernet0/0/1/0
RP/0/RP0/CPU0:router(config-mpls-te-if)# backup-path tunnel-te 2
RP/0/RP0/CPU0:router(config)# interface tunnel-te 2
RP/0/RP0/CPU0:router(config-if)# backup-bw global-pool 5000
RP/0/RP0/CPU0:router(config-if)# ipv4 unnumbered Loopback0
RP/0/RP0/CPU0:router(config-if)# destination 192.168.92.125
RP/0/RP0/CPU0:router(config-if)# path-option 1 explicit name backup-path protected by 10
RP/0/RP0/CPU0:router(config-if)# path-option 10 dynamic
RP/0/RP0/CPU0:router(config)# commit
```

Verification

Use the **show mpls traffic-eng fast-reroute database** command to verify the fast reroute configuration.

```
RP/0/RP0/CPU0:router# show mpls traffic-eng fast-reroute database
```

```
Tunnel head FRR information:
Tunnel      Out intf/label          FRR intf/label      Status
-----
tt4000      HundredGigabitEthernet 0/0/1/0:34          tt1000:34           Ready
tt4001      HundredGigabitEthernet 0/0/1/0:35          tt1001:35           Ready
tt4002      HundredGigabitEthernet 0/0/1/0:36          tt1001:36           Ready
```

Related Topics

- [Configuring MPLS-TE, on page 4](#)

- [Configuring Auto-Tunnel Backup, on page 9](#)
- [Configuring Next Hop Backup Tunnel, on page 10](#)
- [MPLS-TE Features - Details, on page 25](#)

Configuring Auto-Tunnel Backup

The MPLS Traffic Engineering Auto-Tunnel Backup feature enables a router to dynamically build backup tunnels on the interfaces that are configured with MPLS TE tunnels instead of building MPLS-TE tunnels statically.

The MPLS-TE Auto-Tunnel Backup feature has these benefits:

- Backup tunnels are built automatically, eliminating the need for users to pre-configure each backup tunnel and then assign the backup tunnel to the protected interface.
- Protection is expanded—FRR does not protect IP traffic that is not using the TE tunnel or Label Distribution Protocol (LDP) labels that are not using the TE tunnel.

The TE attribute-set template that specifies a set of TE tunnel attributes, is locally configured at the headend of auto-tunnels. The control plane triggers the automatic provisioning of a corresponding TE tunnel, whose characteristics are specified in the respective attribute-set.

Configuration Example

This example configures Auto-Tunnel backup on an interface and specifies the attribute-set template for the auto tunnels. In this example, unused backup tunnels are removed every 20 minutes using a timer and also the range of tunnel interface numbers are specified.

```
RP/0/RP0/CPU0:router # configure
RP/0/RP0/CPU0:router(config)# mpls traffic-eng
RP/0/RP0/CPU0:router(config-mpls-te)# interface HundredGigabitEthernet0/0/30/0/1/0
RP/0/RP0/CPU0:router(config-mpls-te-if)# auto-tunnel backup
RP/0/RP0/CPU0:router(config-mpls-te-if-auto-backup)# attribute-set ab
RP/0/RP0/CPU0:router(config-mpls-te)# auto-tunnel backup timers removal unused 20
RP/0/RP0/CPU0:router(config-mpls-te)# auto-tunnel backup tunnel-id min 6000 max 6500
RP/0/RP0/CPU0:router(config)# commit
```

Verification

This example shows a sample output for automatic backup tunnel configuration.

```
RP/0/RP0/CPU0:router# show mpls traffic-eng tunnels brief
```

TUNNEL NAME	DESTINATION	STATUS	STATE
tunnel-te0	200.0.0.3	up	up
tunnel-te1	200.0.0.3	up	up
tunnel-te2	200.0.0.3	up	up
tunnel-te50	200.0.0.3	up	up
*tunnel-te60	200.0.0.3	up	up
*tunnel-te70	200.0.0.3	up	up
*tunnel-te80	200.0.0.3	up	up

Related Topics

- [Configuring Fast Reroute , on page 8](#)

- [Configuring Next Hop Backup Tunnel, on page 10](#)
- [MPLS-TE Features - Details, on page 25](#)

Configuring Next Hop Backup Tunnel

The backup tunnels that bypass only a single link of the LSP path are referred as Next Hop (NHOP) backup tunnels because they terminate at the LSP's next hop beyond the point of failure. They protect LSPs, if a link along their path fails, by rerouting the LSP traffic to the next hop, thus bypassing the failed link.

Configuration Example

This example configures next hop backup tunnel on an interface and specifies the attribute-set template for the auto tunnels. In this example, unused backup tunnels are removed every 20 minutes using a timer and also the range of tunnel interface numbers are specified.

```
RP/0/RP0/CPU0:router # configure
RP/0/RP0/CPU0:router(config)# mpls traffic-eng
RP/0/RP0/CPU0:router(config-mpls-te)# interface HundredGigabitEthernet0/0/1/0
RP/0/RP0/CPU0:router(config-mpls-te-if)# auto-tunnel backup nhop-only
RP/0/RP0/CPU0:router(config-mpls-te-if-auto-backup)# attribute-set ab
RP/0/RP0/CPU0:router(config-mpls-te)# auto-tunnel backup timers removal unused 20
RP/0/RP0/CPU0:router(config-mpls-te)# auto-tunnel backup tunnel-id min 6000 max 6500
RP/0/RP0/CPU0:router(config)# commit
```

Related Topics

- [Configuring Auto-Tunnel Backup, on page 9](#)
- [Configuring Fast Reroute , on page 8](#)
- [MPLS-TE Features - Details, on page 25](#)

Configuring SRLG Node Protection

Shared Risk Link Groups (SRLG) in MPLS traffic engineering refer to situations in which links in a network share common resources. These links have a shared risk, and that is when one link fails, other links in the group might fail too.

OSPF and IS-IS flood the SRLG value information (including other TE link attributes such as bandwidth availability and affinity) using a sub-type length value (sub-TLV), so that all routers in the network have the SRLG information for each link.

MPLS-TE SRLG feature enhances backup tunnel path selection by avoiding using links that are in the same SRLG as the interfaces it is protecting while creating backup tunnels.

Configuration Example

This example creates a backup tunnel and excludes the protected node IP address from the explicit path.

```
RP/0/RP0/CPU0:router # configure
RP/0/RP0/CPU0:router(config)# mpls traffic-eng
RP/0/RP0/CPU0:router(config-mpls-te)# interface HundredGigabitEthernet0/0/0/30/0/1/0
RP/0/RP0/CPU0:router(config-mpls-te-if)# backup-path tunnel-te 2
RP/0/RP0/CPU0:router(config-mpls-te-if)# exit
```

```

RP/0/RP0/CPU0:router(config)# interface tunnel-te 2
RP/0/RP0/CPU0:router(config-if)# ipv4 unnumbered Loopback0
RP/0/RP0/CPU0:router(config-if)# path-option 1 explicit name backup-srlg
RP/0/RP0/CPU0:router(config-if)# destination 192.168.92.125
RP/0/RP0/CPU0:router(config-if)# exit
RP/0/RP0/CPU0:router(config)# explicit-path name backup-srlg-noddep
RP/0/RP0/CPU0:router(config-if)# index 1 exclude-address 192.168.91.1
RP/0/RP0/CPU0:router(config-if)# index 2 exclude-srlg 192.168.92.2
RP/0/RP0/CPU0:router(config)# commit

```

Related Topics

- [Configuring Fast Reroute](#) , on page 8
- [MPLS-TE Features - Details](#), on page 25

Configuring Pre-Standard DS-TE

Regular traffic engineering does not provide bandwidth guarantees to different traffic classes. A single bandwidth constraint is used in regular TE that is shared by all traffic. MPLS DS-TE enables you to configure multiple bandwidth constraints on an MPLS-enabled interface. These bandwidth constraints can be treated differently based on the requirement for the traffic class using that constraint. Cisco IOS XR software supports two DS-TE modes: Pre-standard and IETF. Pre-standard DS-TE uses the Cisco proprietary mechanisms for RSVP signaling and IGP advertisements. This DS-TE mode does not interoperate with third-party vendor equipment. Pre-standard DS-TE is enabled only after configuring the sub-pool bandwidth values on MPLS-enabled interfaces.

Pre-standard Diff-Serve TE mode supports a single bandwidth constraint model a Russian Doll Model (RDM) with two bandwidth pools: global-pool and sub-pool.

Before You Begin

The following prerequisites are required to configure a Pre-standard DS-TE tunnel.

- You must have a router ID for the neighboring router.
- Stable router ID is required at either end of the link to ensure that the link is successful. If you do not assign a router ID to the routers, the system defaults to the global router ID. Default router IDs are subject to change, which can result in an unstable link.

Configuration Example

This example configures a pre-standard DS-TE tunnel.

```

RP/0/RP0/CPU0:router # configure
RP/0/RP0/CPU0:router(config)# rsvp interface HundredGigabitEthernet 0/0/0/3
RP/0/RP0/CPU0:router(config-rsvp-if)# bandwidth 100 150 sub-pool 50
RP/0/RP0/CPU0:router(config-rsvp-if)# exit
RP/0/RP0/CPU0:router(config)# interface tunnel-te 2
RP/0/RP0/CPU0:router(config-if)# signalled bandwidth sub-pool 10
RP/0/RP0/CPU0:router(config)# commit

```

Verification

Use the **show mpls traffic-eng topology** command to verify the pre-standard DS-TE tunnel configuration.

Related Topics

- [Configuring an IETF DS-TE Tunnel Using RDM, on page 12](#)
- [Configuring an IETF DS-TE Tunnel Using MAM, on page 13](#)
- [MPLS-TE Features - Details, on page 25](#)

Configuring an IETF DS-TE Tunnel Using RDM

IETF DS-TE mode uses IETF-defined extensions for RSVP and IGP. This mode interoperates with third-party vendor equipment.

IETF mode supports multiple bandwidth constraint models, including Russian Doll Model (RDM) and Maximum Allocation Model (MAM), both with two bandwidth pools. In an IETF DS-TE network, identical bandwidth constraint models must be configured on all nodes.

Before you Begin

The following prerequisites are required to create an IETF mode DS-TE tunnel using RDM:

- You must have a router ID for the neighboring router.
- Stable router ID is required at either end of the link to ensure that the link is successful. If you do not assign a router ID to the routers, the system defaults to the global router ID. Default router IDs are subject to change, which can result in an unstable link.

Configuration Example

This example configures an IETF DS-TE tunnel using RDM.

```
RP/0/RP0/CPU0:router # configure
RP/0/RP0/CPU0:router(config)# rsvp interface HundredGigabitEthernet 0/0/0/3
RP/0/RP0/CPU0:router(config-rsvp-if)# bandwidth rdm 100 150
RP/0/RP0/CPU0:router(config-rsvp-if)# exit
RP/0/RP0/CPU0:router(config)# mpls traffic-eng
RP/0/RP0/CPU0:router(config-mpls-te)# ds-te mode ietf
RP/0/RP0/CPU0:router(config-mpls-te)# exit
RP/0/RP0/CPU0:router(config)# interface tunnel-te 2
RP/0/RP0/CPU0:router(config-if)# signalled bandwidth sub-pool 10
RP/0/RP0/CPU0:router(config)# commit
```

Verification

Use the **show mpls traffic-eng topology** command to verify the IETF DS-TE tunnel using RDM configuration.

Related Topics

- [Configuring Pre-Standard DS-TE, on page 11](#)
- [Configuring an IETF DS-TE Tunnel Using MAM, on page 13](#)

- [MPLS-TE Features - Details, on page 25](#)

Configuring an IETF DS-TE Tunnel Using MAM

IETF DS-TE mode uses IETF-defined extensions for RSVP and IGP. This mode interoperates with third-party vendor equipment. IETF mode supports multiple bandwidth constraint models, including Russian Doll Model (RDM) and Maximum Allocation Model (MAM), both with two bandwidth pools.

Configuration Example

This example configures an IETF DS-TE tunnel using MAM.

```
RP/0/RP0/CPU0:router # configure
RP/0/RP0/CPU0:router(config)# rsvp interface HundredGigabitEthernet 0/0/0/3
RP/0/RP0/CPU0:router(config-rsvp-if)# bandwidth mam max-reservable-bw 1000 bc0 600 bc1 400
RP/0/RP0/CPU0:router(config-rsvp-if)# exit
RP/0/RP0/CPU0:router(config)# mpls traffic-eng
RP/0/RP0/CPU0:router(config-mpls-te)# ds-te mode ietf
RP/0/RP0/CPU0:router(config-mpls-te)# ds-te bc-model mam
RP/0/RP0/CPU0:router(config-mpls-te)# exit
RP/0/RP0/CPU0:router(config)# interface tunnel-te 2
RP/0/RP0/CPU0:router(config-if)# signalled bandwidth sub-pool 10
RP/0/RP0/CPU0:router(config)# commit
```

Verification

Use the **show mpls traffic-eng topology** command to verify the IETF DS-TE tunnel using MAM configuration.

Related Topics

- [Configuring an IETF DS-TE Tunnel Using RDM, on page 12](#)
- [Configuring Pre-Standard DS-TE, on page 11](#)
- [MPLS-TE Features - Details, on page 25](#)

Configuring Flexible Name-Based Tunnel Constraints

MPLS-TE Flexible Name-based Tunnel Constraints provides a simplified and more flexible means of configuring link attributes and path affinities to compute paths for the MPLS-TE tunnels.

In traditional TE, links are configured with attribute-flags that are flooded with TE link-state parameters using Interior Gateway Protocols (IGPs), such as Open Shortest Path First (OSPF).

MPLS-TE Flexible Name-based Tunnel Constraints lets you assign, or map, up to 32 color names for affinity and attribute-flag attributes instead of 32-bit hexadecimal numbers. After mappings are defined, the attributes can be referred to by the corresponding color name.

Configuration Example

This example shows assigning a how to associate a tunnel with affinity constraints.

```
RP/0/RP0/CPU0:router# configure
RP/0/RP0/CPU0:router(config)# mpls traffic-eng
```

```

RP/0/RP0/CPU0:router(config-mpls-te)# affinity-map red 1
RP/0/RP0/CPU0:router(config-mpls-te)# interface HundredGigabitEthernet0/0/0/30/0/1/0
RP/0/RP0/CPU0:router(config-mpls-te-if)# attribute-names red
RP/0/RP0/CPU0:router(config)# interface tunnel-te 2
RP/0/RP0/CPU0:router(config-if)# affinity include red
RP/0/RP0/CPU0:router(config)# commit

```

Configuring Automatic Bandwidth

Automatic bandwidth allows you to dynamically adjust bandwidth reservation based on measured traffic. MPLS-TE automatic bandwidth monitors the traffic rate on a tunnel interface and resizes the bandwidth on the tunnel interface to align it closely with the traffic in the tunnel. MPLS-TE automatic bandwidth is configured on individual Label Switched Paths (LSPs) at every headend router.

The following table specifies the parameters that can be configured as part of automatic bandwidth configuration.

Table 1: Automatic Bandwidth Parameters

Bandwidth Parameters	Description
Application frequency	Configures how often the tunnel bandwidths changed for each tunnel. The default value is 24 hours.
Bandwidth limit	Configures the minimum and maximum automatic bandwidth to set on a tunnel.
Bandwidth collection frequency	Enables bandwidth collection without adjusting the automatic bandwidth. The default value is 5 minutes.
Overflow threshold	Configures tunnel overflow detection.
Adjustment threshold	Configures the tunnel-bandwidth change threshold to trigger an adjustment.

Configuration Example

This example enables automatic bandwidth on MPLS-TE tunnel interface and configure the following automatic bandwidth variables.

- Application frequency
- Bandwidth limit
- Adjustment threshold
- Overflow detection

```

RP/0/RP0/CPU0:router# configure
RP/0/RP0/CPU0:router(config)# interface tunnel-te 1
RP/0/RP0/CPU0:router(config-if)# auto-bw
RP/0/RP0/CPU0:router(config-if-tunte-autobw)# application 1000
RP/0/RP0/CPU0:router(config-if-tunte-autobw)# bw-limit min 30 max 1000
RP/0/RP0/CPU0:router(config-if-tunte-autobw)# adjustment-threshold 50 min 800
RP/0/RP0/CPU0:router(config-if-tunte-autobw)# overflow threshold 100 limit 1
RP/0/RP0/CPU0:router(config)# commit

```

Verification

Verify the automatic bandwidth configuration using the **show mpls traffic-eng tunnels auto-bw brief** command.

```
RP/0/RP0/CPU0:router# show mpls traffic-eng tunnels auto-bw brief
```

Tunnel Name	LSP ID	Last appl BW (kbps)	Requested BW (kbps)	Signalled BW (kbps)	Highest BW (kbps)	Application Time Left
tunnel-te1		5	500	300	420	1h 10m

Related Topics

- [MPLS-TE Features - Details, on page 25](#)

Configuring Auto-Tunnel Mesh

The MPLS-TE auto-tunnel mesh (auto-mesh) feature allows you to set up full mesh of TE Point-to-Point (P2P) tunnels automatically with a minimal set of MPLS traffic engineering configurations. You can configure one or more mesh-groups and each mesh-group requires a destination-list (IPv4 prefix-list) listing destinations, which are used as destinations for creating tunnels for that mesh-group.

You can configure MPLS-TE auto-mesh type attribute-sets (templates) and associate them to mesh-groups. Label Switching Routers (LSRs) can create tunnels using the tunnel properties defined in this attribute-set.

Auto-Tunnel mesh configuration minimizes the initial configuration of the network. You can configure tunnel properties template and mesh-groups or destination-lists on TE LSRs that further creates full mesh of TE tunnels between those LSRs. It eliminates the need to reconfigure each existing TE LSR in order to establish a full mesh of TE tunnels whenever a new TE LSR is added in the network.

Configuration Example

This example configures an auto-tunnel mesh group and specifies the attributes for the tunnels in the mesh-group.

```
RP/0/RP0/CPU0:router # configure
RP/0/RP0/CPU0:router(config)# mpls traffic-eng
RP/0/RP0/CPU0:router(config-mpls-te)# auto-tunnel mesh
RP/0/RP0/CPU0:router(config-mpls-te-auto-mesh)# tunnel-id min 1000 max 2000
RP/0/RP0/CPU0:router(config-mpls-te-auto-mesh)# group 10
RP/0/RP0/CPU0:router(config-mpls-te-auto-mesh-group)# attribute-set 10
RP/0/RP0/CPU0:router(config-mpls-te-auto-mesh-group)# destination-list dl-65
RP/0/RP0/CPU0:router(config-mpls-te)# attribute-set auto-mesh 10
RP/0/RP0/CPU0:router(config-mpls-te-attribute-set)# autoroute announce
RP/0/RP0/CPU0:router(config-mpls-te-attribute-set)# auto-bw collect-bw-only
RP/0/RP0/CPU0:router(config)# commit
```

Verification

Verify the auto-tunnel mesh configuration using the **show mpls traffic-eng auto-tunnel mesh** command.

```
RP/0/RP0/CPU0:router# show mpls traffic-eng auto-tunnel mesh
```

```
Auto-tunnel Mesh Global Configuration:
  Unused removal timeout: 1h 0m 0s
  Configured tunnel number range: 1000-2000
```

```

Auto-tunnel Mesh Groups Summary:
Mesh Groups count: 1
Mesh Groups Destinations count: 3
Mesh Groups Tunnels count:
  3 created, 3 up, 0 down, 0 FRR enabled

Mesh Group: 10 (3 Destinations)
Status: Enabled
Attribute-set: 10
Destination-list: dl-65 (Not a prefix-list)
Recreate timer: Not running
-----
Destination      Tunnel ID      State      Unused timer
-----
192.168.0.2      1000          up        Not running
192.168.0.3      1001          up        Not running
192.168.0.4      1002          up        Not running
-----
Displayed 3 tunnels, 3 up, 0 down, 0 FRR enabled

Auto-mesh Cumulative Counters:
Last cleared: Wed Oct  3 12:56:37 2015 (02:39:07 ago)
Total
Created:          3
Connected:       0
Removed (unused): 0
Removed (in use): 0
Range exceeded:  0

```

Configuring an MPLS Traffic Engineering Interarea Tunneling

The MPLS TE Interarea Tunneling feature allows you to establish MPLS TE tunnels that span multiple Interior Gateway Protocol (IGP) areas and levels. This feature removes the restriction that required the tunnel headend and tailend routers both to be in the same area. The IGP can be either Intermediate System-to-Intermediate System (IS-IS) or Open Shortest Path First (OSPF). To configure an inter-area tunnel, you specify on the headend router a loosely routed explicit path for the tunnel label switched path (LSP) that identifies each area border router (ABR) the LSP should traverse using the next-address loose command. The headend router and the ABRs along the specified explicit path expand the loose hops, each computing the path segment to the next ABR or tunnel destination.

Configuration Example

This example configures an IPv4 explicit path with ABR configured as loose address on the headend router.

```

Router# configure
Router(config)# explicit-path name interareal
Router(config-expl-path)# index 1 next-address loose ipv4 unicast 172.16.255.129
Router(config-expl-path)# index 2 next-address loose ipv4 unicast 172.16.255.131
Router(config)# interface tunnel-tel
Router(config-if)# ipv4 unnumbered Loopback0
Router(config-if)# destination 172.16.255.2
Router(config-if)# path-option 10 explicit name interareal
Router(config)# commit

```

Configure Policy-Based Tunnel Selection

Configuring PBTS is a process of directing incoming traffic into specific TE tunnels based on a classification criteria (DSCP). The traffic forwarding decisions are made based on the categorized traffic classes and the

destination network addresses. The following section lists the steps to configure PBTS on a MPLS-TE Tunnel network:

1. Define a class-map based on a classification criteria.
2. Define a policy-map by creating rules for the classified traffic.
3. Associate a forward-class to each type of ingress traffic.
4. Enable PBTS on the ingress interface, by applying this service-policy.
5. Create one or more egress MPLS-TE Tunnels (to carry packets based on priority) to the destination.
6. Associate the egress MPLS-TE Tunnel to a forward-class.

For more information on PBTS, see [Policy-Based Tunnel Selection](#), on page 28 in the *Implementing MPLS Traffic Engineering* chapter.

Configuration Example

The following section illustrates PBTS implementation:

```
RP/0/RP0/CPU0:router#configure
/* Class-map; classification using DSCP */
RP/0/RP0/CPU0:router(config)# class-map match-any AF41-Class
RP/0/RP0/CPU0:router(config-cmap)# match dscp AF41
RP/0/RP0/CPU0:router(config-cmap)# exit

/* Policy-map */
RP/0/RP0/CPU0:router(config)# policy-map INGRESS-POLICY
RP/0/RP0/CPU0:router(config-pmap)# class AF41-Class
/* Associating forward class */
RP/0/RP0/CPU0:router(config-pmap-c)# set forward-class 1
RP/0/RP0/CPU0:router(config-pmap-c)# exit
RP/0/RP0/CPU0:router(config-pmap)# exit

RP/0/RP0/CPU0:router(config)# interface GigabitEthernet0/0/0/1
/* Applying service-policy to ingress interface */
RP/0/RP0/CPU0:router(config-if)# service-policy input INGRESS-POLICY
RP/0/RP0/CPU0:router(config-if)# ipv4 address 10.1.1.1 255.255.255.0
RP/0/RP0/CPU0:router(config-if)# exit

/* Creating TE-tunnels to carry traffic based on priority */
RP/0/RP0/CPU0:router(config)# interface tunnel-te61
RP/0/RP0/CPU0:router(config-if)# ipv4 unnumbered Loopback0
RP/0/RP0/CPU0:router(config-if)# signalled-bandwidth 1000
RP/0/RP0/CPU0:router(config-if)# autoroute announce
RP/0/RP0/CPU0:router(config-if)# destination 10.20.20.1
RP/0/RP0/CPU0:router(config-if)# record route

/* Associating egress TE tunnels to forward class */
RP/0/RP0/CPU0:router(config-if)# forward-class 1
RP/0/RP0/CPU0:router(config-if)# path-option 1 explicit identifier 61
RP/0/RP0/CPU0:router(config-if)# exit
```

Verification

Use `show mpls forwarding tunnels` command to verify the PBTS configuration:

```
RP/0/RP0/CPU0:ios# show mpls forwarding tunnels 10 detail
Tue May 16 01:18:19.681 UTC
```

```

Tunnel      Outgoing      Outgoing      Next Hop      Bytes
Name        Label          Interface     20.20.17.21   Switched
-----
tt10        Exp-Null-v4   Te0/0/0/16   20.20.17.21   0
Updated: May 11 19:31:54.716
Version: 483, Priority: 2
Label Stack (Top -> Bottom): { 0 }
NHID: 0x0, Encap-ID: N/A, Path idx: 0, Backup path idx: 0, Weight: 0
MAC/Encaps: 14/18, MTU: 1500
Packets Switched: 0

Interface:
Name: tunnel-te10 (ifhandle 0x0800005c)
Local Label: 64016, Forwarding Class: 1, Weight: 0

Packets/Bytes Switched: 0/0

```

Configuring LDP over MPLS-TE

LDP and RSVP-TE are signaling protocols used for establishing LSPs in MPLS networks. While LDP is easy to configure and reliable, it lacks the traffic engineering capabilities of RSVP that helps to avoid traffic congestions. LDP over MPLS-TE feature combines the benefits of both LDP and RSVP. In LDP over MPLS-TE, an LDP signalled label-switched path (LSP) runs through a TE tunnel established using RSVP-TE.

The following diagram explains a use case for LDP over MPLS-TE. In this diagram, LDP is used as the signalling protocol between provider edge (PE) router and provider (P) router. RSVP-TE is used as the signalling protocol between the P routers to establish an LSP. LDP is tunneled over the RSVP-TE LSP.

Figure 2: LDP over MPLS-TE

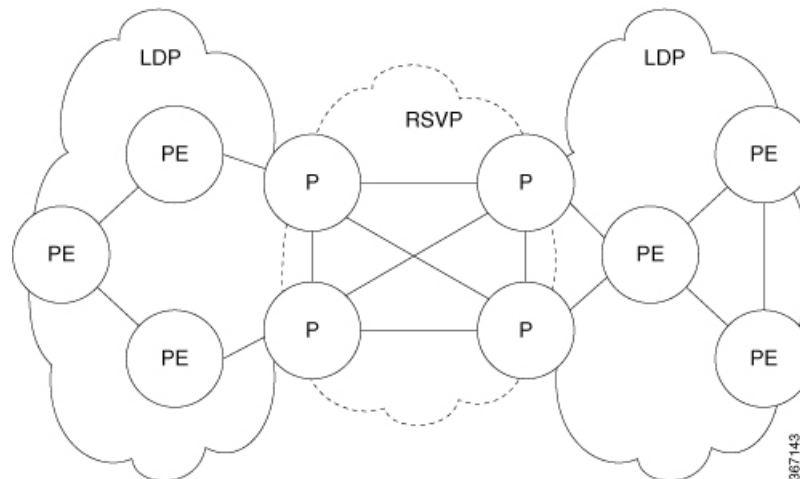

Restrictions and Guidelines for LDP over MPLS-TE

The following restrictions and guidelines apply for this feature in Cisco IOS-XR release 6.3.2:

- MPLS services over LDP over MPLS-TE are supported when BGP neighbours are on the head or tail node of the TE tunnel.
- MPLS services over LDP over MPLS-TE are supported when the TE headend router is acting as transit point for that service.

- If MPLS services are originating from the TE headend, but the TE tunnel is ending before the BGP peer, LDP over MPLS-TE feature is not supported.
- If LDP optimization is enabled using the **hw-module fib mpls ldp lsr-optimized** command, the following restrictions apply:
 - EVPN is not supported.
 - For any prefix or label all outgoing paths has to be LDP enabled.
- Do not use the **hw-module fib mpls ldp lsr-optimized** command on a Provider Edge (PE) router because already configured features such as EVPN, MPLS-VPN, and L2VPN might not work properly.

Configuration Example:

This example shows how to configure an MPLS-TE tunnel from provider router P1 to P2 and then enable LDP over MPLS-TE. In this example, the destination of the tunnel from P1 is configured as the loop back for P2.

```
RP/0/RP0/CPU0:router # configure
RP/0/RP0/CPU0:router(config)# interface tunnel-te 1
RP/0/RP0/CPU0:router(config-if)# ipv4 unnumbered Loopback0
RP/0/RP0/CPU0:router(config-if)# autoroute announce
RP/0/RP0/CPU0:router(config-if)# destination 4.4.4.4
RP/0/RP0/CPU0:router(config-if)# path-option 1 dynamic
RP/0/RP0/CPU0:router(config-if)# exit
RP/0/RP0/CPU0:Router(config)# mpls ldp
RP/0/RP0/CPU0:Router(config-ldp)# router-id 192.168.1.1
RP/0/RP0/CPU0:Router(config-ldp)# interface TenGigE 0/0/0/0
RP/0/RP0/CPU0:Router(config-ldp-if)# interface tunnel-te 1
RP/0/RP0/CPU0:Router(config-ldp-if)# exit
```

Configuring MPLS-TE Path Protection

Path protection provides an end-to-end failure recovery mechanism for MPLS-TE tunnels. A secondary Label Switched Path (LSP) is established, in advance, to provide failure protection for the protected LSP that is carrying a tunnel's TE traffic. When there is a failure on the protected LSP, the source router immediately enables the secondary LSP to temporarily carry the tunnel's traffic. Failover is triggered by a RSVP error message sent to the LSP head end. Once the head end received this error message, it switches over to the secondary tunnel. If there is a failure on the secondary LSP, the tunnel no longer has path protection until the failure along the secondary path is cleared. Path protection can be used within a single area (OSPF or IS-IS), external BGP [eBGP], and static routes. Both the explicit and dynamic path-options are supported for the MPLS-TE path protection feature. You should make sure that the same attributes or bandwidth requirements are configured on the protected option.

Before You Begin

The following prerequisites are required for enabling path protection.

- You should ensure that your network supports MPLS-TE, Cisco Express Forwarding, and Intermediate System-to-Intermediate System (IS-IS) or Open Shortest Path First (OSPF).
- You should configure MPLS-TE on the routers.

Configuration Example

This example configures how to configure path protection for a mpls-te tunnel. The primary path-option should be present to configure path protection. In this configuration, R1 is the headend router and R3 is the tailend router for the tunnel while R2 and R4 are mid-point routers. In this example, 6 explicit paths and 1 dynamic path is created for path protection. You can have upto 8 path protection options for a primary path.

```
RP/0/RP0/CPU0:router # configure
RP/0/RP0/CPU0:router(config)# interface tunnel-te 0
RP/0/RP0/CPU0:router(config-if)# destination 192.168.3.3
RP/0/RP0/CPU0:router(config-if)# ipv4 unnumbered Loopback0
RP/0/RP0/CPU0:router(config-if)# autoroute announce
RP/0/RP0/CPU0:router(config-if)# path-protection
RP/0/RP0/CPU0:router(config-if)# path-option 1 explicit name r1-r2-r3-00 protected-by 2
RP/0/RP0/CPU0:router(config-if)# path-option 2 explicit name r1-r2-r3-01 protected-by 3
RP/0/RP0/CPU0:router(config-if)# path-option 3 explicit name r1-r4-r3-01 protected-by 4
RP/0/RP0/CPU0:router(config-if)# path-option 4 explicit name r1-r3-00 protected-by 5
RP/0/RP0/CPU0:router(config-if)# path-option 5 explicit name r1-r2-r4-r3-00 protected-by 6
RP/0/RP0/CPU0:router(config-if)# path-option 6 explicit name r1-r4-r2-r3-00 protected-by 7
RP/0/RP0/CPU0:router(config-if)# path-option 7 dynamic
RP/0/RP0/CPU0:router(config-if)# exit
RP/0/RP0/CPU0:router(config)# commit
```

Verification

Use the **show mpls traffic-eng tunnels** command to verify the MPLS-TE path protection configuration.

```
RP/0/RP0/CPU0:router# show mpls traffic-eng tunnels 0
Fri Oct 13 16:24:39.379 UTC
Name: tunnel-te0 Destination: 192.168.92.125 Ifhandle:0x8007d34
Signalled-Name: router
Status:
  Admin:    up Oper:    up Path:  valid Signalling: connected
  path option 1, type explicit r1-r2-r3-00 (Basis for Setup, path weight 2)
    Protected-by PO index: 2
  path option 2, type explicit r1-r2-r3-01 (Basis for Standby, path weight 2)
    Protected-by PO index: 3
  path option 3, type explicit r1-r4-r3-01
    Protected-by PO index: 4
  path option 4, type explicit r1-r3-00
    Protected-by PO index: 5
  path option 5, type explicit r1-r2-r4-r3-00
    Protected-by PO index: 6
  path option 6, type explicit r1-r4-r2-r3-00
    Protected-by PO index: 7
  path option 7, type dynamic
G-PID: 0x0800 (derived from egress interface properties)
Bandwidth Requested: 0 kbps CT0
Creation Time: Fri Oct 13 15:05:28 2017 (01:19:11 ago)
Config Parameters:
  Bandwidth:    0 kbps (CT0) Priority:  7 7 Affinity: 0x0/0xffff
  Metric Type: TE (global)
  Path Selection:
    Tiebreaker: Min-fill (default)
  Hop-limit: disabled
  Cost-limit: disabled
  Delay-limit: disabled
  Path-invalidation timeout: 10000 msec (default), Action: Tear (default)
  AutoRoute: enabled LockDown: disabled Policy class: not set
  Forward class: 0 (not enabled)
  Forwarding-Adjacency: disabled
  Autoroute Destinations: 0
  Loadshare:    0 equal loadshares
```

```
Auto-bw: disabled
Fast Reroute: Disabled, Protection Desired: None
Path Protection: Enabled
BFD Fast Detection: Disabled
Reoptimization after affinity failure: Enabled
Soft Preemption: Disabled
History:
Tunnel has been up for: 01:14:13 (since Fri Oct 13 15:10:26 UTC 2017)
Current LSP:
  Uptime: 01:14:13 (since Fri Oct 13 15:10:26 UTC 2017)
Reopt. LSP:
  Last Failure:
    LSP not signalled, identical to the [CURRENT] LSP
    Date/Time: Fri Oct 13 15:08:41 UTC 2017 [01:15:58 ago]
Standby Reopt LSP:
  Last Failure:
    LSP not signalled, identical to the [STANDBY] LSP
    Date/Time: Fri Oct 13 15:08:41 UTC 2017 [01:15:58 ago]
    First Destination Failed: 192.3.3.3
Prior LSP:
  ID: 8 Path Option: 1
  Removal Trigger: path protection switchover
Standby LSP:
  Uptime: 01:13:56 (since Fri Oct 13 15:10:43 UTC 2017)
Path info (OSPF 1 area 0):
Node hop count: 2
Hop0: 192.168.1.2
Hop1: 192.168.3.1
Hop2: 192.168.3.2
Hop3: 192.168.3.3
Standby LSP Path info (OSPF 1 area 0), Oper State: Up :
Node hop count: 2
Hop0: 192.168.2.2
Hop1: 192.168.3.1
Hop2: 192.168.3.2
Hop3: 192.168.3.3
Displayed 1 (of 4001) heads, 0 (of 0) midpoints, 0 (of 0) tails
Displayed 1 up, 0 down, 0 recovering, 0 recovered heads
```

Configure Autoroute Tunnel as Designated Path

Table 2: Feature History Table

Feature Name	Release Information	Feature Description
Configure Autoroute Tunnel as Designated Path	Release 7.6.2	<p>We now provide you the flexibility to simplify the path selection for a traffic class and split traffic among multiple TE tunnels.</p> <p>To split traffic, you can specify an autoroute tunnel to forward traffic to a particular tunnel destination address without considering the IS-IS metric for traffic path selection.</p> <p>IS-IS metric provides the shortest IGP path to a destination based only on link costs along the path. However, you may want to specify a tunnel interface to carry traffic regardless of IGP cost to meet your specific organizational requirements.</p> <p>Earlier, MPLS-TE considered either the Forwarding Adjacency (FA) or Autoroute (AA) tunnel for forwarding traffic based only on the IS-IS metric.</p> <p>The feature introduces the mpls traffic-eng tunnel restricted command.</p>

MPLS-TE builds a unidirectional tunnel from a source to a destination using label switched path (LSP) to forward traffic.

To forward the traffic through MPLS tunneling, you can use autoroute, forwarding adjacency, or static routing:

- Autoroute (AA) functionality allows to insert the MPLS TE tunnel in the Shortest Path First (SPF) tree for the tunnel to transport all the traffic from the headend to all destinations behind the tail-end. AA is only known to the tunnel headend router.
- Forwarding Adjacency (FA) allows the MPLS-TE tunnel to be advertised as a link in an IGP network with the cost of the link associated with it. Routers outside of the TE domain can see the TE tunnel and use it to compute the shortest path for routing traffic throughout the network.
- Static routing allows you to inject static IP traffic into a tunnel as the output interface for the routing decision.

Prior to this release, by default, MPLS-TE considers FA or AA tunnels to forward traffic based on the IS-IS metric. The lower metric is always used to forward traffic. There was no mechanism to forward traffic to a specific tunnel interface.

For certain prefixes to achieve many benefits such as security and service-level agreements, there might be a need to forward traffic to a specific tunnel interface that has a matching destination address.

With this feature, you can exclusively use AA tunnels to forward traffic to their tunnel destination address irrespective of IS-IS metric. Traffic steering is performed based on the prefixes and not metrics. Traffic to other prefixes defaults to the forwarding-adjacency (FA) tunnels.

To enable this feature, use the **mpls traffic-eng tunnel restricted** command.

Also, you may require more than one AA tunnel to a particular remote PE and use ECMP to forward traffic across AA tunnels. You can configure a loopback interface with one primary address and multiple secondary addresses on the remote PE, using one IP for the FA tunnel destination, and others for the AA tunnels destinations. Multiple IP addresses are advertised in the MPLS TE domain using the typed length value (TLV) 132 in IS-IS. A TLV-encoded data stream contains code related to the record type, the record length of the value, and value. TLV 132 represents the IP addresses of the transmitting interface.

Feature Behavior

When MPLS-TE tunnel restricted is configured, the following is the behavior:

- A complete set of candidate paths is available for selection on a per-prefix basis during RIB update as the first hop computation includes all the AA tunnels terminating on a node up to a limit of 64 and the lowest cost forwarding-adjacency or native paths terminating on the node or inherited from the parent nodes in the first hops set for the node.
- During per-prefix computation, AA tunnel first hops are used for traffic sent to their tunnel destination address even if FA tunnel or native first hops have a better metric. AA tunnel first-hops are not used for any other prefixes.
- ECMP is used when multiple AA tunnel first hops have the same destination address and metric.
- During per-prefix computation, AA tunnel first hops are used for traffic sent to their tunnel destination address, and for all other destinations on the tunnel tail node or behind it, even if a native path has a better metric.

Adding **mpls traffic-eng tunnel preferred** configuration has no effect when the tunnel restricted is already configured.

- If there's no AA tunnel or if the tunnel is down, then native paths are used for all other destinations on the tunnel tail node or behind it.

The route metric for a prefix reflects the chosen first-hop, not necessarily the lowest cost SPF distance to the node.

Restrictions for Configure Autoroute Tunnel as Designated Path

- The total number of interface addresses to the number that can be contained in 255 bytes is 63 for IPv4 and 15 for IPv6.
- When this feature is enabled, a maximum of 64 tunnels can terminate on the tail node.

Configure Autoroute Tunnel as Designated Path

Let's understand how to configure the feature using the following topology:

Figure 3: Topology

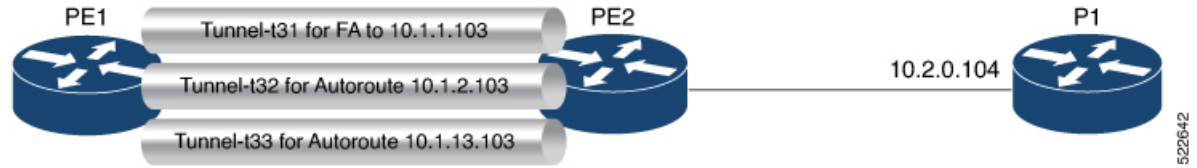

Consider the topology where PE1 has three MPLS tunnels connecting to PE2.

- Tunnel-t31: Forwarding adjacency (FA) is configured to the primary address of Loopback 0 on PE2 (10.1.1.103).
- Tunnel-t32: Autoroute announce (AA) is configured to a secondary address of Loopback 0 on PE2 (10.1.2.103).
- Tunnel-t33: Autoroute announce (AA) is configured to a secondary address of Loopback 0 on PE2 (10.1.3.103).

This feature is not enabled by default. When this feature is not enabled, traffic is load balanced over all AA tunnels towards the same remote PE provided the tunnel metric is the same:

```
Router# show routes
i L2 10.1.1.103/32 [115/40] via 10.1.2.103, 00:00:30, tunnel-t32
[115/40] via 10.1.3.103, 00:00:30, tunnel-t33
i L2 10.1.2.103/32 [115/40] via 10.1.2.103, 00:00:30, tunnel-t32
[115/40] via 10.1.3.103, 00:00:30, tunnel-t33
i L2 10.1.3.103/32 [115/40] via 10.1.2.103, 00:00:30, tunnel-t32
[115/40] via 10.1.3.103, 00:00:30, tunnel-t33
i L2 10.2.0.103/32 [115/40] via 10.1.2.103, 00:00:30, tunnel-t32
[115/40] via 10.1.3.103, 00:00:30, tunnel-t33
10.2.0.104/32 [115/50] via 10.1.2.103, 00:00:30, tunnel-t32
[115/50] via 10.1.3.103, 00:00:30, tunnel-t33
```

Configuration Example

You can configure the feature using the `mpls traffic-eng tunnel restricted` command.

```
RP/0/RSP0/CPU0:ios# configure
RP/0/RSP0/CPU0:ios(config)# router isis 1
RP/0/RSP0/CPU0:ios(config-isis)# address-family ipv4 unicast
RP/0/RSP0/CPU0:ios(config-isis-af# mpls traffic-eng tunnel restricted
```

Running Configuration

The following example shows the AA tunnel metric running configuration:

```
router isis 1
 address-family ipv4 unicast
  mpls traffic-eng tunnel restricted
!
!
end
```

Verification

When you enable the feature, traffic towards a particular prefix is sent only over the tunnel that has that IP address as destination.

```
Router# show route
i L2 10.1.1.103/32 [115/40] via 10.1.1.103, 00:00:04, tunnel-t31
i L2 10.1.2.103/32 [115/40] via 10.1.2.103, 00:00:04, tunnel-t32
i L2 10.1.3.103/32 [115/40] via 10.1.3.103, 00:00:04, tunnel-t33
i L2 10.2.0.103/32 [115/40] via 10.1.1.103, 00:00:04, tunnel-t31
i L2 10.2.0.104/32 [115/50] via 10.1.1.103, 00:00:04, tunnel-t31
```

When multiple restricted AA tunnels are created towards the same destination IP address, router load balances traffic across all those tunnels:

```
Router# show route
i L2 10.1.1.103/32 [115/40] via 10.1.1.101, 00:00:08, GigabitEthernet0/0/0/2
[115/40] via 10.1.3.101, 00:00:08, GigabitEthernet0/0/0/3
i L2 10.1.2.103/32 [115/40] via 10.1.2.103, 00:00:08, tunnel-t32
[115/40] via 10.1.2.103, 00:00:30, tunnel-t34
i L2 10.1.3.103/32 [115/40] via 10.1.3.103, 00:00:08, tunnel-t33
i L2 10.2.0.103/32 [115/40] via 10.1.1.101, 00:00:08, GigabitEthernet0/0/0/2
[115/40] via 10.1.3.101, 00:00:08, GigabitEthernet0/0/0/3
i L2 10.2.0.104/32 [115/50] via 10.1.1.101, 00:00:08, GigabitEthernet0/0/0/2
[115/50] via 10.1.3.101, 00:00:08, GigabitEthernet0/0/0/3
```

MPLS-TE Features - Details

MPLS TE Fast Reroute Link and Node Protection

Fast Reroute (FRR) is a mechanism for protecting MPLS TE LSPs from link and node failures by locally repairing the LSPs at the point of failure, allowing data to continue to flow on them while their headend routers try to establish new end-to-end LSPs to replace them. FRR locally repairs the protected LSPs by rerouting them over backup tunnels that bypass failed links or node.



Note If FRR is greater than 50ms, it might lead to a loss of traffic.

Backup tunnels that bypass only a single link of the LSP's path provide link protection. They protect LSPs if a link along their path fails by rerouting the LSP's traffic to the next hop (bypassing the failed link). These tunnels are referred to as next-hop (NHOP) backup tunnels because they terminate at the LSP's next hop beyond the point of failure.

The following figure illustrates link protection.

Figure 4: Link Protection

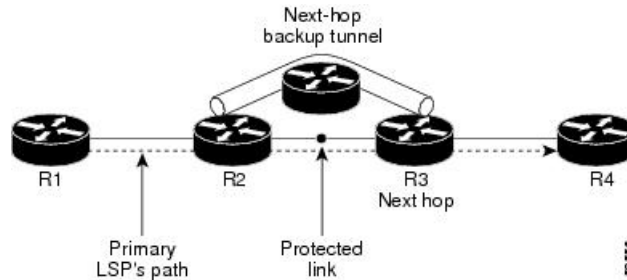

FRR provides node protection for LSPs. Backup tunnels that bypass next-hop nodes along LSP paths are called next-next-hop (NNHOP) backup tunnels because they terminate at the node following the next-hop node of the LSP paths, bypassing the next-hop node. They protect LSPs if a node along their path fails by enabling the node upstream of the failure to reroute the LSPs and their traffic around the failed node to the next-next hop. NNHOP backup tunnels also provide protection from link failures, because they bypass the failed link and the node.

The following figure illustrates node protection.

Figure 5: Node Protection

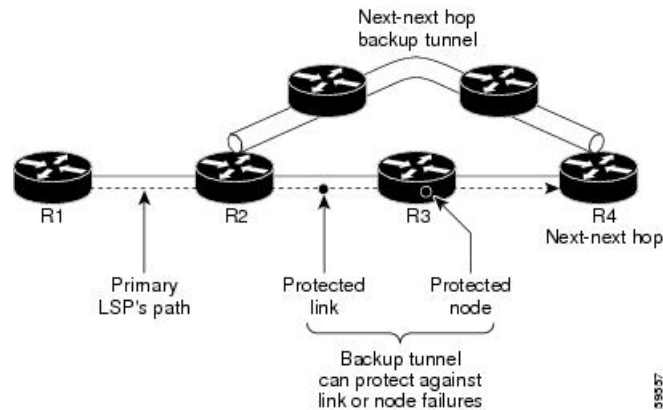

MPLS-TE Forwarding Adjacency

MPLS TE forwarding adjacency allows you to handle a TE label-switched path (LSP) tunnel as a link in an Interior Gateway Protocol (IGP) network that is based on the Shortest Path First (SPF) algorithm. Both Intermediate System-to-Intermediate System (IS-IS) and Open Shortest Path First (OSPF) are supported as the IGP. A forwarding adjacency can be created between routers regardless of their location in the network. The routers can be located multiple hops from each other.

As a result, a TE tunnel is advertised as a link in an IGP network with the tunnel's cost associated with it. Routers outside of the TE domain see the TE tunnel and use it to compute the shortest path for routing traffic throughout the network. TE tunnel interfaces are advertised in the IGP network just like any other links. Routers can then use these advertisements in their IGPs to compute the SPF even if they are not the headend of any TE tunnels.

Automatic Bandwidth

Automatic bandwidth allows you to dynamically adjust bandwidth reservation based on measured traffic. MPLS-TE automatic bandwidth is configured on individual Label Switched Paths (LSPs) at every headend router. MPLS-TE automatic bandwidth monitors the traffic rate on a tunnel interface and resizes the bandwidth on the tunnel interface to align it closely with the traffic in the tunnel.

MPLS-TE automatic bandwidth can perform these functions:

- Monitors periodic polling of the tunnel output rate
- Resizes the tunnel bandwidth by adjusting the highest rate observed during a given period.

For every traffic-engineered tunnel that is configured for an automatic bandwidth, the average output rate is sampled, based on various configurable parameters. Then, the tunnel bandwidth is readjusted automatically based on either the largest average output rate that was noticed during a certain interval, or a configured maximum bandwidth value.

While re-optimizing the LSP with the new bandwidth, a new path request is generated. If the new bandwidth is not available, the last good LSP remains used. This way, the network experiences no traffic interruptions. If minimum or maximum bandwidth values are configured for a tunnel, the bandwidth, which the automatic bandwidth signals, stays within these values.

The output rate on a tunnel is collected at regular intervals that are configured by using the **application** command in MPLS-TE auto bandwidth interface configuration mode. When the application period timer expires, and when the difference between the measured and the current bandwidth exceeds the adjustment threshold, the tunnel is re-optimized. Then, the bandwidth samples are cleared to record the new largest output rate at the next interval. If a tunnel is shut down, and is later brought again, the adjusted bandwidth is lost, and the tunnel is brought back with the initially configured bandwidth. When the tunnel is brought back, the application period is reset.

MPLS Traffic Engineering Interarea Tunneling

The MPLS-TE interarea tunneling feature allows you to establish TE tunnels spanning multiple Interior Gateway Protocol (IGP) areas and levels, thus eliminating the requirement that headend and tailend routers reside in a single area.

Interarea support allows the configuration of a TE LSP that spans multiple areas, where its headend and tailend label switched routers (LSRs) reside in different IGP areas. Customers running multiple IGP area backbones (primarily for scalability reasons) requires Multiarea and Interarea TE . This lets you limit the amount of flooded information, reduces the SPF duration, and lessens the impact of a link or node failure within an area, particularly with large WAN backbones split in multiple areas.

The following figure shows a typical interarea TE network using OSPF.

Figure 6: Interarea (OSPF) TE Network Diagram

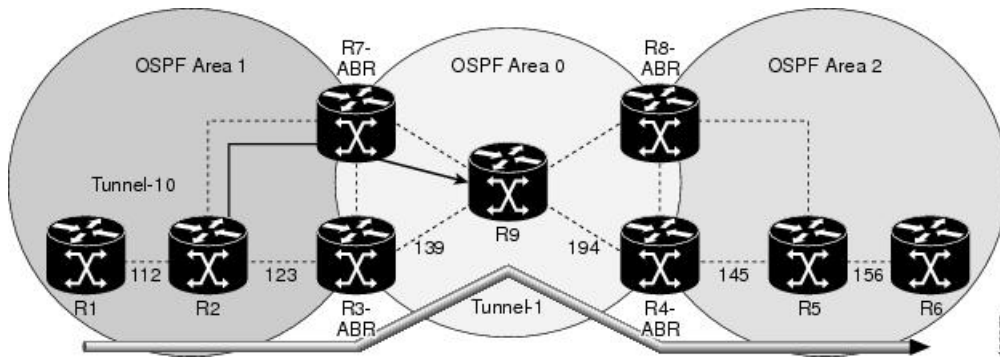

The following figure shows a typical interlevel (IS-IS) TE Network.

Figure 7: Interlevel (IS-IS) TE Network Diagram

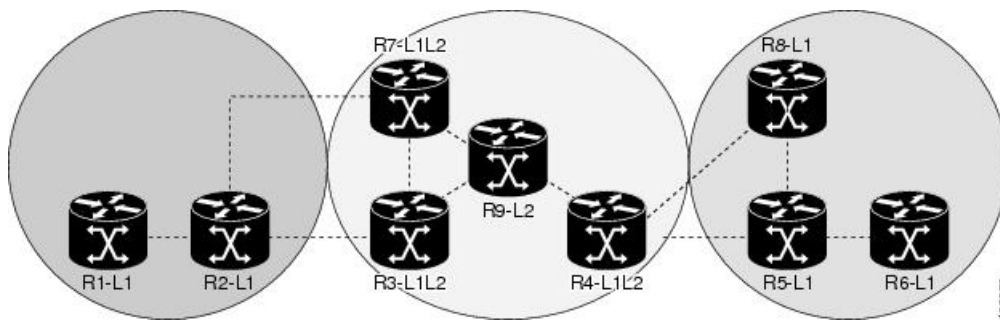

As shown in the [Figure 7: Interlevel \(IS-IS\) TE Network Diagram, on page 28](#), R2, R3, R7, and R4 maintain two databases for routing and TE information. For example, R3 has TE topology information related to R2, flooded through Level-1 IS-IS LSPs plus the TE topology information related to R4, R9, and R7, flooded as Level 2 IS-IS Link State PDUs (LSPs) (plus, its own IS-IS LSP).

Loose hop optimization allows the re-optimization of tunnels spanning multiple areas and solves the problem which occurs when an MPLS-TE LSP traverses hops that are not in the LSP's headend's OSPF area and IS-IS level. Interarea MPLS-TE allows you to configure an interarea traffic engineering (TE) label switched path (LSP) by specifying a loose source route of ABRs along the path. Then it is the responsibility of the ABR (having a complete view of both areas) to find a path obeying the TE LSP constraints within the next area to reach the next hop ABR (as specified on the headend router). The same operation is performed by the last ABR connected to the tailend area to reach the tailend LSR.

You must be aware of these considerations when using loose hop optimization:

- You must specify the router ID of the ABR node (as opposed to a link address on the ABR).
- When multiarea is deployed in a network that contains subareas, you must enable MPLS-TE in the subarea for TE to find a path when loose hop is specified.
- You must specify the reachable explicit path for the interarea tunnel.

Policy-Based Tunnel Selection

Policy-Based Tunnel Selection (PBTS) is a mechanism that lets you direct traffic into specific TE tunnels based on different classification criteria. PBTS will benefit Internet service providers (ISPs) that carry voice

and data traffic through their MPLS and MPLS/VPN networks and would have to route this traffic to provide optimized voice service.

PBTS works by selecting tunnels based on the classification criteria of the incoming packets, which are based on the IP precedence or differentiated services code point (DSCP), or the Type of Service (ToS) fields in the packets. The traffic forwarding decisions are made based on the traffic classes AND the destination network addresses instead of only considering the destination network.

Default-class configured for paths is always zero (0). If there is no TE for a given forward-class, then the default-class (0) will be tried. If there is no default-class, then the packet is tried against the lowest configured forward-class tunnels. PBTS supports up to seven (exp 1 - 7) EXP values associated with a single TE-tunnel.

The following figure illustrates PBTS Network Topology:

Figure 8: Policy-Based Tunnel Selection Implementation

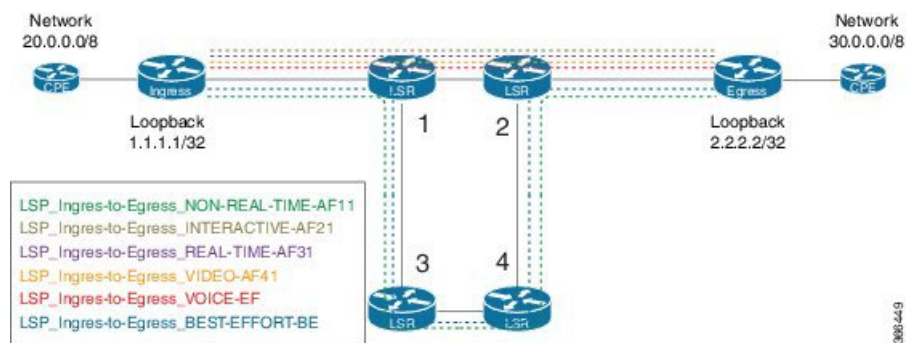

- Tunnels are created between Ingress and Egress nodes through LSR 1-2 and LSR 1-3-4-2 paths.
- High priority traffic takes the path: Ingress->LSR1->LSR2->Egress.
- Low priority traffic takes the path: Ingress->LSR1->LSR3->LSR4->LSR2->Egress

PBTS Function Details

The following PBTS functions are supported on the router:

- Classify the Ingress traffic into different classes by creating rules using PBR configuration.
- Classify packets using DSCP/IP precedence for both IPv4 and IPv6 traffic.
- After classification, set the desired forward-class to each type of Ingress traffic.
- Define one or many MPLS-TE tunnels in the destination using Tunnel configuration.
- Associate the MPLS-TE tunnels to a specific forward-class under Tunnel configuration.
- Enable PBTS on the Ingress interface by applying the service policy that uses the configured classification rules.

The following list gives PBTS support information:

- PBTS is supported only on Ipv4/Ipv6 incoming traffic only.
- A maximum of eight forward-classes per destination prefix is supported.
- A maximum of 64 TE-tunnels within each forward class is supported.

- A maximum of 64 TE-tunnels can be configured on a given destination.
- Incoming labeled traffic is not supported.
- PBTS with L2VPN/L3VPN traffic is not supported.

PBTS Forward Class

A class-map is defined for various types of packets and these class-maps are associated with a forward-class. A class-map defines the matching criteria for classifying a particular type of traffic and a forward-class defines the forwarding path these packets should take.

After a class-map is associated with a forwarding-class in the policy map, all the packets that match the class-map are forwarded as defined in the policy-map. The egress traffic engineering (TE) tunnel interfaces that the packets should take for each forwarding-class is specified by associating the TE interface explicitly (or implicitly in case of default value) with the forward-group.

When the TE interfaces are associated with the forward-class, they can be exported to the routing protocol module using the **auto-route** command. This will then associate the route in the FIB database with these tunnels. If the TE interface is not explicitly associated with a forward-class, it gets associated with a default-class (0). All non-TE interfaces will be routed to the forwarding plane (with forward-class set to default-class) by the routing protocol.

UCMP Over MPLS-TE

In Equal Cost Multi Path (ECMP), you can load-balance routed traffic over multiple paths of the same cost. With Unequal-Cost Multipath (UCMP), you can load-balance traffic over multiple paths of varying costs.

Consider three forwarding links, with two 10 Gigabit Ethernet links and a 100 Gigabit Ethernet link, as shown in the image.

In such a scenario, the incoming traffic load is not equally distributed using ECMP. On the other hand, UCMP applies a weight to a path, and adds more forwarding instances to a path that has a higher weight (larger bandwidth). This results in an equal load distribution over paths of varying bandwidths (and costs).

Configuration Example

UCMP Configuration:

```
R1# configure
R1(config)# mpls traffic-eng
R1(config-mpls-te)# load-share unequal
R1(config-mpls-te)# commit
```

Tunnels Configuration:

```
R1(config)# interface tunnel-te 1
R1(config-if)# ipv4 unnumbered loopback 1
R1(config-if)# load-share 5
R1(config-if)# autoroute announce
R1(config-if-tunte-aa)# commit
R1(config-if-tunte-aa)# exit
R1(config-if)# destination 172.16.0.1
R1(config-if)# path-option 1 dynamic

R1(config)# interface tunnel-te 2
```

```
R1(config-if)# ipv4 address 192.168.0.1 255.255.255.0
R1(config-if)# load-share 6
R1(config-if)# autoroute announce
R1(config-if-tunte-aa)# commit
R1(config-if-tunte-aa)# exit
R1(config-if)# destination 172.16.0.1
R1(config-if)# path-option 1 dynamic
```

Associated Commands

- [load-share](#)
- [load-share unequal](#)
- [show cef](#)

Verification

Verify UCMP Configuration:

```
R1# show cef 172.16.0.1 detail

172.16.0.1/32, version 16, internal 0x1000001 0x0 (ptr 0x97de1a58) [1], 0x0 (0x97fa3728),
0xa20 (0x98fc00a8)
  Updated Jun 17 16:07:46.325
  Prefix Len 32, traffic index 0, precedence n/a, priority 3
  gateway array (0x97e0ba08) reference count 3, flags 0x68, source lsd (5), 1 backups
    [3 type 4 flags 0x8401 (0x9849f728) ext 0x0 (0x0)]
  LW-LDI[type=1, refc=1, ptr=0x97fa3728, sh-ldi=0x9849f728]
  gateway array update type-time 1 Jun 17 16:07:46.325
  LDI Update time Jun 17 16:07:46.350
  LW-LDI-TS Jun 17 16:07:46.350
    via 172.16.0.1/32, tunnel-te1, 5 dependencies, weight 100, class 0 [flags 0x0]
      path-idx 0 NHID 0x0 [0x98e19380 0x98e192f0]
      next hop 172.16.0.1/32
      local adjacency
        local label 24001      labels imposed {ImplNull}
    via 172.16.0.1/32, tunnel-te2, 7 dependencies, weight 10, class 0 [flags 0x0]
      path-idx 1 NHID 0x0 [0x98e194a0 0x98e19410]
      next hop 172.16.0.1/32
      local adjacency
        local label 24001      labels imposed {ImplNull}

  Weight distribution:

  slot 0, weight 100, normalized_weight 10, class 0
  slot 1, weight 10, normalized_weight 1, class 0
  Load distribution: 0 0 0 0 0 0 0 0 0 0 1 (refcount 3)

  Hash  OK  Interface      Address
  0     Y   tunnel-te1     point2point
  1     Y   tunnel-te1     point2point
  2     Y   tunnel-te1     point2point
  3     Y   tunnel-te1     point2point
  4     Y   tunnel-te1     point2point
  5     Y   tunnel-te1     point2point
  6     Y   tunnel-te1     point2point
  7     Y   tunnel-te1     point2point
  8     Y   tunnel-te1     point2point
  9     Y   tunnel-te1     point2point
  10    Y   tunnel-te2     point2point
```

Some sample output:

```

Router# show run formal mpls traffic-eng

mpls traffic-eng
mpls traffic-eng interface Bundle-Ether2
mpls traffic-eng interface Bundle-Ether3
..
mpls traffic-eng load-share unequal
mpls traffic-eng reoptimize 180
mpls traffic-eng signalling advertise explicit-null
mpls traffic-eng reoptimize timers delay path-protection 60

Router# show run formal interface tunnel-te400

interface tunnel-te400
interface tunnel-te400 description TE-STI-GRTMIABR5-GRTBUEBA3-BW-0
interface tunnel-te400 ipv4 unnumbered Loopback0
interface tunnel-te400 load-interval 30
interface tunnel-te400 signalled-name TE-STI-GRTMIABR5-GRTBUEBA3-BW-0
interface tunnel-te400 load-share 80
interface tunnel-te400 autoroute destination 94.142.100.214
interface tunnel-te400 destination 94.142.100.214
interface tunnel-te400 path-protection
interface tunnel-te400 path-option 1 explicit name BR5-BA3-0 protected-by 2
interface tunnel-te400 path-option 2 explicit name BW-BR5-1-VAP3-BA3-0
interface tunnel-te400 path-option 3 explicit name BW-BR5-VAP3-BA3-0

Router# show run formal interface tunnel-te406

interface tunnel-te406
interface tunnel-te406 description TE-STI-GRTMIABR5-GRTBUEBA3-BW-20
interface tunnel-te406 ipv4 unnumbered Loopback0
interface tunnel-te406 load-interval 30
interface tunnel-te406 signalled-name TE-STI-GRTMIABR5-GRTBUEBA3-BW-20
interface tunnel-te406 load-share 10
interface tunnel-te406 autoroute destination 94.142.100.214
interface tunnel-te406 destination 94.142.100.214
interface tunnel-te406 path-protection
interface tunnel-te406 path-option 1 explicit name BR5-1-BA3-0 protected-by 2
interface tunnel-te406 path-option 2 explicit name BW-BR5-VAP4-BA3-0

Router# show cef 94.142.100.214/32 det

94.142.100.214/32, version 25708656, attached, internal 0x4004081 0x0 (ptr 0x764ff1b0) [3],
0x0 (0x7267d848), 0x440 (0x7d93b2b8)
Updated Nov 19 08:02:26.545
Prefix Len 32, traffic index 0, precedence n/a, priority 3
gateway array (0x72411528) reference count 3, flags 0xd0, source lsd (4), 1 backups
[3 type 4 flags 0x10101 (0x7300d648) ext 0x0 (0x0)]
LW-LDI[type=1, refc=1, ptr=0x7267d848, sh-ldi=0x7300d648]
via tunnel-te400, 3 dependencies, weight 80, class 0 [flags 0x8]
path-idx 0 NHID 0x0 [0x72082a40 0x72983b58]
local adjacency
local label 16440 labels imposed {ImplNull}
via tunnel-te406, 3 dependencies, weight 10, class 0 [flags 0x8]
path-idx 1 NHID 0x0 [0x7207b4ac 0x729886bc]
local adjacency
local label 16440 labels imposed {ImplNull}
via tunnel-te410, 3 dependencies, weight 80, class 0 [flags 0x8]
path-idx 2 NHID 0x0 [0x72085218 0x72985ee4]
local adjacency
local label 16440 labels imposed {ImplNull}
via tunnel-te426, 3 dependencies, weight 10, class 0 [flags 0x8]
path-idx 3 NHID 0x0 [0x7207d4b4 0x7297fecc]

```



```

local adjacency
  local label 16440      labels imposed {ImplNull}
via tunnel-te427, 3 dependencies, weight 25, class 0 [flags 0x8]
  path-idx 4 NHID 0x0 [0x720802cc 0x7298726c]
  local adjacency
    local label 16440      labels imposed {ImplNull}
via tunnel-te1089, 3 dependencies, weight 40, class 0 [flags 0x8]
  path-idx 5 NHID 0x0 [0x72081848 0x7298037c]
  local adjacency
    local label 16440      labels imposed {ImplNull}
via tunnel-te1090, 3 dependencies, weight 60, class 0 [flags 0x8]
  path-idx 6 NHID 0x0 [0x7207d770 0x72987780]
  local adjacency
    local label 16440      labels imposed {ImplNull}
via tunnel-te1099, 3 dependencies, weight 60, class 0 [flags 0x8]
  path-idx 7 NHID 0x0 [0x7207ed50 0x72981c7c]
  local adjacency
    local label 16440      labels imposed {ImplNull}

```

Weight distribution:

```

slot 0, weight 80, normalized_weight 7, class 0
slot 1, weight 10, normalized_weight 1, class 0
slot 2, weight 80, normalized_weight 7, class 0
slot 3, weight 10, normalized_weight 1, class 0
slot 4, weight 25, normalized_weight 1, class 0
slot 5, weight 40, normalized_weight 3, class 0
slot 6, weight 60, normalized_weight 5, class 0
slot 7, weight 60, normalized_weight 5, class 0

```

Router# show cef 94.142.100.213/32 det

```

94.142.100.213/32, version 25708617, attached, internal 0x4004081 0x0 (ptr 0x771925c8) [3],
0x0 (0x7267a594), 0x440 (0x7d93d364)
Updated Nov 19 08:02:01.029
Prefix Len 32, traffic index 0, precedence n/a, priority 3
gateway array (0x7240f638) reference count 3, flags 0xd0, source lsd (4), 1 backups
  [3 type 4 flags 0x10101 (0x73013360) ext 0x0 (0x0)]
LW-LDI[type=1, refc=1, ptr=0x7267a594, sh-ldi=0x73013360]
via tunnel-te220, 3 dependencies, weight 60, class 0 [flags 0x8]
  path-idx 0 NHID 0x0 [0x7207d838 0x72982af0]
  local adjacency
    local label 17561      labels imposed {ImplNull}
via tunnel-te230, 3 dependencies, weight 60, class 0 [flags 0x8]
  path-idx 1 NHID 0x0 [0x7207d068 0x72986e20]
  local adjacency
    local label 17561      labels imposed {ImplNull}
via tunnel-te236, 3 dependencies, weight 50, class 0 [flags 0x8]
  path-idx 2 NHID 0x0 [0x720830e4 0x7297f508]
  local adjacency
    local label 17561      labels imposed {ImplNull}
via tunnel-te246, 3 dependencies, weight 100, class 0 [flags 0x8]
  path-idx 3 NHID 0x0 [0x7207a1ec 0x7298483c]
  local adjacency
    local label 17561      labels imposed {ImplNull}
via tunnel-te221, 3 dependencies, weight 50, class 0 [flags 0x8]
  path-idx 4 NHID 0x0 [0x7207ea30 0x72982834]
  local adjacency
    local label 17561      labels imposed {ImplNull}
via tunnel-te222, 3 dependencies, weight 25, class 0 [flags 0x8]
  path-idx 5 NHID 0x0 [0x72084a48 0x72989850]
  local adjacency
    local label 17561      labels imposed {ImplNull}
via tunnel-te1091, 3 dependencies, weight 30, class 0 [flags 0x8]
  path-idx 6 NHID 0x0 [0x720851b4 0x729895f8]
  local adjacency

```

```

    local label 17561      labels_imposed {ImplNull}
via tunnel-te342, 3 dependencies, weight 100, class 0 [flags 0x8]
path-idx 7 NHID 0x0 [0x72085344 0x7298b024]
local adjacency
    local label 17561      labels_imposed {ImplNull}

```

```

Weight distribution:
slot 0, weight 60, normalized_weight 2, class 0
slot 1, weight 60, normalized_weight 2, class 0
slot 2, weight 50, normalized_weight 2, class 0
slot 3, weight 100, normalized_weight 4, class 0
slot 4, weight 50, normalized_weight 2, class 0
slot 5, weight 25, normalized_weight 1, class 0
slot 6, weight 30, normalized_weight 1, class 0
slot 7, weight 100, normalized_weight 4, class 0

```

```

Load distribution: 0 0 1 1 2 2 3 3 3 3 4 4 5 6 7 7 7 7 (refcount 3)

```

Hash	OK	Interface	Address
0	Y	tunnel-te220	point2point
1	Y	tunnel-te220	point2point
2	Y	tunnel-te230	point2point
3	Y	tunnel-te230	point2point
4	Y	tunnel-te236	point2point
5	Y	tunnel-te236	point2point
6	Y	tunnel-te246	point2point
7	Y	tunnel-te246	point2point
8	Y	tunnel-te246	point2point
9	Y	tunnel-te246	point2point
10	Y	tunnel-te221	point2point
11	Y	tunnel-te221	point2point
12	Y	tunnel-te222	point2point
13	Y	tunnel-te1091	point2point
14	Y	tunnel-te342	point2point
15	Y	tunnel-te342	point2point
16	Y	tunnel-te342	point2point
17	Y	tunnel-te342	point2point