



Implementing MPLS OAM

- [Implementing MPLS OAM, on page 1](#)

Implementing MPLS OAM

MPLS Operations, Administration, and Maintenance (OAM) helps service providers to monitor label-switched paths (LSPs) and quickly isolate MPLS forwarding problems to assist with fault detection and troubleshooting in an MPLS network. This module describes MPLS LSP Ping and Traceroute features which can be used for failure detection and troubleshooting of MPLS networks.

MPLS LSP Ping

The MPLS LSP Ping feature is used to check the connectivity between Ingress LSR and egress LSRs along an LSP. MPLS LSP ping uses MPLS echo request and reply messages, similar to Internet Control Message Protocol (ICMP) echo request and reply messages, to validate an LSP. While ICMP echo request and reply messages validate IP networks, MPLS echo and reply messages validate MPLS networks. The MPLS echo request packet is sent to a target router through the use of the appropriate label stack associated with the LSP to be validated. Use of the label stack causes the packet to be forwarded over the LSP itself. The destination IP address of the MPLS echo request packet is different from the address used to select the label stack. The destination IP address is defined as a 127.x.y.z/8 address and it prevents the IP packet from being IP switched to its destination, if the LSP is broken.

An MPLS echo reply is sent in response to an MPLS echo request. The reply is sent as an IP packet and it is forwarded using IP, MPLS, or a combination of both types of switching. The source address of the MPLS echo reply packet is an address obtained from the router generating the echo reply. The destination address is the source address of the router that originated the MPLS echo request packet. The MPLS echo reply destination port is set to the echo request source port.

The following figure shows MPLS LSP ping echo request and echo reply paths.

Figure 1: MPLS LSP Ping Echo Request and Reply Paths



Configuration Examples

This example shows how to use MPLS LSP ping to test the connectivity of an IPv4 LDP LSP. The destination is specified as a Label Distribution Protocol (LDP) IPv4 prefix and Forwarding Equivalence Class (FEC) type is specified as generic.

```
RP/0/RP0/CPU0:router# ping mpls ipv4 10.1.1.2/32 fec-type generic
```

```
Wed Nov 25 03:36:33.143 UTC
Sending 5, 100-byte MPLS Echos to 10.1.1.2/32,
  timeout is 2 seconds, send interval is 0 msec:
```

```
Codes: '!' - success, 'Q' - request not sent, '.' - timeout,
'L' - labeled output interface, 'B' - unlabeled output interface,
'D' - DS Map mismatch, 'F' - no FEC mapping, 'f' - FEC mismatch,
'M' - malformed request, 'm' - unsupported tlvs, 'N' - no rx label,
'P' - no rx intf label prot, 'p' - premature termination of LSP,
'R' - transit router, 'I' - unknown upstream index,
'X' - unknown return code, 'x' - return code 0
```

Type escape sequence to abort.

```
!!!!
Success rate is 100 percent (5/5), round-trip min/avg/max = 2/2/3 ms
```

This example shows how to use MPLS LSP ping to test the connectivity when the destination is specified as a MPLS traffic engineering (TE) tunnel.

```
RP/0/RP0/CPU0:router# ping mpls traffic-eng tunnel-te 4003 source 10.1.1.2
```

```
Tue Nov 24 20:39:39.179 PST
Sending 5, 100-byte MPLS Echos to tunnel-te4003,
  timeout is 2 seconds, send interval is 0 msec:
```

```
Codes: '!' - success, 'Q' - request not sent, '.' - timeout,
'L' - labeled output interface, 'B' - unlabeled output interface,
'D' - DS Map mismatch, 'F' - no FEC mapping, 'f' - FEC mismatch,
'M' - malformed request, 'm' - unsupported tlvs, 'N' - no rx label,
'P' - no rx intf label prot, 'p' - premature termination of LSP,
'R' - transit router, 'I' - unknown upstream index,
'X' - unknown return code, 'x' - return code 0
```

Type escape sequence to abort.

```
!!!!
Success rate is 100 percent (5/5), round-trip min/avg/max = 3/3/4 ms
```

This example shows how to use the **show mpls oam** command to display the MPLS OAM information

```
RP/0/RP0/CPU0:router# show mpls oam counters packet

Wed Nov 25 03:38:07.397 UTC Global Packet Statistics:

                Pkt                Bytes
                -----                -----
Receive Counts:
  Good Requests:                0                0
  Good Replies:                10                760
  Unknown Pkt Types:            0                0
  IP header error:              0                0
  UDP header error:            0                0
  Runts:                        0                0
  Dropped (Q full):            0                0
  General error:                0                0
  Error, no IF:                 0                0
  Error, no memory:            0                0

Transmit Counts:
  Good:                        10                960
  Dropped:                      0                0
```

MPLS LSP Traceroute

The MPLS LSP Traceroute feature is used to isolate the failure point of an LSP. It is used for hop-by-hop fault localization and path tracing. The MPLS LSP Traceroute feature relies on the expiration of the Time to Live (TTL) value of the packet that carries the echo request. When the MPLS echo request message hits a transit node, it checks the TTL value and if it is expired, the packet is passed to the control plane, else the message is forwarded. If the echo message is passed to the control plane, a reply message is generated based on the contents of the request message.

The following figure shows an MPLS LSP traceroute example with an LSP from LSR1 to LSR4.

Figure 2: MPLS LSP Traceroute

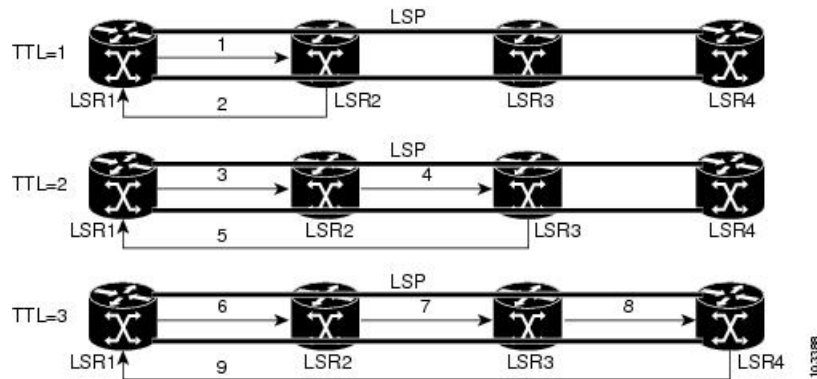

Configuration Examples

This example shows how to use the **traceroute** command to trace to a destination with Forwarding Equivalence Class (FEC) type specified as generic.

```
RP/0/RP0/CPU0:router# traceroute mpls ipv4 192.168.0.1/32 fec-type generic
Mon Nov 30 17:48:45.585 UTC
```

```
Tracing MPLS Label Switched Path to 192.168.0.1/32, timeout is 2 seconds
```

```
Codes: '!' - success, 'Q' - request not sent, '.' - timeout,  
       'L' - labeled output interface, 'B' - unlabeled output interface,  
       'D' - DS Map mismatch, 'F' - no FEC mapping, 'f' - FEC mismatch,  
       'M' - malformed request, 'm' - unsupported tlvs, 'N' - no rx label,  
       'P' - no rx intf label prot, 'p' - premature termination of LSP,  
       'R' - transit router, 'I' - unknown upstream index,  
       'X' - unknown return code, 'x' - return code 0
```

```
Type escape sequence to abort.
```

```
  0 10.1.1.57 MRU 1500 [Labels: implicit-null Exp: 0]  
! 1 10.1.1.58 7 ms23:19
```