



LEDs

- [Chassis LEDs, on page 1](#)
- [Fan Tray LED, on page 5](#)
- [Power Supply LEDs, on page 7](#)
- [Port Status LEDs, on page 10](#)

Chassis LEDs

Attention, Status, Synchronization, and GPS LEDs are located both at the far left of the front of the chassis and also on the back of the chassis:

Figure 1: Chassis LEDs - Front View of Cisco 8201 Chassis

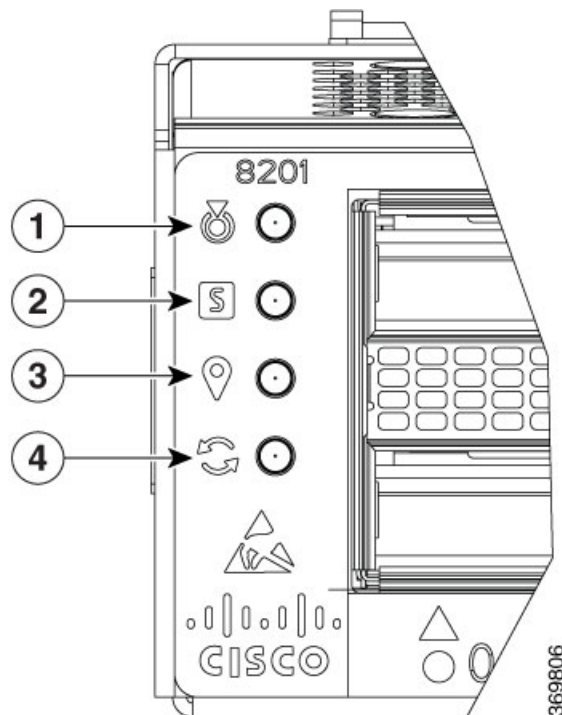

Figure 2: Chassis LEDs - Rear View of Cisco 8201 Chassis

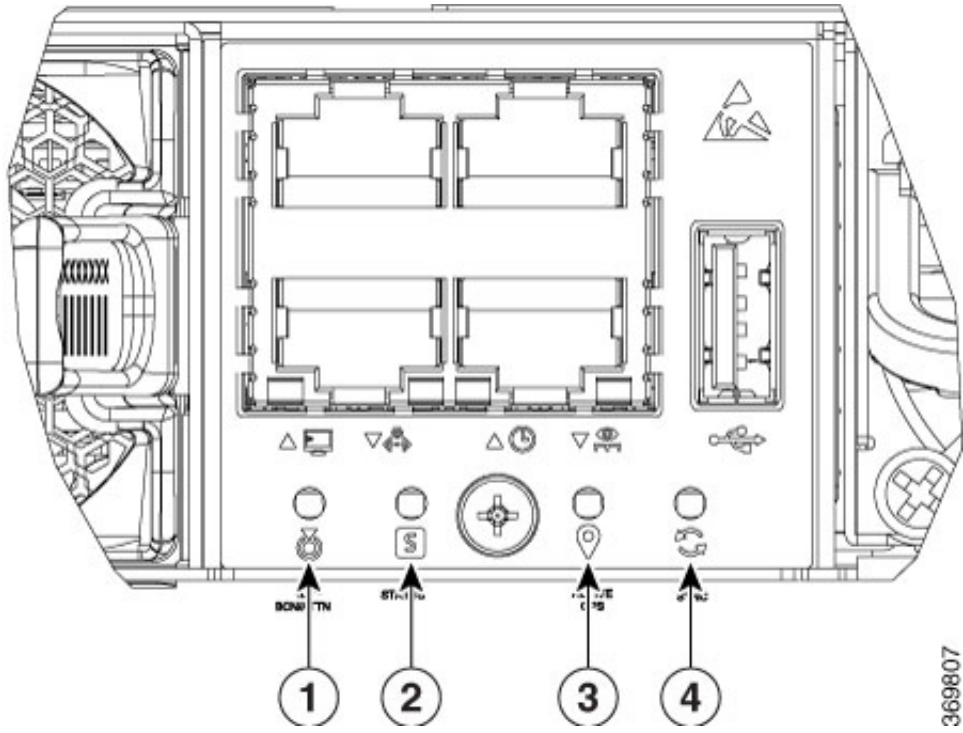

Figure 3: Chassis LEDs - Rear View of Cisco 8202 Chassis

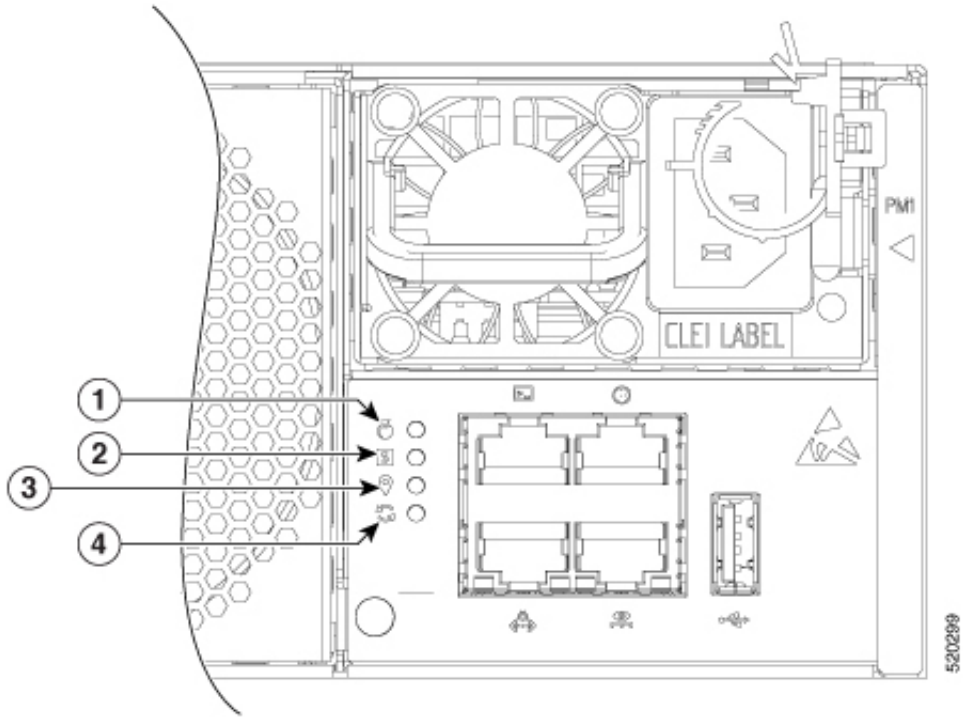

Figure 4: Chassis LEDs - Front View of Cisco 8201-32FH and Cisco 8201-24H8FH Routers

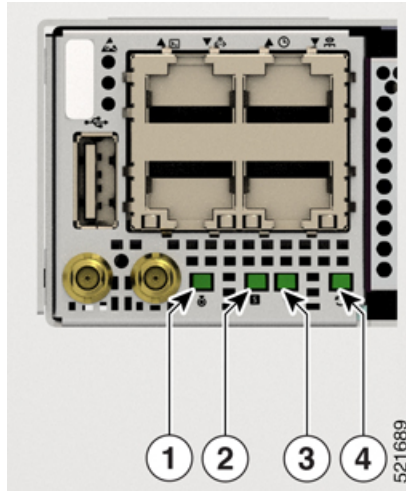
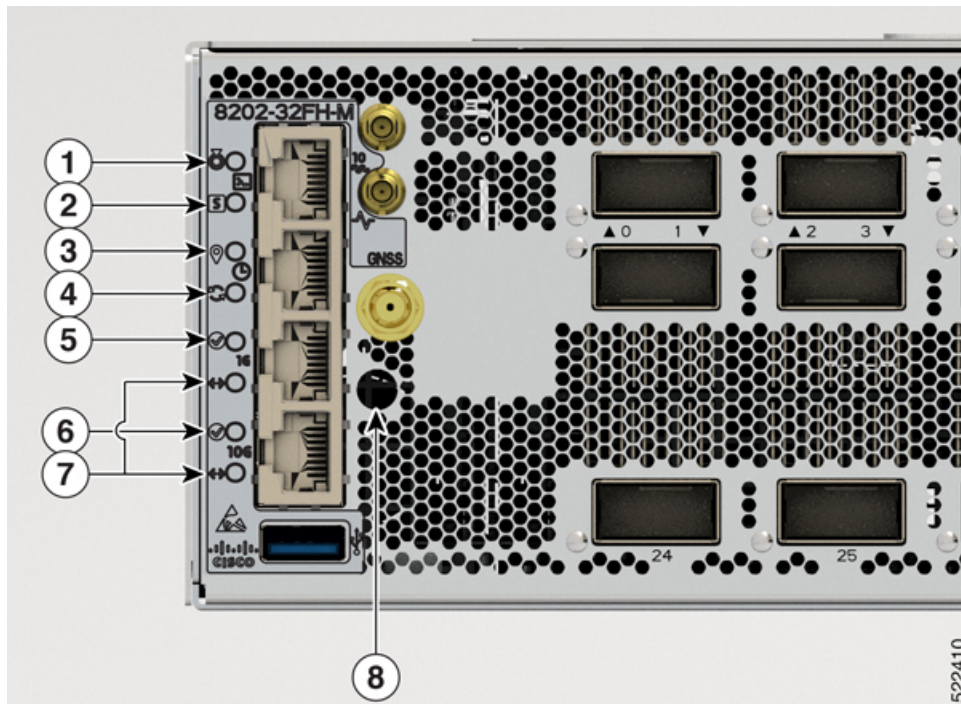







Figure 5: Chassis LEDs - Front View of Cisco 8202-32FH -M Chassis



1	Attention
2	Status
3	GPS
4	Synchronization
5	IG Management Port

6	10G Management Port
7	1G and 10G Port Activity
8	GNSS

Table 1: Chassis LED Descriptions

LED	Color	Status
	Flashing blue	The operator has activated this LED to identify this chassis.
	Off	This chassis is not being identified.
	Green	The module is operational and has no active major or critical alarms.
	Flashing Green	The auto or manual FPD upgrade is in progress.
	Amber	The module is in one of the following states: <ul style="list-style-type: none"> • Power cycle • Reload or reimage • Shutdown
	Flashing Amber	The module has minor alarm.
	Red	Power-up failure which prevents the CPU from booting.
	Flashing Red	The module has active major or critical alarms.
	Off	The module is powered-off.
	Green	Time core is synchronized to an external source including IEEE1588.
	Amber	The system is running in holdover or free-run mode and it is not synchronized to an external interface.
	Off	The centralized frequency or time and phase distribution is not enabled.
	Green	The GPS interface is provisioned and frequency, time of day and phase inputs are all operating correctly.
	Off	The GPS interface is not provisioned, or the GPS inputs are not working correctly.
	Green	The ethernet link is up and operational.
	Amber	The port is either receiving or transmitting data packets.
	Off	The ethernet link is down.

LED	Color	Status
	Green	The ethernet link is up and operational.
	Amber	The port is either receiving or transmitting data packets.
	Off	The ethernet link is down.

Fan Tray LED

Fan tray modules are located on the back of the chassis. Each fan tray module has a Status LED.

Figure 6: Fan Tray LED - Cisco 8201 Chassis

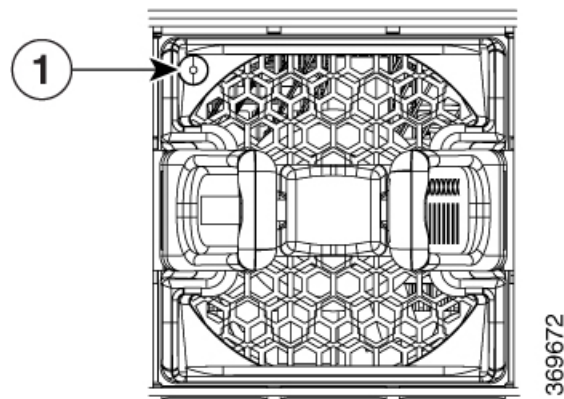

Figure 7: Fan Tray LED - Cisco 8202 Chassis

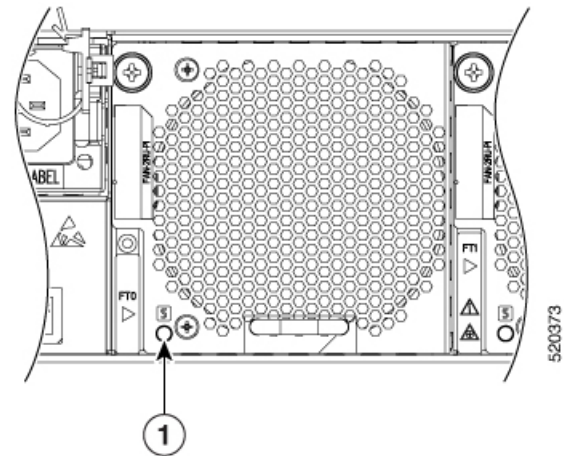
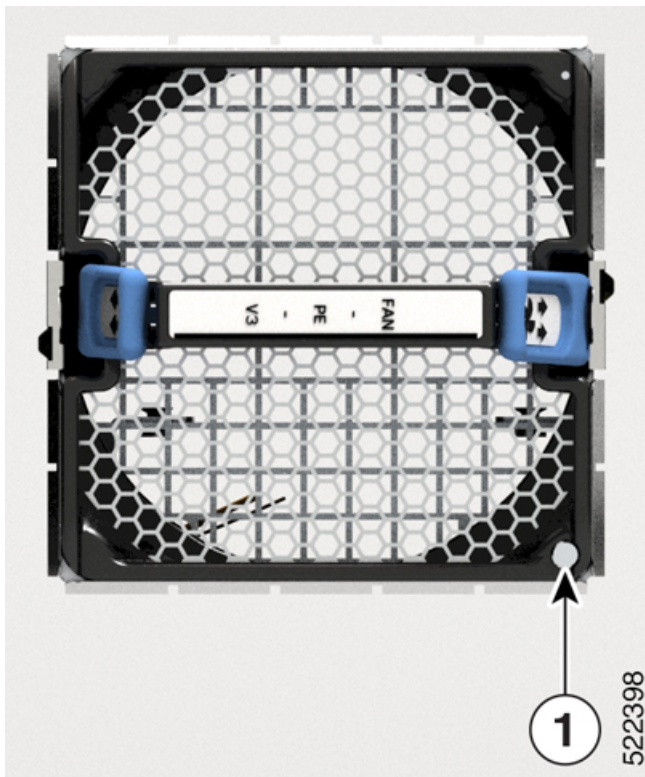

Figure 8: Fan Tray LED - Cisco 8201-32FH and Cisco 8201-24H8FH Routers



Figure 9: Fan Tray LED - Cisco 8202-32FH-M Chassis



1	Fan Status LED
---	----------------

Table 2: Fan Tray LED Descriptions

LED	Color	Status
STATUS	Green	Fan is operating normally.
	Amber	Fan tray is inserted and pending to come online.
	Flashing Amber	Fan has failed.
	Off	Fan is not receiving power.

Power Supply LEDs

Power modules are located on the back side of the chassis. Each power module has a Status LED.

Figure 10: Power Supply LED - 1450W

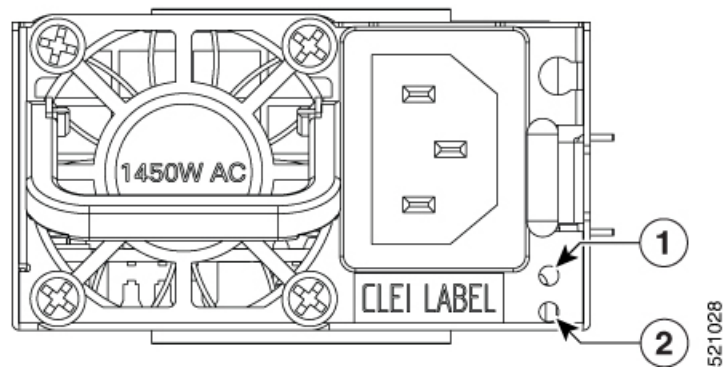

1	Status LED
2	Attention LED

Figure 11: Power Supply LED - 2000W

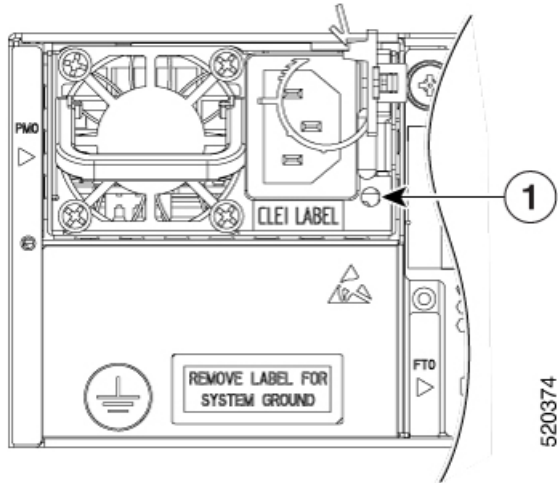

1	Status LED
---	------------

Figure 12: Power Supply LED - Cisco 8201-32FH and Cisco 8201-24H8FH Routers

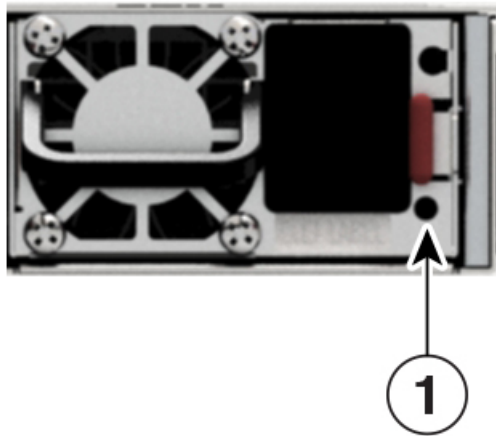

Figure 13: Power Supply LED - Cisco 8202-32FH -M Chassis



1	Status LED
---	------------

Table 3: Power Supply LED Descriptions

LED	Color	Status
STATUS	Green	Power supply is on and transmitting power to the router.
	Flashing Green	Power supply is connected to input power source but not transmitting power to the router.
	Amber	Power supply failure, due to one of the following conditions: <ul style="list-style-type: none"> • Over voltage • Over current • Over Temperature • Fan failure
	Flashing Amber	Power supply is operating but a warning condition has occurred, due to one of the following conditions: <ul style="list-style-type: none"> • High temperature • High power • Slow fan
	Off	Power supply units are not receiving power.
Attention	Flasing Blue	The operator has activated this LED to identify this PSU.
	Off	This PSU is not being identified.

Port Status LEDs

Each port has an LED. The following table describes port status LEDs.

Figure 14: Port Status LED - Cisco 8202 Chassis

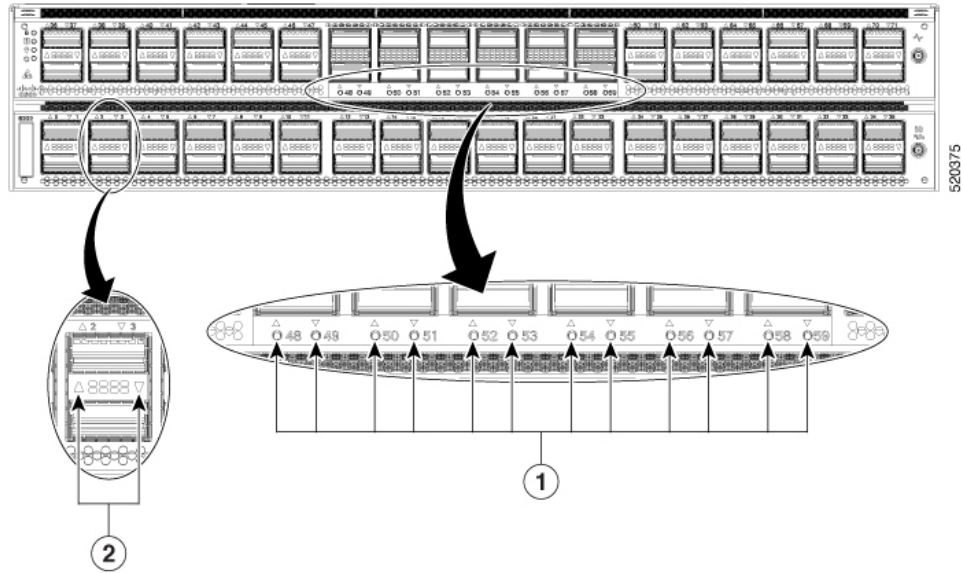

1	400G Port Status LED	2	100G Port Status LED
---	----------------------	---	----------------------

Figure 15: Port Status LED - Cisco 8201-32FH Chassis

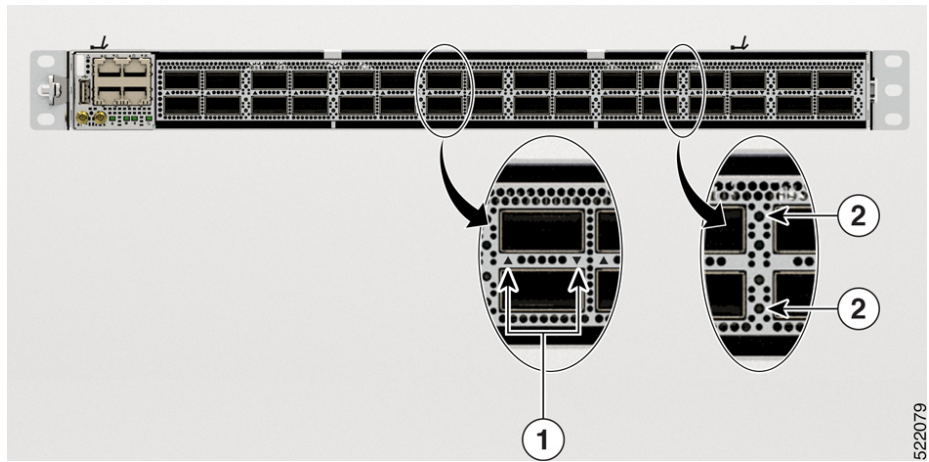

1	400 GbE port	2	400 GbE port status LED
---	--------------	---	-------------------------

Figure 16: Port Status LED - Cisco 8202-32FH -M Chassis

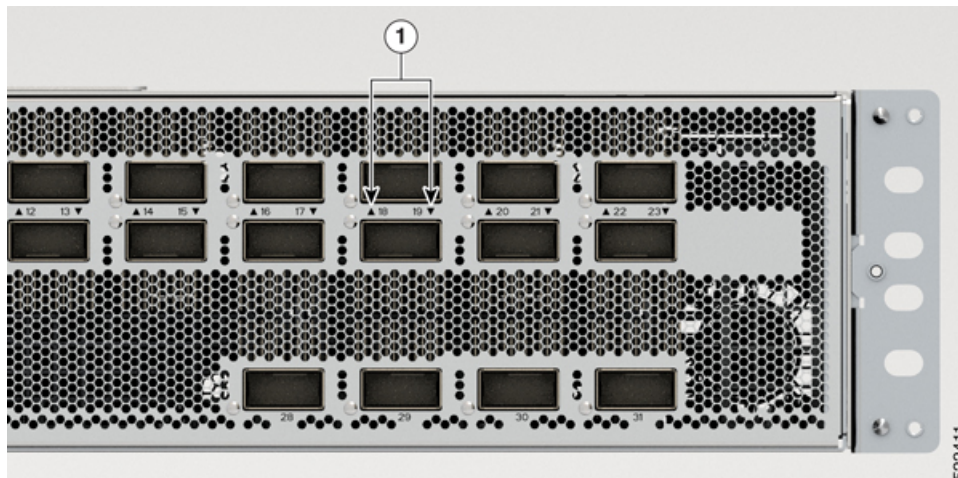

1	400G Port Status LED
---	----------------------

Figure 17: Port Status LED - Cisco 8201-24H8FH Router

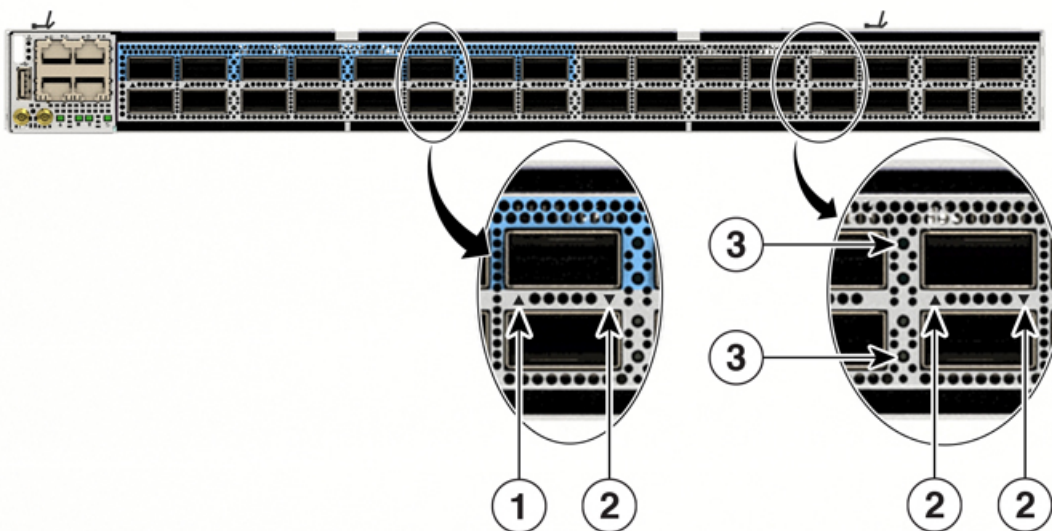

1	400 GbE port (blue)	3	Port status LED
2	100 GbE port		

Table 4: Port Status LEDs (one per port)

LED Color	Description
Off	Port is administratively shut down.
Amber	Port is administratively enabled and the link is down.

LED Color	Description
Green	Port is administratively enabled and the link is up.

