



CHAPTER 1

Overview

This chapter provides background concepts for installing and using Cisco Application Networking Manager (ANM) Virtual Appliance.



Note

This guide describes how to install and administer ANM Virtual Appliance only. For information about installing the ANM server software on a dedicated server, see the [Installation Guide for Cisco Application Networking Manager 5.2.5](#).

This chapter includes the following sections:

- [ANM Overview, page 1-1](#)
- [Using ANM Virtual Appliance, page 1-3](#)
- [Information About ANM High Availability, page 1-4](#)

ANM Overview

ANM is a client server application that enables you to perform the following functions:

- Configure, monitor, and troubleshoot the functions of supported data center devices.
- Create policies for operations, applications owners, and server administration staff to activate and suspend network-based services without knowledge of, or ability to, change network configuration or topology.
- Manage the following product types:
 - Cisco Application Control Engine (ACE) module or appliance
 - Cisco Global Site Selector (GSS)
 - Cisco Content Services Switch (CSS)
 - Cisco Catalyst 6500 Virtual Switching System (VSS) 1440
 - Cisco Catalyst 6500 series switch
 - Cisco 7600 series router
 - Cisco Content Switching Module (CSM)
 - Cisco Content Switching Module with SSL (CSM-S)
 - VMware vCenter Server

ANM is available in two versions, allowing you to install it on a dedicated server or on a VMware virtual machine as shown in [Figure 1-1](#). The capabilities and functions of the ANM software are the same regardless of which application you use. This guide uses the following terms to reference the two ANM applications:

- ANM server: Dedicated server with ANM server software and Red Hat Enterprise Linux (RHEL) operating system installed on it. For information about installing this type of ANM application, see the [Installation Guide for Cisco Application Networking Manager 5.2.5](#).
- ANM Virtual Appliance: VMware virtual appliance with ANM server software and Cisco Application Delivery Engine Operating System (ADE OS) installed on it. Cisco distributes ANM Virtual Appliance in Open Virtual Appliance (.OVA) format.

Figure 1-1 Sample ANM Network Deployment

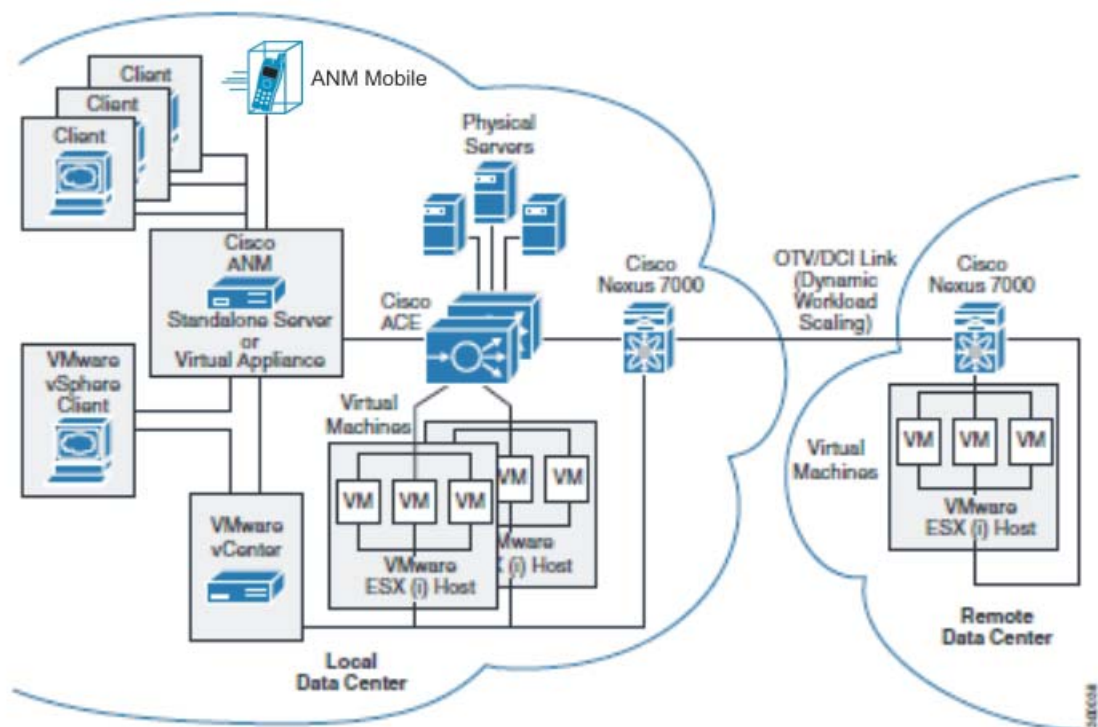

[Figure 1-1](#) shows how ANM and the ACE can be integrated with VMware, allowing you to create and manage server farms for application delivery that consist of real servers that are a combination of physical servers and VMware virtual machines (VMs).

The sample network application illustrates the following ANM and ACE features:

- Dynamic Workload Scaling—ACE feature that permits on-demand access to remote resources, such as VMs, that you own or lease from an Internet service provider (or cloud service provider). This feature uses Cisco’s Nexus 7000 series switches with Overlay Transport Virtualization (OTV), which is a Data Center Interconnect (DCI) technology used to create a layer 2 link over an existing IP network between geographically distributed data centers.

For more information, see the “[Dynamic Workload Scaling Overview](#)” section in the 5.2.4.



Note Dynamic Capacity Expansion requires ACE module or appliance software version A4(2.0) or later and the Cisco Nexus 7000 series switch.

- ANM plug-in for vCenter Server—Plug-in on an ANM server or ANM Virtual Appliance that permits access to ANM’s ACE server load-balancing functions from a VMware vSphere Client. For more information, see the “[Using ANM With Virtual Data Centers](#)” section in the *User Guide for the Cisco Application Networking Manager 5.2.5*.
- ANM Mobile—Feature that enables supported mobile devices to access to your ANM server or ANM Virtual Appliance, allowing you to manage the network objects in much the same way you do from an ANM client. Using a mobile device, you can run ANM Mobile as a native application or inside the mobile device’s browser. For more information, see [Chapter 19, “Using ANM Mobile”](#) in the *User Guide for the Cisco Application Networking Manager 5.2.5*.

Using ANM Virtual Appliance

A virtual machine (VM) is a software artifact that encapsulates a complete computing system, including applications, operating system, and physical resources. For ANM Virtual Appliance, you run ANM on a virtual machine, which provides the following benefits over a dedicated server installation:

- Easier to deploy, scale, and migrate.
- Provides more efficient utilization of hardware resources (just-in-time resource provisioning, for example).
- Eliminates the need for installing and maintaining the operating system separately.

You install ANM Virtual Appliance by deploying an Open Virtualization Format (OVF) file from VMware tools, such as the VMware vSphere Client. An OVF file simplifies the process of deploying a virtual machine by providing a complete definition of the parameters and resource allocation requirements for the new virtual machine.

The VMware vSphere Client is an MS Windows application for configuring and managing virtual machines on the VMware vCenter server. After ANM Virtual Appliance is deployed, you can perform basic administration tasks for ANM Virtual Appliance, such as starting and stopping the virtual machine, through the VMware vSphere Client.

While the operation of ANM Virtual Appliance and ANM server are largely identical, there are a few notable differences. For example, ANM server runs on the RedHat operating system; however, the operating system included with ANM Virtual Appliance is the Cisco ADE OS, version 2.0.

The ADE OS has an IOS-like command line interface (CLI) that you can use to perform setup and administrative tasks for ANM Virtual Appliance. You can use the CLI to perform many functions related to the basic operation of the appliance, such as applying its license, configuring network settings, and backing up the ANM application instance.

To access the ADE OS command line, you use an SSH client or the console tab in the VMware vSphere Client, as shown in [Figure 1-2](#).

Figure 1-2 vSphere Client Console Tab

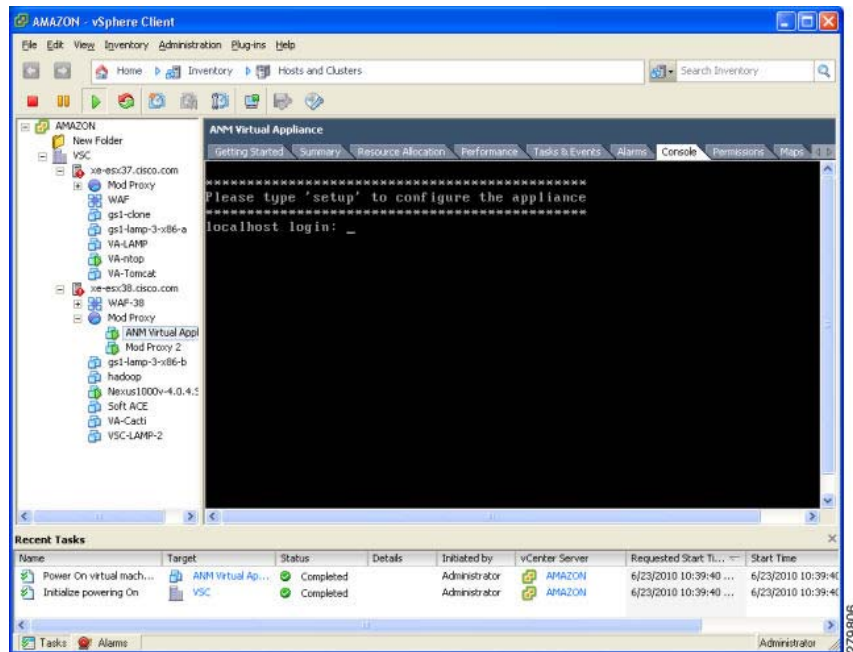

The ADE OS is installed along with the ANM Virtual Appliance application when you deploy the ANM OVF file. For ANM Virtual Appliance, you do not need to separately install or maintain the operating system.

Information About ANM High Availability

You can implement redundancy for ANM Virtual Appliance using the high availability feature of the underlying VMware vSphere platform. VMware HA (High Availability) detects faults in the operation of managed virtual machines and provides redundancy in case of a failure.

You implement VMware HA for ANM Virtual Appliance in the same manner as for any VM-based application running on VMware infrastructure; that is, ANM Virtual Appliance does not impose any special requirements for implementing VMware HA.

For more information on VMware HA, see the VMware documentation.