

产品概述

物联网场景的发展

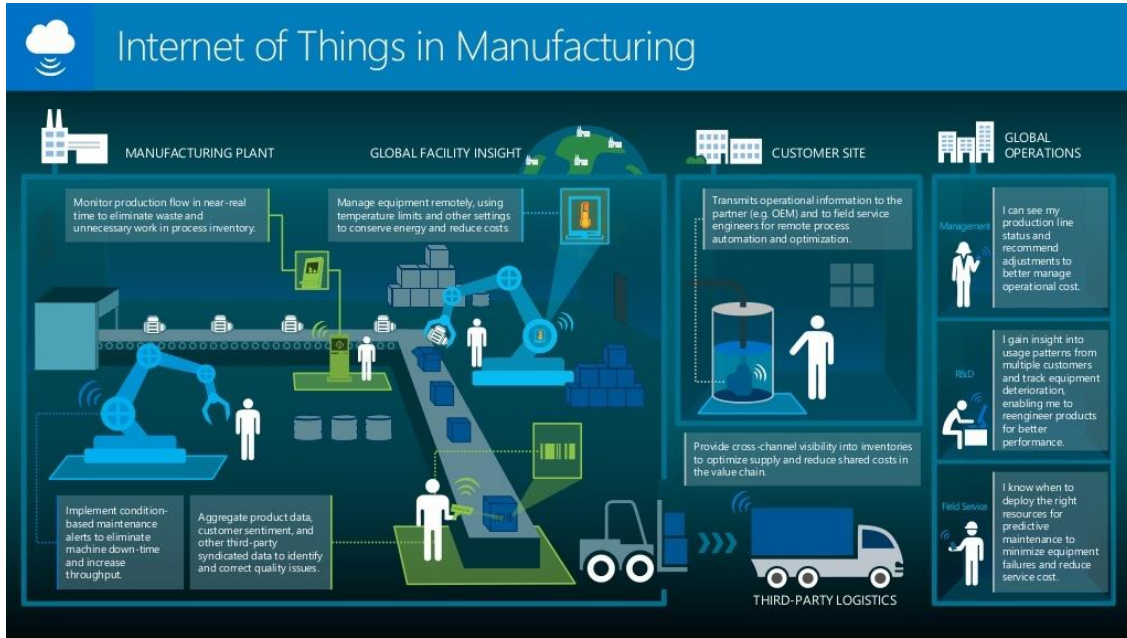

物联网技术的发展



IT等不了

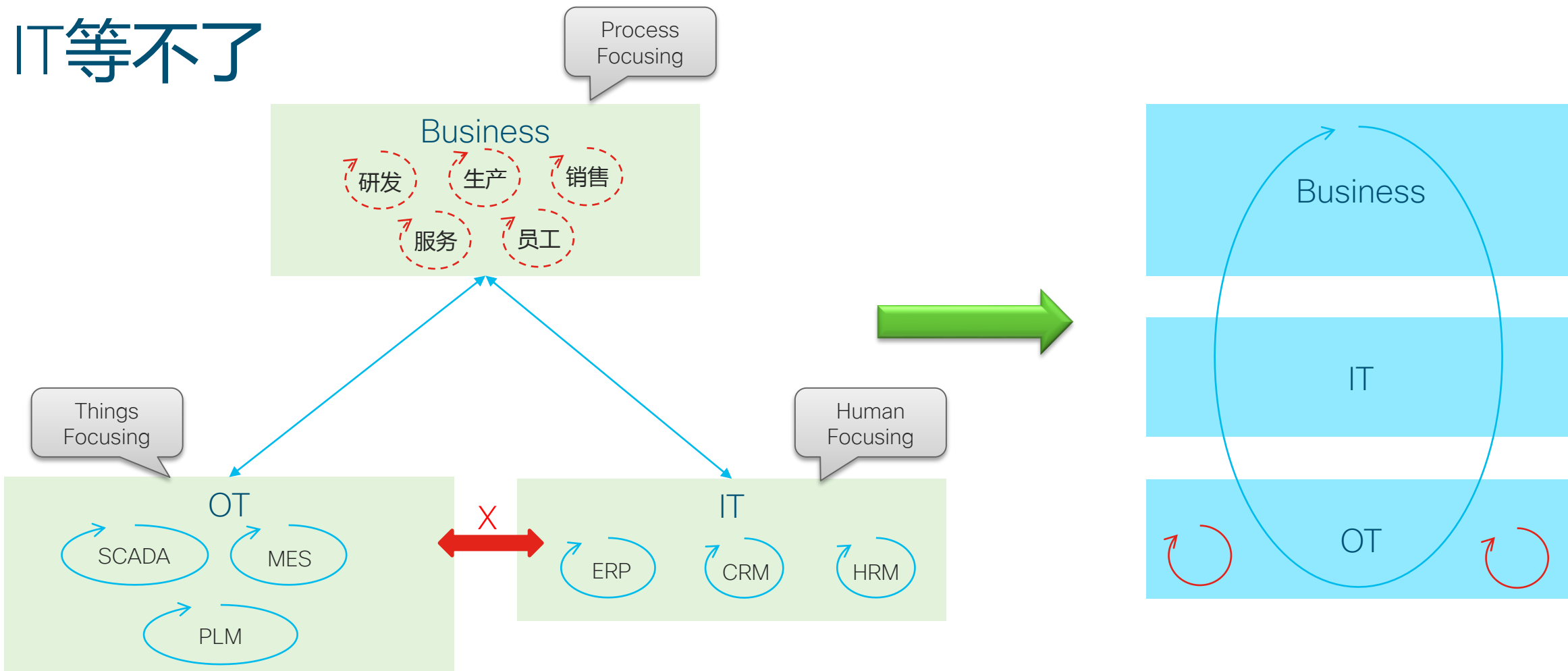

- 利用IT技术增强OT
- 打通IT和OT的信息孤岛
- 带动企业流程的创新

如何打通IT和OT的信息孤岛

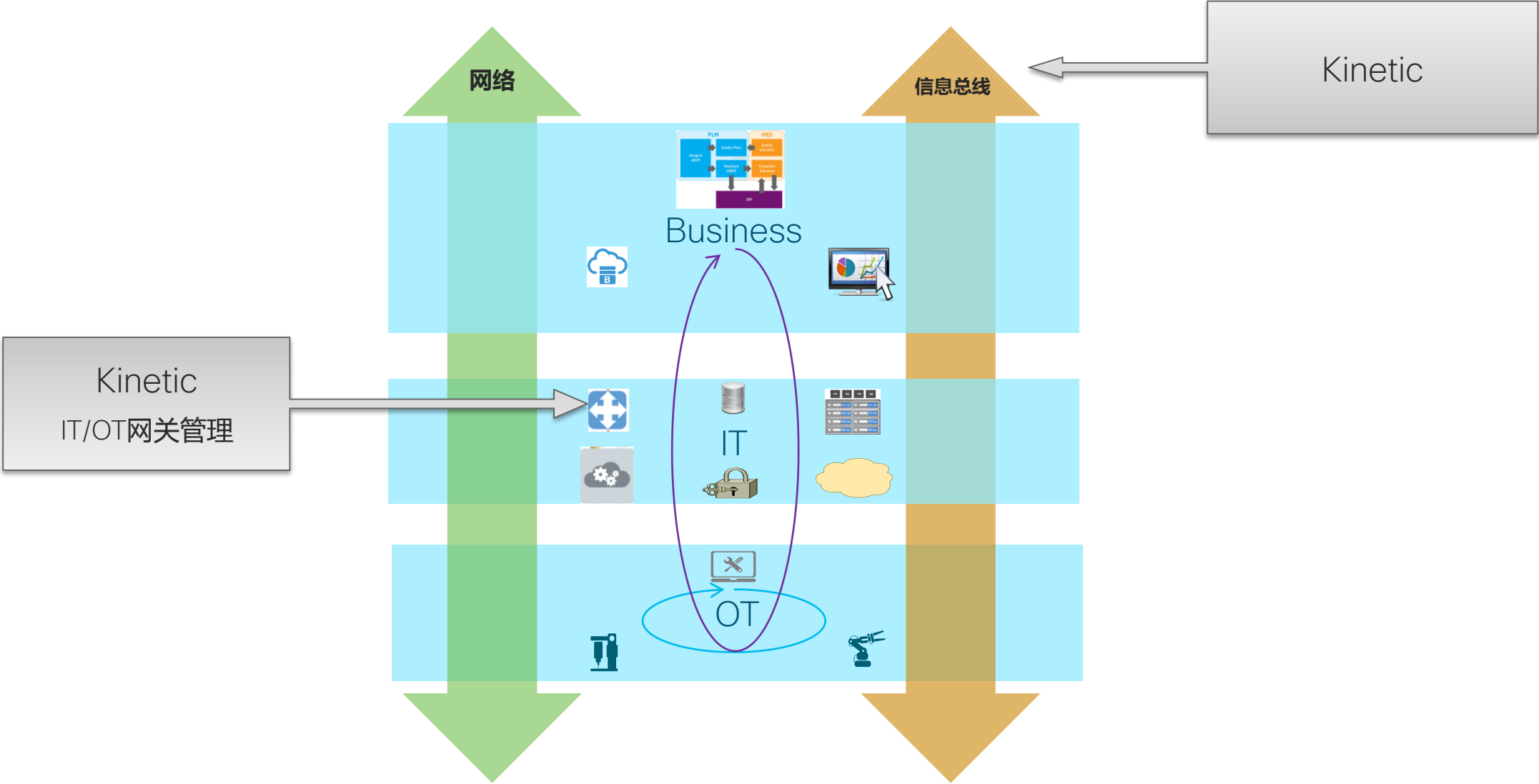

Kinetic

是软件，不是硬件

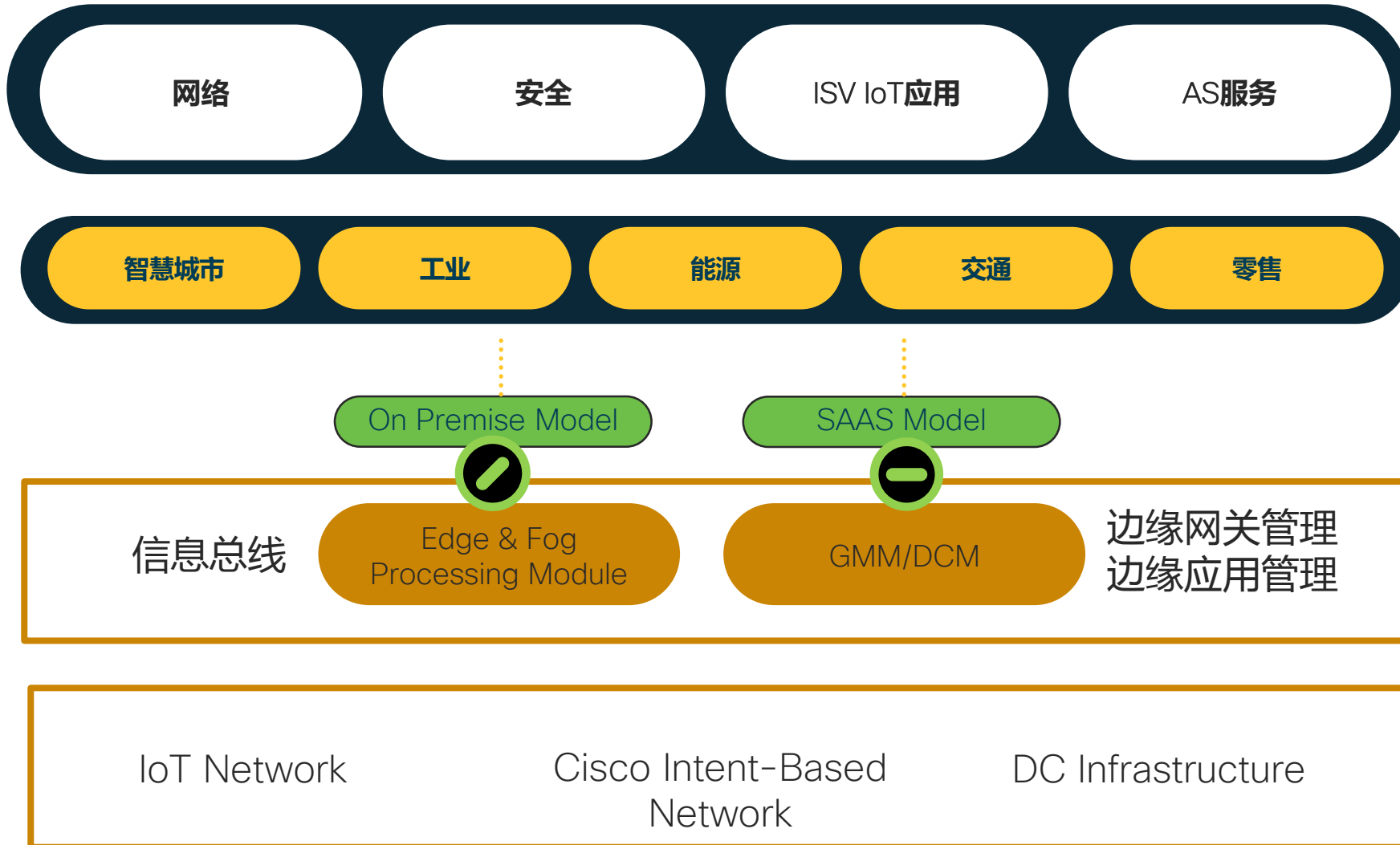

- 1 3个模块可以单独购买
(GMM/DCM在中国暂时不能销售)
(边缘网关和边缘应用可以本地化管理)
- 2 2种服务方式和订购方式
- 3 应用于5个行业
- 4 可以和思科其他方案结合

信息总线的构建的难点在哪里

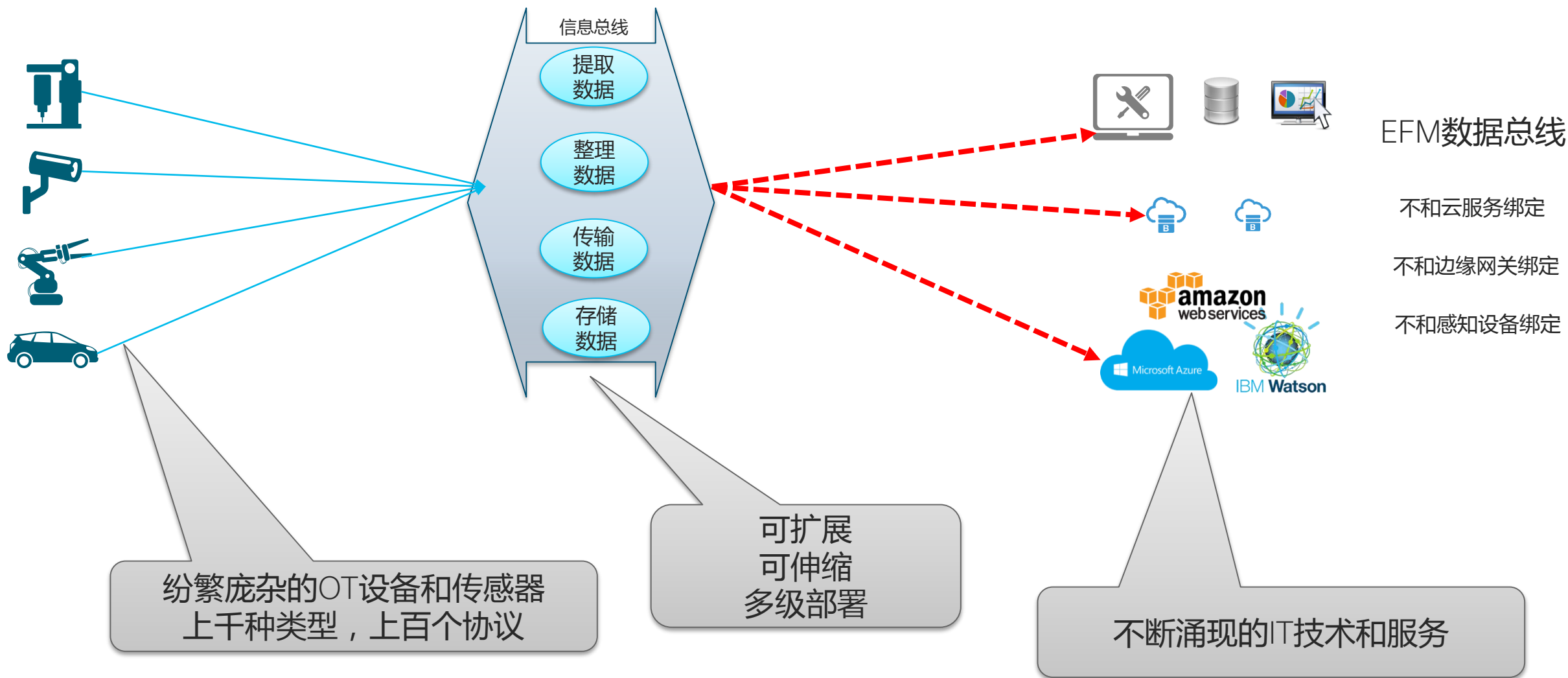

Kinetic EFM是如何工作的 - 核心场景



Device



Fog



Cloud

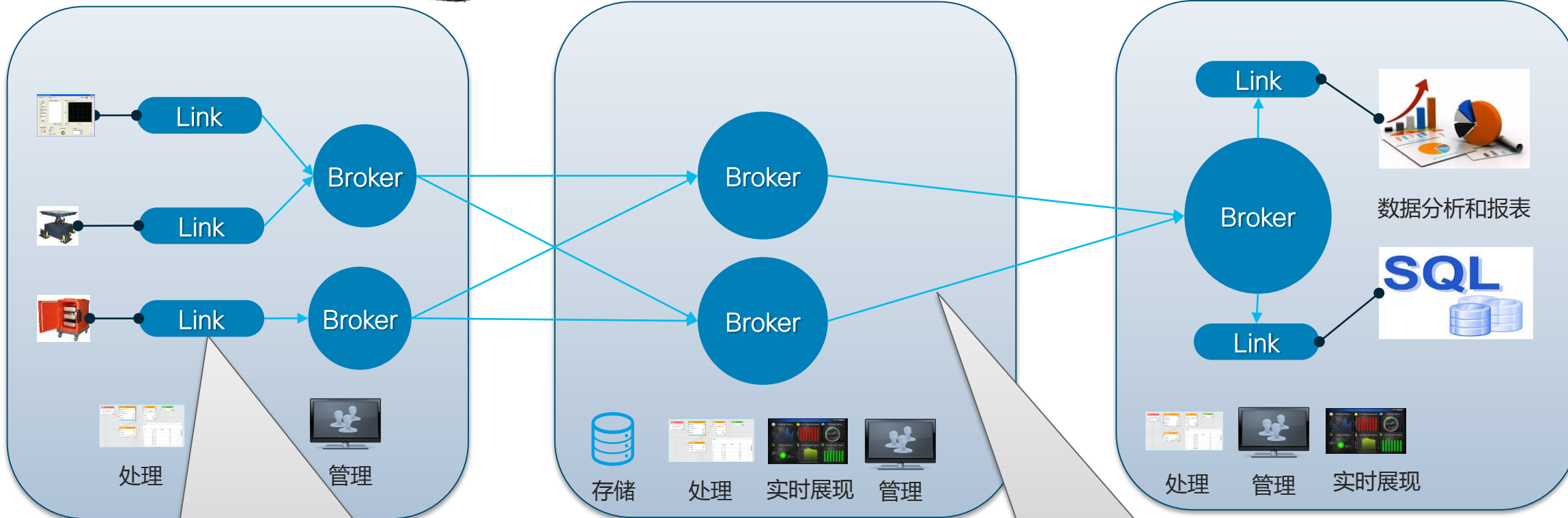

微服务架构 (DS-LINK和Broker)
通过拆卸式DS-Link适配不同协议
可以完成定制开发

通过Broker实现网络式扩展

EFM支持的协议

南向协议
Modbus
CC-LINK
OPC-UA
MT-Connect
CIP
iec61850
FTP
.....

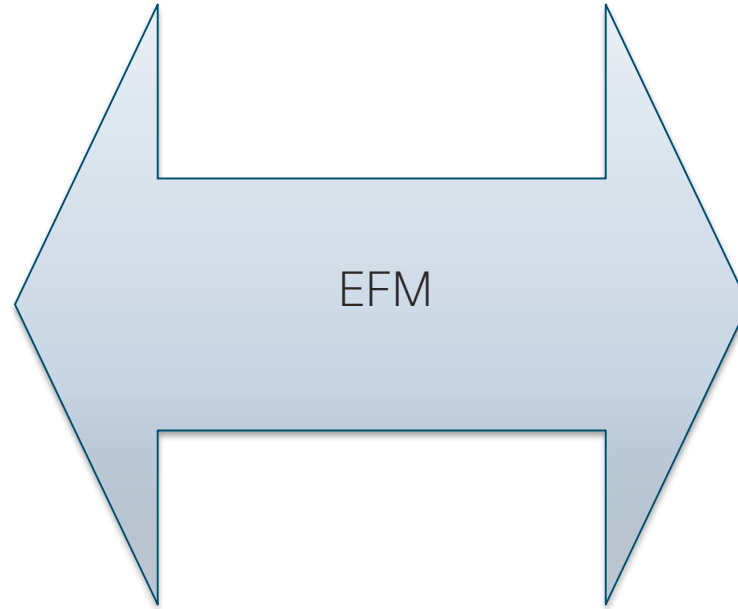

DS-Link代码

北向协议
MQTT
Kafka
JDBC
My SQL
Mango DB
Filesystem
Splunk
.....

边缘网关

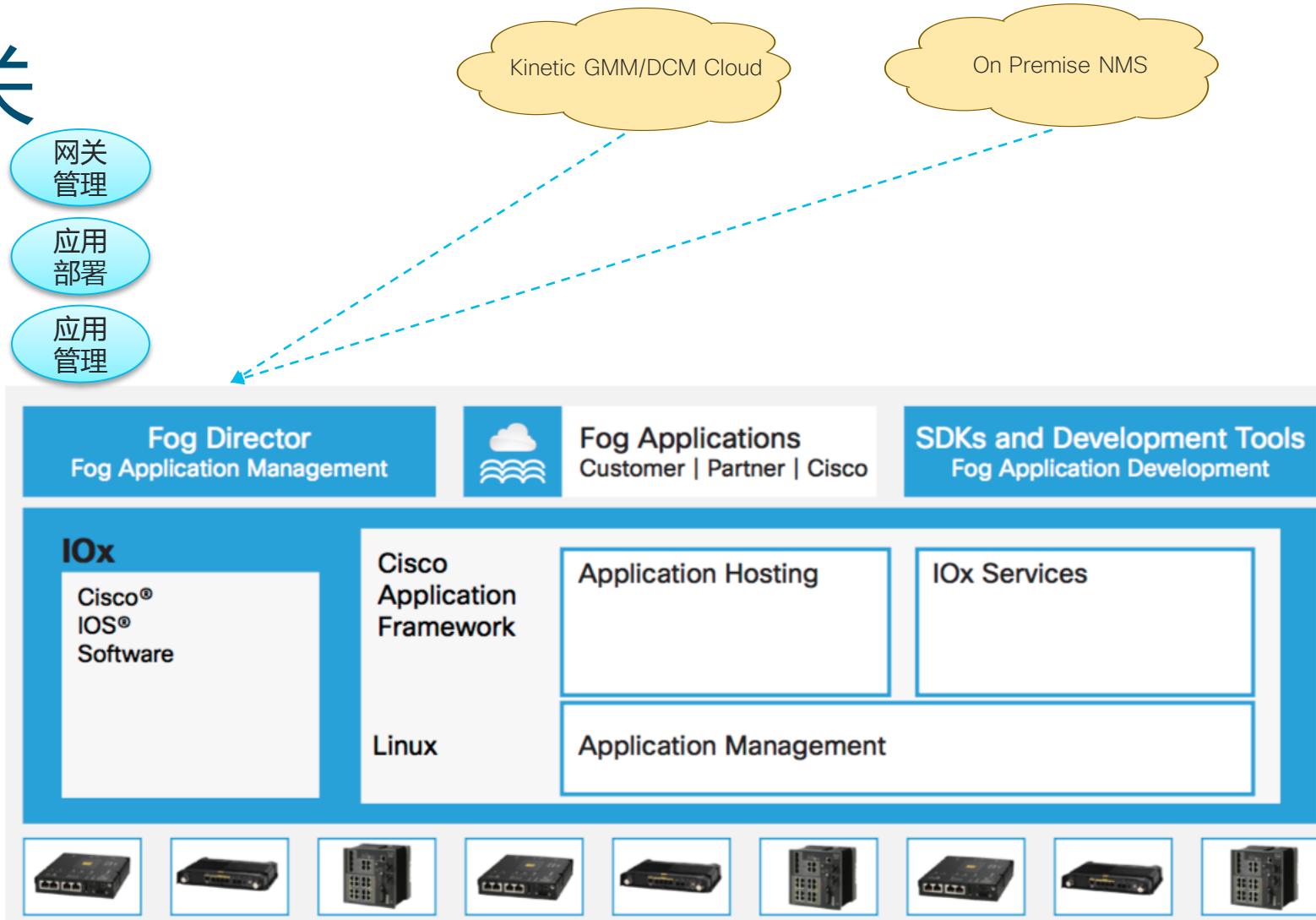

Kinetic衍生场景- Use Case

					
行业	Cisco Kinetic for Cities	Cisco Kinetic for Manufacturing	Cisco Kinetic for Oil & Gas	Cisco Kinetic for Transportation	Cisco Kinetic for Retail
场景	<ul style="list-style-type: none">  Lighting  Parking  Urban Mobility <small>(Traffic Analytics, Crowd Analytics)</small>  Environment  Safety & Security 	<ul style="list-style-type: none">  智能制造  预测性维护  能效管理  物料追踪 	<ul style="list-style-type: none">  钻探  油井  冶炼 	<ul style="list-style-type: none">  港口运输  公路运输 	<ul style="list-style-type: none">  Retail Site Monitoring  Sports & Entertainment <small>(concessions)</small>

Kinetic Value Proposition

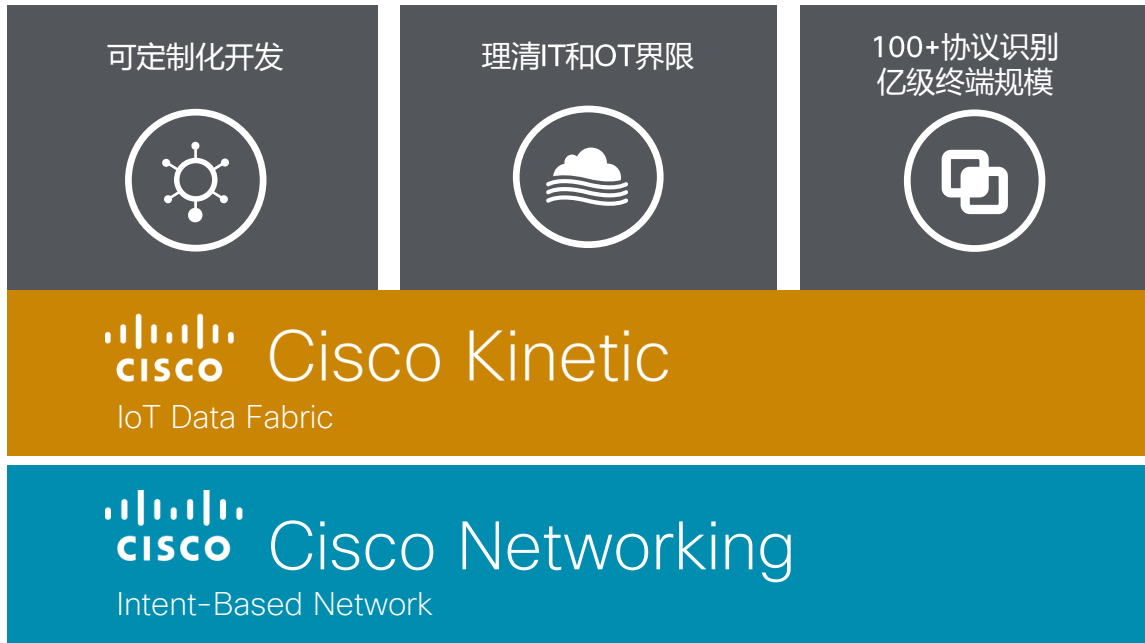

信息总线，打通IT和OT

微服务架构，开放的生态
100+协议识别，可定制化开发
亿级终端规模支持

依托思科网络

Kinetic的合作伙伴



Cisco Kinetic – EFM Customers

Oil & Gas



Transportation/ Roadways



Manufacturing



Others



如何卖

Kinetic GTM Strategy

Item	Kinetic
Value Proposition	IoT Data Fabric <ul style="list-style-type: none">• 开放生态系统，南向通过定制化接入各类数据，北向和各种应用对接• 联合思科网络架构，为IT和OT整合打通“任督二脉”
Target	<ul style="list-style-type: none">• 制造业, 能源, 交通, 零售
Message	<ul style="list-style-type: none">• 围绕核心应用场景开始沟通
Product	<ul style="list-style-type: none">• 中国已经可以订购 (KIN-PROD-PLAT-T)
Partner	<ul style="list-style-type: none">• Kinetic集成商计划• 思科SPA和COE计划
Service	<ul style="list-style-type: none">• TS Global Ready• Devnet IoT Global• Kinetic 专业合作伙伴 / Cisco AS 支持
Pilot/PoC/Demo Kit	<ul style="list-style-type: none">• dCloud• CRDC Devnet Team

思科解决方案合作伙伴加速计划

奖励目标:

思科® 解决方案合作伙伴加速计划 (SPA), 旨在激励具备解决方案提供能力的合作伙伴, 鼓励其将思科产品、软件和服务作为解决方案的一部分, 从而为客户带来更高的业务价值。满足条件的解决方案合作伙伴, 将得到思科的奖励政策支持, 以快速拓展客户、占领市场。

所有符合条件的解决方案合作伙伴, 通过BDM或PAM邀请参与注册, 都有机会享受在软件开发或销售业绩的奖励目标。