



SAImet Package 1.0.0.8 Installation and Configuration Guide

Introduction

The Metadata Extraction Tool (MET) is contained in Cisco's SAImet software package. The SAImet package is installed on the Digital Network Control System (DNCS) and helps support video-on-demand (VOD) on the Cisco Videoscape Voyager Vantage (Vantage) platform.

Purpose

This document provides instructions to provision Arris VOD services for Vantage Version 3.3 clients. This document describes the DNCS configuration required to provide these services, as well as providing installation instructions for the SAImet package on the DNCS. This package is required to provide catalog and metadata services through the SQLite database from the Arris back-office to the client Broadcast File System (BFS).

Audience

This document is written for service providers, headend operators, and support engineers who are responsible for running and maintaining the Vantage product.

Document Version

This is the first formal release of this document, which accounts for Version 1.0.0.8 of the Metadata Extraction Tool.

In This Document

■ Metadata Extraction Tool Description.....	3
■ Configure the BFS.....	5
■ Configure the Arris CMM VOD Server.....	10
■ Install the SAImet Package.....	12
■ Configure the MET Interfaces.....	14
■ Configure svcadm for MET Program IDs	17
■ Add Arris Servers to the /etc/hosts File.....	18
■ Restart the metasm Process and Verify the Files.....	19
■ Edit the config.ini File	20
■ Add the Subscription VOD Package.....	23

Metadata Extraction Tool Description

The Metadata Delivery System (MDS) is the source of all Arris VOD metadata for the customer-premises equipment (CPE). This includes providing all additions, updates, and deletions for all required metadata elements.

Upon startup, the MDS reads and caches several predefined configuration files. These files contain the TCP IP address and port of the Arris VOD publisher, the SQLite database schema details, and the Arris-to-Media Suite database field mappings. Subsequently, the MDS will utilize the Arris VOD publisher IP address and port, retrieved from the configuration file, to establish a persistent TCP connection with the publisher. While this connection's underlying network protocol is TCP, the MDS will accommodate an HTTP-like XML-based application layer publisher/subscriber protocol, as set forth by the Arris VOD publisher specifications. Accordingly, the MDS will issue a subscription request to the publisher that contains the list of metadata-on-demand (MOD) names for which it wants to register (receive updates).

Upon successful subscription, the VOD publisher returns a complete list of metadata for each MOD name specified by the MDS. After receiving this initial complete list of metadata, all subsequent data received from the Arris VOD publisher will be updates -- additions, modifications, and deletions. Upon successful retrieval of the complete list of MOD metadata or any metadata modifications, the MDS will parse the recovered stream. Initially, this entails the separation of the HTTP-like headers from the actual XML message content. Once the XML message is identified and secured, it is also parsed so as to acquire those metadata elements to be transformed into MediaSuite-compatible entities.

Next, and in accordance with the database schema and field mappings contained in the aforementioned configuration files, the resultant MediaSuite entities will be inserted into an SQLite database file. Using the current DNCS BFS server API, this file will then be placed on an in-band BFS carousel to be consumed by the CPE devices.

In addition to the delivery of the database files, a category hierarchy file (CHF), and a summary file (SF) are also placed on an in-band and out-of-band BFS carousel. The CHF should contain all of the categories to be encountered by the client during metadata processing, while the SF will contain information describing the previously created SQLite database files. The following diagram depicts the entire process flow required by the MDS portion of the MET subsystem.

MET High-Level Diagram

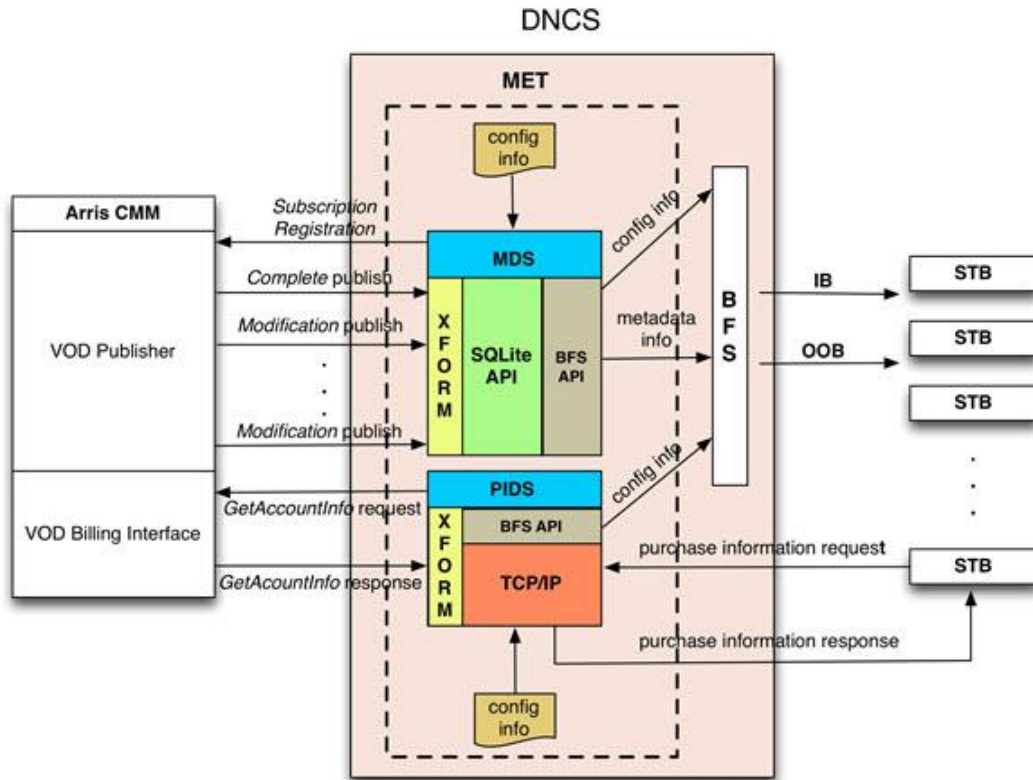

Empty Categories

The MET database contains categories as originally sent from Arris, which the MET then forwards to set-top boxes (STBs). Should any of these categories be empty, an empty category is displayed to the subscriber.

Cisco has provided a parameter (`allowEmptyCats`), set in the `MetConfig.xml` file, that allows the system operator to determine how the system treats empty categories.

- `allowEmptyCats` set to true – The MET server propagates empty categories to the STB
- `allowEmptyCats` set to false – The MET server removes empty categories before propagating them to the STB

Note: Parent categories are also checked and removed if there are no assets in any of their sub-categories.

Configure the BFS

Add the BFS Sources

Follow this outline to add the **met_ib** and **met_oob** BFS sources to the DNCS. Configure the sources as depicted in the screen-captured images.

- 1 Access the DNCS BFS Sources window.

The screenshot shows the 'DNCS BFS Sources' window in a web browser. The table below represents the data visible in the screenshot:

ID	Name	Type	Location	Protocol	IP	Port	Status
3	CAM OOB	BFS	Out-of-band	N/A	N/A	N/A	10000 enabled
4	CAM IB	BFS	In-band	Multicast	230.2.2.2:13821	129	rfgw-1d 29 1000000 enabled
5	IPG OOB	BFS	Out-of-band	N/A	N/A	N/A	10000 enabled
6	IPG1 IB	BFS	In-band	Multicast	230.2.2.3:13821	130	rfgw-1d 29 1000000 enabled
7	IPV OOB	BFS	Out-of-band	N/A	N/A	N/A	10000 enabled
8	IPV IB	BFS	In-band	Multicast	230.2.2.4:13821	131	rfgw-1d 29 1000000 enabled
9	SAM	BFS	Out-of-band	N/A	N/A	N/A	50000 enabled
10	IPG2 IB	BFS	In-band	Multicast	230.2.2.5:13821	132	rfgw-1d 29 1000000 enabled
11	POD_CHANNELS	BFS	Out-of-band	N/A	N/A	N/A	50000 enabled
12	IPG3 IB	BFS	In-band	Multicast	230.2.2.6:13821	133	rfgw-1d 29 1000000 enabled
14	IPG4 IB	BFS	In-band	Multicast	230.2.2.7:13821	134	rfgw-1d 29 1000000 enabled
16	IPG5 IB	BFS	In-band	Multicast	230.2.2.8:13821	135	rfgw-1d 29 1000000 enabled
18	IPG6 IB	BFS	In-band	Multicast	230.2.2.9:13821	136	rfgw-1d 29 1000000 enabled
20	IPG7 IB	BFS	In-band	Multicast	230.2.2.10:13821	137	rfgw-1d 29 1000000 enabled
21	MMN OOB	BFS	Out-of-band	N/A	N/A	N/A	50000 enabled
22	IPV B2	BFS	In-band	Multicast	230.2.2.11:13821	138	rfgw-1d 29 1000000 enabled
24	SGM IB	BFS	In-band	Multicast	230.2.2.12:13821	165	rfgw-1d 29 500000 enabled
26	SGM IB1	BFS	In-band	Multicast	230.2.2.13:13821	166	rfgw-1d 29 500000 enabled
28	SGM B2	BFS	In-band	Multicast	230.2.2.14:13821	167	rfgw-1d 29 500000 enabled
30	SGM B3	BFS	In-band	Multicast	230.2.2.15:13821	168	rfgw-1d 29 500000 enabled
32	SGM B4	BFS	In-band	Multicast	230.2.2.16:13821	169	rfgw-1d 29 500000 enabled
199	bootloader	Bootloader	In-band	Multicast	230.2.2.17:13821	170	rfgw-1d 29 2000000 enabled
202	AppStBand	BFS	In-band	Multicast	230.2.2.18:13821	141	rfgw-1d 29 2000000 enabled
225	ams_esp	BFS	In-band	Multicast	230.2.2.19:13821	175	rfgw-1d 29 500000 enabled
226	ams_meta	BFS	In-band	Multicast	230.2.2.20:13821	176	rfgw-1d 29 1000000 enabled
227	ams_core	BFS	In-band	Multicast	230.2.2.21:13821	177	rfgw-1d 29 1000000 enabled
230	met_ib	BFS	In-band	Multicast	230.2.2.22:13821	174	rfgw-1d 29 1000000 enabled
231	met_oob	BFS	Out-of-band	N/A	N/A	N/A	100000 enabled

Configure the BFS

2 Add the met_ib Source.

The screenshot shows the Cisco Explorer Controller interface for configuring a BFS Source. The configuration is as follows:

- Source Name: met_ib
- Source ID: 230
- Source Type: BFS Bootloader
- Transport Type: In-band Out-of-band
- Data Rate: 1.0 Mbps
- Indication Interval: 100 msec
- Data Pump: run stop
- Available Host: (empty)
- Selected Host: dncatm
- Available Local BFS QAMs: BFSQAM (selected), Line-Id
- Output Ports: (empty)
- Output TSID: 29
- Input Program Number (optional): 174
- Multicast: Multicast Unicast
- Multicast Destination IP: 230.2.2.22
- Enabled QAM Ethernet Input Port: 3

Buttons: Save, Cancel

3 Add the met_oob Source.

The screenshot shows the Cisco Explorer Controller interface for configuring a BFS Source. The configuration is as follows:

- Source Name: met_oob
- Source ID: 231
- Source Type: BFS Bootloader
- Transport Type: In-band Out-of-band
- Data Rate: 0.1 Mbps
- Indication Interval: 200 msec
- Data Pump: run stop
- Available Host: (empty)
- Selected Host: dncatm

Buttons: Save, Cancel

Add the BFS Server

Add the vod BFS server.

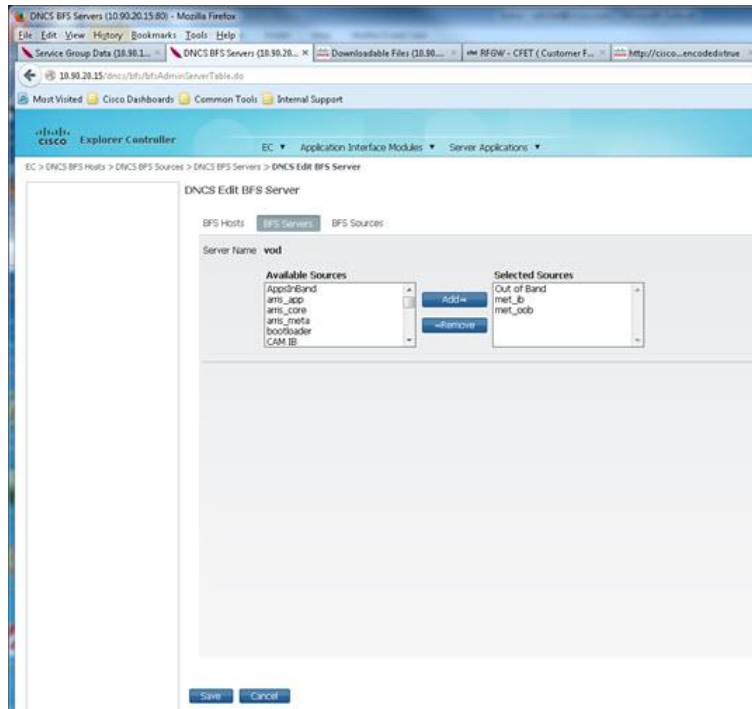

Configure the BFS

Add the vod Cabinet and vod Files

Follow this outline to add the **vod** cabinet and the **met_ib** and **met_oob** files.

Note: The files shown in the Broadcast File Server List (immediately following) are populated by the MET during publishing for STB metadata and catalog consumption.

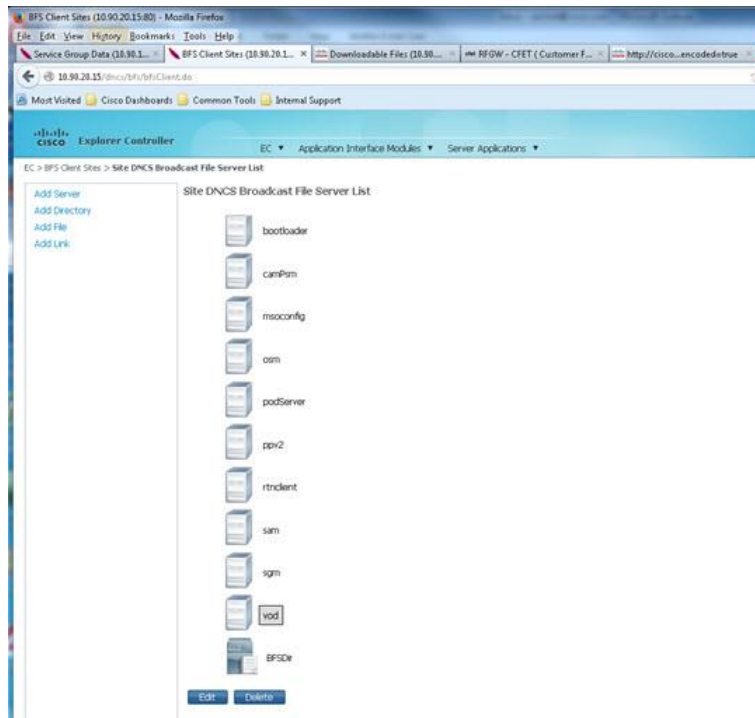

Add met_ib Files and met_oob Files

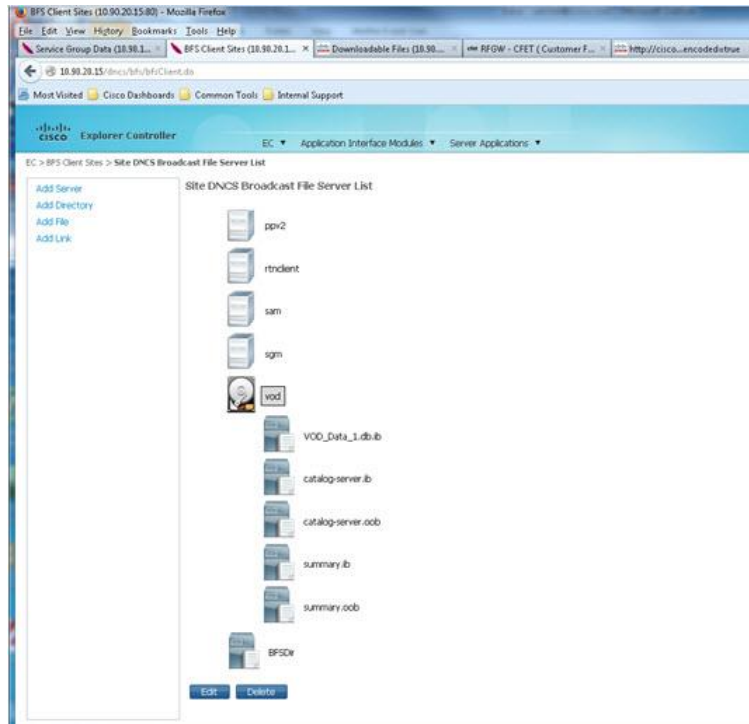

Configure the Arris CMM VOD Server

- 1 Log into the Arris CMM server and navigate to **Export Views**.
- 2 Verify the catalog and folder structure.

Note: The screenshots that follow depict a typical Dashboard, Export View window and Categories window of an Arris back-office. Consider these as references for this document when you configure the MET and the config.ini file on the DNCS. The actual folder structure will vary, depending upon site specifics and customer preference.

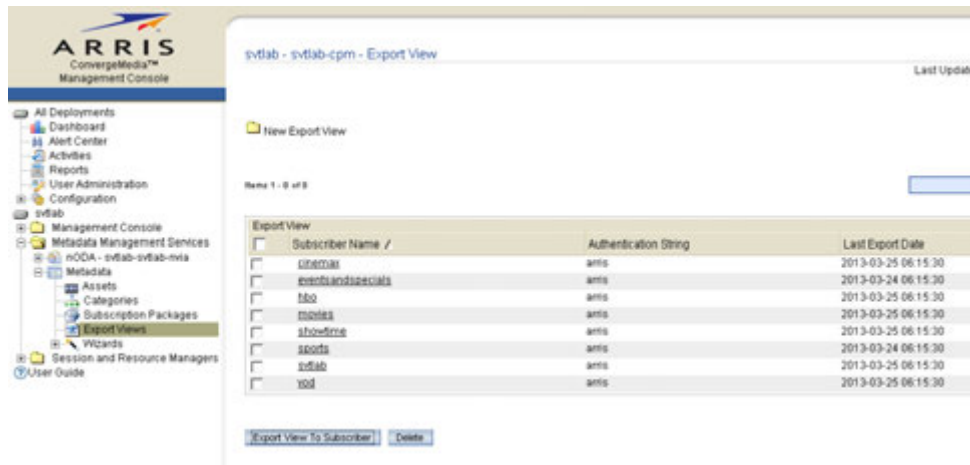
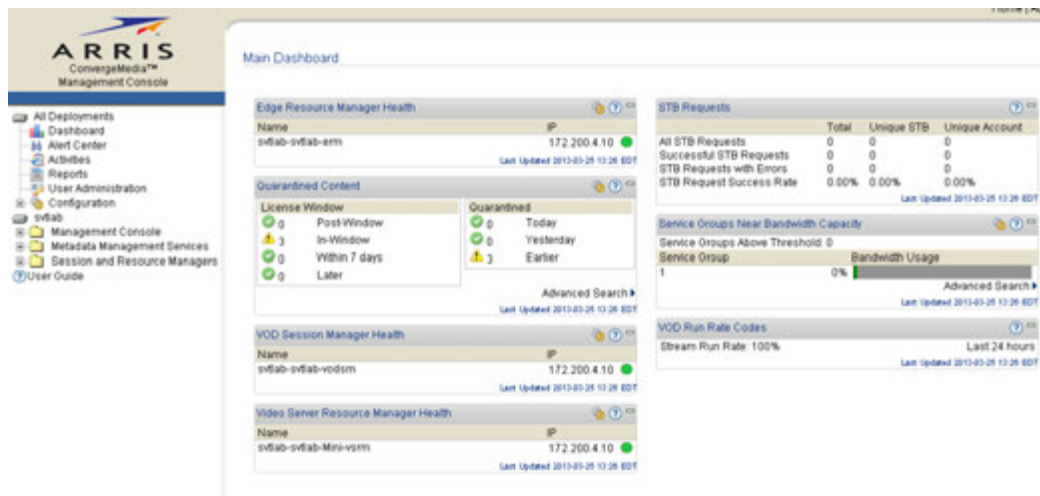



Important:

- Detail on how to configure the Arris server software and interfaces for MET communication is beyond the scope of this document. Cisco expects that the vendor will handle these details upon installation.
- Much of the Arris configuration is done through the configuration files. Contact Arris if you need to change the service group, set up additional GQAM modulators, or change or add channels that you would like to appear on the STB.

Install the SAImet Package

Follow these instructions to install the SAImet package on the DNCS:

- 1 Log on as the **root** user on the DNCS.
- 2 Insert the CD that contains the SAImet software into the DVD drive of the DNCS. The DNCS mounts the CD.
- 3 Type the following command and press **Enter** to confirm that the DNCS mounted the CD:

```
df -k | grep cdrom
```

Result: Output similar to the following should appear:

```
/vol/dev/dsk/c0t0d0/met-1.0.0.x    5804    5804        0    100%
/cdrom/met-1.0.0.x
```

- 4 Type the following command and press **Enter** to change to the /cdrom/cdrom0 directory:

```
cd /cdrom/cdrom0
```

- 5 Type the following command and press **Enter** to verify the contents of the CD:

```
ls
```

Result: Output should show the SAImet package.

- 6 Type the following command and press **Enter** to install the SAImet package:

```
install_pkg
```

Result: The installation begins. Output similar to the following should appear:

```
Checking the system, please wait...
```

```
*****
```

```
This script will install the following packages on "roger":
```

```
SAImet          MET 07-06-12
                1.0.0.x
```

```
*****
```

```
Are you SURE you want to continue? [y,n,?,q]
```

- 7 Type **y** and press **Enter** to continue.

```
Installing SAImet package on roger...
```

```
Processing package instance <SAImet> from </cdrom/met-1.0.0.x>
```

```
MET 07-06-12(SunOS_sparc) 1.0.0.x
```

```
## Executing checkinstall script.
```

```
*****
```

```
Copyright (c) 1998-2012 Cisco Systems, Inc.
```

```
All Rights Reserved
```

```
This product is protected by copyright and distributed under
licenses restricting copying, distribution and decompilation.
```

```
*****
```

```
Using </dvs> as the package base directory.
```

```
## Processing package information.
```

```
## Processing system information.
```

```
9 package pathnames are already properly installed.
```

```
Installing MET 07-06-12 as <SAImet>
```

```
## Executing preinstall script.
```

```
Adding met:700 group.
```

```
Adding met:700 account.
```

```

64 blocks
passwd: password information changed for met
passwd: password information changed for met
## Installing part 1 of 1.
/dvs/met/bin/metcfg
/dvs/met/bin/metmds
/dvs/met/bin/metpids
/dvs/met/bin/metsm
/dvs/met/lib/libMetlib.so
/etc/CiscoProcessInfo.d/SAImet.txt
/lib/svc/method/svc-metsm
/var/svc/manifest/application/metsm.xml
[ verifying class <none> ]
/dvs/met/etc/metdb.sql <attribute change only>
## checking common configuration files
/dvs/met/etc/MetConfig.xml preserved
[ verifying class <preserve> ]
Modifying /etc/inet/services
Modifying /etc/logadm.conf
Modifying /etc/syslog.conf
[ verifying class <sed> ]
## Executing postinstall script.
passwd: password information changed for met
Installation of <SAImet> was successful.
For more SAIMet package installation messages refer to:
/var/sadm/system/logs/SAImet_1.0.0.x_install.log
# pwd
/cdrom/met-1.0.0.x

```

- 8 Examine the log file (/var/sadm/system/logs/SAImet_1.0.0.x_install.log) for any error messages.
- 9 Were there any errors?
 - If **yes**, troubleshoot the error(s) or contact Cisco Services for assistance.
 - If **no**, continue with Step 10.
- 10 Follow these instructions to eject the CD:
 - a Type **cd /** and press **Enter**.
 - b Type **eject** and press **Enter**.

Configure the MET Interfaces

- 1 Type the following command and press **Enter** to switch from the root user to the met user:

```
su - met
```

- 2 Type the following command and press **Enter** to change to the /dvs/met/etc directory:

```
cd /dvs/met/etc/
```

- 3 Type the following command and press **Enter** to confirm the contents of the directory:

```
ls
```

Example: Output should be similar to the following:

```
onfigODA.ini MetConfig.xml metdb.sql.orig metism.pid
```

- 4 Are you installing the MET software after the Explorer Controller (EC) migration (SR 6.0)?

- If **yes**, follow these instructions.

- a Copy the MetConfig.xml file that you saved from the migration, to the /dvs/met/etc directory.

- b Skip Step 5; you are finished with this procedure.

- If **no**, (you have not done the EC migration) continue with Step 5.

- 5 Edit the MetConfig.xml file with a text editor such that the items marked in bold (in the following example) match the Arris back-office and DNCS configuration.

Note: This view describes the catalog and folder structure for the BFS SQLite database. The config.ini file is updated with the UID such that the client will reflect the catalog in the user interface.

```
<?xml version="1.0" encoding="UTF-8"?>
```

```
<Met syslog="local6">
```

```
  <BFS ibsrcid="230" oobsrcid="231"/>>
```

```
  <MDS pubIP="arriscmm" pubport="4537" threads="5" debug="true"
  mms="10000" gzip="false" cti="3" ctic="20" mti="120">
```

```
    <MOD name="cinemax" authstr="arris"/>
```

```
      <MOD name="eventsandspecials" authstr="arris"/>
```

```
      <MOD name="hbo" authstr="arris"/>
```

```
      <MOD name="movies" authstr="arris"/>
```

```
      <MOD name="showtime" authstr="arris"/>
```

```
      <MOD name="sports" authstr="arris"/>
```

```
      <MOD name="vod" authstr="arris"/>
```

```
  </MDS>
```

```
  <PIDS eamIP="arriscmm" eamport="6100" pubIP="arriscmm"
  pubport="6101" threads="5" debug="true" pers="false" rti="10" >
```

```
    <CatalogServer IP="10.253.3.1" service="metpids" />
```

```
  </PIDS>
```

```
</Met>
```

Field Descriptions

The following table lists the field descriptions in the file used in Step 5.

Attribute	Description
Met::syslog	Facility to be used when logging syslog messages. This facility should be configured for the MET in the /etc/syslog.conf file with the following entry: local6.debug /var/log/metLog.
Met::MDS::pubIP	Arris publisher IP address or host name.
Met::MDS::pubport	Arris publisher port.
Met::MDS::BFS::ibsrcid	BFS in-band source ID.
Met::MDS::BFS::oobsrcid	BFS out-of-band source ID.
Met::MDS::threads	Number of transformation worker threads to be created.
Met::MDS::debug	Debug mode enabled (true) or disabled (false).
Met::MDS::mms	Maximum Merge Size - the maximum number of assets allowed in a merged database file.
Met::MDS::gzip	Compress all BFS files (true) or do not compress BFS files (false).
Met::MDS::cti	Complete Time Interval - time in seconds between MDS metadata modification checks when waiting on PublisherModInfoCompleteRequest messages.
Met::MDS::ctic	Complete Time Interval Count - when waiting on PublisherModInfoCompleteRequest messages, this is the number of CTI second intervals after which all modified MOD/ODA metadata should be merged and submitted to BFS.
Met::MDS::mti	Modified Time Interval - when in receipt of PublisherModInfoModificationRequest messages, this is the interval between MDS metadata modification checks as well as database file merge and submittal to BFS. If no metadata has changed, then file merging and submittal to BFS should not take place.
Met::MDS::MOD::name	MOD/ODA name to which the MDS must subscribe.
Met::MDS::MOD::authstr	Authorization string to be used when registering to subscribe to the specified MOD/ODA.
Met::PIDS::eamIP	Arris Entitlement and Account Manager (EAM) IP address or host name.
Met::PIDS::eamport	Arris EAM port.
Met::PIDS::threads	Number of client connection threads to be created.

Configure the MET Interfaces

Attribute	Description
Met::PIDS::debug	Debug mode enabled (true) or disabled (false).
Met::PIDS::pers	Maintain persistent Arris EAM connection (true) or not (false).
Met::PIDS::rti	EAM response timeout interval – Time in seconds for which the PIDS should wait for a response from the Arris EAM.
Met::PIDS::CatalogServer::IP	IP address of the PIDS server. This information will be sent to the client population via IB and OOB BFS.
Met::PIDS::CatalogServer::service	Service name to be found in the /etc/services file specifying the PIDS service port.
Met::MDS::allowEmptyCats	Allow Empty Categories (true) or disallow Empty Categories (false). Note: The system default is to not allow empty categories to show.

Configure svcadm for MET Program IDs

- 1 Type the following command and press **Enter** to become the **root** user:
`su - root`
- 2 Open the `/etc/services` file with a text editor.
- 3 Add the following line to the end of the file:
`metpids 34599/tcp metpids`
- 4 Save the file and close the editor.

Add Arris Servers to the /etc/hosts File

- 1 Open the /etc/hosts file with a text editor.
- 2 Add the cmm (management) and xms (VOD pump) IP addresses to the hosts file.

Example:

```
#ARRIS SERVERS  
192.0.2.0 arriscmm  
192.0.2.100 xms
```

- 3 Save the file and close the editor.

Restart the metasm Process and Verify the Files

- 1 As the **root** user, type the following command and press **Enter** to restart the metasm process:
svcadm restart metasm
- 2 Type the following command and press **Enter** to watch the process restart and publish:
tail -f /var/log/met.log
- 3 Type the following command and press **Enter** to switch to the dvs/dvsFiles/BFS/DNCS/vod file:
cd /dvs/dvsFiles/BFS/DNCS/vod
- 4 Type the following command and press **Enter** to verify that all files updated:
ls -la

Example: Output should be similar to the following example:

```
total 102
drwxr-xr-x  2 dnscs  dnscs  512 Feb  4 16:22 .
drwxr-xr-x 21 dnscs  dnscs  512 Feb  6 13:23 ..
-rwxr-x---  1 dnscs  dnscs   31 Jan 29 15:13 catalog-server.ib
-rwxr-x---  1 dnscs  dnscs   31 Jan 29 15:13 catalog-server.oob
-rwxr-x---  1 dnscs  dnscs  95 Feb  4 16:22 summary.ib
-rwxr-x---  1 dnscs  dnscs  95 Feb  4 16:22 summary.oob
-rwxr-x---  1 dnscs  dnscs 46080 Feb  4 16:22 VOD_Data_1.db.ib
```

- 5 Type the following command and press **Enter**:
cd /dvs/met/etc
- 6 Open the configODA.ini file with an editor and examine the file for UIDs.
Note: This is a file that is generated through the MDS. This file is generated upon successful login to the Arris publisher and the subsequent retrieval of metadata. The UIDs that appear in the file need to be added to the config.ini file.
Sample contents of configODA.ini file:
[vod]
names=vod,movies,hbo,cinemax,showtime,sports,eventsandspecials
uids=10127,10128,10129,10130,10440,10446,10449

Edit the config.ini File

- 1 On the DNCS, change directories to msoconfig.
- 2 Type **ls** and press **Enter** to confirm the presence of the rtn directory.
Expected output:
`dns rtn`
- 3 Type the following command and press **Enter**:
`cd rtn`
- 4 Type **ls** and press **Enter** to examine the contents of the rtn directory.
Expected output:
`0 1`
- 5 Type the following command and press **Enter**:
`cd 0`
- 6 Type **ls** and press **Enter** to examine the contents of the rtn directory.
Expected output:
`config.ini globalconfig.txt stagingdefaults.txt`
- 7 Open the config.ini file with a text editor.
- 8 Examine the contents of the file. The items marked in bold will need to be added for Arris and Vantage Version 3.3.

```
#  
# This is an example of the config.ini file, AKA non user unified settings  
#  
# Each variable below  
#  
# CA entries  
#  
[cam]  
# cisco_ca=0  
cisco_ca=1  
widevine=0  
cablecard_host=1  
# widevine=1  
# clear=0  
clear=1  
default=cablecard_host  
recording_mode=cisco_ca  
# recording_mode=clear  
# recording_mode=same_as_live  
[cisco_ca]  
entitlements=powerkey  
# entitlements=softcas
```

```

#
# startup entries
#
# reboot? by default do NOT reboot
# uncommenting either value will cause the STB to obey that setting
[reboot]
# disable=0
# disable=1
# time is hour of the day, 0-23, e.g. 3 = 3:00 AM
# time only makes sense if reboot is ENABLED
# time=3
#
#
#
#
[moca]
enable_moca_by_service=1
moca_service_name=_MRDV

#Any change to this section would reboot the system

[vod]
uids=10128,10127,10129,10130,10440,10446,10449
samids=12,13,14,15,16,17,18
types=VOD,VOD,SVOD,SVOD,SVOD,VOD,VOD

#types=VOD,sVOD,Svod,SVOD,SvoD,svod,svOd,svod,SVoD,vod,SvoD
posterartpath=/bfs/rtnclient/posterart
#names=Rogers-On-Demand,Anime-Network-OnDemand,NFL-Network-On-
Demand,OMNI-Plus-On-Demand,Citytv-On-Demand,WWE-On-Demand,HBO-
Canada-On-Demand,GLOBAL-On-Demand,Treehouse-On-Demand,MPIX-On-
Demand,HGTV On Demand
#contextIds=25601,25632,25605,25625,25606,25607,25608,25618,25619,25624,25623
,25622,25603
#SamIds=329,349,366,367,368,369,370,379,380,371,372,373,381
#dcns=598,590,591,600,592,593,595,806,805,599,597,596,594
#eids=233,4,17,51,17,17,17,233,233,57,61,107,233
#eids=233,7,107,61,57,51,4
#assetGenericFieldId=1
#assetGenericId=1
#folderGenericFieldId=2
#folderGenericId=2

```

Edit the config.ini File

```
#nightly_bfs_trigger=3  
#nightly_clear_trigger=5
```

```
#
```

Add the Subscription VOD Package

Add the Subscription VOD package.

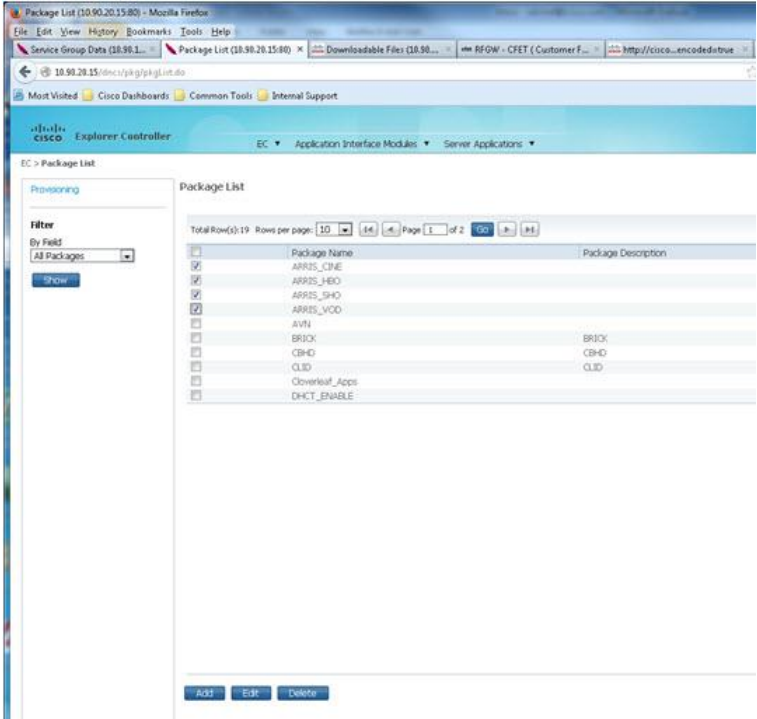

For More Information

If you have additional technical questions, call Cisco Services at 770 236-2200 or 866 787-3866 for assistance. Follow the menu options to speak with a service engineer.



Americas Headquarters

Cisco Systems, Inc.
170 West Tasman Drive
San Jose, CA 95134-1706
USA

<http://www.cisco.com>

Tel: 408 526-4000

800 553-6387

Fax: 408 527-0883

Cisco and the Cisco logo are trademarks or registered trademarks of Cisco and/or its affiliates in the U.S. and other countries. To view a list of Cisco trademarks, go to this URL:

www.cisco.com/go/trademarks.

Third party trademarks mentioned are the property of their respective owners.

The use of the word partner does not imply a partnership relationship between Cisco and any other company. (1110R)

Product and service availability are subject to change without notice.

© 2014 Cisco and/or its affiliates. All rights reserved.

September 2014

Part Number

TP-00091-01