

## Model 6942 Four Port Optoelectronic Node 870 MHz with 65/86 MHz Split

### Description

The Model 6942 Node is a high performance, four output optoelectronic node. The Model 6942 Node can be configured with a variety of forward optical receivers and reverse optical transmitters, providing flexibility for use in multiple applications. Redundant optical receiver and transmitter capability allows optical path redundancy, enabling increased network reliability.

The Model 6942 Node's reverse path is very flexible. Reverse traffic can be combined and routed to FP or DFB reverse transmitters, and redundant (back-up) transmitters may also be utilized. The platform provides for reverse segmentation through the addition of transmitters and reverse routers. Up to four transmitters - one per reverse input port - can be configured using the eight-position optical interface board. Where fiber counts are limited, the six-position optical interface board also allows use of advanced Baseband Digital Reverse, reverse path segmentation technology using Scientific-Atlanta's bdr™ system. The six-position optical interface board has two transmitter mounting positions. If the reverse path is not segmented, one position is used for the primary reverse transmitter and the other for an optional redundant transmitter. For dual reverse segmentation, two transmitters are installed, each dedicated to reverse traffic from a pair of station reverse input ports.



The Model 6942 Node can also be configured with a Scientific-Atlanta status monitoring transponder. The transponder, in conjunction with the Transmission Network Control System (TNCS), or other compatible element management system, enables remote monitoring of critical node related parameters, and remote control of each optional reverse path switch for ingress troubleshooting.

### Features

- 1 GHz RF platform
- 15 amperes continuous power passing
- Four high level forward RF outputs
- Screwless seizures for ease of connector installation
- 40-90 V AC high-efficiency switch mode power supply
- Optional power supply redundancy
- Local test points and LED indicators on optical receivers and transmitters simplify installation and maintenance
- Optional status monitoring and control (status monitoring transponder and TNCS or other compatible element management system required)
- Plug-in pads provide individual level control for each port for forward and reverse paths
- Optional 3-state reverse switch (on/off/-6 dB) allows each reverse input to be isolated for noise and ingress troubleshooting (status monitoring transponder and TNCS required)
- Fiber management tray provides convenient fiber and connector storage for up to 6 connector pairs
- 1310 nm analog reverse transmitters with either Fabry-Perot or DFB lasers
- 1550 nm analog reverse DFB transmitter
- Supports Baseband Digital Reverse technology, allowing reverse path segmentation
- Upgradeable to Model 6944 launch amplifier to enable full forward segmentation

# Model 6942 Four Port Optoelectronic Node – 5-65/86-870 MHz



## Model 6942 with Dual Reverse Segmentation

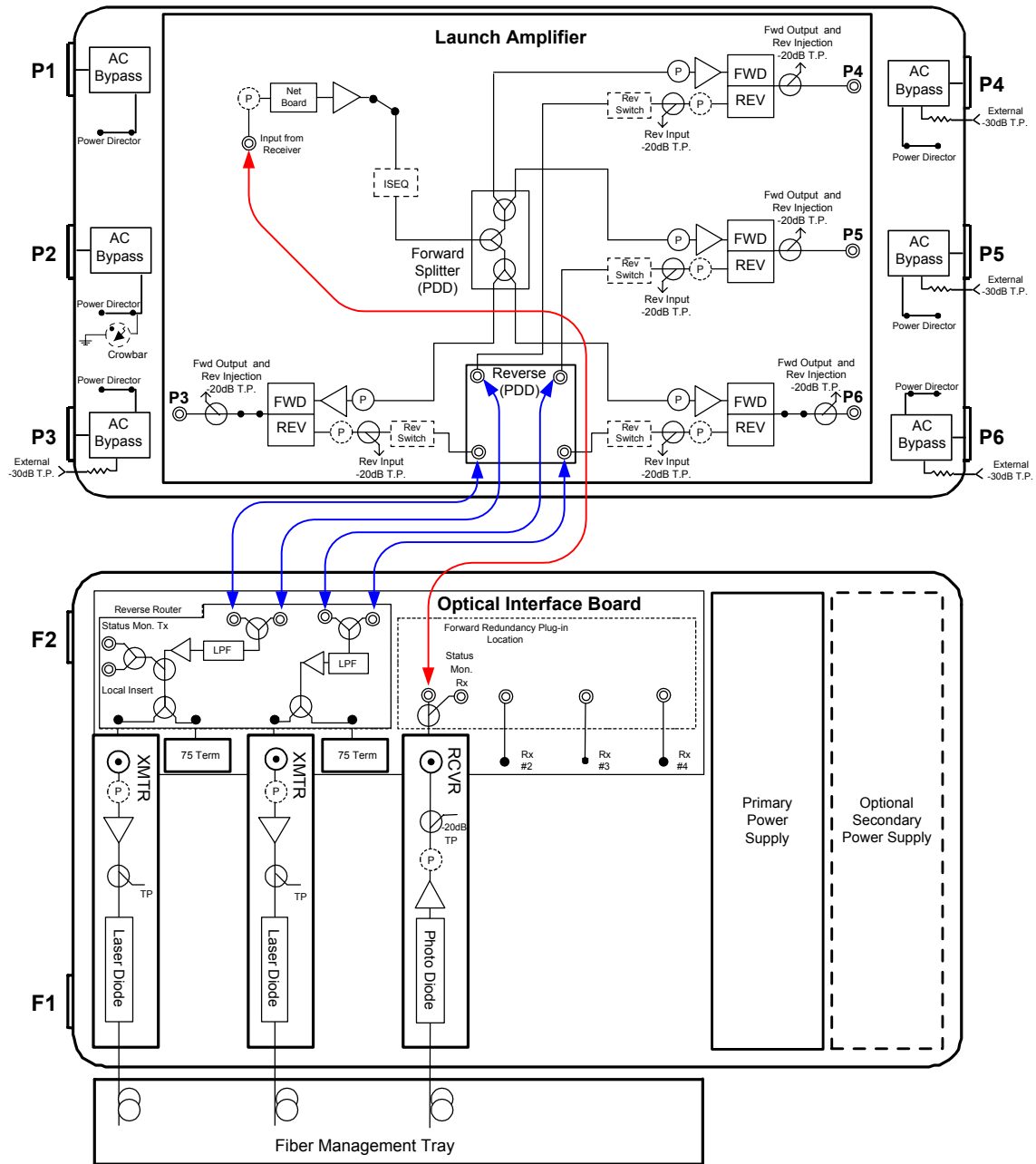

## Six Position Optical Interface Board with Forward and Reverse Plug-In Modules

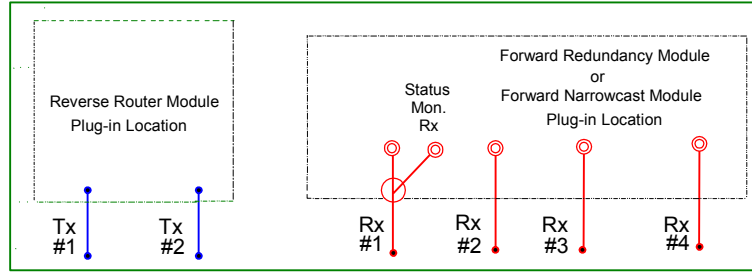

p/n 591129  
6 Position Optical Interface Board for 6944 (installed in housing lid)

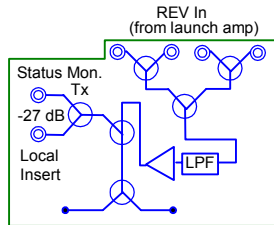

p/n 591162  
Standard (1X) Reverse Router Module  
(Two Wide) 5-65 MHz  
(used when reverse segmentation is not needed,  
allows redundancy)

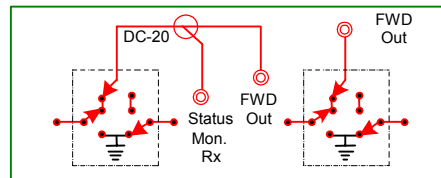

p/n 591148  
Forward Redundancy Module  
(used for redundancy with either dual or no segmentation)

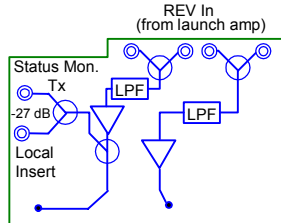

p/n 591165  
Dual Segmentation (2X) Reverse Router Module  
(Two Wide) 5-65 MHz  
(no redundancy)

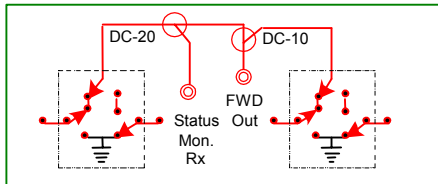

p/n 591150  
Forward Narrowcast (Tiering) Module  
(used for combining broadcast and narrowcast RX outputs,  
allows redundancy)

## *Eight Position Optical Interface Board with Forward and Reverse Plug-in Modules*

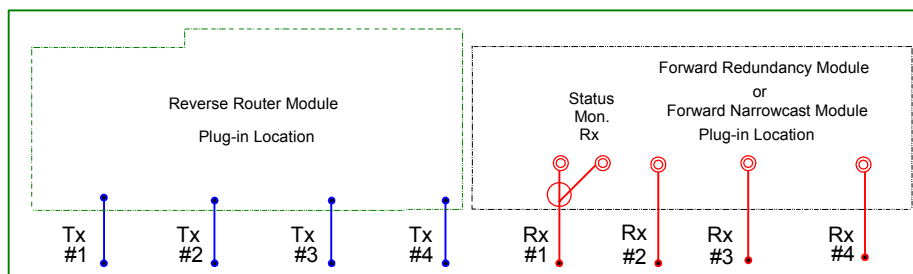

p/n 590946  
8 Position Optical Interface Board for 6944 (Installed in housing lid)

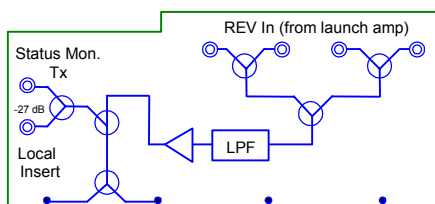

p/n 591153  
Standard (1X) Reverse Router Module  
(Four Wide) 5-65 MHz  
(used when reverse segmentation is not needed,  
allows redundancy)

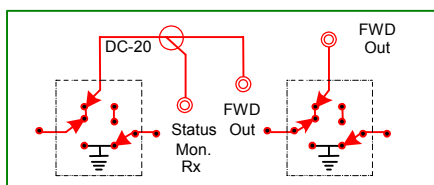

p/n 591148  
Forward Redundancy Module  
(used for redundancy with either dual or no segmentation)

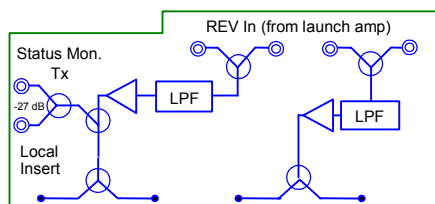

p/n 591156  
Dual Segmentation (2X) Reverse Router Module  
(Four Wide), 5-65 MHz  
(allows redundancy)

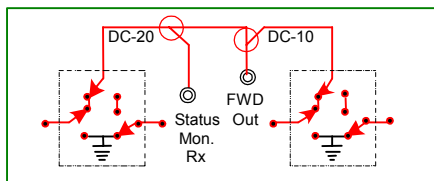

p/n 591150  
Forward Narrowcast (Tiering) Module  
(used for combining broadcast and narrowcast RX outputs,  
allows redundancy)

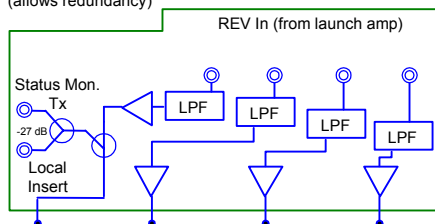

p/n 591159  
Quad Segmentation (4X) Reverse Router Module  
(Four Wide) 5-65 MHz  
(no redundancy)

## Optical Section Specifications

Optical Section Forward Receiver (RX) Module	Units	Standard RX	High Gain RX	Notes
Wavelength	nm	1310 and 1550	1310 and 1550	
Optical Input Range	dBm	-3.0 to +2.0	-3.0 to +1.0	
Pass Band	MHz	52-870	52-870	
Frequency Response	dB	± 0.75	± 0.75	1
Tilt (±1.5 dB)	dB	0	0	
Optical Input Test Point (± 20 %)	V DC	1V / mW	1V / mW	2
RF Output Test Point (± 1.0 dB)	dB	- 20	- 20	
RF Output Level	dBmV	See Chart Below	See Chart Below	3

### Receiver RF Output Level Vs Transmitter OMI

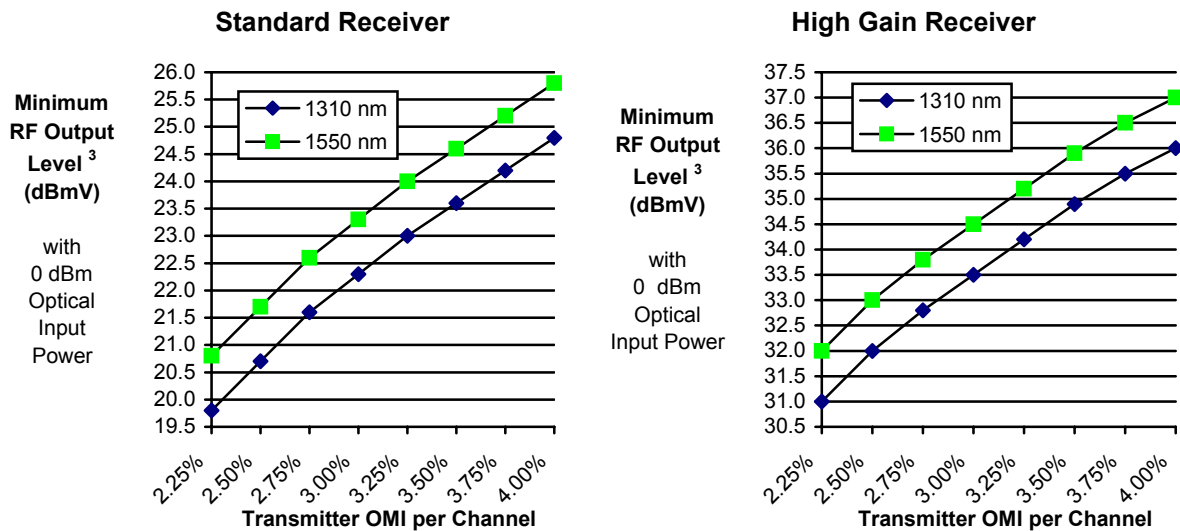

#### Notes for Optical Section Specifications:

1. For forward receiver module only. Does not include frequency response contributions from forward optical transmitter.
2. Referenced to optical input power in milliwatts at 1310 nm.
3. Minimum receiver RF output level for the stated transmitter percent Optical Modulation Index (OMI) per channel, with receiver optical input power of 0 dBm. To determine RF output levels at other optical input power, add (or subtract) 2 dB in RF level for each 1 dB increase (or decrease) in receiver optical input power.

For reverse optical transmitter and link performance, see the “Analog Reverse Optical Transmitters for Model 6940/6944 and GainMaker® Optoelectronic Stations” data sheet or the “Model 6940/44 bdr Digital Reverse” data sheet(s).

Unless otherwise noted, the above specifications reflect typical station performance at stated reference levels in the recommended operating configuration(s). Unless otherwise noted, specifications are based on measurements made in accordance with NCTA Recommended Practices for Measurements on Cable Television Systems using standard frequency assignments and are referenced to 68°F (20°C).

# Model 6942 Four Port Optoelectronic Node – 5-65/86-870 MHz



## RF Section Specifications

General Station Performance	Units	Forward	Reverse	Notes
Passband	MHz	86-870	5-65	
Amplifier Type	- -	PHD	Push-Pull	
Return Loss	dB	16	16	
Hum Modulation @ 12A	dB	65	65	
Hum Modulation @ 15A	dB	65 (86-750 MHz)	65	
	dB	60 (751-870 MHz)		
Internal RF Test Points ( $\pm 1$ dB)	dB	-20	-20	
External RF Test Points ( $\pm 1.5$ dB)	dB	-30	-30	

Launch Amplifier Performance - Forward	Units	Forward	Notes
Operational Gain (minimum)	dB	26	4
Frequency Response	dB	$\pm 0.5$	
Internal Tilt ( $\pm 1.0$ dB)	dB	9.5	1,3
Noise Figure @...	dB		2
	870 MHz	11	
	750 MHz	11.5	
	650 MHz	12.5	
	550 MHz	13.5	
	86 MHz	18.5	
Reference Output Levels @...	dBmV		
	870 MHz	47.5	
	750 MHz	45.7	
	650 MHz	44	
	550 MHz	42.5	
	86 MHz	35.5	
Reference Output Tilt (86-870 MHz)	dB	12	1,5
<b>64 PAL B/G Channels (CW) with digital</b>			12
Composite Triple Beat	dB	75	6
Cross Modulation	dB	72	6
Composite Second Order (high side)	dB	71	6
<b>64 PAL I Channels (CW) with digital</b>			13
Composite Beat	dB	70	6
Cross Modulation	dB	72	6
<b>42 CENELEC Channels (CW)</b>			14
Composite Triple Beat	dBuV	111	
Cross Modulation	dBuV	112	
Composite Second Order	dBuV	115	
<b>78 NTSC Channels (CW) with digital</b>			11
Composite Triple Beat	dB	73	6
Cross Modulation	dB	72	6
Composite Second Order (high side)	dB	73	6

Unless otherwise noted, the above specifications reflect typical station performance at stated reference levels in the recommended operating configuration(s). Unless otherwise noted, specifications are based on measurements made in accordance with NCTA Recommended Practices for Measurements on Cable Television Systems using standard frequency assignments and are referenced to 68°F (20°C).

# Model 6942 Four Port Optoelectronic Node – 5-65/86-870 MHz



## RF Section Specifications, continued

Forward Insertion Loss Optical Interface Board and Plug-Ins (Loss from specified optical receiver RF output to launch amplifier RF input)	Units	with no Module Installed	with Redundancy Module Installed	with Narrowcast Module Installed	Notes
Receiver position 1	dB	-1.0	-1.5	-2.5	10
Receiver position 2	dB	0	-1.5	-2.5	10

### Notes for RF Section Specifications:

1. Reference output tilt and internal tilt are both "Linear" tilt.
2. Launch amplifier forward noise figure with 1 dB input pad and 0 dB interstage equalizer (ISEQ).
3. Forward internal tilt specified with factory installed 0 dB ISEQ.
4. Launch amplifier forward gain from RF input to station output port, with 1 dB input pad and 0 dB ISEQ. The 1 dB input pad simulates the loss of an ISEQ with value greater than 0 dB, which is typically field installed to achieve desired output tilt.
5. The forward reference output tilt specified is achieved via the field installation of appropriate ISEQ, in conjunction with the internal tilt of the launch amplifier and the tilt associated with the optical link (transmitter/receiver combination).
6. Station performance can be determined by combining optic performance and launch amplifier performance. Stated distortion performance is for launch amplifier section operated at reference output levels and tilt.
7. Loaded with 78 NTSC carriers from 91 – 550 MHz. "Digital" refers to 550 - 870 MHz loading with 52 QAM carriers at -6 dB relative to analog video carrier levels.
8. Loaded with 64 PAL B/G carriers from 112 – 600 MHz. "Digital" refers to 600 - 870 MHz loading with 45 QAM carriers at -6 dB relative to analog video carrier levels.
9. Loaded with 64 PAL I carriers from 88 – 600 MHz. "Digital" refers to 600 - 870 MHz loading with 45 QAM carriers at -6 dB relative to analog video carrier levels.
10. Insertion loss from optical receiver RF output to launch amplifier RF input, with specified forward plug-in module installed in the optical interface board. Subtract this loss from the launch amplifier operational gain to determine forward station gain from optical receiver output to station output.
11. Tested per CENELEC Standard EN50083-3. RF output level associated with -60 dBc distortion is specified.

Unless otherwise noted, the above specifications reflect typical station performance at stated reference levels in the recommended operating configuration(s). Unless otherwise noted, specifications are based on measurements made in accordance with NCTA Recommended Practices for Measurements on Cable Television Systems using standard frequency assignments and are referenced to 68°F (20°C).

# Model 6942 Four Port Optoelectronic Node – 5-65/86-870 MHz



## RF Section Specifications, continued

Launch Amplifier Performance - Reverse	Units	Reverse	Notes
Frequency Response	dB	+/- 0.5	4
Internal Tilt (+/- 1 dB)	dB	0	4
Insertion Loss	dB	- 3.0	1,4

Station Performance - Reverse (Station port input to optical transmitter input)	Units	With no segmentation	With Dual segmentation	With Quad segmentation	Notes
Amplifier Type	--	PP	PP	na	
Path to Path Isolation	dB	na	> 50	> 50	5
Insertion Loss	dB	-3	-3	-3	2,4
Noise Figure	dB	14.5	14.5	14.5	3,4
<b>CENELEC Distortions</b>					11
Discrete Third Order	dBuV		110		
Discrete Second Order	dBuV		102		

Station Delay Characteristics			
Forward (Chrominance to Luminance Delay)		Reverse (Group Delay in 1.5 MHz BW)	
Frequency (MHz)	Delay (nS)	Frequency (MHz)	Delay (ns)
91.25 - 94.83	5	5.0 - 6.5	39
97.25 - 100.83	3	6.5 - 8.0	17
103.25 - 106.83	2	8.0 - 9.5	8
112.25 - 116.68	2	60.5 - 62.0	10
		62.0 - 63.5	12
		63.5 - 65.0	17

### Notes for this page:

1. Launch amplifier reverse insertion loss from station reverse input(s) to launch amplifier reverse output. Launch amplifier module has passive loss only in the reverse path (no gain stage).
2. Station reverse insertion loss from station reverse input(s) to the RF input of the optical transmitter (RF output of the specified reverse plug-in module).
3. Reverse noise figure at station input, with specified degree of reverse segmentation (appropriate reverse plug-in module installed in optical interface board) and 0 dB reverse input pad in launch amplifier.
4. All reverse specifications are with reverse switch installed.
5. Reverse path-to-path isolation is specified as the isolation between any two reverse paths that are configured as separate segmentation paths. This is the minimum loss that a reverse signal present at the input of any optical transmitter will incur if measured at an alternate (undriven) transmitter input.

Unless otherwise noted, the above specifications reflect typical station performance at stated reference levels in the recommended operating configuration(s). Unless otherwise noted, specifications are based on measurements made in accordance with NCTA Recommended Practices for Measurements on Cable Television Systems using standard frequency assignments and are referenced to 68°F (20°C).



# Model 6942 Four Port Optoelectronic Node – 5-65/86-870 MHz



## Specifications

Electrical	Units				Notes
Max. AC Through Current (continuous)	Amps	15			
Max. AC Through Current (surge)	Amps	25			
<b>Component DC Power Consumption (typical)</b>		<b>@ +24 VDC</b>	<b>@ +15 VDC</b>	<b>@ -6 VDC</b>	<b>1</b>
Launch Amplifier with 5 PHD hybrids	Amps	2.1	-	-	
Standard (1X) Reverse Router Module	Amps	-	0.07	-	
Dual Segmentation (2X) Reverse Router Module	Amps	-	0.13	-	
Quad Segmentation (4X) Reverse Router Module	Amps		0.25		
Forward Redundancy Module	Amps	0.04			
Forward Narrowcast Module	Amps	0.04			
Status Monitoring Transponder	Amps	0.15	-	-	
Standard Optical Receiver	Amps	0.25	0.01	0.035	
High Gain Optical Receiver	Amps	0.35	0.01	0.035	
6940/44 Reverse Transmitter - High Gain FP	Amps	0.09	-	0.07	
6940/44 Reverse Transmitter - High Gain DFB	Amps	0.09	-	0.09	
6940/44 Reverse Switch	Amps	0.02	-	-	
Power Supply DC Current Rating	Amps	4.5	0.5	1.5	1
Power Supply Operating Efficiency	%	85			
AC Input Low Voltage Cutoff	V AC	33			
Minimum Restart Voltage	V AC	41			

Station Powering Data													
6942 Station	I <sub>DC</sub> (Amps at 24 V DC)		AC Voltage										
			90	85	80	75	70	65	60	55	50	45	41
1x2 Configuration (1 Std Receiver & 2 DFB or FP Transmitter)	2.68	AC Current (A)	1.2	1.2	1.2	1.2	1.2	1.3	1.5	1.5	1.7	1.8	2.1
		Power (W)	78	78	78	77	77	77	77	77	77	78	78

Data is based on stations configured for 2-way operation with status monitoring transponder. AC currents specified are based on measurements made with typical CATV type ferro-resonant AC power supply (quasi-square wave), and standard version DC power supply (pn 590902).

**Note:**

- The total DC power consumption of installed components should not exceed the power supply DC current rating.

Environmental	Units	
Operating Temperature Range	degrees	-40°F to 140°F (-40°C to 60°C)
Relative Humidity Range	percent	5 to 95
Mechanical		
Housing Dimensions	Weight	
20.2 in. L x 10.8 in. H x 10.8 in. D (51.3 cm L x 27.4 cm H x 27.4 cm D)	Station with 2 RX, 2 TX, 2 power supplies:	39 lbs (17.7 kg)
	Station with 4 RX, 4 TX, 2 power supplies:	42 lbs (19.1 kg)

Unless otherwise noted, the above specifications reflect typical station performance at stated reference levels in the recommended operating configuration(s). Unless otherwise noted, specifications are based on measurements made in accordance with NCTA Recommended Practices for Measurements on Cable Television Systems using standard frequency assignments and are referenced to 68°F (20°C).

# Model 6942 Four Port Optoelectronic Node – 5-65/86-870 MHz



## Ordering Information

The **Prisma® Node Ordering Matrix** provides ordering information for configured nodes. This page contains ordering information for required and optional accessories that may not be included as part of a configured node. Please consult with Sales or Access Networks Applications Engineering to determine the best configuration for your particular need.

The following **Required Accessories** must be ordered separately (not included via Prisma Node Ordering Matrix):

Required Accessories for Model 6940 Node	Part Number
Plug-in Pads (attenuators) <ul style="list-style-type: none"> <li>1 required per Forward Fiber Optic Receiver Output</li> <li>1 required per each Reverse RF Input used</li> <li>1 required per Reverse Fiber Optic Transmitter</li> </ul>	See Pad (attenuator) part number table
Plug-in Forward Equalizer - Available in 1.5 dB steps from 0 to 15 dB at 870 MHz <ul style="list-style-type: none"> <li>1 required</li> </ul>	See EQ/Inverse EQ part number table

The following **Optional Accessories** may be ordered separately:

Optical Transmitters, Receivers and Related Parts	Part Number		
Note: Transmitters and Receivers include coax cable for connection to launch amplifier			
6940/44 - Standard Optical Receiver with SC/APC connector	590922		
6940/44 - Standard Optical Receiver with SC/UPC connector	590923		
6940/44 - High Gain Optical Receiver with SC/APC connector *	590926		
6940/44 - High Gain Optical Receiver with SC/UPC connector *	590927		
6944 - 1310 nm FP Optical Transmitter - High Gain, with SC/APC connector	590942		
6944 - 1310 nm FP Optical Transmitter - High Gain, with SC/UPC connector	590943		
6944 - 1310 nm DFB Optical Transmitter - High Gain, with SC/APC connector	590938		
6944 - 1310 nm DFB Optical Transmitter - High Gain, with SC/UPC connector	590939		
6944 - 1550 nm DFB Optical Transmitter - High Gain, with SC/APC connector	4005119		
6944 - 1550 nm DFB Optical Transmitter - High Gain, with SC/UPC connector	4005121		
SC/APC (green) Bulkhead Mating Adaptor, (mounts in fiber handling tray), (qty 10)	4006328		
SC/UPC (blue) Bulkhead Mating Adaptor, (mounts in fiber handling tray), (qty 10)	4006329		
Plug-In Modules for 6942 Optical Interface Board	Use with Optical Interface Board:		
	6 Position pn 591129	8 Position pn 590946	
Std. Reverse Router Module (4 wide), 5-65 MHz	-	X	591153
Dual Segmentation (2X) Reverse Router Module (4 wide), 5-65 MHz	-	X	591156
Quad Segmentation (4X) Reverse Router Module(4 wide), 5-65 MHz	-	X	591159
Standard (1X) Reverse Router Module (2 wide), 5-65 MHz	X	-	591162
Dual Segmentation (2X) Reverse Router Module (2 wide), 5-65 MHz	X	-	591165
Forward Redundancy Module	X	X	591148
Forward Narrowcast Module	X	X	591150
Plug-In Modules for Launch Amplifier			
6940/44 – Reverse Switch (one may be ordered for each reverse input port or common path)	590956		
Related Equipment			
6940/44 – Standard DC Power Supply 40 - 90 V AC	590902		
6940/44 – Crowbar Surge Protector	736253		
Redundant Control Module - Required for redundant optical receiver operation when Status Monitoring Transponder is <i>not</i> used	741509		
Status Monitoring Transponder	See Transponder Data Sheet		
75 Ohm Transmitter Terminator (used when no TX in redundant slot)	591133		
75 Ohm SMB Terminator (for female SMB connector termination)	591134		
SMB to F Test Cable Assembly	590961		
6940/44 – RF Test Probe	562580		

\* Standard gain receiver is recommended.



## Ordering Information, continued

### Equalizers / Inverse Equalizers

870 MHz Linear Forward Equalizers	Part Number
0 dB (jumper)	717929
1.5 dB	590986
3.0 dB	590987
4.5 dB	590988
6.0 dB	590989
7.5 dB	590990
9.0 dB	590991
10.5 dB	590992
12.0 dB	590993
13.5 dB	590994
15.0 dB	590995
870 MHz Inverse Equalizers	Part Number
1.5 dB	590010
3.0 dB	591011
4.5 dB	591012
6.0 dB	591013
7.5 dB	591014
9.0 dB	591015
10.5 dB	591016

### Pads (attenuators)

Pad Value (dB)	Part Number	Pad Value (dB)	Part Number
0	279500	0.5	565231
1	279501	1.5	565232
2	279502	2.5	565233
3	279503	3.5	565234
4	279504	4.5	565235
5	279505	5.5	565236
6	279506	6.5	565237
7	279507	7.5	565238
8	279508	8.5	565239
9	279509	9.5	565240
10	279510	10.5	565241
11	279511	11.5	565242
12	279512	12.5	565243
13	279513	13.5	565244
14	504151	14.5	565245
15	504152	15.5	565246
16	504153	16.5	565247
17	504154	17.5	565248
18	504155	18.5	565249
19	504156	19.5	565250
20	504157	20.5	565251
75 ohm terminator	279524		



Scientific-Atlanta, the Scientific-Atlanta logo, Prisma, and GainMaker are registered trademarks of Scientific-Atlanta, Inc. ROSA is a trademark of Scientific-Atlanta Europe, NV. bdr is a trademark of Scientific-Atlanta, Inc. Specifications and product availability are subject to change without notice. © 2004 Scientific-Atlanta, Inc. All rights reserved.

Scientific-Atlanta, Inc.  
1-800-722-2009 or 770-236-6900  
www.scientificatlanta.com

Part Number 7005810 Rev A  
July 2004