

Cisco UCS C245 M6 SFF Rack Server

A printed version of this document is only a copy and not necessarily the latest version. Refer to the following link for the latest released version:

<https://www.cisco.com/c/en/us/products/servers-unified-computing/ucs-c-series-rack-servers/datasheet-listing.html>



CONTENTS

OVERVIEW	5
DETAILED VIEWS	7
Chassis Front View	7
Chassis Rear View	8
BASE SERVER STANDARD CAPABILITIES and FEATURES	10
CONFIGURING the SERVER	13
STEP 1 VERIFY SERVER SKU	14
STEP 2 SELECT RISER CARDS (REQUIRED)	15
STEP 3 SELECT CPU(s)	16
STEP 4 SELECT MEMORY	19
STEP 5 SELECT DRIVE CONTROLLERS	24
Cisco M6 12G SAS RAID Controller	24
Cisco 12G SAS HBA	24
RAID Volumes and Groups	24
STEP 6 SELECT DRIVES	27
STEP 7 SELECT OPTION CARD(s)	31
STEP 8 ORDER OPTIONAL PCIe OPTION CARD ACCESSORIES	34
STEP 9 ORDER GPU CARDS (OPTIONAL)	37
STEP 10 ORDER POWER SUPPLY	40
STEP 11 SELECT INPUT POWER CORD(s)	42
STEP 12 ORDER TOOL-LESS RAIL KIT AND OPTIONAL REVERSIBLE CABLE MANAGEMENT ARM	46
STEP 13 SELECT MANAGEMENT CONFIGURATION (OPTIONAL)	47
STEP 14 ORDER SECURITY DEVICES (OPTIONAL)	48
STEP 15 SELECT LOCKING SECURITY BEZEL (OPTIONAL)	49
STEP 16 ORDER M.2 SATA SSDs (OPTIONAL)	50
STEP 17 SELECT OPERATING SYSTEM AND VALUE-ADDED SOFTWARE	52
STEP 18 SELECT OPERATING SYSTEM MEDIA KIT	56
STEP 19 SELECT SERVICE and SUPPORT LEVEL	57
Unified Computing Warranty, No Contract	57
Smart Net Total Care (SNTC) for Cisco UCS	57
Smart Net Total Care (SNTC) for Cisco UCS Onsite Troubleshooting Service	59
Solution Support (SSPT) for UCS	60
Solution Support for Service Providers	61
Smart Net Total Care for UCS Hardware Only Service	61
Partner Support Service for UCS	62
PSS for UCS Hardware Only	63
Distributor Support Service (DSS)	64
Unified Computing Combined Support Service	65
UCS Drive Retention Service	66
Local Language Technical Support for UCS	66
SUPPLEMENTAL MATERIAL	67
Chassis	67
Riser Connector Locations on the Motherboard	69
Riser Card Configurations and Options	71
Riser 1A	71
Riser 1B	72
Riser 2A	73
Riser 3A	74
Riser 3B	75

Riser 3C	76
Memory Support for AMD Rome and Milan CPUs	77
Block Diagram	78
Serial Port Details	79
KVM Cable	79
SPARE PARTS	80
REPLACING CPUs and HEATSINKS	94
UPGRADING or REPLACING MEMORY	95
DISCONTINUED EOL PRODUCTS	97
TECHNICAL SPECIFICATIONS	98
Dimensions and Weight	98
Power Specifications	100
Environmental Specifications	104
Extended Operating Temperature Hardware Configuration Limits	105
Compliance Requirements	106

CONTENTS

OVERVIEW

The UCS C245 M6 SFF server extends the capabilities of Cisco's Unified Computing System portfolio in a 2U form factor with the addition of the AMD CPUs, 16 DIMM slots per CPU for 3200-MHz DDR4 DIMMs with individual DIMM capacity points up to 256 GB. The maximum memory capacity for 2 CPUs is 8 TB (for 32 x 256 GB DDR4 DIMMs). The C245 M6 SFF server has:

- Up to 24 front SFF SAS/SATA HDDs or SSDs (optionally up to 4 of the drives can be NVMe)
- I/O-centric option provides up to 8 PCIe slots using three rear risers, or
- Storage-centric option provides three rear risers with a total of up to 4 NVMe SFF drives and 3 PCIe slots

The server provides internal slots for the following:

- One Cisco 12G SAS RAID controllers with 4 GB cache backup to control SAS/SATA drives, or
- Cisco 12G SAS HBAs to control SAS/SATA drives.



NOTE: PCIe drives are controlled directly from the CPUs.

The UCS C245 M6 server has a single 1 GbE management port. A modular LAN on motherboard (mLOM)/OCP 3.0 module provides up to two 100 GbE ports. A connector on the front of the chassis provides KVM functionality.

The Cisco UCS C245 M6 server can be used standalone, or as part of the Cisco Unified Computing System, which unifies computing, networking, management, virtualization, and storage access into a single integrated architecture enabling end-to-end server visibility, management, and control in both bare metal and virtualized environments.

See [Figure 1 on page 6](#) for front and rear views of the UCS C245 M6 server.

Figure 1 Cisco UCS C245 M6 SFF Rack Server

24 Front drives are SAS/SATA and NVMe mix (up to 4 NVMe drives) and optionally 4 NVMe rear drives

Front View



Rear View (all slots shown unpopulated - see [Figure 3 on page 8](#) for details)

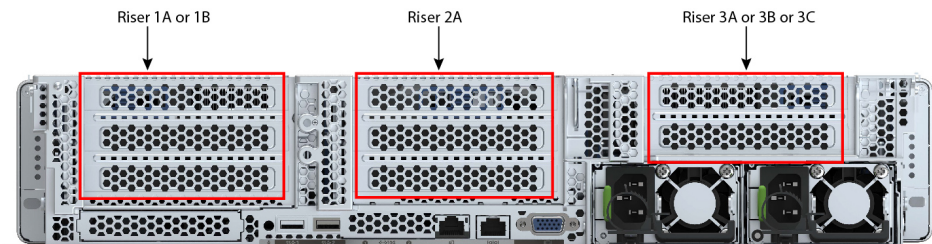

DETAILED VIEWS

Chassis Front View

Figure 2 shows the front View of the C245 M6 SFF Rack Server configured with 24 front drives. The drives can be a mix of SAS/SATA and NVMe (up to 4 NVMe drives) and optionally up to 4 NVMe rear drives.

Figure 2 Chassis Front View (UCSC-C245-M6SX)

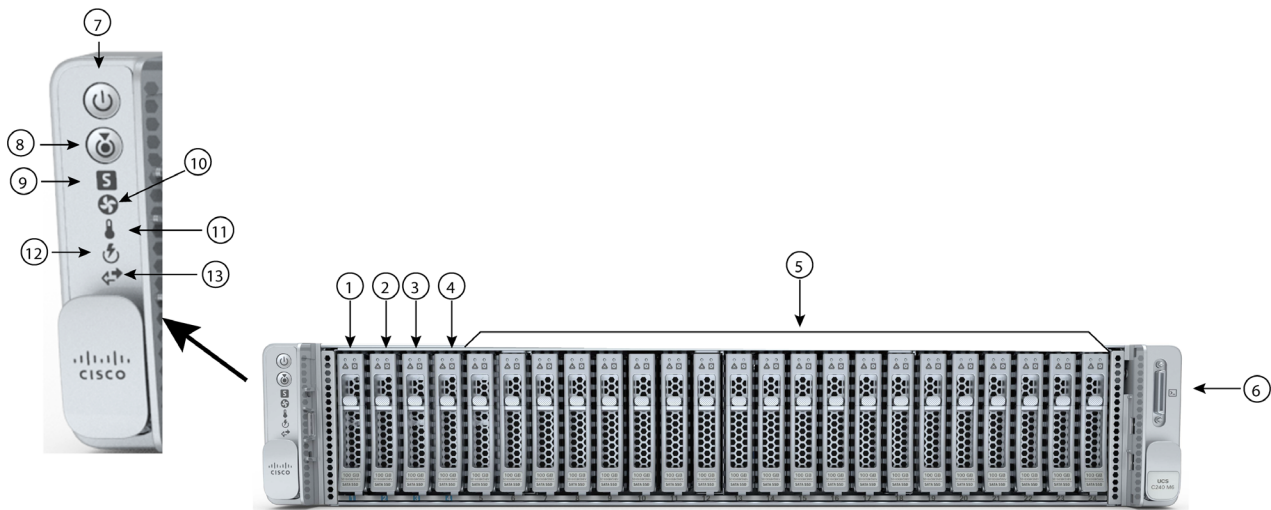

1 - 4	Drive bays 1 - 4 support SAS/SATA hard drives and solid state drives (SSDs) as well as NVMe PCIe drives ^{1, 2} .	9	System status LED
5	Drive bays 5 - 24 support SAS/SATA hard drives and solid state drives (SSDs) only	10	Fan status LED
6	KVM connector (used with KVM cable that provides two USB 2.0, one VGA, and one serial connector)	11	Temperature status LED
7	Power button/Power status LED	12	Power supply status LED
8	Unit Identification button/LED	13	Network link activity LED

Notes:

1. If front NVMe drives are selected, you must also select 2 CPUs.
2. You can mix and match in drive bays 1 - 4. For example, slots 1 and 2 can hold NVMe drives and slots 3 and 4 can hold SAS/SATA HDDs or SSDs.

Chassis Rear View

Figure 3 shows the external features of the rear panel.

Figure 3 Chassis Rear View (UCSC-C245-M6SX)

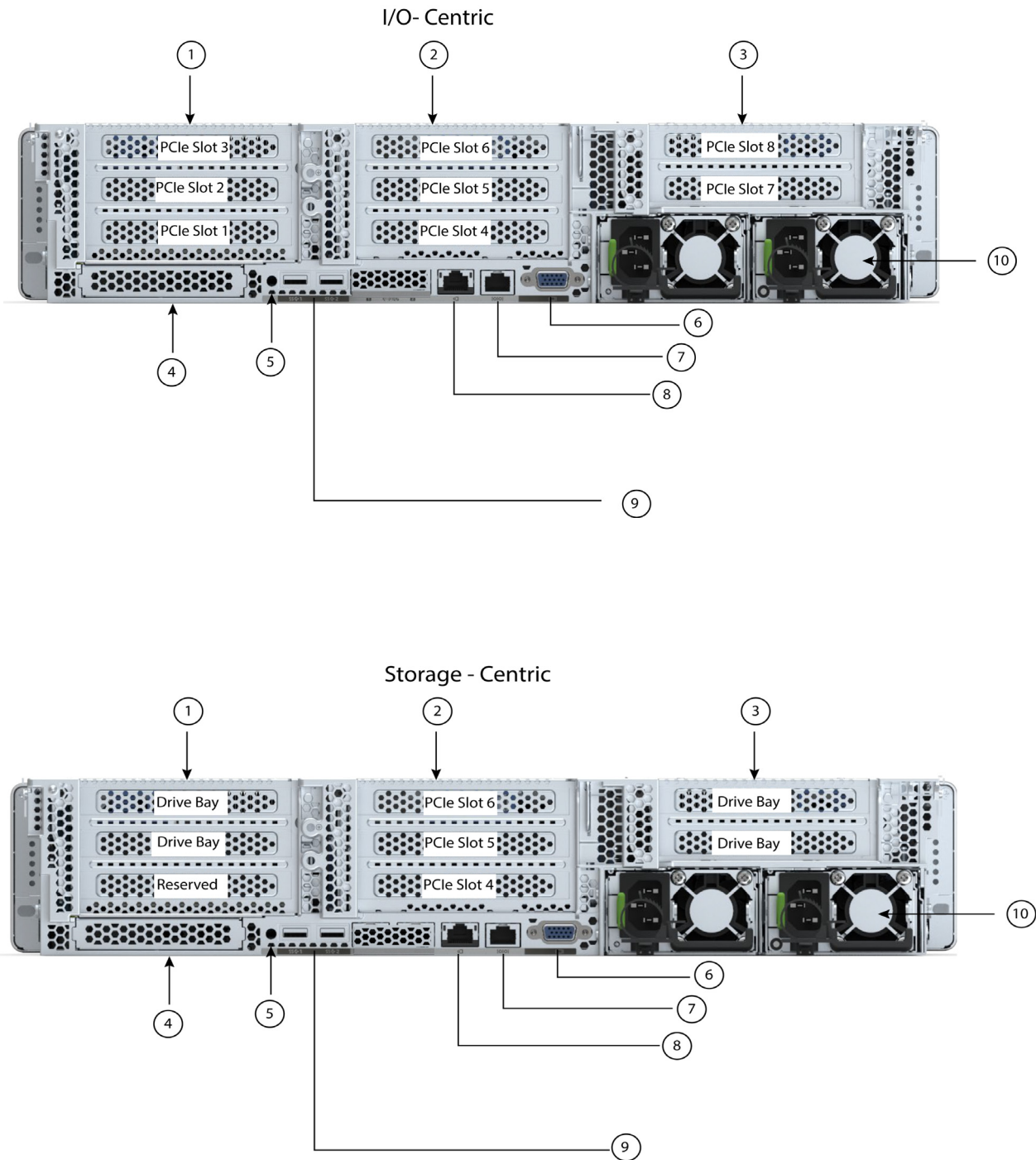

1	<p>There are two Riser 1 options:</p> <p>Riser 1A (I/O-centric, CPU1 control)</p> <p>Supports three PCIe slots:</p> <ul style="list-style-type: none"> ■ Slot 1 is full-height, 3/4 length, x8, NCSI ■ Slot 2 is full-height, full-length, x16, NCSI ■ Slot 3 is full-height, full-length, x8, no NCSI <p>Riser 1B (storage-centric, CPU1 control)</p> <ul style="list-style-type: none"> ■ Supports two SFF NVMe drives <ul style="list-style-type: none"> • Drive bay 102 (lower bay), x4 • Drive bay 101 (upper bay), x4 <p>See Riser Card Configurations and Options, page 70 for mechanical details.</p>	6	VGA display port (DB15 connector)
2	<p>Riser 2A (always I/O-centric, CPU2 control)</p> <p>Supports three PCIe slots:</p> <ul style="list-style-type: none"> ■ Slot 4 is full-height, 3/4 length, x8, NCSI ■ Slot 5 is full-height, full-length, x16, NCSI ■ Slot 6 is full-height, full length, x8, no NCSI 	7	COM port (RJ45 connector)
3	<p>There are three Riser 3 options</p> <p>Riser 3A (I/O-centric, CPU2 control)</p> <ul style="list-style-type: none"> ■ Supports two PCIe slots: <ul style="list-style-type: none"> • Slot 7 is full-height, full-length, x8, no NCSI • Slot 8 is full-height, full-length, x8, no NCSI <p>Riser 3B (storage-centric, CPU2 control)</p> <ul style="list-style-type: none"> ■ Supports two SFF NVMe drives <ul style="list-style-type: none"> • Drive bay 104 (lower bay), x4 • Drive bay 103 (upper bay), x4 <p>Riser 3C</p> <ul style="list-style-type: none"> ■ Supports one full-height, full-length, double-wide GPU (PCIe slot 7 only), x16 ■ Slot 8 is blocked by double-wide GPU <p>See Riser Card Configurations and Options, page 70 for details.</p>	8	1 GbE dedicated Ethernet management port
4	Modular LAN-on-motherboard (mLOM)/OCP 3.0 card slot (x16)	9	USB 3.0 ports (two)
5	System ID pushbutton/LED	10	Power supplies (two)



NOTE: For GPU support on a particular riser slot, see [Table 4 on page 15](#)

BASE SERVER STANDARD CAPABILITIES and FEATURES

Table 1 lists the capabilities and features of the base server. Details about how to configure the server for a particular feature or capability (for example, number of processors, disk drives, or amount of memory) are provided in *CONFIGURING the SERVER, page 13*.

Table 1 Capabilities and Features

Capability/Feature	Description
Chassis	Two rack unit (2RU) chassis
CPU	One or two AMD Milan or Rome Processors
Memory	32 slots for registered DIMMs (RDIMMs) or load-reduced DIMMs (LRDIMMs)
Multi-bit Error Protection	This server supports multi-bit error protection.
Video	<p>The Cisco Integrated Management Controller (CIMC) provides video using the Matrox G200e video/graphics controller:</p> <ul style="list-style-type: none"> ■ Integrated 2D graphics core with hardware acceleration ■ Embedded DDR memory interface supports up to 512 MB of addressable memory (8 MB is allocated by default to video memory) ■ Supports display resolutions up to 1920 x 1200 16bpp @ 60Hz ■ High-speed integrated 24-bit RAMDAC ■ Single lane PCI-Express host interface running at Gen 1 speed
Power subsystem	<p>Up to two of the following hot-swappable power supplies:</p> <ul style="list-style-type: none"> ■ 1050 W (AC) ■ 1050 W (DC) ■ 1600 W (AC) ■ 2300 W (AC) <p>One power supply is mandatory; one more can be added for 1 + 1 redundancy.</p>
Front Panel	A front panel controller provides status indications and control buttons.
ACPI	<p>This server supports the advanced configuration and power interface (ACPI)</p> <p>Rome - ACPI version 6.2 Milan - ACPI version 6.3</p>
Fans	Six hot-swappable fans for front-to-rear cooling
Infiniband	The InfiniBand architecture is supported by the PCIe slots.
Expansion slots	<ul style="list-style-type: none"> ■ Riser 1A (3 PCIe slots) ■ Riser 1B (2 drive bays) ■ Riser 2A (3 PCIe slots) ■ Riser 3A (2 PCIe slots) ■ Riser 3B (2 drive bays) ■ Riser 3C (1 PCIe slot) ■ Dedicated slots for a Cisco 12G SAS RAID controller or Cisco 12G SAS HBA. <p>For more details on the variations of riser 1, riser 2, and riser 3, see <i>Riser Card Configurations and Options, page 70</i>.</p>

Capability/ Feature	Description
Interfaces	<ul style="list-style-type: none"> ■ Rear panel <ul style="list-style-type: none"> • One 1Gbase-T RJ-45 management port • One RS-232 serial port (RJ45 connector) • One DB15 VGA connector • Two USB 3.0 port connectors • One flexible modular LAN on motherboard (mLOM)/OCP 3.0 slot that can accommodate various interface cards. ■ Front panel <ul style="list-style-type: none"> • One KVM console connector (supplies two USB 2.0 connectors, one VGA DB15 video connector, and one serial port (RS232) RJ45 connector)
Internal storage devices	<ul style="list-style-type: none"> ■ Up to 24 front SFF SAS/SATA hard drives (HDDs) or SAS/SATA solid state drives (SSDs). ■ Optionally, up to four front SFF NVMe PCIe SSDs. These drives must be placed in front drive bays 1, 2, 3, and 4 only and are connected to CPU 2. The rest of the bays (5 - 24) can be populated with SAS/SATA SSDs or HDDs. ■ Optionally, up to four SFF rear-facing NVMe drives. <p>Other storage:</p> <ul style="list-style-type: none"> ■ A mini-storage module connector on the motherboard supports a boot-optimized RAID controller carrier that holds up to two SATA M.2 SSDs. Mixing different capacity SATA M.2 SSDs is not supported. ■ 8GB FlexMMC utility storage for staging of firmware and other user data. 8GB FlexMMC storage is built into the motherboard on M6
Integrated management processor	<p>Baseboard Management Controller (BMC) running Cisco Integrated Management Controller (CIMC) firmware.</p> <p>Depending on your CIMC settings, the CIMC can be accessed through the 1GE dedicated management port or a Cisco virtual interface card (VIC).</p> <p>CIMC manages certain components within the server, such as the Cisco 12G SAS HBA.</p>
Storage controllers	<p>One Cisco M6 12G SAS RAID controller or up to two Cisco 12G SAS HBAs plug into a dedicated slot.</p> <ul style="list-style-type: none"> ■ Cisco M6 12G SAS RAID Controller with 4GB FBWC <ul style="list-style-type: none"> • RAID support (RAID 0, 1, 5, 6, 10, 50, 60, SRAID0, and JBOD mode) • Supports up to 28 internal SAS/SATA drives • Plugs into a dedicated slot ■ Cisco 12G SAS HBA <ul style="list-style-type: none"> • No RAID support • JBOD/Pass-through Mode support • Supports up to 16 SAS/SATA internal drives • Plugs into a dedicated slot
Modular LAN on Motherboard (mLOM)/OCP ¹ 3.0 slot	<p>The dedicated mLOM/OCP 3.0 slot on the motherboard can flexibly accommodate the following cards:</p> <ul style="list-style-type: none"> ■ Cisco Virtual Interface Cards ■ OCP 3.0 network interface card (UCSC-O-ID10GC)

BASE SERVER STANDARD CAPABILITIES and FEATURES

Capability/ Feature	Description
Intersight	Intersight provides server management capabilities
CIMC	Cisco Integrated Management Controller 4.2(1) or later

Notes:

1. Open Compute Project

CONFIGURING the SERVER

Follow these steps to configure the Cisco UCS C245 M6 SFF Rack Server:

- *STEP 1 VERIFY SERVER SKU, page 14*
- *STEP 2 SELECT RISER CARDS (REQUIRED), page 15*
- *STEP 3 SELECT CPU(s), page 16*
- *STEP 4 SELECT MEMORY, page 19*
- *STEP 5 SELECT DRIVE CONTROLLERS, page 24*
- *STEP 6 SELECT DRIVES, page 27*
- *STEP 7 SELECT OPTION CARD(s), page 31*
- *STEP 8 ORDER OPTIONAL PCIe OPTION CARD ACCESSORIES, page 34*
- *STEP 9 ORDER GPU CARDS (OPTIONAL), page 37*
- *STEP 10 ORDER POWER SUPPLY, page 40*
- *STEP 11 SELECT INPUT POWER CORD(s), page 41*
- *STEP 12 ORDER TOOL-LESS RAIL KIT AND OPTIONAL REVERSIBLE CABLE MANAGEMENT ARM, page 45*
- *STEP 13 SELECT MANAGEMENT CONFIGURATION (OPTIONAL), page 46*
- *STEP 14 ORDER SECURITY DEVICES (OPTIONAL), page 47*
- *STEP 14 ORDER SECURITY DEVICES (OPTIONAL), page 47*
- *STEP 15 SELECT LOCKING SECURITY BEZEL (OPTIONAL), page 48*
- *STEP 16 ORDER M.2 SATA SSDs (OPTIONAL), page 49*
- *STEP 17 SELECT OPERATING SYSTEM AND VALUE-ADDED SOFTWARE, page 51*
- *STEP 18 SELECT OPERATING SYSTEM MEDIA KIT, page 55*
- *STEP 19 SELECT SERVICE and SUPPORT LEVEL, page 56*

STEP 1 VERIFY SERVER SKU

Top level ordering product ID (PID) is shown in [Table 2](#)

Table 2 Top level ordering PID (major line bundle)

Product ID (PID)	Description
UCS-M6-MLB	UCS M6 Rack, Blade, Chassis MLB This major line bundle (MLB) consists of the Rack Server (UCSC-C240-M6S, UCSC-C240-M6S, UCSC-C240-M6N, or UCSC-C240-M6SN) with software PIDs. Use this PID to begin a new configuration.

Select one server product ID (PID) from [Table 3](#).

Table 3 PID of the C245 M6 SFF Rack Base Server

Product ID (PID)	Description
UCSC-C245-M6SX ¹	Small form-factor (SFF) drives, with 24-drive backplane. <ul style="list-style-type: none"> ■ Front-loading drive bays 1–24 support 2.5-inch SAS/SATA drives. ■ Optionally, front-loading drive bays 1, 2, 3, and 4 support 2.5-inch NVMe SSDs. ■ Optionally up to 4 rear facing NVMe drives ■ No CPU, memory, drives, PCIe cards, or power supply included

Notes:

1. This product may not be purchased outside of the approved bundles (must be ordered under the MLB)

The Cisco UCS C245 M6 SFF server:

- Includes a 24-drive backplane
- Does not include power supply, CPU, memory DIMMs, hard disk drives (HDDs), solid-state drives (SSDs), NVMe drives, SD cards, riser 1, riser 2, riser 3, tool-less rail kit, or option cards.



NOTE: Use the steps on the following pages to configure the server with the components that you want to include.

STEP 2 SELECT RISER CARDS (REQUIRED)

Select risers from [Table 4](#).

Table 4 PIDs of the Risers

Product ID (PID)	Description
UCSC-RIS1A-240M6 (default riser)	C245 M6 Riser1A (controlled with CPU1) <ul style="list-style-type: none"> ■ PCIe slot 1 (bottom slot): full height, 3/4 length, x8, NCSI ■ PCIe slot 2 (middle slot): full height, full length (GPU Card), x16, NCSI ■ PCIe slot 3 (top slot): full height, full length, x8
UCSC-RIS1B-240M6 (storage riser)	C245 M6 Riser1B (controlled with CPU1) <ul style="list-style-type: none"> ■ Slot 1 (bottom slot) is reserved ■ Middle slot, 2.5" NVMe drive bay 102, x4 (controlled with CPU2) ■ Top slot, 2.5" NVMe drive bay 101, x4 (controlled with CPU2)
UCSC-RIS2A-240M6 (default riser)	C245 M6 Riser2A (controlled with CPU2) <ul style="list-style-type: none"> ■ PCIe slot 4 (bottom slot): full height, 3/4 length, x8, NCSI ■ PCIe slot 5 (middle slot): full height, full length (GPU Card), x16, NCSI ■ PCIe slot 6 (top slot): full height, full length, x8
UCSC-RIS3A-240M6 (default riser)	C245 M6 Riser3A (controlled with CPU2) <ul style="list-style-type: none"> ■ PCIe slot 7 (bottom slot): full height, full length, x8 ■ PCIe slot 8 (top slot): full height, full length, x8
UCSC-RIS3B-240M6 (storage riser)	C245 M6 Riser 3B (controlled with CPU2) <ul style="list-style-type: none"> ■ Bottom slot, 2.5" NVMe drive bay 104, x4 ■ Top slot, 2.5" NVMe drive bay 103, x4
UCSC-RIS3C-240M6 (GPU riser)	C240 M6 Riser 3C (controlled with CPU2) <ul style="list-style-type: none"> ■ Slot 7 supports one full-height, full-length, double-wide GPU (PCIe slot 7 only), x16 ■ Slot 8 blocked by double-wide GPU



NOTE:

- Riser filler blank UCSC-FBRS2-C240M6 for riser 2 and UCSC-FBRS3-C240M6 for riser 3 is auto included, if riser 2 or riser 3 are not selected.
- See for [SPARE PARTS, page 79](#) section for all the spare components and required other parts with it.
- For additional details on riser cards, see [Riser Card Configurations and Options, page 70](#)

STEP 3 SELECT CPU(s)

The standard CPU features are:

- AMD® Rome®, Milan®, and Milan-X® family CPUs
- CPU-to-CPU communication using Infinity Fabric Interconnect
- Cache size of up to 768 MB
- Up to 64 cores

Select CPUs

The available CPUs are listed in [Table 5](#)

Table 5 Available CPUs

Product ID (PID) ¹	Clock Freq (GHz)	Power (W)	L3 Cache Size (MB)	Cores	Highest DDR4 DIMM Clock Support (MHz) ²
Milan Processors					
UCS-CPU-A7763	2.45	280	256	64	3200
UCS-CPU-A7713	2.00	225	256	64	3200
UCS-CPU-A7713P	2.00	225	256	64	3200
UCS-CPU-A7663	2.00	225	256	56	3200
UCS-CPU-A7643	2.30	225	256	48	3200
UCS-CPU-A7543	2.80	225	256	32	3200
UCS-CPU-A7543P	2.80	225	256	32	3200
UCS-CPU-A7513	2.60	200	128	32	3200
UCS-CPU-A75F3	2.95	280	256	32	3200
UCS-CPU-A7413	2.65	180	128	24	3200
UCS-CPU-A7453	2.75	180	64	28	3200
UCS-CPU-A7443	2.85	200	128	24	3200
UCS-CPU-A7443P	2.85	200	128	24	3200
UCS-CPU-A74F3	3.20	240	256	24	3200
UCS-CPU-A7343	3.20	190	128	16	3200
UCS-CPU-A7313	3.00	155	128	16	3200
UCS-CPU-A7313P	3.00	155	128	16	3200
UCS-CPU-A73F3	3.50	240	256	16	3200
UCS-CPU-A72F3	3.70	180	256	8	3200
Milan-X Processors					
UCS-CPU-A7773X	2.20	280	768	64	3200
UCS-CPU-A7573X	2.80	280	768	32	3200
UCS-CPU-A7473X	2.80	240	768	24	3200
UCS-CPU-A7373X	3.05	240	768	16	3200

Table 5 Available CPUs

Product ID (PID) ¹	Clock Freq (GHz)	Power (W)	L3 Cache Size (MB)	Cores	Highest DDR4 DIMM Clock Support (MHz) ²
Rome Processors					
UCS-CPU-A7662	2.00	225	256	64	3200
UCS-CPU-A7532	2.40	200	256	32	3200
UCS-CPU-A7502P	2.50	180	128	32	3200
UCS-CPU-A7352	2.30	155	128	24	3200
UCS-CPU-A7302	3.00	155	128	16	3200
UCS-CPU-A7282	2.80	120	64	16	3200
UCS-CPU-A7272	2.90	120	64	12	3200
UCS-CPU-A7262	3.20	155	128	8	3200
UCS-CPU-A7252	3.10	120	64	8	3200
UCS-CPU-A7232P	3.10	120	32	8	3200

Notes:

1. Any CPU PID ending in “P” cannot be used in a 2-CPU system. They can only be used in a 1-CPU system
2. If higher or lower speed DIMMs are selected than what is shown in [Table 6 on page 19](#) for a given CPU speed, the DIMMs will be clocked at the lowest common denominator of CPU clock and DIMM clock.



CAUTION: For systems configured with processors operating above 28° C [82.4° F], a fan fault or executing workloads with extensive use of heavy instructions sets may assert thermal and/or performance faults with an associated event recorded in the System Event Log (SEL).

If an NVIDIA A10, or A100 GPU is installed, or rear HDDs are installed, the 28° C [82.4° F] restriction changes to 25° C [77° F]

Approved Configurations

(1) For the UCSC-C245-M6SX:

- For 1-CPU systems, select one CPU from [Table 5 on page 16](#). The server is shipped by default with riser 1 only
- For 2-CPU systems, select two identical CPUs from [Table 5 on page 16](#).



NOTE:

- You cannot have two CPUs ending in a “P” suffix in a two-CPU configuration.
 - If you configure a server with one CPU with a “P” suffix, you cannot later upgrade to a 2-CPU system with two of these CPUs.
-

Caveats

- The selection of 1 or 2 CPUs depends on the desired server functionality. See the following sections:
 - [STEP 4 SELECT MEMORY, page 19](#)
 - [STEP 5 SELECT DRIVE CONTROLLERS, page 24](#)
 - [STEP 6 SELECT DRIVES, page 27](#)
 - [STEP 7 SELECT OPTION CARD\(s\), page 31](#)

STEP 4 SELECT MEMORY

The available memory main characteristics for the C245 M6 SFF are as follows:

- Clock speed: 3200 MHz
- Ranks per DIMM: 1, 2, 4, or 8
- Operational voltage: 1.2 V
- Registered ECC DDR4 DIMMS (RDIMMs) or Load-reduced DIMMs (LRDIMMs).

Memory is organized with eight memory channels per CPU, with one or two DIMMs per channel (DPC).

Select DIMMs

The supported memory DIMMs are listed in [Table 6](#).

Table 6 Available DDR4 DIMMs

Product ID (PID)	PID Description	Voltage	Ranks /DIMM
3200-MHz DIMMs			
UCS-MR-X16G1RW	16 GB RDIMM SRx4 3200 (8Gb)	1.2 V	1
UCS-MR-X32G1RW	32 GB RDIMM SRx4 3200 (16Gb)	1.2 V	1
UCS-MR-X32G2RW	32 GB RDIMM DRx4 3200 (8Gb)	1.2 V	2
UCS-MR-X64G2RW	64 GB RDIMM DRx4 3200 (16Gb)	1.2 V	2
UCS-ML-128G4RW	128 GB LRDIMM QRx4 3200 (16Gb) (non-3DS)	1.2 V	4
UCS-ML-256G8RW ¹	256 GB LRDIMM 8Rx4 3200 (16Gb) (3DS)	1.2 V	8
DIMM Blank²			
UCS-DIMM-BLK	UCS DIMM Blank		

Notes:

1. 256 GB DIMMs cannot be combined with GPU cards, and the ambient temperature shall be limited to a maximum of 28°C.
2. Any empty DIMM slot must be populated with a DIMM blank to maintain proper cooling airflow.

Figure 4 is the supported 8-channel configuration, with one or two DPC.

Figure 4 8-Channel Memory Organization

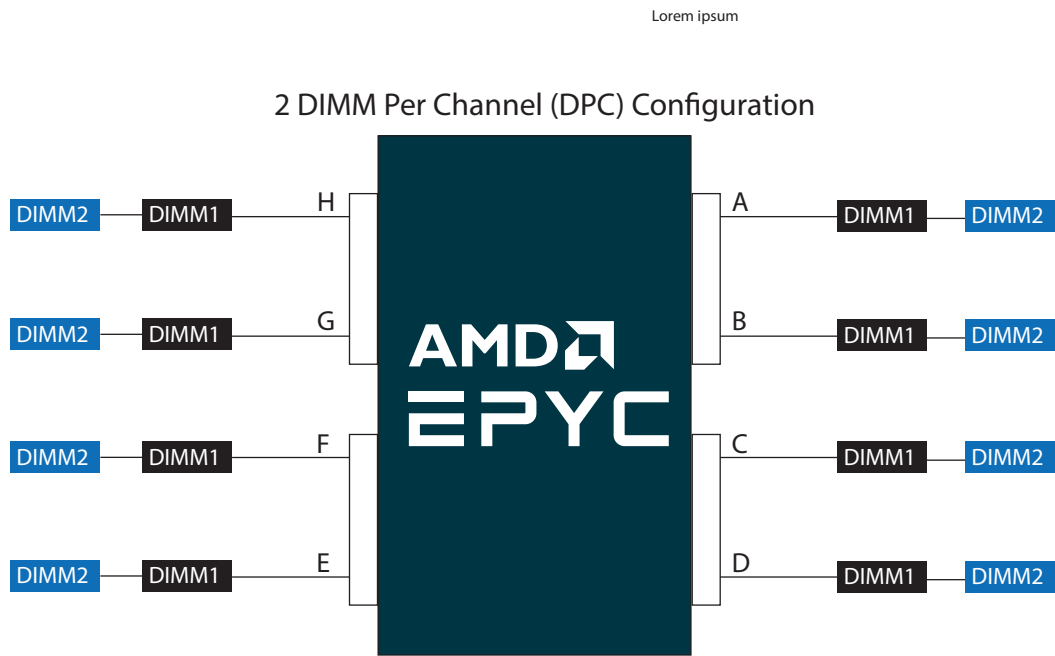

Note: Blue DIMM sockets are farthest from CPU and black DIMM sockets are closest to CPU

Approved Configurations

(1) One CPU (CPU1) population

- Select 4, 6, 8, 10, 12, 14, or 16 DIMMs for the 1 CPU system.
- 4 DIMMs configuration is only allowed, if eight channels cannot be populated, and only with processors that have 128MB L3 cache or less.

The DIMMs will be placed by the factory as shown in the following table.

Total DIMM number per system	CPU 1 DIMM Placement in Channels (for identically ranked DIMMs)
4	(C2, D2); (G2, H2)
6	(C2, D2); (G2, H2); (A2, E2)
8	(C2, D2); (G2, H2); (A2, E2); (B2, F2)
10	(C2, D2); (G2, H2); (A2, E2); (B2, F2); (D1, E1)
12	(C2, D2); (G2, H2); (A2, E2); (B2, F2); (D1, E1); (B1, G1)
14	(C2, D2); (G2, H2); (A2, E2); (B2, F2); (D1, E1); (B1, G1); (C1, F1)
16	(C2, D2); (G2, H2); (A2, E2); (B2, F2); (D1, E1); (B1, G1); (C1, F1); (A1, H1)

(2) Two CPU (CPU1 and CPU2) population

- Select 8,12,16,20,24,28,32 DIMMs for the 2 CPUs system.
- 8 DIMMs for 2 CPUs system configuration is only allowed if the 16 channels cannot be populated, and only with processors that have 128MB L3 cache or less.

The DIMMs will be placed by the factory as shown in the following tables.

Total DIMM number per system	CPU 1 DIMM Placement in Channels (for identically ranked DIMMs)	CPU 2 DIMM Placement in Channels (for identically ranked DIMMs)
8	(C2, D2); (G2, H2)	(C2, D2); (G2, H2)
12	(C2, D2); (G2, H2); (A2, E2)	(C2, D2); (G2, H2); (A2, E2)
16	(C2, D2); (G2, H2); (A2, E2); (B2, F2)	(C2, D2); (G2, H2); (A2, E2); (B2, F2)
20	(C2, D2); (G2, H2); (A2, E2); (B2, F2); (D1, E1)	(C2, D2); (G2, H2); (A2, E2); (B2, F2); (D1, E1)
24	(C2, D2); (G2, H2); (A2, E2); (B2, F2); (D1, E1); (B1, G1)	(C2, D2); (G2, H2); (A2, E2); (B2, F2); (D1, E1); (B1, G1)
28	(C2, D2); (G2, H2); (A2, E2); (B2, F2); (D1, E1); (B1, G1); (C1, F1)	(C2, D2); (G2, H2); (A2, E2); (B2, F2); (D1, E1); (B1, G1); (C1, F1)
32	(C2, D2); (G2, H2); (A2, E2); (B2, F2); (D1, E1); (B1, G1); (C1, F1); (A1, H1)	(C2, D2); (G2, H2); (A2, E2); (B2, F2); (D1, E1); (B1, G1); (C1, F1); (A1, H1)



NOTE: System performance is optimized when the DIMM type and quantity are equal for both CPUs, and when all channels are filled equally across the CPUs in the server.

Table 7 on page 22 and *Table 8 on page 22* give the maximum DRAM speeds for various DIMM populations.

Table 7 Memory Speed for 1 DIMM Per Channel (1 DPC)

DIMM Type	DIMM Population	Maximum DRAM Frequency (MHz)
	DIMM0	
RDIMM	One rank	3200
	Two ranks	3200
LRDIMM	Four ranks	3200
	Eight ranks	3200

Table 8 Memory Speed for 2 DIMMs Per Channel (2DPC)

DIMM Type	DIMM Population		Maximum DRAM Frequency (MHz)
	DIMM0	DIMM1	
RDIMM	One rank	One rank	2933
	One rank	Two rank	2933
	Two rank	Two rank	2933
LRDIMM	Four ranks	Four ranks	2933
	Eight ranks	Eight ranks	2933

DIMM Rules

- DIMM Mixing:
 - Mixing different types of DIMM (RDIMM with any type of LRDIMM or 3DS LRDIMM with non-3DS LRDIMM) is not supported within a server.
 - Mixing RDIMM with RDIMM types is allowed if they are mixed in same quantities, in a balanced configuration.
 - Mixing 16 GB, 32 GB, and 64 GB RDIMMs is supported.
 - 128 GB and 256 GB LRDIMMs cannot be mixed with other RDIMMs
 - 128 GB non-3DS LRDIMMs cannot be mixed with 256 GB 3DS LRDIMMs
- General Population Order Guidelines:
 - For best performance, populate all eight memory channels for each CPU socket, with every channel having the same capacity.
 - Populate open channels before populating two DIMMs on a given channel.
 - In 2 DPC configurations where only one DIMM is populated on a channel, populate the DIMM socket physically farthest away from the processor.
 - Balance memory capacity per channel pair on a given CPU.
 - Balance memory capacity per CPU socket in a two-socket system.
 - DIMMs within the same channel must be of the same base DIMM module type (all RDIMM, LRDIMM, or 3DS).
 - DIMMs within the same channel must be of the same DRAM density.
 - All memory channels operate at the same frequency. The system will use the highest common supported frequency when populated with different speed DIMMs. The highest common supported speed is the rated speed of the slowest DIMM in the system while also applying the population speed limits for the configuration (1 of 1, 1 of 2, 2 of 2).

STEP 5 SELECT DRIVE CONTROLLERS

The following list summarizes how drives are controlled on the server:

- SAS/SATA drives are controlled through a Cisco M6 12G RAID controller, or
- SAS/SATA drives are controlled through one or two Cisco 12G SAS HBAs
- NVMe PCIe drives are controlled directly from the CPUs

Cisco M6 12G SAS RAID Controller

This RAID controller supports up to 24 SAS or SATA drives operating at 3 Gbs, 6 Gbs, and 12 Gbs. It includes a SuperCap for a 4 GB flash-back write cache (FBWC) and supports RAID 0, 1, 5, 6, 10, 50, 60, SRAID0, and JBOD mode. The RAID controller plugs directly into a dedicated slot.



NOTE: 64 RAID groups (virtual drives) are supported with this RAID controller.

Cisco 12G SAS HBA

This HBA supports up to 16 SAS or SATA drives operating at 3 Gbs, 6 Gbs, and 12Gbs. It supports JBOD or pass-through mode (not RAID) and plugs directly into a dedicated slot. Two of these HBAs are required to control 24 drives.

RAID Volumes and Groups

When creating each RAID volume, follow these guidelines:

- Use the same capacity for each drive in each RAID volume
- For the Cisco M6 12G RAID controller, use either all SAS HDDs, or all SAS SSDs, or all SATA SSDs in each RAID volume

Select RAID Controller Options

Select one of the following:

- Cisco 12G SAS RAID controller (see [Table 9](#)), or
- Cisco 12G SAS HBA (see [Table 9](#))



NOTE: vSAN HCL listed/qualified component is UCSC-SAS-M6T (UCSC-SAS-240M6).

Table 9 Hardware Controller Options

Product ID (PID)	PID Description
Controllers for Internal Drives	
Note that if the following Cisco M6 12G SAS RAID controller or Cisco 12G SAS HBA is selected, they are factory-installed in a dedicated slot.	
UCSC-RAID-M6SD	Cisco M6 12G SAS RAID controller with SuperCap and 4GB FBWC <ul style="list-style-type: none"> ■ Supports up to 24 internal SAS HDDs and SAS/SATA SSDs. ■ Supports RAID 0, 1, 5, 6, 10, 50, 60, SRAID0, and JBOD mode. Supports mixed RAID and JBOD mode. ■ For now, SED drives are managed with local key management only. Third-party key management will be supported (KMIP compliant).
UCSC-SAS-240M6	Cisco 12G SAS HBA <ul style="list-style-type: none"> ■ Supports up to 16 internal SAS HDDs and SAS/SATA SSDs ■ Supports JBOD or pass-through mode
RAID Configuration Options (not available for Cisco 12G SAS Tri Mode HBA or AHCI)	
R2XX-SRAID0	Enable single disk RAID 0 Setting.
R2XX-RAID0	Factory preconfigured RAID striping option Enable RAID 0 Setting. Requires two or more hard drives
R2XX-RAID1	Factory preconfigured RAID mirroring option Enable RAID 1 Setting. Requires two or more drives with the same size, speed, capacity.
R2XX-RAID5	Factory preconfigured RAID option Enable RAID 5 Setting. Requires a minimum of three drives of the same size, speed, capacity.
R2XX-RAID6	Factory preconfigured RAID option Enable RAID 6 Setting. Requires a minimum of four drives of the same size, speed, capacity.
R2XX-RAID10	Factory preconfigured RAID option Enable RAID 10 Setting. Requires a even number of drives (minimum of four drives) of the same size, speed, capacity.



NOTE:

- CBL-SAS24-245M6 is included with the selection of UCSC-SAS-240M6
 - CBL-SDSAS-245M6 and UCS-SCAP-M6 is included with the selection of UCSC-RAID-M6SD
 - if are adding drive controller later as spare, you may need to order cables and super cap/cables with it.
-

Approved Configurations

- The Cisco 12G RAID HBA supports up to 24 internal SAS/SATA SSDs or HDDs with up to RAID 0, 1, 5, 6, 10, 50, 60, SRAID0, and JBOD mode.
- Each Cisco 12G SAS HBA supports up to 16 internal SAS/SATA SSDs or HDDs with JBOD support.

STEP 6 SELECT DRIVES

The standard disk drive features are:

- 2.5-inch small form factor
- Hot-pluggable
- Drives come mounted in sleds



NOTE: If more than two NVMe SSDs are selected, you must also select 2 CPUs.

Select Drives

The available drives are listed in [Table 10](#).

Table 10 Available Hot-Pluggable Sled-Mounted Drives

Product ID (PID)	PID Description	Drive Type	Capacity
HDDs			
HDDs (15K RPM)			
UCS-HD900G15K12N	900 GB 12G SAS 15K RPM SFF HDD	SAS	900 GB
UCS-HD300G15K12N	300 GB 12G SAS 15K RPM SFF HDD	SAS	300 GB
UCS-HD600G15K12N	600 GB 12G SAS 15K RPM SFF HDD	SAS	600 GB
HDDs (10K RPM)			
UCS-HD300G10K12N	300 GB 12G SAS 10K RPM SFF HDD	SAS	300 GB
UCS-HD600G10K12N	600 GB 12G SAS 10K RPM SFF HDD	SAS	600 GB
UCS-HD12TB10K12N	1.2 TB 12G SAS 10K RPM SFF HDD	SAS	1.2 TB
UCS-HD18TB10K4KN ¹	1.8 TB 12G SAS 10K RPM SFF HDD (4K)	SAS	1.8 TB
UCS-HD24TB10K4KN ¹	2.4 TB 12G SAS 10K RPM SFF HDD (4K)	SAS	2.4 TB
Enterprise Performance SAS/SATA SSDs (High endurance, supports up to 10X or 3X DWPD (drive writes per day))²			
UCS-SD19T63X-EP	1.9 TB 2.5in Enterprise performance 6GSATA SSD(3X endurance)	SATA	1.9 TB
UCS-SD960G63X-EP	960 GB 2.5in Enterprise performance 6GSATA SSD(3X endurance)	SATA	960 GB
UCS-SD480G63X-EP	480 GB 2.5in Enterprise Performance 6GSATA SSD(3X endurance)	SATA	480 GB
UCS-SD19TBM3X-EP	1.9TB 2.5in Enterprise performance 6GSATA SSD(3X endurance)	SATA	1.9 TB
UCS-SD960GBM3X-EP	960GB 2.5in Enterprise performance 6GSATA SSD(3X endurance)	SATA	960 GB
UCS-SD480GBM3X-EP	480GB 2.5in Enterprise Performance 6GSATA SSD(3X endurance)	SATA	480 GB
UCS-SD38T63X-EP	3.8TB 2.5in Enter Perf 6G SATA Intel SSD (3X)	SATA	3.8 TB
UCS-SD800GK3X-EP	800 GB 2.5in Enterprise Performance 12G SAS SSD(3X endurance)	SAS	800 GB
UCS-SD16TK3X-EP	1.6 TB 2.5in Enterprise Performance 12G SAS SSD(3X endurance)	SAS	1.6 TB
UCS-SD32TK3X-EP	3.2 TB 2.5in Enterprise Performance 12G SAS SSD(3X endurance)	SAS	3.2 TB
UCS-SD32TKA3X-EP	3.2TB 2.5in Enter Perf 12G SAS Kioxia G2 SSD (3X)	SAS	3.2 TB

Table 10 Available Hot-Pluggable Sled-Mounted Drives (continued)

Product ID (PID)	PID Description	Drive Type	Capacity
UCS-SD16TKA3X-EP	1.6TB 2.5in Enterprise Performance 12G SAS SSD(3X endurance)	SAS	1.6 TB
Enterprise Value SAS/SATA SSDs (Low endurance, supports up to 1X DWPD (drive writes per day))³			
UCS-SD38T611X-EV	3.8 TB 2.5 inch Enterprise Value 6G SATA SSD	SATA	3.8 TB
UCS-SD960G611X-EV	960 GB 2.5 inch Enterprise Value 6G SATA SSD	SATA	960 GB
UCS-SD480G611X-EV	480 GB 2.5 inch Enterprise Value 6G SATA SSD	SATA	480 GB
UCS-SD19T61X-EV	1.9 TB 2.5 inch Enterprise Value 6G SATA SSD	SATA	1.9 TB
UCS-SD38T61X-EV	3.8 TB 2.5 inch Enterprise Value 6G SATA SSD	SATA	3.8 TB
UCS-SD120GM1X-EV	120 GB 2.5 inch Enterprise Value 6G SATA SSD	SATA	120 GB
UCS-SD960G6S1X-EV	960GB 2.5 inch Enterprise Value 6G SATA SSD	SATA	960 GB
UCS-SD19T6S1X-EV	1.9TB 2.5 inch Enterprise Value 6G SATA SSD	SATA	1.9 TB
UCS-SD38T6S1X-EV	3.8TB 2.5 inch Enterprise Value 6G SATA SSD	SATA	3.8 TB
UCS-SD76T6S1X-EV	7.6TB 2.5 inch Enterprise Value 6G SATA SSD	SATA	7.6 TB
UCS-SD76TBM1X-EV	7.6TB 2.5 inch Enterprise Value 6G SATA SSD	SATA	7.6 TB
UCS-SD38TBM1X-EV	3.8TB 2.5 inch Enterprise Value 6G SATA SSD	SATA	3.8 TB
UCS-SD19TBM1X-EV	1.9TB 2.5 inch Enterprise Value 6G SATA SSD	SATA	1.9 TB
UCS-SD16TBM1X-EV	1.6TB 2.5 inch Enterprise Value 6G SATA SSD	SATA	1.6 TB
UCS-SD960GBM1X-EV	960GB 2.5 inch Enterprise Value 6G SATA SSD	SATA	960 GB
UCS-SD480GBM1X-EV	480GB 2.5 inch Enterprise Value 6G SATA SSD	SATA	480 GB
UCS-SD240GBM1X-EV	240GB 2.5 inch Enterprise Value 6G SATA SSD	SATA	240 GB
UCS-SD19TM1X-EV	1.9TB 2.5in Enter Value 6G SATA Micron G1 SSD	SATA	1.9 TB
UCS-SD960GK1X-EV	960 GB 2.5 inch Enterprise Value 12G SAS SSD	SAS	960 GB
UCS-SD19TK1X-EV	1.9 TB 2.5 inch Enterprise Value 12G SAS SSD	SAS	1.9 TB
UCS-SD38TK1X-EV	3.8 TB 2.5 inch Enterprise Value 12G SAS SSD	SAS	3.8 TB
UCS-SD76TK1X-EV	7.6 TB 2.5 inch Enterprise Value 12G SAS SSD	SAS	7.6 TB
UCS-SD15TK1X-EV	15.3 TB 2.5 inch Enterprise Value 12G SAS SSD	SAS	15.3 TB
UCS-SD15TKA1X-EV	15.3TB 2.5in Enter Value 12G SAS Kioxia G2 SSD	SAS	15.3 TB
UCS-SD76TKA1X-EV	7.6TB 2.5 inch Enterprise Value 12G SAS SSD	SAS	7.6 TB
UCS-SD38TKA1X-EV	3.8TB 2.5 inch Enterprise Value 12G SAS SSD	SAS	3.8 TB
UCS-SD19TKA1X-EV	1.9TB 2.5 inch Enterprise Value 12G SAS SSD	SAS	1.9 TB
Self-Encrypted Drives (SED)			
UCS-HD18T10NK9	1.8 TB 12G SAS 10K RPM SFF HDD (4K format, SED)	SED	1.8 TB
UCS-HD12T10NK9	1.2TB 12G SAS 10K RPM SFF HDD (SED-FIPS)	SED	1.2 TB
UCS-HD600G15NK9	600 GB 12G SAS 15K RPM SFF HDD (SED)	SED	600 GB
UCS-SD76TBKNK9	7.6TB Enterprise value SAS SSD (1 DWPD, SED-FIPS)	SED-FIPS	7.6 TB
UCS-SD76TEM2NK9	7.6TB Enterprise value SATA SSD (1X, SED)	SED	7.6 TB
UCS-SD960GM2NK9	960GB Enterprise value SATA SSD (1X, SED)	SED	960 GB
UCS-SD76TBKANK9	7.6TB Enterprise value SAS SSD (1 DWPD, SED-FIPS)	SED	7.6 TB
UCS-SD38TBKANK9	3.8TB 2.5in Enterprise value 12G SAS SSD (1DWPD, SED-FIPS)	SED	3.8 TB
UCS-SD16TBKANK9	1.6TB 2.5in Enter Perf 12G SAS Kioxia G2 SSD (3X SED-FIPS)	SED	1.6 TB

Table 10 Available Hot-Pluggable Sled-Mounted Drives (continued)

Product ID (PID)	PID Description	Drive Type	Capacity
PCIe / NVMe 2.5-in SFF Drives⁴			
UCSC-NVMEXPB-I375	375 GB 2.5in Intel Optane NVMe Extreme Performance SSD	NVMe	375 GB
UCSC-NVMEXP-I750	750 GB 2.5in Intel Optane NVMe Extreme Perf.	NVMe	750 GB
UCS-NVMEI4-I1920	1.9 TB 2.5in U.2 Intel P5500 NVMe High Perf Medium Endurance	NVMe	1.9 TB
UCS-NVMEI4-I1600	1.6 TB 2.5in U.2 Intel P5600 NVMe High Perf Medium Endurance	NVMe	1.6 TB
UCS-NVMEI4-I3200	3.2 TB 2.5in U.2 Intel P5600 NVMe High Perf Medium Endurance	NVMe	3.2 TB
UCS-NVMEI4-I6400	6.4 TB 2.5in U.2 Intel P5600 NVMe High Perf Medium Endurance	NVMe	6.4 TB
UCS-NVMEXP-I400	400GB 2.5in U.2 Intel P5800X Optane NVMe Extreme Perform SSD	NVMe	400 GB
UCS-NVMEXP-I800	800GB 2.5in U.2 Intel P5800X Optane NVMe Extreme Perform SSD	NVMe	800 GB
UCS-NVME4-1920	1.9TB 2.5in U.2 15mm P5520 Hg Perf Med End NVMe	NVMe	1,9 TB
UCS-NVME4-3840	3.8TB 2.5in U.2 15mm P5520 Hg Perf Med End NVMe	NVMe	3.8 TB
UCS-NVME4-7680	7.6TB 2.5in U.2 15mm P5520 Hg Perf Med End NVMe	NVMe	7.6 TB
UCS-NVME4-1536	15.3TB 2.5in U.2 15mm P5520 Hg Perf Med End NVMe	NVMe	15.3 TB
UCS-NVME4-1600	1.6TB 2.5in U.2 15mm P5620 Hg Perf Hg End NVMe (3X)	NVMe	1.6 TB
UCS-NVME4-3200	3.2TB 2.5in U.2 15mm P5620 Hg Perf Hg End NVMe (3X)	NVMe	3.2 TB
UCS-NVME4-6400	6.4TB 2.5in U.2 15mm P5620 Hg Perf Hg End NVMe (3X)	NVMe	6.4 TB
UCS-NVMEQ-1536	15.3TB 2.5in U.2 15mm P5316 Hg Perf Low End NVMe	NVMe	15.3 TB
UCS-NVMEM6-W3200	3.2TB 2.5in U.2 WD SN840 NVMe Extreme Perf. High Endurance	NVMe	3.2 TB
UCS-NVMEM6-W7680	7.6TB 2.5in U.2 WD SN840 NVMe Extreme Perf. Value Endurance	NVMe	7.6 TB
UCS-NVMEM6-W15300	15.3TB 2.5in U.2 WD SN840 NVMe Extreme Perf. Value Endurance	NVMe	15.3 TB
NOTE: Cisco uses solid state drives from a number of vendors. All solid state drives are subject to physical write limits and have varying maximum usage limitation specifications set by the manufacturer. Cisco will not replace any solid state drives that have exceeded any maximum usage specifications set by Cisco or the manufacturer, as determined solely by Cisco.			

Notes:

- Operating Systems that support 4k sector size drives are as follows:
 - CentOS 7.9/8.2/8.3 (and later), Windows Server 2016/2019 (and later)
 - Red Hat Enterprise Linux 7.9/8.2 (and later), SUSE Linux Enterprise Server 15.2 (and later)
 - ESXi 6.7 U3/7.0 U2 (and later)
 - See this link for operating system guidance: <https://ucshcltool.cloudapps.cisco.com/public/>
 - UEFI Mode must be used when booting from 4K sector size drives (legacy mode is not supported).
 - Ensure that 4K sector size and 512 byte sector size drives are not mixed in the same RAID volume.
- Targeted for write centric IO applications. Supports endurance of 10 or 3 DWPD (drive writes per day). Target applications are caching, online transaction processing (OLTP), data warehousing, and virtual desktop infrastructure (VDI).
- Targeted for read centric IO applications. Supports endurance of 1 DWPD (drive write per day). Target applications are boot, streaming media, and collaboration.
- Except HGST, Intel and WD NVMe drives can be mixed.

**NOTE:**

- When you order front-facing NVMe drives with or without raid controller (**UCSC-RAID-M6SD**), an NVMe cable (**PID: CBL-SDFNVME-245M6**) is included along with the drives.
- When you order front-facing NVMe drives with dual SAS HBAs (**UCSC-SAS-240M6**), an NVMe cable (**PID: CBL-FNVME-C245M6**) is included along with the drives.
- If you decide to add front-facing NVMe drives later, you may need to order the drives as spare and also an NVMe cable (**PID: CBL-SDFNVME-245M6=** or **CBL-FNVME-C245M6=**). Spare NVMe cables supports depends on the drive controller installing/installed in the system.
 - With or without RAID controller (**UCSC-RAID-M6SD**) configuration:
 - Cable PID: **CBL-SDFNVME-245M6=**
 - This cable plugs into NVMe-C on MB side, and NVMe-C on BP side and controls drives 1-2.
 - This cable plugs into NVMe-B on MB side, and NVMe-D on BP side and controls drives 3-4.
 - Dual SAS HBA(**UCSC-SAS-240M6**) configuration:
 - Cable PID: **CBL-FNVME-C245M6=**
 - This cable plugs into MB CPU2(NVMe-C) to NVMe-C & D on 2U24 SFF BP and connects to drives HDD1-2 & HDD3-4.

See for [SPARE PARTS, page 79](#) section for all the spare components and required other parts with it.

Caveats

- Front SFF NVMe drives are connected directly to CPU2, and are not managed by any drive controller.
- If you order any front SFF NVMe drives, you must also order two CPUs.
- The rear NVMe drives are controlled directly from the CPUs.
- The rear NVMe drives are not bootable.
- If you order 3 or 4 NVMe drives, you must also order two CPUs
- SFF NVMe drives are bootable in UEFI mode only.
- You can mix HDDs and SSDs as long as you keep all HDDs in their own RAID volume and all SSDs in their own RAID volume.
- You can mix SAS HDDs and SAS/SATA SSDs when using a Cisco M6 12G SAS RAID controller or Cisco 12G SAS HBA.
- SED drives can be mixed with the non-SED drives in [Table 10 on page 27](#)

STEP 7 SELECT OPTION CARD(S)

For up-to-date server compatibility, please check the Hardware and Software compatibility list (HCL) at <https://ucshcltool.cloudapps.cisco.com/public/>.

The standard card offerings are:

- Modular LAN on Motherboard (mLOM)
- Virtual Interface Cards (VICs)
- Network Interface Cards (NICs)
- Open Compute Project (OCP) 3.0 NIC
- Host Bus Adapters (HBAs)

Select Option Cards

The available option cards are listed in [Table 11](#).

Table 11 Available Option Cards

Product ID (PID)	PID Description	Location	Card Size ¹
Modular LAN on Motherboard (mLOM)/OCP			
UCSC-M-V25-04	Cisco UCS VIC 1467 quad port 10/25G SFP28 mLOM	mLOM	HHHL, SS
UCSC-M-V100-04	Cisco UCS VIC 1477 dual port 40/100G QSFP28 mLOM	mLOM	HHHL, SS
UCSC-M-V5Q50G	Cisco UCS VIC 15428 quad port 10/25/50G MLOM	mLOM	HHHL, SS
UCSC-M-V5D200G	Cisco UCS VIC 15238 dual port 40/100/200G MLOM	mLOM	HHHL, SS
UCSC-M-V5Q50GV2 ²	Cisco UCS VIC 15427 Quad Port CNA MLOM with Secure Boot	mLOM	HHHL, SS
UCSC-M-V5D200GV2 ²	VIC 15237, MLOM, 2x40/100/200G for Rack	mLOM	HHHL, SS
UCSC-O-ID10GC ³	Intel X710T2LOCPV3G1L 2x10GBase-T OCP3 NIC	mLOM/OCP 3.0 slot	-
Virtual Interface Card (VICs)			
UCSC-PCIE-C100-04	Cisco UCS VIC 1495 Dual Port 40/100G QSFP28 CNA PCIe	Riser 1 or 2	HHHL, SS
UCSC-PCIE-C25Q-04	Cisco UCS VIC 1455 quad port 10/25G SFP28 PCIe	Riser 1 or 2	HHHL, SS
UCSC-P-V5Q50G-D	Cisco UCS VIC 15425 Quad Port 10/25/50G CNA PCIE	Riser 1 or 2	HHHL, SS
UCSC-P-V5D200G-D	Cisco UCS VIC 15235 Dual Port 40/100/200G CNA PCIE	Riser 1 or 2	HHHL, SS
Network Interface Cards (NICs)			
1 Gb NICs			
UCSC-PCIE-IRJ45	Intel i350 quad-port 1G copper PCIe	Riser 1, 2, or 3	HHHL, SS
10 Gb NICs			
UCSC-PCIE-ID10GF	Intel X710-DA2 Dual Port 10Gb SFP+ NIC	Riser 1, 2, or 3	HHHL, SS
UCSC-PCIE-IQ10GF	Intel X710 quad-port 10G SFP+ NIC	Riser 1, 2, or 3	HHHL, SS
UCSC-P-ID10GC	Cisco-Intel X710T2LG 2x10 GbE RJ45 PCIe NIC	Riser 1, 2, or 3	HHHL, SS

Table 11 Available Option Cards (continued)

Product ID (PID)	PID Description	Location	Card Size ¹
UCSC-P-IQ10GC	Cisco-Intel X710T4LG 4x10 GbE RJ45 PCIe NIC	Riser 1, 2, or 3	HHHL, SS
25 Gb NICs			
UCSC-P-I8D25GF ⁴	Cisco-Intel E810XXVDA2 2x25/10 GbE SFP28 PCIe NIC	Riser 1, 2, or 3	HHHL, SS
UCSC-P-M5D25GF ⁴	Mellanox MCX512A-ACAT dual port 10/25G SFP28 NIC	Riser 1, 2, or 3	HHHL, SS
UCSC-P-I8Q25GF ⁴	Cisco-Intel E810XXVDA4L 4x25/10 GbE SFP28 PCIe NIC	Riser 1, 2, or 3	FHHL, SS
40 Gb NICs			
UCSC-PCIE-ID40GF	Intel XL710 dual-port 40G QSFP+ NIC	Riser 1, 2, or 3	HHHL, SS
100 Gb NICs			
UCSC-P-M5D100GF ⁴	Mellanox CX-5 MCX516A-CDAT 2x100GbE QSFP PCIe NIC	Riser 1, 2, or 3	HHHL, SS
UCSC-P-I8D100GF ⁴	Cisco-Intel E810CQDA2 2x100 GbE QSFP28 PCIe NIC	Riser 1, 2, or 3	HHHL, SS
UCSC-P-M6DD100GF	Cisco-MLNX MCX623106AS-CDAT 2x100GbE QSFP56 PCIe NIC	Riser 1, 2, or 3	HHHL, SS
UCSC-P-M6CD100GF	Cisco-MLNX MCX623106AC-CDAT 2x100GbE QSFP56 PCIe NIC (with Crypto)	Riser 1, 2, or 3	HHHL, SS
Nexus Smart NICs⁵			
NXN-K3P-2X	Nexus X25 2-port SFP28 SmartNIC (2-channel), KU3P FPGA	Riser 1, 2, or 3	HHHL, SS
NXN-K3P-2X-4GB	Nexus X25 2-port SFP28 SmartNIC (2-channel), KU3P FPGA, 4GB	Riser 1, 2, or 3	HHHL, SS
NXN-K3P-8X	Nexus X100 2-port QSFP28 SmartNIC (8-channel), KU3P FPGA	Riser 1, 2, or 3	HHHL, SS
NXN-K3P-8X-9GB	Nexus X100 2p QSFP28 SmartNIC (8-channel), KU3P FPGA, 9GB	Riser 1, 2, or 3	HHHL, SS
NXN-V9P-16X-9GB	Nexus 2-port QDD SmartNIC+ (16-channel), VU9P FPGA, 9GB DDR	Riser 1, 2, or 3	HHHL, SS
Host Bus Adapters (HBAs)			
UCSC-P-Q6D32GF	Cisco-QLogic QLE2772 2x32GFC Gen 6 Enhanced PCIe HBA	Riser 1, 2, or 3	HHHL, SS
UCSC-P-B7D32GF	Cisco-Emulex LPe35002-M2-2x32GFC Gen 7 PCIe HBA	Riser 1, 2, or 3	HHHL, SS
UCSC-PCIE-QD16GF	Qlogic QLE2692 dual-port 16G FC HBA	Riser 1, 2, or 3	HHHL, SS
UCSC-PCIE-BD16GF	Emulex LPe31002 dual port 16G FC HBA	Riser 1, 2, or 3	HHHL, SS

Notes:

1. HHHL = half-height, half-length; HHHL = half-height, half-length; SS = single-slot; DS = double-slot
2. Can not be mixed with 1400 series VICs
3. The UCSC-O-ID10GC is an OCP 3.0 adapter and fits in mLOM /OCP 3.0 slot using a special mechanical connector add-on. See the following link for installation instructions:
https://www.cisco.com/content/en/us/td/docs/unified_computing/ucs/c/hw/c245m6/install/c245m6.html
4. When present, the recommended Fan Speed Control policy setting is balanced
5. Nexus Smart NICs are currently available only with RHEL 8.4 drivers. refer to [data sheet](#) for the complete details NIC.

Caveats

- For 1-CPU systems:
 - Only PCIe slots 1, 2, and 3 on PCIe riser 1A are available for a 1-CPU system.
 - The PCIe slots on riser 2 are not supported on 1-CPU systems. The riser 2 slots are full-height PCIe slots 4, 5, and 6 (see [Figure 3 on page 8](#)). These are the slots in the middle when looking at the rear of the server. Slot 4 is the bottom slot.
 - The PCIe slots on riser 3 are not supported on 1-CPU systems. The riser 3 slots are full-height PCIe slots 7 and 8 (see [Figure 3 on page 8](#)). These are the slots on the right when looking at the rear of the server. Slot 7 is the bottom slot.
 - Only a single plug-in PCIe VIC card may be installed on a 1-CPU system, and it must be installed in slots 1, 2, or 3 of riser 1A.
 - You can order an mLOM VIC card to be installed in the mLOM/OCP 3.0 slot internal to the chassis and thus have two VIC cards in operation at the same time. If you order a GPU, it must be installed in slots as specified in [Table 11 on page 31](#). See [Table 11 on page 31](#) for the selection of plug-in and mLOM VIC cards.
- For 2-CPU systems:
 - The following PCIe slots are available:
 - Three on PCIe riser 1A (PCIe slots 1, 2, and 3),
 - Three on PCIe riser 2A (PCIe slots 4, 5, and 6),
 - Two on PCIe riser 3A (PCIe slots 7 and 8).
 - Two plug-in PCIe VIC cards can be installed in dual CPU systems, using slots 2 and 5. In addition, you can order an mLOM VIC card, which is installed in the mLOM/OCP 3.0 slot inside the chassis and thus have three VIC cards in operation at the same time. See [Table 11 on page 31](#) for the selection of plug-in and mLOM VIC cards. See also [Table 1 on page 10](#) and [Serial Port Details, page 78](#) for the PCIe slot physical descriptions.
 - If GPUs are installed in slot 2 of riser 1A or slot 5 of riser 2A, the NCSI capability automatically switches over to slot 1 of riser 1A or slot 4 of Riser 2A. Therefore, Cisco PCIe VICs can be installed in slots 1 and 4 if GPUs are installed in slots 2 and 5. If you order multiple GPUs, they must be installed as shown in [Table 11 on page 31](#).
 - The server supports up to two PCIe Cisco VICs plus an mLOM VIC

However, single-wire management is supported on only one VIC at a time. If multiple VICs are installed on a server, only one slot has NCSI enabled at a time and for single wire management, priority goes to the mLOM/OCP 3.0 slot, then slot 2, then slot 5 for NCSI management traffic. When multiple cards are installed, connect the single wire management cables in the priority order mentioned above.
- To help ensure that your operating system is compatible with the card you have selected, or to see additional cards that have been qualified to work with the UCS C245 M6 server, but are not sold on the Cisco price list, check the Hardware Compatibility List at this link

http://www.cisco.com/en/US/products/ps10477/prod_technical_reference_list.html

STEP 8 ORDER OPTIONAL PCIe OPTION CARD ACCESSORIES

- These optics and cables have been tested for compatibility and are approved for use with Ethernet Network Adapter (as of the time of this publication). For the latest update, check the and consult Cisco Compatibility Matrix at <https://tmgmatrix.cisco.com>.
- For list of supported optics and cables for VIC 1455, VIC 1467, VIC 1495 and VIC 1477 refer to VIC 1400 series data sheet at the following links:
 - <https://www.cisco.com/c/en/us/products/collateral/interfaces-modules/unified-computing-system-adapters/datasheet-c78-741130.html>
 - <https://www.cisco.com/c/en/us/products/collateral/interfaces-modules/unified-computing-system-adapters/datasheet-c78-734727.html>

Select

- NIC Interoperability with Cisco Cables/Optics (*Table 12 on page 34 through Table 14 on page 35*).
- NIC Interoperability with Intel Cables/Optics (*Table 15 on page 36*).

Table 12 10G NIC Interoperability with Cisco Cables/Optics

Cisco Product ID (PID)	UCSC- PCIe-ID10GF	UCSC- PCIe-IQ10GF	UCSC- P-ID10GC
Cisco Direct Attach Cables (DAC)			
SFP-H10GB-CU1M	✓	✓	
SFP-H10GB-CU3M	✓	✓	
SFP-H10GB-CU5M	✓	✓	
SFP-H10GB-ACU7M	✓	✓	
SFP-H10GB-ACU10M	✓	✓	
SFP-10G-AOC1M	✓	✓	
SFP-10G-AOC2M	✓	✓	
SFP-10G-AOC3M	✓	✓	
SFP-10G-AOC5M	✓	✓	
SFP-10G-AOC7M	✓	✓	
SFP-10G-AOC10M	✓	✓	
UTP/RJ45			✓
Cisco Optical Transceivers			
SFP-10G-SR	✓	✓	
SFP-10G-SR-S	✓	✓	
SFP-10G-LR	✓	✓	
SFP-10G-LR-S	✓	✓	
GLC-SX-MMD	✓	✓	

Table 13 25G NIC Interoperability with Cisco Cables/Optics

Cisco Product ID (PID)	UCSC-P-M5D25GF	UCSC-P-I8Q25GF	UCSC-P-I8D25GF
Cisco Direct Attach Cables (DAC)			
SFP-H10GB-CU1M	✓	✓	✓
SFP-H10GB-CU3M	✓	✓	✓
SFP-H10GB-CU4M	✓		
SFP-H10GB-CU5M	✓	✓	✓
SFP-H10GB-ACU7M	✓		
SFP-H10GB-ACU10M	✓		
SFP-10G-AOC7M		✓	✓
SFP-10G-AOC10M	✓		
SFP-25G-AOC10M	✓	✓	✓
SFP-25G-AOC5M	✓		
SFP-25G-AOC7M	✓		
QSFP-4SFP25G-CU2M		✓	✓
SFP-H25G-CU1M	✓	✓	✓
SFP-H25G-CU2M	✓	✓	✓
SFP-H25G-CU2.5M	✓		
SFP-H25G-CU3M	✓	✓	✓
SFP-H25G-CU4M	✓		
SFP-H25G-CU5M	✓	✓	✓
Cisco Optical Transceivers			
SFP-10G-SR	✓	✓	✓
SFP-10G-SR-S		✓	✓
SFP-10G-LR	✓	✓	✓
SFP-25G-SR-S	✓	✓	✓
SFP-10/25G-LR-S	✓	✓	✓
SFP-10/25G-CSR-S		✓	✓

Table 14 100G NIC Interoperability with Cisco Cables/Optics

Cisco Product ID (PID)	UCSC-P-M5D100GF	UCSC-P-I8D100GF
Cisco Direct Attach Cables (DAC)		
QSFP-100G-AOC5M	✓	
QSFP-100G-AOC7M	✓	✓
QSFP-100G-AOC10M	✓	✓

Table 14 100G NIC Interoperability with Cisco Cables/Optics (continued)

QSFP-4SFP25G-CU2M		✓
QSFP-100G-CU3M	✓	
QSFP-100G-CU5M	✓	✓
Cisco Optical Transceivers		
QSFP-100G-LR4-S	✓	
QSFP-100G-SR4-S	✓	✓
QSFP-40/100-SRBD	✓	✓

Table 15 Intel NIC Interoperability with Intel Cables/Optics

Intel Product ID (PID)	UCSC-PCIE-ID10GF
Intel Direct Attach Cables (DACs)	
XDACBL1M	✓
XDACBL3M	✓
XDACBL5M	✓
Intel Optical Transceivers	
E10GSFPSR	✓
E10GSFPLR	✓

The information in the preceding tables was compiled from testing conducted by Cisco Transceiver Module Group (TMG) and vendors. The latest compatibility with optical modules and DACs can be found at <https://tmgmatrix.cisco.com/>.

Refer to the these links for additional connectivity options.

Intel:	Mellanox:
Product Guide	Firmware Release Notes
Speed White Paper	

STEP 9 ORDER GPU CARDS (OPTIONAL)



NOTE: When a GPU is ordered, the server comes with low-profile heatsinks PID (UCSC-HSLP-M6) and need to select special air duct PID (UCSC-ADGPU-245M6) for GPUs.

Select GPU Options

The available GPU PCIe options and their riser slot compatibilities are listed in [Table 16](#)

Table 16 Available PCIe GPU Cards¹

GPU Product ID (PID)	PID Description	Card Size	Max GPU per Node	Riser Slot Compatibility					
				Riser 1A (Gen 4)	Riser 1B ²	Riser 2 (Gen 4)	Riser 3A ³ Gen 4)	Riser 3B ⁴	Riser 3C ⁵
UCSC-GPU-A10	TESLA A10, PASSIVE, 150W, 24GB	Single-wide	5	slot 2&3	N/A	slot 5&6	N/A	N/A	slot 7
UCSC-GPU-A30	TESLA A30, PASSIVE, 180W, 24GB	Double-wide	3	slot 2	N/A	slot 5	N/A	N/A	slot 7
UCSC-GPU-A40 ⁵	TESLA A40 RTX, PASSIVE, 300W, 48GB	Double-wide	3	slot 2	N/A	slot 5	N/A	N/A	slot 7
UCSC-GPU-A100-80 ⁵	TESLA A100, PASSIVE, 300W, 80GB	Double-wide	3	slot 2	N/A	slot 5	N/A	N/A	slot 7
UCSC-GPU-A16 ⁵	NVIDIA A16 PCIE 250W 4X16GB	Double-wide	3	slot 2	N/A	slot 5	N/A	N/A	slot 7

Notes:

1. Refer to https://www.cisco.com/content/en/us/td/docs/unified_computing/ucs/c/hw/c240m6/install/b-c240-m6-install-guide.html for more details.
2. Riser 1B does not accept GPUs
3. Riser 3A does not accept GPUs
4. Riser 3B does not accept GPUs
5. The server supports one full-height, full-length, double-wide GPU (PCIe slot 7 only) in Riser 3C.

**NOTE:**

- GPUs cannot be mixed
- All GPU cards must be procured from Cisco as there is a unique SBIOS ID required by CIMC and UCSM
- If you are adding GPUs later, please refer to [SPARE PARTS, page 79](#) section of the below spec sheet to find the accessories/cables needed along with the GPU spare.
- Please refer to [installation guide](#) for the GPU related information.

Table 17 NVIDIA GPU Licenses

Product ID (PID)	PID Description
NV-VCS-1YR	NVIDIA vCompute Server Subscription - 1 GPU - 1 Year
NV-VCS-3YR	NVIDIA vCompute Server Subscription - 1 GPU - 3 Year
NV-VCS-5YR	NVIDIA vCompute Server Subscription - 1 GPU - 5 Year
NV-GRDWK-1-5S	Quadro Perpetual Lic - NVIDIA vDWS 1CCU; 5Yr SUMS Req
NV-GRDVA-1-5S	GRID Perpetual Lic - NVIDIA VDI APPs 1CCU; 5Yr SUMS Req
NV-GRDPC-1-5S	GRID Perpetual Lic - NVIDIA VDI PC 1CCU; 5Yr SUMS Req
NV-GRD-EDP-5S	EDU - Quadro Perpetual Lic - NVIDIA vDWS 1CCU; 5Yr SUMS Req
NV-GRID-WKP-5YR	NVIDIA Quadro Production SUMS - vDWS 1CCU - 5 Year
NV-GRID-VAP-5YR	NVIDIA GRID Production SUMS - VDI Apps 1CCU - 5 Year
NV-GRID-PCP-5YR	NVIDIA GRID Production SUMS - VDI PC 1CCU - 5 Year
NV-GRID-EDP-5YR	EDU - NVIDIA Quadro vDWS Production SUMS - 1CCU - 5 Year
NV-GRID-WKS-1YR	NVIDIA Quadro SW Subscription - vDWS 1CCU - 1 Year
NV-GRID-WKS-3YR	NVIDIA Quadro SW Subscription - vDWS 1CCU - 3 Year
NV-GRID-WKS-4YR	NVIDIA Quadro SW Subscription - vDWS 1CCU - 4 Year
NV-GRID-WKS-5YR	NVIDIA Quadro SW Subscription - vDWS 1CCU - 5 Year
NV-GRID-PCS-1YR	NVIDIA GRID Software Subscription - VDI PC 1CCU - 1 Year
NV-GRID-PCS-3YR	NVIDIA GRID Software Subscription - VDI PC 1CCU - 3 Year
NV-GRID-PCS-4YR	NVIDIA GRID Software Subscription - VDI PC 1CCU - 4 Year
NV-GRID-PCS-5YR	NVIDIA GRID Software Subscription - VDI PC 1CCU - 5 Year
NV-GRID-VAS-1YR	NVIDIA GRID Software Subscription - VDI Apps 1CCU - 1 Year
NV-GRID-VAS-3YR	NVIDIA GRID Software Subscription - VDI Apps 1CCU - 3 Year
NV-GRID-VAS-4YR	NVIDIA GRID Software Subscription - VDI Apps 1CCU - 4 Year

Table 17 NVIDIA GPU Licenses *(continued)*

Product ID (PID)	PID Description
NV-GRID-VAS-5YR	NVIDIA GRID Software Subscription - VDI Apps 1CCU - 5 Year
NV-GRID-EDS-1YR	EDU - NVIDIA Quadro vDWS SW Subscription - 1CCU - 1 Year
NV-GRID-EDS-3YR	EDU - NVIDIA Quadro vDWS SW Subscription - 1CCU - 3 Year
NV-GRID-EDS-4YR	EDU - NVIDIA Quadro vDWS SW Subscription - 1CCU - 4 Year
NV-GRID-EDS-5YR	EDU - NVIDIA Quadro vDWS SW Subscription - 1CCU - 5 Year

STEP 10 ORDER POWER SUPPLY

Power supplies share a common electrical and physical design that allows for hot-plug and tool-less installation into M6 C-series servers. Each power supply is certified for high-efficiency operation and offer multiple power output options. This allows users to “right-size” based on server configuration, which improves power efficiency, lower overall energy costs and avoid stranded capacity in the data center. Use the power calculator at the following link to determine the needed power based on the options chosen (CPUs, drives, memory, and so on):

<http://ucspowercalc.cisco.com>



WARNING: Starting 1st January 2024, only Titanium rated PSUs are allowed to be shipped to European Union (EU), European Economic Area (EEA), United Kingdom (UK), Switzerland and other countries that adopted Lot 9 Regulation.

Table 18 Power Supply

Product ID (PID)	PID Description
PSU (Input High Line 210VAC)	
UCSC-PSU1-1050W	UCS 1050W AC PSU Platinum (Not EU/UK Lot 9 Compliant)
UCSC-PSUV2-1050DC	Cisco UCS 1050W -48V DC Power Supply for Rack Server Requires cable CAB-48DC-40A-8AWG
UCSC-PSU1-1600W	UCS 1600W AC PSU Platinum (Not EU/UK Lot 9 Compliant)
UCSC-PSU1-2300W ¹	2300W Power supply for C-series servers Titanium
UCSC-PSU1-1050WST	UCS 1050W AC PSU Platinum (Not EU/UK Lot 9 Compliant)
UCSC-PSU1-1200W	1200W Titanium power supply for C-Series Servers
UCSC-PSU1-1600WST	UCS 1600W AC PSU Platinum (Not EU/UK Lot 9 Compliant)
UCSC-PSU1-2300WST	Cisco UCS 2300W AC Power Supply for Rack Servers Titanium
PSU (Input Low Line 110VAC)	
UCSC-PSU1-1050W	UCS 1050W AC PSU Platinum (Not EU/UK Lot 9 Compliant)
UCSC-PSUV2-1050DC	Cisco UCS 1050W -48V DC Power Supply for Rack Server Requires cable CAB-48DC-40A-8AWG
UCSC-PSU1-1200W	1200W Titanium power supply for C-Series Servers
UCSC-PSU1-2300W	2300W Power supply for C-series servers Titanium
UCSC-PSU1-1050WST	UCS 1050W AC PSU Platinum (Not EU/UK Lot 9 Compliant)

Notes:

1. The 2300 W power supply uses a different power connector than the rest of the power supplies, so you must use different power cables to connect it. See [Table 19 on page 41](#) and [Table 20 on page 44](#).



NOTE:

- In a server with two power supplies, both power supplies must be identical.
- DC PSUs are not impacted by Lot 9 Regulation and are EU/UK Lot 9 compliant

STEP 11 SELECT INPUT POWER CORD(S)

Using [Table 19](#) and [Table 20](#), select the appropriate AC power cords. You can select a minimum of no power cords and a maximum of two. If you select the option R2XX-DMYPWRCORD, no power cord is shipped with the server.



NOTE: [Table 19](#) lists the power cords for servers that use power supplies less than 2300 W. [Table 20](#) lists the power cords for servers that use 2300 W power supplies. Note that the power cords for 2300 W power supplies use a C19 connector so they only fit the 2300 W power supply connector.

Table 19 Available Power Cords (for server PSUs less than 2300 W)

Product ID (PID)	PID Description	Images
NO-POWER-CORD	ECO friendly green option, no power cable will be shipped	
R2XX-DMYPWRCORD	No power cord (dummy PID to allow for a no power cord option)	Not applicable
CAB-48DC-40A-8AWG	C-Series -48VDC PSU Power Cord, 3.5M, 3 Wire, 8AWG, 40A	<p>Figure 1-3 CAB-48DC-40A-8AWG, DC Power Cord (3.5 m)</p>
CAB-N5K6A-NA	Power Cord, 200/240V 6A, North America	
CAB-AC-L620-C13	AC Power Cord, NEMA L6-20 - C13, 2M/6.5ft	
CAB-C13-CBN	CABASY,WIRE,JUMPER CORD, 27" L, C13/C14, 10A/250V	
CAB-C13-C14-2M	CABASY,WIRE,JUMPER CORD, PWR, 2 Meter, C13/C14,10A/250V	

Table 19 Available Power Cords (for server PSUs less than 2300 W)

Product ID (PID)	PID Description	Images
CAB-C13-C14-AC	CORD,PWR,JMP,IEC60320/C14,IEC60320/C13, 3.0M	
CAB-250V-10A-AR	Power Cord, 250V, 10A, Argentina	
CAB-9K10A-AU	Power Cord, 250VAC 10A 3112 Plug, Australia	
CAB-250V-10A-CN	AC Power Cord - 250V, 10A - PRC	
CAB-9K10A-EU	Power Cord, 250VAC 10A CEE 7/7 Plug, EU	
CAB-250V-10A-ID	Power Cord, 250V, 10A, India	
CAB-C13-C14-3M-IN	Power Cord Jumper, C13-C14 Connectors, 3 Meter Length, India	Image not available
CAB-C13-C14-IN	Power Cord Jumper,C13-C14 Connectors,1.4 Meter Length, India	Image not available
CAB-250V-10A-IS	Power Cord, SFS, 250V, 10A, Israel	

Table 19 Available Power Cords (for server PSUs less than 2300 W)

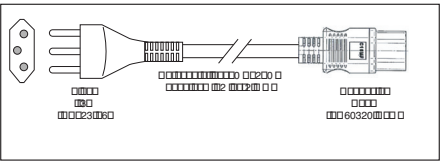
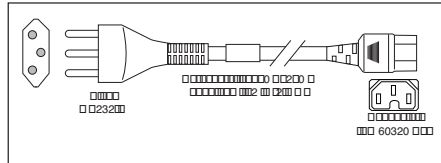
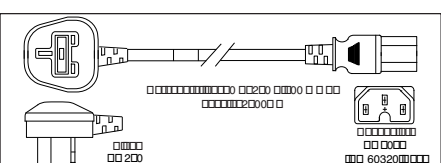
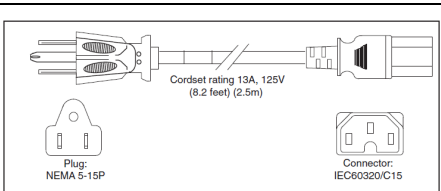
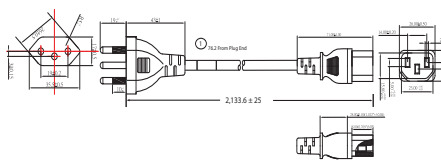
Product ID (PID)	PID Description	Images
CAB-9K10A-IT	Power Cord, 250VAC 10A CEI 23-16/VII Plug, Italy	
CAB-9K10A-SW	Power Cord, 250VAC 10A MP232 Plug, Switzerland	
CAB-9K10A-UK	Power Cord, 250VAC 10A BS1363 Plug (13 A fuse), UK	
CAB-9K12A-NA ¹	Power Cord, 125VAC 13A NEMA 5-15 Plug, North America	
CAB-250V-10A-BR	Power Cord - 250V, 10A - Brazil	
CAB-C13-C14-2M-JP	Power Cord C13-C14, 2M/6.5ft Japan PSE mark	Image not available
CAB-9K10A-KOR ¹	Power Cord, 125VAC 13A KSC8305 Plug, Korea	Image not available
CAB-ACTW	AC Power Cord (Taiwan), C13, EL 302, 2.3M	Image not available
CAB-JPN-3PIN	Japan, 90-125VAC 12A NEMA 5-15 Plug, 2.4m	Image not available

Notes:

1. This power cord is rated to 125V and only supported for PSU rated at 1050W or less

Table 20 Available Power Cords (for servers with 2300 W PSUs)

Product ID (PID)	PID Description	Images
CAB-C19-CBN	Cabinet Jumper Power Cord, 250 VAC 16A, C20-C19 Connectors	Not applicable
CAB-S132-C19-ISRL	S132 to IEC-C19 14ft Israeli	Image not available
CAB-IR2073-C19-AR	IRSM 2073 to IEC-C19 14ft Argen	Image not available
CAB-BS1363-C19-UK	BS-1363 to IEC-C19 14ft UK	Image not available
CAB-SABS-C19-IND	SABS 164-1 to IEC-C19 India	Image not available
CAB-C2316-C19-IT	CEI 23-16 to IEC-C19 14ft Italy	Image not available
CAB-L520P-C19-US	NEMA L5-20 to IEC-C19 6ft US	Image not available
CAB-US515P-C19-US	NEMA 5-15 to IEC-C19 13ft US	Image not available
CAB-US520-C19-US	NEMA 5-20 to IEC-C19 14ft US	Image not available
CAB-US620P-C19-US	NEMA 6-20 to IEC-C19 13ft US	Image not available

STEP 12 ORDER TOOL-LESS RAIL KIT AND OPTIONAL REVERSIBLE CABLE MANAGEMENT ARM

Select a Tool-less Rail Kit

Select a tool-less rail kit (or no rail kit) from [Table 21](#).

Table 21 Tool-less Rail Kit Options

Product ID (PID)	PID Description
UCSC-RAIL-M6	Ball bearing rail kit
UCSC-RAIL-NONE	No rail kit option



NOTE: Cisco recommends a minimum quantity of 1 Rail Kit.

Select an Optional Reversible Cable Management Arm

The reversible cable management arm mounts on either the right or left slide rails at the rear of the server and is used for cable management. Use [Table 22](#) to order a cable management arm.

Table 22 Cable Management Arm

Product ID (PID)	PID Description
UCSC-CMA-C240M6	Reversible CMA for ball bearing rail kit

For more information about the tool-less rail kit and cable management arm, see the *Cisco UCS C245 M6 Installation and Service Guide* at this URL:

https://www.cisco.com/content/en/us/td/docs/unified_computing/ucs/c/hw/c245m6/install/c245m6.html



NOTE: If you plan to rackmount your UCS C245 M6 server, you must order a tool-less rail kit. The same rail kits and CMAs are used for M5 and M6 servers.

STEP 13 SELECT MANAGEMENT CONFIGURATION (OPTIONAL)

By default, the C245 M6 server NIC mode is configured to be Shared LOM Extended. This NIC mode allows any LOM port or adapter card port to be used to access the Cisco Integrated Management Controller (CIMC). The Cisco VIC card must be installed in a slot with NCSI support.

To change the default NIC mode to Cisco Card Mode, select the UCSC-CCARD-01 PID shown in [Table 23](#). In this mode, you can assign an IP address to the CIMC using DHCP and from there you can fully automate your deployment.

For more details on all the NIC mode settings, see

https://www.cisco.com/c/en/us/td/docs/unified_computing/ucs/c/hw/c225m6/install/c225m6/m_maintaining-the-server.html#Cisco_Concept.dita_cbad6f92-209d-4d56-986a-bbbc7ae6ba44

Table 23 Management Configuration Ordering Information

	PID Description
UCSC-CCARD-01	Cisco Card Mode BIOS setting for C-Series Servers
UCSC-DLOM-01	Dedicated LOM Mode BIOS setting for C-Series Servers



NOTE: If OCP PID UCSC-O-ID10GC is selected then must also select VIC PID (UCSC-PCIE-C100-04, UCSC-PCIE-C25Q-04)

STEP 14 ORDER SECURITY DEVICES (OPTIONAL)

A Trusted Platform Module (TPM) is a computer chip (microcontroller) that can securely store artifacts used to authenticate the platform (server). These artifacts can include passwords, certificates, or encryption keys. A TPM can also be used to store platform measurements that help ensure that the platform remains trustworthy. Authentication (ensuring that the platform can prove that it is what it claims to be) and attestation (a process helping to prove that a platform is trustworthy and has not been breached) are necessary steps to ensure safer computing in all environments.

A chassis intrusion switch gives a notification of any unauthorized mechanical access into the server.

The security device ordering information is listed in [Table 24](#).

Table 24 Security Devices

Product ID (PID)	PID Description
UCSX-TPM2-002B-C	Trusted Platform Module 2.0 UCS servers (FIPS 140-2 Compliant)
UCSC-INT-SW02	Chassis Intrusion Switch
UCSX-TPM-OPT-OUT	OPT OUT, TPM 2.0, TCG, FIPS140-2, CC EAL4+ Certified ¹

Notes:

1. Please note that Microsoft certification requires a TPM 2.0 for bare-metal or guest VM deployments. Opt-out of the TPM 2.0 voids the Microsoft certification



NOTE:

- The TPM module used in this system conforms to TPM v2.0, as defined by the Trusted Computing Group (TCG). It is also SPI-based.
- TPM installation is supported after-factory. However, a TPM installs with a one-way screw and cannot be replaced, upgraded, or moved to another server. If a server with a TPM is returned, the replacement server must be ordered with a new TPM.

STEP 15 SELECT LOCKING SECURITY BEZEL (OPTIONAL)

An optional locking bezel can be mounted to the front of the chassis to prevent unauthorized access to the drives.

Select the locking bezel from [Table 25](#).

Table 25 Locking Bezel Option

Product ID (PID)	Description
UCSC-BZL-C240M5	Security Bezel

STEP 16 ORDER M.2 SATA SSDs (OPTIONAL)

Order one or two matching M.2 SATA SSDs (see [Table 26](#)) along with a boot-optimized RAID controller (see [Table 27](#)). See [Figure 5 on page 66](#) for the location of the extender board connector on the motherboard. The motherboard extender board connector accepts the extender board and the extender board accepts the boot-optimized RAID controller.

Each boot-optimized RAID controller can accommodate up to two SATA M.2 SSDs shown in [Table 26](#). Order one or two M.2 SATA SSDs from [Table 26](#)



NOTE: It is recommended that M.2 SATA SSDs be used as boot-only devices.

Table 26 M.2 SATA SSDs

Product ID (PID)	PID Description
UCS-M2-I240GB	240GB SATA M.2 SSD
UCS-M2-I480GB	480GB SATA M.2 SSD
UCS-M2-240G	240GB SATA M.2
UCS-M2-480G	480GB M.2 SATA SSD
UCS-M2-960G	960GB SATA M.2

Order the Boot-Optimized RAID controller from [Table 27](#). The Boot-Optimized RAID controller plugs into the extender board and holds up to two M.2 SATA drives.



NOTE: The Boot-Optimized RAID controller supports VMWare, Windows and Linux Operating Systems

Table 27 Boot-Optimized RAID Controller

Product ID (PID)	PID Description
UCS-M2-HWRAID	Cisco Boot optimized M.2 RAID controller (holds up to two M.2 SATA SSDs)



NOTE:

- The UCS-M2-HWRAID boot-optimized RAID controller supports RAID 1 and JBOD mode
- (CIMC/UCSM) is supported for configuring of volumes and monitoring of the controller and installed SATA M.2 drives
- The minimum version of Cisco IMC and Cisco UCS Manager that support this controller is 4.2(1) and later. The name of the controller in the software is MSTOR-RAID
- The SATA M.2 drives can boot in UEFI mode only. Legacy boot mode is not supported
- Hot-plug replacement is not supported. The server must be powered off.

Caveats

- Order one or two identical M.2 SATA SSDs for the boot-optimized RAID controller. You cannot mix M.2 SATA SSD capacities.

STEP 17 SELECT OPERATING SYSTEM AND VALUE-ADDED SOFTWARE



NOTE: See this link for operating system guidance:
<https://ucshcltool.cloudapps.cisco.com/public/>

Select

- OEM Software ([Table 28](#))
- Operating System ([Table 29](#))
- NVIDIA GPU Licenses ([Table 17 on page 38](#))

Table 28 OEM Software

Product ID (PID)	PID Description
VMware vCenter	
VMW-VCS-STD-1A	VMware vCenter 6 Server Standard, 1 yr support required
VMW-VCS-STD-3A	VMware vCenter 6 Server Standard, 3 yr support required
VMW-VCS-STD-5A	VMware vCenter 6 Server Standard, 5 yr support required
VMW-VCS-FND-1A	VMware vCenter 6 Server Foundation (4 Host), 1 yr supp reqd
VMW-VCS-FND-3A	VMware vCenter 6 Server Foundation (4 Host), 3 yr supp reqd
VMW-VCS-FND-5A	VMware vCenter 6 Server Foundation (4 Host), 5 yr supp reqd

Table 29 Operating System

Product ID (PID)	PID Description
Microsoft Windows Server	
MSWS-19-DC16C	Windows Server 2019 Data Center (16 Cores/Unlimited VMs)
MSWS-19-DC16C-NS	Windows Server 2019 DC (16 Cores/Unlim VMs) - No Cisco SVC
MSWS-19-ST16C	Windows Server 2019 Standard (16 Cores/2 VMs)
MSWS-19-ST16C-NS	Windows Server 2019 Standard (16 Cores/2 VMs) - No Cisco SVC
MSWS-22-DC16C	Windows Server 2022 Data Center (16 Cores/Unlimited VMs)
MSWS-22-DC16C-NS	Windows Server 2022 DC (16 Cores/Unlim VMs) - No Cisco SVC
MSWS-22-DCA2C	Windows Server 2022 Data Center - Additional 2 Cores

Table 29 Operating System (continued)

Product ID (PID)	PID Description
MSWS-22-DCA2C-NS	Windows Server 2022 DC - Additional 2 Cores - No Cisco SVC
MSWS-22-ST16C	Windows Server 2022 Standard (16 Cores/2 VMs)
MSWS-22-ST16C-NS	Windows Server 2022 Standard (16 Cores/2 VMs) - No Cisco SVC
MSWS-22-STA2C	Windows Server 2022 Standard - Additional 2 Cores
MSWS-22-STA2C-NS	Windows Server 2022 Stan - Additional 2 Cores - No Cisco SVC
Red Hat	
RHEL-2S2V-1A	Red Hat Enterprise Linux (1-2 CPU,1-2 VN); 1-Yr Support Req
RHEL-2S2V-3A	Red Hat Enterprise Linux (1-2 CPU,1-2 VN); 3-Yr Support Req
RHEL-2S2V-5A	Red Hat Enterprise Linux (1-2 CPU,1-2 VN); 5-Yr Support Req
RHEL-VDC-2SUV-1A	RHEL for Virt Datacenters (1-2 CPU, Unlim VN) 1 Yr Supp Req
RHEL-VDC-2SUV-3A	RHEL for Virt Datacenters (1-2 CPU, Unlim VN) 3 Yr Supp Req
RHEL-VDC-2SUV-5A	RHEL for Virt Datacenters (1-2 CPU, Unlim VN) 5 Yr Supp Req
Red Hat Ent Linux/ High Avail/ Res Strg/ Scal	
RHEL-2S2V-1S	Red Hat Enterprise Linux (1-2 CPU,1-2 VN); Prem 1-Yr SnS
RHEL-2S2V-3S	Red Hat Enterprise Linux (1-2 CPU,1-2 VN); Prem 3-Yr SnS
RHEL-2S-HA-1S	RHEL High Availability (1-2 CPU); Premium 1-yr SnS
RHEL-2S-HA-3S	RHEL High Availability (1-2 CPU); Premium 3-yr SnS
RHEL-2S-RS-1S	RHEL Resilient Storage (1-2 CPU); Premium 1-yr SnS
RHEL-2S-RS-3S	RHEL Resilient Storage (1-2 CPU); Premium 3-yr SnS
RHEL-VDC-2SUV-1S	RHEL for Virt Datacenters (1-2 CPU, Unlim VN) 1 Yr SnS Reqd
RHEL-VDC-2SUV-3S	RHEL for Virt Datacenters (1-2 CPU, Unlim VN) 3 Yr SnS Reqd
Red Hat SAP	
RHEL-SAP-2S2V-1S	RHEL for SAP Apps (1-2 CPU, 1-2 VN); Prem 1-Yr SnS
RHEL-SAP-2S2V-3S	RHEL for SAP Apps (1-2 CPU, 1-2 VN); Prem 3-Yr SnS
VMware	
VMW-VSP-STD-1A	VMware vSphere 6 Standard (1 CPU), 1-yr, Support Required
VMW-VSP-STD-3A	VMware vSphere 6 Standard (1 CPU), 3-yr, Support Required
VMW-VSP-STD-5A	VMware vSphere 6 Standard (1 CPU), 5-yr, Support Required
VMW-VSP-EPL-3A	VMware vSphere 6 Ent Plus (1 CPU), 3-yr, Support Required

Table 29 Operating System (continued)

Product ID (PID)	PID Description
VMW-VSP-EPL-1A	VMware vSphere 6 Ent Plus (1 CPU), 1-yr, Support Required
VMW-VSP-EPL-5A	VMware vSphere 6 Ent Plus (1 CPU), 5-yr, Support Required
SUSE	
SLES-2S2V-1A	SUSE Linux Enterprise Svr (1-2 CPU,1-2 VM); 1-Yr Support Req
SLES-2S2V-3A	SUSE Linux Enterprise Svr (1-2 CPU,1-2 VM); 3-Yr Support Req
SLES-2S2V-5A	SUSE Linux Enterprise Svr (1-2 CPU,1-2 VM); 5-Yr Support Req
SLES-2S2V-1S	SUSE Linux Enterprise Svr (1-2 CPU,1-2 VM); Prio 1-Yr SnS
SLES-2S2V-3S	SUSE Linux Enterprise Svr (1-2 CPU,1-2 VM); Prio 3-Yr SnS
SLES-2S2V-5S	SUSE Linux Enterprise Svr (1-2 CPU,1-2 VM); Prio 5-Yr SnS
SLES-2S-HA-1S	SUSE Linux High Availability Ext (1-2 CPU); 1yr SnS
SLES-2S-HA-3S	SUSE Linux High Availability Ext (1-2 CPU); 3yr SnS
SLES-2S-HA-5S	SUSE Linux High Availability Ext (1-2 CPU); 5yr SnS
SLES-2S-GC-1S	SUSE Linux GEO Clustering for HA (1-2 CPU); 1yr Sns
SLES-2S-GC-3S	SUSE Linux GEO Clustering for HA (1-2 CPU); 3yr SnS
SLES-2S-GC-5S	SUSE Linux GEO Clustering for HA (1-2 CPU); 5yr SnS
SLES-2S-LP-1S	SUSE Linux Live Patching Add-on (1-2 CPU); 1yr SnS Required
SLES-2S-LP-3S	SUSE Linux Live Patching Add-on (1-2 CPU); 3yr SnS Required
SLES-2S-LP-1A	SUSE Linux Live Patching Add-on (1-2 CPU); 1yr Support Req
SLES-2S-LP-3A	SUSE Linux Live Patching Add-on (1-2 CPU); 3yr Support Req
SLES-2SUVM-1A	SUSE Linux Enterprise Svr (1-2 CPU,Unl VM) LP; 1Y Supp Req
SLES-2SUVM-1S	SUSE Linux Enterprise Svr (1-2 CPU,Unl VM) LP; Prio 1Y SnS
SLES-2SUVM-1YR	SUSE Linux Entp Svr (1-2 CPU,Unl VM) LP; Prio SnS 24x7 - 1Y
SLES-2SUVM-3A	SUSE Linux Enterprise Svr (1-2 CPU,Unl VM) LP; 3Y Supp Req
SLES-2SUVM-3S	SUSE Linux Enterprise Svr (1-2 CPU,Unl VM) LP; Prio 3Y SnS
SLES-2SUVM-3YR	SUSE Linux Entp Svr (1-2 CPU,Unl VM) LP; Prio SnS 24x7 - 3Y
SLES-2SUVM-5A	SUSE Linux Enterprise Svr (1-2 CPU,Unl VM) LP; 5Y Supp Req
SLES-2SUVM-5S	SUSE Linux Enterprise Svr (1-2 CPU,Unl VM) LP; Prio 5Y SnS
SLES-2SUVM-5YR	SUSE Linux Entp Svr (1-2 CPU,Unl VM) LP; Prio SnS 24x7 - 5Y
SLES-SAP2SUVM-1A	SLES for SAP Apps w/ HA (1-2 CPU, Unl VM) LP; 1Y Supp Req

Table 29 Operating System (continued)

Product ID (PID)	PID Description
SLES-SAP2SUVM-1S	SLES for SAP Apps (1-2 CPU, Unl VM) LP; Priority 1Y SnS
SLES-SAP2SUVM-1YR	SUSE for SAP Apps; (1-2 CPU,Unl VM) LP; Prio SnS 24x7 - 1Y
SLES-SAP2SUVM-3A	SLES for SAP Apps w/ HA (1-2 CPU, Unl VM) LP; 3Y Supp Reqd
SLES-SAP2SUVM-3S	SLES for SAP Apps (1-2 CPU, Unl VM) LP; Priority 3Y SnS
SLES-SAP2SUVM-3YR	SUSE for SAP Apps; (1-2 CPU,Unl VM) LP; Prio SnS 24x7 - 3Y
SLES-SAP2SUVM-5A	SLES for SAP Apps w/ HA (1-2 CPU, Unl VM) LP; 5Y Supp Reqd
SLES-SAP2SUVM-5S	SLES for SAP Apps (1-2 CPU, Unl VM) LP; Priority 5Y SnS
SLES-SAP2SUVM-5YR	SUSE for SAP Apps; (1-2 CPU,Unl VM) LP; Prio SnS 24x7 - 5Y
SLES and SAP	
SLES-SAP-2S2V-1A	SLES for SAP Apps (1-2 CPU, 1-2 VM); 1-Yr Support Reqd
SLES-SAP-2S2V-3A	SLES for SAP Apps (1-2 CPU, 1-2 VM); 3-Yr Support Reqd
SLES-SAP-2S2V-5A	SLES for SAP Apps (1-2 CPU, 1-2 VM); 5-Yr Support Reqd
SLES-SAP-2S2V-1S	SLES for SAP Apps (1-2 CPU, 1-2 VM); Priority 1-Yr SnS
SLES-SAP-2S2V-3S	SLES for SAP Apps (1-2 CPU, 1-2 VM); Priority 3-Yr SnS
SLES-SAP-2S2V-5S	SLES for SAP Apps (1-2 CPU, 1-2 VM); Priority 5-Yr SnS

STEP 18 SELECT OPERATING SYSTEM MEDIA KIT

Select the optional operating system media listed in [Table 30](#).

Table 30 OS Media

Product ID (PID)	PID Description
MSWS-19-ST16C-RM	Windows Server 2019 Stan (16 Cores/2 VMs) Rec Media DVD Only
MSWS-19-DC16C-RM	Windows Server 2019 DC (16Cores/Unlim VM) Rec Media DVD Only
MSWS-22-ST16C-RM	Windows Server 2022 Stan (16 Cores/2 VMs) Rec Media DVD Only
MSWS-22-DC16C-RM	Windows Server 2022 DC (16Cores/Unlim VM) Rec Media DVD Only

STEP 19 SELECT SERVICE and SUPPORT LEVEL

A variety of service options are available, as described in this section.

Unified Computing Warranty, No Contract

If you have noncritical implementations and choose to have no service contract, the following coverage is supplied:

- Three-year parts coverage.
- Next business day (NBD) parts replacement eight hours a day, five days a week.
- 90-day software warranty on media.
- Ongoing downloads of BIOS, drivers, and firmware updates.
- UCSM updates for systems with Unified Computing System Manager. These updates include minor enhancements and bug fixes that are designed to maintain the compliance of UCSM with published specifications, release notes, and industry standards.

Smart Net Total Care (SNTC) for Cisco UCS

For support of the entire Unified Computing System, Cisco offers the Cisco Smart Net Total Care (SNTC) for UCS Service. This service provides expert software and hardware support to help sustain performance and high availability of the unified computing environment. Access to Cisco Technical Assistance Center (TAC) is provided around the clock, from anywhere in the world.

The Cisco Smart Net Total Care for UCS Service includes flexible hardware replacement options, including replacement in as little as two hours. There is also access to Cisco's extensive online technical resources to help maintain optimal efficiency and uptime of the unified computing environment. For more information please refer to the following URL:

<http://www.cisco.com/c/en/us/services/technical/smart-net-total-care.html?stickynav=1>

You can choose a desired service listed in [Table 31](#).

Table 31 Cisco SNTC for UCS Service (PID UCSC-C245-M6SX)

Service SKU	Service Level GSP	On Site?	Description
CON-PREM-UCSCC244	C2P	Yes	SNTC 24X7X20S
CON-UCSD8-UCSCC244	UCSD8	Yes	UC SUPP DR 24X7X20S*
CON-C2PL-UCSCC244	C2PL	Yes	LL 24X7X20S**
CON-OSP-UCSCC244	C4P	Yes	SNTC 24X7X40S
CON-UCSD7-UCSCC244	UCSD7	Yes	UCS DR 24X7X40S*
CON-C4PL-UCSCC244	C4PL	Yes	LL 24X7X40S**

Table 31 Cisco SNTC for UCS Service (PID UCSC-C245-M6SX) (continued)

Service SKU	Service Level GSP	On Site?	Description
CON-USD7L-UCSCC244	USD7L	Yes	LLUCS HW DR 24X7X40S***
CON-OSE-UCSCC244	C4S	Yes	SNTC 8X5X40S
CON-UCSD6-UCSCC244	UCSD6	Yes	UC SUPP DR 8X5X40S*
CON-SNCO-UCSCC244	SNCO	Yes	SNTC 8x7xNCDOS****
CON-OS-UCSCC244	CS	Yes	SNTC 8X5XNBDOS
CON-UCSD5-UCSCC244	UCSD5	Yes	UCS DR 8X5XNBDOS*
CON-S2P-UCSCC244	S2P	No	SNTC 24X7X2
CON-S2PL-UCSCC244	S2PL	No	LL 24X7X2**
CON-SNTP-UCSCC244	SNTP	No	SNTC 24X7X4
CON-SNTPL-UCSCC244	SNTPL	No	LL 24X7X4**
CON-SNTE-UCSCC244	SNTE	No	SNTC 8X5X4
CON-SNC-UCSCC244	SNC	No	SNTC 8x7xNCD
CON-SNT-UCSCC244	SNT	No	SNTC 8X5XNBD
CON-SW-UCSCC244	SW	No	SNTC NO RMA
Note: For PID UCSC-C245-M6SX-CH, select Service SKU with UCSCSC24 suffix (Example: CON-OSP-UCSCSC24)			
*Includes Drive Retention (see below for full description)			
**Includes Local Language Support (see below for full description) – Only available in China and Japan			
***Includes Local Language Support and Drive Retention – Only available in China and Japan			

Smart Net Total Care (SNTC) for Cisco UCS Onsite Troubleshooting Service

An enhanced offer over traditional Smart Net Total Care which provides onsite troubleshooting expertise to aid in the diagnostics and isolation of hardware issue within our customers' Cisco Unified Computing System (UCS) environment. It is delivered by a Cisco Certified field engineer (FE) in collaboration with remote TAC engineer and Virtual Internetworking Support Engineer (VISE). You can choose a desired service listed in [Table 32](#).

Table 32 SNTC for UCS Onsite Troubleshooting Service (PID UCSC-C245-M6SX)

Service SKU	Service Level GSP	On Site?	Description
CON-OSPT-UCSCC244	OSPT	Yes	24X7X40S Trblshtg
CON-OSPTD-UCSCC244	OSPTD	Yes	24X7X40S TrblshtgDR*
CON-OSPTL-UCSCC244	OSPTL	Yes	24X7X40S TrblshtgLL**
CON-OPTLD-UCSCC244	OPTLD	Yes	24X7X40S TrblshtgLLD***
Note: For PID UCSC-C245-M6SX-CH, select Service SKU with UCSCSC24 suffix (Example: CON-OSPT-UCSCSC24)			
For PID UCSC-C245-M6-CH, select Service SKU with UCSB2M6C suffix (Example: CON-OSPT-UCSB2M6C)			
*Includes Drive Retention (see below for full description)			
**Includes Local Language Support (see below for full description) – Only available in China and Japan			
***Includes Local Language Support and Drive Retention – Only available in China and Japan			

Solution Support (SSPT) for UCS

Solution Support includes both Cisco product support and solution-level support, resolving complex issues in multivendor environments, on average, 43% more quickly than product support alone. Solution Support is a critical element in data center administration, to help rapidly resolve any issue encountered, while maintaining performance, reliability, and return on investment.

This service centralizes support across your multivendor Cisco environment for both our products and solution partner products you’ve deployed in your ecosystem. Whether there is an issue with a Cisco or solution partner product, just call us. Our experts are the primary point of contact and own the case from first call to resolution. For more information please refer to the following URL:

<http://www.cisco.com/c/en/us/services/technical/solution-support.html?stickynav=1>

You can choose a desired service listed in [Table 33](#).

Table 33 Solution Support for UCS Service (PID UCSC-C245-M6SX)

Service SKU	Service Level GSP	On Site?	Description
CON-SSC2P-UCSCC244	SSC2P	Yes	SOLN SUPP 24X7X2OS
CON-SSC4P-UCSCC244	SSC4P	Yes	SOLN SUPP 24X7X4OS
CON-SSC4S-UCSCC244	SSC4S	Yes	SOLN SUPP 8X5X4OS
CON-SSCS-UCSCC244	SSCS	Yes	SOLN SUPP 8X5XNBDOS
CON-SSDR7-UCSCC244	SSDR7	Yes	SSPT DR 24X7X4OS*
CON-SSDR5-UCSCC244	SSDR5	Yes	SSPT DR 8X5XNBDOS*
CON-SSS2P-UCSCC244	SSS2P	No	SOLN SUPP 24X7X2
CON-SSSNP-UCSCC244	SSSNP	No	SOLN SUPP 24X7X4
CON-SSSNE-UCSCC244	SSSNE	No	SOLN SUPP 8X5X4
CON-SSSNC-UCSCC244	SSSNC	No	SOLN SUPP NCD
CON-SSSNT-UCSCC244	SSSNT	No	SOLN SUPP 8X5XNBD
Note: For PID UCSC-C245-M6SX-CH, select Service SKU with UCSCSC24 suffix (Example: CON-SSC4P-UCSCSC24)			
*Includes Drive Retention (see below for full description)			

Solution Support for Service Providers

You can choose a desired service listed in [Table 34](#).

Table 34 Solution Support for Service Providers UCS Service (PID UCSC-C245-M6SX)

Service SKU	Service Level GSP	On Site?	Description
SP-SSC2P-UCSCC244	SPSSC2P	Yes	SP SOLN SUPP 24X7X2OS
SP-SSC4P-UCSCC244	SPSSC4P	Yes	SP SOLN SUPP 24X7X4OS
SP-SSC4S-UCSCC244	SPSSC4S	Yes	SP SOLN SUPP 8X5X4OS
SP-SSCS-UCSCC244	SPSSCS	Yes	SP SOLN SUPP 8X5XNBDOS
SP-SSS2P-UCSCC244	SPSSS2P	Yes	SP SOLN SUPP 24X7X2
SP-SSS4P-UCSCC244	SPSSS4P	Yes	SP SOLN SUPP 24X7X4
SP-SSSNE-UCSCC244	SPSSSNE	No	SP SOLN SUPP 8X5X4
SP-SSSNT-UCSCC244	SPSSSNT	No	SP SOLN SUPP 8X5XNBD
SP-SSSPB-UCSCC244	SPSSPB	No	SP SOLN SUPP NO HW RPL
Note: For PID UCSC-C245-M6SX-CH, select Service SKU with UCSCSC24 suffix (Example: CON-SPSSC4P-UCSCSC24)			

Smart Net Total Care for UCS Hardware Only Service

For faster parts replacement than is provided with the standard Cisco Unified Computing System warranty, Cisco offers the Cisco Smart Net Total Care for UCS Hardware Only Service. You can choose from two levels of advanced onsite parts replacement coverage in as little as four hours. Smart Net Total Care for UCS Hardware Only Service provides remote access any time to Cisco support professionals who can determine if a return materials authorization (RMA) is required. You can choose a desired service listed in [Table 35](#).

Table 35 SNTC for UCS Hardware Only Service (PID UCSC-C245-M6SX)

Service SKU	Service Level GSP	On Site?	Description
CON-UCW7-UCSCC244	UCW7	Yes	UCS HW 24X7X4OS
CON-UCWD7-UCSCC244	UCWD7	Yes	UCS HW+DR 24X7X4OS*
CON-UCW7L-UCSCC244	UCW7L	Yes	LL UCS 24X7X4OS**
CON-UWD7L-UCSCC244	UWD7L	Yes	LL UCS DR 24X7X4OS***
CON-UCW5-UCSCC244	UCW5	Yes	UCS HW 8X5XNBDOS
CON-UCWD5-UCSCC244	UCWD5	Yes	UCS HW+DR 8X5XNBDOS*

Table 35 SNTC for UCS Hardware Only Service (PID UCSC-C245-M6SX) (continued)

Note: For PID UCSC-C245-M6SX-CH, select Service SKU with UCSCSC24 suffix (Example: CON-UCW7-UCSCSC24)
*Includes Drive Retention (see below for full description)
**Includes Local Language Support (see below for full description) – Only available in China and Japan
***Includes Local Language Support and Drive Retention – Only available in China and Japan

Partner Support Service for UCS

Cisco Partner Support Service (PSS) is a Cisco Collaborative Services service offering that is designed for partners to deliver their own branded support and managed services to enterprise customers. Cisco PSS provides partners with access to Cisco's support infrastructure and assets to help them:

- Expand their service portfolios to support the most complex network environments
- Lower delivery costs
- Deliver services that increase customer loyalty

PSS options enable eligible Cisco partners to develop and consistently deliver high-value technical support that capitalizes on Cisco intellectual assets. This helps partners to realize higher margins and expand their practice. PSS is available to all Cisco PSS partners. The two Partner Unified Computing Support Options include:

- Partner Support Service for UCS
- Partner Support Service for UCS Hardware Only

PSS for UCS provides hardware and software support, including triage support for third party software, backed by Cisco technical resources and level three support. You can choose a desired service listed in [Table 36](#).

Table 36 PSS for UCS Service (PID UCSC-C245-M6SX)

Service SKU	Service Level GSP	On Site?	Description
CON-PSJ8-UCSCC244	PSJ8	Yes	UCS PSS 24X7X2 OS
CON-PSJ7-UCSCC244	PSJ7	Yes	UCS PSS 24X7X4 OS
CON-PSJD7-UCSCC244	PSJD7	Yes	UCS PSS 24X7X4 DR*
CON-PSJ6-UCSCC244	PSJ6	Yes	UCS PSS 8X5X4 OS
CON-PSJD6-UCSCC244	PSJD6	Yes	UCS PSS 8X5X4 DR*
CON-PSJ4-UCSCC244	PSJ4	No	UCS SUPP PSS 24X7X2
CON-PSJ3-UCSCC244	PSJ3	No	UCS SUPP PSS 24X7X4
CON-PSJ2-UCSCC244	PSJ2	No	UCS SUPP PSS 8X5X4
CON-PSJ1-UCSCC244	PSJ1	No	UCS SUPP PSS 8X5XNBD

Table 36 PSS for UCS Service (PID UCSC-C245-M6SX) (continued)

Note: For PID UCSC-C245-M6SX-CH, select Service SKU with UCSCSC24 suffix (Example: CON-PSJ7-UCSCSC24)
*Includes Drive Retention (see below for full description)

PSS for UCS Hardware Only

PSS for UCS Hardware Only provides customers with replacement parts in as little as two hours and provides remote access any time to Partner Support professionals who can determine if a return materials authorization (RMA) is required. You can choose a desired service listed in [Table 37](#).

Table 37 PSS for UCS Hardware Only Service (PID UCSC-C245-M6SX)

Service SKU	Service Level GSP	On Site?	Description
CON-PSW7-UCSCC244	PSW7	Yes	UCS W PSS 24X7X4 OS
CON-PSWD7-UCSCC244	PSWD7	Yes	UCS W PSS 24X7X4 DR*
CON-PSW6-UCSCC244	PSW6	Yes	UCS W PSS 8X5X4 OS
CON-PSWD6-UCSCC244	PSWD6	Yes	UCS W PSS 8X5X4 DR*
CON-PSW4-UCSCC244	PSW4	No	UCS W PL PSS 24X7X2
CON-PSW3-UCSCC244	PSW3	No	UCS W PL PSS 24X7X4
CON-PSW2-UCSCC244	PSW2	No	UCS W PL PSS 8X5X4
Note: For PID UCSC-C245-M6SX-CH, select Service SKU with UCSCSC24 suffix (Example: CON-PSW7-UCSCSC24)			
*Includes Drive Retention (see below for full description)			

Distributor Support Service (DSS)

You can choose a desired service listed in [Table 38](#).

Table 38 DSS for UCS Service (PID UCSC-C245-M6SX)

Service SKU	Service Level GSP	On Site?	Description
CON-DSCO-UCSCC244	DSCO	Yes	DSS CORE 24X7X20S
CON-DSO-UCSCC244	DSO	Yes	DSS CORE 24X7X4
CON-DSNO-UCSCC244	DSNO	Yes	DSS CORE 8X5XNBDOS
CON-DSCC-UCSCC244	DSCC	No	DSS CORE 24X7X2
CON-DCP-UCSCC244	DCP	No	DSS CORE 24X7X4
CON-DSE-UCSCC244	DSE	No	DSS CORE 8X5X4
CON-DSN-UCSCC244	DSN	No	DSS CORE 8X5XNBD
Note: For PID UCSC-C245-M6SX-CH, select Service SKU with UCSCSC24 suffix (Example: CON-DSO-UCSCSC24)			

Unified Computing Combined Support Service

Combined Services makes it easier to purchase and manage required services under one contract. SNTC services for UCS help increase the availability of your vital data center infrastructure and realize the most value from your unified computing investment. The more benefits you realize from the Cisco Unified Computing System (Cisco UCS), the more important the technology becomes to your business. These services allow you to:

- Optimize the uptime, performance, and efficiency of your UCS
- Protect your vital business applications by rapidly identifying and addressing issues
- Strengthen in-house expertise through knowledge transfer and mentoring
- Improve operational efficiency by allowing UCS experts to augment your internal staff resources
- Enhance business agility by diagnosing potential issues before they affect your operations

You can choose a desired service listed [Table 39](#).

Table 39 Combined Support for UCS Service (PID UCSC-C245-M6SX)

Service SKU	Service Level GSP	On Site?	Description
CON-NCF2P-UCSCC244	NCF2P	Yes	CMB SVC 24X7X2OS
CON-NCF4P-UCSCC244	NCF4P	Yes	CMB SVC 24X7X4OS
CON-NCF4S-UCSCC244	NCF4S	Yes	CMB SVC 8X5X4OS
CON-NCFC5-UCSCC244	NCFC5	Yes	CMB SVC 8X5XNBDOS
CON-NCF2-UCSCC244	NCF2	No	CMB SVC 24X7X2
CON-NCFP-UCSCC244	NCFP	No	CMB SVC 24X7X4
CON-NCFE-UCSCC244	NCFE	No	CMB SVC 8X5X4
CON-NCFT-UCSCC244	NCFT	No	CMB SVC 8X5XNBD
CON-NCFW-UCSCC244	NCFW	No	CMB SVC SW
Note: For PID UCSC-C245-M6SX-CH, select Service SKU with UCSCSC24 suffix (Example: CON-NCF4P-UCSCSC24)			

UCS Drive Retention Service

With the Cisco Unified Computing Drive Retention Service, you can obtain a new disk drive in exchange for a faulty drive without returning the faulty drive.

Sophisticated data recovery techniques have made classified, proprietary, and confidential information vulnerable, even on malfunctioning disk drives. The Drive Retention service enables you to retain your drives and ensures that the sensitive data on those drives is not compromised, which reduces the risk of any potential liabilities. This service also enables you to comply with regulatory, local, and federal requirements.

If your company has a need to control confidential, classified, sensitive, or proprietary data, you might want to consider one of the Drive Retention Services listed in the above tables (where available).



NOTE: Cisco does not offer a certified drive destruction service as part of this service.

Local Language Technical Support for UCS

Where available, and subject to an additional fee, local language support for calls on all assigned severity levels may be available for specific product(s) - see tables above.

For a complete listing of available services for Cisco Unified Computing System, see the following URL:

http://www.cisco.com/en/US/products/ps10312/serv_group_home.html

SUPPLEMENTAL MATERIAL

Chassis

An internal view of the C245 M6 chassis with the top cover removed is shown in *Figure 5*.

Figure 5 C245 M6 Server With Top Cover Off

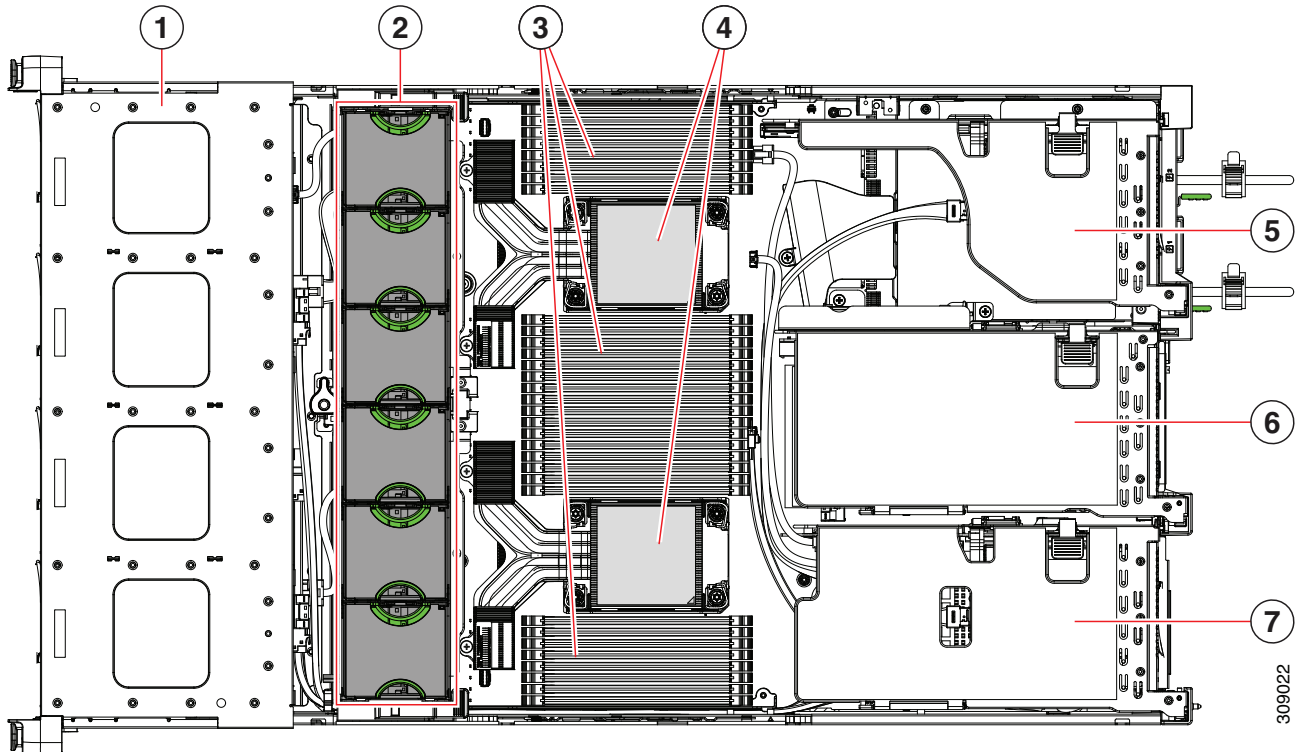

309022

1	Front-loading drive bays.	2	Cooling fan modules (six, hot-swappable)
3	DIMM sockets on motherboard (16 per CPU) An air baffle rests on top of the DIMMs and CPUs when the server is operating. The air baffle is not displayed in this illustration.	4	CPU sockets CPU 2 is at the top and CPU 1 is at the bottom.

<p>5</p>	<p>PCIe riser 3 (PCIe slots 7 and 8 numbered from bottom to top), with the following options:</p> <ul style="list-style-type: none"> ■ 3A (Default Option)—Slots 7 (x24 mechanical, x8 electrical), and 8 (x24 mechanical, x8 electrical). Both slots can accept a full height, full length GPU card. ■ 3B (Storage Option)—Slots 7 (x24 mechanical, x4 electrical) and 8 (x24 mechanical, x4 electrical). Both slots can accept 2.5-inch NVMe SSDs. ■ 3C (GPU Option)—Slots 7 (x24 mechanical, x16 electrical) and 8 empty (NCSI support limited to one slot at a time). Slot 7 can support a full height, full length, double-wide GPU card and 8 blocked by Double-wide GPU (not used) 	<p>6</p>	<p>PCIe riser 2 (PCIe slots 4, 5, 6 numbered from bottom to top), with the following options:</p> <ul style="list-style-type: none"> ■ 2A (Default Option)—Slot 4 (x24 mechanical, x8 electrical) supports full height, ¾ length card; Slot 5 (x24 mechanical, x16 electrical) supports full height, full length GPU card; Slot 6 (x24 mechanical, x8 electrical) supports full height, full length card.
<p>7</p>	<p>PCIe riser 1 (PCIe slot 1, 2, 3 numbered bottom to top), with the following options:</p> <ul style="list-style-type: none"> ■ 1A (Default Option)—Slot 1 (x24 mechanical, x8 electrical) supports full height, ¾ length card; Slot 2 (x24 mechanical, x16 electrical) supports full height, full length GPU card; Slot 3 (x24 mechanical, x8 electrical) supports full height, full length card. ■ 1B (Storage Option)—Slot 1 is reserved; Slot 2 (x4 electrical), supports 2.5-inch SFF NVMe SSDs; Slot 3 (x4 electrical), supports 2.5-inch SFF NVMe SSDs. 	<p>-</p>	

Riser Connector Locations on the Motherboard

Figure 6 shows the locations of the PCIe riser connectors on the C245 M6 SFF motherboard.

Figure 6 C245 M6 SFF Riser Connector Locations

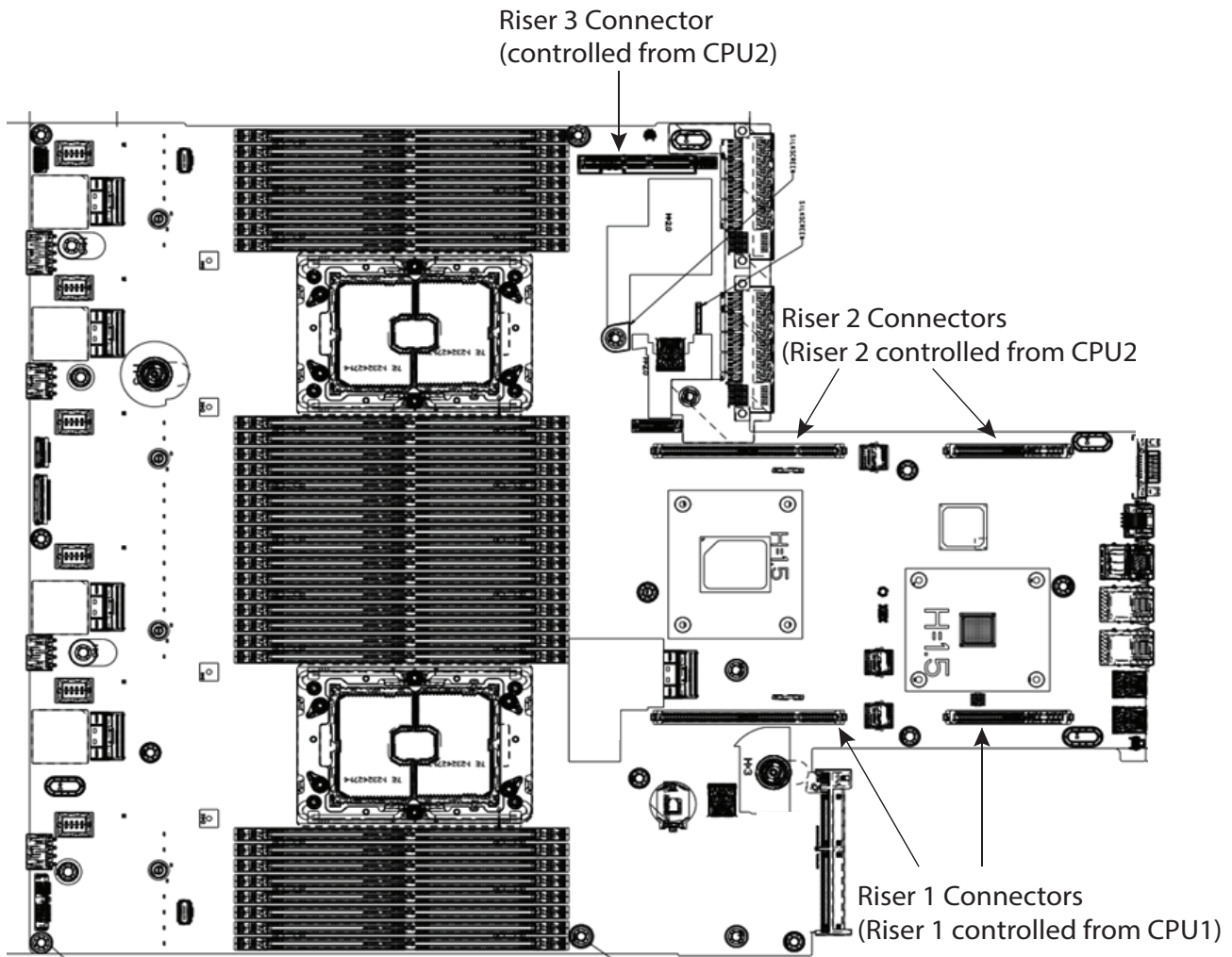
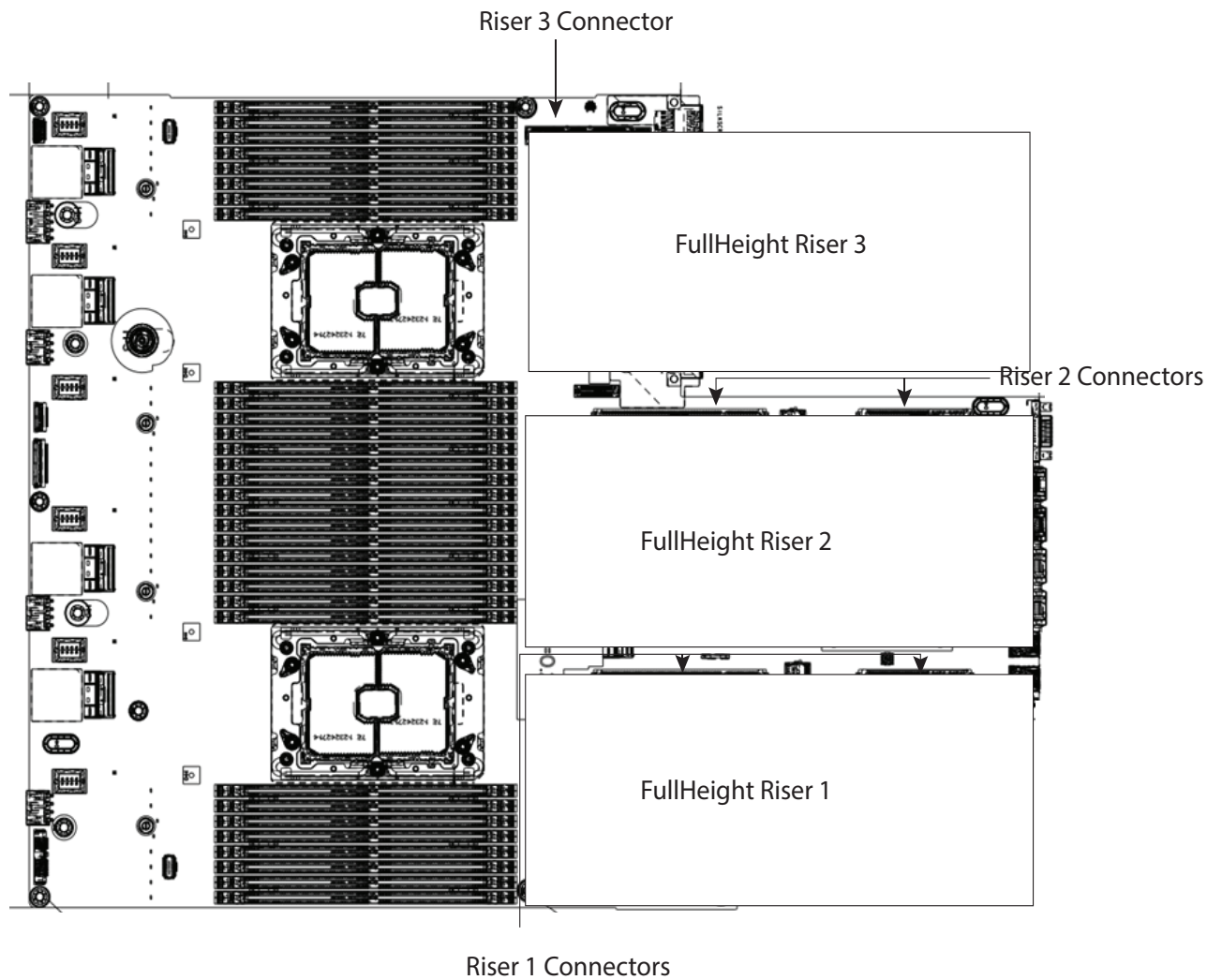

Figure 7 shows three full-height risers plugged into their respective connectors.

Figure 7 C245 M6 SFF With Three Full-Height Risers Plugged In



Riser Card Configurations and Options

The riser card locations are shown in [Figure 8](#).

Figure 8 Riser Card Locations

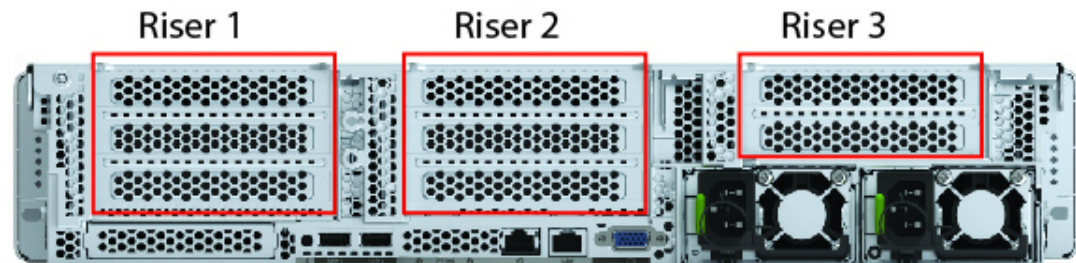

Riser 1A

Riser 1A mechanical information is shown in [Figure 9](#).

Figure 9 Riser Card 1A

PCIe Riser 1A (outside)

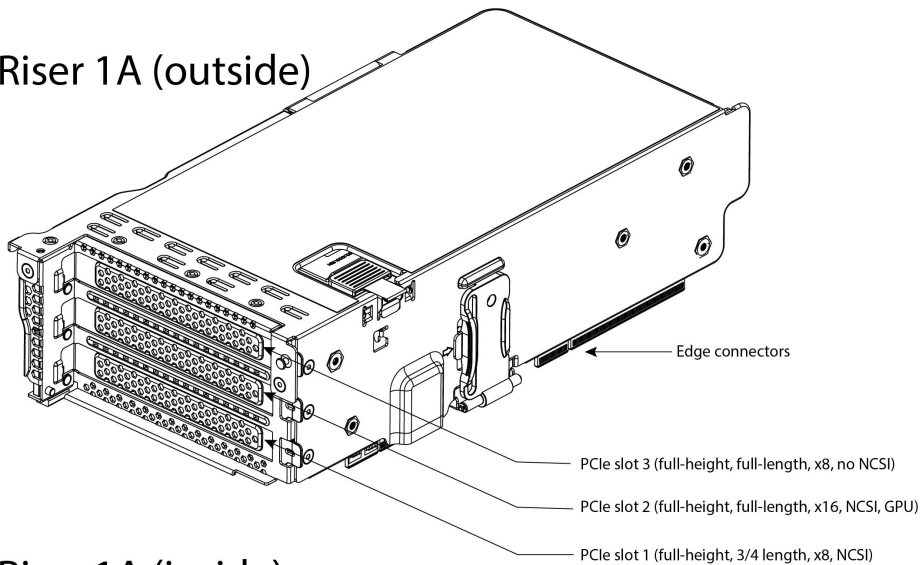

PCIe Riser 1A (inside)

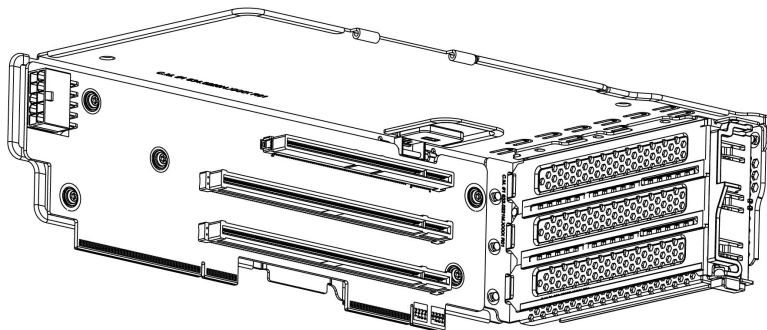

Riser 1B

Riser 1B mechanical information is shown in *Figure 10*.

Figure 10 Riser Card 1B

PCIe Riser 1B (outside)

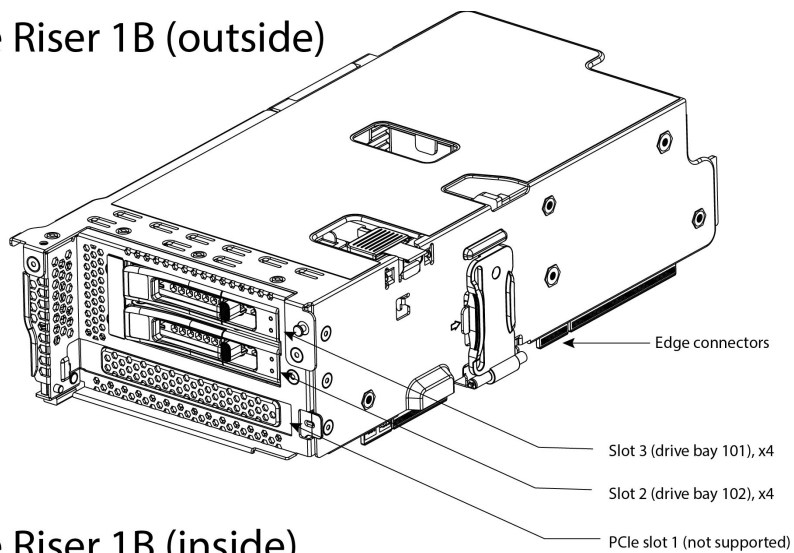

PCIe Riser 1B (inside)

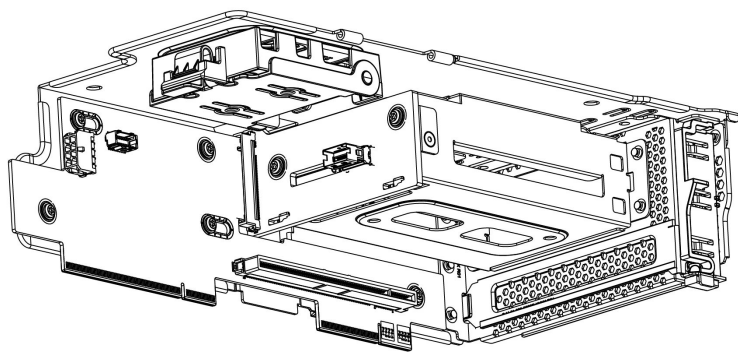

Riser 2A

Riser 2A mechanical information is shown in [Figure 11](#).

Figure 11 Riser Card 2A

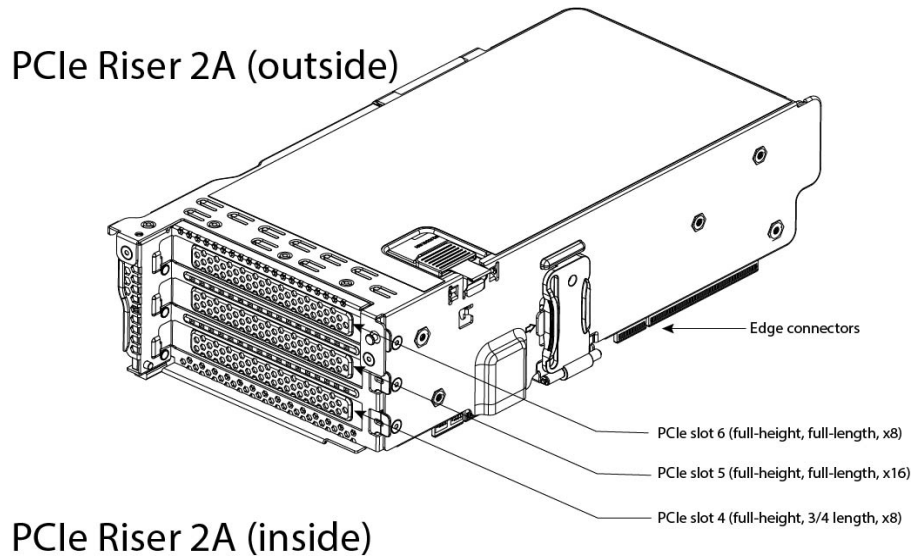

PCIe Riser 2A (inside)

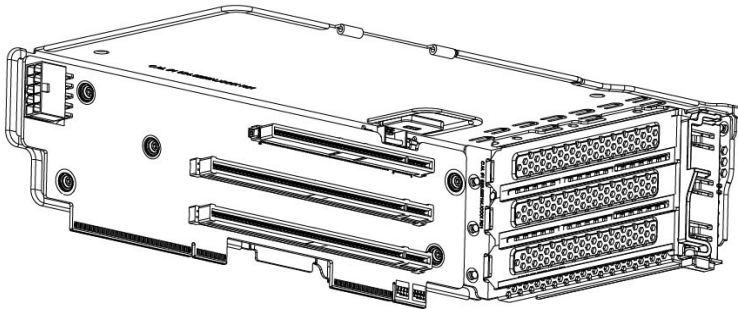

Riser 3A

Riser 3A mechanical information is shown in [Figure 12](#).

Figure 12 Riser Card 3A

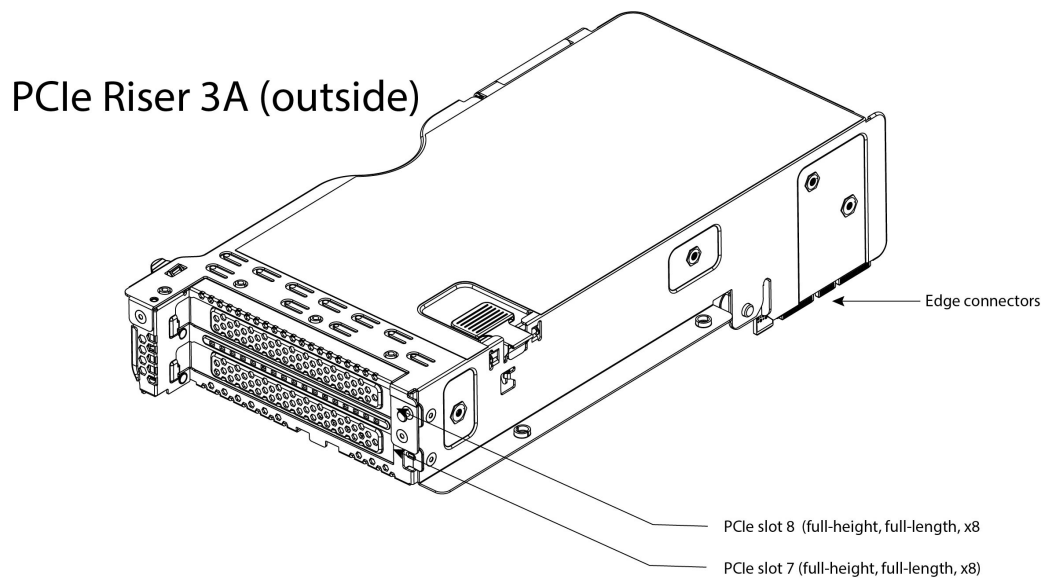

PCIe Riser 3A (inside)

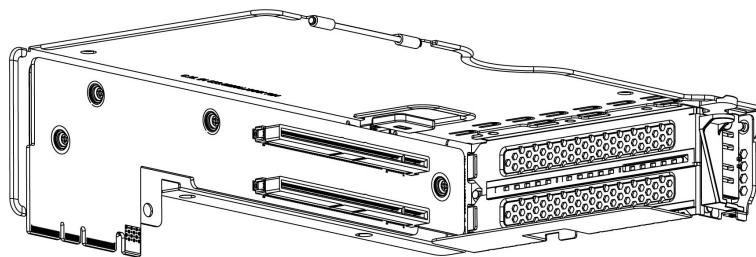

Riser 3B

Riser 3B mechanical information is shown in [Figure 13](#).

Figure 13 Riser Card 3B

PCIe Riser 3B (outside)

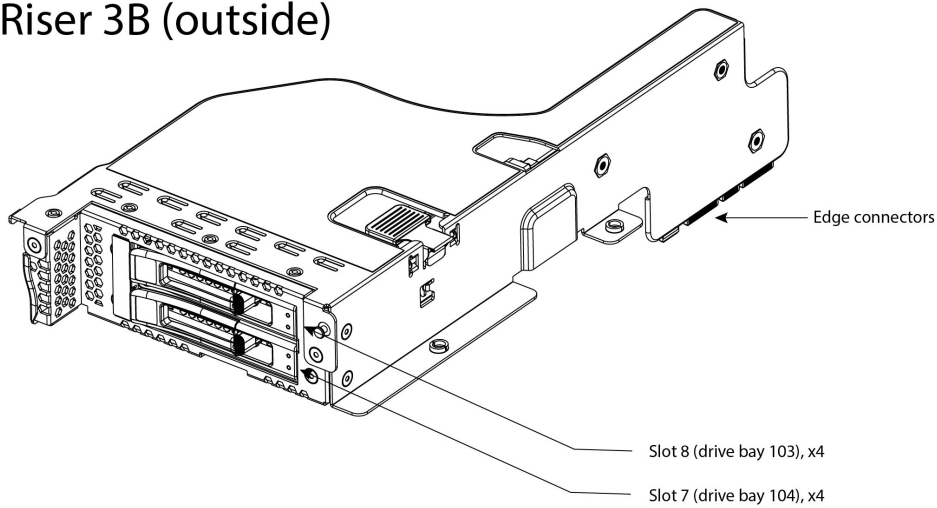

PCIe Riser 3B (inside)

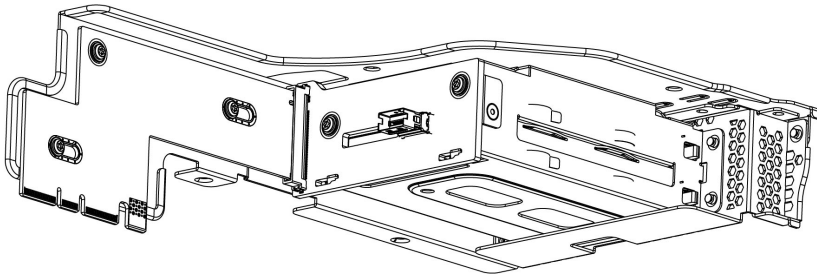

Riser 3C

Riser 3C mechanical information is shown in [Figure 14](#).

Figure 14 Riser Card 3C

PCIe Riser 3C (outside)

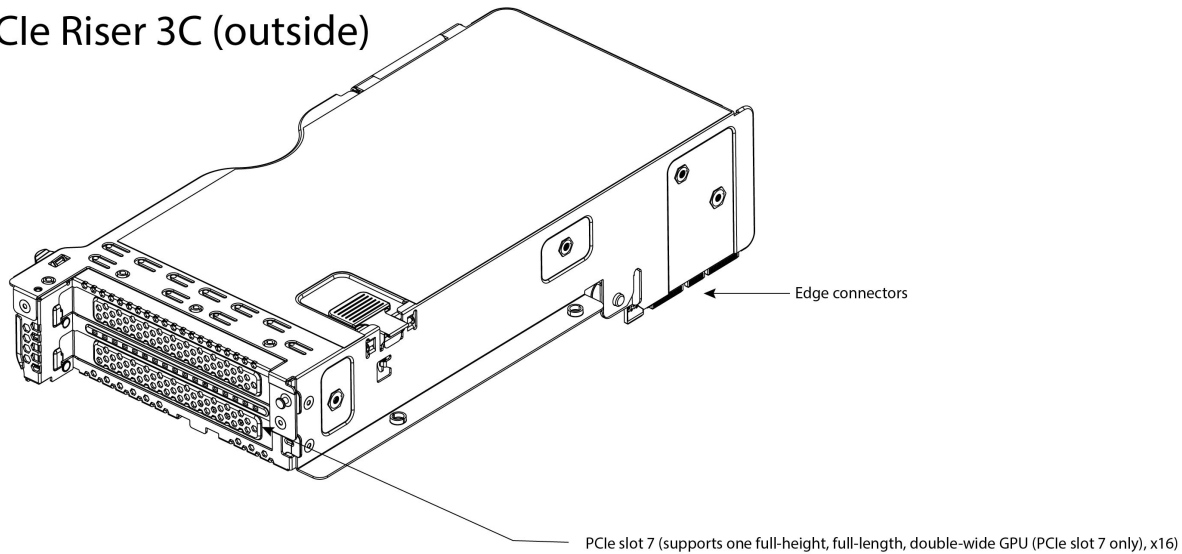

PCIe Riser 3C (inside)

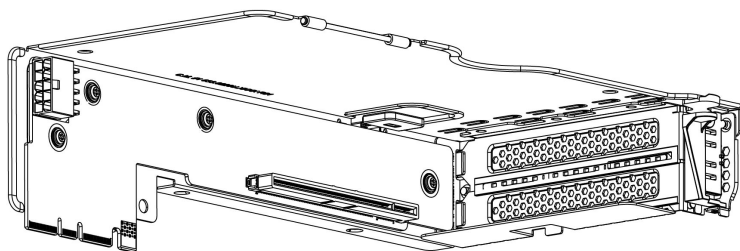

Memory Support for AMD Rome and Milan CPUs

Each CPU has 16 DIMM sockets and supports a maximum memory capacity of 4 GB using 16 x 256 GB DRAMs.

The CPUs support the DRAMs shown in [Table 40](#).

Table 40 Supported DRAMs

DRAM Type	Ranks	Capacity
RDIMM	1 (SR)	16 GB
RDIMM	2 (DR)	32 GB or 64 GB
LRDIMM	4 (QR)	128 GB (non-3DS)
LRDIMM	8 (8R)	256 GB (3DS)

Block Diagram

A block diagram of the C245 M6SX server is shown in *Figure 15*.

Figure 15 UCSC-C245-M6SX Block Diagram

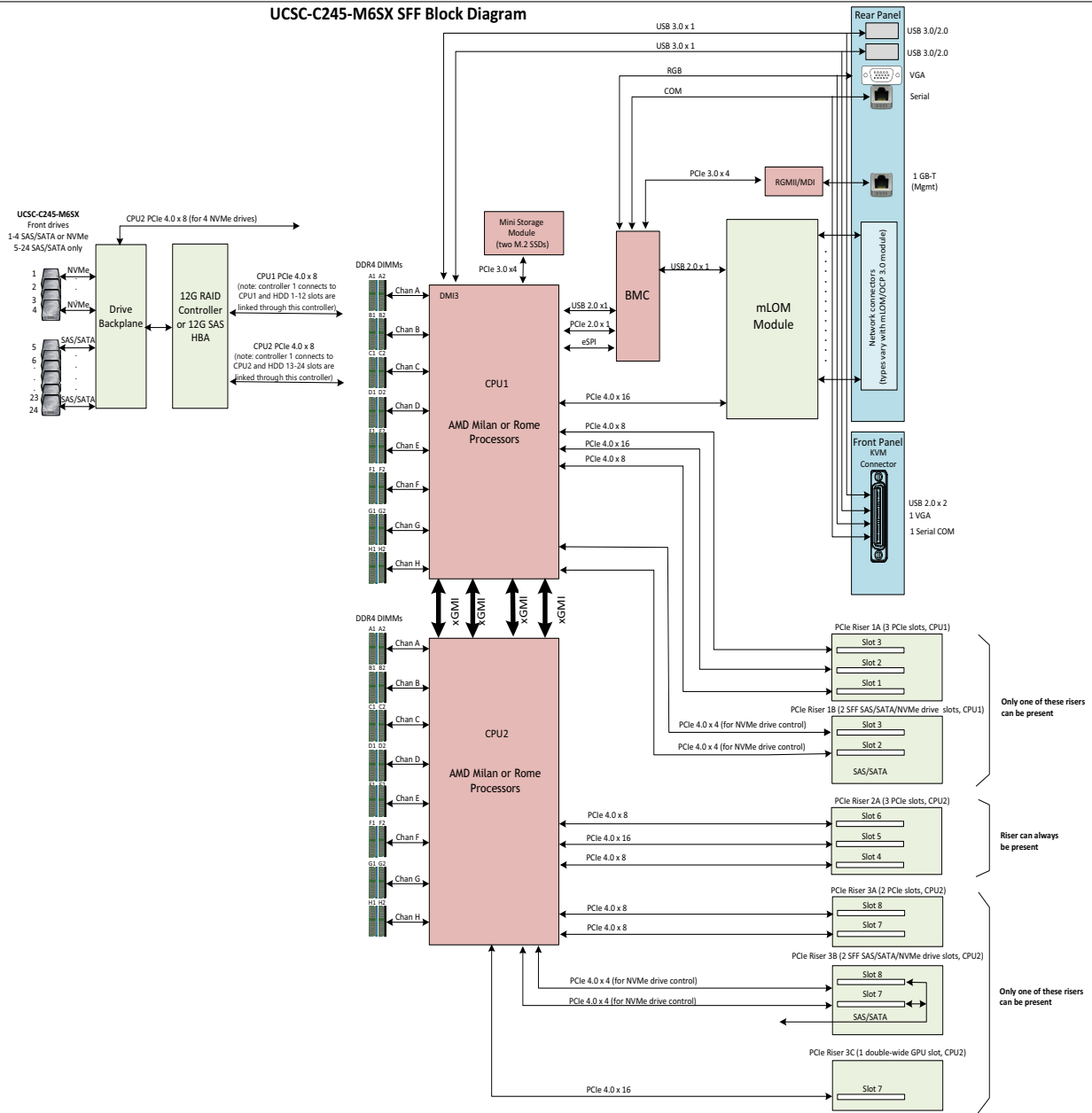

Serial Port Details

The pinout details of the rear RJ-45 serial port connector are shown in [Figure 16](#).

Figure 16 Serial Port (Female RJ-45 Connector) Pinout

Serial Port (RJ-45 Female Connector)

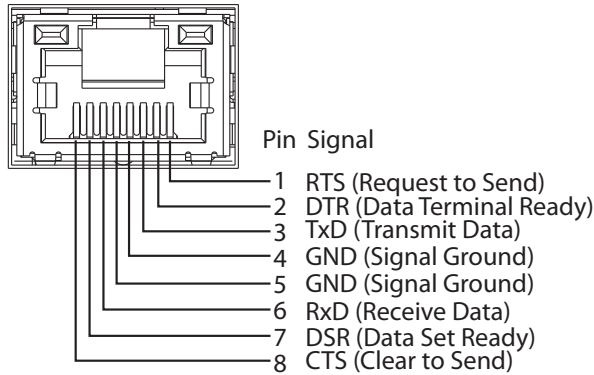

KVM Cable

The KVM cable provides a connection into the server, providing a DB9 serial connector, a VGA connector for a monitor, and dual USB 2.0 ports for a keyboard and mouse. With this cable, you can create a direct connection to the operating system and the BIOS running on the server.

The KVM cable ordering information is listed in [Table 41](#).

Table 41 KVM Cable

Product ID (PID)	PID Description
N20-BKVM	KVM cable for server console port

Figure 17 KVM Cable

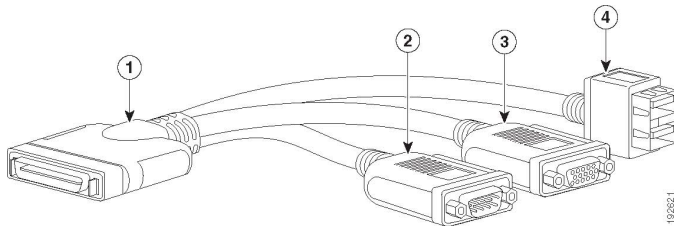

1	Connector (to server front panel)	3	VGA connector (for a monitor)
2	DB-9 serial connector	4	Two-port USB 2.0 connector (for a mouse and keyboard)

SPARE PARTS

This section lists the upgrade and service-related parts for the UCS C245 M6 server. Some of these parts are configured with every server.



NOTE: Some spare parts you order may also require accessories for full functionality. For example, drives or RAID controllers may need accompanying cables. CPUs may need heatsinks, thermal paste, and installation tools. The spares and their accessory parts are listed in [Table 42](#).

Table 42 Spare Parts

Product ID (PID)	PID Description
KVM Cable	
N20-BKVM=	KVM local IO cable for UCS servers console port
Risers	
<p>Note: If you are ordering a Riser, see the Riser Cable and Accessories section in this table for additional parts you may need to order for the Risers</p>	
UCSC-RIS1A-240M6=	C240 M6 Riser1A; (x8;x16x, x8); StBkt; (CPU1)
UCSC-RIS1B-240M6=	C240 M6 Riser1B; 2xHDD; x16; StBkt; (CPU1)
UCSC-RIS2A-240M6=	C240 M6 Riser2A; (x8;x16;x8);StBkt; (CPU2)
UCSC-RIS3A-240M6=	C240 M6 Riser3A (x8;x8); StBkt; (CPU2)
UCSC-RIS3B-240M6=	C240 M6 Riser 3B; 2xHDD; StBkt; (CPU2)
UCSC-RIS3C-240M6=	C240 M6 Riser 3C
Riser Cable and Accessories	
CBL-R1B-SD-240M6=	CBL C240 M6SX (2U24) to Riser 1B
<p>Note: This cable set may required, if you are adding UCSC-RIS1B-240M6 and UCSC-RAID-M6SD to UCSC-C245-M6SX</p>	
UCSC-FBRS2-C240M6=	C240M6 2U Riser2 Filler Blank
UCSC-FBRS3-C240M6=	C240M6 2U Riser3 Filler Blank
CPUs	
<p>Note: When ordering spare CPUs, check the CPU Accessories section of this table for additional parts you may need.</p>	
Milan Processors	
UCS-CPU-A7763=	2.45
UCS-CPU-A7713=	2.00
UCS-CPU-A7713P=	2.00

Table 42 Spare Parts (continued)

Product ID (PID)	PID Description
UCS-CPU-A7663=	2.00
UCS-CPU-A7643=	2.30
UCS-CPU-A7543=	2.80
UCS-CPU-A7543P=	2.80
UCS-CPU-A7513=	2.60
UCS-CPU-A75F3=	2.95
UCS-CPU-A7413=	2.65
UCS-CPU-A7453=	2.75
UCS-CPU-A7443=	2.85
UCS-CPU-A7443P=	2.85
UCS-CPU-A74F3=	3.20
UCS-CPU-A7343=	3.20
UCS-CPU-A7313=	3.00
UCS-CPU-A7313P=	3.00
UCS-CPU-A73F3=	3.50
UCS-CPU-A72F3=	3.70
Milan-X Processors	
UCS-CPU-A7773X=	2.20
UCS-CPU-A7573X=	2.80
UCS-CPU-A7473X=	2.80
UCS-CPU-A7373X=	3.05
Rome Processors	
UCS-CPU-A7662=	2.00
UCS-CPU-A7532=	2.40
UCS-CPU-A7502P=	2.50
UCS-CPU-A7352=	2.30
UCS-CPU-A7302=	3.00
UCS-CPU-A7282=	2.80
UCS-CPU-A7272=	2.90
UCS-CPU-A7262=	3.20
UCS-CPU-A7252=	3.10
UCS-CPU-A7232P=	3.10
CPU Accessories	
UCS-CPU-TIM=	Single CPU thermal interface material syringe for M5 server HS seal ¹
 <p>Note: This part is included with the purchase of spare CPU. Can be ordered separately.</p>	

Table 42 Spare Parts (continued)





Product ID (PID)	PID Description
UCS-M6-CPU-CAR=  Note: This part is included with the purchase of spare CPU.Can be ordered separately.	Spare CPU Carrier for M6
UCSX-HSCK=  Note: This part is included with the purchase of spare CPU.Can be ordered separately.	UCS CPU/Heatsink Cleaning Kit, for up to 4 CPU/heatsink sets
UCS-CPUAT=  Note: This part is included with the purchase of spare CPU.Can be ordered separately.	CPU Assembly Tool for Servers
UCSC-HSHP-245M6=  Note: Order this Heatsink, if you are adding additional CPU/spare CPU	Heatsink for 2U SFF M6 PCIe SKU
UCSC-FAN-C240M6=	C240M6 2U Fan
Memory	
UCS-MR-X16G1RW=	16 GB RDIMM SRx4 3200 (8Gb)
UCS-MR-X32G1RW=	32 GB RDIMM SRx4 3200 (16Gb)
UCS-MR-X32G2RW=	32 GB RDIMM DRx4 3200 (8Gb)
UCS-MR-X64G2RW=	64 GB RDIMM DRx4 3200 (16Gb)
UCS-ML-128G4RW=	128 GB LRDIMM QRx4 3200 (16Gb)
UCS-ML-256G8RW=	256 GB LRDIMM 8Rx4 3200 (16Gb)
DIMM Blank	
UCS-DIMM-BLK=  Note: Order this DIMM Blank, if you are not using DIMM slots.Any empty DIMM slot must be populated with a DIMM blank to maintain proper cooling airflow.	UCS DIMM Blank

Table 42 Spare Parts (continued)

Product ID (PID)	PID Description
Drives	
HDDs	
 <p>Note: When ordering additional SAS/SATA or NVMe front or rear drives, you may need to order a cable to connect from the drive to the motherboard. See the Drive Cables section in this table.</p>	
HDDs (15K RPM)	
UCS-HD900G15K12N=	900 GB 12G SAS 15K RPM SFF HDD
UCS-HD300G15K12N=	300 GB 12G SAS 15K RPM SFF HDD
UCS-HD600G15K12N=	600 GB 12G SAS 15K RPM SFF HDD
HDDs (10K RPM)	
UCS-HD300G10K12N=	300 GB 12G SAS 10K RPM SFF HDD
UCS-HD600G10K12N=	600 GB 12G SAS 10K RPM SFF HDD
UCS-HD12TB10K12N=	1.2 TB 12G SAS 10K RPM SFF HDD
UCS-HD18TB10K4KN=	1.8 TB 12G SAS 10K RPM SFF HDD (4K)
UCS-HD24TB10K4KN=	2.4 TB 12G SAS 10K RPM SFF HDD (4K)
Enterprise Performance SAS/SATA SSDs (High endurance, supports up to 10X or 3X DWPD (drive writes per day))	
UCS-SD19T63X-EP=	1.9 TB 2.5in Enterprise performance 6GSATA SSD(3X endurance)
UCS-SD960G63X-EP=	960 GB 2.5in Enterprise performance 6GSATA SSD(3X endurance)
UCS-SD480G63X-EP=	480 GB 2.5in Enterprise Performance 6GSATA SSD(3X endurance)
UCS-SD19TBM3X-EP=	1.9TB 2.5in Enterprise performance 6GSATA SSD(3X endurance)
UCS-SD960GBM3X-EP=	960GB 2.5in Enterprise performance 6GSATA SSD(3X endurance)
UCS-SD480GBM3X-EP=	480GB 2.5in Enterprise Performance 6GSATA SSD(3X endurance)
UCS-SD800GK3X-EP=	800 GB 2.5in Enterprise Performance 12G SAS SSD(3X endurance)
UCS-SD16TK3X-EP=	1.6 TB 2.5in Enterprise Performance 12G SAS SSD(3X endurance)
UCS-SD32TK3X-EP=	3.2 TB 2.5in Enterprise Performance 12G SAS SSD(3X endurance)
UCS-SD38T63X-EP=	3.8TB 2.5in Enter Perf 6G SATA Intel SSD (3X)
UCS-SD32TKA3X-EP=	3.2TB 2.5in Enter Perf 12G SAS Kioxia G2 SSD (3X)
UCS-SD16TKA3X-EP=	1.6TB 2.5in Enterprise Performance 12G SAS SSD(3X endurance)
UCS-SD800GS3X-EP=	800GB 2.5in Enterprise Performance 12G SAS SSD(3X endurance)
UCS-SD16TS3X-EP=	1.6TB 2.5in Enterprise Performance 12G SAS SSD(3X endurance)
UCS-SD32TS3X-EP=	3.2TB 2.5in Enterprise Performance 12G SAS SSD(3X endurance)
Enterprise Value SAS/SATA SSDs (Low endurance, supports up to 1X DWPD (drive writes per day))	
UCS-SD38T6I1X-EV=	3.8 TB 2.5 inch Enterprise Value 6G SATA SSD
UCS-SD960G6I1X-EV=	960 GB 2.5 inch Enterprise Value 6G SATA SSD
UCS-SD480G6I1X-EV=	480 GB 2.5 inch Enterprise Value 6G SATA SSD
UCS-SD19T6I1X-EV=	1.9 TB 2.5 inch Enterprise Value 6G SATA SSD
UCS-SD38T6I1X-EV=	3.8 TB 2.5 inch Enterprise Value 6G SATA SSD
UCS-SD120GM1X-EV=	120 GB 2.5 inch Enterprise Value 6G SATA SSD
UCS-SD240GM1X-EV=	240 GB 2.5 inch Enterprise Value 6G SATA SSD

Table 42 Spare Parts (continued)

Product ID (PID)	PID Description
UCS-SD960GK1X-EV=	960 GB 2.5 inch Enterprise Value 12G SAS SSD
UCS-SD19TK1X-EV=	1.9 TB 2.5 inch Enterprise Value 12G SAS SSD
UCS-SD38TK1X-EV=	3.8 TB 2.5 inch Enterprise Value 12G SAS SSD
UCS-SD76TK1X-EV=	7.6 TB 2.5 inch Enterprise Value 12G SAS SSD
UCS-SD15TK1X-EV=	15.3 TB 2.5 inch Enterprise Value 12G SAS SSD
UCS-SD19TM1X-EV=	1.9TB 2.5in Enter Value 6G SATA Micron G1 SSD
UCS-SD15TKA1X-EV=	15.3TB 2.5in Enter Value 12G SAS Kioxia G2 SSD
UCS-SD76TKA1X-EV=	7.6TB 2.5 inch Enterprise Value 12G SAS SSD
UCS-SD38TKA1X-EV=	3.8TB 2.5 inch Enterprise Value 12G SAS SSD
UCS-SD19TKA1X-EV=	1.9TB 2.5 inch Enterprise Value 12G SAS SSD
UCS-SD960G6S1X-EV=	960GB 2.5 inch Enterprise Value 6G SATA SSD
UCS-SD19T6S1X-EV=	1.9TB 2.5 inch Enterprise Value 6G SATA SSD
UCS-SD38T6S1X-EV=	3.8TB 2.5 inch Enterprise Value 6G SATA SSD
UCS-SD76T6S1X-EV=	7.6TB 2.5 inch Enterprise Value 6G SATA SSD
UCS-SD76TBM1X-EV=	7.6TB 2.5 inch Enterprise Value 6G SATA SSD
UCS-SD38TBM1X-EV=	3.8TB 2.5 inch Enterprise Value 6G SATA SSD
UCS-SD19TBM1X-EV=	1.9TB 2.5 inch Enterprise Value 6G SATA SSD
UCS-SD16TBM1X-EV=	1.6TB 2.5 inch Enterprise Value 6G SATA SSD
UCS-SD960GBM1X-EV=	960GB 2.5 inch Enterprise Value 6G SATA SSD
UCS-SD480GBM1X-EV=	480GB 2.5 inch Enterprise Value 6G SATA SSD
UCS-SD240GBM1X-EV=	240GB 2.5 inch Enterprise Value 6G SATA SSD
UCS-SD19TS1X-EV=	1.9TB 2.5 inch Enterprise Value 12G SAS SSD
UCS-SD38TS1X-EV=	3.8TB 2.5 inch Enterprise Value 12G SAS SSD
Self-Encrypted Drives (SED)	
UCS-HD18T10NK9=	1.8 TB 12G SAS 10K RPM SFF HDD (4K format, SED)
UCS-HD12T10NK9=	1.2TB 12G SAS 10K RPM SFF HDD (SED-FIPS)
UCS-HD600G15NK9=	600 GB 12G SAS 15K RPM SFF HDD (SED)
UCS-SD76TBKNK9=	7.6TB Enterprise value SAS SSD (1 DWPD, SED-FIPS)
UCS-SD76TEM2NK9=	7.6TB Enterprise value SATA SSD (1X, SED)
UCS-SD960GM2NK9=	960GB Enterprise value SATA SSD (1X , SED)
UCS-SD76TBKANK9=	7.6TB Enterprise value SAS SSD (1 DWPD, SED-FIPS)
UCS-SD38TBKANK9=	3.8TB 2.5in Enterprise value 12G SAS SSD (1DWPD, SED-FIPS)
UCS-SD16TBKANK9=	1.6TB 2.5in Enter Perf 12G SAS Kioxia G2 SSD (3X SED-FIPS)
PCIe/NVMe SFF (2.5-inch) drives²	
UCSC-NVMEXPB-I375=	375GB 2.5in Intel Optane NVMe Extreme Performance SSD
UCSC-NVMEXP-I750=	750GB 2.5in Intel Optane NVMe Extreme Perf.
UCS-NVMEI4-I1920=	1.9TB 2.5in U.2 Intel P5500 NVMe High Perf Medium Endurance
UCS-NVMEI4-I1600=	1.6TB 2.5in U.2 Intel P5600 NVMe High Perf Medium Endurance
UCS-NVMEI4-I3200=	3.2TB 2.5in U.2 Intel P5600 NVMe High Perf Medium Endurance
UCS-NVMEI4-I6400=	6.4TB 2.5in U.2 Intel P5600 NVMe High Perf Medium Endurance

Table 42 Spare Parts (continued)



Product ID (PID)	PID Description
UCS-NVMEXP-I400=	400GB 2.5in U.2 Intel P5800X Optane NVMe Extreme Perform SSD
UCS-NVMEXP-I800=	800GB 2.5in U.2 Intel P5800X Optane NVMe Extreme Perform SSD
UCS-NVME4-1920=	1.9TB 2.5in U.2 15mm P5520 Hg Perf Med End NVMe
UCS-NVME4-3840=	3.8TB 2.5in U.2 15mm P5520 Hg Perf Med End NVMe
UCS-NVME4-7680=	7.6TB 2.5in U.2 15mm P5520 Hg Perf Med End NVMe
UCS-NVME4-1536=	15.3TB 2.5in U.2 15mm P5520 Hg Perf Med End NVMe
UCS-NVME4-1600=	1.6TB 2.5in U.2 15mm P5620 Hg Perf Hg End NVMe (3X)
UCS-NVME4-3200=	3.2TB 2.5in U.2 15mm P5620 Hg Perf Hg End NVMe (3X)
UCS-NVME4-6400=	6.4TB 2.5in U.2 15mm P5620 Hg Perf Hg End NVMe (3X)
UCS-NVMEQ-1536=	15.3TB 2.5in U.2 15mm P5316 Hg Perf Low End NVMe
UCS-NVMEM6-W3200=	3.2TB 2.5in U.2 WD SN840 NVMe Extreme Perf. High Endurance
UCS-NVMEM6-W7680=	7.6TB 2.5in U.2 WD SN840 NVMe Extreme Perf. Value Endurance
UCS-NVMEM6-W15300=	15.3TB 2.5in U.2 WD SN840 NVMe Extreme Perf. Value Endurance
Drive Cables	
CBL-FNVME-C245M6=	C245M6 2U x2 Front NVMe cable (single Y cable)
 <p>Note: This cable set may be required, if you are adding a front NVMe drive. This cable is supported only with the SAS HBA controller.</p>	
CBL-SDFNVME-245M6=	C245M6 2U x4 Front NVMe cable (two cables)
 <p>Note: This cable set may be required, if you are adding the front-facing NVMe drives only. This cable is only supported with 12G SAS RAID Controller.</p>	
Drive Blanking Panel	
UCSC-BBLKD-S2=	C-Series M5 SFF drive blanking panel
RAID Controllers/SAS HBAs	
 <p>Note: When ordering additional RAID controllers, you may need to order a cable/supercap to connect from the RAID controller to the motherboard. See the RAID Controller Accessories section in this table.</p>	
UCSC-SAS-240M6=	Cisco 12G SAS HBA
UCSC-RAID-M6SD=	Cisco M6 12G SAS RAID controller with SuperCap and 4GB FBWC
RAID Controller Accessories	

Table 42 Spare Parts (continued)





Product ID (PID)	PID Description
CBL-SDSAS-245M6=  Note: This cable set may required, if you are adding UCSC-RAID-M6SD to UCSC-C245-M6SX	CBL C245 M6SX (2U24) MB CPU1(NVMe-Drive)
CBL-SAS24-245M6=  Note: This cable set may required, if you are adding SAS Drive and UCSC-SAS-240M6 (quantity 2)	C245M6 SAS cable 24 (2U); Pismo Rock
UCS-SCAP-M6=  Note: Order this Super cap, if you are adding UCSC-RAID-M6SD.	M6 Supercap for write cache backup
CBL-SCAPSD-C240M6=  Note: Order this Super cap cable if you are adding UCSC-RAID-M6SD to UCSC-C245-M6SX	CBL Super Cap for PB+ C240/C245 M6
M.2 SATA SSDs  Note: When ordering additional RAID controllers, you may need some the accessories to install it. See the M.2 SATA SSDs Accessories section in this table.	
UCS-M2-I240GB=	240GB SATA M.2 SSD
UCS-M2-I480GB=	480GB SATA M.2 SSD
UCS-M2-240G	240GB SATA M.2
UCS-M2-480G	480GB M.2 SATA SSD
UCS-M2-960G	960GB SATA M.2
UCS-M2-HWRAID=	Cisco Boot optimized M.2 RAID controller (holds up to two M.2 SATA SSDs)
M.2 SATA SSDs Accessories	

Table 42 Spare Parts (continued)

Product ID (PID)	PID Description
UCSC-M2EXT-240M6=  Note: When ordering UCS-M2-HWRAID spare, you may need to order M.2 Extender board.	C240M6 2U M.2 Extender board
PCIe Cards	
Modular LAN on Motherboard (mLOM)	
UCSC-M-V25-04=	Cisco UCS VIC 1467 quad port 10/25G SFP28 mLOM
UCSC-M-V100-04=	Cisco UCS VIC 1477 dual port 40/100G QSFP28 mLOM
UCSC-M-V5Q50G=	Cisco UCS VIC 15428 quad port 10/25/50G MLOM
UCSC-M-V5D200G=	Cisco UCS VIC 15238 dual port 40/100/200G MLOM
UCSC-M-V5Q50GV2=	Cisco UCS VIC 15427 Quad Port CNA MLOM with Secure Boot
UCSC-M-V5D200GV2=	VIC 15237, MLOM, 2x40/100/200G for Rack
Virtual Interface Card (VICs)	
UCSC-PCIE-C100-04=	Cisco UCS VIC 1495 Dual Port 40/100G QSFP28 CNA PCIe
UCSC-PCIE-C25Q-04=	Cisco UCS VIC 1455 quad port 10/25G SFP28 PCIe
UCSC-P-V5Q50G-D=	Cisco UCS VIC 15425 Quad Port 10/25/50G CNA PCIE
UCSC-P-V5D200G-D=	Cisco UCS VIC 15235 Dual Port 40/100/200G CNA PCIE
Network Interface Cards (NICs)	
10 Gb NICs	
UCSC-PCIE-ID10GF=	Intel X710-DA2 Dual Port 10Gb SFP+ NIC
UCSC-PCIE-IQ10GF=	Intel X710 quad-port 10G SFP+ NIC
UCSC-P-ID10GC=	Cisco-Intel X710T2LG 2x10 GbE RJ45 PCIe NIC
UCSC-P-IQ10GC=	Cisco-Intel X710T4LG 4x10 GbE RJ45 PCIe NIC
25 Gb NICs	
UCSC-P-I8D25GF=	Cisco-Intel E810XXVDA2 2x25/10 GbE SFP28 PCIe NIC
UCSC-P-M5D25GF=	Mellanox MCX512A-ACAT dual port 10/25G SFP28 NIC
UCSC-P-I8Q25GF=	Cisco-Intel E810XXVDA4L 4x25/10 GbE SFP28 PCIe NIC
40 Gb NICs	
UCSC-PCIE-ID40GF=	Intel XL710 dual-port 40G QSFP+ NIC
100 Gb NICs	
UCSC-P-M5D100GF=	Mellanox CX-5 MCX516A-CDAT 2x100GbE QSFP PCIe NIC
UCSC-P-I8D100GF=	Cisco-Intel E810CQDA2 2x100 GbE QSFP28 PCIe NIC
UCSC-P-M6DD100GF=	Cisco-MLNX MCX623106AS-CDAT 2x100GbE QSFP56 PCIe NIC
UCSC-P-M6CD100GF=	Cisco-MLNX MCX623106AC-CDAT 2x100GbE QSFP56 PCIe NIC (with Crypto)
Host Bus Adapters (HBAs)	
UCSC-PCIE-QD16GF=	Qlogic QLE2692 dual-port 16G FC HBA

Table 42 Spare Parts (continued)







Product ID (PID)	PID Description
UCSC-PCIE-BD16GF=	Emulex LPe31002 dual port 16G FC HBA
UCSC-P-Q6D32GF=	Cisco-QLogic QLE2772 2x32GFC Gen 6 Enhanced PCIe HBA
UCSC-P-B7D32GF=	Cisco-Emulex LPe35002-M2-2x32GFC Gen 7 PCIe HBA
GPU PCIe Cards	
 <p>Note: If you are adding a GPU, you may need to add cables and other accessories for the GPU. See the GPU accessories and NVIDIA GPU Licenses section of this table.</p>	
UCSC-GPU-A10=	TESLA A10, PASSIVE, 150W, 24GB
UCSC-GPU-A30=	Tesla A30
UCSC-GPU-A40=	TESLA A40 RTX, PASSIVE, 300W, 48GB
UCSC-GPU-A100-80=	TESLA A100, PASSIVE, 300W, 80GB
UCSC-GPU-A16=	NVIDIA A16 PCIE 250W 4X16GB
GPU accessories	
UCS-M10CBL-C240M5	C240M5 NVIDIA M10/A10 Cable
 <p>Note: Order this cable if you are adding an A10/M10 GPU</p>	
UCS-P100CBL-240M5	C240M5 NVIDIA P100 /RTX /A100 /A40/ A16 /A30 Cable
 <p>Note: Order this cable if you are adding an A100 /A40/ A16/A30 GPU</p>	
CBL-GPU-C240M6	Y TYPE GPU POWER Cable for A10 GPU, C240M6 and C245M6
 <p>Note: Order this power cable if you are adding an A10 GPU</p>	
UCSC-HSLP-C245M6=	Heatsink 2U SFF GPU SKU
 <p>Note: Order this Heatsink if you are adding an GPUs</p>	
UCSC-ADGPU-245M6	C245M6 GPU Air Duct 2USFF/NVMe (for DW/FL only)
 <p>Note: You may need to order this Air Duct if you are adding an GPUs</p>	

Table 42 Spare Parts (continued)

Product ID (PID)	PID Description
NVIDIA GPU Licenses	
 <p>Note: Order the GPU licenses if are adding the NVIDIA GPUs</p> <ul style="list-style-type: none"> • If you already have a NVIDIA GPU and adding another one, or if you are replacing NVIDIA GPUs, then existing license should be fine. • if you don't have a GPU already installed, and you are adding the first one or two, you may need to order the license. 	
NV-VCS-1YR=	NVIDIA vCompute Server Subscription - 1 GPU - 1 Year
NV-VCS-3YR=	NVIDIA vCompute Server Subscription - 1 GPU - 3 Year
NV-VCS-5YR=	NVIDIA vCompute Server Subscription - 1 GPU - 5 Year
NV-VCS-R-1Y=	Renew NVIDIA vCompute Server Subscription - 1 GPU - 1 Year
NV-VCS-R-3Y=	Renew NVIDIA vCompute Server Subscription - 1 GPU - 3 Year
NV-VCS-R-5Y=	Renew NVIDIA vCompute Server Subscription - 1 GPU - 5 Year
NV-GRDWK-1-5S=	Quadro Perpetual Lic - NVIDIA vDWS 1CCU; 5Yr SUMS Req
NV-GRDVA-1-5S=	GRID Perpetual Lic - NVIDIA VDI APPs 1CCU; 5Yr SUMS Reqd
NV-GRDPC-1-5S=	GRID Perpetual Lic - NVIDIA VDI PC 1CCU; 5Yr SUMS Reqd
NV-GRD-EDP-5S=	EDU - Quadro Perpetual Lic - NVIDIA vDWS 1CCU; 5Yr SUMS Reqd
NV-GRID-WKP-5YR=	NVIDIA Quadro Production SUMS - vDWS 1CCU - 5 Year
NV-GRID-VAP-5YR=	NVIDIA GRID Production SUMS - VDI Apps 1CCU - 5 Year
NV-GRID-PCP-5YR=	NVIDIA GRID Production SUMS - VDI PC 1CCU - 5 Year
NV-GRID-EDP-5YR=	EDU - NVIDIA Quadro vDWS Production SUMS - 1CCU - 5 Year
NV-GRID-WKS-1YR=	NVIDIA Quadro SW Subscription - vDWS 1CCU - 1 Year
NV-GRID-WKS-3YR=	NVIDIA Quadro SW Subscription - vDWS 1CCU - 3 Year
NV-GRID-WKS-4YR=	NVIDIA Quadro SW Subscription - vDWS 1CCU - 4 Year
NV-GRID-WKS-5YR=	NVIDIA Quadro SW Subscription - vDWS 1CCU - 5 Year
NV-GRID-PCS-1YR=	NVIDIA GRID Software Subscription - VDI PC 1CCU - 1 Year
NV-GRID-PCS-3YR=	NVIDIA GRID Software Subscription - VDI PC 1CCU - 3 Year
NV-GRID-PCS-4YR=	NVIDIA GRID Software Subscription - VDI PC 1CCU - 4 Year
NV-GRID-PCS-5YR=	NVIDIA GRID Software Subscription - VDI PC 1CCU - 5 Year
NV-GRID-VAS-1YR=	NVIDIA GRID Software Subscription - VDI Apps 1CCU - 1 Year
NV-GRID-VAS-3YR=	NVIDIA GRID Software Subscription - VDI Apps 1CCU - 3 Year
NV-GRID-VAS-4YR=	NVIDIA GRID Software Subscription - VDI Apps 1CCU - 4 Year
NV-GRID-VAS-5YR=	NVIDIA GRID Software Subscription - VDI Apps 1CCU - 5 Year
NV-GRID-EDS-1YR=	EDU - NVIDIA Quadro vDWS SW Subscription - 1CCU - 1 Year
NV-GRID-EDS-3YR=	EDU - NVIDIA Quadro vDWS SW Subscription - 1CCU - 3 Year
NV-GRID-EDS-4YR=	EDU - NVIDIA Quadro vDWS SW Subscription - 1CCU - 4 Year
NV-GRID-EDS-5YR=	EDU - NVIDIA Quadro vDWS SW Subscription - 1CCU - 5 Year
NV-GRID-VAP-R-4Y=	Renew NVIDIA GRID vApps SUMS 1CCU 4 Year

Table 42 Spare Parts (continued)

Product ID (PID)	PID Description
NV-GRID-PCP-R-4Y=	Renew NVIDIA GRID vPC SUMS 1CCU 4 Year
NV-QUAD-WKP-R-4Y=	Renew NVIDIA Quadro vDWS SUMS 1CCU 4 Year
NV-QUAD-WKPE-R-4Y=	Renew NVIDIA Quadro vDWS SUMS 1CCU EDU 4 Year
NV-QUAD-WKS-R-1Y=	Renew NVIDIA Quadro vDWS Subscr 1CCU 1 Year
NV-QUAD-WKS-R-3Y=	Renew NVIDIA Quadro vDWS Subscr 1CCU 3 Year
NV-QUAD-WKS-R-4Y=	Renew NVIDIA Quadro vDWS Subscr 1CCU 4 Year
NV-QUAD-WKS-R-5Y=	Renew NVIDIA Quadro vDWS Subscr 1CCU 5 Year
NV-QUAD-WKSE-R-1Y=	Renew NVIDIA Quadro vDWS Subscr 1CCU EDU 1 Year
NV-QUAD-WKSE-R-3Y=	Renew NVIDIA Quadro vDWS Subscr 1CCU EDU 3 Year
NV-QUAD-WKSE-R-4Y=	Renew NVIDIA Quadro vDWS Subscr 1CCU EDU 4 Year
NV-GRID-VAS-R-1Y=	Renew NVIDIA GRID vApps Subscr 1CCU 1 Year
NV-GRID-VAS-R-3Y=	Renew NVIDIA GRID vApps Subscr 1CCU 3 Year
NV-GRID-VAS-R-4Y=	Renew NVIDIA GRID vApps Subscr 1CCU 4 Year
NV-GRID-VAS-R-5Y=	Renew NVIDIA GRID vApps Subscr 1CCU 5 Year
NV-GRID-PCS-R-1Y=	Renew NVIDIA GRID vPC Subscr 1CCU 1 Year
NV-GRID-PCS-R-3Y=	Renew NVIDIA GRID vPC Subscr 1CCU 3 Year
NV-GRID-PCS-R-4Y=	Renew NVIDIA GRID vPC Subscr 1CCU 4 Year
NV-GRID-PCS-R-5Y=	Renew NVIDIA GRID vPC Subscr 1CCU 5 Year
NV-QUAD-WKP-R-1Y=	Renew NVIDIA Quadro vDWS SUMS 1CCU 1 Year
NV-QUAD-WKP-R-3Y=	Renew NVIDIA Quadro vDWS SUMS 1CCU 3 Year
NV-QUAD-WKP-R-5Y=	Renew NVIDIA Quadro vDWS SUMS 1CCU 5 Year
NV-QUAD-WKPE-R-1Y=	Renew NVIDIA Quadro vDWS SUMS 1CCU EDU 1 Year
NV-QUAD-WKPE-R-3Y=	Renew NVIDIA Quadro vDWS SUMS 1CCU EDU 3 Year
NV-QUAD-WKPE-R-5Y=	Renew NVIDIA Quadro vDWS SUMS 1CCU EDU 5 Year
NV-GRID-VAP-R-1Y=	Renew NVIDIA GRID vApps SUMS 1CCU 1 Year
NV-GRID-VAP-R-3Y=	Renew NVIDIA GRID vApps SUMS 1CCU 3 Year
NV-GRID-VAP-R-5Y=	Renew NVIDIA GRID vApps SUMS 1CCU 5 Year
NV-GRID-PCP-R-1Y=	Renew NVIDIA GRID vPC SUMS 1CCU 1 Year
NV-GRID-PCP-R-3Y=	Renew NVIDIA GRID vPC SUMS 1CCU 3 Year
NV-GRID-PCP-R-5Y=	Renew NVIDIA GRID vPC SUMS 1CCU 5 Year
NV-GRD-VA2WKP-5S=	Upgrade NVIDIA VDI APPS to Quadro vDWS 1CCU; 5Yr SUMS Reqd
NV-GRD-VA2PCP-5S=	Upgrade NVIDIA VDI APPS to vPC 1CCU; 5Yr SUMS Reqd
NV-GRD-VA2WKPE-5S=	Upgrade NVIDIA VDI to Quadro vDWS 1CCU; 5Yr SUMS Reqd
NV-GRD-PC2WKP-5S=	Upgrade NVIDIA vPC to Quadro vDWS 1CCU; 5Yr SUMS Reqd
NV-GRD-PC2WKPE-5S=	Upgrade NVIDIA vPC to Quadro vDWS 1CCU; 5Yr SUMS Reqd
Power Supplies	
PSU (Input High Line 210VAC)	
UCSC-PSU1-1050W=	UCS 1050W AC PSU Platinum (Not EU/UK Lot 9 Compliant)
UCSC-PSUV2-1050DC=	Cisco UCS 1050W -48V DC Power Supply for Rack Server Requires cable CAB-48DC-40A-8AWG
UCSC-PSU1-1600W=	UCS 1600W AC PSU Platinum (Not EU/UK Lot 9 Compliant)

Table 42 Spare Parts (continued)

Product ID (PID)	PID Description
UCSC-PSU1-2300W2=	2300W Power supply for C-series servers Titanium
UCSC-PSU1-1050WST=	UCS 1050W AC PSU Platinum (Not EU/UK Lot 9 Compliant)
UCSC-PSU1-1200W	1200W Titanium power supply for C-Series Servers
UCSC-PSU1-1600WST=	UCS 1600W AC PSU Platinum (Not EU/UK Lot 9 Compliant)
UCSC-PSU1-2300WST=	Cisco UCS 2300W AC Power Supply for Rack Servers Titanium
PSU (Input Low Line 110VAC)	
UCSC-PSU1-1050W=	UCS 1050W AC PSU Platinum (Not EU/UK Lot 9 Compliant)
UCSC-PSUV2-1050DC=	Cisco UCS 1050W -48V DC Power Supply for Rack Server Requires cable CAB-48DC-40A-8AWG
UCSC-PSU1-1200W=	1200W Titanium power supply for C-Series Servers
UCSC-PSU1-2300W=	2300W Power supply for C-series servers Titanium
UCSC-PSU1-1050WST=	UCS 1050W AC PSU Platinum (Not EU/UK Lot 9 Compliant)
Power Supply Blanking Panel	
UCSC-PSU-M5BLK=	Power Supply Blanking Panel for M5 servers
Power Cables	
CAB-48DC-40A-8AWG=	C-Series -48VDC PSU Power Cord, 3.5M, 3 Wire, 8AWG, 40A
CAB-N5K6A-NA=	Power Cord, 200/240V 6A, North America
CAB-AC-L620-C13=	AC Power Cord, NEMA L6-20 - C13, 2M/6.5ft
CAB-C13-CBN=	CABASY,WIRE,JUMPER CORD, 27" L, C13/C14, 10A/250V
CAB-C13-C14-2M=	CABASY,WIRE,JUMPER CORD, PWR, 2 Meter, C13/C14,10A/250V
CAB-C13-C14-AC=	CORD,PWR,JMP,IEC60320/C14,IEC6 0320/C13, 3.0M
CAB-250V-10A-AR=	Power Cord, 250V, 10A, Argentina
CAB-9K10A-AU=	Power Cord, 250VAC 10A 3112 Plug, Australia
CAB-250V-10A-CN=	AC Power Cord - 250V, 10A - PRC
CAB-9K10A-EU=	Power Cord, 250VAC 10A CEE 7/7 Plug, EU
CAB-250V-10A-ID=	Power Cord, 250V, 10A, India
CAB-C13-C14-3M-IN=	Power Cord Jumper, C13-C14 Connectors, 3 Meter Length, India
CAB-C13-C14-IN=	Power Cord Jumper,C13-C14 Connectors,1.4 Meter Length, India
CAB-250V-10A-IS=	Power Cord, SFS, 250V, 10A, Israel
CAB-9K10A-IT=	Power Cord, 250VAC 10A CEI 23-16/VII Plug, Italy
CAB-9K10A-SW=	Power Cord, 250VAC 10A MP232 Plug, Switzerland
CAB-9K10A-UK=	Power Cord, 250VAC 10A BS1363 Plug (13 A fuse), UK
CAB-9K12A-NA=	Power Cord, 125VAC 13A NEMA 5-15 Plug, North America
CAB-250V-10A-BR=	Power Cord - 250V, 10A - Brazil
CAB-C13-C14-2M-JP=	Power Cord C13-C14, 2M/6.5ft Japan PSE mark
CAB-9K10A-KOR=	Power Cord, 125VAC 13A KSC8305 Plug, Korea
CAB-ACTW=	AC Power Cord (Taiwan), C13, EL 302, 2.3M

Table 42 Spare Parts (continued)

Product ID (PID)	PID Description
CAB-JPN-3PIN=	Japan, 90-125VAC 12A NEMA 5-15 Plug, 2.4m
CAB-C19-CBN=	Cabinet Jumper Power Cord, 250 VAC 16A, C20-C19 Connectors
CAB-S132-C19-ISRL=	S132 to IEC-C19 14ft Israeli
CAB-IR2073-C19-AR=	IRSM 2073 to IEC-C19 14ft Argen
CAB-BS1363-C19-UK=	BS-1363 to IEC-C19 14ft UK
CAB-SABS-C19-IND=	SABS 164-1 to IEC-C19 India
CAB-C2316-C19-IT=	CEI 23-16 to IEC-C19 14ft Italy
CAB-L520P-C19-US=	NEMA L5-20 to IEC-C19 6ft US
CAB-US515P-C19-US=	NEMA 5-15 to IEC-C19 13ft US
CAB-US520-C19-US=	NEMA 5-20 to IEC-C19 14ft US
CAB-US620P-C19-US=	NEMA 6-20 to IEC-C19 13ft US
CAB-C19-C20-IND=	Power Cord C19-C20 India
UCSB-CABL-C19-BRZ=	NBR 14136 to C19 AC 14FT POWER CORD, BRAZIL
CAB-9K16A-BRZ=	Power Cord 250VAC 16A, Brazil, Src Plug EL224-C19
CAB-ACS-16=	AC Power Cord (Swiss) 16A
CAB-AC-16A-AUS=	Power Cord, 250VAC, 16A, Australia C19
CAB-C19-C20-3M-JP=	Power Cord C19-C20, 3M/10ft Japan PSE mark
CAB-AC-C19-TW=	Power Cord, 250 V, 16A, C19, Taiwan
CAB-AC-C6K-TWLK=	Power Cord, 250Vac 16A, twist lock NEMA L6-20 plug, US
CAB-AC-2500W-EU=	Power Cord, 250Vac 16A, Europe
CAB-AC-2500W-INT=	Power Cord, 250Vac 16A, INTL
CAB-9K16A-KOR=	Power Cord 250VAC 16A, Korea, Src Plug
CAB-AC-2500W-ISRL=	Power Cord,250VAC,16A,Israel
CAB-AC16A-CH=	16A AC Power Cord For China
R2XX-DMYPWRCORD=	No power cord option
Rail Kit and CMA	
UCSC-RAIL-M6=	Ball Bearing Rail Kit for C220 & C240 M6 rack servers
UCSC-CMA-C220M6=	Reversible CMA for C220 M6 ball bearing rail kit
UCSC-RAIL-NONE=	NO RAIL KIT OPTION
TPM	
UCSX-TPM2-002B-C=	Trusted Platform Module2.0 UCS servers(FIPS 140-2 Compliant)
UCSC-INT-SW02=	Chassis Intrusion Switch
Bezel	
UCSC-BZL-C220M5=	C220 M5 Security Bezel
Software/Firmware	
Windows Server Recovery Media	
MSWS-19-ST16C-RM=	Windows Server 2019 Stan (16 Cores/2 VMs) Rec Media DVD Only
MSWS-19-DC16C-RM=	Windows Server 2019 DC (16Cores/Unlim VM) Rec Media DVD Only
MSWS-22-ST16C-RM=	Windows Server 2022 Stan (16 Cores/2 VMs) Rec Media DVD Only

Table 42 Spare Parts (continued)

Product ID (PID)	PID Description
MSWS-22-DC16C-RM=	Windows Server 2022 DC (16Cores/Unlim VM) Rec Media DVD Only
RHEL SAP	
RHEL-SAPSP-3S=	RHEL SAP Solutions Premium - 3 Years
RHEL-SAPSS-3S=	RHEL SAP Solutions Standard - 3 Years
RHEL-SAPSP-R-1S=	Renew RHEL SAP Solutions Premium - 1 Year
RHEL-SAPSS-R-1S=	Renew RHEL SAP Solutions Standard - 1 Year
RHEL-SAPSP-R-3S=	Renew RHEL SAP Solutions Premium - 3 Years
RHEL-SAPSS-R-3S=	Renew RHEL SAP Solutions Standard -3 Years
VMware vSphere	
VMW-VSP-STD-1A=	VMware vSphere 7 Std (1 CPU, 32 Core) 1-yr, Support Required
VMW-VSP-STD-3A=	VMware vSphere 7 Std (1 CPU, 32 Core) 3-yr, Support Required
VMW-VSP-STD-5A=	VMware vSphere 7 Std (1 CPU, 32 Core) 5-yr, Support Required
VMW-VSP-EPL-1A=	VMware vSphere 7 Ent Plus (1 CPU, 32 Core) 1Yr, Support Reqd
VMW-VSP-EPL-3A=	VMware vSphere 7 Ent Plus (1 CPU, 32 Core) 3Yr, Support Reqd
VMW-VSP-EPL-5A=	VMware vSphere 7 Ent Plus (1 CPU, 32 Core) 5Yr, Support Reqd
VMW-VSP-STD-1S=	VMware vSphere 7 Std (1 CPU, 32 Core), 1-yr VMware SnS Reqd
VMW-VSP-STD-3S=	VMware vSphere 7 Std (1 CPU, 32 Core), 3-yr VMware SnS Reqd
VMW-VSP-STD-1YR	VMware vSphere 7 Std SnS - 1 Year (reports to PID VMW-VSP-STD-1S=)
VMW-VSP-STD-3YR	VMware vSphere 7 Std SnS - 3 Year (reports to PID VMW-VSP-STD-3S=)
VMW-VSP-EPL-1S=	VMware vSphere 7 EntPlus (1 CPU 32 Core) 1Yr VMware SnS Reqd
VMW-VSP-EPL-3S=	VMware vSphere 7 EntPlus (1 CPU 32 Core) 3Yr VMware SnS Reqd
VMW-VSP-EPL-1YR	VMware vSphere 7 Enterprise Plus SnS - 1 Year (reports to PID VMW-VSP-EPL-1S=)
VMW-VSP-EPL-3YR	VMware vSphere 7 Enterprise Plus SnS - 3 Year (reports to PID VMW-VSP-EPL-3S=)
VMware vCenter	
VMW-VCS-STD-1A=	VMware vCenter 7 Server Standard, 1 yr support required
VMW-VCS-STD-3A=	VMware vCenter 7 Server Standard, 3 yr support required
VMW-VCS-STD-5A=	VMware vCenter 7 Server Standard, 5 yr support required
VMW-VCS-STD-1S=	VMware vCenter 7 Server Standard, 1-yr VMware SnS Reqd
VMW-VCS-STD-3S=	VMware vCenter 7 Server Standard, 3-yr VMware SnS Reqd
VMW-VCS-STD-1YR	VMware vCenter 6 Server Standard SnS - 1 Year (reports to PID VMW-VCS-STD-1S=)
VMW-VCS-STD-3YR	VMware vCenter 6 Server Standard SnS - 3 Year (reports to PID VMW-VCS-STD-3S=)
VMW-VCS-FND-1A=	VMware vCenter Server 7 Foundation (4 Host), 1 yr supp reqd
VMW-VCS-FND-3A=	VMware vCenter Server 7 Foundation (4 Host), 3 yr supp reqd
VMW-VCS-FND-5A=	VMware vCenter Server 7 Foundation (4 Host), 5 yr supp reqd
VMW-VCS-FND-1S=	VMware vCenter Server 7 Foundation (4 Host), 1yr VM SnS Reqd
VMW-VCS-FND-3S=	VMware vCenter Server 7 Foundation (4 Host), 3yr VM SnS Reqd

Table 42 Spare Parts (continued)

Product ID (PID)	PID Description
VMW-VCS-FND-1YR	VMware vCenter Server 6 Foundation (4 Host) SnS - 1 Year (reports to PID VMW-VCS-FND-1S=)
VMW-VCS-FND-3YR	VMware vCenter Server 6 Foundation (4 Host) SnS - 3 Year (reports to PID VMW-VCS-FND-3S=)
VMware vSphere Upgrades	
VMW-VSS2VSP-1A=	Upgrade: vSphere 7 Std to vSphere 7 Ent Plus (1 yr Supp Req)
VMW-VSS2VSP-3A=	Upgrade: vSphere 7 Std to vSphere 7 Ent Plus (1 yr Supp Req)

Notes:

1. This part is included with the purchase of option or spare CPU or CPU processor kits.
2. The 2300 W power supply uses a different power connector than the rest of the power supplies, so you must use different power cables to connect it. See [Table 19 on page 41](#) and [Table 20 on page 44](#).

Please refer to “Cisco UCS C245 M6 Server Installation and Service Guide” for installation procedures. See this link:

https://www.cisco.com/content/en/us/td/docs/unified_computing/ucs/c/hw/c245m6/install/c245m6.html

REPLACING CPUs and HEATSINKS



NOTE: Before servicing any CPU, do the following:

- Decommission and power off the server.
- Slide the C245 M6 SFF server out from the rack.
- Remove the top cover.



CAUTION: CPUs and their sockets are fragile and must be handled with extreme care to avoid damaging pins. The CPUs must be installed with heatsinks and thermal interface material to ensure cooling. Failure to install a CPU correctly might result in damage to the server.



CAUTION: Always shut down the server before removing it from the chassis, as described in the procedures. Failure to shut down the server before removal results in the corresponding RAID supercap cache being discarded and other data might be lost.

To replace an existing CPU, follow these steps:

(1) Have the following tools and materials available for the procedure:

- T-20 Torx driver—Supplied with replacement CPU.
- Thermal interface material (TIM)—Syringe supplied with replacement CPU.

(2) Order the appropriate replacement CPU from [Table 5 on page 16](#)

(3) Carefully remove and replace the CPU and heatsink in accordance with the instructions found in “Cisco UCS C245 M6 Server Installation and Service Guide,” found at:

https://www.cisco.com/content/en/us/td/docs/unified_computing/ucs/c/hw/c245m6/install/c245m6.html

To add a new CPU, follow these steps:

(1) Have the following tools and materials available for the procedure:

- T-30 Torx driver—Supplied with new CPU.
- Thermal interface material (TIM)—Syringe supplied with replacement CPU.

(2) Order the appropriate new CPU from [Table 5 on page 16](#)

(3) Order one heat sink for each new CPU. Order PID UCSC-HSHP-245M6 unless you have installed a double-wide or A10 GPU. In that case, order PID UCSC-HSLP-245M6.

(4) Carefully install the CPU and heatsink in accordance with the instructions found in “Cisco UCS C240 M6 Server Installation and Service Guide,” found at:

https://www.cisco.com/content/en/us/td/docs/unified_computing/ucs/c/hw/c245m6/install/c245m6.html

UPGRADING or REPLACING MEMORY



NOTE: Before servicing any DIMM, do the following:

- Decommission and power off the server.
- Remove the top cover from the server
- Slide the server out the front of the chassis.

To add or replace DIMMs, follow these steps:

Step 1 Open both DIMM connector latches.

Step 2 Press evenly on both ends of the DIMM until it clicks into place in its slot

Note: Ensure that the notch in the DIMM aligns with the slot. If the notch is misaligned, it is possible to damage the DIMM, the slot, or both.

Step 3 Press the DIMM connector latches inward slightly to seat them fully.

Step 4 Populate all slots with a DIMM or DIMM blank. A slot cannot be empty.

Figure 18 Replacing Memory

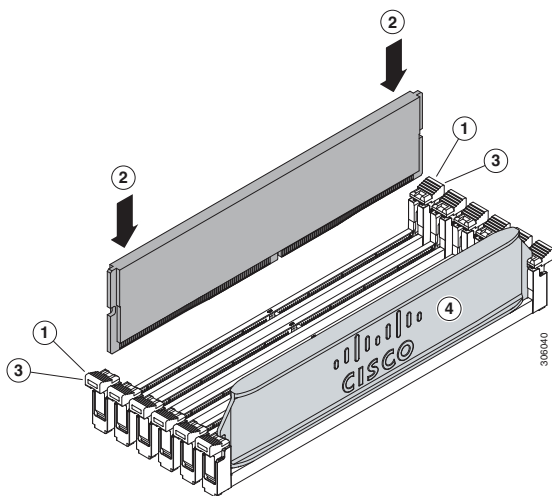

For additional details on replacing or upgrading DIMMs, see “Cisco UCS C240 M6 Server Installation and Service Guide,” found at these links:

https://www.cisco.com/content/en/us/td/docs/unified_computing/ucs/c/hw/c245m6/install/c245m6.html

DISCONTINUED EOL PRODUCTS

Below is the list of parts were previously available for this product and are no longer sold. Please refer to the EOL Bulletin Links via the Table 36 below to determine if still supported.

Table 43 EOS

Product ID	Description	EOL/EOS link
Operating system		
SLES-2SUV-1A	SUSE Linux Enterprise Svr (1-2 CPU,Unl VM); 1-Yr Support Req	
SLES-2SUV-1S	SUSE Linux Enterprise Svr (1-2 CPU,Unl VM); Prio 1-Yr SnS	
SLES-2SUV-3A	SUSE Linux Enterprise Svr (1-2 CPU,Unl VM); 3-Yr Support Req	
SLES-2SUV-3S	SUSE Linux Enterprise Svr (1-2 CPU,Unl VM); Prio 3-Yr SnS	
SLES-2SUV-5A	SUSE Linux Enterprise Svr (1-2 CPU,Unl VM); 5-Yr Support Req	
SLES-2SUV-5S	SUSE Linux Enterprise Svr (1-2 CPU,Unl VM); Prio 5-Yr SnS	
SLES-SAP-2SUV-1A	SLES for SAP Apps w/ HA (1-2 CPU, Unl VM); 1-Yr Support Reqd	
SLES-SAP-2SUV-1S	SLES for SAP Apps (1-2 CPU, Unl VM); Priority 1-Yr SnS	
SLES-SAP-2SUV-3A	SLES for SAP Apps w/ HA (1-2 CPU, Unl VM); 3-Yr Support Reqd	
SLES-SAP-2SUV-3S	SLES for SAP Apps (1-2 CPU, Unl VM); Priority 3-Yr SnS	
SLES-SAP-2SUV-5A	SLES for SAP Apps w/ HA (1-2 CPU, Unl VM); 5-Yr Support Reqd	
SLES-SAP-2SUV-5S	SLES for SAP Apps (1-2 CPU, Unl VM); Priority 5-Yr SnS	
GPU		
UCSC-GPU-A100	TESLA A100, PASSIVE, 250W, 40GB	https://www.cisco.com/c/en/us/products/collateral/servers-unified-computing/ucs-c-series-rack-servers/select-ucs-and-hyperflex-accessories.html
Drives		
UCS-M2-240GB	240GB M.2 SATA Micron G1 SSD	https://www.cisco.com/c/en/us/products/collateral/servers-unified-computing/ucs-c-series-rack-servers/unified-computing-accessories-eol.html
UCS-M2-960GB	960GB M.2 SATA Micron G1 SSD	https://www.cisco.com/c/en/us/products/collateral/servers-unified-computing/ucs-c-series-rack-servers/unified-computing-accessories-eol.html
UCS-NVMEI4-I3840	3.8TB 2.5in U.2 Intel P5500 NVMe High Perf Medium Endurance	https://www.cisco.com/c/en/us/products/collateral/servers-unified-computing/ucs-c-series-rack-servers/select-ucs-access-eol-15074.html

Table 43 EOS

UCS-NVMEI4-I7680	7.6TB 2.5in U.2 Intel P5500 NVMe High Perf Medium Endurance	https://www.cisco.com/c/en/us/products/colateral/servers-unified-computing/ucs-c-series-rack-servers/select-ucs-access-eol-15074.html
UCS-NVMEM6-W6400	6.4TB 2.5in U.2 WD SN840 NVMe Extreme Perf. High Endurance	https://www.cisco.com/c/en/us/products/colateral/servers-unified-computing/ucs-c-series-rack-servers/unified-computing-accessories-eol.html
UCS-NVMEM6-W6400	6.4TB 2.5in U.2 WD SN840 NVMe Extreme Perf. High Endurance	https://www.cisco.com/c/en/us/products/colateral/servers-unified-computing/ucs-c-series-rack-servers/unified-computing-accessories-eol.html
UCS-SD76T61X-EV	7.6TB 2.5 inch Enterprise Value 6G SATA SSD	https://www.cisco.com/c/en/us/products/colateral/servers-unified-computing/ucs-c-series-rack-servers/select-ucs-hyperflex-accessories-eol.html
UCS-SD76TBEM2NK9	7.6TB 2.5in Enter Value 6G SATA Micron G1 SSD (SED)	https://www.cisco.com/c/en/us/products/colateral/servers-unified-computing/ucs-c-series-rack-servers/unified-computing-accessories-eol.html
UCS-SD960GBM2NK9	960GB 2.5in Enter Value 6G SATA Micron G1 SSD (SED)	https://www.cisco.com/c/en/us/products/colateral/servers-unified-computing/ucs-c-series-rack-servers/unified-computing-accessories-eol.html
UCS-SD240GM1X-EV	240GB 2.5in Enter Value 6G SATA Micron G1 SSD	https://www.cisco.com/c/en/us/products/colateral/servers-unified-computing/ucs-c-series-rack-servers/unified-computing-accessories-eol.html
UCS-SD480GM1X-EV	480 GB 2.5in Enter Value 6G SATA Micron G1 SSD	https://www.cisco.com/c/en/us/products/colateral/servers-unified-computing/ucs-c-series-rack-servers/unified-computing-accessories-eol.html
UCS-SD76TM1X-EV	7.6TB 2.5in Enter Value 6G SATA Micron G1 SSD	https://www.cisco.com/c/en/us/products/colateral/servers-unified-computing/ucs-c-series-rack-servers/unified-computing-accessories-eol.html
UCS-SD16TM1X-EV	1.6TB 2.5in Enter Value 6G SATA Micron G1 SSD	https://www.cisco.com/c/en/us/products/colateral/servers-unified-computing/ucs-c-series-rack-servers/unified-computing-accessories-eol.html
UCS-SD38TM1X-EV	3.8TB 2.5in Enter Value 6G SATA Micron G1 SSD	https://www.cisco.com/c/en/us/products/colateral/servers-unified-computing/ucs-c-series-rack-servers/unified-computing-accessories-eol.html
UCS-SD960G61X-EV	960GB 2.5 inch Enterprise Value 6G SATA SSD	https://www.cisco.com/c/en/us/products/colateral/servers-unified-computing/ucs-c-series-rack-servers/select-ucs-hyperflex-accessories-eol.html

TECHNICAL SPECIFICATIONS

Dimensions and Weight

Table 44 UCS C245 M6 Dimensions and Weight

Parameter	Value
Height	3.42 in. (8.7 cm)
Width (Not including slam latches)	16.9 in. (42.9 cm)
Width (including slam latches)	18.9 in. (48.0 cm)
Depth	30 in. (76.2 cm)
Front Clearance	3 in. (76 mm)
Side Clearance	1 in. (25 mm)
Rear Clearance	6 in. (152 mm)
Weight	
Weight with following options and no rail kit: 0 HDD, 0 CPU, 0 DIMM, and 1 2400 W power supply	35.7 lbs (16.2 kg)
Weight with following options and including rail kit: 0 HDD, 0 CPU, 0 DIMM, and 1 2400 W power supply	44 lbs (20 kg)
Weight with following options and no rail kit: 1 HDD, 1 CPU, 1 DIMM, and 1 2400 W power supply	37.6 lbs (17 kg)
Weight with following options and including rail kit: 1 HDD, 1 CPU, 1 DIMM, and 1 2400 W power supply	45.9 lbs (20.8 kg)
Weight with following options and no rail kit: 8 HDDs, 2 CPUs, 32 DIMMs, and 2 2400 W power supplies	44.71 lbs (20.28 kg)
Weight with following options and including rail kit: 8 HDDs, 2 CPUs, 32 DIMMs, and 2 2400 W power supplies	49.2 lbs (22.32 kg)
Weight with following options and no rail kit: 0 HDD, 0 CPU, 0 DIMM, and 1 2400 W power supply	33.14 lbs (15 kg)
Weight with following options and including rail kit: 0 HDD, 0 CPU, 0 DIMM, and 1 2400 W power supply	41.45 lbs (18.8 kg)
Weight with following options and no rail kit: 1 HDD, 1 CPU, 1 DIMM, and 1 2400 W power supply	40.55 lbs (18.4kg)
Weight with following options and including rail kit: 1 HDD, 1 CPU, 1 DIMM, and 1 2400 W power supply	48.86 lbs (22.2 kg)
Weight with following options and no rail kit: 24 HDDs, 2 CPUs, 32 DIMMs, and 2 2400 W power supplies	58.8 lbs (26.7 kg)

Table 44 UCS C245 M6 Dimensions and Weight

Parameter	Value
Weight with following options and including rail kit: 24 HDDs, 2 CPUs, 32 DIMMs, and 2 2400 W power supplies	61.7 lbs (28 kg)

Power Specifications

The server is available with the following types of power supplies:

- 1050 W (AC) power supply (see [Table 45](#)).
- 1050 W V2 (DC) power supply (see [Table 46](#))
- 1600 W (AC) power supply (see [Table 47](#))
- 2300 W (AC) power supply (see [Table 48](#))

Table 45 UCS C245 M6 SFF Power Specifications (1050 W AC power supply)

Parameter	Specification			
Input Connector	IEC320 C14			
Input Voltage Range (V rms)	100 to 240			
Maximum Allowable Input Voltage Range (V rms)	90 to 264			
Frequency Range (Hz)	50 to 60			
Maximum Allowable Frequency Range (Hz)	47 to 63			
Maximum Rated Output (W) ¹	800		1050	
Maximum Rated Standby Output (W)	36			
Nominal Input Voltage (V rms)	100	120	208	230
Nominal Input Current (A rms)	9.2	7.6	5.8	5.2
Maximum Input at Nominal Input Voltage (W)	889	889	1167	1154
Maximum Input at Nominal Input Voltage (VA)	916	916	1203	1190
Minimum Rated Efficiency (%) ²	90	90	90	91
Minimum Rated Power Factor ²	0.97	0.97	0.97	0.97
Maximum Inrush Current (A peak)	15			
Maximum Inrush Current (ms)	0.2			
Minimum Ride-Through Time (ms) ³	12			

Notes:

1. Maximum rated output is limited to 800W when operating at low-line input voltage (100-127V)
2. This is the minimum rating required to achieve 80 PLUS Platinum certification, see test reports published at <http://www.80plus.org/> for certified values
3. Time output voltage remains within regulation limits at 100% load, during input voltage dropout

Table 46 UCS C245 M6 SFF Power Specifications (1050 W V2 DC power supply)

Parameter	Specification
Input Connector	Molex 42820
Input Voltage Range (V rms)	-48
Maximum Allowable Input Voltage Range (V rms)	-40 to -72
Frequency Range (Hz)	NA
Maximum Allowable Frequency Range (Hz)	NA
Maximum Rated Output (W)	1050
Maximum Rated Standby Output (W)	36
Nominal Input Voltage (V rms)	-48
Nominal Input Current (A rms)	24
Maximum Input at Nominal Input Voltage (W)	1154
Maximum Input at Nominal Input Voltage (VA)	1154
Minimum Rated Efficiency (%) ¹	91
Minimum Rated Power Factor ¹	NA
Maximum Inrush Current (A peak)	15
Maximum Inrush Current (ms)	0.2
Minimum Ride-Through Time (ms) ²	5

Notes:

1. This is the minimum rating required to achieve 80 PLUS Platinum certification, see test reports published at <http://www.80plus.org/> for certified values
2. Time output voltage remains within regulation limits at 100% load, during input voltage dropout

Table 47 UCS C245 M6 1600 W (AC) Power Supply Specifications

Parameter	Specification			
Input Connector	IEC320 C14			
Input Voltage Range (V rms)	200 to 240			
Maximum Allowable Input Voltage Range (V rms)	180 to 264			
Frequency Range (Hz)	50 to 60			
Maximum Allowable Frequency Range (Hz)	47 to 63			
Maximum Rated Output (W)	1600			
Maximum Rated Standby Output (W)	36			
Nominal Input Voltage (V rms)	100	120	208	230
Nominal Input Current (A rms)	NA	NA	8.8	7.9
Maximum Input at Nominal Input Voltage (W)	NA	NA	1778	1758
Maximum Input at Nominal Input Voltage (VA)	NA	NA	1833	1813
Minimum Rated Efficiency (%) ¹	NA	NA	90	91
Minimum Rated Power Factor ²	NA	NA	0.97	0.97
Maximum Inrush Current (A peak)	30			
Maximum Inrush Current (ms)	0.2			
Minimum Ride-Through Time (ms) ²	12			

Notes:

1. This is the minimum rating required to achieve 80 PLUS Platinum certification, see test reports published at <http://www.80plus.org/> for certified values
2. Time output voltage remains within regulation limits at 100% load, during input voltage dropout

Table 48 UCS C245 M6 2300 W (AC) Power Supply Specifications

Parameter	Specification			
Input Connector	IEC320 C20			
Input Voltage Range (Vrms)	100 to 240			
Maximum Allowable Input Voltage Range (Vrms)	90 to 264			
Frequency Range (Hz)	50 to 60			
Maximum Allowable Frequency Range (Hz)	47 to 63			
Maximum Rated Output (W) ¹	2300			
Maximum Rated Standby Output (W)	36			
Nominal Input Voltage (Vrms)	100	120	208	230
Nominal Input Current (Arms)	13	11	12	10.8
Maximum Input at Nominal Input Voltage (W)	1338	1330	2490	2480
Maximum Input at Nominal Input Voltage (VA)	1351	1343	2515	2505
Minimum Rated Efficiency (%) ²	92	92	93	93
Minimum Rated Power Factor ²	0.99	0.99	0.97	0.97
Maximum Inrush Current (A peak)	30			
Maximum Inrush Current (ms)	0.2			
Minimum Ride-Through Time (ms) ³	12			

Notes:

1. Maximum rated output is limited to 1200W when operating at low-line input voltage (100-127V)
2. This is the minimum rating required to achieve 80 PLUS Titanium certification, see test reports published at <http://www.80plus.org/> for certified values
3. Time output voltage remains within regulation limits at 100% load, during input voltage dropout

For configuration-specific power specifications, use the Cisco UCS Power Calculator at this URL:

<http://ucspowercalc.cisco.com>

Environmental Specifications

The environmental specifications for the C245 M6 SFF server are listed in [Table 49](#).

Table 49 UCS C245 M6 SFF Environmental Specifications

Parameter	Minimum
Operating Temperature	<p>Dry bulb temperature of 10°C to 35°C (50°F to 95°F)</p> <p>Maximum temperature change of 20°C (36°F) per hour (a temperature change within a specified period of time and not a rate of change)</p> <p>Humidity condition: Uncontrolled, not to exceed 50% RH starting condition</p> <p>Derate the maximum temperature by 1°C (33.8°F) per every 305 meters of altitude above 900m</p>
Extended Operating Temperature	<p>5°C to 40°C (41°F to 104°F) with no direct sunlight</p> <p>Humidity condition: Uncontrolled, not to exceed 50% RH starting condition</p> <p>Derate the maximum temperature by 1°C (33.8°F) per every 305 meters of altitude above 900m</p>
Non-Operating Temperature	Dry bulb temperature of -40°C to 65°C (-40°F to 149°F)
Operating Relative Humidity	<p>10% to 90% and 28°C (82.4°F) maximum dew-point temperature, non-condensing environment</p> <p>Minimum to be higher (more moisture) of -12°C (10.4°F) dew point or 8% relative humidity</p> <p>Maximum to be 24°C (75.2°F) dew point or 90% relative humidity</p>
Non-Operating Relative Humidity	5% to 93% relative humidity, non-condensing, with a maximum wet bulb temperature of 28°C across the 20°C to 40°C dry bulb range.
Maximum Operating Duration	Unlimited
Operating Altitude	A maximum elevation of 3050 meters (10,006 ft)
Non-Operating Altitude	An elevation of 0 to 12,000 meters (39,370 ft)
Sound Power level, Measure A-weighted per ISO7779 LWAd (Bels) Operation at 23°C (73°F)	5.5
Sound Pressure level, Measure A-weighted per ISO7779 LpAm (dBA) Operation at 23°C (73°F)	40

Extended Operating Temperature Hardware Configuration Limits

Table 50 Cisco UCS C245 M6 Extended Operating Temperature Hardware Configuration Limits

Platform ¹	ASHRAE A3 (5°C to 40°C) ²	ASHRAE A4 (5°C to 45°C) ³
Processors:	155W+	155W+ and 105W+ (4 or 6 Cores)
Memory:	LRDIMMs	LRDIMMs
Storage:	M.2 SATA SSDs NVMe SSDs	M.2 SATA SSDs NVMe SSDs HDDs or SSDs (Rear Bays)
Peripherals:	PCIe NVMe SSDs GPUs	PCIe NVMe SSDs GPUs VICs (Slots 1 and 4) NICs (Slots 1 and 4) HBAs (Slots 1 and 4)

Notes:

1. Two PSUs are required and PSU failure is not supported
2. Non-Cisco UCS qualified peripherals and/or peripherals that consume more than 25W are not supported
3. High power or maximum power fan control policy must be applied

Compliance Requirements

The regulatory compliance requirements for C-Series servers are listed in [Table 51](#)

Table 51 UCS C-Series Regulatory Compliance Requirements

Parameter	Description
Regulatory Compliance	Products should comply with CE Markings per directives 2014/30/EU and 2014/35/EU
Safety	UL 60950-1 Second Edition CAN/CSA-C22.2 No. 60950-1 Second Edition EN 60950-1 Second Edition IEC 60950-1 Second Edition AS/NZS 60950-1 GB4943 2001
EMC - Emissions	47CFR Part 15 (CFR 47) Class A AS/NZS CISPR32 Class A CISPR32 Class A EN55032 Class A ICES003 Class A VCCI Class A EN61000-3-2 EN61000-3-3 KN32 Class A CNS13438 Class A
EMC - Immunity	EN55024 CISPR24 EN300386 KN35



Americas Headquarters
Cisco Systems, Inc.
San Jose, CA

Asia Pacific Headquarters
Cisco Systems (USA) Pte. Ltd.
Singapore

Europe Headquarters
Cisco Systems International BV Amsterdam,
The Netherlands

Cisco has more than 200 offices worldwide. Addresses, phone numbers, and fax numbers are listed on the Cisco Website at www.cisco.com/go/offices.

Cisco and the Cisco Logo are trademarks of Cisco Systems, Inc. and/or its affiliates in the U.S. and other countries. A listing of Cisco's trademarks can be found at www.cisco.com/go/trademarks. Third party trademarks mentioned are the property of their respective owners. The use of the word partner does not imply a partnership relationship between Cisco and any other company. (1005R)

