



## **Cisco Nexus 7000 Series Virtual Device Context Configuration Guide**

**First Published:** 2014-10-17

**Last Modified:** 2017-02-07

### **Americas Headquarters**

Cisco Systems, Inc.  
170 West Tasman Drive  
San Jose, CA 95134-1706  
USA  
<http://www.cisco.com>  
Tel: 408 526-4000  
800 553-NETS (6387)  
Fax: 408 527-0883

THE SPECIFICATIONS AND INFORMATION REGARDING THE PRODUCTS IN THIS MANUAL ARE SUBJECT TO CHANGE WITHOUT NOTICE. ALL STATEMENTS, INFORMATION, AND RECOMMENDATIONS IN THIS MANUAL ARE BELIEVED TO BE ACCURATE BUT ARE PRESENTED WITHOUT WARRANTY OF ANY KIND, EXPRESS OR IMPLIED. USERS MUST TAKE FULL RESPONSIBILITY FOR THEIR APPLICATION OF ANY PRODUCTS.

THE SOFTWARE LICENSE AND LIMITED WARRANTY FOR THE ACCOMPANYING PRODUCT ARE SET FORTH IN THE INFORMATION PACKET THAT SHIPPED WITH THE PRODUCT AND ARE INCORPORATED HEREIN BY THIS REFERENCE. IF YOU ARE UNABLE TO LOCATE THE SOFTWARE LICENSE OR LIMITED WARRANTY, CONTACT YOUR CISCO REPRESENTATIVE FOR A COPY.

The Cisco implementation of TCP header compression is an adaptation of a program developed by the University of California, Berkeley (UCB) as part of UCB's public domain version of the UNIX operating system. All rights reserved. Copyright © 1981, Regents of the University of California.

NOTWITHSTANDING ANY OTHER WARRANTY HEREIN, ALL DOCUMENT FILES AND SOFTWARE OF THESE SUPPLIERS ARE PROVIDED "AS IS" WITH ALL FAULTS. CISCO AND THE ABOVE-NAMED SUPPLIERS DISCLAIM ALL WARRANTIES, EXPRESSED OR IMPLIED, INCLUDING, WITHOUT LIMITATION, THOSE OF MERCHANTABILITY, FITNESS FOR A PARTICULAR PURPOSE AND NON-INFRINGEMENT OR ARISING FROM A COURSE OF DEALING, USAGE, OR TRADE PRACTICE.

IN NO EVENT SHALL CISCO OR ITS SUPPLIERS BE LIABLE FOR ANY INDIRECT, SPECIAL, CONSEQUENTIAL, OR INCIDENTAL DAMAGES, INCLUDING, WITHOUT LIMITATION, LOST PROFITS OR LOSS OR DAMAGE TO DATA ARISING OUT OF THE USE OR INABILITY TO USE THIS MANUAL, EVEN IF CISCO OR ITS SUPPLIERS HAVE BEEN ADVISED OF THE POSSIBILITY OF SUCH DAMAGES.

Any Internet Protocol (IP) addresses and phone numbers used in this document are not intended to be actual addresses and phone numbers. Any examples, command display output, network topology diagrams, and other figures included in the document are shown for illustrative purposes only. Any use of actual IP addresses or phone numbers in illustrative content is unintentional and coincidental.

All printed copies and duplicate soft copies of this document are considered uncontrolled. See the current online version for the latest version.

Cisco has more than 200 offices worldwide. Addresses and phone numbers are listed on the Cisco website at [www.cisco.com/go/offices](http://www.cisco.com/go/offices).

Cisco and the Cisco logo are trademarks or registered trademarks of Cisco and/or its affiliates in the U.S. and other countries. To view a list of Cisco trademarks, go to this URL: <https://www.cisco.com/c/en/us/about/legal/trademarks.html>. Third-party trademarks mentioned are the property of their respective owners. The use of the word partner does not imply a partnership relationship between Cisco and any other company. (1721R)

© 2008–2017 Cisco Systems, Inc. All rights reserved.



## CONTENTS

---

### PREFACE

#### **Preface** vii

Preface vii

Audience vii

Document Conventions vii

Related Documentation viii

Documentation Feedback ix

Communications, Services, and Additional Information ix

---

### CHAPTER 1

#### **New and Changed Information** 1

New and Changed Information 1

---

### CHAPTER 2

#### **Overview** 5

Licensing Requirements 5

Information About VDCs 5

VDC Architecture 7

Kernel and Infrastructure Layer 7

MAC Addresses 7

Default VDC 8

Communication Between VDCs 8

Storage VDCs 8

VDC Resources 8

Physical Resources 9

Logical Resources 13

VDC Resource Templates 14

Configuration Files 14

VDC Management 14

VDC Default User Roles	14
Configuration Modes	15
VDC Management Connections	16
VDC Fault Isolation	17
VDC Module Type Compatibility	18
Cisco NX-OS Feature Support in VDCs	18

---

**CHAPTER 3**

<b>Configuring an Admin VDC</b>	<b>21</b>
Finding Feature Information	21
Information About Admin VDCs	21
Prerequisites for Admin VDCs	22
Creating an Admin VDC	22
Guidelines and Limitations for Creating Admin VDCs	22
Configuring an Admin VDC	23
Configuration Examples for Admin VDCs	24
Related Documents for Admin VDCs	25
Feature History for Admin VDCs	25

---

**CHAPTER 4**

<b>Configuring VDC Resource Templates</b>	<b>27</b>
Finding Feature Information	27
Information About VDC Resource Templates	27
Guidelines and Limitations for VDC Resource Templates	29
VDC Resource Templates	29
Configuring VDC Resource Templates	30
Verifying the VDC Resource Template Configuration	31
Configuration Example for VDC Resource Template	31
Related Documents for VDC Resource Templates	32
Feature History for VDC Resource Templates	32

---

**CHAPTER 5**

<b>Creating VDCs</b>	<b>35</b>
Finding Feature Information	35
Information About Creating VDCs	35
Storage VDCs	36
High-Availability Policies	36

Allocating Interfaces	37
VDC Management Connections	40
Initializing a New VDC	40
Prerequisites for Creating VDCs	40
Guidelines and Limitations for Creating VDCs	41
Default Settings for Creating VDCs	42
Process for Creating VDCs	42
Creating VDCs	43
Initializing a VDC	45
Verifying the VDC Configuration	46
Configuration Example for Ethernet VDC Creation and Initialization	47
Configuration Examples for Default and Nondefault VDCs	50
Example Running Configuration from the Default VDC	50
Example Running Configuration from a Nondefault VDC	50
Related Documents for Creating VDCs	50
Feature History for Creating VDCs	51

---

**CHAPTER 6**
**Managing VDCs 53**

Finding Feature Information	53
Information About Managing VDCs	53
Interface Allocation	54
VDC Resource Limits	68
HA Policies	68
Saving All VDC Configurations to the Startup Configuration	68
Suspending and Resuming VDCs	68
VDC Reloads	69
MAC Addresses	69
VDC Boot Order	69
Prerequisites for Managing VDCs	70
Guidelines and Limitations for Managing VDCs	70
Managing VDCs	73
Changing the Nondefault VDC Prompt Format	73
Allocating Interfaces to an Ethernet VDC	74
Applying a VDC Resource Template	75

Changing VDC Resource Limits	75
F2e Proxy Mode	79
M2-M3 VDC and Interoperability mode	81
Configuring VDC Resource Limits	82
Displaying show vdc detail Output	85
Changing the HA Policies	85
Saving VDC Configurations	87
Suspending a Nondefault VDC	88
Resuming a Nondefault VDC	88
Reloading a Nondefault VDC	88
Configuring the VDC Boot Order	89
Deleting a VDC	90
Verifying the VDC Configuration	91
Configuration Examples for VDC Management	91
Related Documents for Managing VDCs	92
Feature History for Managing VDCs	92

---

**APPENDIX A**      **VDC Configuration Limits**    95



# Preface

---

The preface contains the following sections:

- [Preface, on page vii](#)

## Preface

This preface describes the audience, organization, and conventions of the Book Title. It also provides information on how to obtain related documentation.

This chapter includes the following topics:

## Audience

This publication is for experienced network administrators who configure and maintain Cisco NX-OS on Cisco Nexus 7000 Series Platform switches.

## Document Conventions



### Note

- As part of our constant endeavor to remodel our documents to meet our customers' requirements, we have modified the manner in which we document configuration tasks. As a result of this, you may find a deviation in the style used to describe these tasks, with the newly included sections of the document following the new format.
- The Guidelines and Limitations section contains general guidelines and limitations that are applicable to all the features, and the feature-specific guidelines and limitations that are applicable only to the corresponding feature.

Command descriptions use the following conventions:

Convention	Description
<b>bold</b>	Bold text indicates the commands and keywords that you enter literally as shown.
<i>Italic</i>	Italic text indicates arguments for which the user supplies the values.

Convention	Description
[x]	Square brackets enclose an optional element (keyword or argument).
[x   y]	Square brackets enclosing keywords or arguments separated by a vertical bar indicate an optional choice.
{x   y}	Braces enclosing keywords or arguments separated by a vertical bar indicate a required choice.
[x {y   z}]	Nested set of square brackets or braces indicate optional or required choices within optional or required elements. Braces and a vertical bar within square brackets indicate a required choice within an optional element.
<i>variable</i>	Indicates a variable for which you supply values, in context where italics cannot be used.
string	A nonquoted set of characters. Do not use quotation marks around the string or the string will include the quotation marks.

Examples use the following conventions:

Convention	Description
<code>screen font</code>	Terminal sessions and information the switch displays are in screen font.
<b>boldface screen font</b>	Information you must enter is in boldface screen font.
<i>italic screen font</i>	Arguments for which you supply values are in italic screen font.
<>	Nonprinting characters, such as passwords, are in angle brackets.
[ ]	Default responses to system prompts are in square brackets.
!, #	An exclamation point (!) or a pound sign (#) at the beginning of a line of code indicates a comment line.

This document uses the following conventions:



**Note** Means *reader take note*. Notes contain helpful suggestions or references to material not covered in the manual.



**Caution** Means *reader be careful*. In this situation, you might do something that could result in equipment damage or loss of data.

## Related Documentation

Documentation for Cisco Nexus 7000 Series Switches is available at:

- Configuration Guides



<http://www.cisco.com/c/en/us/support/switches/nexus-7000-series-switches/products-installation-and-configuration-guides-list.html>

- Command Reference Guides

<http://www.cisco.com/c/en/us/support/switches/nexus-7000-series-switches/products-command-reference-list.html>

- Release Notes

<http://www.cisco.com/c/en/us/support/switches/nexus-7000-series-switches/products-release-notes-list.html>

- Install and Upgrade Guides

<http://www.cisco.com/c/en/us/support/switches/nexus-7000-series-switches/products-installation-guides-list.html>

- Licensing Guide

<http://www.cisco.com/c/en/us/support/switches/nexus-7000-series-switches/products-licensing-information-listing.html>

Documentation for Cisco Nexus 7000 Series Switches and Cisco Nexus 2000 Series Fabric Extenders is available at the following URL:

<http://www.cisco.com/c/en/us/support/switches/nexus-2000-series-fabric-extenders/products-installation-and-configuration-guides-list.html>

## Documentation Feedback

To provide technical feedback on this document, or to report an error or omission, please send your comments to [nexus7k-docfeedback@cisco.com](mailto:nexus7k-docfeedback@cisco.com). We appreciate your feedback.

## Communications, Services, and Additional Information

- To receive timely, relevant information from Cisco, sign up at [Cisco Profile Manager](#).
- To get the business impact you're looking for with the technologies that matter, visit [Cisco Services](#).
- To submit a service request, visit [Cisco Support](#).
- To discover and browse secure, validated enterprise-class apps, products, solutions and services, visit [Cisco Marketplace](#).
- To obtain general networking, training, and certification titles, visit [Cisco Press](#).
- To find warranty information for a specific product or product family, access [Cisco Warranty Finder](#).

### Cisco Bug Search Tool

[Cisco Bug Search Tool](#) (BST) is a web-based tool that acts as a gateway to the Cisco bug tracking system that maintains a comprehensive list of defects and vulnerabilities in Cisco products and software. BST provides you with detailed defect information about your products and software.





# CHAPTER 1

## New and Changed Information

This chapter describes new and changed features.

- [New and Changed Information](#), on page 1

## New and Changed Information

Your software release might not support all the features in this document. For the latest caveats and feature information, see the Bug Search Tool at <https://tools.cisco.com/bugsearch/> and the release notes for your software release.

*Table 1: New and Changed Features*

Feature	Description	Changed in Release
VDC Resource Limits	Added support for M3 Series modules.  The range for maximum value changed for the <b>limit-resource m6route-mem</b> commands.	7.3(0)D1(1)
Support for F3 Series modules.	Added support for F3 Series modules.	6.2(6)
Cisco Nexus 7710 switch and Cisco Nexus 7718 switch	Added support for the Cisco Nexus 7710 switch and the Cisco Nexus 7718 switch on the Supervisor 2e module.	6.2(2)
Supervisor 1 module	Added support for Admin VDC on Supervisor 1 module.	6.2(2)
F2e Series module	Added the ability to enable the F2e Series module (a new configurable VDC module type, independent from and separate to the F2 VDC module type) on the chassis.	6.2(2)

Feature	Description	Changed in Release
Switchwide VDC mode	Added the ability to enable specific line cards in the chassis and prevent others from powering on.	6.1(3)
Support for F2e Series module	Added support for F2e Series as part of F2 Series modules.	6.1(2)
Admin VDC	Added support for admin VDC.	6.1(1)
Supervisor modules, Number of VDCs and storage VDCs.	Added support for the new supervisor modules and the supported number of VDCs. Added support for storage VDCs.	6.1(1)
CPU Shares	Added support for CPU shares on a VDC.	6.1(1)
VDC resource limits	Added support for M2 Series modules.	6.1(1)
VDC resource limits	Added support for F2 Series modules.	6.0(1)
FCoE	Added support for storage VDCs and the FCoE feature.	5.2(1)
MAC addresses	The default VDC has a MAC address, and subsequent nondefault VDCs that are created are assigned MAC addresses.	5.2(1)
VDC resource limits	Added support for M Series modules.	5.2(1)
N7K-F132XP-15 module	Added support for the N7K-F132XP-15 module.	5.1(1)
VDC resource limits	Added the ability to configure ERSPAN monitor session resource limits.	5.1(1)
VDC resource limits	The range for the minimum and maximum values changed for the <b>limit-resource m4route-mem</b> , <b>limit-resource m6route-mem</b> , <b>limit-resource u4route-mem</b> , <b>limit-resource u6route-mem</b> , and <b>limit-resource vrf</b> commands.	5.0(2)
Restarting VDCs	The <b>vdc restart</b> command was replaced by the <b>reload vdc</b> command.	4.2(4)

Feature	Description	Changed in Release
Suspending and resuming VDCs	You can suspend and resume nondefault VDCs.	4.2(1)
Restarting VDCs	You can restart active nondefault VDCs and nondefault VDCs in the failed state.	4.2(1)
Reloading VDCs	You can reload nondefault VDCs.	4.2(1)
VDC prompt format	You can change the format of the CLI prompt for nondefault VDCs.	4.2(1)
VDC boot order	You can configure the boot order for nondefault VDCs.	4.2(1)
VDCs and tunnel interfaces	You can put tunnel interfaces into nondefault VDCs and VRFs.	4.2(1)
IPv4 and IPv6 unicast route memory resources	Changed the default value for the maximum limits.	4.1(2)
Multicast route memory resources	Added IPv4 and IPv6 multicast route memory resources.	4.1(2)
Port channel resource	Changed the default value for the maximum limit.	4.1(2)
IPv4 unicast route memory resource	Changed the default maximum value from 256 to 320.	4.0(2)
IPv6 unicast route memory resource	Changed the default maximum value from 256 to 192.	4.0(2)





## CHAPTER 2

# Overview

---

This chapter describes virtual device contexts (VDCs) supported on Cisco NX-OS devices.

- [Licensing Requirements, on page 5](#)
- [Information About VDCs, on page 5](#)
- [VDC Architecture, on page 7](#)
- [VDC Resources, on page 8](#)
- [VDC Management, on page 14](#)
- [VDC Fault Isolation, on page 17](#)
- [VDC Module Type Compatibility, on page 18](#)
- [Cisco NX-OS Feature Support in VDCs, on page 18](#)

## Licensing Requirements

For a complete explanation of Cisco NX-OS licensing recommendations and how to obtain and apply licenses, see the [Cisco NX-OS Licensing Guide](#).

## Information About VDCs

The Cisco NX-OS software supports VDCs, which partition a single physical device into multiple logical devices that provide fault isolation, management isolation, address allocation isolation, service differentiation domains, and adaptive resource management. You can manage a VDC instance within a physical device independently. Each VDC appears as a unique device to the connected users. A VDC runs as a separate logical entity within the physical device, maintains its own unique set of running software processes, has its own configuration, and can be managed by a separate administrator.

VDCs also virtualize the control plane, which includes all those software functions that are processed by the CPU on the active supervisor module. The control plane supports the software processes for the services on the physical device, such as the routing information base (RIB) and the routing protocols.

Beginning with Cisco NX-OS Release 5.2(1) for the Nexus 7000 Series devices, you can configure Fibre Channel over Ethernet (FCoE). See the Cisco NX-OS FCoE Configuration Guide for Cisco Nexus 7000 and Cisco MDS 9500 for information about FCoE. Beginning with Cisco NX-OS Release 6.1(1), you can enable FCoE on the F248XP-25[E] Series with Supervisor 2 and Supervisor 2e modules. You must configure a dedicated storage VDC to run FCoE on the Cisco Nexus 7000 Series devices. See Chapter 5, “Managing VDCs,” for information about configuring storage VDCs.

Beginning with Cisco NX-OS Release 6.2(2), the Supervisor 1 module supports an admin VDC with the same functionalities of Supervisor 2/2e modules. You can only allocate mgmt0 interface to the admin VDC. The Supervisor 2e module supports the new Cisco Nexus 7718 switch and the Cisco Nexus 7710 switches. These switches support F2e line cards only. For more information, see the Cisco Nexus 7000 Series Hardware Installation and Reference Guide.

When upgrading from any releases prior to Release 6.2(2) by changing the boot variables and rebooting with the new code using a manual upgrade, all the interfaces assigned to default VDC (VDC 1) after the upgrade might become unallocated. You cannot perform configuration conversion or data structure conversion during a manual upgrade. You might be required to manually allocate the interfaces to the correct non-admin VDC and copy all configurations to startup and reload the switch. Verify using the **show vdc membership** command.

When you create a VDC, the Cisco NX-OS software takes several of the control plane processes and replicates them for the VDC. This replication of processes allows VDC administrators working in Ethernet VDCs to use virtual routing and forwarding (VRF) instance names and VLAN IDs independent of those used in other VDCs. Each VDC administrator essentially interacts with a separate set of processes, VRFs, and VLANs.



**Note** However, the numbers must be unique between FCoE and Ethernet VLANs. That is, the numbers used on the FCoE VLANs in the storage VDCs must be different than any of the VLAN numbers used in the Ethernet VDCs. You can repeat VLAN numbers within separate Ethernet VDCs. The VLAN numbering space for FCoE and Ethernet is shared only for those VDCs configured for port sharing. See the Cisco NX-OS FCoE Configuration Guide for Cisco Nexus 7000 and Cisco MDS 9500 for information about configuring FCoE.

The figure below shows how the Cisco NX-OS software segments the physical device into VDCs. The benefits include VDC-level fault isolation, VDC-level administration, separation of data traffic, and enhanced security.

**Figure 1: Segmentation of a Physical Device**

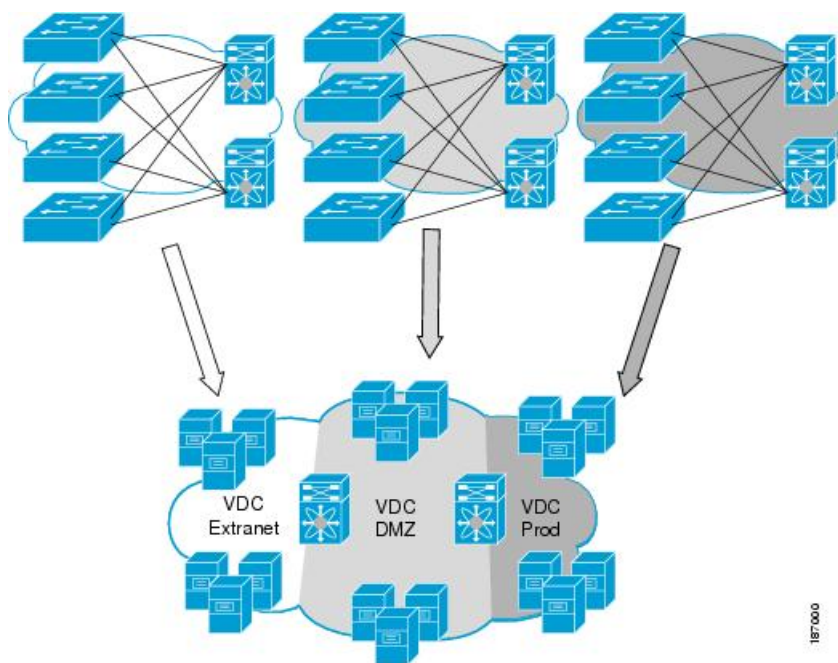



# VDC Architecture

The Cisco NX-OS software provides the base upon which VDCs are supported.

## Kernel and Infrastructure Layer

The basis of the Cisco NX-OS software is the kernel and infrastructure layer. A single instance of the kernel supports all of the processes and VDCs that run on the physical device. The infrastructure layer provides an interface between the higher layer processes and the hardware resources of the physical device, such as the ternary content addressable memory (TCAM). Having a single instance of this layer reduces the complexity for the management of the hardware resources and helps scale the Cisco NX-OS software performance by avoiding duplication of the system management process (see the figure below).

The infrastructure also enforces isolation across VDCs. A fault that is generated within a VDC does not impact the services in other VDCs. This feature limits the impact of software faults and greatly improves the reliability of the device.

Along with the infrastructure layer, some nonvirtualized services have only a single instance for all VDCs. These infrastructure services participate in creating VDCs, moving resources across VDCs, and monitoring individual protocol services within a VDC.

The Cisco NX-OS software creates a virtualized control plane for each VDC. The virtualized control plane within the VDCs processes all the protocol-related events.

All the Layer 2 and Layer 3 protocol services run within a VDC. Each protocol service that is started within a VDC runs independently of the protocol services in other VDCs. The infrastructure layer protects the protocol services within a VDC so that a fault or other problem in a service in one VDC does not impact other VDCs. The Cisco NX-OS software creates these virtualized services only when a VDC is created. Each VDC has its own instance of each service. These virtualized services are unaware of other VDCs and only work on resources that are assigned to that VDC. Only a user with the network-admin role can control the resources available to these virtualized services.

**Figure 2: VDC Architecture**

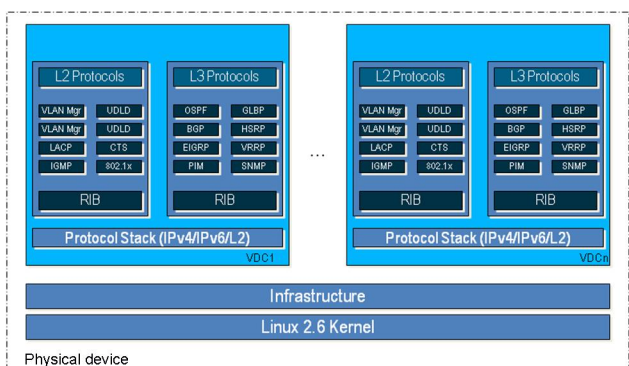

## MAC Addresses

The default VDC has a MAC address. Subsequent nondefault VDCs that you create are assigned MAC addresses automatically as part of the bootup process.

## Default VDC

The physical device always has at least one VDC, the default VDC (VDC 1). When you first log in to a new Cisco NX-OS device, you begin in the default VDC. You must be in the default VDC or admin VDC to create, change attributes for, or delete a nondefault VDC. Cisco NX-OS releases prior to 6.1 can support up to four VDCs, including the default VDC, which means that you can create up to three nondefault VDCs.

If you have the network-admin role privileges, you can manage the physical device and all VDCs from the default VDC.

## Communication Between VDCs

The Cisco NX-OS software does not support direct communication between VDCs on a single physical device. You must make a physical connection from a port allocated to one VDC to a port allocated to the other VDC to allow the VDCs to communicate.

## Storage VDCs

The storage VDC is one of the nondefault VDCs and it does need a license. However, a storage VDC does not need a VDC license because it relies on the FCoE license installed to enable the FCoE function on the modules. Beginning with Cisco NX-OS Release 5.2(1) for the Nexus 7000 Series devices, you can run FCoE on the F1, F2 and F2e Series modules, depending upon your specific release version. You can create separate storage VDCs to run FCoE. You can have only one storage VDC on the device, and you cannot configure the default VDC as a storage VDC.

**Note**

Starting with Cisco NX-OS Release 6.2(2), we do not support the interoperability of F1 and F2 Series modules in any VDC, either in a dedicated mode or in a shared mode. If you have configured F1 and F2 Series modules as supported line cards in a storage VDC during an In-Service Software Upgrade (ISSU) to Cisco NX-OS Release 6.2(2) or later releases, before ISSU, reconfigure your storage VDC by using the `limit-resource module-type` command (for information, see the “Changing VDC Resource Limits” section) to avoid any unnecessary disruption to the system.

After you create the storage VDC, you assign specified FCoE VLANs. Finally, you configure interfaces on the Cisco Nexus 7000 Series device as either dedicated FCoE interfaces or as shared interfaces, which can carry both Ethernet and FCoE traffic. See the *Cisco NX-OS FCoE Configuration Guide for Cisco Nexus 7000 and Cisco MDS 9500* for information on configuring FCoE.

## VDC Resources

If you have the network-admin user role, you can allocate physical device resources exclusively for the use of a VDC. Once a resource is assigned to a specific VDC, you can manage it only from that VDC. The Cisco NX-OS software allows you to control how the logical and physical resources are assigned to each VDC. Users logging directly into the VDC can only see this limited view of the device and can manage only those resources that the network administrator explicitly assigns to that VDC. Users within a VDC cannot view or modify resources in other VDCs.



---

**Note** You must have the network-admin role to allocate resources to a VDC

---

## Physical Resources

The only physical resources that you can allocate to a VDC are the Ethernet interfaces. For the Ethernet VDCs, each physical Ethernet interface can belong to only one VDC, including the default VDC, at any given time. When you are working with shared interfaces in the storage VDC, the physical interface can belong to both one Ethernet VDC and one storage VDC simultaneously, but to no more than one of each.

Initially, all physical interfaces belong to the default VDC (VDC 1). When you create a new VDC, the Cisco NX-OS software creates the virtualized services for the VDC without allocating any physical interfaces to it. After you create a new VDC, you can allocate a set of physical interfaces from the default VDC to the new VDC.

When you allocate an interface to a VDC, all configuration for that interface is erased. You, or the VDC administrator, must configure the interface from within the VDC. Only the interfaces allocated to the VDC are visible for configuration.



---

**Note** Beginning with Cisco NX-OS Release 5.2(1) for Nexus 7000 Series devices, all members of a port group are automatically allocated to the VDC when you allocate an interface.

---

The following Cisco Nexus 7000 Series Ethernet modules have the following number of port groups and interfaces:

- N7K-M202CF-22L (1 interface x 2 port groups = 2 interfaces 100G modules)—There are no restrictions on the interface allocation between VDCs.
- N7K-M206FQ-23L (1 interface x 6 port groups = 6 interfaces 40G modules)—There are no restrictions on the interface allocation between VDCs.
- N7K-M224XP-23L (1 interface x 24 port groups = 24 interfaces 10G modules)—There are no restrictions on the interface allocation between VDCs.
- N7K-M108X2-12L (1 interface x 8 port groups = 8 interfaces)—There are no restrictions on the interface allocation between VDCs.
- N7K-M148GS-11L, N7K-M148GT-11, N7K-M148GS-11 (12 interfaces x 4 port groups = 48 interfaces) and N7K-M148GT-11L (same as non-L M148) (1 interface x 48 port groups = 48 interfaces)—There are no restrictions on the interface allocation between VDCs, but we recommend that interfaces that belong to the same port group be in a single VDC.
- N7K-M132XP-12 (4 interfaces x 8 port groups = 32 interfaces) and N7K-M132XP-12L (same as non-L M132) (1 interface x 8 port groups = 8 interfaces)—All M132 cards require allocation in groups of 4 ports and you can configure 8 port groups. Interfaces belonging to the same port group must belong to the same VDC. See the example for this module in Figure 1-3.
- N7K-M132XP-12L (same as non-L M132) (1 interface x 8 port groups = 8 interfaces)—All M132 cards require allocation in groups of 4 ports and you can configure 8 port groups.

**Figure 3: Example Interface Allocation for Port Groups on a Cisco 7000 Series 10-Gbps Ethernet Module (N7K-M132XP-12)**

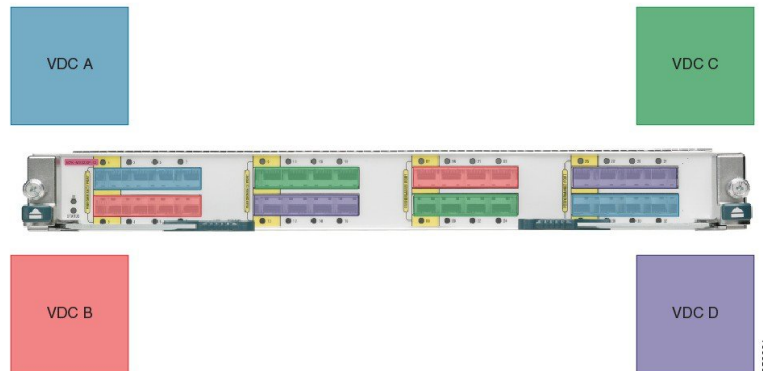

On the Cisco Nexus 7000 Series 32-port, 10-Gbps Ethernet module N7K-F132XP-15, you must allocate the interfaces on your physical device in the specified combination. This module has 16 port groups that consist of 2 ports each (2 interfaces x 16 port groups = 32 interfaces). Interfaces that belong to the same port group must belong to the same VDC (see the figure below). For more information about ports that can be paired. For more information about implementing FCoE on this module, see the *Cisco NX-OS FCoE Configuration Guide for Cisco Nexus 7000 and Cisco MDS 9500*.

**Figure 4: Example Interface Allocation for Port Groups on a Cisco 7000 Series 10-Gbps Ethernet Module (N7K-F132XP-15)**



On the Cisco Nexus 7000 Series 48-port, 10-Gbps Ethernet modules N7K-F248XP-25[E] and N7K-F248XT-25[E], you must allocate the interfaces on your physical device in the specified combination. These modules have 12 port groups that consist of 4 ports each (4 interfaces x 12 port groups = 48 interfaces). Interfaces that belong to the same port group must belong to the same VDC (see the figure below).

**Figure 5: Example Interface Allocation for Port Groups on the Cisco Nexus 7000 Series 10-Gbps Ethernet Module N7K-F248XP-25[E] and N7K-F248XT-25[E]**

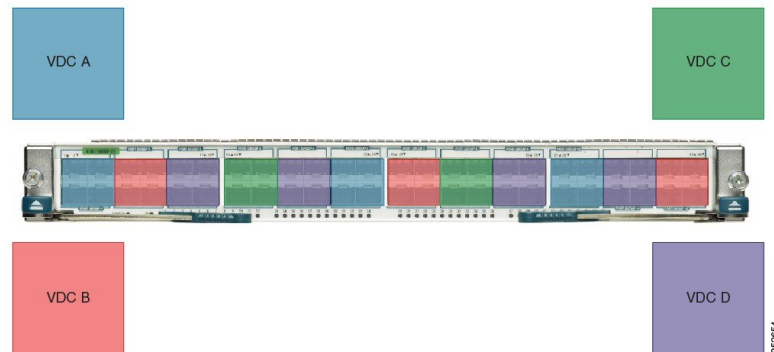

For more information on port groups on the Cisco Nexus 7000 Series 10-Gbps Ethernet modules, see the *Cisco Nexus 7000 Series Hardware Installation and Reference Guide*.

On the Cisco Nexus 7000 Series 12-port, 40-Gbps Ethernet modules N7K-F312FQ-25, you must allocate the interfaces on your physical device in the specified combination. These modules have 6 port groups that consist of 2 ports each (2 interfaces x 6 port groups = 12 interfaces). Interfaces that belong to the same port group must belong to the same VDC.

**Figure 6: Cisco Nexus 7000 Series 12-port, 40-Gbps Ethernet modules N7K-F312FQ-25**

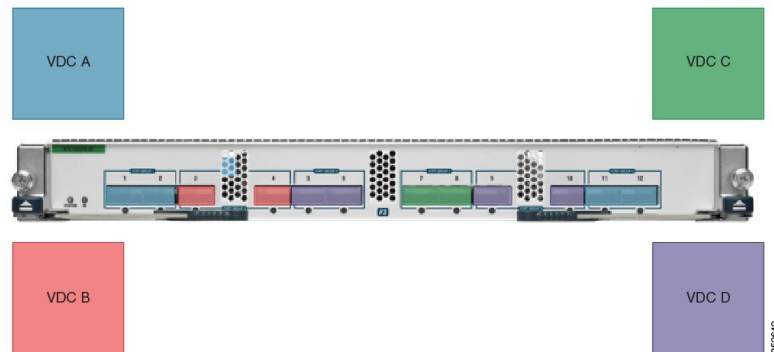

On the Cisco Nexus 7700 Series 48-port, 10-Gbps Ethernet modules N7K-F348XP-25, you must allocate the interfaces on your physical device in the specified combination. These modules have 6 port groups that consist of 8 ports each (8 interfaces x 6 port groups = 48 interfaces). Interfaces that belong to the same port group must belong to the same VDC.

**Figure 7: Cisco Nexus 7700 Series 48-port, 10-Gbps Ethernet modules N77-F348XP-25**

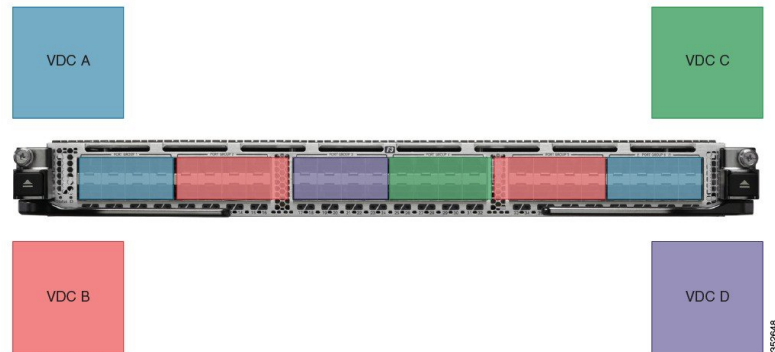

On the Cisco Nexus 7700 Series 24-port, 40-Gbps Ethernet modules N7K-F324QF-25, you must allocate the interfaces on your physical device in the specified combination. These modules have 12 port groups that consist of 2 ports each (2 interfaces x 12 port groups = 48 interfaces). Interfaces that belong to the same port group must belong to the same VDC.

**Figure 8: Cisco Nexus 7700 Series 24-port, 40-Gbps Ethernet modules N77-F324QF-25**



On the Cisco Nexus 7700 Series 12-port, 100-Gbps Ethernet modules N7K-F312CK-26, you must allocate the interfaces on your physical device in the specified combination. These modules have 12 port groups that consist of 1 port each (1 interface x 12 port groups = 12 interfaces).

**Figure 9: Cisco Nexus 7700 Series 12-port, 100-Gbps Ethernet modules N77-F312CK-26**

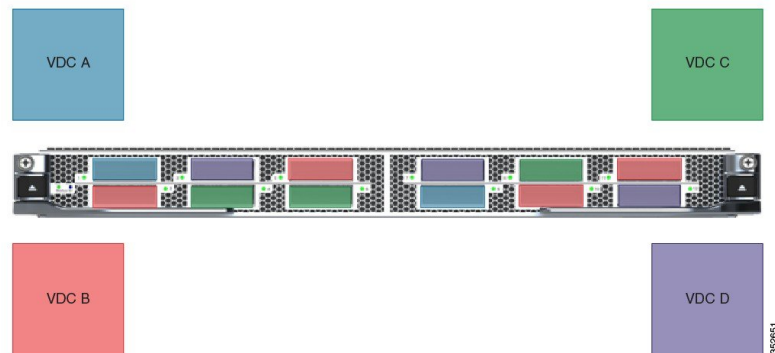



**Note** When the breakout feature is used on the N7K-40 and N77-40G modules, all interfaces that are broken out stay in the same VDC as their original parent port group.

## Logical Resources

Each VDC acts as a separate logical device within a single physical device, which means that all the namespaces are unique within a VDC. However, you cannot use an identical namespace within a storage VDC and an Ethernet VDC.

When you create a VDC, it has its own default VLAN and VRF that are not shared with other VDCs. You can also create other logical entities within a VDC for the exclusive use of that VDC. These logical entities, which include SPAN monitoring sessions, port channels, VLANs, and VRFs, are for Ethernet VDCs.



**Note** You can have a maximum of two SPAN monitoring sessions on your physical device.

When you create a logical entity in a VDC, only users in that VDC can use it even when it has the same identifier as another logical entity in another VDC.

A VDC administrator can configure VLAN IDs independently of the VLAN IDs used in other Ethernet VDCs on the same physical device. For example, if VDC administrators for Ethernet VDC A and Ethernet VDC B both create VLAN 100, these VLANs are internally mapped to separate unique identifiers (see the figure below).

For more information on VDC support and the maximum number of VLANs, see the *Cisco Nexus 7000 Series NX-OS Verified Scalability Guide*.

**Figure 10: Example VLAN Configuration for Ethernet VDCs**

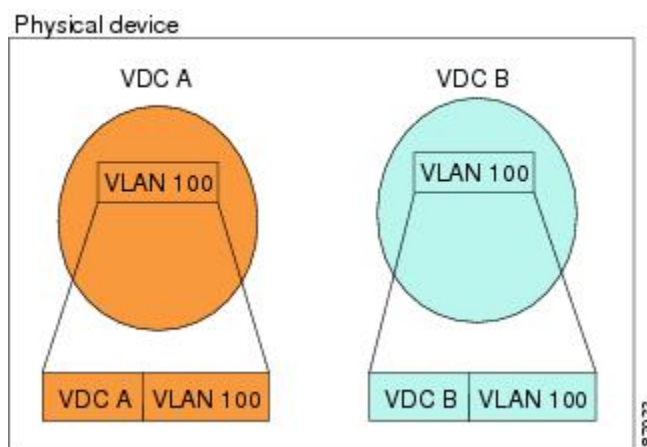

**Note** When you are working with both storage VDCs and Ethernet VDCs, the VLAN ID and logical entity must be entirely separate for the storage VDCs.

## VDC Resource Templates

A network administrator can allocate resources to VDCs using resource templates. Each resource template describes how a set of resources are allocated to a VDC. When you create a VDC, you use a VDC resource template to set limits on the number of certain logical entities that you can create in the VDC. These logical entities include port channels, SPAN monitor sessions, VLANs, IPv4 and IPv6 route memory, and VRFs. You can create a VDC resource template or use the default VDC resource template provided by the Cisco NX-OS software.

## Configuration Files

Each VDC maintains a separate configuration file in NVRAM, reflecting the configuration of interfaces allocated to the VDC and any VDC-specific configuration elements such as VDC user accounts and VDC user roles. The separation of the VDC configuration files provides security and fault isolation that protects a VDC from configuration changes on another VDC.

Separate VDC configuration files also provide configuration isolation. The resources in each VDC might have IDs that overlap without affecting the configuration of the other VDCs. For example, the same VRF IDs, port-channel numbers, VLAN IDs, and management IP address can exist on multiple Ethernet VDCs.

## VDC Management

Each VDC can be managed by a different VDC administrator. An action taken by a VDC administrator in one VDC does not impact users in other VDCs. A VDC administrator within a VDC can create, modify, and delete the configuration for resources allocated to VDC with no impact to other VDCs.

## VDC Default User Roles

The Cisco NX-OS software has default user roles that the network administrator can assign to the user accounts that administer VDCs. These user roles make available a set of commands that the user can execute after logging into the device. All commands that the user is not allowed to execute are hidden from the user or return an error.



---

**Note** You must have the network-admin or vdc-admin role to create user accounts in a VDC.

---

The Cisco NX-OS software provides default user roles with different levels of authority for VDC administration as follows:

- network-admin—The network-admin role exists only in the default VDC and allows access to all the global configuration commands (such as **reload** and **install**) and all the features on the physical device. A custom user role is not granted access to these network-admin-only commands or to other commands that are scoped admin-only. Only the network administrator can access all the commands that are related to the physical state of the device. This role can perform system-impacting functions such as upgrading software and running an Ethernet analyzer on the traffic. Network administrators can create and delete VDCs, allocate resources for these VDCs, manage device resources reserved for the VDCs, and configure features within any VDC. Network administrators can also access nondefault VDCs using the **switchto vdc** command from the default VDC. When network administrators switch to a nondefault VDC, they acquire vdc-admin permissions, which are the highest permissions available in a nondefault VDC.



- **network-operator**—The network-operator role exists only in the default VDC and allows users to display information for all VDCs on the physical device. Users with network-operator roles can access nondefault VDCs using the **switchto vdc** command from the default VDC.
- **vdc-admin**—Users who have the vdc-admin role can configure all features within a VDC. Users with either the network-admin or vdc-admin role can create, modify, or remove user accounts within the VDC. All configurations for the interfaces allocated to a VDC must be performed within the VDC. Users with the vdc-admin role are not allowed to execute any configuration commands related to the physical device.
- **vdc-operator**—Users assigned with the vdc-operator role can display information only for the VDC. Users with either the network-admin or vdc-admin role can assign the vdc-operator role to user accounts within the VDC. The vdc-operator role does not allow the user to change the configuration of the VDC.

If you do not need more than three VDCs, we recommend that you leave the default VDC as an admin VDC and use the other VDCs as active data-plane virtual switches on the Supervisor 1 module. Make sure to restrict default VDC access to a select few administrators who are allowed to modify the global configuration (network-admin role). Remember that you can configure some features (such as Control Plane Policing [CoPP] and rate limits only in the default VDC. You cannot configure the default VDC as a storage VDC.

If the default VDC must be used for data-plane traffic, administrators who require default VDC configuration access but not global configuration access should be assigned with the vdc-admin role. This role restricts administrative functions to the default VDC exclusively and prevents access to global VDC configuration commands.

## Configuration Modes

The Cisco NX-OS software has two main configuration modes for VDCs, VDC configuration mode in the default VDC and global configuration mode within the VDC itself.

In the VDC configuration mode in the default VDC, you can allocate interfaces to the VDCs and change VDC attributes. You can enter VDC configuration mode from global configuration mode on the default VDC. Only users with the network-admin role can access VDC configuration mode.

This example shows how to enter VDC configuration mode:

```
switch# config t
switch(config)# vdc Enterprise
switch(config-vdc)#
```

This example shows how to switch to VDC Enterprise from the default VDC:

```
switch# switchto vdc Enterprise
Cisco Nexus Operating System (NX-OS) Software
TAC support: http://www.cisco.com/tac
Copyright (c) 2002-2012, Cisco Systems, Inc. All rights reserved.
The copyrights to certain works contained in this software are
owned by other third parties and used and distributed under
license. Certain components of this software are licensed under
the GNU General Public License (GPL) version 2.0 or the GNU
Lesser General Public License (LGPL) Version 2.1. A copy of each
such license is available at
http://www.opensource.org/licenses/gpl-2.0.php and
http://www.opensource.org/licenses/lgpl-2.1.php
```

In the global configuration mode in a VDC, you can configure Cisco NX-OS features for nondefault VDCs. You can access this configuration mode by logging in to the VDC and entering global configuration mode. You must have a user role that allows read and write access to the VDC to use this configuration mode.

This example shows how to enter global configuration mode for a VDC:

```
switch-Enterprise# config t
switch-Enterprise(config)#
```

## VDC Management Connections

The Cisco NX-OS software provides a virtual management (mgmt 0) interface for out-of-band management for each VDC. You can configure this interface with a separate IP address that is accessed through the physical mgmt 0 interface (see Figure 1-7). Because the virtual management interface allows you to use only one management network, you can share the AAA servers and syslog servers among the VDCs.

**Figure 11: Out-of-Band VDC Management Example**

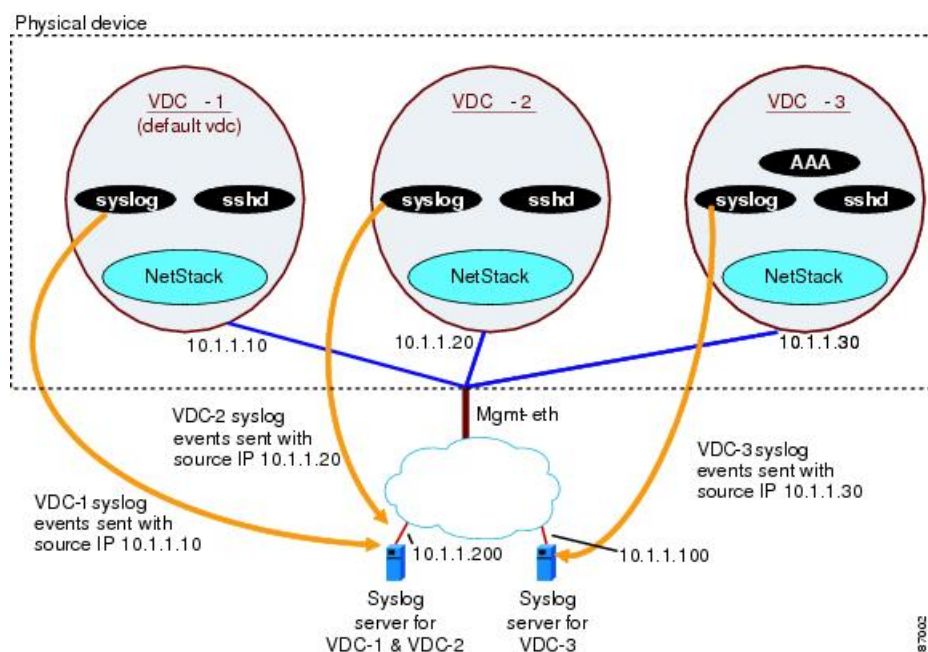

VDCs also support in-band management. You can access the VDC using one of the Ethernet interfaces that are allocated to the VDC (see the figure below). Because the in-band management allows you to use only separate management networks, you can ensure the separation of the AAA servers and syslog servers among the VDCs.

Figure 12: In-Band VDC Management Example

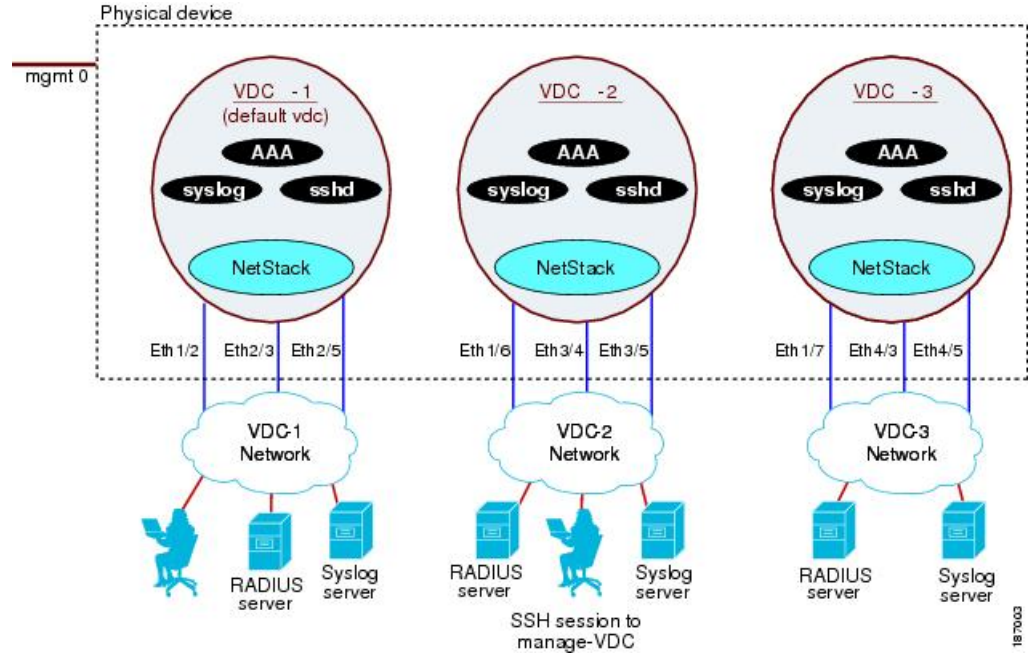

## VDC Fault Isolation

The VDC architecture can prevent failures within one VDC from impacting other VDCs on the same physical device. For instance, an Open Shortest Path First (OSPF) process that fails in one VDC does not affect the OSPF processes in other VDCs in the same physical device.

The figure below shows that a fault in a process running in VDC 1 does not impact any of the running processes in the other VDCs.

Figure 13: Fault Isolation within VDCs

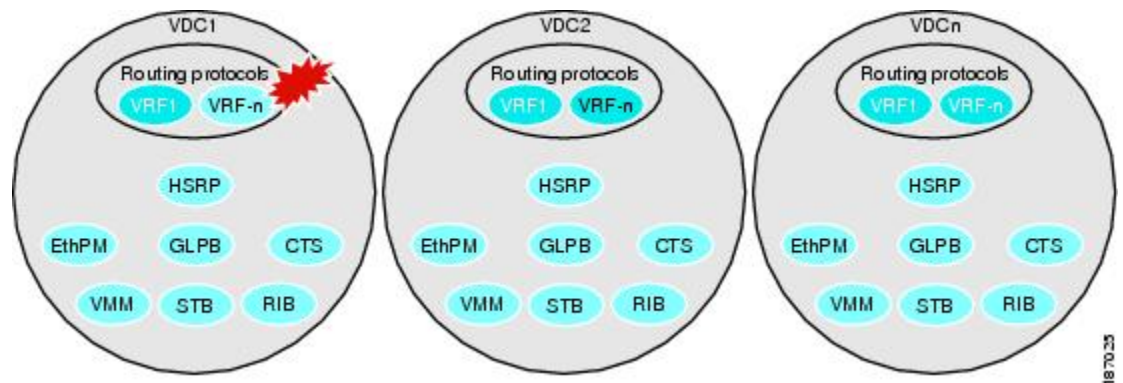

The Cisco NX-OS software also provides debugging and syslog message logging at the VDC level. VDC administrators can use these tools to troubleshoot problems with the VDC.

For more information about VDC troubleshooting, see the *Cisco Nexus 7000 Series NX-OS Troubleshooting Guide*.

The Cisco NX-OS software incorporates high availability (HA) features that minimize the impact on the data plane if the control plane fails or a switchover occurs. The different HA service levels provide data plane protection, including service restarts, stateful supervisor module switchovers, and in-service software upgrades (ISSUs). All of these high availability features support VDCs.

For more information about HA in the Cisco NX-OS software, see the *Cisco Nexus 7000 Series NX-OS High Availability and Redundancy Guide*.

## VDC Module Type Compatibility

**Table 2: VDC Module Type Compatibility for Release 8.0(1)**

	F1	F2	M2L	F2e(F2CR)	F3	M3
F1	True	False	True	False	False	False
F2	False	True	False	True	True	False
M2XL	True	False	True	True	True	True
F2e(F2CR)	False	True	True	True	True	False
F3	False	True	True	True	True	True
M3	False	False	True	False	True	True



---

**Note** Xbow platform supports F2e, F3 and M3 modules only  
M3-M2-F3 combination is blocked for Cisco Nexus 7000 Series Switches.

---

## Cisco NX-OS Feature Support in VDCs

VDC support for the Cisco NX-OS software features varies, depending on the feature. For most of the Cisco NX-OS software features, configuration and operation are local to the current VDC. However, exceptions are as follows:

- Control Plane Policing (CoPP)—Because of the hardware support, you can configure CoPP policies only in the default or admin VDCs. The CoPP policies apply across all VDCs on the physical device.
- Fabric Extender—You must install the Cisco Nexus 2000 Series Fabric Extender feature set in the default or admin VDCs before you can enable the Fabric Extender in any VDC (including the default VDC). For more information about the Fabric Extender, see the *Configuring the Cisco Nexus 2000 Series Fabric Extender*.
- FabricPath—You must install the FabricPath feature set in the default or admin VDCs before you can enable FabricPath in any VDC (including the default VDC). For more information about FabricPath, see the *Cisco NX-OS FabricPath Configuration Guide for Nexus 7000*.

- FCoE—You must install the FCoE feature set in the default or admin VDCs before you can enable FCoE in any VDC (including the default VDC). For more information about FCoE, see “Creating VDCs,” and the *Cisco NX-OS FCoE Configuration Guide for Nexus 7000 and MDS 9500*.
- Multiprotocol Label Switching (MPLS)—You must install the MPLS feature set in the default or admin VDCs before you can enable MPLS in any VDC (including the default VDC). For more information about MPLS, see the *Cisco Nexus 7000 Series NX-OS MPLS Configuration Guide*.
- Rate limits—Because of the hardware support, you can configure rate limits only in the default VDC. The rate limits apply across all VDCs on the physical device.
- IP tunnels—In Cisco NX-OS releases prior to 4.2, you can create VDC tunnels only in the default VDC. However, beginning with Cisco NX-OS Release 4.2(1), you can put tunnel interfaces into nondefault VDCs and VRFs.
- FCoE—Beginning with the Cisco NX-OS Release 5.2(1) for the Nexus 7000 Series devices, VDCs have FCoE support to provide users with local area network (LAN)/storage area network (SAN) management separation on one physical Ethernet interface. The Cisco NX-OS supports both Ethernet and FCoE only in nondefault VDCs that control the Ethernet and storage portions of the network. You can have only one storage VDC configured on the device.

For information on VDC support for a specific feature, see the configuration information for that feature.





## CHAPTER 3

# Configuring an Admin VDC

This chapter describes how to configure an admin virtual device context (VDC) on Cisco NX-OS devices.

- [Finding Feature Information, on page 21](#)
- [Information About Admin VDCs, on page 21](#)
- [Prerequisites for Admin VDCs, on page 22](#)
- [Creating an Admin VDC, on page 22](#)
- [Guidelines and Limitations for Creating Admin VDCs, on page 22](#)
- [Configuring an Admin VDC, on page 23](#)
- [Configuration Examples for Admin VDCs, on page 24](#)
- [Related Documents for Admin VDCs, on page 25](#)
- [Feature History for Admin VDCs, on page 25](#)

## Finding Feature Information

Your software release might not support all the features documented in this module. For the latest caveats and feature information, see the Bug Search Tool at <https://tools.cisco.com/bugsearch/> and the release notes for your software release. To find information about the features documented in this module, and to see a list of the releases in which each feature is supported, see the "New and Changed Information" chapter or the Feature History table in this chapter.

## Information About Admin VDCs

Beginning with Cisco NX-OS Release 6.1 you can enable an admin VDC at the initial system bootup through a setup script. It is an optional step and the creation of an admin VDC is not required. An admin VDC is used for administrative functions only.

Beginning with Cisco NX-OS Release 6.2(2), the Supervisor 1 module supports an admin VDC with the same functionalities as Supervisor 2/2e modules. You can enable a default VDC or an admin VDC on the Supervisor 1 module. For the supported number of VDCs on Supervisor 1 and 2/2e modules, see the Cisco Nexus 7000 Verified Scalability Guide.

Beginning with Cisco NX-OS Release 6.2(2), all functionalities regarding the Supervisor 2e module on the Cisco Nexus 7000 Series switch is applicable to the Supervisor 2e module on the Cisco Nexus 7700 switch.

For more information on Supervisor modules and the Cisco Nexus 7700 switches, see the *Cisco Nexus 7000 Series Hardware Installation and Reference Guide*.

## Prerequisites for Admin VDCs

Admin VDCs are supported on Supervisor 1 and Supervisor 2/2e modules. When an admin VDC is enabled, only the mgmt0 port is allocated to the admin VDC.

## Creating an Admin VDC

You can create an admin VDC in one of the following ways:

- After a fresh switch bootup, a prompt is displayed to select the admin VDC. Choose Yes at the prompt to create an admin VDC. This option is recommended for brand new deployments. It is not recommended to use this option when migrating from Supervisor 1 to Supervisor 2/2e. For more information on the Supervisor 1 to Supervisor 2/2e migration procedure, refer to *Cisco Nexus 7000 Series Hardware Installation and Reference Guide*.
- Enter the **system admin-vdc** command after bootup. The default VDC becomes the admin VDC. All the nonglobal configuration in the default VDC is lost after you enter this command. This option is recommended for existing deployments where the default VDC is used only for administration and does not pass any traffic.
- You can change the default VDC to the admin VDC with the **system admin-vdc migrate new vdc name** command. After entering this command, the nonglobal configuration on a default VDC is migrated to the new migrated VDC. This option is recommended for existing deployments where the default VDC is used for production traffic whose downtime must be minimized.



---

**Note** If the default VDC has Fabric Extenders that are enabled and configured, the migration of the default VDC configuration can take several minutes.

---

## Guidelines and Limitations for Creating Admin VDCs

Admin VDCs have the following configuration guidelines and limitations:

- No features or feature sets can be enabled in an admin VDC.
- No interfaces from any line card module can be allocated to an admin VDC. Only mgmt0 can be allocated to an admin VDC which means that for an admin VDC, only out-of-band management is possible through the mgmt0 interface and console port.
- When an admin VDC is enabled at bootup, it replaces the default VDC.
- Once an admin VDC is created, it cannot be deleted and it cannot be changed back to the default VDC. To change it back to the default VDC, erase the configuration and perform a fresh bootup.
- For the supported number of VDCs on Supervisor 1 and Supervisor 2/2e modules, see the *Cisco Nexus 7000 Verified Scalability Guide*.



The guidelines and limitations for migrating to an admin VDC with **system admin-vdc** and **system admin-VDC migrate** commands are as follows:

- During the admin VDC migration, some feature configurations, such as access control lists (ACLs), are copied into the new VDC but they are not removed from the admin VDC. You have to explicitly remove any unwanted configurations in the admin VDC. While it is recommended to remove this configuration, keeping it does not cause any side effect.

The guidelines and limitations for migrating to an admin VDC with the **system admin-vdc migrate** command only are as follows:

- If you enable the VTP in the default VDC when you enter the **system admin-vdc migrate** command, the VTP configuration is not automatically migrated. After the migration is complete, you must reconfigure the VTP feature in the new VDC.
- If the time zone is configured in the default VDC when you enter the **system admin-vdc migrate** command, the time zone configuration is not automatically migrated. After the migration is complete, you must reconfigure the timezone in the new VDC.
- As the management IP address in the default VDC is not migrated to the new VDC, some existing sessions are not automatically up in the new VDC. You have to configure a new IP address for the management interface in the VDC. Also, any external devices, for example, VPC keepalives over the management interface on the VPC peer or SNMP management stations should be reconfigured.
- During the migration, if the Cisco Nexus 7000 Series switches have enough system resources to spare, the resource limits of the default VDC are copied into the migrated VDC or the migration fails with an error message.
- If the default VDC has Fabric Extenders that are enabled and configured, the migration of the default VDC configuration can take several minutes.

## Configuring an Admin VDC

### Procedure

	Command or Action	Purpose
<b>Step 1</b>	switch# <b>configure terminal</b>	Enters global configuration mode.
<b>Step 2</b>	switch(config)# <b>system admin-vdc [migrate new-vdc]</b>	<p>Enables the admin VDC. Use this command to migrate the default VDC to the admin VDC. If the migrate option is not included in the command, the default VDC becomes the admin VDC and any additional configuration is removed. Otherwise, the configuration is migrated to a new VDC.</p> <p><b>Note</b> The management Ethernet IP address is not migrated as part of the migration process between the default VDC and the admin VDC.</p>

	Command or Action	Purpose
		When migrating the admin VDC, the following error message is displayed: "Interface mgmt0 will not have its IP address migrated to the new VDC."
<b>Step 3</b>	switch(config-vdc)# <b>exit</b>	Exits the VDC configuration mode.
<b>Step 4</b>	(Optional) switch(config)# <b>show vdc</b>	Displays the VDC status information.
<b>Step 5</b>	(Optional) switch(config)# <b>copy running-config startup-config</b>	Saves the change persistently through reboots and restarts by copying the running configuration to the startup configuration.

## Configuration Examples for Admin VDCs

This example shows the prompts at a clean bootup to enable the admin VDC:

```
Enter the password for "admin":
Confirm the password for "admin":
Do you want to enable admin vdc (yes/no) [n]:yes
```

This example shows the show vdc output before the admin VDC is created:

```
switch(config)# sh vdc
vdc_id vdc_name state mac type lc
-----
1 switch active 00:26:98:0d:01:41 Ethernet m1 f1 m1x1 m2x1
2 vdc2 active 00:26:98:0d:01:42 Ethernet m1 f1 m1x1 m2x1
3 vdc3 active 00:26:98:0d:01:43 Ethernet f2
```

This example shows the output of the **system admin-vdc** command after a bootup:

```
switch(config)# system admin-vdc
All non-global configuration from the default vdc will be removed,
Are you sure you want to continue? (yes/no) [no] yes
```

This example shows the **show vdc** output after executing the **system admin-vdc** command:

```
switch(config)# show vdc
vdc_idvdc_name state mac type lc
-----
1 switch active 00:26:98:0d:01:41 AdminNone
2 vdc2 active00:26:98:0d:01:42 Ethernet m1 f1 m1x1 m2x1
3 vdc3 active 00:26:98:0d:01:43 Ethernetf2
```

This example shows the output of the **system admin-vdc migrate new vdc name** command to migrate the default VDC to the admin VDC:

```
switch(config)# system admin-vdc migrate new-vdc

All non-global configuration from the default vdc will be removed, Are you sure you want
to continue? (yes/no) [no] yes
Note: Interface mgmt0 will not have its ip address migrated to the new vdc
Note: During migration some configuration may not be migrated.
Example: VTP will need to be reconfigured in the new vdc if it was enabled. Please refer
to configuration guide for details. Please wait, this may take a while
Note: Ctrl-C has been temporarily disabled for the duration of this command
```

```
2012 Jul 5 22:20:58 switch %$ VDC-1 %$ %VDC_MGR-2-VDC_ONLINE: vdc 4 has come online
switch(config)#
```

This example shows the **show vdc** output after the admin VDC is created:

```
switch(config)# show vdc

vdc_idvdc_name state mac type lc
-----
1 switch active 00:26:98:0d:01:41 AdminNone
2 vdc2 active 00:26:98:0d:01:42 Ethernet m1 f1 m1x1 m2x1
3 vdc3 active 00:26:98:0d:01:43 Ethernet f2
4 new-vdc active 00:26:98:0d:01:44 Ethernet m1 f1 m1x1 m2x1
switch(config)#
```

## Related Documents for Admin VDCs

Related Topic	Document Title
Cisco NX-OS licensing	<i>Cisco Nexus 7000 Series NX-OS Unicast Routing Command Reference</i>
Supported number of VDCs	<i>Cisco Nexus 7000 Verified Scalability Guide</i>
VDC commands	<i>Cisco Nexus 7000 Series NX-OS Virtual Device Context Command Reference</i>

## Feature History for Admin VDCs

This table includes only the updates for those releases that have resulted in additions or changes to the feature.

**Table 3: Feature History for Admin VDCs**

Feature Name	Release	Feature Information
Supervisor 1 module	6.2(2)	Added support for admin VDCs on the Supervisor 1 module.
Admin VDC	6.1(1)	This feature was introduced on Supervisor 2 and Supervisor 2e modules.





## CHAPTER 4

# Configuring VDC Resource Templates

This chapter describes how to configure virtual device context (VDC) resource templates on Cisco NX-OS devices.

- [Finding Feature Information, on page 27](#)
- [Information About VDC Resource Templates, on page 27](#)
- [Guidelines and Limitations for VDC Resource Templates, on page 29](#)
- [VDC Resource Templates, on page 29](#)
- [Configuring VDC Resource Templates, on page 30](#)
- [Verifying the VDC Resource Template Configuration, on page 31](#)
- [Configuration Example for VDC Resource Template, on page 31](#)
- [Related Documents for VDC Resource Templates, on page 32](#)
- [Feature History for VDC Resource Templates, on page 32](#)

## Finding Feature Information

Your software release might not support all the features documented in this module. For the latest caveats and feature information, see the Bug Search Tool at <https://tools.cisco.com/bugsearch/> and the release notes for your software release. To find information about the features documented in this module, and to see a list of the releases in which each feature is supported, see the "New and Changed Information" chapter or the Feature History table in this chapter.

## Information About VDC Resource Templates

VDC resource templates set the minimum and maximum limits for shared physical device resources when you create the VDC. The Cisco NX-OS software reserves the minimum limit for the resource to the VDC. Any resources allocated to the VDC beyond the minimum are based on the maximum limit and availability on the device.

You can explicitly specify a VDC resource template, or you can use the default VDC template provided by the Cisco NX-OS software. VDC templates set limits on the following resources:

- IPv4 multicast route memory
- IPv6 multicast route memory
- IPv4 unicast route memory

- IPv6 unicast route memory
- Port channels
- Switch Port Analyzer (SPAN) sessions
- VLANs
- Virtual routing and forwarding instances (VRFs)

The default IPv4 and IPv6 route memory available for all VDCs on the supervisor is 250 MB. Beginning with Cisco NX-OS Release 5.2(1), the default memory is 300 MB. This amount remains the same with both the 4-GB and the 8-GB supervisor. You can have approximately 11,000 routes, each with 16 next hops, in 16 MB of route memory. The **show routing memory estimate routes *number-of-routes* next-hops *number-of-next-hops*** command shows the amount of unicast RIB (IPv4 RIB and IPv6 RIB) shared memory needed to support the specified number of routes and next hops.

If you do not set a limit for a resource in a VDC resource template, the default limits for that resource are the same as those in the default VDC resource template. The table below lists the default template resource limits of the nondefault VDC.



**Note** You cannot change the limits in the default VDC resource template.

**Table 4: Default Resource Limits for the Nondefault VDC**

Resource	Minimum	Maximum
IPv4 multicast route memory <sup>1</sup>	8	8
IPv6 multicast route memory <sup>1</sup>	5	5
IPv4 unicast route memory <sup>1</sup>	8	8
IPv6 unicast route memory <sup>1</sup>	4	4
Port channels	0	768
SPAN sessions	0	2
ERSPAN sessions	0	23
VLANs	16	4094
VRFs	2	4096
Inband SRC session	0	1

<sup>1</sup> Route memory is in megabytes.

Any changes that you make to a VDC resource template do not affect any VDCs that you created using that VDC resource template. To update a VDC with the new limits in the VDC resource, you must explicitly reapply the template to the VDC.

The table below lists the default template resource limits of the global default VDC.

Table 5: Default Resource Limits for the Default VDC

Resource	Minimum	Maximum
IPv4 multicast route memory <sup>1</sup>	58	58
IPv6 multicast route memory <sup>1</sup>	8	8
IPv4 unicast route memory <sup>1</sup>	96	96
IPv6 unicast route memory <sup>1</sup>	24	24
Port channels	0	768
SPAN sessions	0	2
ERSPAN sessions	0	23
VLANs	16	4094
VRFs	2	4096
Inband SRC session	0	1

<sup>1</sup> Route memory is in megabytes.



**Note** Only the network administrator can change a VDC template in the default VDC.

## Guidelines and Limitations for VDC Resource Templates

VDC templates have the following configuration guidelines and limitations:

- VDC templates can only be created by the network administrator in the default VDC.
- See the *Cisco Nexus 7000 Verified Scalability Guide* for information on the maximum supported number of VDC templates.

## VDC Resource Templates

VDC resource templates describe the minimum and maximum resources that the VDC can use. If you do not specify a VDC resource template when you create a VDC, the Cisco NX-OS software uses the default template, vdc-default.



**Note** As an alternative to using VDC resource templates, you can change the individual resource limits after you create the VDC by changing an individual resource limit for a single VDC or by changing the resource limits in a nondefault VDC resource template and applying the template to the VDC.



**Note** You can have a maximum of two SPAN monitoring sessions on your physical device.

You can change the individual resource limits after you create the VDC as follows:

- Change an individual resource limit for a single VDC.
- Change the resource limits in a nondefault VDC resource template and apply the template to the VDC.

## Configuring VDC Resource Templates

The maximum amount of system resources assigned to a VDC is limited by the VDC resource template used when the VDC is created. You can create VDC resource templates that you can use when creating VDCs that have resource limits other than those provided in the default VDC resource template.

If you do not set limits for a resource in a VDC resource template, the default limits are the limits for that resource in the default VDC resource template.

You can set only one value for the multicast and unicast route memory resources maximum and minimum limits. If you specify a minimum limit, that is the value for both the minimum and maximum limits and the maximum limit is ignored. If you specify only a maximum limit, that is the value for both the minimum and maximum limits.

You can have a maximum of two SPAN monitoring sessions on your physical device.

You cannot change the configuration of the default resource templates.

### Procedure

- 
- Step 1** `switch# configure terminal`  
Enters global configuration mode.
- Step 2** `switch(config)# vdc resource template vdc-template-name`  
Specifies the VDC resource template name and enters VDC resource template configuration mode. The name is a maximum of 32 alphanumeric characters and is not case sensitive.
- Step 3** `switch(config-vdc-template)# limit-resource m4route-mem [minimum min-value] maximum max-value`  
Specifies the limits for IPv4 multicast route memory in megabytes. The range is from 1 to 90.
- Step 4** `switch(config-vdc-template)# limit-resource m6route-mem [minimum min-value] maximum max-value`  
Specifies the limits for IPv6 multicast route memory in megabytes. The range is from 3 to 20.
- Step 5** `switch(config-vdc-template)# limit-resource monitor-session minimum min-value maximum {max-value | equal-to-min}`  
Specifies the limits for SPAN monitor session resources. The default minimum value is 0. The default maximum value is 2. The range is from 0 to 2. The equal-to-min keyword automatically sets the maximum limit equal to the minimum limit.

**Note** You can have a maximum of two SPAN monitoring sessions on your physical device.



- Step 6** `switch(config-vdc-template)# limit-resource port-channel minimum min-value maximum {max-value | equal-to-min}`  
Specifies the limits for port channels. The default minimum value is 0. The default maximum value is 768. The range is from 0 to 768. The **equal-to-min** keyword automatically sets the maximum limit equal to the minimum limit.
- Step 7** `switch(config-vdc-template)# limit-resource u4route-mem [minimum min-value] maximum max-value`  
Specifies the limits for IPv4 unicast route memory in megabytes. The range is from 1 to 250.
- Step 8** `switch(config-vdc-template)# limit-resource u6route-mem [minimum min-value] maximum max-value`  
Specifies the limits for IPv6 unicast route memory in megabytes. The range is from 1 to 100.
- Step 9** `switch(config-vdc-template)# limit-resource vrf minimum min-value maximum {max-value | equal-to-min}`  
Specifies the limits for VRF. The range is from 2 to 1000. The **equal-to-min** keyword automatically sets the maximum limit equal to the minimum limit.
- Step 10** `switch(config-vdc-template)# exit`  
Exits VDC template configuration mode.
- Step 11** (Optional) `switch(config)# show vdc resource template`  
Displays VDC template configuration information.
- Step 12** (Optional) `switch(config)# copy running-config startup-config`  
Saves the change persistently through reboots and restarts by copying the running configuration to the startup configuration.

## Verifying the VDC Resource Template Configuration

To display VDC resource template configuration information, perform one of the following tasks:

Command	Purpose
<code>show running-config {vdc   vdc-all}</code>	Displays the VDC information in the running configuration.
<code>show vdc resource template [template-name]</code>	Displays the VDC template configuration.

For detailed information about the fields in the output from this command, see the *Cisco Nexus 7000 Series NX-OS Virtual Device Context Command Reference*.

## Configuration Example for VDC Resource Template

This example shows how to configure a VDC resource template:

```
vdc resource template TemplateA
```

```

limit-resource port-channel minimum 4 maximum 128
limit-resource span-ssn minimum 1 maximum equal-to-min
limit-resource vlan minimum 32 maximum 1024
limit-resource vrf minimum 32 maximum 1000

```

## Related Documents for VDC Resource Templates

Related Topic	Document Title
Cisco NX-OS licensing	<i>Cisco Nexus 7000 Series NX-OS Unicast Routing Command Reference</i>
VDC commands	<i>Cisco Nexus 7000 Series NX-OS Virtual Device Context Command Reference</i>

## Feature History for VDC Resource Templates

This table includes only the updates for those releases that have resulted in additions or changes to the feature.

**Table 6: Feature History for VDC Resource Templates**

Feature Name	Release	Feature Information
VDC resource templates	6.2(2)	No change from Cisco NX-OS Release 6.1(3).
VDC resource templates	6.1(3)	No change from Cisco NX-OS Release 6.0(1).
VDC resource templates	6.0(1)	No change from Cisco NX-OS Release 5.2.
VDC resource templates	5.2(1)	No change from Cisco NX-OS Release 5.1.
VDC resource templates	5.1(1)	No change from Cisco NX-OS Release 5.0.
IPv4 multicast route memory resource	5.0(2)	Changed the range for the minimum and maximum values.
IPv6 multicast route memory resource	5.0(2)	Changed the range for the minimum and maximum values.
IPv4 unicast route memory resource	5.0(2)	Changed the range for the minimum and maximum values.
IPv6 unicast route memory resource	5.0(2)	Changed the range for the minimum and maximum values.
VRF resource	5.0(2)	Changed the range for the minimum and maximum values.
VDC resource templates	4.2(1)	No change from Cisco NX-OS Release 4.1(2).
IPv4 unicast route memory resource	4.1(2)	Changed the default maximum value from 256 to 8.

Feature Name	Release	Feature Information
IPv6 unicast route memory resource	4.1(2)	Changed the default maximum value from 256 to 4.
Multicast route memory resources	4.1(2)	Added IPv4 and IPv6 multicast route memory resources.
Port channel resources	4.1(2)	Changed the default maximum value from 256 to 768.
IPv4 unicast route memory resource	4.0(2)	Changed the default maximum value from 256 to 320.
IPv6 unicast route memory resource	4.0(2)	Changed the default maximum value from 256 to 192.





## CHAPTER 5

# Creating VDCs

---

This chapter describes how to create virtual device contexts (VDCs) on Cisco NX-OS devices.

- [Finding Feature Information, on page 35](#)
- [Information About Creating VDCs, on page 35](#)
- [Prerequisites for Creating VDCs, on page 40](#)
- [Guidelines and Limitations for Creating VDCs, on page 41](#)
- [Default Settings for Creating VDCs, on page 42](#)
- [Process for Creating VDCs, on page 42](#)
- [Creating VDCs, on page 43](#)
- [Initializing a VDC, on page 45](#)
- [Verifying the VDC Configuration, on page 46](#)
- [Configuration Example for Ethernet VDC Creation and Initialization, on page 47](#)
- [Configuration Examples for Default and Nondefault VDCs, on page 50](#)
- [Related Documents for Creating VDCs, on page 50](#)
- [Feature History for Creating VDCs, on page 51](#)

## Finding Feature Information

Your software release might not support all the features documented in this module. For the latest caveats and feature information, see the Bug Search Tool at <https://tools.cisco.com/bugsearch/> and the release notes for your software release. To find information about the features documented in this module, and to see a list of the releases in which each feature is supported, see the "New and Changed Information" chapter or the Feature History table in this chapter.

## Information About Creating VDCs

In Cisco NX-OS, only a user with the network-admin role can create VDCs.

Beginning with the Cisco NX-OS Release 5.2(1), you can run Fibre Channel over Ethernet (FCoE) on the Cisco Nexus 7000 Series devices. You must create a storage VDC to run FCoE. The storage VDC cannot be the default VDC. You can have one storage VDC on the device. See the Cisco NX-OS FCoE Configuration Guide for Cisco Nexus 7000 and Cisco MDS 9500 for information on configuring FCoE.

Beginning with Cisco NX-OS Release 6.2(2), Supervisor 2e module supports the new Cisco Nexus 7718 switch and the Cisco Nexus 7710 switch. These switches supports F2e line cards only. For more information, see the *Cisco Nexus 7000 Series Hardware Installation and Reference Guide*.

## Storage VDCs

The storage VDC is one of the nondefault VDCs and it does need a license. However, a storage VDC does not need a VDC license because it relies on the FCoE license installed to enable the FCoE function on the modules. Beginning with Cisco NX-OS Release 5.2(1) for the Nexus 7000 Series devices, you can run FCoE on the F1, F2 and F2e Series modules, depending upon your specific release version. You can create separate storage VDCs to run FCoE. You can have only one storage VDC on the device, and you cannot configure the default VDC as a storage VDC.



---

**Note** Starting with Cisco NX-OS Release 6.2(2), we do not support the interoperability of F1 and F2 Series modules in any VDC, either in a dedicated mode or in a shared mode. If you have configured F1 and F2 Series modules as supported line cards in a storage VDC during an In-Service Software Upgrade (ISSU) to Cisco NX-OS Release 6.2(2) or later releases, before ISSU, reconfigure your storage VDC by using the `limit-resource module-type` command (for information, see the “Changing VDC Resource Limits” section) to avoid any unnecessary disruption to the system.

---

After you create the storage VDC, you assign specified FCoE VLANs. Finally, you configure interfaces on the Cisco Nexus 7000 Series device as either dedicated FCoE interfaces or as shared interfaces, which can carry both Ethernet and FCoE traffic. See the *Cisco NX-OS FCoE Configuration Guide for Cisco Nexus 7000 and Cisco MDS 9500* for information on configuring FCoE.

## High-Availability Policies

The high-availability (HA) policies for a VDC defines the action that the Cisco NX-OS software takes when an unrecoverable VDC fault occurs.

You can specify the HA policies for single supervisor module or dual supervisor module configurations when you create the VDC. The HA policy options are as follows:

- Single supervisor module configuration:
  - Bringdown—Puts the VDC in the failed state.
  - Reload— Reloads the supervisor module.
  - Restart—Takes down the VDC processes and interfaces and restarts them using the startup configuration.
  
- Dual supervisor module configuration:
  - Bringdown—Puts the VDC in the failed state.
  - Restart—Takes down the VDC processes and interfaces and restarts them using the startup configuration.
  - Switchover— Initiates a supervisor module switchover.

The default HA policies for a nondefault VDC that you create is restart for a single supervisor module configuration and switchover for a dual supervisor module configuration. The default HA policy for the default VDC is reload for a single supervisor module configuration and switchover for a dual supervisor module configuration.

## Allocating Interfaces



---

**Note** See the *Cisco NX-OS FCoE Configuration Guide for Cisco Nexus 7000 and Cisco MDS 9500* for information on allocating interfaces for storage VDCs and FCoE.

---

The only physical resources that you can allocate to a VDC are the physical interfaces. You can assign an interface to only one VDC, except in the specific case of shared interfaces that carry both Fibre Channel and Ethernet traffic. You allocate a shared interface to both an Ethernet VDC and to the storage VDC. When you move an interface from one VDC to another VDC, the interface loses its configuration. The output of the **show running-config vdc** command has two entries for storage VDC. The first entry has details of all configurations except FCoE VLAN range and shared interfaces. The second entry, which appears at the bottom, has details of FCoE VLAN range and shared interfaces. This entry is placed at the bottom to avoid the configuration replay failure if the storage VDC is created before the ethernet VDC and the interface is shared from the ethernet VDC. You can create the ethernet VDC in any order if this entry is placed at the bottom.

When you first create a VDC, you can specifically allocate interfaces to it. All interfaces initially reside in the default VDC (VDC 1). After you allocate the interfaces to a VDC, you can only view and configure them from that specific VDC. You can also remove interfaces from a VDC by moving them back to the default VDC.



---

**Caution** When you move an interface, all configuration on the interface is lost and the interfaces are in the down state.

---



---

**Note** Beginning with Cisco NX-OS Release 5.2(1) for Nexus 7000 Series devices, all members of a port group are automatically allocated to the VDC when you allocate an interface.

---

You must be aware of the hardware architecture of your platform when allocating interfaces to a VDC. You can allocate the interfaces on your physical device in any combination.

Beginning with Cisco NX-OS Release 6.1, the following M2 Series modules are supported on Cisco Nexus 7000 Series platforms:

- 24-port 10G (N7K-M224XP-23L)
- 6-port 40G (N7K-M206FQ-23L)
- 2-port 100G (N7K-M202-CF-22L)



**Note** There is no port group restriction on M2 Series modules. Any port in M2 Series modules can be placed in any VDC.

**Table 7: Port Numbers for Port Groups on the Cisco Nexus 7000 Series 32-Port, 10-Gbps Ethernet Module N7K-M132XP-12**

Port Group	Port Numbers
Group 1	1, 3, 5, 7
Group 2	2, 4, 6, 8
Group 3	9, 11, 13, 15
Group 4	10, 12, 14, 16
Group 5	17, 19, 21, 23
Group 6	18, 20, 22, 24
Group 7	25, 27, 29, 31
Group 8	26, 28, 30, 32

You must allocate the interfaces on your physical device in the specified combination on the Cisco Nexus 7000 Series 32-port, 10-Gbps Ethernet module N7K-F132XP-15. This module has 16 port groups that consist of 2 ports each. You must assign the specified port pairs in the same VDC. The table below shows the port numbering for the port groups.

**Table 8: Port Numbers for Port Groups on the Cisco Nexus 7000 Series 32-Port, 10-Gbps Ethernet Module N7K-F132XP-15**

Port Group	Port Numbers
Group 1	1 and 2
Group 2	3 and 4
Group 3	5 and 6
Group 4	7 and 8
Group 5	9 and 10
Group 6	11 and 12
Group 7	13 and 14



Port Group	Port Numbers
Group 8	15 and 16
Group 9	17 and 18
Group 10	19 and 20
Group 11	21 and 22
Group 12	23 and 24
Group 13	25 and 26
Group 14	27 and 28
Group 15	29 and 30
Group 16	31 and 32

You must allocate the interfaces on your physical device in the specified combination on the Cisco Nexus 7000 Series 48-port, 10-Gbps Ethernet modules N7K-F248XP-25[E] and N7K-F248XT-25[E]. These modules have 12 port groups that consist of 4 ports each. You must assign all four ports in a port group to the same VDC. The table below shows the port numbering for the port groups.

**Table 9: Port Numbers for Port Groups on the Cisco Nexus 7000 Series 10-Gbps Ethernet Module N7K-F248XP-25[E] and N7K-F248XT-25[E] and Cisco Nexus 7700 Series 48-Port 1 and 10-Gbps Ethernet Module N77-F248XP-23E**

Port Group	Port Numbers
Group 1	1, 2, 3, 4
Group 2	5, 6, 7, 8
Group 3	9, 10, 11, 12
Group 4	13, 14, 15, 16
Group 5	17, 18, 19, 20
Group 6	21, 22, 23, 24
Group 7	25, 26, 27, 28
Group 8	29, 30, 31, 32
Group 9	33, 34, 35, 36

Port Group	Port Numbers
Group 10	37, 38, 39, 40
Group 11	41, 42, 43, 44
Group 12	45, 46, 47, 48

For more information about port groups on the Cisco Nexus 7000 Series 32-port, 10-Gbps Ethernet modules, see the *Cisco Nexus 7000 Series Hardware Installation and Reference Guide*.

## VDC Management Connections

The Cisco NX-OS software provides a virtual management (mgmt 0) interface for out-of-band management of each VDC. You can configure this interface with a separate IP address that is accessed through the physical mgmt 0 interface. You also use one of the Ethernet interfaces on the physical device for in-band management.

## Initializing a New VDC

A new VDC is similar to a new physical device. You must set the VDC admin user account password and perform the basic configuration to establish connectivity to the VDC.

## Prerequisites for Creating VDCs

VDCs have the following configuration guidelines and limitations:

- Standard VDCs cannot share interfaces, VLANs, Virtual Routing and Forwarding (VRF) tables, or port channels.
- Only users with the network-admin role can create VDCs.
- The following guidelines and limitations apply to the **switchto vdc** command:
  - Only users with the network-admin or network-operator role can use the **switchto vdc** command. No other users are permitted to use it.
  - No user can grant permission to another role to use the **switchto vdc** command.
  - After a network-admin uses the **switchto vdc** command, this user becomes a vdc-admin for the new VDC. Similarly, after a network-operator uses the **switchto vdc** command, this user becomes a vdc-operator for the new VDC. Any other roles associated with the user are not valid after the **switchto vdc** command is entered.
  - After a network-admin or network-operator uses the **switchto vdc** command, this user cannot use this command to switch to another VDC. The only option is to use the switchback command to return to the original VDC.

- Cisco NX-OS Release 6.2.2 introduced a separate F2e Series VDC type which must be entered to enable F2e Series support. In Cisco NX-OS Release 6.1, the F2 VDC type supports both F2 and F2e Series modules.
- F2 Series modules can exist with F2e Series modules in the same VDC. F2 Series modules cannot exist with any other module type in the VDC. This restriction applies to both LAN and storage VDCs. See the “Managing VDCs” chapter for more detailed information on module type restrictions and conditions.
- F2 and F2e Series modules support FCoE only with Supervisor 2 and Supervisor 2e modules.
- F2 and F3 Series modules in a specific VDC do not support OTV.
- F2 and F3 Series modules in a specific VDC do not support 64,000 unicast entries if the VPN routing and forwarding (VRF) instance is spread across the F2 and F3 Series modules.

## Guidelines and Limitations for Creating VDCs

VDCs have the following configuration guidelines and limitations:

- Standard VDCs cannot share interfaces, VLANs, Virtual Routing and Forwarding (VRF) tables, or port channels.
- Only users with the network-admin role can create VDCs.
- On a Cisco Nexus 7000 Series switch, when a transceiver is removed or inserted on an interface in a VDC (for example VDC-1), a trap is sent to all the VDCs in the switch (including the VDC-1). This is applicable for a module removal or insertion and other physical entity events. Also, if there is a strict secure tenanted solution with multiple VDCs, this behavior can cause data leak to other tenants.
- The following guidelines and limitations apply to the **switchto vdc** command:
  - Only users with the network-admin or network-operator role can use the **switchto vdc** command. No other users are permitted to use it.
  - No user can grant permission to another role to use the **switchto vdc** command.
  - After a network-admin uses the **switchto vdc** command, this user becomes a vdc-admin for the new VDC. Similarly, after a network-operator uses the **switchto vdc** command, this user becomes a vdc-operator for the new VDC. Any other roles associated with the user are not valid after the **switchto vdc** command is entered.
  - After a network-admin or network-operator uses the **switchto vdc** command, this user cannot use this command to switch to another VDC. The only option is to use the switchback command to return to the original VDC.
- Cisco NX-OS Release 6.2.2 introduced a separate F2e Series VDC type which must be entered to enable F2e Series support. In Cisco NX-OS Release 6.1, the F2 VDC type supports both F2 and F2e Series modules.
- F2 Series modules can exist with F2e Series modules in the same VDC. F2 Series modules cannot exist with any other module type in the VDC. This restriction applies to both LAN and storage VDCs.
- F2 and F2e Series modules support FCoE only with Supervisor 2 and Supervisor 2e modules.

- The OTV feature is unavailable when interfaces from both an F2 and F3 Series module are allocated to a specific VDC.
- F2 and F3 Series modules in a specific VDC do not support 64,000 unicast entries if the VPN routing and forwarding (VRF) instance is spread across the F2 and F3 Series modules.
- The maximum number of port-channels across N7K for all VDCs is 768 (Inclusive of fex port-channels if created).

## Default Settings for Creating VDCs

Table 10: Default VDC Parameter Settings

Parameters	Default
Default VDC HA policies	<b>reload</b> for single supervisor module configurations <b>switchover</b> for dual supervisor module configurations
Nondefault VDC HA policies	<b>reload</b> for single supervisor module configurations <b>switchover</b> for dual supervisor module configurations
VDC ID	First available

## Process for Creating VDCs

To create VDCs, follow these steps:

### Procedure

- 
- Step 1** If necessary, create a VDC resource template
- Step 2** Create the VDC and allocate interfaces
- Step 3** Initialize the VDC
- Allocating interfaces to a VDC is optional. You can allocate the interfaces after you have verified the VDC configuration.
  - When creating an FCoE type VDC, you must enter the type storage command at the time the nondefault VDC is being created, because it cannot be specified later. You must also allocate specified VLANs as FCoE VLANs that will run only in the storage VDC. For details about implementing FCoE and allocating interfaces, see the *Cisco NX-OS FCoE Configuration Guide for Cisco Nexus 7000 and Cisco MDS 9500*.
  - You can enable FCoE on F1 Series modules with Supervisor 1 modules. You can also enable FCoE on F1 Series modules and on the F248XP-25[E] Series with Supervisor 2 and Supervisor 2e modules.

- You cannot enable FCoE on F2 and F2e Series modules with Supervisor 1 modules.

## Creating VDCs

### Before you begin

You must create a VDC before you can use it.



**Note** VDC creation can take a few minutes to complete. Use the **show vdc** command to verify the completion of the create request.

Log in to the default or admin VDC as a network administrator.

Choose a VDC resource template if you want to use resource limits other than those limits provided in the default VDC resource template.



**Note** When creating an FCoE type VDC, you must enter the type storage command at the time the nondefault VDC is being created, because it cannot be specified later. For information on allocating FCoE VLANs and interfaces to the storage VDC, see the *Cisco NX-OS FCoE Configuration Guide for Cisco Nexus 7000 and Cisco MDS 9500*.

### Procedure

	Command or Action	Purpose
<b>Step 1</b>	switch# <b>configure terminal</b>	Enters global configuration mode.
<b>Step 2</b>	switch(config)# <b>vdc</b> {switch   vdc-name} [ha-policy {dual-sup {bringdown   restart   switchover}   single-sup {bringdown   reload   restart}}] [id vdc-number] [template template-name] [template template-name] [type storage]	Creates a VDC and enters the VDC configuration mode. The keywords and arguments are as follows: <ul style="list-style-type: none"> <li>• <b>switch</b>—Specifies the default VDC. VDC number 1 is reserved for the default VDC.</li> <li>• <b>vdc-name</b>—Specifies a nondefault VDC. The VDC name can be a maximum of 32 characters. The VDC name cannot begin with a number. Nondefault VDC numbers are from 2 to 9. The next available number is assigned when creating a nondefault VDC.</li> <li>• <b>ha-policy dual-sup:</b> <ul style="list-style-type: none"> <li>• <b>bringdown</b>—Puts the VDC in the failed state.</li> </ul> </li> </ul>

	Command or Action	Purpose
		<ul style="list-style-type: none"> <li>• <b>restart</b>—Takes down the VDC processes and interfaces and restarts them using the startup configuration.</li> <li>• <b>switchover</b>—(Default) Initiates a supervisor module switchover.</li> <li>• <b>ha-policy single-sup:</b> <ul style="list-style-type: none"> <li>• <b>bringdown</b>—Puts the VDC in the failed state.</li> <li>• <b>reload</b>—Reloads the supervisor module.</li> <li>• <b>restart</b>—(Default) Takes down the VDC processes and interfaces and restarts them using the startup configuration.</li> </ul> </li> <li>• <b>id</b>—Specifies the VDC ID.</li> <li>• <b>template</b>—Specifies the VDC resource template. The default resource template is used if you do not specify one.</li> <li>• <b>type storage</b>—Specifies a nondefault VDC as a storage VDC.</li> </ul> <p><b>Note</b> You must enter the <b>type storage</b> keyword when you create the nondefault VDC because you cannot specify this keyword after the nondefault VDC has been created. See the <i>Cisco NX-OS FCoE Configuration Guide for Cisco Nexus 7000 and Cisco MDS 9500</i> for information on configuring FCoE.</p>
<b>Step 3</b>	(Optional) switch(config-vdc)# <b>[no] allocate interface ethernet slot/port</b>	<p>Allocates one interface to the VDC.</p> <p>The <i>slot/port</i> argument specifies the interface that you are allocating. Use the <b>no</b> option of the command to remove an interface from the VDC and place it in an unallocated pool.</p>
<b>Step 4</b>	(Optional) switch(config-vdc)# <b>[no] allocate interface ethernet slot/port - last-port</b>	<p>Allocates a range of interfaces on the same module to the VDC.</p> <p>The <i>slot</i> argument specifies the slot, the <i>port</i> argument specifies the first interface in the</p>

	Command or Action	Purpose
		range, and the <i>last-port</i> argument specifies the last interface in the range that you are allocating.
<b>Step 5</b>	(Optional) switch(config-vdc)# <b>[no] allocate interface ethernet slot/port, ethernet slot/port,</b>	Allocates a list of interfaces to the VDC. The <i>slot/port</i> argument specifies the interface that you are allocating. You can specify several interfaces using commas as delimiters.
<b>Step 6</b>	(Optional) switch(config-vdc)# <b>show vdc membership</b>	Displays the interface membership for the VDCs.
<b>Step 7</b>	(Optional) switch(config-vdc)# <b>show vdc shared membership</b>	Displays the shared interface membership for the VDCs.
<b>Step 8</b>	switch(config-vdc)# <b>exit</b>	Exits the VDC configuration mode.
<b>Step 9</b>	(Optional) switch(config)# <b>show vdc</b>	Displays the VDC status information.
<b>Step 10</b>	(Optional) switch(config)# <b>copy running-config startup-config</b>	Saves the change persistently through reboots and restarts by copying the running configuration to the startup configuration.  <b>Note</b> After you create a VDC, you must copy the default VDC running configuration to the startup configuration so that a VDC user can copy the new VDC running configuration to the startup configuration.

## Initializing a VDC

A newly created VDC is much like a new physical device. To access a VDC, you must first initialize it. The initialization process includes setting the VDC admin user account password and optionally running the setup script (see the “Configuration Example for Ethernet VDC Creation and Initialization” section). The setup script helps you to perform basic configuration tasks such as creating more user accounts and configuring the management interface.



**Note** The VDC admin user account in the nondefault VDC is separate from the network admin user account in the default VDC. The VDC admin user account has its own password and user role.

### Before you begin

- Log in to the default or admin VDC as a network administrator.

- Obtain an IPv4 or IPv6 address for the management interface (mgmt 0) if you want to use out-of-band management for the VDC.

### Procedure

	Command or Action	Purpose
<b>Step 1</b>	switch# <b>switchto vdc</b> <i>vdc-name</i>	Switches to the VDC.
<b>Step 2</b>	(Optional) switch-NewVDC# <b>show vdc current-vdc</b>	Displays the current VDC number.

## Verifying the VDC Configuration

To display the VDC configuration, perform one of the following tasks:

Command	Purpose
<b>show running-config</b> { <i>vdc</i>   <i>vdc-all</i> }	Displays the VDC information in the running configuration.
<b>show vdc</b> [ <i>vdc-name</i> ]	Displays the VDC configuration information.
<b>show vdc detail</b>	Displays the detailed information about many VDC parameters.
<b>show vdc current-vdc</b>	Displays the current VDC number.
<b>show vdc membership</b> [ <i>status</i> ]	Displays the VDC interface membership information.
<b>show vdc resource template</b>	Displays the VDC template configuration.
<b>show resource</b>	Displays the VDC resource configuration for the current VDC.
<b>show vdc</b> [ <i>vdc-name</i> ] <b>resource</b> [ <i>resource-name</i> ]	Displays the VDC resource configuration for all VDCs.
<b>show mac vdc</b> { <i>vdc-id</i> }	Displays the MAC address for a specific VDC.

For detailed information about the fields in the output from these commands, see the *Cisco Nexus 7000 Series NX-OS Virtual Device Context Command Reference*.



# Configuration Example for Ethernet VDC Creation and Initialization

Beginning with the Cisco NX-OS Release 5.2(1), you can run FCoE on the Cisco Nexus Series 7000 devices. You must create a separate storage VDC to run FCoE. See the *Cisco NX-OS FCoE Configuration Guide for Cisco Nexus 7000 and Cisco MDS 9500* for an example of configuring a storage VDC.

This example shows how to create and initialize a VDC:

```
switch# config t
switch(config)# vdc test
switch(config-vdc)# allocate interface ethernet 2/46
Moving ports will cause all config associated to them in source vdc to be removed. Are you
sure you want to move the ports? [yes] yes
switch(config-vdc)# exit
switch(config)# switchto vdc test

---- System Admin Account Setup ----
Do you want to enforce secure password standard (yes/no) [y]: y
Enter the password for "admin":<password>
Confirm the password for "admin":<password>

---- Basic System Configuration Dialog ----
This setup utility will guide you through the basic configuration of
the system. Setup configures only enough connectivity for management
of the system.
Please register Cisco Nexus7000 Family devices promptly with your
supplier. Failure to register may affect response times for initial
service calls. Nexus7000 devices must be registered to receive
entitled support services.
Press Enter at anytime to skip a dialog. Use ctrl-c at anytime
to skip the remaining dialogs.
Would you like to enter the basic configuration dialog (yes/no): yes
Create another login account (yes/no) [n]: n
Configure read-only SNMP community string (yes/no) [n]: n
Configure read-write SNMP community string (yes/no) [n]: n
Enter the switch name : Test
Continue with Out-of-band (mgmt0) management configuration? (yes/no) [y]:

Mgmt0 IPv4 address : 10.10.5.5
Mgmt0 IPv4 netmask : 255.255.254.0
Configure the default gateway? (yes/no) [y]: y
IPv4 address of the default gateway : 10.10.5.1
Configure advanced IP options? (yes/no) [n]:
Enable the telnet service? (yes/no) [y]:
Enable the ssh service? (yes/no) [n]: y
Type of ssh key you would like to generate (dsa/rsa/rsa1) : rsa
Number of key bits <768-2048> : 768
Configure the ntp server? (yes/no) [n]:
Configure default switchport interface state (shut/noshut) [shut]:
Configure default switchport trunk mode (on/off/auto) [on]:
The following configuration will be applied:
switchname Test
interface mgmt0
ip address 10.10.5.5 255.255.254.0
no shutdown
exit
vrf context management
```

```

ip route 0.0.0.0/0 10.10.5.1
exit
telnet server enable
ssh key rsa 768 force
ssh server enable
system default switchport shutdown
system default switchport trunk mode on
Would you like to edit the configuration? (yes/no) [n]:
Use this configuration and save it? (yes/no) [y]:

[#####] 100%

Cisco Data Center Operating System (NX-OS) Software
TAC support: http://www.cisco.com/tac
Copyright (c) 2002-2007, Cisco Systems, Inc. All rights reserved.
The copyrights to certain works contained herein are owned by
other third parties and are used and distributed under license.
Some parts of this software may be covered under the GNU Public
License or the GNU Lesser General Public License. A copy of
each such license is available at
http://www.gnu.org/licenses/gpl.html and
http://www.gnu.org/licenses/lgpl.html
switch-test# exit
switch

```

This example displays the prompt to choose admin VDC during the switch bootup:

```

n7k-ts-2# show vdc
vdc_id   vdc_name   state   mac
-----
1        n7k-ts-2   active  00:22:55:7a:72:c1
2        c2         active  00:22:55:7a:72:c2
3        d2         active  00:22:55:7a:72:c3 <----! current name is 'd2'
4        dcn-sv     active  00:22:55:7a:72:c4

n7k-ts-2# switchto vdc d2

n7k-ts-2-d2(config)# hostname d2-new

n7k-ts-2-d2-new# 2010 Mar 16 18:40:40 n7k-ts-2-d2-new %$ VDC-3 %$
%VSHD-5-VSHD_SYSLOG_CONFIG_I: Configured from vty by on console0

n7k-ts-2-d2-new# exit

n7k-ts-2# show vdc
vdc_id   vdc_name   state   mac
-----
1        n7k-ts-2   active  00:22:55:7a:72:c1
2        c2         active  00:22:55:7a:72:c2
3        d2-new     active  00:22:55:7a:72:c3 <-----!!! VDC name changed
4        dcn-sv     active  00:22:55:7a:72:c4

n7k-ts-2# show running-config vdc
!Command: show running-config vdc
vdc d2-new id 3 <----- VDC name changed!!!!
allocate interface
Ethernet1/1-9,Ethernet1/11,Ethernet1/13,Ethernet1/15,Ethern
et1/25,Ethernet1/27,Ethernet1/29,Ethernet1/31
allocate interface Ethernet2/2-12
boot-order 1
limit-resource vlan minimum 16 maximum 4094
limit-resource monitor-session minimum 0 maximum 2
limit-resource vrf minimum 16 maximum 200

```

```
limit-resource port-channel minimum 0 maximum 768
limit-resource u4route-mem minimum 8 maximum 8
```

This running configuration example shows how a shared interface appears:

```
switch# show running-config vdc

!Command: show running-config vdc
no system admin-vdc
vdc N7710 id 1
limit-resource module-type f2e
allow feature-set fex
cpu-share 5
limit-resource vlan minimum 16 maximum 4094
limit-resource monitor-session-erspan-dst minimum 0 maximum 23
limit-resource vrf minimum 2 maximum 4096
limit-resource port-channel minimum 0 maximum 768
limit-resource u4route-mem minimum 96 maximum 96
limit-resource u6route-mem minimum 24 maximum 24
limit-resource m4route-mem minimum 58 maximum 58
limit-resource m6route-mem minimum 8 maximum 8
limit-resource monitor-session-inband-src minimum 0 maximum 1
limit-resource anycast_bundleid minimum 0 maximum 16
limit-resource monitor-session-extended minimum 0 maximum 16
limit-resource monitor-rbs-filter minimum 0 maximum 16
limit-resource monitor-rbs-product minimum 0 maximum 16

vdc storage id 2 type storage
limit-resource module-type f2e f3
allow feature-set fcoe
allow feature-set fex
cpu-share 5
allocate interface Ethernet2/17-20,Ethernet2/25-40
boot-order 1
limit-resource vlan minimum 16 maximum 4094
limit-resource monitor-session-erspan-dst minimum 0 maximum 23
limit-resource vrf minimum 2 maximum 4096
limit-resource port-channel minimum 0 maximum 768
limit-resource u4route-mem minimum 8 maximum 8
limit-resource u6route-mem minimum 4 maximum 4
limit-resource m4route-mem minimum 8 maximum 8
limit-resource m6route-mem minimum 5 maximum 5
limit-resource monitor-session-inband-src minimum 0 maximum 1
limit-resource anycast_bundleid minimum 0 maximum 16
limit-resource monitor-session-extended minimum 0 maximum 16
limit-resource monitor-rbs-filter minimum 0 maximum 16
limit-resource monitor-rbs-product minimum 0 maximum 16

vdc ethernet id 3
limit-resource module-type f2e f3
allow feature-set fex
cpu-share 5
allocate interface
Ethernet2/1-16,Ethernet2/21-24,Ethernet2/41-48
boot-order 1
limit-resource vlan minimum 16 maximum 4094
limit-resource monitor-session-erspan-dst minimum 0 maximum 23
limit-resource vrf minimum 2 maximum 4096
limit-resource port-channel minimum 0 maximum 768
limit-resource u4route-mem minimum 8 maximum 8
limit-resource u6route-mem minimum 4 maximum 4
limit-resource m4route-mem minimum 8 maximum 8
limit-resource m6route-mem minimum 5 maximum 5
limit-resource monitor-session-inband-src minimum 0 maximum 1
limit-resource anycast_bundleid minimum 0 maximum 16
```

```

limit-resource monitor-session-extended minimum 0 maximum 16
limit-resource monitor-rbs-filter minimum 0 maximum 16
limit-resource monitor-rbs-product minimum 0 maximum 16

vdc storage id 2
allocate fcoe-vlan-range 30-50 from vdc ethernet
allocate fcoe-vlan-range 100 from vdc ethernet
allocate fcoe-vlan-range 400 from vdc ethernet
allocate shared interface Ethernet2/41-48

```

## Configuration Examples for Default and Nondefault VDCs

### Example Running Configuration from the Default VDC

This example shows a nondefault VDC configuration from the running configuration of the default VDC:

```

vdc payroll id 2
limit-resource vlan minimum 16 maximum 4094
limit-resource monitor-session minimum 0 maximum 2
limit-resource vrf minimum 16 maximum 1000
limit-resource port-channel minimum 0 maximum 192
limit-resource u4route-mem minimum 8 maximum 80
limit-resource u6route-mem minimum 4 maximum 48

```

### Example Running Configuration from a Nondefault VDC

This example shows the initial running configuration from a nondefault VDC:

```

version 4.0(1)
username admin password 5 $1$/CsUmTw5$/.3SZpb8LRsk9HdWAsQ501 role vdc-admin
telnet server enable
ssh key rsa 768 force
aaa group server radius aaa-private-sg
    use-vrf management
snmp-server user admin vdc-admin auth md5 0x061d8e733d8261dfb2713a713a95e87c priv
0x061d8e733d8261dfb2713a713a95e87c localizedkey
vrf context management
ip route 0.0.0.0/0 10.10.5.1

interface Ethernet2/46

interface mgmt0
ip address 10.10.5.5/23

```

## Related Documents for Creating VDCs

Related Topic	Document Title
Cisco NX-OS licensing	<i>Cisco Nexus 7000 Series NX-OS Unicast Routing Command Reference</i>
Cisco Nexus 7000 Series 32-port 10-Gbps Ethernet modules	<i>Cisco Nexus 7000 Series Hardware Installation and Reference Guide</i>

Related Topic	Document Title
VDC commands	<i>Cisco Nexus 7000 Series NX-OS Virtual Device Context Command Reference</i>
FCoE commands	<i>Cisco NX-OS FCoE Command Reference for Cisco Nexus 7000 and Cisco MDS 9500</i>

## Feature History for Creating VDCs

This table includes only the updates for those releases that have resulted in additions or changes to the feature.

**Table 11: Feature History for Creating VDCs**

Feature Name	Release	Feature Information
Cisco Nexus 7710 switch and Cisco Nexus 7718 switch	6.2(2)	Added support for the Cisco Nexus 7710 switch and the Cisco Nexus 7718 switch on the Supervisor 2e module.
Admin VDC on Supervisor 1 module	6.2(2)	Added support for admin VDC on the Supervisor 1 module.
F2e Series modules	6.2(2)	Added the ability to enable the F2e Series module (a new configurable VDC module type, independent from and separate to the F2 VDC module type) on the chassis.
F2e Series modules	6.1(2)	Added support for storage VDCs on F2e Series modules
Supervisor modules, Number of VDCs, and the VDC license	6.1(1)	Added support for the new supervisor modules and increased number of VDCs, support for storage VDCs on F2 Series modules, and the VDC license requirement for Supervisor 2 and additional VDCs.
F2 Series module	6.0(1)	Added support for the F2 Series module.
Creating VDCs	6.0(1)	No change from Cisco NX-OS Release 5.2.
FCoE	5.2(1)	Added support for storage VDCs and the FCoE feature.
N7K-F132XP-15 module	5.1(1)	Added support for the N7K-F132XP-15 module.
Creating VDCs	4.2(1)	No change from Cisco NX-OS Release 4.1(2).
IPv4 unicast route memory resource	4.1(2)	Changed the default maximum value from 256 to 8.

Feature Name	Release	Feature Information
IPv6 unicast route memory resource	4.1(2)	Changed the default maximum value from 256 to 4.
Multicast route memory resources	4.1(2)	Added IPv4 and IPv6 multicast route memory resources.
Port channel resources	4.1(2)	Changed the default maximum value from 256 to 768.
IPv4 unicast route memory resource	4.0(2)	Changed the default maximum value from 256 to 320.
IPv6 unicast route memory resource	4.0(2)	Changed the default maximum value from 256 to 192.



## CHAPTER 6

# Managing VDCs

---

This chapter describes how to manage virtual device contexts (VDCs) on Cisco NX-OS devices.

- [Finding Feature Information, on page 53](#)
- [Information About Managing VDCs, on page 53](#)
- [Prerequisites for Managing VDCs, on page 70](#)
- [Guidelines and Limitations for Managing VDCs, on page 70](#)
- [Managing VDCs, on page 73](#)
- [Verifying the VDC Configuration, on page 91](#)
- [Configuration Examples for VDC Management, on page 91](#)
- [Related Documents for Managing VDCs, on page 92](#)
- [Feature History for Managing VDCs, on page 92](#)

## Finding Feature Information

Your software release might not support all the features documented in this module. For the latest caveats and feature information, see the Bug Search Tool at <https://tools.cisco.com/bugsearch/> and the release notes for your software release. To find information about the features documented in this module, and to see a list of the releases in which each feature is supported, see the "New and Changed Information" chapter or the Feature History table in this chapter.

## Information About Managing VDCs

After you create a VDC, you can change the interface allocation, VDC resource limits, and the single-supervisor and dual-supervisor high availability (HA) policies. You can also save the running configuration of all VDCs on the physical device to the startup configuration.



**Note** Ports on F3 modules may increment L1 and/or L2 errors (symbol errors, FCS errors, CRC errors, and so on) in the following instances:

- a) Link goes up and then down (errors will increment during link down and link up; errors will stop incrementing if the link is fully up)
- b) Link is down but optics and cable are still plugged in.

Workaround: Administratively shut down any unused ports.

In case, any of these errors are incrementing during traffic transmission, there may be genuine issue with optics and/or cable or F3 hardware and these cases need to be investigated by Cisco TAC.

The following VDC type support is available in Cisco NX-OS Release 7.3(0)DX(1) and Cisco NX-OS Release 7.3(1)D1(1):

VDC Type	Layer 2	Layer 3	Fabric Path	VxLAN	FEX	MPLS	OTV	LISP	GTP	L2 Gateways	Table Sizes
M3	Yes	Yes	No	Yes	No	Yes	Yes	Yes	Yes	Yes	M3 size
F3+M3	Yes	Yes	No	Yes	No	Yes	Yes	Yes	No	No	F3 size

Starting from Cisco NX-OS Release 8.0(1), the following VDC type support is available:

VDC Type	Layer 2	Layer 3	Fabric Path	VxLAN	FEX	MPLS	OTV	LISP	GTP	L2 Gateways	Table Sizes
M2+M3	Yes	Yes	No	Yes	No	Yes	Yes	Yes	No	No	M2

For more information on feature support for specific releases, see the [Cisco Nexus 7000 Series Release Notes](#).

## Interface Allocation



**Note** See the *Cisco NX-OS FCoE Configuration Guide for Cisco Nexus 7000 and Cisco MDS 9500 Guide* for information on allocating interfaces for storage VDCs and FCoE.

When you create a VDC, you can allocate I/O interfaces to the VDC. Later, the deployment of your physical device might change, and you can reallocate the interfaces as necessary.



**Note** Beginning with Cisco NX-OS Release 5.2(1) for Nexus 7000 Series devices, all members of a port group are automatically allocated to the VDC when you allocate an interface.

The following Cisco Nexus 7000 Series Ethernet modules have the following number of port groups and interfaces:



- N7K-F132XP-15 (2 interfaces x 16 port groups = 32 interfaces)—There are no restrictions on the interface allocation between VDCs, but we recommend that interfaces that belong to the same port group be in a single VDC.
- N7K-F248XP-25, N7K-F248XP-25E, N7K-F248XT-25E, N77-F248XP-23E (4 interfaces x 12 port groups = 48 interfaces)—There are no restrictions on the interface allocation between VDCs, but we recommend that interfaces that belong to the same port group be in a single VDC.
- N77-F248XP-23E (4 interfaces x 12 port groups = 48 interfaces)—There are no restrictions on the interface allocation between VDCs, but we recommend that interfaces that belong to the same port group be in a single VDC.
- N7K-F306CK-25—Has six ASICs, 6 port groups of 1x100G ASIC.
- N7K-F312FQ-25—Has six ASICs, 6 port groups of 2x40G ASIC.
- N7K-F348XP-25—Has six ASICs, 6 port groups of 8x10G ASIC.
- N77-F312CK-26—Has twelve ASICs, 12 port groups of 1x100G ASIC.
- N77-F324FQ-25—Has twelve ASICs, 12 port groups of 2x40G ASIC.
- N77-F348XP-23—Has six ASICs, 6 port groups of 8x10G ASIC.
- N7K-M108X2-12L (1 interface x 8 port groups = 8 interfaces)—There are no restrictions on the interface allocation between VDCs.
- N7K-M132XP-12 (4 interfaces x 8 port groups = 32 interfaces) and N7K-M132XP-12L (same as non-L M132) (1 interface x 8 port groups = 8 interfaces)—All M132 cards require allocation in groups of 4 ports and you can configure 8 port groups. Interfaces belonging to the same port group must belong to the same VDC.
- N7K-M148GS-11 (12 interfaces x 4 port groups = 48 interfaces), N7K-M148GS-11L, N7K-M148GT-11, N7K-M148GT-11L (same as non-L M148) (1 interface x 48 port groups = 48 interfaces) —There are no restrictions on the interface allocation between VDCs, but we recommend that interfaces that belong to the same port group be in a single VDC.
- N7K-M202CF-22L (1 interface x 2 port groups = 2 interfaces)—There are no restrictions on the interface allocation between VDCs.
- N7K-M206FQ-23L (1 interface x 6 port groups = 6 interfaces)—There are no restrictions on the interface allocation between VDCs.
- N7K-M224XP-23L (1 interface x 24 port groups = 24 interfaces)—There are no restrictions on the interface allocation between VDCs.
- N7K-M324FQ-25L—Has four ASICs, 4 port groups of 6x40G ASIC.
- N7K-M348XP-25L—Has two ASICs, 2 port groups of 24x10G ASIC.

The Cisco Nexus 7700 Series M3 Ethernet modules have the following number of port groups and interfaces. VDC allocation is based on port group boundaries.

- N77-M312CQ-26L—Has six ASICs, 6 port groups of 2x100G ASIC
- N77-M324FQ-25L—Has four ASICs, 4 port groups of 6x40G ASIC.
- N77-M348XP-23L—Has two ASICs, 2 port groups of 24x10G ASIC.

On the Cisco Nexus 7000 Series 32-port, 10-Gbps Ethernet module N7K-F132XP-15, you must allocate the interfaces on your physical device in the specified combination. This module has 16 port groups that consist of 2 ports each (2 interfaces x 16 port groups = 32 interfaces). Interfaces that belong to the same port group must belong to the same VDC.



**Note** You can configure the limit-resource module-type command only from the VDC configuration mode and not from a VDC resource template.

**Figure 14: Example Interface Allocation for Port Groups on a Cisco 7000 Series 10-Gbps Ethernet Module (N7K-F132XP-15)**



The callouts in the figure above represent an example of VDC allocation. The table below shows the VDC that each callout represents.

**Table 12: Example VDC Allocation**

VDC	Callout
VDC A	1
VDC B	2
VDC C	3
VDC D	4

The table below shows the port numbering for the port groups.

**Table 13: Port Numbers for Port Groups on the Cisco Nexus 7000 Series 10-Gbps Ethernet Module N7K-F132XP-15**

Port Group	Port Numbers
Group 1	1 and 2
Group 2	3 and 4
Group 3	5 and 6
Group 4	7 and 8
Group 5	9 and 10
Group 6	11 and 12
Group 7	13 and 14

Port Group	Port Numbers
Group 8	15 and 16
Group 9	17 and 18
Group 10	19 and 20
Group 11	21 and 22
Group 12	23 and 24
Group 13	25 and 26
Group 14	27 and 28
Group 15	29 and 30
Group 16	31 and 32

On the Cisco Nexus 7000 Series 48-port, 10-Gbps Ethernet modules N7K-F248XP-25[E] and N7K-F248XT-25[E], you must allocate the interfaces on your physical device in the specified combination. These modules have 12 port groups that consist of 4 ports each (4 interfaces x 12 port groups = 48 interfaces). Interfaces that belong to the same port group must belong to the same VDC.

**Figure 15: Example Interface Allocation for Port Groups on the Cisco Nexus 7000 Series 10-Gbps Ethernet Modules N7K-F248XP-25[E] and N7K-F248XT-25[E] and Cisco Nexus 7700 Series 48-Port 1 and 10-Gbps Ethernet Module N77-F248XP-23E**

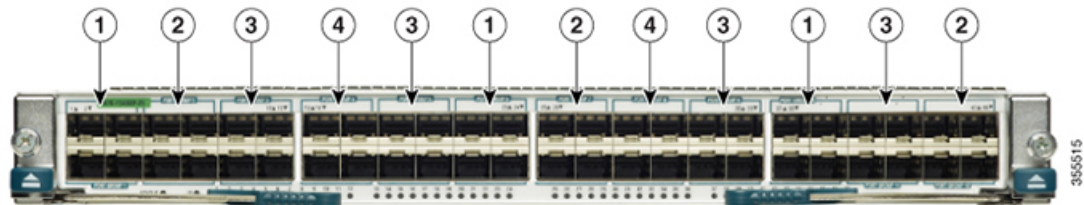

The callouts in the figure above represent an example of VDC allocation. The table below shows the VDC that each callout represents.

**Table 14: Example VDC Allocation**

VDC	Callout
VDC A	1
VDC B	2
VDC C	3
VDC D	4

The table below shows the port numbering for the port groups.

**Table 15: Port Numbers for Port Groups on the Cisco Nexus 7000 Series 10-Gbps Ethernet Modules N7K-F248XP-25[E] and N7K-F248XT-25[E] and Cisco Nexus 7700 Series 48-Port 1 and 10-Gbps Ethernet Module N77-F248XP-23E**

Port Group	Port Numbers
Group 1	1, 2, 3, 4
Group 2	5, 6, 7, 8
Group 3	9, 10, 11, 12
Group 4	13, 14, 15, 16
Group 5	17, 18, 19, 20
Group 6	21, 22, 23, 24
Group 7	25, 26, 27, 28
Group 8	29, 30, 31, 32
Group 9	33, 34, 35, 36
Group 10	37, 38, 39, 40
Group 11	41, 42, 43, 44
Group 12	45, 46, 47, 48

For more information about port groups on the Cisco Nexus 7000 Series 10-Gbps Ethernet modules, see the *Cisco Nexus 7000 Series Hardware Installation and Reference Guide*.



**Note** When you add or delete interfaces, the Cisco NX-OS software removes the configuration and disables the interfaces.

**Figure 16: Example Interface Allocation for Port Groups on the Cisco Nexus 7000 Series 100-Gbps Ethernet Modules (N7K-F306CK-25)**

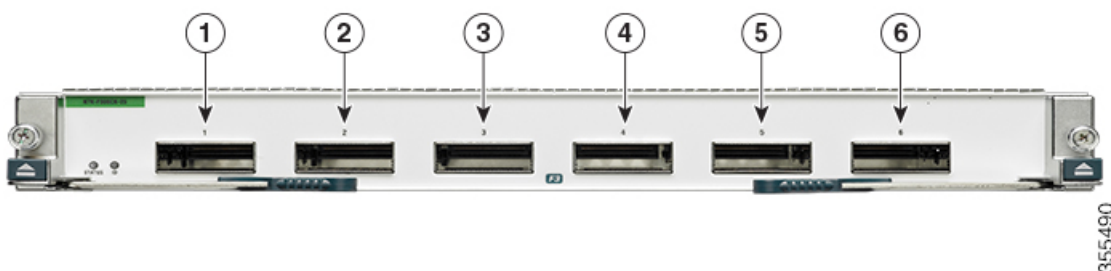

The callouts in the figure above represent an example of VDC allocation. The table below shows the VDC that each callout represents.

**Table 16: Example VDC Allocation**

VDC	Callout
VDC A	1
VDC B	2
VDC C	3
VDC D	4
VDC E	5
VDC F	6

The table below shows the port numbering for the port groups.

**Table 17: Port Numbers for Port Groups on the Cisco Nexus 7000 Series 100-Gbps Ethernet Modules (N7K-F306CK-25)**

Port Group	Port Numbers
Group 1	1
Group 2	2
Group 3	3
Group 4	4
Group 5	5
Group 6	6

**Figure 17: Example Interface Allocation for Port Groups on the Cisco Nexus 7700 Series 100-Gbps Ethernet Modules (N77-F312CK-26)**

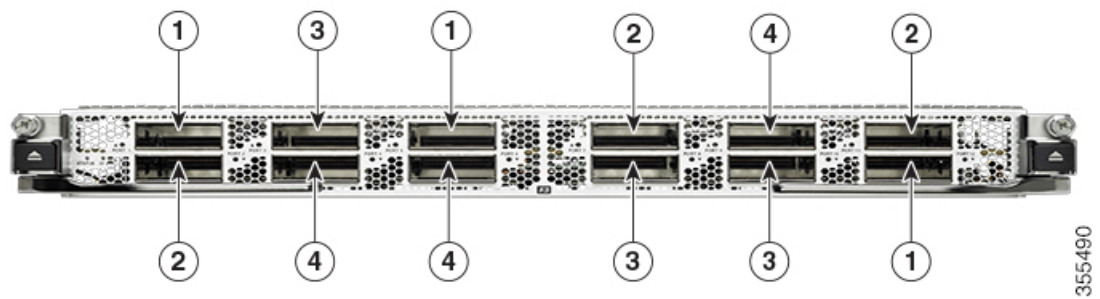

The callouts in the figure above represent an example of VDC allocation. The table below shows the VDC that each callout represents.

**Table 18: Example VDC Allocation**

VDC	Callout
VDC A	1

VDC	Callout
VDC B	2
VDC C	3
VDC D	4

The table below shows the port numbering for the port groups.

**Table 19: Port Numbers for Port Groups on the Cisco Nexus 7700 Series 100-Gbps Ethernet Modules (N77-F312CK-26)**

Port Group	Port Numbers
Group 1	1
Group 2	2
Group 3	3
Group 4	4
Group 5	5
Group 6	6
Group 7	7
Group 8	8
Group 9	9
Group 10	10
Group 11	11
Group 12	12

**Figure 18: Example Interface Allocation for Port Groups on the Cisco Nexus 7000 Series 40-Gbps Ethernet Modules (N7K-F312FQ-25)**

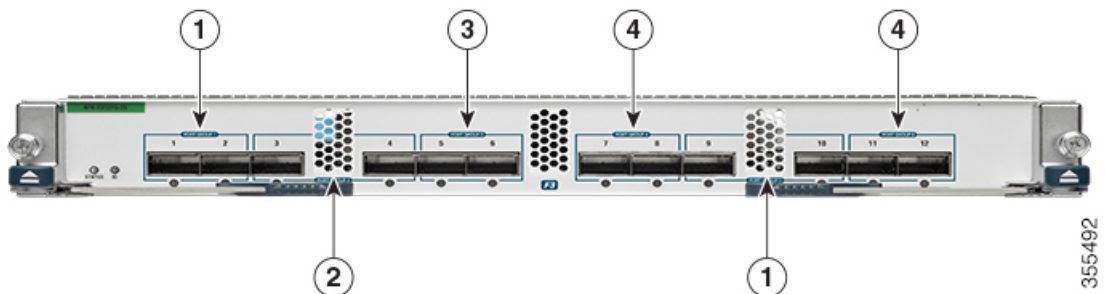

The callouts in the figure above represent an example of VDC allocation. The table below shows the VDC that each callout represents.

**Table 20: Example VDC Allocation**

VDC	Callout
VDC A	1
VDC B	2
VDC C	3
VDC D	4

The table below shows the port numbering for the port groups.

**Table 21: Port Numbers for Port Groups on the Cisco Nexus 7000 Series 40-Gbps Ethernet Modules (N7K-F312FQ-25)**

Port Group	Port Numbers
Group 1	1, 2
Group 2	3, 4
Group 3	5, 6
Group 4	7, 8
Group 5	9, 10
Group 6	11, 12

**Figure 19: Example Interface Allocation for Port Groups on the Cisco Nexus 7700 Series 40-Gbps Ethernet Modules (N77-F324FQ-25)**

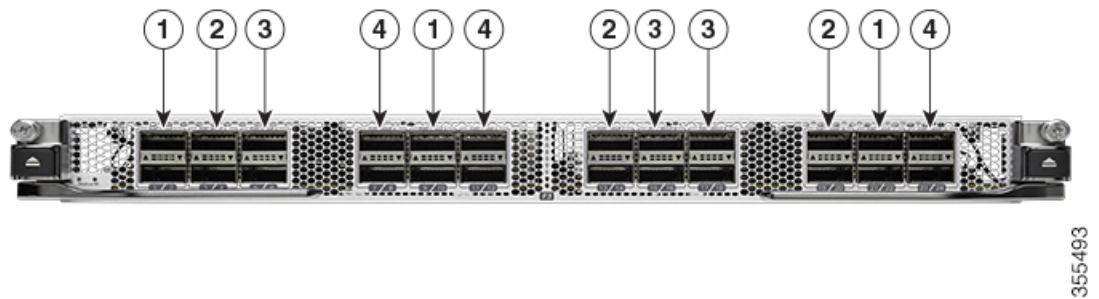

The callouts in the figure above represent an example of VDC allocation. The table below shows the VDC that each callout represents.

**Table 22: Example VDC Allocation**

VDC	Callout
VDC A	1
VDC B	2
VDC C	3

VDC	Callout
VDC D	4

The table below shows the port numbering for the port groups.

**Table 23: Port Numbers for Port Groups on the Cisco Nexus 7700 Series 40-Gbps Ethernet Modules (N77-F324FQ-25)**

Port Group	Port Numbers
Group 1	1, 2
Group 2	3, 4
Group 3	5, 6
Group 4	7, 8
Group 5	9, 10
Group 6	11, 12
Group 7	13, 14
Group 8	15, 16
Group 9	17, 18
Group 10	19, 20
Group 11	21, 22
Group 12	23, 24

**Figure 20: Example Interface Allocation for Port Groups on the Cisco Nexus 7000 Series 10-Gbps Ethernet Modules (N7K-F348XP-25)**

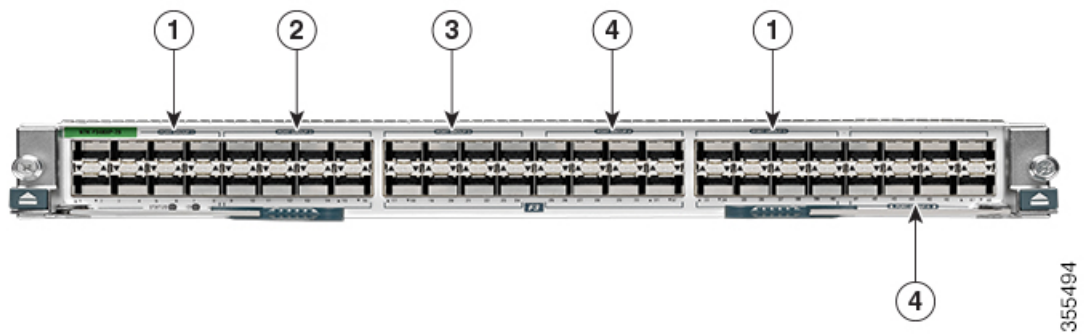



**Figure 21: Example Interface Allocation for Port Groups on the Cisco Nexus 7700 Series 10-Gbps Ethernet Modules (N77-F348XP-23)**

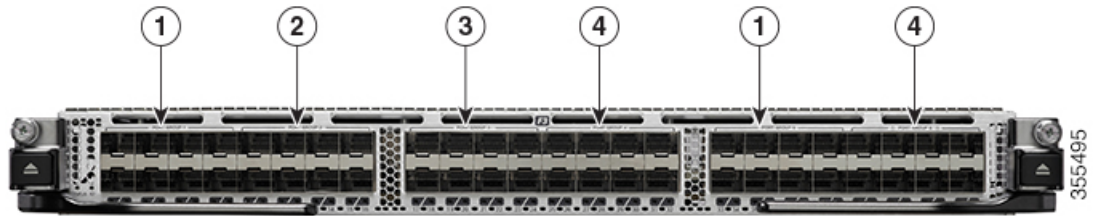

The callouts in the figures above represent an example of VDC allocation. The table below shows the VDC that each callout represents.

**Table 24: Example VDC Allocation**

VDC	Callout
VDC A	1
VDC B	2
VDC C	3
VDC D	4

The table below shows the port numbering for the port groups.

**Table 25: Port Numbers for Port Groups on the Cisco Nexus 7000 Series 10-Gbps Ethernet Modules (N7K-F348XP-25) and the Cisco Nexus 7700 Series 10-Gbps Ethernet Modules (N77-F348XP-23)**

Port Group	Port Numbers
Group 1	1, 2, 3, 4, 5, 6, 7, 8
Group 2	9, 10, 11, 12, 13, 14, 15, 16
Group 3	17, 18, 19, 20, 21, 22, 23, 24
Group 4	25, 26, 27, 28, 29, 30, 31, 32
Group 5	33, 34, 35, 36, 37, 38, 39, 40
Group 6	41, 42, 43, 44, 45, 46, 47, 48

Figure 22: Example Interface Allocation for Port Groups on the Cisco Nexus 7000 Series 10-Gbps Ethernet Module (N7K-M132XP-12)

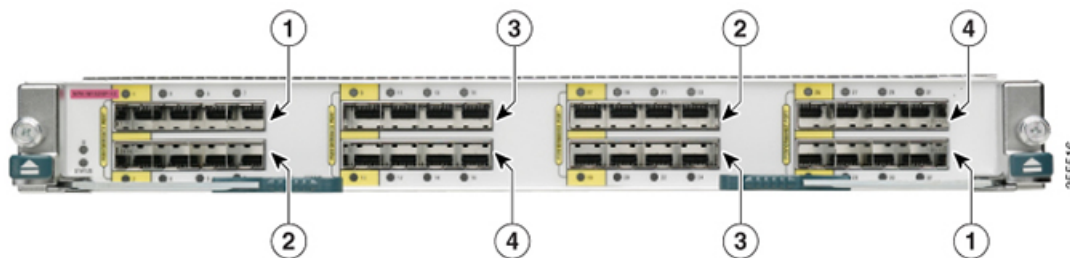

The callouts in the figure above represent an example of VDC allocation. The table below shows the VDC that each callout represents.

Table 26: Example VDC Allocation

VDC	Callout
VDC A	1
VDC B	2
VDC C	3
VDC D	4

The table below shows the port numbering for the port groups.

Table 27: Port Numbers for Port Groups on the Cisco Nexus 7000 Series 10-Gbps Ethernet Module N7K-M132XP-12

Port Group	Port Numbers
Group 1	1, 3, 5, 7
Group 2	2, 4, 6, 8
Group 3	9, 11, 13, 15
Group 4	10, 12, 14, 16
Group 5	17, 19, 21, 23
Group 6	18, 20, 22, 24
Group 7	25, 27, 29, 31
Group 8	26, 28, 30, 32

Figure 23: Example Interface Allocation for Port Groups on the Cisco Nexus 7700 Series 100-Gbps Ethernet Modules (N77-M312CQ-26L)

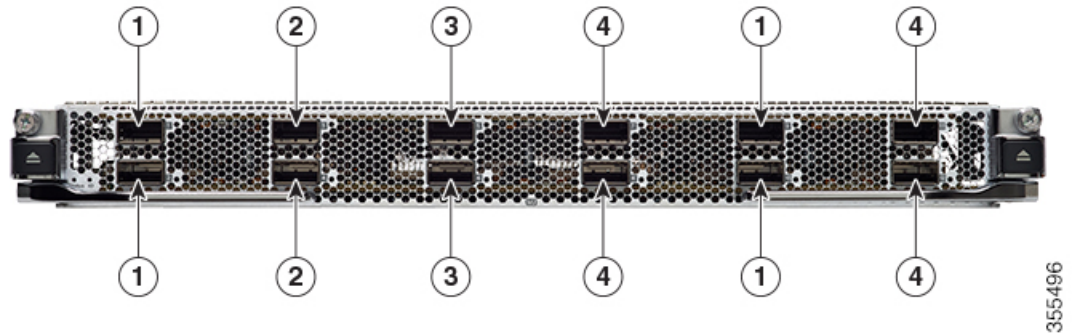

The callouts in the figure above represent an example of VDC allocation. The table below shows the VDC that each callout represents.

Table 28: Example VDC Allocation

VDC	Callout
VDC A	1
VDC B	2
VDC C	3
VDC D	4

The table below shows the port numbering for the port groups.

Table 29: Port Numbers for Port Groups on the Cisco Nexus 7700 Series 100-Gbps Ethernet Modules (N77-M312CQ-26L)

Port Group	Port Numbers
Group 1	1, 2
Group 2	3, 4
Group 3	5, 6
Group 4	7, 8
Group 5	9, 10
Group 6	11, 12

Figure 24: Example Interface Allocation for Port Groups on the Cisco Nexus 7000 Series 40-Gbps Ethernet Modules (N7K-M324FQ-25L)

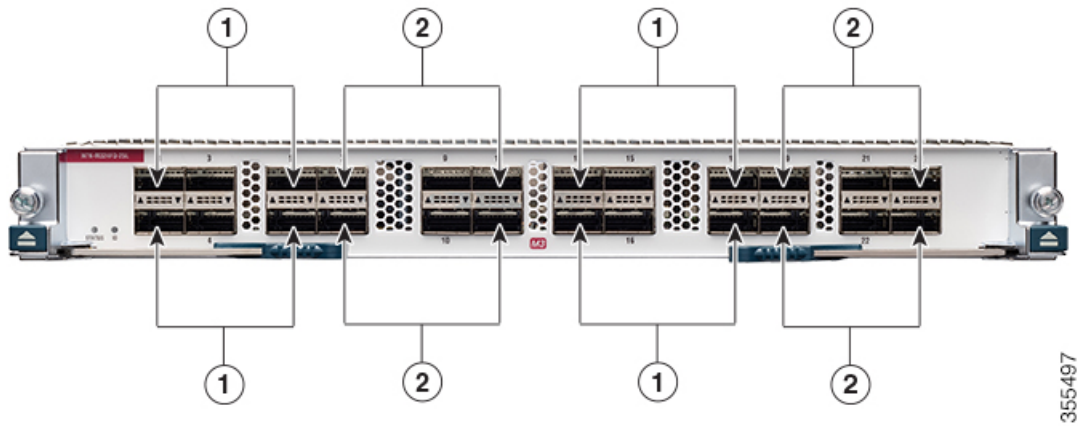

The callouts in the figure above represent an example of VDC allocation. The table below shows the VDC that each callout represents.

Table 30: Example VDC Allocation

VDC	Callout
VDC A	1
VDC B	2

The table below shows the port numbering for the port groups.

Table 31: Port Numbers for Port Groups on the Cisco Nexus 7000 Series 40-Gbps Ethernet Modules (N7K-M324FQ-25L) and Cisco Nexus 7700 Series 40-Gbps Ethernet Modules (N77-M324FQ-25L)

Port Group	Port Numbers
Group 1	1, 2, 3, 4, 5, 6
Group 2	7, 8, 9, 10, 11, 12
Group 3	13, 14, 15, 16, 17, 18
Group 4	19, 20, 21, 22, 23, 24

Figure 25: Example Interface Allocation for Port Groups on the Cisco Nexus 7000 Series 10-Gbps Ethernet Modules (N7K-M348XP-25L)

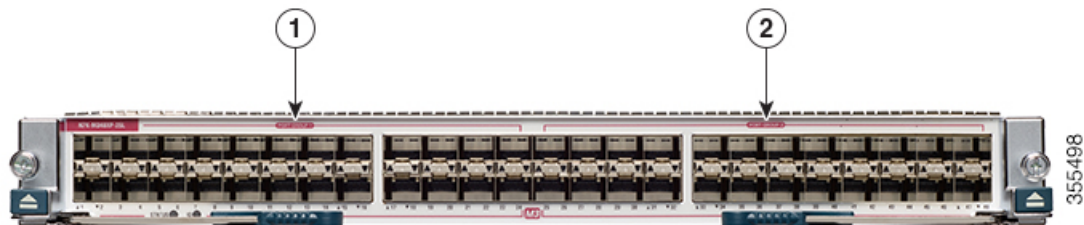

Figure 26: Example Interface Allocation for Port Groups on the Cisco Nexus 7700 Series 10-Gbps Ethernet Modules (N77-M348XP-23L)

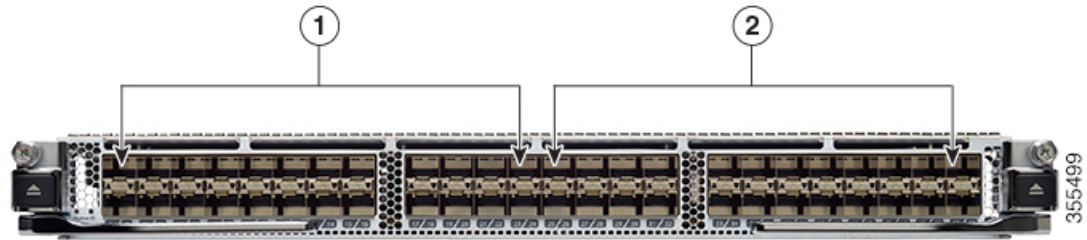

Table 32: Example VDC Allocation

VDC	Callout
VDC A	1
VDC B	2

The table below shows the port numbering for the port groups.

Table 33: Port Numbers for Port Groups on the Cisco Nexus 7000 Series 10-Gbps Ethernet Modules (N7K-M348XP-25L) and Cisco Nexus 7700 Series 10-Gbps Ethernet Modules (N77-M348XP-23L)

Port Group	Port Numbers
Group 1	1, 2, 3, 4, 5, 6, 7, 8, 9, 10, 11, 12, 13, 14, 15, 16, 17, 18, 19, 20, 21, 22, 23, 24
Group 2	25, 26, 27, 28, 29, 30, 31, 32, 33, 34, 35, 36, 37, 38, 39, 40, 41, 42, 43, 44, 45, 46, 47, 48

When interfaces in different VDCs share the same port ASIC, reloading the VDC (with the reload vdc command) or provisioning interfaces to the VDC (with the allocate interface command) might cause short traffic disruptions (of 1 to 2 seconds) for these interfaces. If such behavior is undesirable, make sure to allocate all interfaces on the same port ASIC to the same VDC.

This example shows how to map interfaces to the port ASIC:

```
# slot slot_number show hardware internal dev-port-map
+-----+
+-----++FRONT PANEL PORT TO ASIC INSTANCE MAP+++-----+
+-----+
FP port|PHYS |SECUR |MAC_0 |RWR_0 |L2LKP |L3LKP |QUEUE |SWICHF
  1    0    0      0      0      0      0      0      0
  2    0    0      0      0      0      0      0      0
  3    0    0      0      0      0      0      0      0
  4    0    0      0      0      0      0      0      0
  5    0    1      0      0      0      0      0      0
  6    0    1      0      0      0      0      0      0
  7    0    1      0      0      0      0      0      0
  8    0    1      0      0      0      0      0      0
  9    1    2      0      0      0      0      0      0
 10    1    2      0      0      0      0      0      0
 11    1    2      0      0      0      0      0      0
```

12	1	2	0	0	0	0	0	0
13	1	3	1	0	0	0	0	0
14	1	3	1	0	0	0	0	0
15	1	3	1	0	0	0	0	0
16	1	3	1	0	0	0	0	0
17	2	4	1	0	0	0	0	0

The interface number is listed in the FP port column, and the port ASIC number is listed in the MAC\_0 column, which means that in the above example, interfaces 1 through 12 share the same port ASIC (0).

## VDC Resource Limits

You can change the resource limits for your VDC individually or by applying a VDC resource template as your needs change. You can change the following limits for the following resources:

- IPv4 multicast route memory
- IPv6 multicast route memory
- IPv4 unicast route memory
- IPv6 unicast route memory
- Port channels
- Switched Port Analyzer (SPAN) monitor sessions
- VLANs
- Virtual routing and forwarding (VRF) instances

## HA Policies

The HA policy determines the action that the physical device takes when the VDC encounters an unrecoverable error. You can change the HA policy for the VDC that was specified when you created the VDC.



---

**Note** You cannot change the HA policies for the default VDC.

---

## Saving All VDC Configurations to the Startup Configuration

From the VDC, a user with the vdc-admin or network-admin role can save the VDC configuration to the startup configuration. However, you might want to save the configuration of all VDCs to the startup configuration from the default VDC.

## Suspending and Resuming VDCs

Users with the network-admin role can suspend and resume a nondefault VDC. You must save the VDC running configuration to the startup configuration before suspending the VDC. Otherwise, you will lose the changes to the running configuration when you resume the VDC. You cannot remove interfaces allocated to a suspended VDC. All other resources in use by the VDC are released while the VDC is suspended.



---

**Note** You cannot perform an in-service software upgrade (ISSU) when a VDC is suspended.

---



---

**Note** You cannot suspend the default VDC.

---



---

**Caution** Suspending a VDC disrupts all traffic on the VDC.

---

## VDC Reloads

You can reload an active nondefault VDC that is in any state. The impact of reloading a nondefault VDC is similar to reloading a physical device. The VDC reloads using the startup configuration.



---

**Note** You cannot reload the default or admin VDC.

---



---

**Caution** Reloading a VDC disrupts all traffic on the VDC.

---

## MAC Addresses

The default VDC has a management MAC address. Beginning with Cisco NX-OS Release 5.2(1) for the Cisco Nexus 7000 Series devices, subsequent nondefault VDCs that you create are assigned MAC addresses automatically as part of the bootup process.

You will see a syslog message if there are not sufficient MAC addresses to supply all the VDCs on the device.

## VDC Boot Order

You can specify the boot order for the VDCs on the Cisco NX-OS device. By default, all VDCs start in parallel with no guarantee as to which VDC completes starting first. Using the boot order value, the Cisco NX-OS software starts the VDCs in a predictable sequence. The boot order feature has the following characteristics:

- More than one VDC can have the same boot order value. By default, all VDCs have the boot order value of 1.
- VDCs with the lowest boot order value boot first.
- The Cisco NX-OS software starts all VDCs with the same boot order value followed by the VDCs with the next highest boot order value.
- The Cisco NX-OS software starts VDCs that have the same boot order value in parallel.

- You cannot change the boot order for the default VDC or admin VDC; you can change the boot order only for nondefault VDCs.

## Prerequisites for Managing VDCs

VDC management has the following prerequisites:

- You must have the network-admin user role.
- You must log in to the default or admin VDC.

## Guidelines and Limitations for Managing VDCs

VDC management has the following configuration guidelines and limitations:

- Only users with the network-admin user role can manage VDCs.
- You can change VDCs only from the default or admin VDC.
- If sufficient MAC addresses to program the management port of all the nondefault VDCs are unavailable, do not program the MAC address in any of the nondefault VDCs.
- A syslog message is generated if sufficient MAC addresses are unavailable to program the management port in all VDCs.
- When a hardware issue occurs, syslog messages are sent to all VDCs.
- When you have back-to-back connected interfaces in two different virtual routing and forwarding (VRF) instances within the same VDC, the Address Resolution Protocol (ARP) fails to complete and packet drops occur because the VRFs obtain their own source MAC addresses. If you need two interfaces on the same VDC with different VRFs, assign a static MAC address to the VRF interfaces.
- When you replace an I/O module by another I/O module in the same slot of a Cisco Nexus 7000/7700 Series switch and power up the switch, the new I/O module is powered down and the following syslog message is displayed: **Slot-<x> has failed to boot up because of service "Im SAP" due to module insertion failure**. To resume normal operations, power up the I/O module after all the VDCs are online. The following syslog message is then displayed: **IM-1-IM\_LC\_INCOMPATIBLE\_COPY\_R\_S: Module <x> inserted is not compatible with previous module in this slot. To ensure correct operation, do <copy run start vdc-all> to purge the previous module's configuration**. After the I/O module is online, use the **copy run start vdc-all** command and perform the required configurations.

### M2-M3 Interop limitations

The following rules will be enforced for M line modules:

- M2 interfaces can coexist with M3 or M2 interfaces in same VDC. However, F2E and M3 interfaces cannot coexist.
- No interface from M2 module working with M3 interface can be allocated to other VDC.
- M2 module must be in M2-M3 interop mode, if M3 interface exists in same VDC.



- M2 module must be in M2-F2E mode, if F2E interface exists in same VDC.
- M2 LC must be in M2-M3 mode, if its ports must work in/be allocated to a M2-M3 VDC.



---

**Note** This is applicable even if M3 ports exists or not.

---

- M2 LC must be in M2-F2E mode(default mode), to operate in other VDC.

You must configure interop mode, before applying the ASCII configuration. This avoids applying port related configuration while LC reboots. For information about M2-M3 VDC and Interoperability mode, see [M2-M3 VDC and Interoperability mode, on page 81](#).

If the topology configuration consists of any VDC type M2 M3 with ports allocated from a M2 module to this VDC, performing a write-erase+reload+ascii configuration replay may result in port allocation errors during the configuration replay.

1. Save the running configuration to the bootflash.  
Verify the configuration to contain **system interop-mode m2-m3 module x**.
2. Perform write-erase and reload the configuration.
3. Bring up the switch and verify all the modules are online.
4. Configure the interop mode using the commands in the saved configuration.  
Type **Yes** when prompted to reload the modules.
5. Wait until all the modules are Online.
6. Apply the saved ASCII configuration.

If you reload configuration using **reload ascii** command, port allocation errors may occur during the configuration replay. Perform the following procedure to troubleshoot.

1. Save the running configuration to bootflash.
2. Perform reload ascii.
3. Wait until all modules and VDCs are online.
4. Apply the saved ASCII configuration from bootflash.

Along with the above mentioned guidelines and restrictions, the following are applicable from Cisco Nexus 7000 NX-OS Release 7.3(0)DX(1):

- Cisco Nexus 7700 series had the following types of M3 module:
  - Nexus 7700 M3 48-Port 1G/10G Module
  - Nexus 7700 M3 24-Port 40G
- The 48 port 10G module has two sockets of 24 X 10G ASIC.
- The 24 port 40G module has four sockets of 6 X 40G ASIC.
- The port group mappings are per ASIC.

- Interface allocation is done on the port group boundaries. The interfaces align ASIC resources to VDCs.
- The port group size varies depending on the module type.

Along with the above mentioned guidelines and restrictions, the following are applicable from Cisco Nexus 7000 NX-OS Release 8.0(1):

- Cisco Nexus 7000 Series switches has the following types of M3-Series modules:
  - 48-port 1-/10-Gigabit Ethernet I/O module (N7K-M348XP-25L)
  - 24-port 40-Gigabit Ethernet I/O module (N7K-M324FQ-25L)
- The 48 port 10G module has two sockets of 24 X 10G ASIC.
- The 24 port 40G module has four sockets of 6 X 40G ASIC.
- Cisco Nexus 7700 Series switches has the following types of M3-Series modules:
  - 48-Port 1-/10-Gigabit Ethernet I/O module (N7K-M348XP-25L)
  - 24-Port 10-/40-Gigabit Ethernet (N7K-M324FQ-25L)
  - 12-port 100-Gigabit Ethernet I/O module (N77-M312CQ-26L)
- The 48 port 10G module has two sockets of 24 X 10G ASIC.
- The 24 port 40G module has four sockets of 6 X 40G ASIC.
- The 12 port 100G module has six sockets of 2 X 100G ASIC.
- The port group mappings are per ASIC.
- Interface allocation is done on the port group boundaries. The interfaces align ASIC resources to VDCs.
- The port group size varies depending on the module type.

### VDC Type Support

The following VDC type support is available in Cisco NX-OS Release 7.3(0)DX(1):

VDC Type	M3 support	M3 + F3 Support
Layer 2	Yes	Yes
Layer 3	Yes	Yes
Fabric Path	No	No
VxLAN	Yes	Yes
FEX	Yes	Yes
MPLS	Yes	Yes
OTV	Yes	Yes
LISP	Yes	Yes

VDC Type	M3 support	M3 + F3 Support
GTP	Yes	No
Layer 2 Gateways	Yes	No
Table Size	M3 Size	F3 Size

## Managing VDCs

### Changing the Nondefault VDC Prompt Format

You can change the format of the CLI prompt for nondefault VDCs. By default, the prompt format is a combination of the default VDC name and the nondefault VDC name. You can change the prompt to only contain the nondefault VDC name.

#### Before you begin

Log in to the default or admin VDC with a username that has the network-admin user role.

#### Procedure

	Command or Action	Purpose
<b>Step 1</b>	switch# <b>configure terminal</b>	Enters global configuration mode.
<b>Step 2</b>	switch(config)# <b>[no] vdc combined-hostname</b>	Changes the format of the CLI prompt for the nondefault VDC. To change the prompt to show only the nondefault VDC name, use the no format of the command. By default, the CLI prompt for a nondefault VDC consists of the default VDC name and the nondefault VDC name.
<b>Step 3</b>	(Optional) switch(config)# <b>copy running-config startup-config vdc-all</b>	Copies the running configuration for all the VDCs to the startup configuration. If you disable the combined hostname, this command prevents the VDC names from reverting back to their original format (with combined hostnames) after the running configuration is saved and the system is reloaded. Enter this command after turning off the combined hostname.

## Allocating Interfaces to an Ethernet VDC



**Note** See the *Cisco NX-OS FCoE Configuration Guide for Cisco Nexus 7000 and Cisco MDS 9500* for information on allocating interfaces to storage VDCs for Fibre Channel over Ethernet (FCoE).

You can allocate one or more interfaces to a VDC. When you allocate an interface, you move it from one VDC to another VDC. The interfaces are in the down state after you move them.



**Note** When you allocate an interface, all configuration on the interface is lost.



**Note** Beginning with Cisco NX-OS Release 5.2(1) for Nexus 7000 Series devices, all members of a port group are automatically allocated to the VDC when you allocate an interface.

### Before you begin

Log in to the default or admin VDC with a username that has the network-admin user role.

### Procedure

	Command or Action	Purpose
<b>Step 1</b>	switch# <b>configure terminal</b>	Enters global configuration mode.
<b>Step 2</b>	switch(config)# <b>vdc vdc-name</b>	Specifies a VDC and enters VDC configuration mode.
<b>Step 3</b>	(Optional) switch(config-vdc)# <b>show vdc membership [status]</b>	Displays the status of VDC interface membership
<b>Step 4</b>	switch(config-vdc)# [ <b>no</b> ] <b>allocate interface ethernet slot/port</b>	Allocates one interface to the VDC. Beginning with Cisco NX-OS Release 6.1(1), you can use the <b>no allocate interface ethernet</b> command to remove the interface from the VDC and place it in an unallocated pool.
<b>Step 5</b>	(Optional) switch(config-vdc)# [ <b>no</b> ] <b>allocate interface ethernet slot/port - last-port</b>	Allocates a range of interfaces on the same module to the VDC.
<b>Step 6</b>	(Optional) switch(config-vdc)# [ <b>no</b> ] <b>allocate interface ethernet slot/port, ethernet slot/port,</b>	Allocates a list of interfaces to the VDC.
<b>Step 7</b>	switch(config-vdc)# <b>exit</b>	Exits the VDC configuration mode.
<b>Step 8</b>	(Optional) switch(config-vdc)# <b>show vdc membership [status]</b>	Displays VDC interface membership information.

	Command or Action	Purpose
<b>Step 9</b>	(Optional) switch(config)# <b>copy running-config startup-config</b>	Saves the change persistently through reboots and restarts by copying the running configuration to the startup configuration.  <b>Note</b> After you add an interface to a VDC, you must copy the default or admin VDC running configuration to the startup configuration before users can copy the changed VDC running configuration to the startup configuration.

## Applying a VDC Resource Template

You can change the VDC resource limits by applying a new VDC resource template. Changes to the limits take effect immediately except for the IPv4 and IPv6 route memory limits, which take effect after the next VDC reset, physical device reload, or physical device stateful switchover.

### Procedure

	Command or Action	Purpose
<b>Step 1</b>	switch# <b>configure terminal</b>	Enters global configuration mode.
<b>Step 2</b>	switch# <b>show vdc resource detail</b>	Displays the resource information for all VDCs.
<b>Step 3</b>	switch(config)# <b>vdc vdc-name</b>	Specifies a VDC and enters VDC configuration mode.
<b>Step 4</b>	switch(config-vdc)# <b>template template-name</b>	Applies a new resource template for the VDC.
<b>Step 5</b>	switch(config-vdc)# <b>exit</b>	Exits VDC configuration mode.
<b>Step 6</b>	(Optional) switch(config)# <b>show vdc vdc-name resource</b>	Displays the resource information for a specific VDC.
<b>Step 7</b>	(Optional) switch(config)# <b>copy running-config startup-config</b>	Saves the change persistently through reboots and restarts by copying the running configuration to the startup configuration.

## Changing VDC Resource Limits

You can change the limits on the VDC resources. Changes to the limits take effect immediately except for the IPv4 and IPv6 routing table memory limits, which take effect after the next VDC reset, physical device reload, or physical device stateful switchover.



**Note** You can set only one value for the multicast and unicast route memory resources maximum and minimum limits. If you specify a minimum limit, that is the value for both the minimum and maximum limits and the maximum limit is ignored. If you specify only a maximum limit, that is the value for both the minimum and maximum limits.

Beginning with Cisco NX-OS Release 6.1, CPU shares are used to control the CPU resources among the VDCs by allowing you to prioritize VDC access to the CPU during CPU contention. CPU shares are supported on Supervisor 2/2e modules only. You can also configure the number of CPU shares on a VDC. For example, a VDC with 10 CPU shares gets twice the CPU time compared to a VDC that has 5 CPU shares.

Some features require that all modules in a chassis be of a certain type. Beginning with Cisco NX-OS Release 6.1(3), you can apply the switchwide VDC mode to prevent accidental insertion of a module or to restrict certain line cards from powering on in the system. For example, the result bundle hashing (RBH) modulo feature does not operate with M Series modules in the system. Use the system module-type command to apply the switchwide VDC mode. This command controls which line cards are allowed in the chassis (see the table below). Otherwise, widespread disruption is caused within a VDC.

The modules that you do not enable must not be powered on after you configure this feature and enter yes. An error message forces you to manually disable these modules before proceeding, which prevents major disruptions and service issues within a VDC.

Beginning with Cisco NX-OS Release 6.2(2), the F2e Series module can be enabled on the chassis, which now allows interoperability with the M Series modules. For a chassis with only F2e Series modules, the default VDC will be created using an F2e Series module as a supported module unless you apply your own configuration. F2 Series modules are only compatible with F2e Series modules on the chassis. The F2e and F2 Series modules cannot exist with the F1 Series module in the same VDCs. Currently, only F1, F2, and F2e Series modules are supported by storage VDCs. While Supervisor 1 supports only F1 Series modules in a storage VDC, Supervisor 2/2e supports all these types. The rules of mixing module types in a storage VDC is the same as in an ethernet VDC.



**Note** When using the system module-type command to apply the switchwide VDC mode, there are no restrictions on the module types that can be mixed

Modules	F1	F2	F3
F1 with Supervisor 1 only	Yes	No	No
F2 with Supervisor 2/2e	No	Yes	Yes
F2 / F2e with Supervisor 2/2e	No	Yes	Yes



**Note** For Cisco NX-OS Release 6.1 only, because F2e Series modules are supported as F2 Series modules, F2e Series modules follow the same mixing rules as F2 Series modules.



**Note** Storage VDCs in Cisco NX-OS Release 6.2(6) do not support F3 Series modules.

**Table 34: Restrictions and Conditions of Allowed Module Type Mix on Ethernet VDCs**

Module	M1	F1	M1XL	M2XL	F2	F2e	F3	M3
M1	Yes	Yes	Yes	Yes	No	Yes	No	No
F1	Yes	Yes	Yes	Yes	No	No	No	No
M1XL	Yes	Yes	Yes	Yes	No	Yes	No	No
M2XL	Yes	Yes	Yes	Yes	No	Yes	Yes	Yes
F2	No	No	No	No	Yes	Yes	Yes	No
F2e	Yes	No	Yes	Yes	Yes	Yes	Yes	No
F3	No	No	No	Yes	Yes	Yes	Yes	Yes
M3	No	No	No	Yes	No	No	Yes	Yes



**Note** • F3 F2E M2XL cannot coexist in the same VDC (although any two of them can coexist).

**Table 35: Module Type Support on a Default VDC**

Cisco NX-OS Release	All Line Cards Present in Chassis	Default Module Type Support for Default VDC (without user configuration)
5.1	M (any) and/or F1	M1 F1
6.0	F2 M* and/or F1 (and any other combination)	F2 M1 F1
6.1	F2 and/or F2e  <b>Note</b> During an upgrade from Cisco NX-OS Release 6.1x to 6.2(2), F2 Series module type is automatically upgraded to F2 F2e Series.	F2

Cisco NX-OS Release	All Line Cards Present in Chassis	Default Module Type Support for Default VDC (without user configuration)
6.2	F2 F2e F2 F2e F3 F2e F3 Other combinations <b>Note</b> Support for F3 Series modules was added in Cisco NX-OS Release 6.2(6).	F2 F2e F2e F2 F2e F3 F3 F2e M1 M1XL M2XL F2e
7.3(1)D1(1)	F2 F2e F2 F2e F3 F2e F3 M1 M2	F2 F2e F2 F2e F3 F2e F3 M1 M2
7.3(0)DX(1)	F2 F2e F2 F2e F3 F2e F3 M1 M2 M2 M3 M3 F3 M3 (Cisco Nexus 7700 Series switches only)	F2 F2e F2 F2e F3 F2e F3 M1 M2 M2 M3 M3 F3 M3 (Cisco Nexus 7700 Series switches only)



Cisco NX-OS Release	All Line Cards Present in Chassis	Default Module Type Support for Default VDC (without user configuration)
8.0 (1)	F2 F2e F2 F2e F3 F2e F3 M2 M2 M3 M3 F3 M3	F2 F2e F2 F2e F3 F2e F3 M2 M2 M3 M3 F3 M3

**Note**

- The Cisco Nexus 7710 switch and Cisco Nexus 7718 switch supports F2e and F3 Series module types in both an Ethernet VDC and Storage VDC. F3 Series modules do not support storage VDCs in Cisco NX-OS Release 6.2(6).
- Fabric-1 modules, F1 Series modules, M1 Series modules (non-XL mode), and Cisco Nexus 7000 Supervisor-1 modules are not supported in Cisco NX-OS Release 7.3(0)D1(1) and later releases.

## F2e Proxy Mode

To support the coexistence of an F2e Series module with an M Series module in the same VDC, the F2e Series module operates in a proxy mode so that all Layer 3 traffic is sent to an M Series module in the same VDC. For F2e proxy mode, having routing adjacencies connected through F2e interfaces with an M1 Series module is not supported. However, routing adjacencies connected through F2e interfaces with an M2 Series module is supported.

You cannot allocate F2e ports as shared interfaces in the storage VDC if the F2e port is in proxy mode in the Ethernet VDC.

When you enter the **limit-resource module-type** command and it changes the F2e mode between the old VDC type and the new VDC type, you are prompted to enter the **rebind interface** command, as shown below:

```
switch(config-vdc)# limit-resource module-type m1 m1x1 m2x1 f2e
This will cause all ports of unallowed types to be removed from this vdc. Continue (y/n)?
[yes]
Note: rebind interface is needed for proper system operation.
Please backup the running-configuration for interface by redirecting the output of "show
running-config interface".
Reapply the interface configuration after the "rebind interface" command
switch(config)# vdc vdc2
switch(config-vdc)# rebind interfaces
All interfaces' configurations of the current vdc will be lost during interface rebind.
Please back up the configurations of the current vdc. Do you want to proceed (y/n)? [no]
yes
switch(config-vdc)#
```



**Note** If an interface rebind is required, users are displayed with a yes/no prompt on Cisco NX-OS Release 6.2(8) and later, as opposed to entering the rebind interface command manually in earlier releases.

The table below shows the VDC type changes that require the rebind interface command:

**Table 36: VDC Types That Require Rebind Interface Command**

Old VDC Type	New VDC Type	Rebind Required	Description	Impact
F2,F2e	M,F2e	Yes	Changes F2e from Layer 3 to proxy mode.	You will lose the F2,F2e configuration during the rebinding of the interface. F2 configuration loss should not have much impact because F2 ports are not part of the new VDC.
M,F2e	F2,F2e	Yes	Changes F2e from proxy to Layer 3 mode.	You will lose the M,F2e configuration during the rebinding of the interface. M configuration loss should not have much impact because M ports are not part of the new VDC.
F2e	M,F2e	Yes	Changes F2e from Layer 3 to proxy mode.	You will lose only the F2e configuration.
M,F2e	F2e	Yes	Changes F2e from proxy to Layer 3 mode.	You will lose the M,F2e configuration during the rebinding of the interface. M configuration loss should not have much impact because M ports are not part of the new VDC.
F2,F2e	F2e	Yes	Enables F2e-only capabilities like SVI statistics.	You will lose the F2,F2e configuration during the rebinding of the interface. F2 configuration loss should not have much impact because F2 ports are not part of the new VDC.
F2e	F2e,F3	No	N/A	N/A
F2e	F2,F2e	Yes	Disables F2e-only capabilities like SVI statistics.	You will lose only the F2e configuration.
F3	F3,F2e	No	N/A	N/A

Old VDC Type	New VDC Type	Rebind Required	Description	Impact
F3,F2e	F3	No	N/A	N/A
F3	F3,M2XL	No	N/A	N/A
F3,M2XL	F3	No	N/A	N/A
F3,F2,F2e	F3	Yes	Changes LCD to F3.	You will lose the F3 configuration.
F3	F3,F2,F2e	Yes	Changes F3 to LCD.	You will lose the F3 configuration.
F3,F2	F3	Yes	Changes LCD to F3.	You will lose the F3 configuration.
F3	F3,F2	Yes	Changes F3 to LCD.	You will lose the F3 configuration.
M3	M3, F3	Yes	N/A	N/A
M3, F3	M3	Yes	N/A	N/A
M3	M3, M2	Yes	N/A	N/A
M3, M2	M3	Yes	N/A	N/A



**Note** M1 and F3 modules cannot co-exist. When an existing module (for example, M1) is replaced with a new module (for example, F3) rebind is not required. Rebind is required only when a VDC module type is changed along with the existing module types.

## M2-M3 VDC and Interoperability mode

In Cisco Nexus 7000 Series Switches, the M2 line module packet supports both M2-F2E and M2-M3 interop header formats. By default, the M2 module operates in the M2-F2E mode. M3 line module supports M2-M3 interop header only. M2 and F3/F2E modules supports both modes of operation.

If M2 and M3 modules operates in the same VDC, M2 module must be changed to M2-M3 interop mode. When M2 module works with M2 or F2E module in proxy mode, M2 module must be in M2-F2E mode.

M2 LC must be in M2-M3 mode, if its ports must work in/be allocated to a M2-M3 VDC.



**Note** This is applicable even if M3 ports exists or not.

M2 LC must be in M2-F2E mode(default mode), to operate in other VDC.

To change the M2 module mode,

- To change M2 module to M2-M3 interop mode, use the **system interop-mode m2-m3 module** command.

Enter **Y** when prompted to reload the module.

- To change M2 module to M2-F2E mode, you must unallocate any M2 interfaces from the M2-M3 VDC.

Use the **no system interop-mode m2-m3 module** command.

Enter **Y** when prompted to reload the module.



**Note** Ensure that all the interfaces from the same M2 module working with the M3 module must be in the same VDC.



**Note** You can insert a maximum of ten 24-port 40-Gigabit Ethernet QSFP+ (N7K-M324FQ-25L) I/O modules in the Cisco Nexus 7018 switch. This I/O module uses 96 VQI per slot. The maximum VQI of a Cisco Nexus 7018 switch is 1024 and a total of eleven 24-port 40-Gigabit Ethernet QSFP+ I/O modules will require 1056 VQI. In such a scenario, the eleventh I/O module will attempt to come online 3 times and then will get powered down. During reload of a switch with eleven 24-port 40-Gigabit Ethernet QSFP+ I/O modules, the I/O module that comes up last will be powered down.

## Configuring VDC Resource Limits

### Procedure

	Command or Action	Purpose
<b>Step 1</b>	switch# <b>configure terminal</b>	Enters global configuration mode.
<b>Step 2</b>	(Optional) switch(config)# [ <b>no</b> ] <b>system module-type</b> <i>module-type</i>	<p>Enters switchwide VDC mode and specifies which modules can be enabled on a chassis. You can enable a mix of F1, F2, F2e, M1, M1XL, and M2 Series modules. There are no restrictions on the type of mix allowed for the <b>system module-type</b> command.</p> <p><b>Note</b> Restrictions on the module types that can be mixed in a VDC are controlled by the <b>limit-resource module-type</b> command.</p> <p><b>Note</b> The modules that you do not enable must not be powered on after you configure this feature and enter yes. An error message forces you to manually disable these modules before proceeding, which prevents major disruptions and service issues within a VDC.</p>

	Command or Action	Purpose
		The <b>no</b> form of this command resets the configuration mode to allow all modules.
<b>Step 3</b>	(Optional) switch(config)# <b>show vdc</b>	Displays which modules are enabled in the chassis.
<b>Step 4</b>	(Optional) switch(config)# <b>show vdc resource detail</b>	Displays the resource information for all VDCs.
<b>Step 5</b>	switch(config)# <b>vdc vdc-name</b>	Specifies a VDC and enters VDC configuration mode.
<b>Step 6</b>	switch(config-vdc)# <b>limit-resource m4route-mem [minimum min-value] maximum max-value</b>	Specifies the limits for IPv4 multicast route memory in megabytes. The range is from 1 to 90.
<b>Step 7</b>	switch(config-vdc)# <b>limit-resource m6route-mem [minimum min-value] maximum max-value</b>	Specifies the limits for IPv6 multicast route memory in megabytes. The range is from 1 to 20.
<b>Step 8</b>	switch(config-vdc)# <b>limit-resource monitor-session minimum min-value maximum {max-value   equal-to-min}</b>	Configures the SPAN monitor session resource limits. The range is from 0 to 2. The equal-to-min keyword automatically sets the maximum limit equal to the minimum limit.  <b>Note</b> You can have a maximum of two SPAN monitoring sessions on your physical device.
<b>Step 9</b>	switch(config-vdc)# <b>limit-resource monitor-session-erspan-dst minimum min-value maximum {max-value   equal-to-min}</b>	Configures the ERSPAN monitor session resource limits. The range is from 0 to 23. The equal-to-min keyword automatically sets the maximum limit equal to the minimum limit.
<b>Step 10</b>	switch(config-vdc)# <b>limit-resource port-channel minimum min-value maximum {max-value   equal-to-min}</b>	Specifies the limits for port channels. The default minimum value is 0. The default maximum value is 768. The range is from 0 to 768. The <b>equal-to-min</b> keyword automatically sets the maximum limit equal to the minimum limit.
<b>Step 11</b>	switch(config-vdc)# <b>limit-resource u4route-mem [minimum min-value] maximum max-value</b>	Specifies the minimum and maximum limits for IPv4 unicast route memory in megabytes. The range is from 1 to 350.
<b>Step 12</b>	switch(config-vdc)# <b>limit-resource u6route-mem [minimum min-value] maximum max-value</b>	Specifies the minimum and maximum limits for IPv6 unicast route memory in megabytes. The range is from 1 to 100.
<b>Step 13</b>	switch(config-vdc)# <b>limit-resource vlan minimum min-value maximum {max-value   equal-to-min}</b>	Configures the VLAN resource limits. The range is from 16 to 4094. The <b>equal-to-min</b>

	Command or Action	Purpose
		keyword automatically sets the maximum limit equal to the minimum limit.
<b>Step 14</b>	switch(config-vdc)# <b>limit-resource vrf minimum</b> <i>min-value</i> <b>maximum</b> { <i>max-value</i>   <b>equal-to-min</b> }	Specifies the limits for VRF. The range is from 2 to 1000. The <b>equal-to-min</b> keyword automatically sets the maximum limit equal to the minimum limit.
<b>Step 15</b>	switch(config-vdc)# <b>limit-resource module-type</b> <i>module type</i>	<p>Configures the specified line card type. VDCs support the F1, F2, F2e, M1, M1XL, and M2XL Series module types.</p> <p><b>Note</b> F2e Series modules cannot exist in the same VDC with F1 Series modules. The <b>limit-resource module-type</b> command allows a mix of F1, M1, M1XL, and M2XL Series modules or a mix of F2e, M1, M1XL, and M2XL Series modules in the same VDC.</p> <p><b>Note</b> F2 Series modules cannot exist in the same VDC with F1, M1, M1XL, and M2XL Series modules. Use the <b>limit-resource module-type f2</b> command to allow only F2 Series modules into a VDC. Use the <b>limit-resource module-type f2 f2e</b> command to enable an F2e Series module in an F2 VDC. The ports from F2 and F2e Series modules can be allocated like any other ports.</p>
<b>Step 16</b>	switch(config-vdc)# <b>cpu-shares</b> <i>shares</i>	Sets the number of CPU shares on a VDC. The range is from 1 to 10. For example, a VDC with 10 CPU shares gets twice the CPU time compared to a VDC that has 5 CPU shares.
<b>Step 17</b>	(Optional) switch(config-vdc)# <b>show vdc detail</b>	Displays the VDC status information.
<b>Step 18</b>	switch(config-vdc)# <b>exit</b>	Exits VDC template configuration mode.
<b>Step 19</b>	(Optional) switch(config)# <b>show vdc vdc-name resource</b>	Displays VDC template configuration information.
<b>Step 20</b>	(Optional) switch(config)# <b>copy running-config startup-config</b>	Saves the change persistently through reboots and restarts by copying the running configuration to the startup configuration.

## Displaying show vdc detail Output

This example displays the output of show vdc detail command:

```
switch# show vdc detail

vdc id: 1
vdc name: switch
vdc state: active
vdc mac address: 00:26:51:cb:bf:41
vdc ha policy: RELOAD
vdc dual-sup ha policy: SWITCHOVER
vdc boot Order: 1
CPU Share: 5
CPU Share Percentage: 22%
vdc create time: Wed Jul 18 18:08:15 2012
vdc reload count: 0
vdc restart count: 0
vdc type: Admin
vdc supported linecards: None

vdc id: 2
vdc name: vdc2
vdc state: active
vdc mac address: 00:26:51:cb:bf:42
vdc ha policy: RESTART
vdc dual-sup ha policy: SWITCHOVER
vdc boot Order: 1
CPU Share: 10
CPU Share Percentage: 45%
vdc create time: Wed Jul 18 18:17:14 2012
vdc reload count: 0
vdc restart count: 0
vdc type: Ethernet
vdc supported linecards: m1 f1 m1x1 m2x1

vdc id: 3
vdc name: new-vdc
vdc state: active
vdc mac address: 00:26:51:cb:bf:43
vdc ha policy: RESTART
vdc dual-sup ha policy: SWITCHOVER
vdc boot Order: 1
CPU Share: 7
CPU Share Percentage: 31%
vdc create time: Wed Jul 18 18:29:51 2012
vdc reload count: 0
vdc restart count: 0
vdc type: Ethernet
vdc supported linecards: m1 f1 m1x1 m2x1
switch#
```

## Changing the HA Policies

You can change the HA policies for a VDC. The VDC HA policies are as follows:

- Dual supervisor modules:
  - Bringdown—Puts the VDC in the failed state.

- Restart—Restarts the VDC. This process includes shutting down all the interfaces within that VDC and stopping all the virtualized services processes. The Cisco NX-OS software restarts all the virtualized services saved in the startup configuration and brings the interfaces back up with the configuration saved in the startup configuration. Any configuration that you did not save in the startup configuration prior to the restart is lost.
- Switchover—Initiates a supervisor module switchover.
- Single supervisor modules:
  - Bringdown—Puts the VDC in the failed state.
  - Reload—Reloads the supervisor module.



---

**Caution** With the reload action, any configuration that you did not save in the startup configuration prior to the reload is lost.

---



---

**Note** The reload action affects all interfaces and all VDCs on the physical device.

---

- Restart—Restarts the VDC. This process includes shutting down all the interfaces within that VDC and stopping all the virtualized services processes. The Cisco NX-OS software restarts all the virtualized services saved in the startup configuration and brings the interfaces back up with the configuration saved in the startup configuration. Any configuration that you did not save in the startup configuration prior to the restart is lost.



---

**Caution** With the reload action, any configuration that you did not save in the startup configuration prior to the reload is lost.

---



---

**Note** You cannot change the HA policies for the default or admin VDC.

---

### Before you begin

Log in to the default or admin VDC with a username that has the network-admin user role.

### Procedure

	Command or Action	Purpose
<b>Step 1</b>	switch# <b>configure terminal</b>	Enters global configuration mode.
<b>Step 2</b>	switch(config)# <b>vdc vdc-name</b>	Specifies a VDC and enters VDC configuration mode.



	Command or Action	Purpose
<b>Step 3</b>	switch(config-vdc)# <b>ha-policy</b> { <b>dual-sup</b> { <b>bringdown</b>   <b>restart</b>   <b>switchover</b> }   <b>single-sup</b> { <b>bringdown</b>   <b>reload</b>   <b>restart</b> }}	Configures the HA policy for the VDC. The <b>dual-sup</b> and <b>single-sup</b> keyword values are as follows: <ul style="list-style-type: none"> <li>• <b>bringdown</b>—Puts the VDC in the failed state.</li> <li>• <b>reload</b>—Initiates a supervisor module switchover for physical devices with two supervisor modules, or reloads physical devices with one supervisor module.</li> <li>• <b>restart</b>—Takes down the VDC processes and interfaces and restarts it using the startup configuration.</li> <li>• <b>switchover</b>—Initiates a supervisor module switchover.</li> </ul> <p><b>Note</b> You cannot change the HA policies for the default or admin VDC.</p>
<b>Step 4</b>	switch(config-vdc)# <b>exit</b>	Exits VDC configuration mode.
<b>Step 5</b>	(Optional) switch(config)# <b>show vdc detail</b>	Displays VDC status information.
<b>Step 6</b>	(Optional) switch(config)# <b>copy running-config startup-config</b>	Saves the change persistently through reboots and restarts by copying the running configuration to the startup configuration.

## Saving VDC Configurations

You can save the configuration of all the VDCs on the physical device to the startup configuration.

### Before you begin

Log in to the default or admin VDC with a username that has the network-admin user role.

### Procedure

	Command or Action	Purpose
<b>Step 1</b>	switch# <b>switchto vdc</b> <i>vdc-name</i>	Switches to the nondefault VDC.
<b>Step 2</b>	(Optional) switch-TestVDC# <b>copy running-config startup-config</b>	Copies the running configuration for the VDC to the startup configuration.
<b>Step 3</b>	switch-TestVDC# <b>switchback</b>	Switches back to the default or admin VDC.
<b>Step 4</b>	(Optional) switch# <b>copy running-config startup-config vdc-all</b>	Copies the running configuration for all the VDCs to the startup configuration.

## Suspending a Nondefault VDC

You can suspend an active nondefault VDC. You must save the VDC running configuration to the startup configuration before suspending the VDC. Otherwise, you will lose the changes to the running configuration.



**Note** You cannot suspend the default and admin VDC.



**Caution** Suspending a VDC disrupts all traffic on the VDC.

### Before you begin

Log in to the default or admin VDC with a username that has the network-admin user role.

### Procedure

	Command or Action	Purpose
<b>Step 1</b>	(Optional) <code>switch# copy running-config startup-config vdc-all</code>	Copies the running configuration for all the VDCs to the startup configuration.
<b>Step 2</b>	<code>switch# configure terminal</code>	Enters global configuration mode.
<b>Step 3</b>	<code>switch(config)# vdc vdc-name suspend</code>	Suspends a nondefault VDC.

## Resuming a Nondefault VDC

You can resume a nondefault VDC from the suspended state. The VDC resumes with the configuration saved in the startup configuration.

### Before you begin

Log in to the default or admin VDC with a username that has the network-admin user role.

### Procedure

	Command or Action	Purpose
<b>Step 1</b>	<code>switch# configure terminal</code>	Enters global configuration mode.
<b>Step 2</b>	<code>switch(config)# no vdc vdc-name suspend</code>	Resumes a suspended nondefault VDC.

## Reloading a Nondefault VDC

You can reload a nondefault VDC that is in a failed state. The VDC reloads using the startup configuration.



**Note** Use the **reload** command to reload the default or admin VDC. Reloading the default or admin VDC reloads all VDCs on the Cisco NX-OS device.



**Caution** Reloading a VDC disrupts all traffic on the VDC.

### Before you begin

Log in to the nondefault VDC with a username that has the vdc-admin user role or use the **switchto vdc** command from the default or admin VDC to access the nondefault VDC.

### Procedure

	Command or Action	Purpose
<b>Step 1</b>	(Optional) switch# <b>copy running-config startup-config vdc-all</b>	Copies the running configuration for the nondefault VDC to the startup configuration.
<b>Step 2</b>	switch-TestVDC# <b>reload vdc</b>	Reloads a nondefault VDC.

## Configuring the VDC Boot Order

You can configure the boot order for the VDCs on your Cisco NX-OS device.



**Note** You cannot change the boot order of the default or admin VDC.

### Before you begin

Log in to the default or admin VDC with a username that has the network-admin user role.

### Procedure

	Command or Action	Purpose
<b>Step 1</b>	switch# <b>configure terminal</b>	Enters global configuration mode.
<b>Step 2</b>	switch(config)# <b>vdc vdc-name</b>	Specifies a VDC and enters VDC configuration mode.
<b>Step 3</b>	switch(config-vdc)# <b>boot-order number</b>	Configures the boot order value for the VDC. The range for the number argument is from 1 to 4 on a Supervisor 2 module and from 1 to 8 on a Supervisor 2e module. The VDC starts from the lowest to the highest boot order value.

	Command or Action	Purpose
		You cannot change the boot order for the default VDC.
<b>Step 4</b>	switch(config-vdc)# <b>exit</b>	Exits VDC configuration mode.
<b>Step 5</b>	(Optional) switch(config)# <b>show vdc detail</b>	Displays VDC status information.
<b>Step 6</b>	(Optional) switch(config)# <b>copy running-config startup-config vdc-all</b>	Copies the running configuration for all the VDCs to the startup configuration.

## Deleting a VDC

When you delete a VDC, the ports on the VDC are moved to unallocated interfaces.



### Note

You cannot delete the default VDC (VDC 1) and the admin VDC.



### Caution

Deleting a VDC disrupts all traffic on the VDC.

### Before you begin

Log in to the default or admin VDC with a username that has the network-admin user role.

### Procedure

	Command or Action	Purpose
<b>Step 1</b>	switch# <b>configure terminal</b>	Enters global configuration mode.
<b>Step 2</b>	switch(config)# <b>no vdc vdc-name</b>	Removes the VDC.  <b>Caution</b> Deleting a VDC disrupts all traffic on the VDC and removes all configuration on all the interfaces allocated to the VDC.
<b>Step 3</b>	switch(config)# <b>exit</b>	Exits VDC configuration mode.
<b>Step 4</b>	(Optional) switch# <b>show vdc</b>	Displays VDC configuration information.
<b>Step 5</b>	(Optional) switch# <b>copy running-config startup-config</b>	Copies the running configuration to the startup configuration.

## Verifying the VDC Configuration

To display the VDC configuration, perform one of the following tasks:

Command	Purpose
<code>show running-config {vdc   vdc-all}</code>	Displays the VDC information in the running configuration.
<code>show vdc [vdc-name]</code>	Displays the VDC configuration information.
<code>show vdc detail</code>	Displays the detailed information about many VDC parameters.
<code>show vdc current-vdc</code>	Displays the current VDC number.
<code>show vdc membership [status]</code>	Displays the VDC interface membership information.
<code>show vdc resource template</code>	Displays the VDC template configuration.
<code>show resource</code>	Displays the VDC resource configuration for the current VDC.
<code>show vdc [vdc-name] resource [resource-name]</code>	Displays the VDC resource configuration for all VDCs.
<code>show mac vdc {vdc-id}</code>	Displays the MAC address for a specific VDC.

For detailed information about the fields in the output from these commands, see the *Cisco Nexus 7000 Series NX-OS Virtual Device Context Command Reference*.

## Configuration Examples for VDC Management

This example shows how to allocate interfaces between VDCs for port groups on a Cisco Nexus 7000 Series 32-port, 10-Gbps Ethernet module:



**Note** VDC-A is the default VDC.

```

config t
hostname VDC-A
vdc VDC-B
! Port group 2
allocate interfaces ethernet 2/2, ethernet 2/4, ethernet 2/6, ethernet 2/8
! Port group 3
allocate interfaces ethernet 2/9, ethernet 2/11, ethernet 2/13, ethernet 2/15
vdc VDC-C
! Port group 4
allocate interfaces ethernet 2/10, ethernet 2/12, ethernet 2/14, ethernet 2/16
! Port group 5
allocate interfaces ethernet 2/17, ethernet 2/19, ethernet 2/21, ethernet 2/23
vdc VDC-D

```

```

! Port group 6
allocate interfaces ethernet 2/18, ethernet 2/20, ethernet 2/22, ethernet 2/24
! Port group 7
allocate interfaces ethernet 2/25, ethernet 2/27, ethernet 2/29, ethernet 2/30

```

## Related Documents for Managing VDCs

Related Topic	Document Title
Cisco NX-OS licensing	<i>Cisco Nexus 7000 Series NX-OS Unicast Routing Command Reference</i>
Cisco Nexus 7000 Series Hardware Installation and Reference Guide	<i>Cisco Nexus 7000 Series Hardware Installation and Reference Guide</i>
VDC commands	<i>Cisco Nexus 7000 Series NX-OS Virtual Device Context Command Reference</i>
FCoE commands	<i>Cisco NX-OS FCoE Command Reference for Cisco Nexus 7000 and Cisco MDS 9500</i>

## Feature History for Managing VDCs

This table includes only the updates for those releases that have resulted in additions or changes to the feature.

**Table 37: Feature History for Managing VDCs**

Feature Name	Release	Feature Information
M3 Series Module	8.0(1)	Added guidelines and limitations for support of M3 Series modules on Cisco Nexus 7000 Series switches.
M3 Series Module	7.3(0)DX(1)	Added guidelines and limitations for support of M3 Series modules on Cisco Nexus 7700 Series switches.
F3 Series module	6.2(6)	Added support for the F3 Series module.
Cisco Nexus 7710 switch and Cisco Nexus 7718 switch	6.2(2)	Added support for the Cisco Nexus 7710 switch and the Cisco Nexus 7718 switch on the Supervisor 2e module.
Admin VDC on Supervisor 1 module	6.2(2)	Added support for admin VDCs on the Supervisor 1 module.
F2e Series module	6.2(2)	Added the ability to enable the F2e Series module (a new configurable VDC module type, independent from and separate to the F2 VDC module type) on the chassis.

Feature Name	Release	Feature Information
F2e proxy mode	6.2(2)	Introduced this feature to support the coexistence of an F2e Series module with an M Series module in the same VDC.
Switchwide VDC mode	6.1(3)	Added the ability to enable specific line cards in the chassis and prevent others from powering on.
Support for F2e Series modules	6.1(2)	Added support for F2e Series modules as part of the F2 Series modules.
Support for Supervisor 2 and M2 Series modules.	6.1(1)	Added support for Supervisor 2 and M2 Series modules.
CPU shares	6.1(1)	Added support for CPU shares on a VDC.
VDC resource limits	6.0(1)	Added support for F2 Series modules.
MAC addresses	5.2(1)	The default VDC has a MAC address, and subsequent nondefault VDCs that are created are assigned MAC addresses.
VDC resource limits	5.2(1)	Added support for M1XL Series modules.
N7K-F132XP-15 module	5.1(1)	Added support for the N7K-F132XP-15 module.
VDC resource limits	5.1(1)	Added the ability to configure ERSPAN monitor session resource limits.
VDC resource limits	5.0(2)	The range for the minimum and maximum values changed for the <b>limit-resource m4route-mem</b> , <b>limit-resource m6route-mem</b> , <b>limit-resource u4route-mem</b> , <b>limit-resource u6route-mem</b> , and <b>limit-resource vrf</b> commands.
Restarting VDCs	4.2(4)	The vdc restart command was replaced by the <b>reload vdc</b> command.
Suspending and resuming VDCs	4.2(1)	You can suspend and resume nondefault VDCs.
Restarting VDCs	4.2(1)	You can restart active nondefault VDCs and nondefault VDCs in the failed state.
Reloading VDCs	4.2(1)	You can reload nondefault VDCs.
VDC prompt format	4.2(1)	You can change the format of the CLI prompt for nondefault VDCs.
VDC boot order	4.2(1)	You can configure the boot order for nondefault VDCs.

<b>Feature Name</b>	<b>Release</b>	<b>Feature Information</b>
IPv4 unicast route memory resource	4.1(2)	Changed the default maximum value from 256 to 8.
IPv6 unicast route memory resource	4.1(2)	Changed the default maximum value from 256 to 4.
Multicast route memory resources	4.1(2)	Added IPv4 and IPv6 multicast route memory resources.
Port channel resources	4.1(2)	Changed the default maximum value from 256 to 768.
IPv4 unicast route memory resource	4.0(2)	Changed the default maximum value from 256 to 320.
IPv6 unicast route memory resource	4.0(2)	Changed the default maximum value from 256 to 192.





## APPENDIX **A**

# VDC Configuration Limits

---

The configuration limits are documented in the *Cisco Nexus 7000 Series NX-OS Verified Scalability Guide*.

