

IMPORTANT SAFETY INSTRUCTIONS, continued

Obtaining Service for Product Damage

For damage that requires service, unplug this product from the AC outlet. Then, contact your cable service provider or qualified service personnel to obtain service for the following conditions:

- If there is damage to the power-supply cord or plug
- If liquid enters this product
- If you expose this product to rain or water
- If you drop this product, a heavy object falls on this product, or damage occurs to the cover of this product
- If this product does not operate normally by following the operating instructions
- If this product exhibits a distinct change in performance

Checking Product Safety

Upon completion of any service or repairs to this product, the service technician must perform safety checks to determine that this product is in proper operating condition.

Outdoor Grounding System

If this product connects to an outdoor antenna or cable system, be sure the antenna or cable system is grounded (earthed). This provides some protection against voltage surges and built-up static charges.

Article 810 of the National Electric Code (NEC) ANSI/NFPA No. 70-1990, provides the following information:

- Grounding of the mast and supporting structure
- Grounding the lead-in wire to an antenna discharge unit
- Size of the grounding conductors
- Location of the antenna-discharge unit
- Connection to grounding electrodes
- Requirements for the grounding electrodes (see the following antenna grounding diagram as recommended by NEC ANSI/NFPA 70)

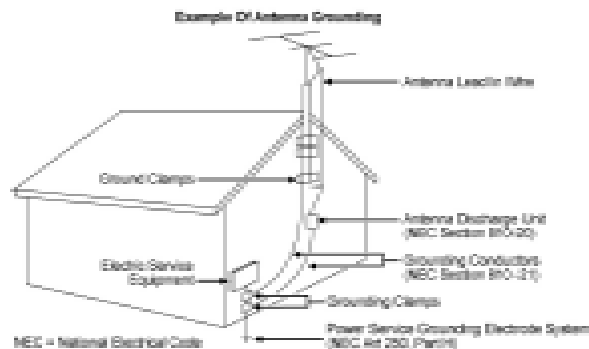

Lightning

For added protection for this product during a lightning storm, or when it is left unattended and unused for long periods of time, unplug it from the wall outlet and disconnect the antenna or cable system. This will prevent damage to the product due to lightning and power-line surges. Plugging this product into a surge protector may reduce the risk of damage.

Note: Unplugging this product for an extended period of time can result in loss of authorization. For reauthorization, contact your cable service provider.

Power Lines



WARNING: To avoid electric shock, do not locate an outside antenna system in the vicinity of overhead power lines or power circuits.

Do not locate an outside antenna system in the vicinity of overhead power lines or power circuits. When installing an outside antenna system, take extreme care to keep from touching power lines or circuits, as contact might be fatal.

20050719STBD

United States FCC Compliance

Note: This device has been tested and found to comply with the limits for a Class B digital device, pursuant to part 15 of the FCC Rules. These limits are designed to provide reasonable protection against such interference in a residential installation. This equipment generates, uses, and can radiate radio frequency energy. If not installed and used in accordance with the instructions, it may cause harmful interference to radio communications. However, there is no guarantee that interference will not occur in a particular installation. If this equipment does cause harmful interference to radio or television reception, which can be determined by turning the equipment OFF and ON, the user is encouraged to try to correct the interference by one or more of the following measures:

- Reorient or relocate the receiving antenna.
- Increase the separation between the equipment and receiver.
- Connect the equipment into an outlet on a circuit different from that to which the receiver is connected.
- Consult the cable company or an experienced radio/television technician for help.

Any changes or modifications not expressly approved by Scientific-Atlanta could void the user's authority to operate the equipment.

The information shown in the FCC Declaration of Conformity paragraph below is a requirement of the FCC and is intended to supply you with information regarding the FCC approval of this device. *The phone number listed is for FCC-related questions only and not intended for questions regarding the connection or operation for this device. Please contact your cable service provider for any questions you may have regarding the operation or installation of this device.*

FCC Declaration of Conformity

This device complies with Part 15 of FCC Rules. Operation is subject to the following two conditions: 1) the device may not cause harmful interference, and 2) the device must accept any interference received, including interference that may cause undesired operation.

Explorer 1850 Digital-Only Set-Top
Model: Explorer 1850
Scientific-Atlanta, Inc., 5030 Sugarloaf Parkway
Lawrenceville, Georgia 30044 USA
Telephone: 770-236-1077

Software and Firmware Use

Scientific-Atlanta, Inc. owns copyrights to the software described in this document and furnishes the software to you under a license agreement. You may only use or copy this software in accordance with the terms of your license agreement.

Scientific-Atlanta, Inc. owns copyrights to the firmware in this equipment. You may only use the firmware in the equipment in which it is provided. Any reproduction or distribution of this firmware, or any portion of it, without the express written consent of Scientific-Atlanta, Inc. is prohibited.

© 2005 by Scientific-Atlanta, Inc. All rights reserved.
Product and service availability subject to change without notice.

Scientific-Atlanta, Inc., 5030 Sugarloaf Parkway,
P.O. Box 465447, Lawrenceville, GA 30042

www.scientificatlanta.com

October 2005 Printed in the United States of America
4012606 Rev A



Explorer® 1850™ Digital-Only Set-Top Quick Reference

Safety First

Before using this set-top, read the **Important Safety Instructions** section of this quick reference. Follow the instructions to install this set-top, to become familiar with the buttons on the front panel, and to access your cable services. Then, enjoy the features of this set-top!

Explorer eClub

(www.scientificatlanta.com/explorerclub)

Access the online Explorer eClub for more information about this set-top and see additional connection diagrams. On the Explorer eClub site you can also get "how to" tips on using this set-top, such as setting up your favorite channels, blocking programs that are inappropriate for

children, and using the remote control to turn on more than one of your electronic devices. There is also a section with answers to frequently asked questions. To join and access the online Explorer eClub, enter the model number shown on the front panel of this set-top.

Set-Top Serial Number

If this set-top requires troubleshooting in the future, your cable service provider may ask for the serial number. The serial number is on the back panel; it begins with "SA" and is located in the lower left corner of the bar code. Use the space provided here to record the serial number.

1850 Front Panel

- | | |
|-----------------------|---|
| 1 Power | Turns the set-top on and off |
| 2 VOL +, VOL - | Increases and decreases the volume |
| 3 CH +, CH - | Scrolls up and down through the channels |
| 4 Select | Provides access to your on-screen selection |
| 5 LED Display | Displays the selected channel number and time of day. The LED also displays the following: <ul style="list-style-type: none"> • Message () • Power () |
| 6 Guide | Accesses on-screen services, such as the on-screen guide, video-on-demand, or pay-per-view |
| 7 Info | Displays a description of the selected program. This button is available from the on-screen guide and while viewing a program |
| 8 Exit | Exits menus, on-screen guide, and program information |
| 9 Settings | Accesses the Settings menu |
| 10 Smart Card | Allows smart card access (This feature may not be available on all models.) |
| 11 USB | Connects to external equipment, such as a keyboard (This feature may not be available on all models.) |

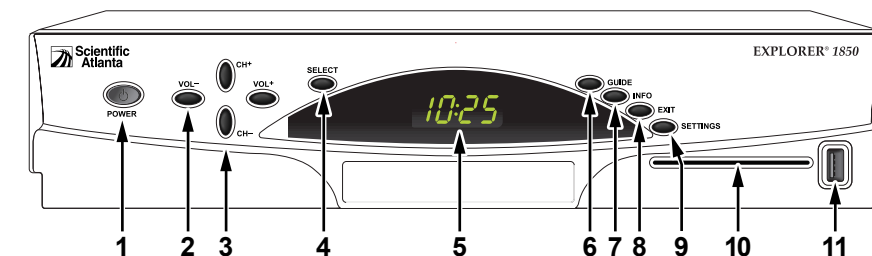

T11492

Safety and Performance Tips

- Keep the top of the set-top free of all objects and electronic devices, including your TV.
- Always stand the set-top on its feet, never on its side.

Canada EMI Regulation

This Class B digital apparatus complies with Canadian ICES-003.
Cet appareil numérique de la class B est conforme à la norme NMB-003 du Canada.

Trademarks

Scientific-Atlanta, the Scientific-Atlanta logo, and Explorer are registered trademarks of Scientific-Atlanta, Inc. 1850 is a trademark of Scientific-Atlanta, Inc.

Disclaimer

Scientific-Atlanta, Inc. assumes no responsibility for errors or omissions that may appear in this guide. Scientific-Atlanta reserves the right to change this guide at any time without notice.

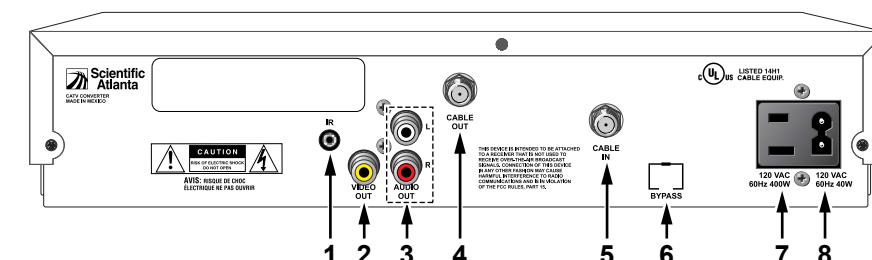

T11493

- | | |
|--------------------------|--|
| 1 IR | This connector is reserved for future use |
| 2 VIDEO OUT | Connects to the video input of your TV or VCR |
| 3 AUDIO OUT (L/R) | Connects RCA cables to Audio Out to send audio signals (left and right) to a stereo receiver or TV with stereo outputs. |
| 4 CABLE OUT | Connects to a coaxial cable to send audio and video signals to a TV or VCR. These signals are SDTV video and monaural audio. |
| 5 CABLE IN | Connects the coaxial cable that delivers the signal from your cable service provider |
| 6 BYPASS | Contact your cable service provider for more information |
| 7 AC Outlet | Connects the AC power cord from another device, such as a TV |
| 8 AC Power Input | Connects the power cord to deliver power to the set-top |

Connect the Set-Top to a Stereo TV and Stereo VCR

 **WARNING: Electric shock hazard! Unplug all electronic devices before connecting or disconnecting any device cables to the set-top.**

Connect the set-top to the TV and VCR as shown in the diagram.

1. Connect the set-top to the coaxial cable coming from the wall.
2. Plug the set-top and the TV into an AC power source.

Important: To protect the set-top from power surge damage, ground (earth) your cable product to provide some protection against voltage surges and built-up static charges. To avoid these voltage surges that can be caused by lightning storms and power outages, plug the set-top into a surge protector to reduce the risk of damage.

3. Do *not* turn on the set-top yet. It may take several minutes for the set-top to receive the latest software, programming, and service information. When the Power light on the front panel stops flashing, that is your indication that the programming update is complete.
4. To begin watching TV, turn the TV ON and press the POWER button on the front of the set-top, or press POWER on the remote control.

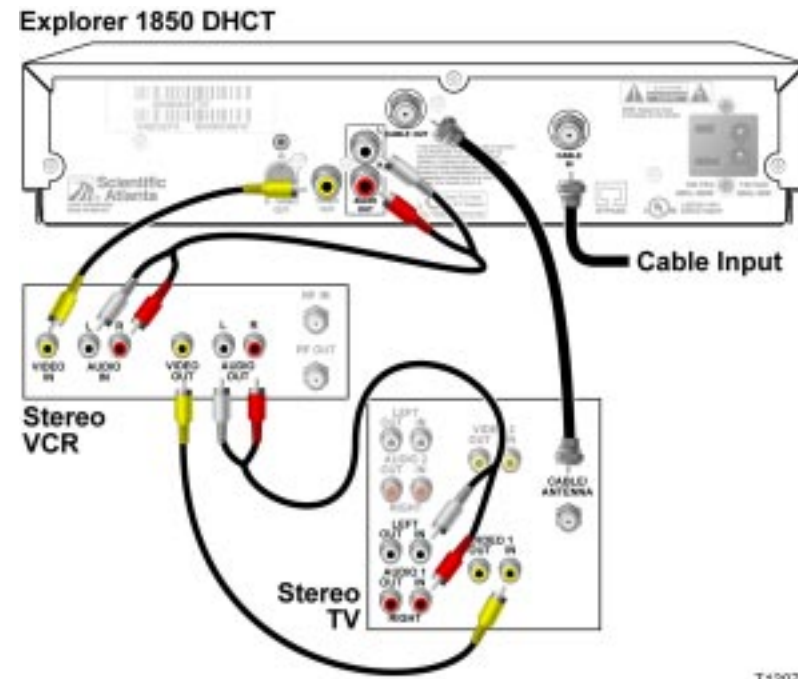

Access Cable Services and Programs

Through this set-top you can access interactive services, such as video-on-demand and pay-per-view programs. Contact your cable service provider for information about these and other available services.

Access cable services and programs by pressing the following keys on the remote control:

- **Guide**—Access the on-screen guide for schedules of TV programs and other services available from your cable service provider, such as video-on-demand and pay-per-view programs.
- **Arrows**—Highlight a program in the schedule.
- **INFO**—Display a specific program description (either from the on-screen guide or while viewing a program).
- **SELECT**—View a specific program in the guide.

Avoid Screen Burn-In!

Images such as letterbox bars or side bars, bright closed-captioning backgrounds, station logos, or any other stationary images may cause the HDTV screen to age unevenly and cause damage to your HDTV. Refer to the user's guide that came with your HDTV for more information about screen burn-in.

Performance Tips

If this set-top does not perform as expected, the following tips may help.

No picture

- Verify that the power to your TV is turned on.
- If the set-top is plugged into a wall switch, verify the switch is in the ON position. (Avoid plugging into a switched outlet.)
- Verify that all cables are properly connected.
- The current channel may not be available in your service package. Try selecting another channel to see if video is available.

No color

- Verify the current TV program is broadcast in color.
- Adjust the TV color controls.

No sound

- If your setup includes a VCR or stereo, verify that you have properly connected them to the set-top.
- Verify the volume is turned up.
- Verify the mute function is not on.

Automatic Software Updates

The TV screen displays a message that indicates the set-top is automatically updating its software.

Wait for the current time to display on the front panel of the set-top before continuing. When the front panel displays the time, the update is complete.

Note: If you need further assistance, contact your cable service provider.

IMPORTANT SAFETY INSTRUCTIONS

CATV Installers Notice

If you are a CATV installer, read the information in the box below.

Note to CATV System Installer (U.S.A. and Canada Only)
This reminder is provided to call the CATV system installer's attention to Article 620-40 of the NEC (Section 54, Part I of the Canadian Electrical Code), that provides guidelines for proper grounding and, in particular, specifies that the CATV cable ground shall be connected to the grounding system of the building, as close to the point of cable entry as practical.

CAUTION
RISK OF ELECTRIC SHOCK
DO NOT OPEN
AVIS
RISQUE DE CHOC ELECTRIQUE
NE PAS OUVRIRE

CAUTION: To reduce the risk of electric shock, do not remove cover (or back). No user-serviceable parts inside. Refer servicing to qualified service personnel.

WARNING
TO PREVENT FIRE OR ELECTRIC SHOCK,
DO NOT EXPOSE THIS UNIT TO RAIN OR MOISTURE.

This symbol is intended to alert you that uninsulated voltage within this product may have sufficient magnitude to cause electric shock. Therefore, it is dangerous to make any kind of contact with any inside part of this product.

This symbol is intended to alert you of the presence of important operating and maintenance (servicing) instructions in the literature accompanying this product.

Heed Warnings

Adhere to all warnings on the product and in the operating instructions.

Read, Retain, and Follow These Instructions

Read all of the instructions before you operate this product. Follow all operating instructions that accompany this product. Retain the instructions for future use. Give particular attention to all safety precautions.

Comply With Warnings

Avoid electric shock. Comply with all warnings and cautions in the operating instructions, as well as those that are affixed to this product.

Power Warnings

Providing a Power Source

A label on this product indicates the correct power source for this product. Operate this product only from an electrical outlet with the voltage and frequency indicated on the product label.

If you are uncertain of the type of power supply to your home or business, consult your cable service provider or your local power company.

Grounding This Product (U.S.A. and Canada Only)

 **WARNING: To avoid electric shock and fire hazard, match the plug and outlet connections carefully, then fully insert. If the plug and outlet do not match, or you cannot fully insert the plug, contact an electrician to update your power outlets.**

If this product is equipped with either a three-prong (grounding pin) safety plug or a two-prong (polarized) safety plug, follow these safety guidelines to properly ground this product:

- For a 3-prong plug (one prong on this plug is a protective grounding pin), insert the plug into a grounded mains, 3-prong outlet.
Note: This plug fits only one way. If you are unable to insert this plug fully into the outlet, contact your electrician to replace your obsolete outlet.
- For a 2-prong plug (a polarized plug with one wide blade and one narrow blade), insert the plug into a polarized mains, 2-prong outlet in which one socket is wider than the other.
Note: If you are unable to insert this plug fully into the outlet, try reversing the plug. If the plug still fails to fit, contact an electrician to replace your obsolete outlet.

Overloading

 **WARNING: Avoid electric shock and fire hazard! Do not overload mains AC outlets and extension cords. For products that require battery power or other power sources to operate them, refer to the operating instructions for those products.**

Do not overload electrical outlets, extension cords, or integral convenience receptacles as this can result in a risk of fire or electric shock. For products that require battery power or other sources to operate, refer to the operating instructions for that product.

Preventing Power Cord Damage

Arrange all power cords so that people or pets cannot walk on the cords.

Do not place objects on the cords. Do not lean objects against the cords. Placing objects on or leaning objects against cords can damage the cords. Give particular attention to cords at the point at which the cord connects to plugs, at the electrical outlets, and where the cords exit the product.

Usage Warnings

Providing Ventilation

This product has openings for ventilation that protect it from overheating. To ensure the reliability of this product, do the following:

- Do not block or cover these openings.
- Do not place entertainment devices (such as VCRs or DVDs), lamps, books, vases with liquids, or other objects on top of this product.
- Do not place this product in any of the following locations:
 - On a bed, sofa, rug, or similar surface
 - Near heat sources such as radiators, heat registers, stoves, or other products (including amplifiers) that produce heat
 - In an enclosure, such as a bookcase or rack, unless the installation provides proper ventilation

Selecting a Proper Location

 **WARNING: Avoid personal injury and damage to this product! An unstable surface may cause this product to fall.**

Place this product in a location that is close enough to an electrical outlet and where the power cord is easily accessible to be disconnected from the wall outlet or from the rear panel of the product.

Important: The power cord is the mains power supply disconnect device. Place this product on a stable surface. The surface must support the size and weight of this product.

Cleaning This Product

 **WARNING: Avoid electric shock! Unplug this product before cleaning.**

Before cleaning this product, unplug it from the electrical outlet. Use a damp cloth to clean this product. Do not use a liquid cleaner or an aerosol cleaner. Do not use a magnetic/static cleaning device (dust remover) to clean this product.

Protecting This Product From Foreign Objects and Water or Moisture Damage

 **WARNING: Avoid electric shock and fire hazard! Never push objects through the openings in this product. Foreign objects can cause electrical shorts that can result in electric shock or fire. Do not expose this product to rain or moisture. Do not place objects filled with liquid, such as vases, on this product.**

Never push objects of any kind into this product through openings as they may touch dangerous voltage points or short out parts that could result in a fire or electric shock.

Do not expose this product to liquids or moisture. Do not place this product on a wet surface. Do not spill liquids on or near this product.

Do not use this product near water (such as a bath tub, wash bowl, sink, or laundry tub), in a wet basement, or near a swimming pool.

Accessories Warnings

 **WARNING: Avoid any potential for electric shock or fire. Do not use accessories with this product unless recommended by your cable service provider.**

Avoid any potential for electric shock or fire. Do not use accessories with this product unless recommended by your cable service provider.

Service Warnings

Servicing This Product

 **WARNING: Avoid electric shock! Opening or removing the cover may expose you to dangerous voltages. This product contains no user-serviceable parts. Refer all servicing to qualified service personnel.**

Do not open the cover of this product. If you open the cover, your warranty will be void. Refer all servicing to qualified personnel only. Contact your cable service provider for instructions.