



Cisco TelePresence Touch

- for C Series and EX Series

Lasse Melbye



Cisco TelePresence Touch

Now available for C Series Meeting Room Systems



New Consistent Experience Across Rooms and Personal Systems



A TelePresence Touch Revolution



It's easy.

Simplicity of the touch technology. Visual and intuitive user interaction. Clean design of core user tasks.

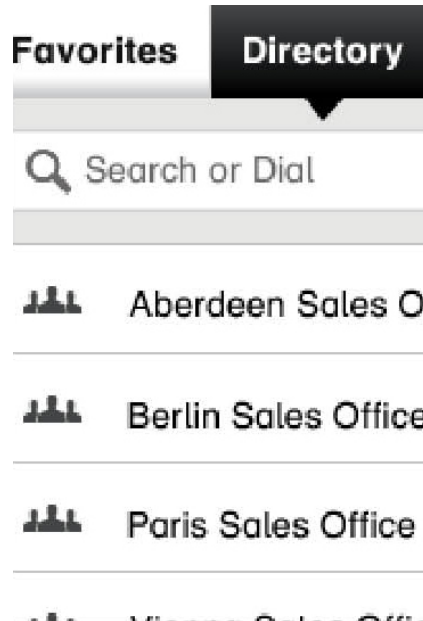

It's flexible.

It's just as simple to join a scheduled meeting as it is to initiate an ad hoc meeting.

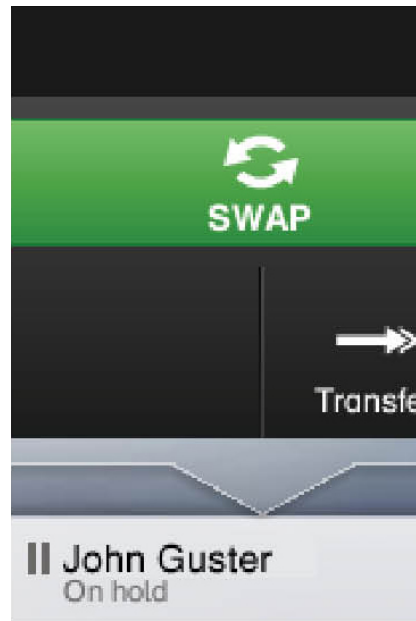

It's optimized.

Adaptable user interface dependent on use scenarios and system capabilities.

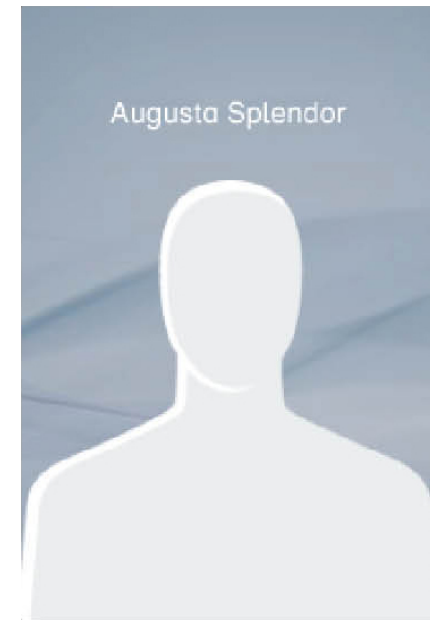

It's consistent.

Be confident. It's the same familiar user experience whether you are at your desk or in a meeting room.

Feature Highlights

Search across all contact categories

Dial directly from the input field

Ease of Managing Contacts

Ease of Managing a Conference

Quick and Seamless Source Selection

Optimized Presentation Experience



Search across all categories

Input area for generic search and manual dialing

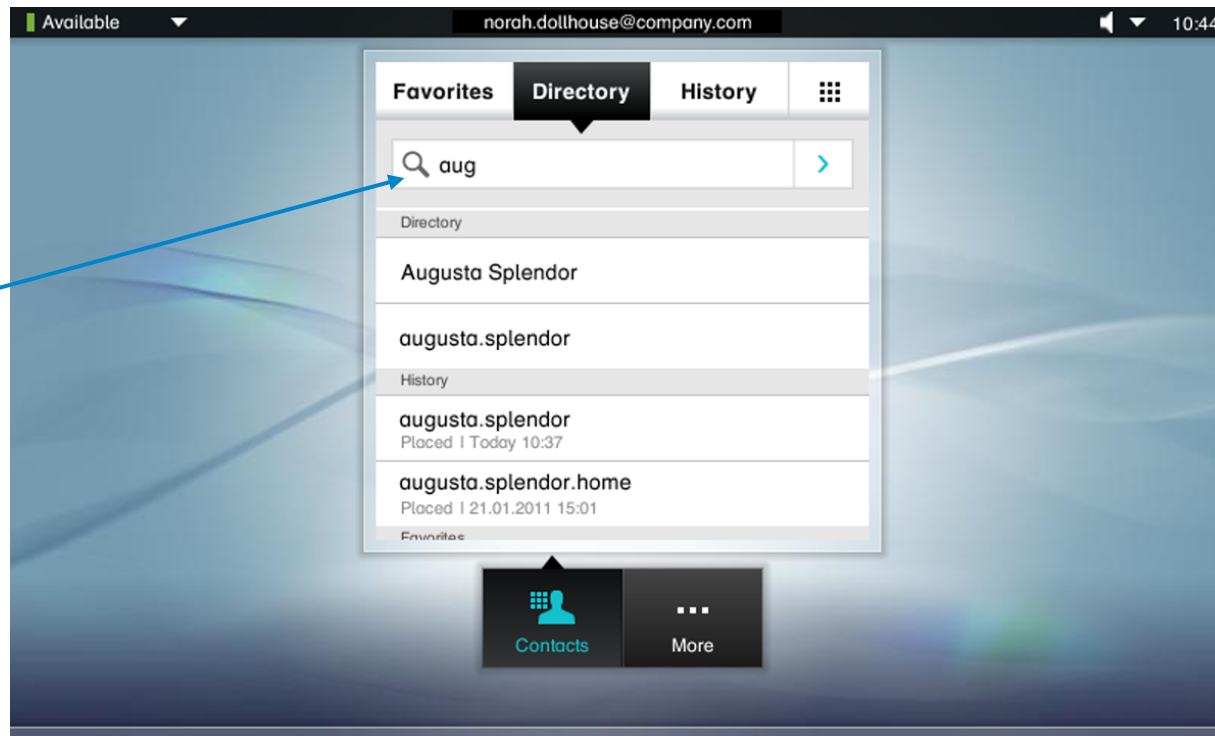

The search field enables you to easily find contacts across all categories whether they are in 'Favorites', 'History' or 'Directory'.

Scroll function in 'Favorites', 'Directory' and 'History'.

Dial directly from the input field

The manual dialing allows to type an new address or number by using the keyboard or keypad.

Quick entry to the most used contact functionality by bringing up last used category, keyboard or keypad.

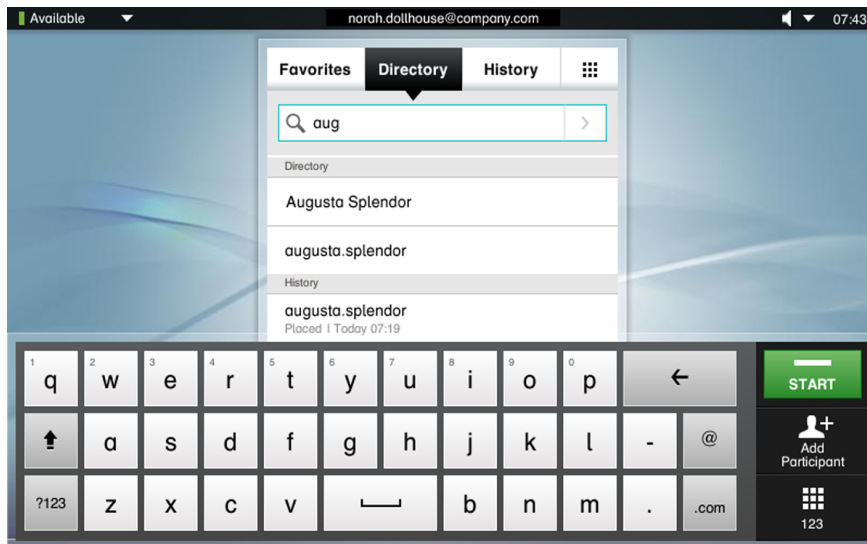

Search for a contact or call a URI



Dial a number

Ease of Managing Contacts

Once a contact is selected there are multiple functions available in the contact card.

Tap **'Start'** to directly dial the selected contact.

Tap **'Add Participant'** to select multiple participants into a conference.

Tap **'Edit & Start'** to edit an address/number before dialing.

Tap **'Call rate default'** to change the call rate before dialing.



Contact card

Tap **'Add Favorites'** to add contacts to 'Favorites'.

Ease of Managing a Conference

Multiple available functions offer flexibility and freedom to directly organize and manage a conference.

The Participant bar gives a good overview and status of meeting participants.

A context card gives you the ability to Hold, Resume, Swap or Join meetings, in addition to far end camera control

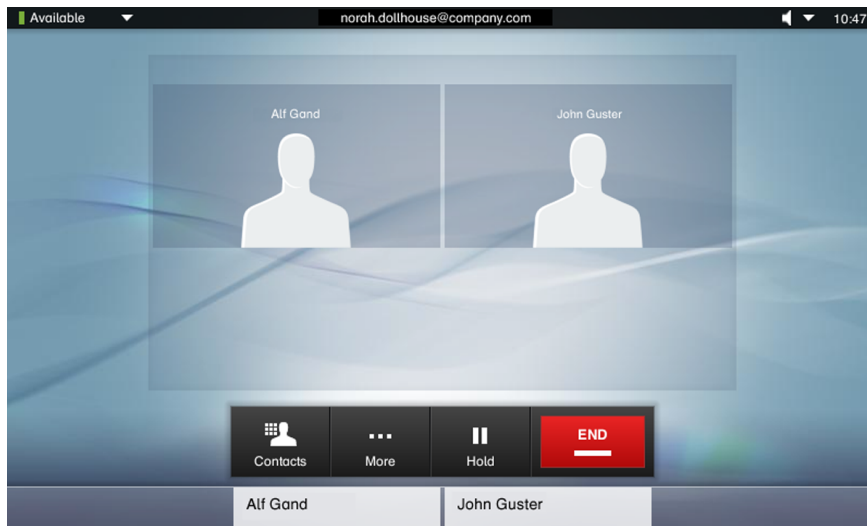

Participant bar

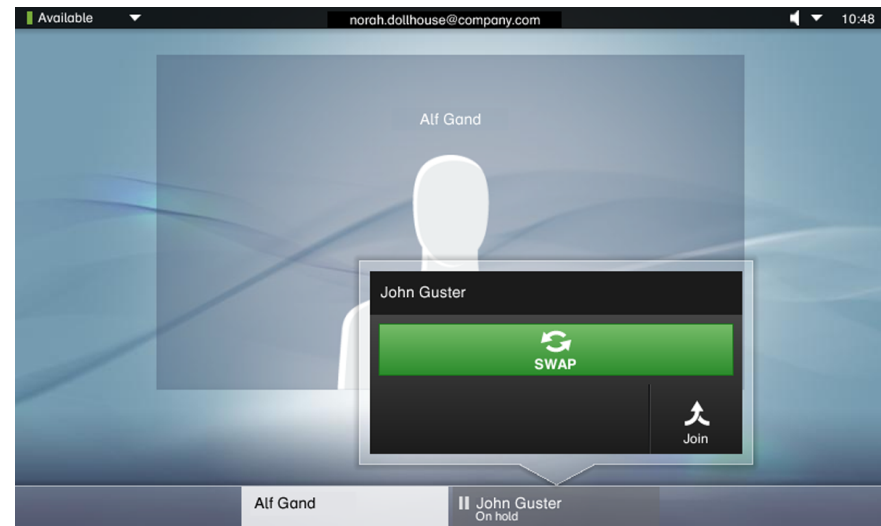

Context card

Quick and Seamless Source Selection



Presentation

Easily select between sources

Display active source and tap 'Present' to share.

Optimized Presentation Experience

Present, minimize presentation or end presentation

View selected source on the touch screen and tap 'Present' when ready.

Minimize presentation to focus on participants in full screen without having to close the presentation.

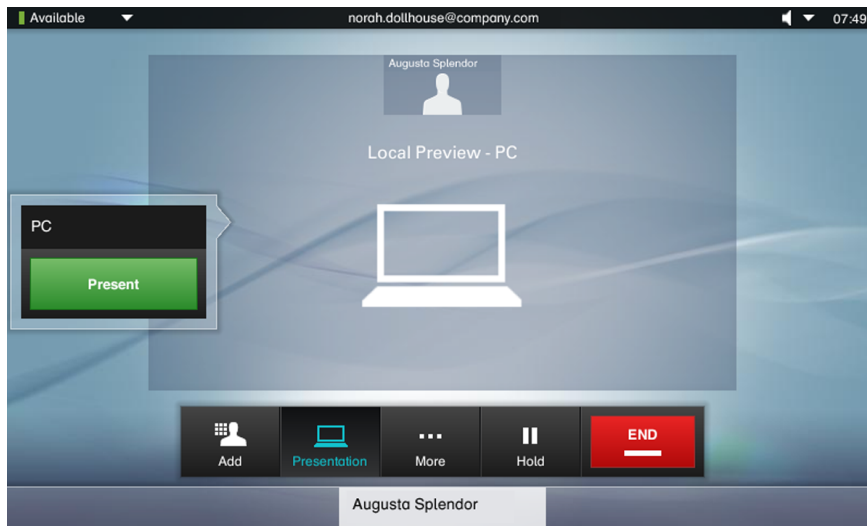

Tap to Present (EX Series GUI)



Tap 'Minimize' to minimize presentation (EX Series GUI)

Out-of-the-Box Provisioning for the EX Series

1 PICK UP AND PLUG IN



Connect at home or in the office

2 TYPE IN USER CREDENTIALS

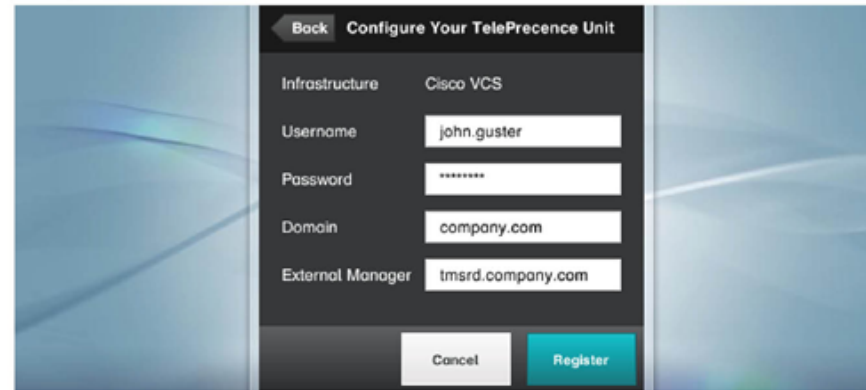

Log-in details provided in e-mail

3 SEARCH, FIND AND CALL



Immediate access to corporate phone book

4 NATURAL COMMUNICATION ESTABLISHED



Meet face to face anytime

More Feature Highlights

Local Camera Control

For Meeting room systems with PTZ camera and EX systems with zoom there is local camera control.

Far end Camera Control

On the context card for conference participants (participant bar) there is far end camera control function.

Layout Option

Full Screen: Far end or presentation in full screen

Speaker: Large window of active speaker, small POP window of others

Speaker full: Full screen of active speaker, with PIP window of others

Equal: Equally large windows of all participants.

Settings

Access settings to configure the system and set user preferences.

Self View

To see what view you send to far end, use self view. A pip window appears.

Hold/Resume/Join/Swap

Place conference participants on hold, and resume them back to conference. Join and swap between conference participants.

Audio input

Easy select between speaker, handset and headset.

Do not Disturb

Ability to block incoming calls



Availability

TC4.1 - February, 2011

Shipping with:

- EX Series (including handset)
- Profile C Series

Optional for:

- C Series Integrator Package
- Quick set



How to connect using LAN

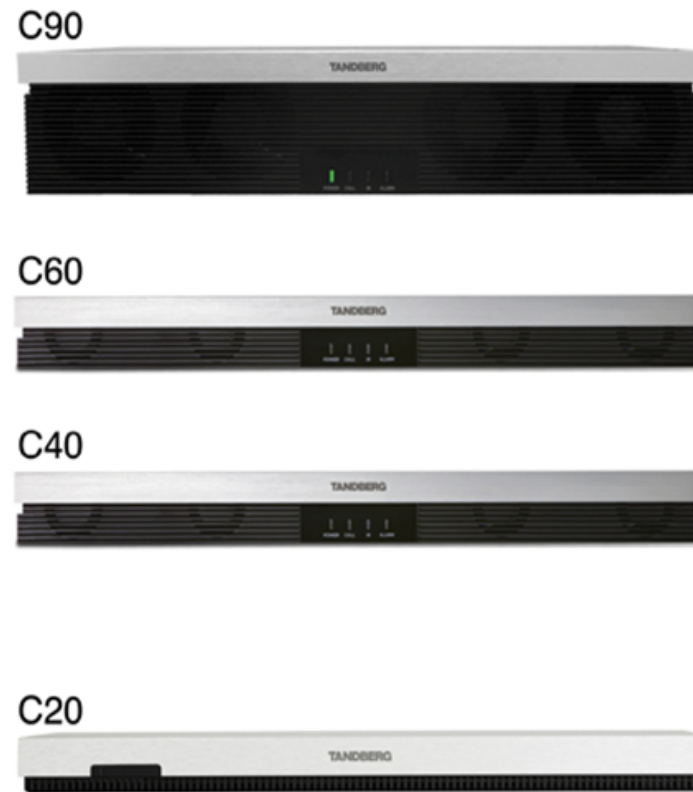
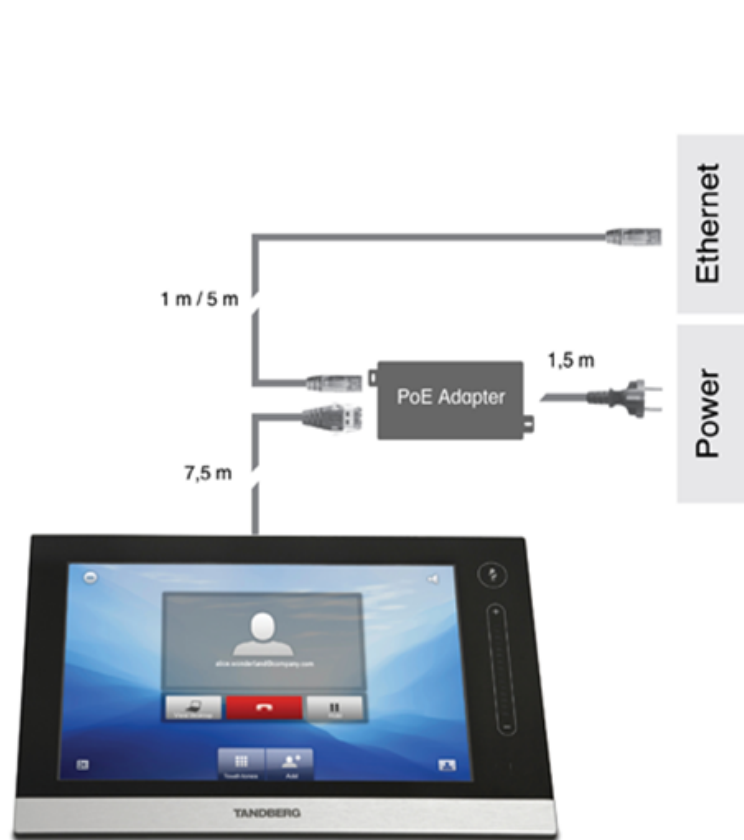

How to connect directly

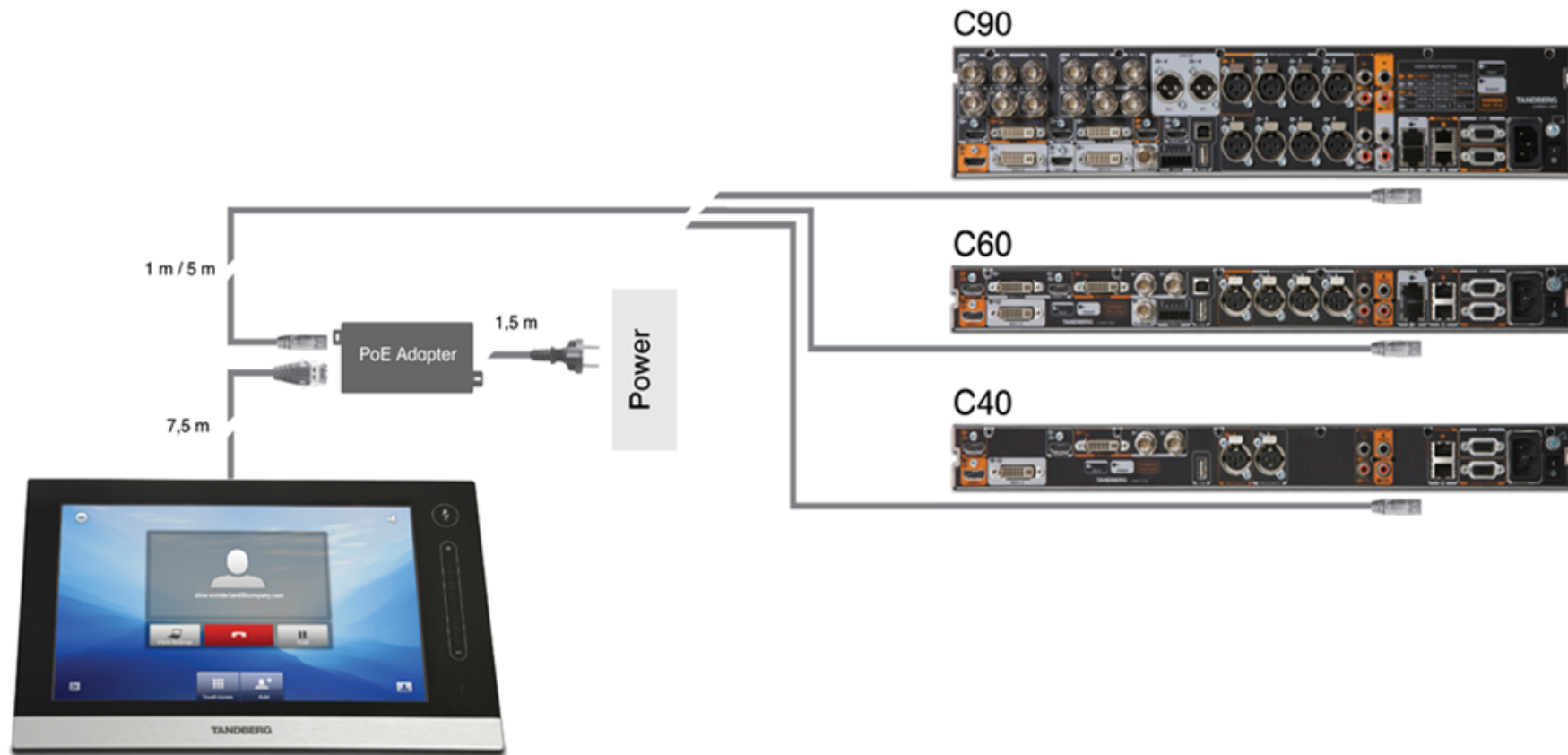

Two options for C90, C60, C40 based products – Ethernet or Direct

Pairing easy 1-2-3

- Select video endpoint from the list
- Enter Username and Password *
- Ready to use

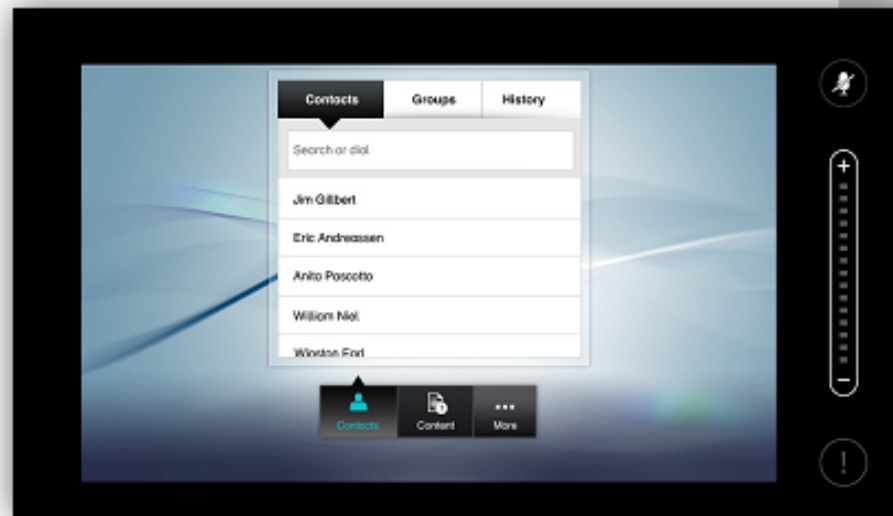

* Default, if not changed by administrator

Technical details

C-series Software

- TC4.1

inTouch Device

- 8" projected capacitive touch screen
- 480 x 800 resolution

inTouch for C-series Cable kit

- inTouch cable : 7,5 m
- Ethernet cable : 1 m or 5 m
- AC Power adapter cable : 1,5 m

Thank you.

