

Authentication on Wireless LAN Controllers Configuration Examples

Document ID: 82135

Contents

Introduction

Prerequisites

- Requirements
- Components Used
- Conventions

Authentication on WLCs

- Layer 1 Solutions
- Layer 2 Solutions
- Layer 3 Solutions

Configuration Examples

- Layer 1 Security Solutions
- Layer 2 Security Solutions
- Layer 3 Security Solutions

Troubleshoot

- Troubleshooting Commands

Related Information

Introduction

This document provides configuration examples that explain how to configure different types of Layer 1, Layer 2, and Layer 3 authentication methods on Wireless LAN Controllers (WLCs).

Prerequisites

Requirements

Ensure that you meet these requirements before you attempt this configuration:

- Knowledge of the configuration of Lightweight Access Points (LAPs) and Cisco WLCs
- Knowledge of 802.11i security standards

Components Used

The information in this document is based on these software and hardware versions:

- Cisco 4400 WLC that runs firmware release 6.0.182.0
- Cisco 1000 Series LAPs
- Cisco 802.11a/b/g Wireless Client Adapter that runs firmware release 2.6
- Cisco Secure ACS server version 3.2

The information in this document was created from the devices in a specific lab environment. All of the devices used in this document started with a cleared (default) configuration. If your network is live, make sure that you understand the potential impact of any command.

Conventions

Refer to Cisco Technical Tips Conventions for more information on document conventions.

Authentication on WLCs

The Cisco Unified Wireless Network (UWN) security solution bundles potentially complicated Layer 1, Layer 2, and Layer 3 802.11 Access Point (AP) security components into a simple policy manager that customizes system-wide security policies on a per-wireless LAN (WLAN) basis. The Cisco UWN security solution provides simple, unified, and systematic security management tools.

These security mechanisms can be implemented on WLCs.

Layer 1 Solutions

Restrict client access based on the number of consecutive failed attempts.

Layer 2 Solutions

None Authentication When this option is selected from the Layer 2 Security drop-down list, No Layer 2 authentication is performed on the WLAN. This is the same as the open authentication of the 802.11 standard.

Static WEP With Static Wired Equivalent Privacy (WEP), all APs and client radio NICs on a particular WLAN must use the same encryption key. Each sending station encrypts the body of each frame with a WEP key before transmission, and the receiving station decrypts it using an identical key upon reception.

802.1x Configures the WLAN to use the 802.1x based authentication. The use of IEEE 802.1X offers an effective framework in order to authenticate and control user traffic to a protected network, as well as dynamically vary encryption keys. 802.1X ties a protocol called Extensible Authentication Protocol (EAP) to both the wired and WLAN media and supports multiple authentication methods.

Static WEP + 802.1x This Layer 2 security setting enables both 802.1x and Static WEP. Clients can either use Static WEP or 802.1x authentication in order to connect to the network.

Wi-Fi Protected Access (WPA) WPA or WPA1 and WPA2 are standard-based security solutions from the Wi-Fi Alliance that provide data protection and access control for WLAN systems. WPA1 is compatible with the IEEE 802.11i standard but was implemented before the standard's ratification. WPA2 is the Wi-Fi Alliance's implementation of the ratified IEEE 802.11i standard.

By default, WPA1 uses Temporal Key Integrity Protocol (TKIP) and message integrity check (MIC) for data protection. WPA2 uses the stronger Advanced Encryption Standard encryption algorithm using Counter Mode with Cipher Block Chaining Message Authentication Code Protocol (AES-CCMP). Both WPA1 and WPA2 use 802.1X for authenticated key management by default. However, these options are also available: PSK, CCKM, and CCKM+802.1x. If you select CCKM, Cisco only allows clients which support CCKM. If you select CCKM+802.1x, Cisco allows non-CCKM clients also.

CKIP Cisco Key Integrity Protocol (CKIP) is a Cisco-proprietary security protocol for encrypting 802.11 media. CKIP improves 802.11 security in infrastructure mode using key permutation, MIC, and message sequence number. Software release 4.0 supports CKIP with static key. For this feature to operate correctly, you must enable Aironet information elements (IEs) for the WLAN. The CKIP settings specified in a WLAN are mandatory for any client that attempts to associate. If the WLAN is configured for both CKIP key permutation and MMH MIC, the client must support both. If the WLAN is configured for only one of these features, the client must support only this CKIP feature. WLCs only support static CKIP (like static WEP).

WLCs do not support CKIP with 802.1x (dynamic CKIP).

Layer 3 Solutions

None When this option is selected from the Layer 3 security drop-down list, no Layer 3 authentication is performed on the WLAN.

Note: The configuration example for No Layer 3 authentication and No Layer 2 authentication is explained in the None Authentication section.

Web Policy (Web Authentication and Web Passthrough) Web authentication is typically used by customers who want to deploy a guest-access network. In a guest-access network, there is initial username and password authentication, but security is not required for the subsequent traffic. Typical deployments can include "hot spot" locations, such as T-Mobile or Starbucks.

Web authentication for the Cisco WLC is done locally. You create an interface and then associate a WLAN/service set identifier (SSID) with that interface.

Web authentication provides simple authentication without a supplicant or client. Keep in mind that web authentication does not provide data encryption. Web authentication is typically used as simple guest access for either a "hot spot" or campus atmosphere where the only concern is the connectivity.

Web passthrough is a solution through which wireless users are redirected to an acceptable usage policy page without having to authenticate when they connect to the Internet. This redirection is taken care of by the WLC itself. The only requirement is to configure the WLC for web passthrough, which is basically web authentication without having to enter any credentials.

VPN Passthrough VPN Passthrough is a feature which allows a client to establish a tunnel only with a specific VPN server. Therefore, if you need to securely access the configured VPN server as well as another VPN server or the Internet, this is not possible with VPN Passthrough enabled on the controller.

In the next sections, configuration examples are provided for each of the authentication mechanisms.

Configuration Examples

Before you configure the WLANs and the authentication types, you must configure the WLC for basic operation and register the LAPs to the WLC. This document assumes that the WLC is configured for basic operation and that the LAPs are registered to the WLC. If you are a new user trying to setup the WLC for basic operation with LAPs, refer to Lightweight AP (LAP) Registration to a Wireless LAN Controller (WLC).

Layer 1 Security Solutions

Wireless clients can be restricted access based on the number of consecutive failed attempts to access the WLAN network. Client exclusion occurs in these conditions by default. These values cannot be changed.

- Consecutive 802.11 Authentication Failure (5 consecutive times, 6th try is excluded)
- Consecutive 802.11 Association Failures (5 consecutive times, 6th try is excluded)
- Consecutive 802.1x Authentication Failures (3 consecutive times, 4th try is excluded)
- External Policy Server Failure
- Attempt to use IP address already assigned to another device (IP Theft or IP Reuse)
- Consecutive Web Authentication (3 consecutive times, 4th try is excluded)

In order to locate the Client Exclusion Policies, click **Security** in the top menu, and then choose **Wireless Protection Policies > Client Exclusion Policies** the navigation on the left side of the page.



The exclusion timer can be configured. Exclusion options can be enabled or disabled per controller. The exclusion timer can be enabled or disabled per WLAN.

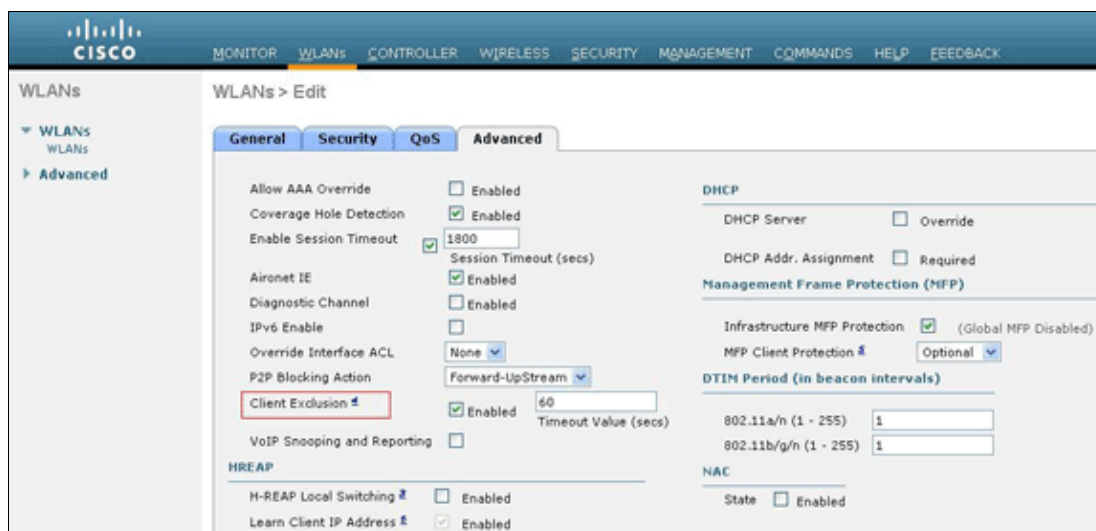

The Maximum Number of Concurrent Logins for a single user name by default is 0. You can enter any value between 0 and 8. This parameter can be set at **SECURITY > AAA > User Login Policies** and allows you to specify the maximum number of concurrent logins for a single client name, between one and eight, or 0 = unlimited. Here is an example:

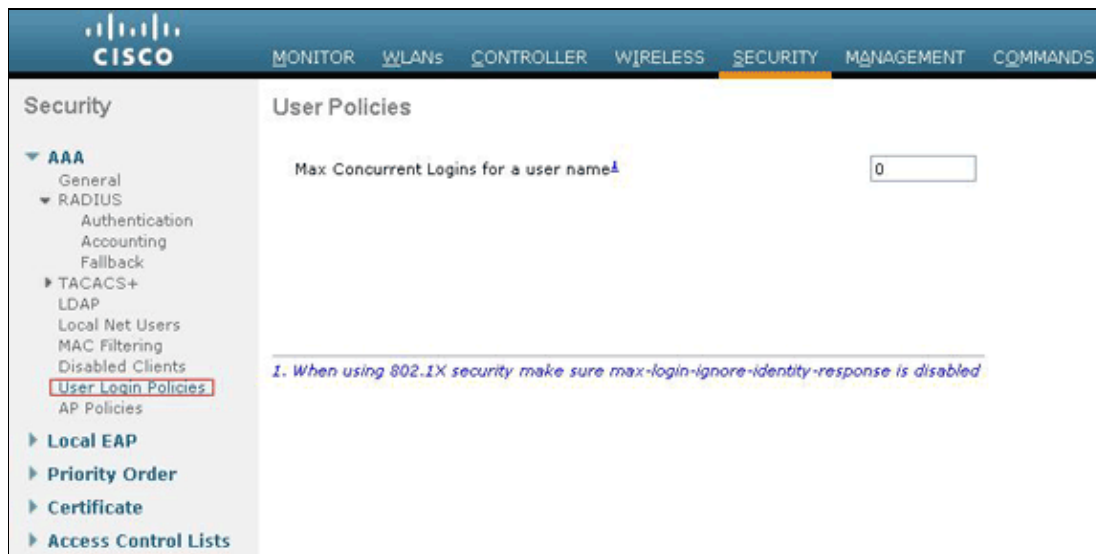

Layer 2 Security Solutions

None Authentication

This example shows a WLAN configured without authentication.

Note: This example also works for No Layer 3 authentication.

Wireless LAN With No Authentication

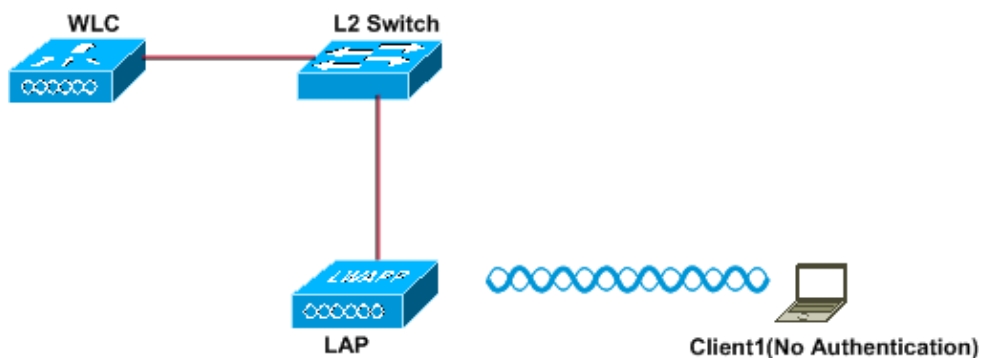

Layer 2 Security: None

Layer 3 Security: None

SSID:NullAuthentication

Configure WLC for No Authentication

Complete these steps in order to configure the WLC for this setup:

1. Click **WLANs** from the controller GUI in order to create a WLAN.

The WLANs window appears. This window lists the WLANs configured on the controller.

2. Click **Go** in order to configure a new WLAN.
3. Enter the parameters for the WLAN. This example shows configuration for this WLAN.

The screenshot shows the Cisco configuration interface for creating a new WLAN. The breadcrumb trail is 'WLANs > New'. The configuration fields are as follows:

Type	WLAN
Profile Name	WLAN1
SSID	NullAuthentication
ID	1

4. Click **Apply**.
5. In the WLAN > Edit window, define the parameters specific to the WLAN.
6. Click the **Security** tab, and choose **None** for Layer 2 and Layer 3 security.

The screenshot shows the 'WLANs > Edit' configuration window. The 'Security' tab is active, and the 'Layer 2' sub-tab is selected. The configuration for Layer 2 Security is as follows:

Layer 2 Security	None
MAC Filtering	<input type="checkbox"/>

Note: For a WLAN to become active, the status should be enabled. To enable it, check the **Status** check box under the General tab.

This enables No authentication for this WLAN.

7. Choose other parameters based on your design requirements. This example uses the default values.
8. Click **Apply**.

Configure Wireless Client for No Authentication

Complete these steps in order to configure the Wireless LAN client for this setup:

Note: This document uses an Aironet 802.11a/b/g Client Adapter that runs firmware 3.5 and explains the configuration of the client adapter with ADU version 3.5.

1. In order to create a new profile, click the **Profile Management** tab on the ADU.
2. Click **New**.
3. When the Profile Management (General) window displays, complete these steps in order to set the profile name, client name, and SSID:

- a. Enter the name of the profile in the Profile Name field.

This example uses *NoAuthentication* as the profile name.

- b. Enter the name of the client in the Client Name field.

The client name is used to identify the wireless client in the WLAN network. This configuration uses *Client 1* for the client name.

- c. Under Network Names, enter the SSID that is to be used for this profile.

The SSID is the same as the SSID that you configured on the WLC. The SSID in this example is *NullAuthentication*.

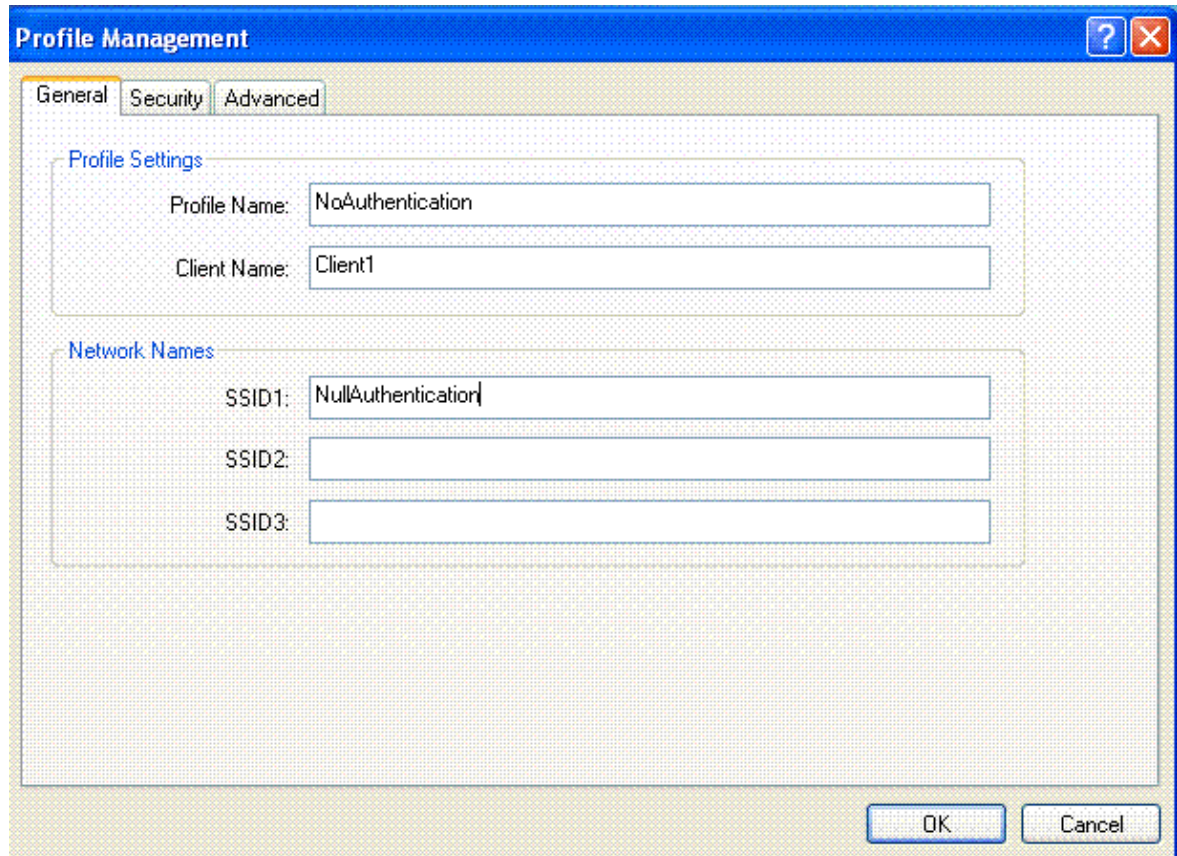

The image shows a screenshot of the 'Profile Management' dialog box, specifically the 'Security' tab. The dialog has a blue title bar with a question mark and a close button. Below the title bar are three tabs: 'General', 'Security', and 'Advanced'. The 'Security' tab is selected. The main area is divided into two sections: 'Profile Settings' and 'Network Names'. In the 'Profile Settings' section, there are two text input fields: 'Profile Name' with the value 'NoAuthentication' and 'Client Name' with the value 'Client1'. In the 'Network Names' section, there are three text input fields: 'SSID1' with the value 'NullAuthentication', 'SSID2' which is empty, and 'SSID3' which is empty. At the bottom right of the dialog are 'OK' and 'Cancel' buttons.

4. Click the **Security** tab.

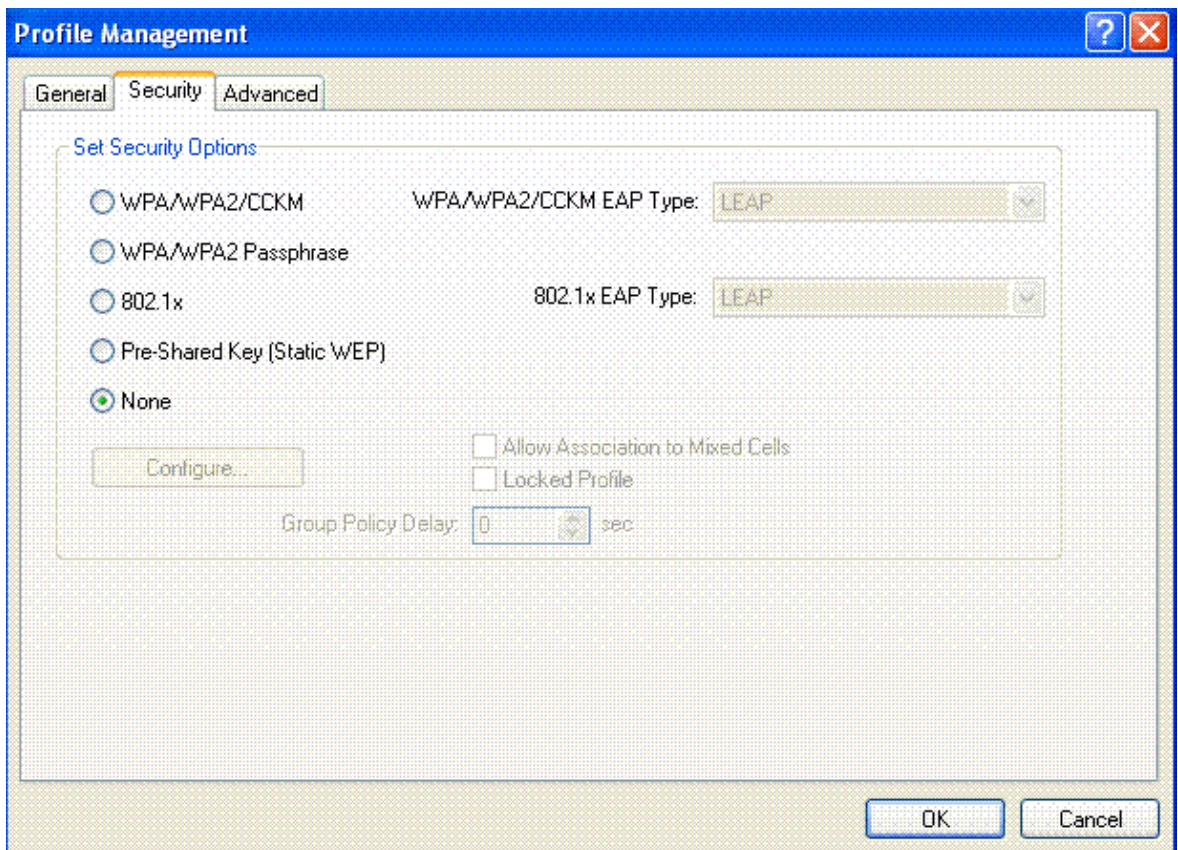

5. Click the **None** radio button under Set Security Options, and then click **OK**.

When the SSID is activated, the wireless client connects to the WLAN without any authentication.

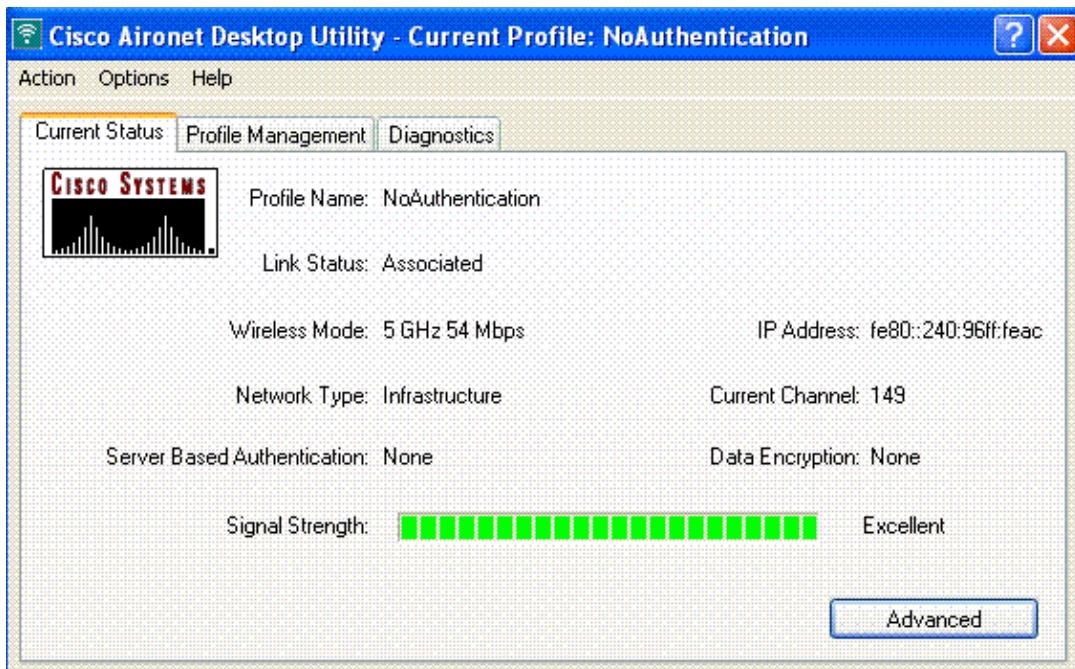

Static WEP

This example shows a WLAN configured with static WEP.

Wireless LAN With Static WEP

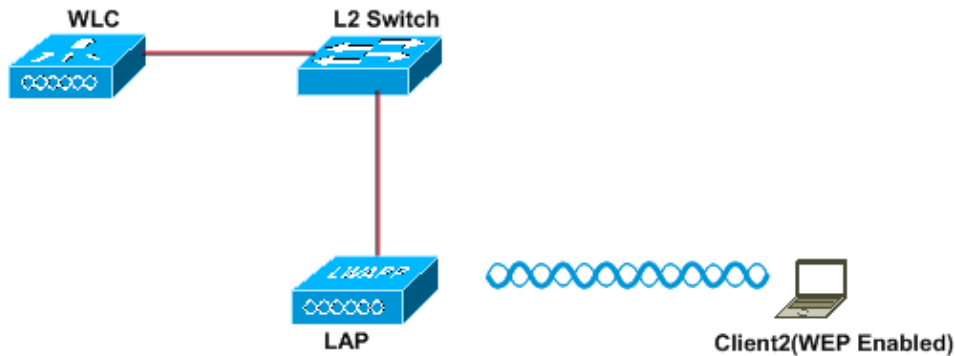

Layer 2 Security: Static-WEP
Layer 3 Security: None

SSID:Static-WEP
WEP-Key Size: 128-bit
WEP Key:1234567890abc

Configure WLC for Static WEP

Complete these steps in order to configure the WLC for this setup:

1. Click **WLANs** from the controller GUI in order to create a WLAN.

The WLANs window appears. This window lists the WLANs configured on the controller.

2. Click **New** in order to configure a new WLAN.
3. Enter the WLAN ID and WLAN SSID.

In this example, the WLAN is named *StaticWEP* and the WLAN ID is 2.

WLANs > New	
Type	WLAN
Profile Name	WLAN2
SSID	StaticWEP
ID	2

4. Click **Apply**.
5. In the WLAN > Edit window, define the parameters specific to the WLAN.
 - a. From the Layer 2 drop-down list, choose **Static WEP**.

This enables Static WEP for this WLAN.

- b. Under Static WEP parameters, choose the WEP key size and key index, and enter the static WEP encryption key.

The key size can be either 40 bits or 104 bits. The key index can be between 1 and 4. One unique WEP Key Index can be applied to each WLAN. Because there are only four WEP Key Indexes, only four WLANs can be configured for Static WEP Layer 2 encryption. In this example, the 104 bit WEP is used and the WEP key used is 1234567890abcdef.

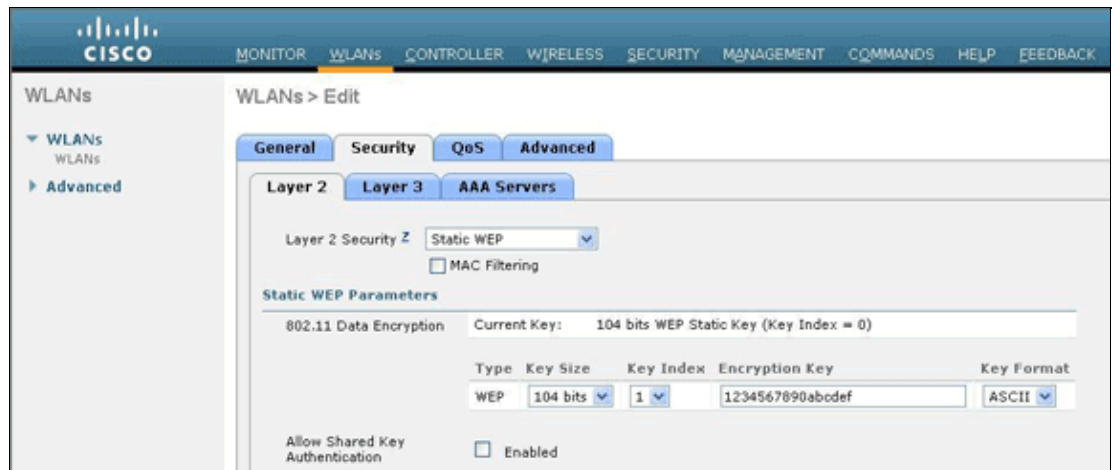

- c. Check if the Radius server is configured for authentication. The Radius server can be configured on the **Security** tab located at **AAA > Radius > Authentication**. Once configured, the Radius server should be assigned to the WLAN for authentication. Go to **WLANs > Security > AAA Servers** in order to assign the Radius server to the WLAN for authentication.

In this example, 10.77.244.196 is the Radius server.

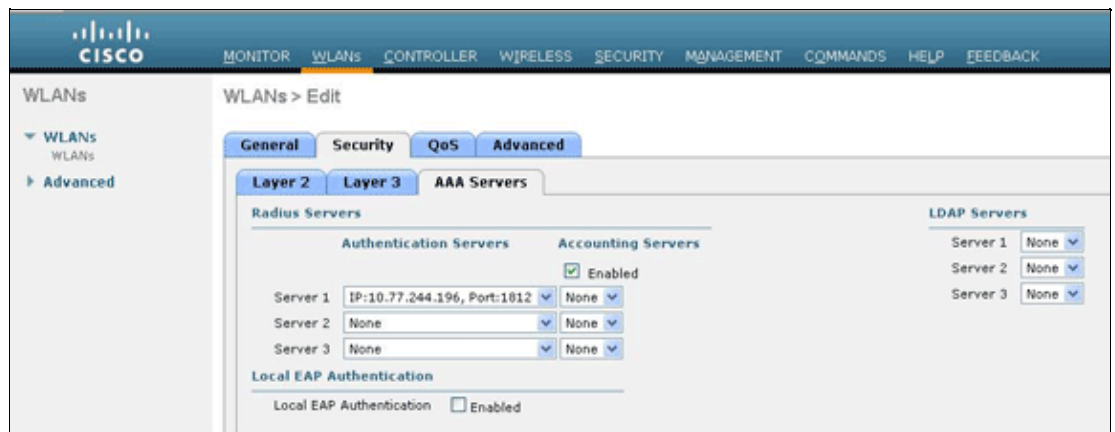

6. Choose other parameters based on your design requirements.

This example uses the default values.

7. Click **Apply**.

Note: WEP is always represented in hexadecimal (hex). When you enter the WEP key in ASCII, the ASCII WEP string is converted to hex, which is used to encrypt the packet. There is no standard method that vendors perform to convert hex to ASCII, as some will do padding while others will not. Therefore, for maximum inter-vendor compatibility, use hex for your WEP keys.

Note: If you want to enable Shared Key Authentication for the WLAN, check the **Allow Shared-Key Authentication** check box under Static WEP Parameters. This way, if the client is also configured for Shared Key Authentication, Shared Key Authentication followed by WEP encryption of packets will take place in the WLAN.

Configure Wireless Client for Static WEP

Complete these steps in order to configure the Wireless LAN Client for this setup:

1. In order to create a new profile, click the **Profile Management** tab on the ADU.
2. Click **New**.
3. When the Profile Management (General) window displays, complete these steps in order to set the profile name, client name, and SSID:

- a. Enter the name of the profile in the Profile Name field.

This example uses *StaticWEP* as the profile name.

- b. Enter the name of the client in the Client Name field.

The client name is used to identify the wireless client in the WLAN network. This configuration uses *Client 2* for the client name.

- c. Under Network Names, enter the SSID that is to be used for this profile.

The SSID is the same as the SSID that you configured on the WLC. The SSID in this example is *StaticWEP*.

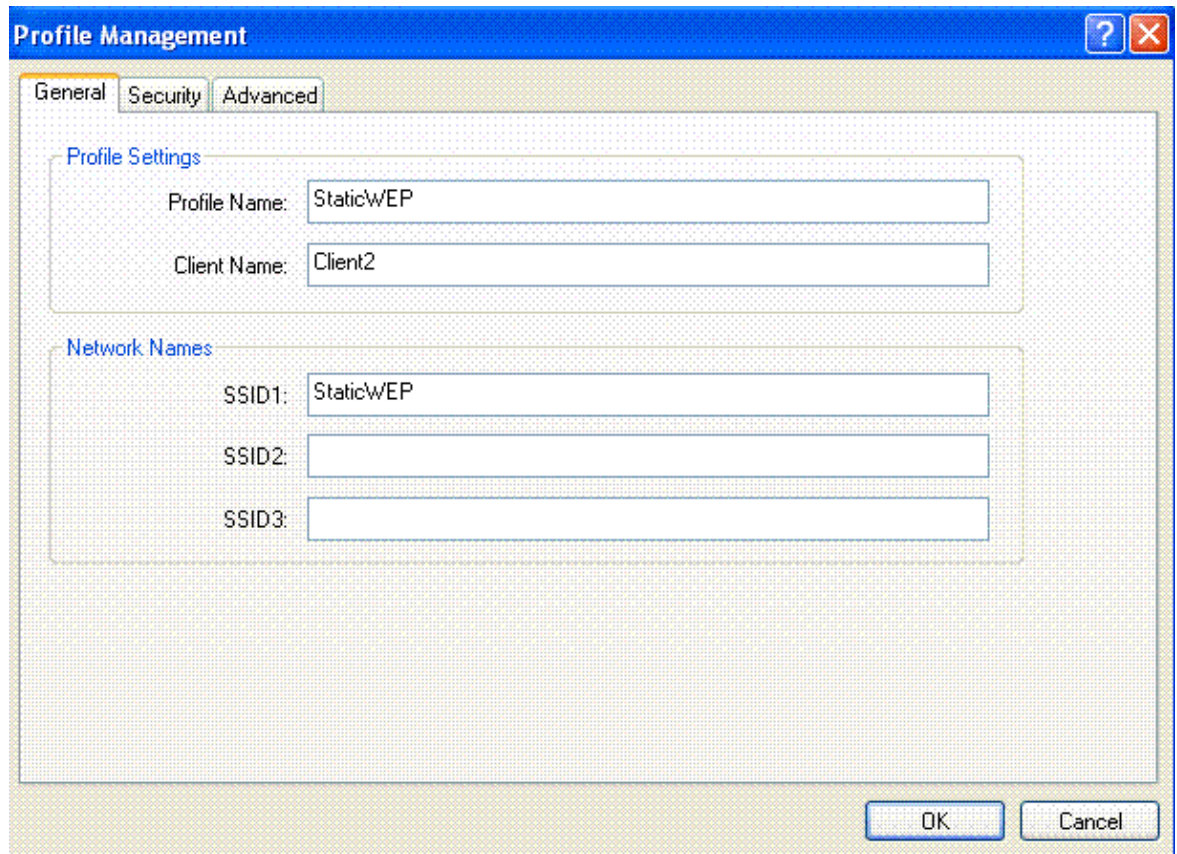

The screenshot shows the 'Profile Management' dialog box with the 'General' tab selected. The 'Profile Settings' section contains two text input fields: 'Profile Name' with the value 'StaticWEP' and 'Client Name' with the value 'Client2'. The 'Network Names' section contains three text input fields: 'SSID1' with the value 'StaticWEP', 'SSID2' which is empty, and 'SSID3' which is empty. The dialog box has a blue title bar with a question mark icon and a close button. At the bottom right, there are 'OK' and 'Cancel' buttons.

4. Click the **Security** tab.

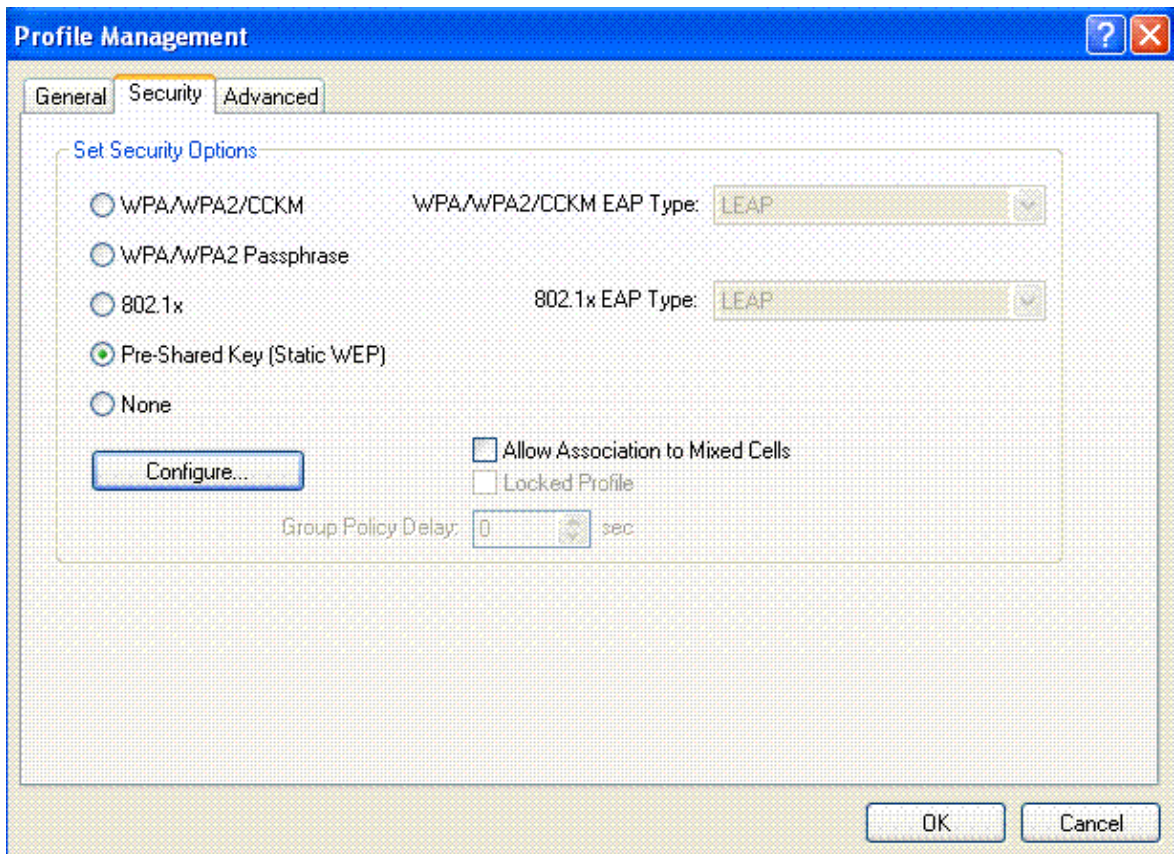

5. Choose **Pre-Shared Key (Static WEP)** under Set Security Options.
6. Click **Configure**, and define the WEP key size and the WEP key.

This should match with the WEP key configured on the WLC for this WLAN.

7. Click **Apply**.

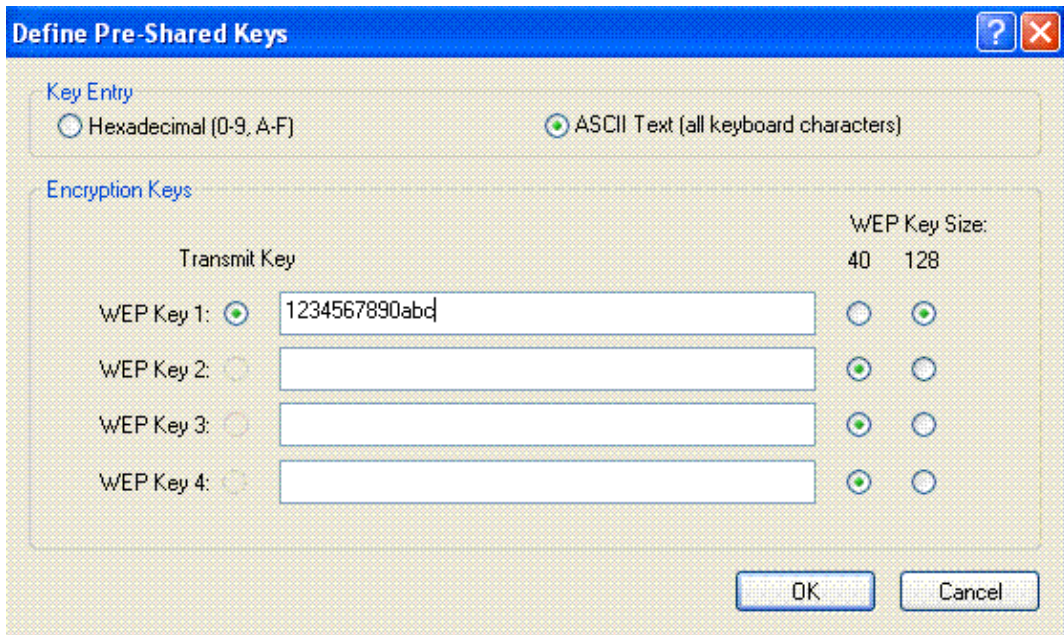

When the SSID is activated, the wireless client connects to the WLAN and the packets are encrypted using the static WEP key.

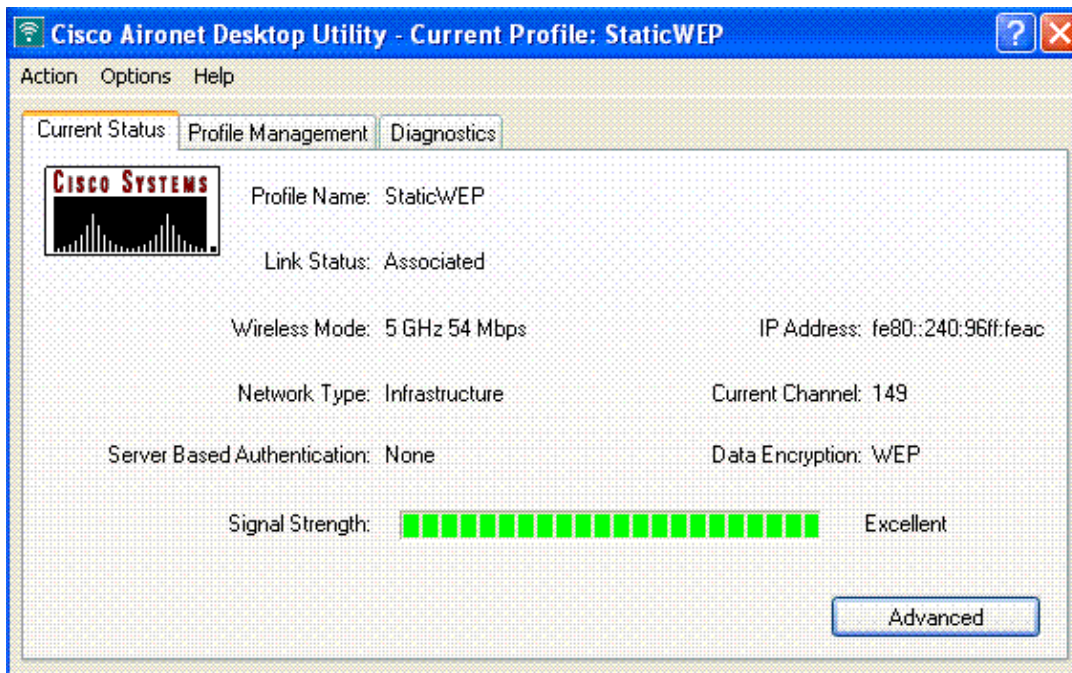

802.1x Authentication

This example shows a WLAN configured with 802.1x authentication.

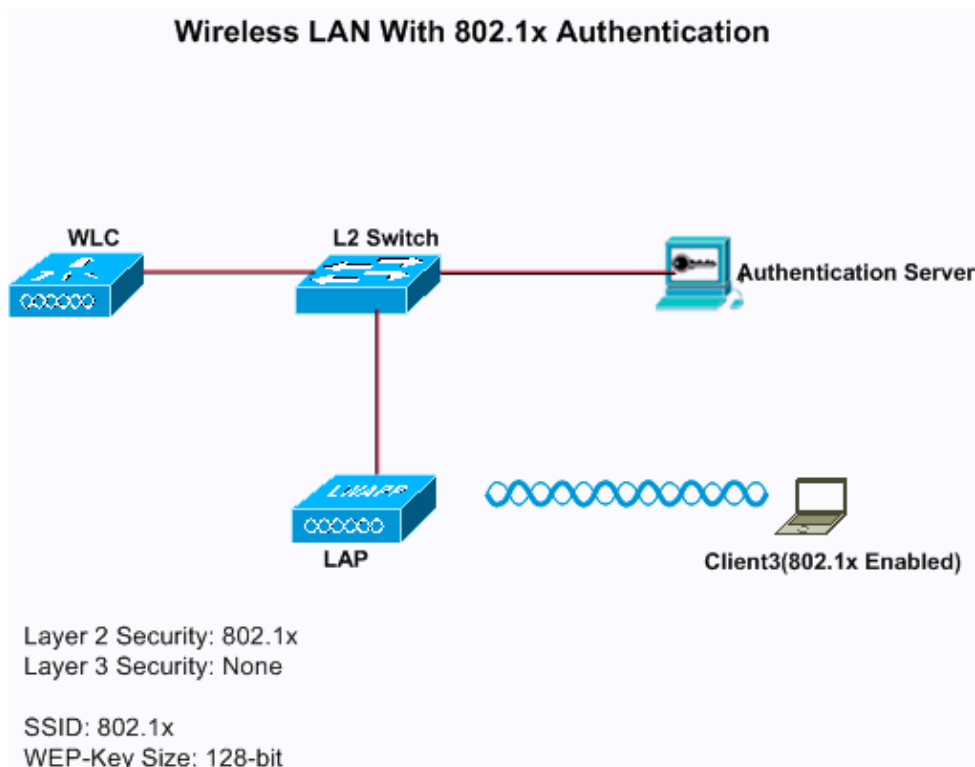

Configure WLC for 802.1x Authentication

Complete these steps in order to configure the WLC for this setup:

1. Click **WLANs** from the controller GUI in order to create a WLAN.

The WLANs window appears. This window lists the WLANs configured on the controller.

2. Click **New** in order to configure a new WLAN.

In this example, the WLAN is named *802.1x*, and the WLAN ID is 3. A profile name should also be added.

The screenshot shows the Cisco configuration interface for creating a new WLAN. The breadcrumb is 'WLANs > New'. The form fields are: Type (WLAN), Profile Name (WLAN3), SSID (802.1x), and ID (3).

3. Click **Apply**.

4. In the WLAN > Edit window, define the parameters specific to the WLAN.

a. From the Layer 2 drop-down list, choose **802.1x**.

Note: Only WEP encryption is available with 802.1x. Choose either 40 bits or 104 bits for encryption, and make sure Layer 3 security is set to None.

This enables 802.1x authentication for this WLAN.

b. Under RADIUS server parameters, select the RADIUS server that will be used to authenticate the client credentials.

c. Choose other parameters based on your design requirements.

This example uses the default values.

5. Click **Apply**.

The screenshot shows the Cisco configuration interface for editing a WLAN. The breadcrumb is 'WLANs > Edit'. The 'Layer 2 Security' dropdown is set to '802.1X'. The '802.1X Parameters' section shows '802.11 Data Encryption' set to 'WEP' and 'Key Size' set to '104 bits'. There is also a 'MAC Filtering' checkbox which is unchecked.

Notes:

- ◆ If you choose *802.1x* for Layer 2 security, CCKM cannot be used.
- ◆ If you choose *WPA 1* or *WPA 2* for Layer 2 security, these options appear under Auth Key Management:

- ◇ *802.1x+CCKM* If you choose this option, both CCKM or non-CCKM clients are supported (CCKM optional).
- ◇ *802.1x* If you choose this option, only 802.1x clients are supported.
- ◇ *CCKM* If you choose this option, only CCKM clients are supported, where clients are directed to an external server for authentication.
- ◇ *PSK* If you choose this option, a pre-shared key is used for the WLC and client. Also, all standards are set to be used to before pre-standards; for example, WPA/WPA2 takes precedent over CCKM when used simultaneously.

The type of EAP authentication used to validate the clients is dependent on the EAP type configured on the RADIUS server and the wireless clients. Once 802.1x is enabled on the WLC, the WLC allows all types of EAP packets to flow between the LAP, the wireless client and the RADIUS server.

These documents provide configuration examples on some of the EAP authentication types:

- ◆ PEAP under Unified Wireless Networks with ACS 4.0 and Windows 2003
- ◆ EAP-TLS under Unified Wireless Network with ACS 4.0 and Windows 2003
- ◆ EAP Authentication with WLAN Controllers (WLC) Configuration Example

Configure Wireless Client for 802.1x Authentication

Complete these steps in order to configure the Wireless LAN Client for this setup:

1. In order to create a new profile, click the **Profile Management** tab on the ADU.
2. Click **New**.
3. When the Profile Management (General) window displays, complete these steps in order to set the profile name, client name, and SSID:

- a. Enter the name of the profile in the Profile Name field.

This example uses *EAPAuth* as the profile name.

- b. Enter the name of the client in the Client Name field.

The client name is used to identify the wireless client in the WLAN network. This configuration uses *Client 3* for the client name.

- c. Under Network Names, enter the SSID that is to be used for this profile.

The SSID is the same as the SSID that you configured on the WLC. The SSID in this example is *802.1x*.

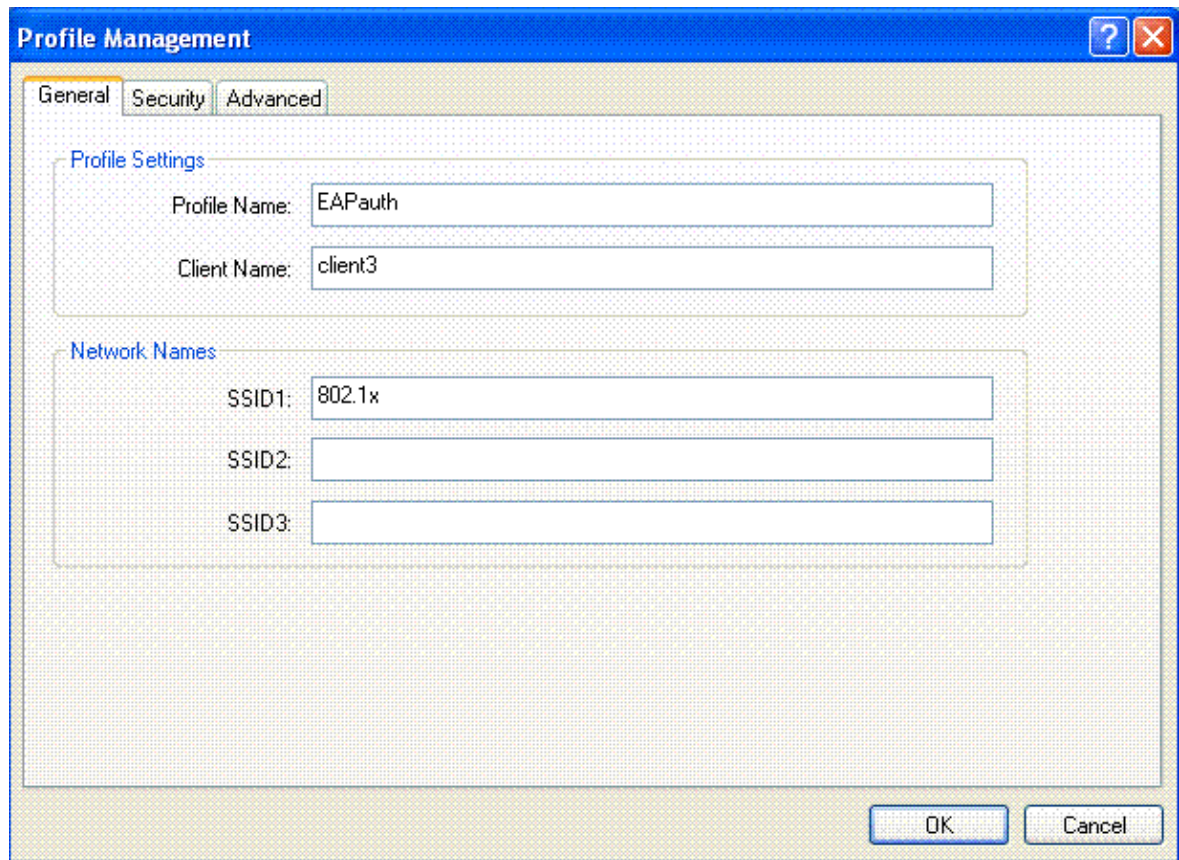

4. Click the **Security** tab.

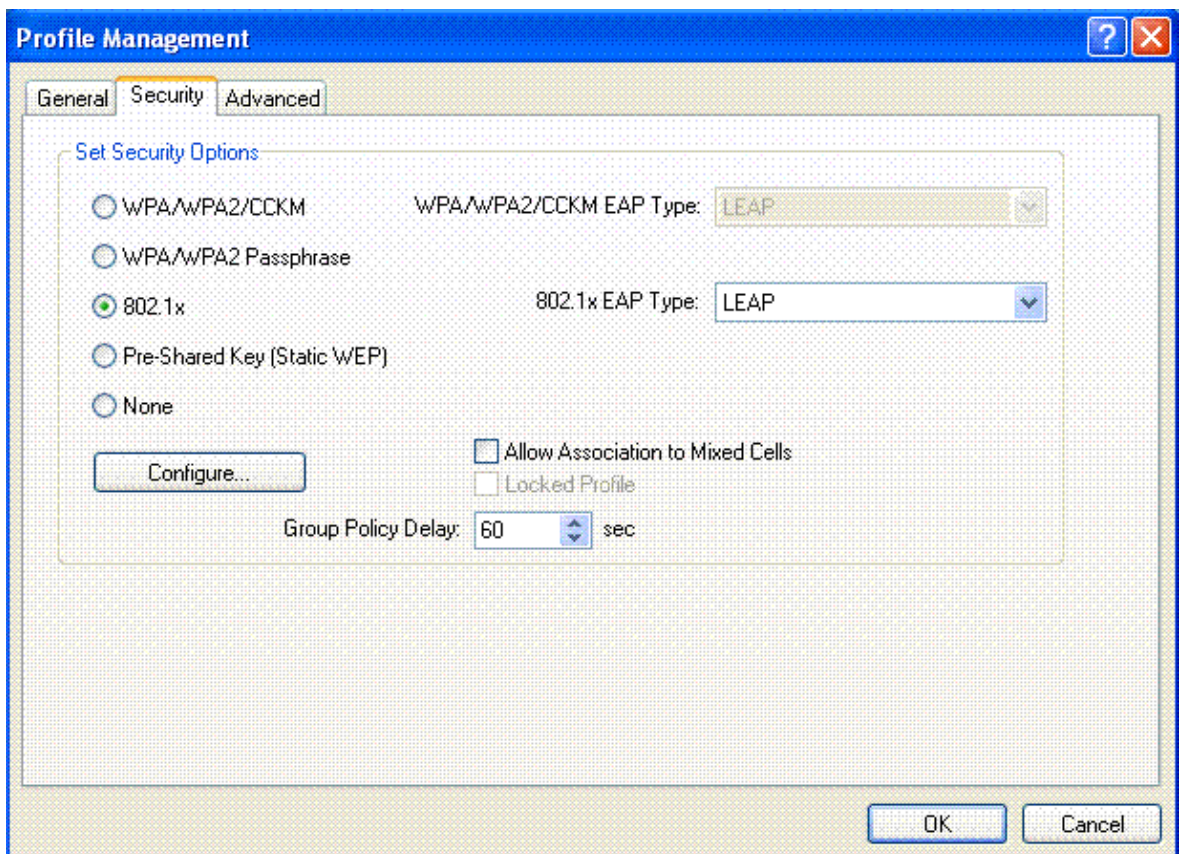

5. Click the **802.1x** radio button.

6. From the 802.1x EAP Type drop-down list, choose the EAP type used.

7. Click **Configure** in order to configure parameters specific to the selected EAP type.

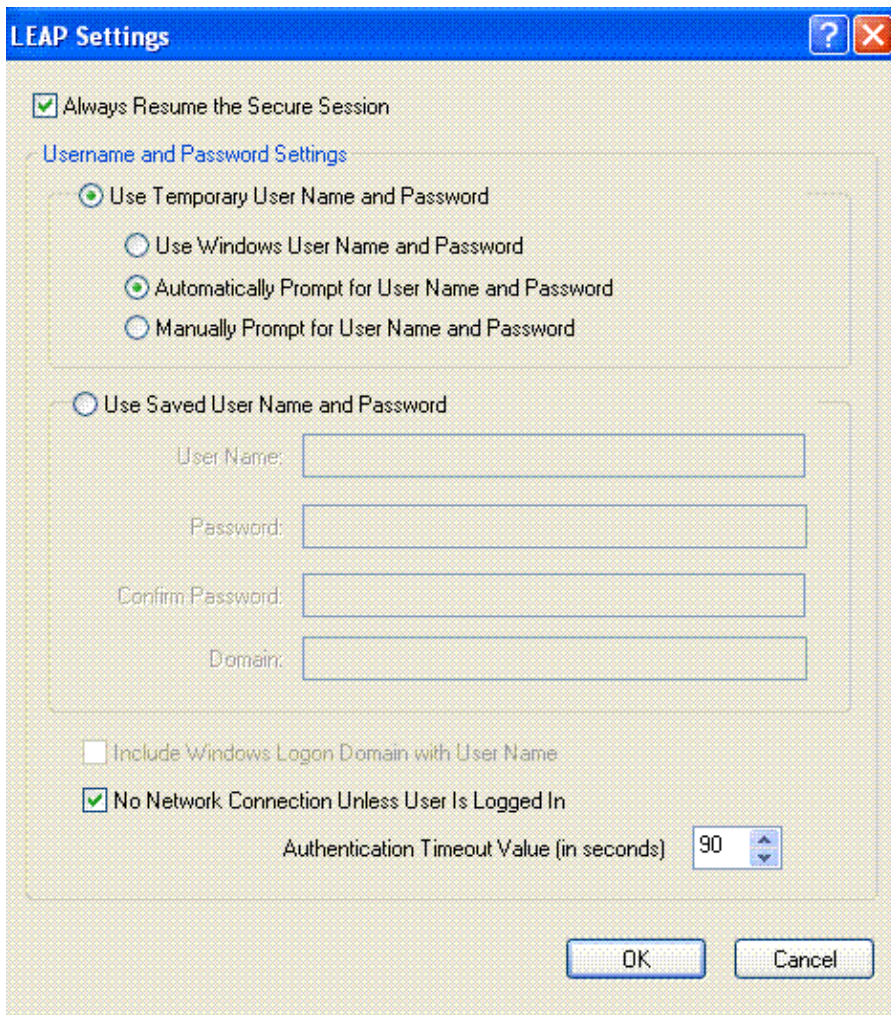

8. Click **Apply**.

When the SSID is activated, the wireless client connects to the WLAN using 802.1x authentication. Dynamic WEP keys are used for the sessions.

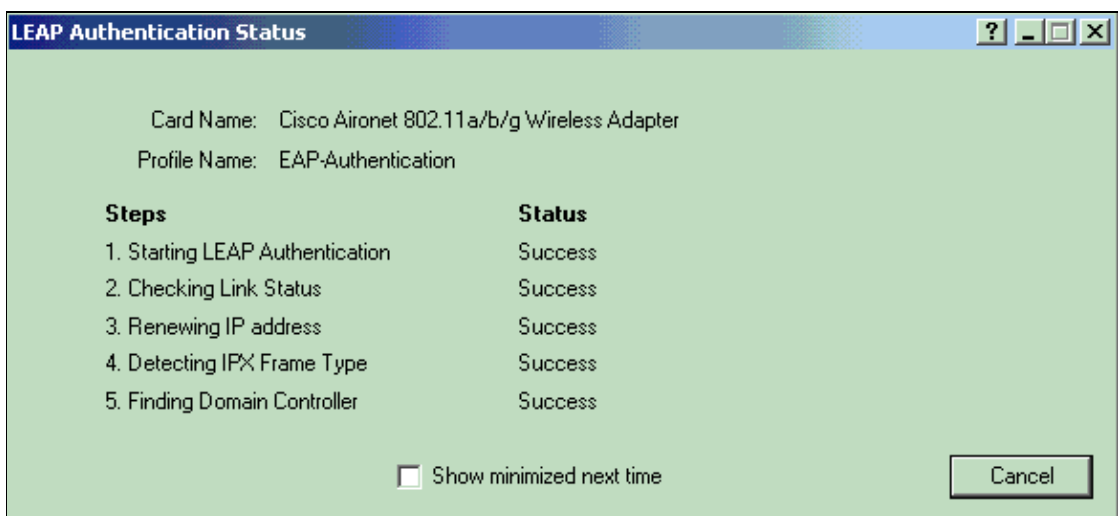

Static WEP + 802.1x Authentication

This example shows a WLAN configured with static WEP + 802.1x authentication.

Wireless LAN With 802.1x + Static-WEP Authentication

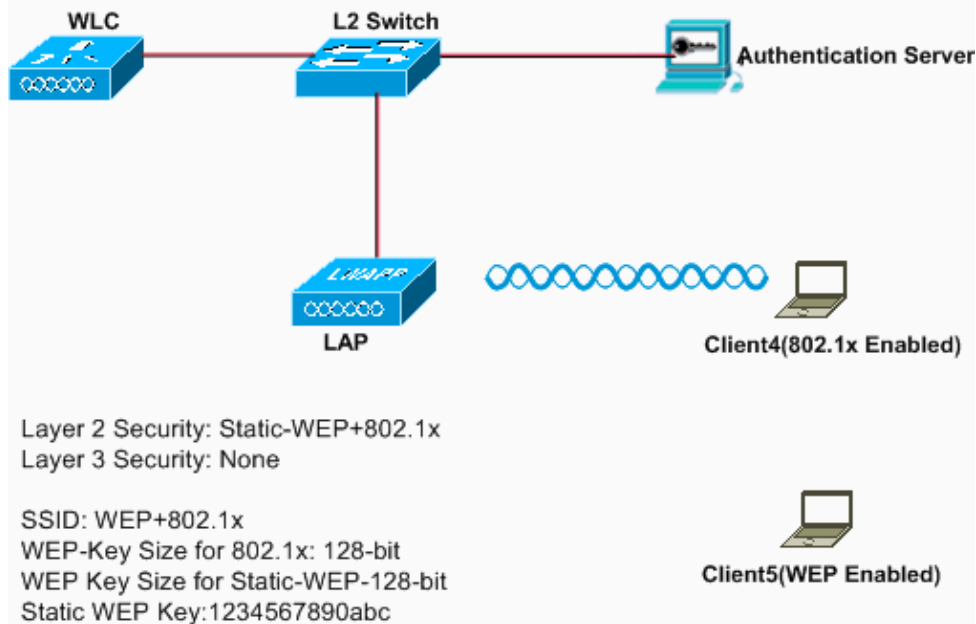

Complete these steps in order to configure the WLC for this setup:

1. Click **WLANS** from the controller GUI in order to create a WLAN.

The WLANs window appears. This window lists the WLANs configured on the controller.

2. Click **New** in order to configure a new WLAN.
3. Enter the WLAN ID and WLAN SSID.

In this example, the WLAN is named *WEP+802.1x*, and the WLAN ID is 4.

WLANs > New

Type	WLAN
Profile Name	WLAN 4
SSID	Static WEP + 802.1x
ID	4

4. Click **Apply**.
5. In the WLAN > Edit window, define the parameters specific to the WLAN.

- a. From the Layer 2 drop-down list, choose **Static-WEP+802.1x**.

This enables both Static WEP and 802.1x authentication for this WLAN.

- b. Under RADIUS server parameters, select the RADIUS server that will be used to authenticate the client credentials using 802.1x, and configure the RADIUS server as shown in the previous example.

- c. Under Static WEP parameters, select the WEP key size and key index, and enter the static WEP encryption key as shown in the previous image.
- d. Choose other parameters based on your design requirements.

This example uses the default values.

Configure the Wireless Client for Static WEP and 802.1x

See the [Configure Wireless Client for 802.1x Authentication](#) and [Configure Wireless Client for Static WEP](#) sections for information on how to configure the wireless client.

Once the client profiles are created, clients that are configured for static WEP associate with the LAP. Use the SSID WEP+802.1x in order to connect to the network.

Similarly, wireless clients which are configured to use 802.1x authentication are authenticated using EAP and access the network with the same SSID WEP+802.1x.

Wi-Fi Protected Access

This example shows a WLAN which is configured with WPA with 802.1x.

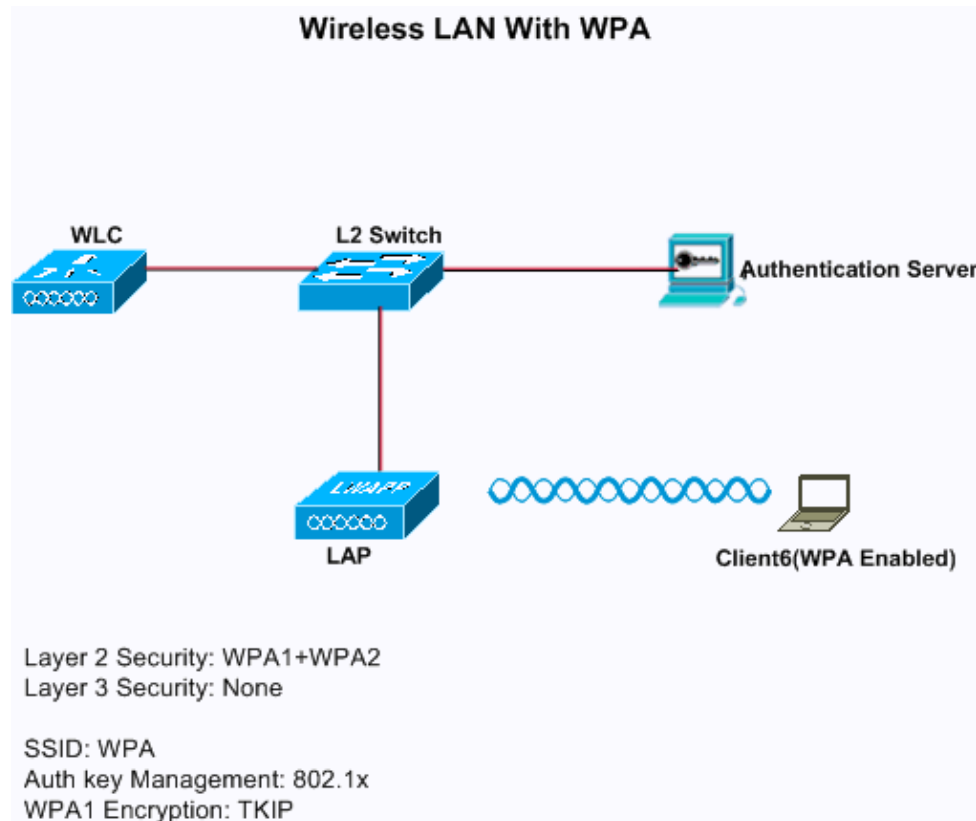

Configure the WLC for WPA

Complete these steps in order to configure the WLC for this setup:

1. Click **WLANS** from the controller GUI in order to create a WLAN.

The WLANs window appears. This window lists the WLANs configured on the controller.

2. Click **Go** in order to configure a new WLAN.

Choose the type and profile name. In this example, the WLAN is named *WPA*, and the WLAN ID is 5.



The screenshot shows the Cisco configuration interface for creating a new WLAN. The breadcrumb navigation is 'WLANs > New'. The form contains the following fields:

Type	WLAN
Profile Name	WLAN 5
SSID	WPA
ID	5

3. Click **Apply**.

4. In the WLAN > Edit window, define the parameters specific to the WLAN.

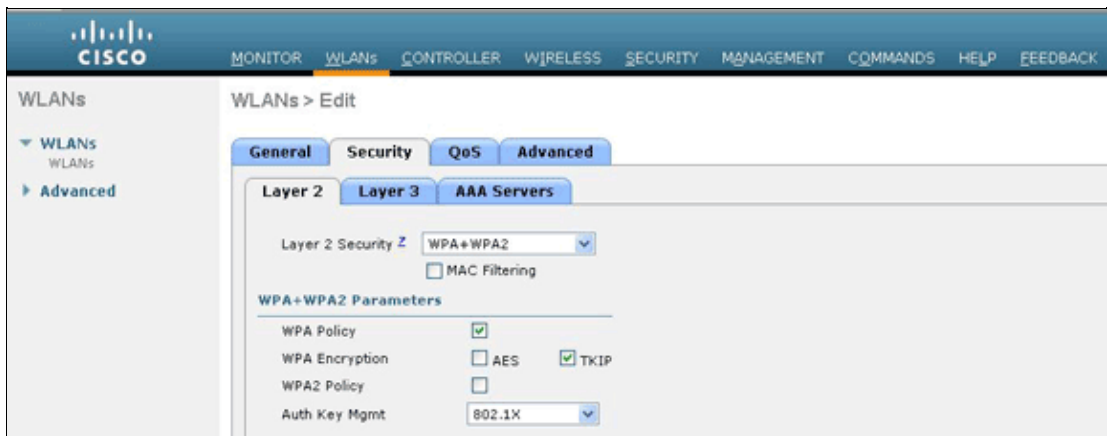

The screenshot shows the 'WLANs > Edit' configuration page. The 'Security' tab is selected, and the 'Layer 2' sub-tab is active. The configuration is as follows:

Layer 2 Security	WPA+WPA2
MAC Filtering	<input type="checkbox"/>
WPA Policy	<input checked="" type="checkbox"/>
WPA Encryption	<input type="checkbox"/> AES <input checked="" type="checkbox"/> TKIP
WPA2 Policy	<input type="checkbox"/>
Auth Key Mgmt	802.1X

- Click the **Security** tab, click the **Layer 2** tab, and choose **WPA1+WPA2** from the Layer 2 Security drop-down list.
- Under WPA1+WPA2 Parameters, check the **WPA1 Policy** check box in order to enable WPA1, check the **WPA2 Policy** check box in order to enable WPA2, or check both check boxes in order to enable both WPA1 and WPA2.

The default value is disabled for both WPA1 and WPA2. If you leave both WPA1 and WPA2 disabled, the access points advertise in their beacons and probe response information elements only for the authentication key management method you choose.

- Check the **AES** check box in order to enable AES data encryption or the **TKIP** check box in order to enable TKIP data encryption for WPA1, WPA2, or both.

The default values are TKIP for WPA1 and AES for WPA2.

- Choose one of these key management methods from the Auth Key Mgmt drop-down list:

- ◇ *802.1X* If you choose this option, only 802.1x clients are supported.
- ◇ *CCKM* If you choose this option, only CCKM clients are supported, where clients are directed to an external server for authentication.
- ◇ *PSK* If you choose this option, a pre-shared key is used for the WLC and client. Also, all standards are set to be used to before pre-standards; for example, WPA/WPA2 takes precedent over CCKM when used simultaneously.
- ◇ *802.1X+CCKM* If you choose this option, both CCKM or non-CCKM clients are supported (CCKM optional).

This example uses 802.1x.

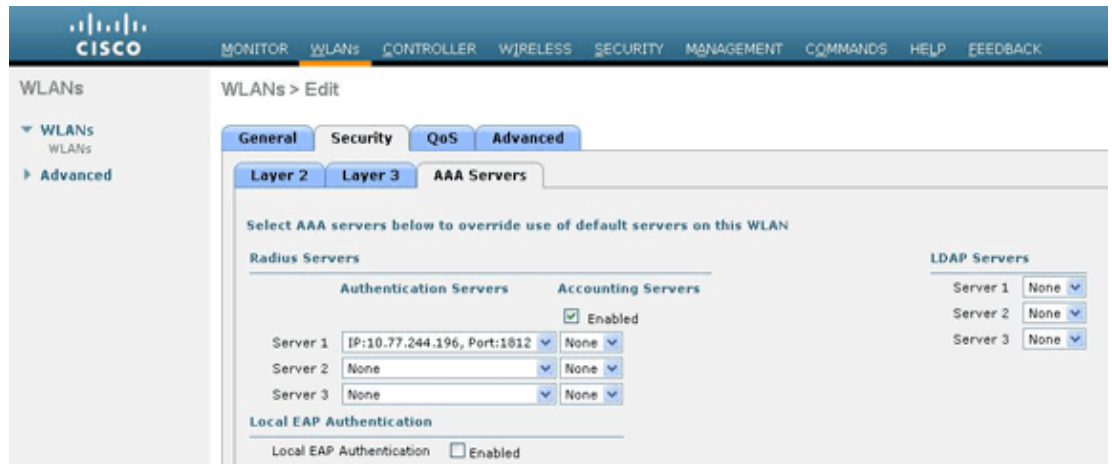

Note: If you choose PSK, choose **ascii** or **hex** from the PSK Format drop-down list, and then enter a pre-shared key in the blank field. WPA pre-shared keys must contain 8 to 63 ASCII text characters or 64 hex characters.

5. Click **Apply** in order to apply your changes.

Configure the Wireless Client for WPA

Complete these steps in order to configure the Wireless LAN client for this setup:

1. In the Profile Management window on the ADU, click **New** in order to create a new profile.
2. Click the **General** tab, and enter the profile name and the SSID that the client adapter will use.

In this example, the profile name and the SSID are *WPA*. The SSID must match the SSID that you configured on the WLC for WPA.

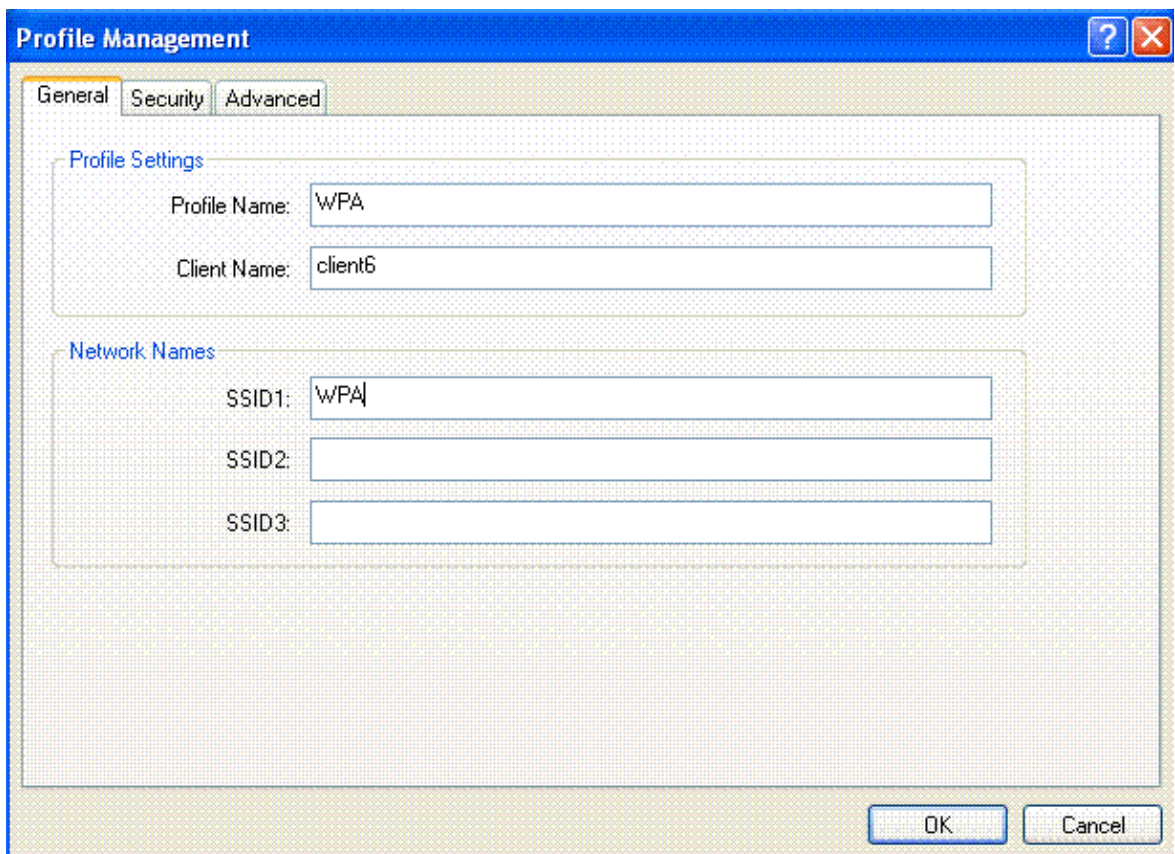

3. On the Security tab, click the **WPA/WPA2/CCKM** radio button, and choose the appropriate EAP type from the WPA/WPA2/CCKM EAP Type drop-down list. This step enables WPA.

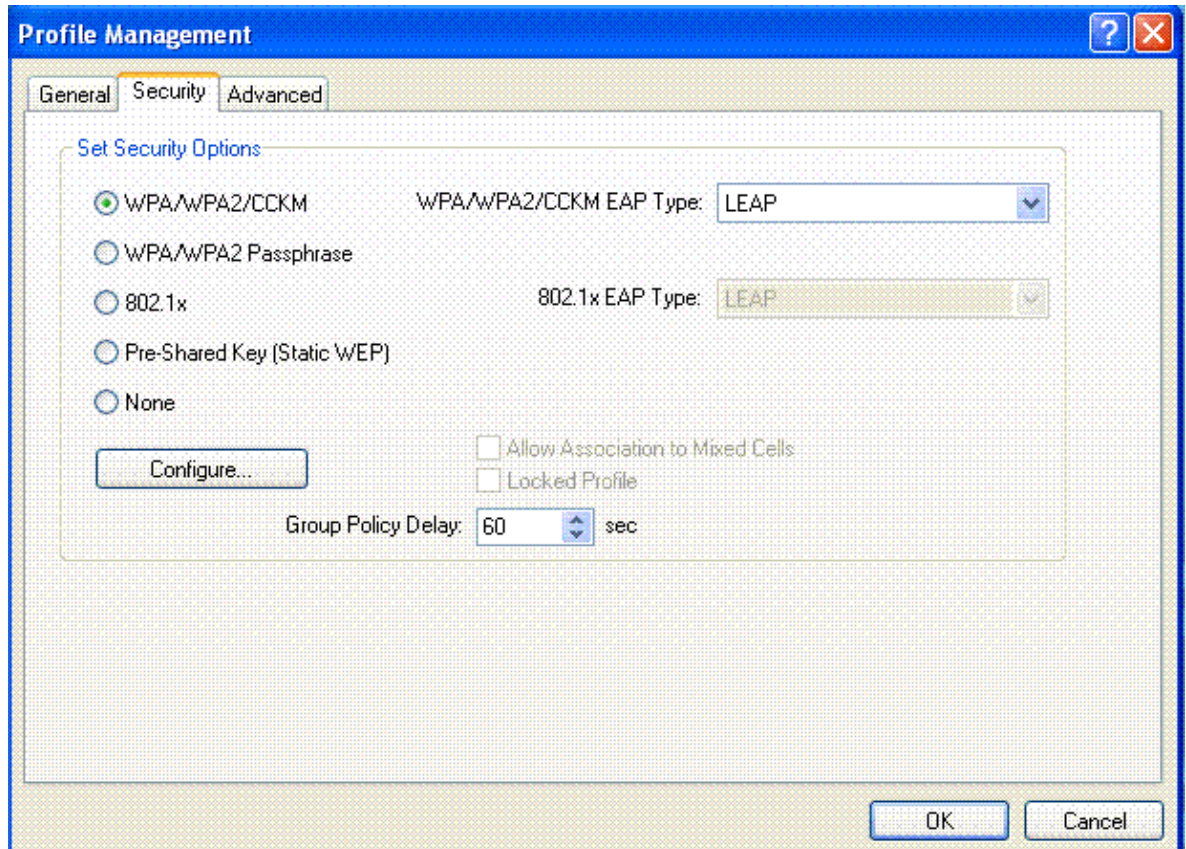

4. Click **Configure** in order to define the EAP settings specific to the type of EAP selected.

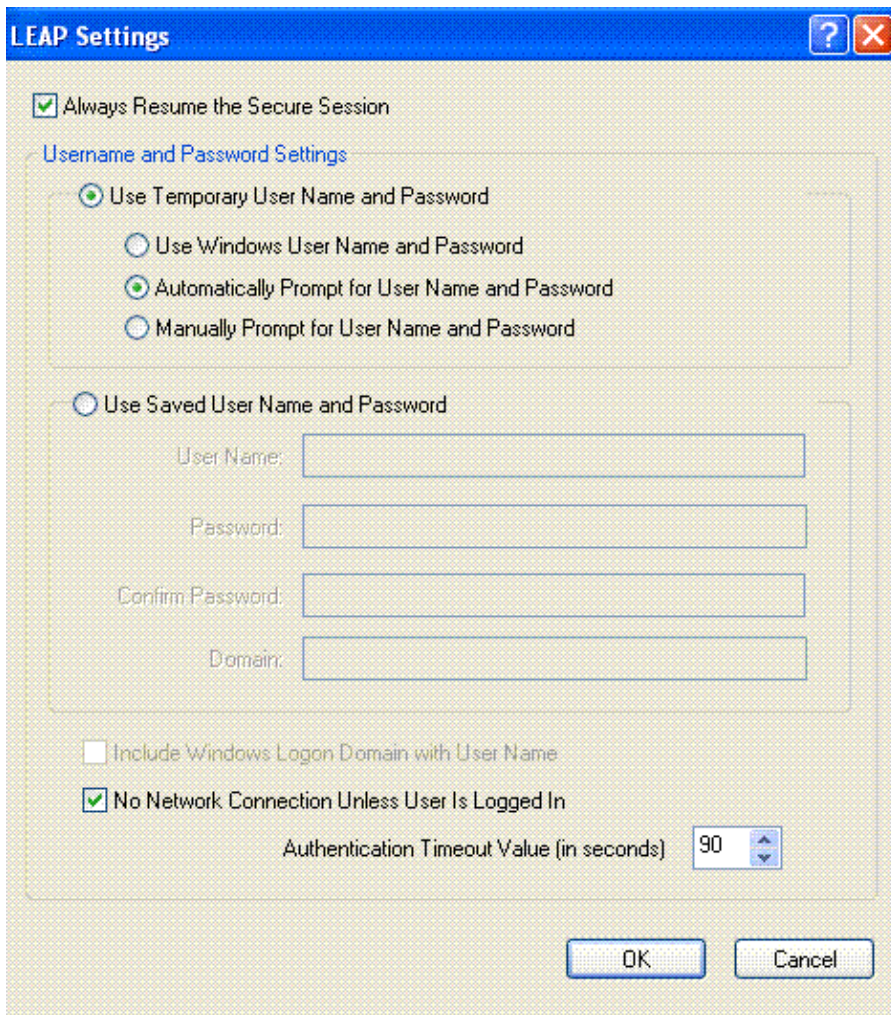

5. Click **OK**.

Note: When this profile is activated, the client is authenticated using 802.1x and when authentication is successful, the client connects to the WLAN. Check the ADU Current Status in order to verify that the client uses TKIP encryption (default encryption used by WPA1) and EAP authentication.

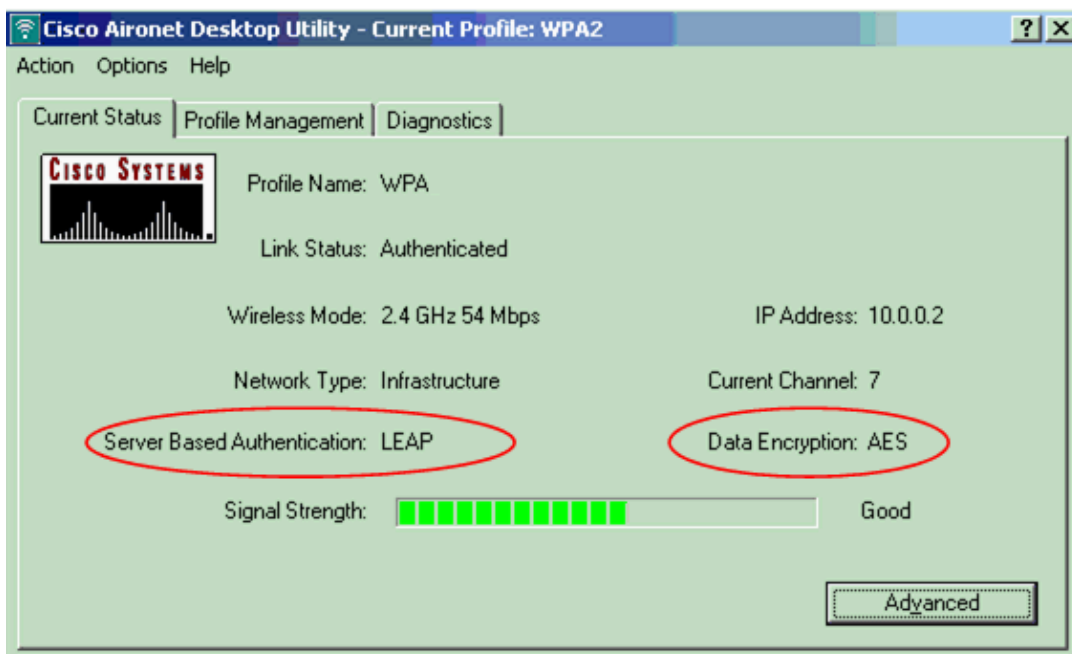

CKIP

This example shows a WLAN configured with CKIP.

Wireless LAN With CKIP

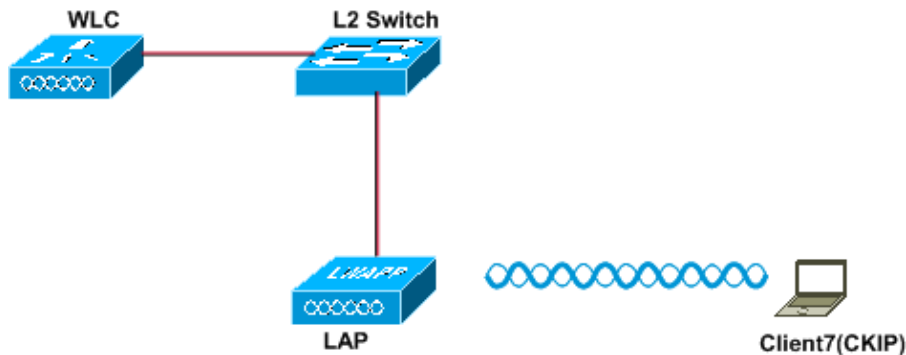

Layer 2 Security: CKIP
Layer 3 Security: None
SSID: CKIP

Configure the WLC for CKIP

Complete these steps in order to configure the WLC for this setup:

1. Click **WLANs** from the controller GUI in order to create a WLAN.

The WLANs window appears. This window lists the WLANs configured on the controller.

2. Click **New** in order to configure a new WLAN.

Choose the type and profile name. In this example, the WLAN is named *CKIP* and the WLAN ID is 6.

The screenshot shows the Cisco WLC GUI with the 'WLANs > New' configuration window. The 'Type' dropdown is set to 'WLAN', the 'Profile Name' is 'WLAN 6', the 'SSID' is 'CKIP', and the 'ID' dropdown is set to '6'. The 'Advanced' tab is selected in the left sidebar.

3. In the WLAN > Edit window, define the parameters specific to the WLAN.

- a. From the Layer 2 drop-down list, choose **CKIP**.

This step enables CKIP for this WLAN.

- b. Under the CKIP parameters, select the key size and key index, and enter the static encryption key.

The key size can be either 40 bits, 104 bits, or 128 bits. The key index can be between 1 and 4. One unique WEP key index can be applied to each WLAN. Because there are only four WEP key indexes, only four WLANs can be configured for static WEP Layer 2 encryption.

c. For CKIP, choose the **MMH Mode** option, or the **Key Permutation** option, or both.

Note: Either one of these parameters or both should be selected for CKIP to work as expected. If these parameters are not selected, the WLAN stays in the disabled state.

In this example, 104 bit key is used, and the key is 1234567890abc.

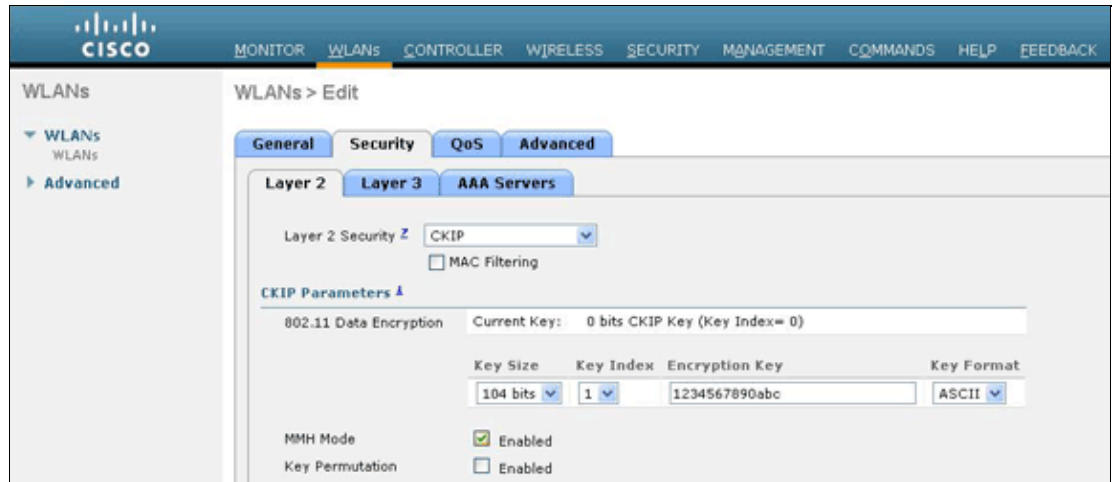

4. Choose other parameters based on your design requirements.

This example uses the default values.

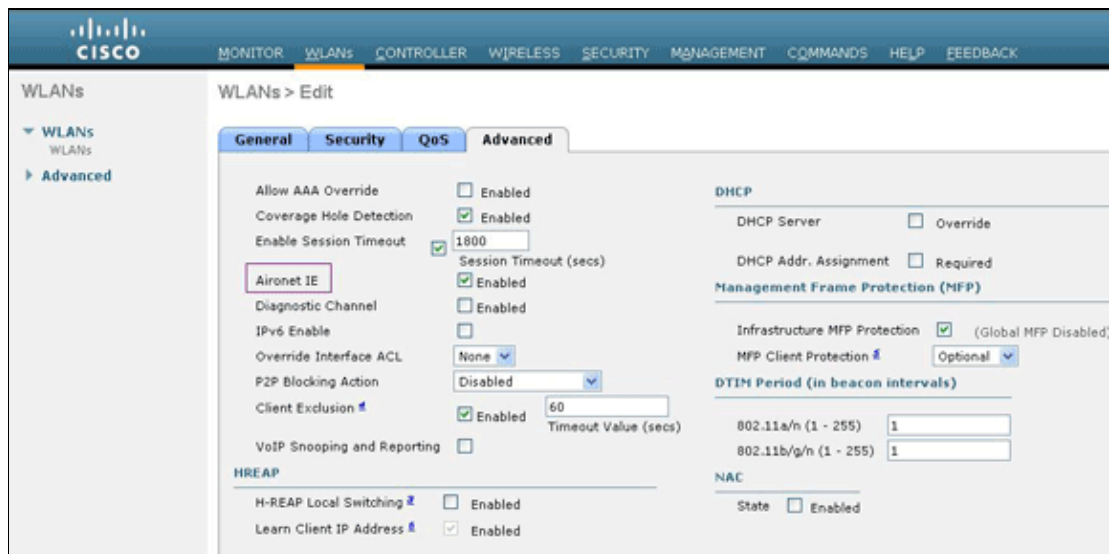

5. Click **Apply**.

Note: CKIP is functional on the 1100, 1130, and 1200 APs, but not AP 1000. Aironet IE needs to be enabled for this feature to work. CKIP expands the encryption keys to 16 bytes.

Configure the Wireless Client for CKIP

Complete these steps in order to configure the Wireless LAN Client for this setup:

1. In order to create a new profile, click the **Profile Management** tab on the ADU, and then click **New**.

2. When the Profile Management (General) window displays, complete these steps in order to set the profile name, client name, and SSID:

a. Enter the name of the profile in the Profile Name field.

This example uses *CKIP* as the profile name.

b. Enter the name of the client in the Client Name field.

The client name is used to identify the wireless client in the WLAN network. This configuration uses *Client6* for the client name.

c. Under Network Names, enter the SSID that is to be used for this Profile.

The SSID is the same as the SSID that you configured on the WLC. The SSID in this example is *CKIP*.

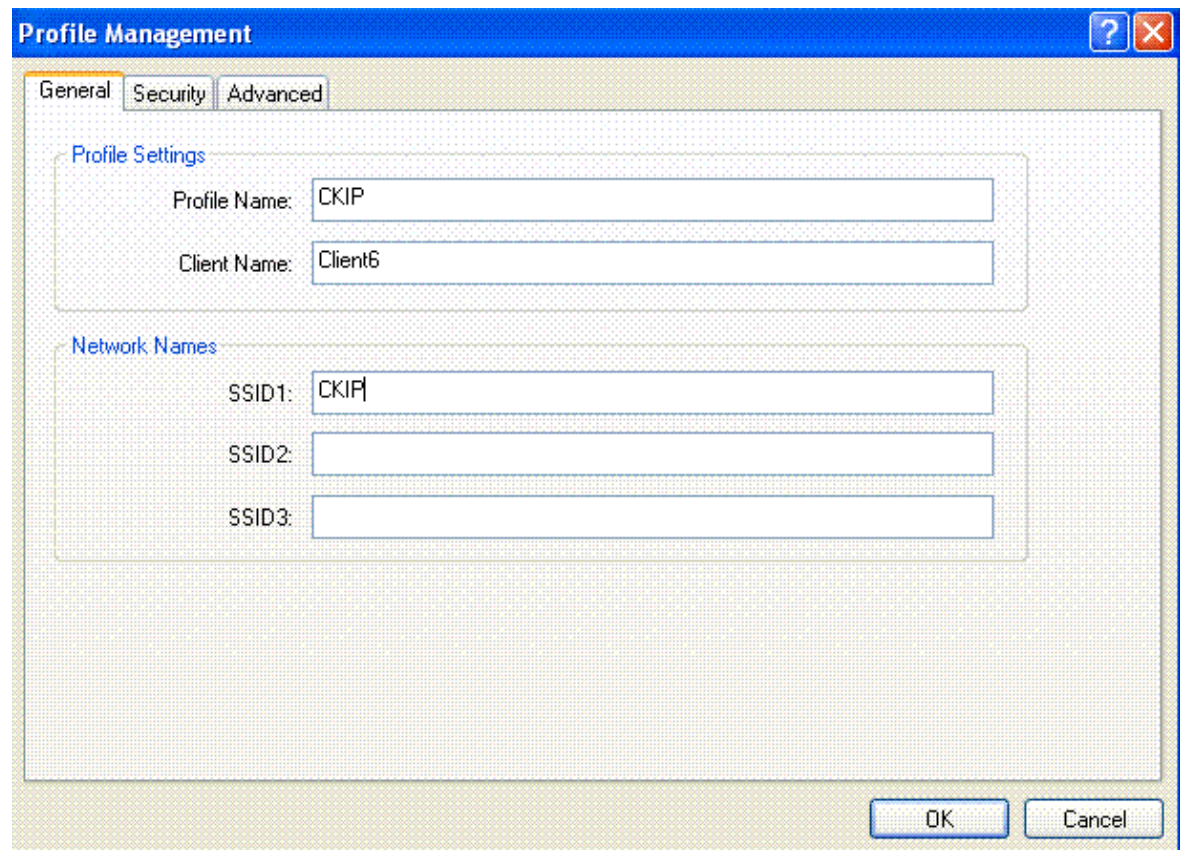

The screenshot shows the 'Profile Management' dialog box with the 'General' tab selected. The 'Profile Settings' section contains two text input fields: 'Profile Name' with the value 'CKIP' and 'Client Name' with the value 'Client6'. The 'Network Names' section contains three text input fields: 'SSID1' with the value 'CKIP', 'SSID2' which is empty, and 'SSID3' which is empty. At the bottom right, there are 'OK' and 'Cancel' buttons.

3. Click the **Security** tab.

4. Choose **Pre-Shared Key (Static WEP)** under Set Security Options, click **Configure**, and define the WEP key size and the WEP key.

These values should match with the WEP key configured on the WLC for this WLAN.

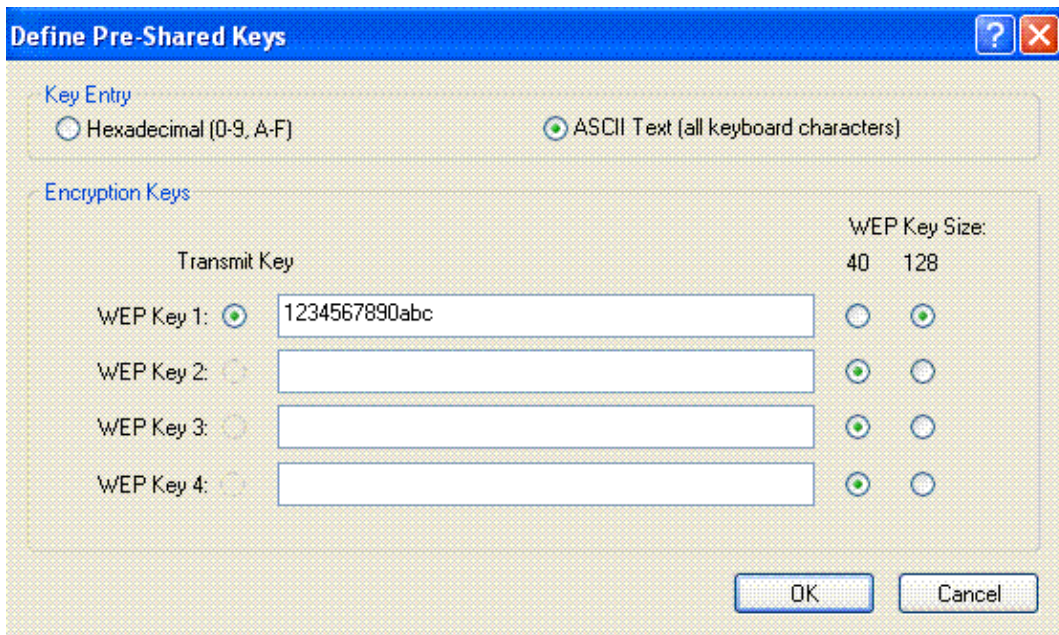
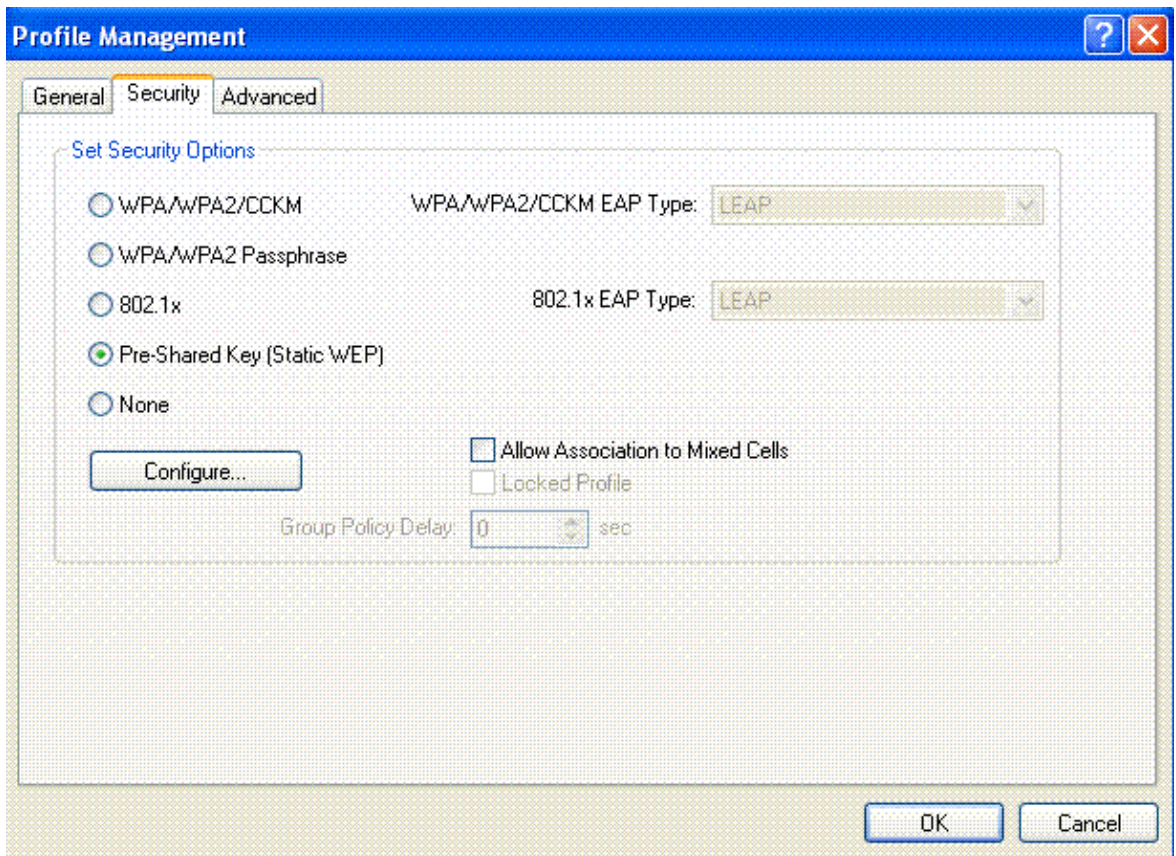

5. Click **OK**.

When the SSID is activated, the wireless client negotiates with the LAP and WLC to use CKIP for encryption the packets.

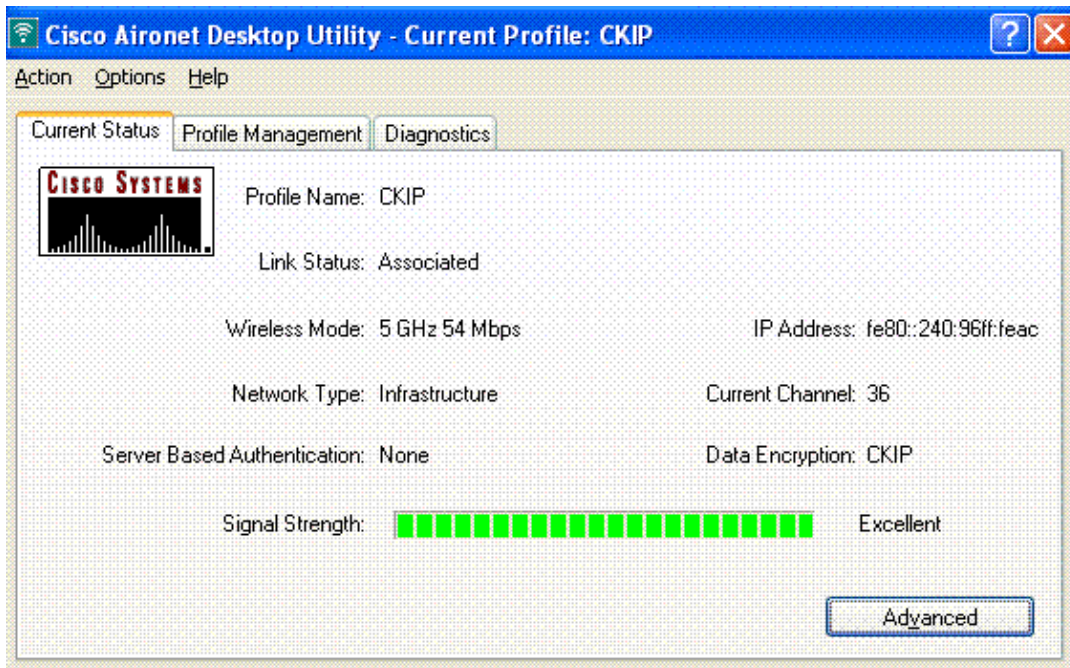

Layer 3 Security Solutions

Web Policy (Web Authentication and Web Passthrough)

Refer to Wireless LAN Controller Web Authentication Configuration Example for information on how to enable web authentication in a WLAN network.

Refer to External Web Authentication with Wireless LAN Controllers Configuration Example for information on how to configure external web authentication and web passthrough authentication in a WLAN.

Refer to Wireless LAN Controller Web Passthrough Configuration Example for more information on how to enable web passthrough in a WLAN network.

The Splash Page mechanism is a Layer 3 security mechanism introduced in WLC Version 5.0 used for client authentication. Refer to Wireless LAN Controller Splash Page Redirect Configuration Example for more information.

VPN Passthrough

Refer to Client VPN over Wireless LAN with WLC Configuration Example for information on how to configure VPN passthrough in a WLAN.

Troubleshoot

Troubleshooting Commands

You can use these **debug** commands to troubleshoot your configuration.

Debugs for Web Authentication:

- **debug mac addr** <client-MAC-address xx:xx:xx:xx:xx:xx> Configures MAC address debugging for the client.
- **debug aaa all enable** Configures debugging of all AAA messages.

- **debug pem state enable** Configures debug of policy manager State Machine
- **debug pem events enable** Configures debug of policy manager events.
- **debug dhcp message enable** Use this command in order to display debugging information about the Dynamic Host Configuration Protocol (DHCP) client activities and to monitor the status of DHCP packets.
- **debug dhcp packet enable** Use this command in order to display DHCP packet level information.
- **debug pm ssh–appgw enable** Configures debug of application gateways.
- **debug pm ssh–tcp enable** Configures debug of policy manager tcp handling

Debugs for WEP: No debug for WEP because it is performed at the AP, turn on **debug dot11 all enable**.

Debugs for 802.1X/WPA/RSN/PMK caching:

- **debug mac addr <client–MAC–address xx:xx:xx:xx:xx:xx>** Configures MAC address debugging for the client.
- **debug dot1x all enable** Use this command in order to display 802.1X debugging information.
- **debug dot11 all enable** Use this command in order to enable debugging of radio functions.
- **debug pem events enable** Configures debug of policy manager events.
- **debug pem state enable** Configures debug of policy manager State Machine.
- **debug dhcp message enable** Use this command in order to display debugging information about the Dynamic Host Configuration Protocol (DHCP) client activities and to monitor the status of DHCP packets.
- **debug dhcp packet enable** Use this command in order to display DHCP packet level information.
- **debug mobility handoff enable (for intra–switch roaming)** Configures debug of Mobility packets.
- **show client detail <mac>** Displays detailed information for a client by mac address. Check the WLAN and RADIUS session timeout configuration.

Related Information

- **Restrict WLAN Access based on SSID with WLC and Cisco Secure ACS Configuration Example**
 - **ACLs on Wireless LAN Controller Configuration Example**
 - **Cisco Wireless LAN Controller Configuration Guide, Release 4.0**
 - **Wireless Support Page**
 - **Technical Support & Documentation – Cisco Systems**
-

[Contacts & Feedback](#) | [Help](#) | [Site Map](#)

© 2009 – 2010 Cisco Systems, Inc. All rights reserved. [Terms & Conditions](#) | [Privacy Statement](#) | [Cookie Policy](#) | [Trademarks of Cisco Systems, Inc.](#)

Updated: Jul 09, 2010

Document ID: 82135
