

## Model 6944 Four Port Optoelectronic Node 870 MHz with 65/86 MHz Split

### Description

The Model 6944 Node is Scientific-Atlanta's latest generation 870 MHz optical node platform. This platform allows independent segmentation or redundancy for both the forward and reverse paths in a reliable, cost effective package.

The forward path of the Model 6944 Node can be initially deployed as a broadcast 1310/1550 nm optical receiver with common services distributed to either four outputs (all high level) or six outputs (two high level and four lower level). Forward segmentation can be implemented via use of additional optical receivers, to provide unique broadcast services at each of the high level ports.

The Model 6944 Node's reverse path is equally flexible. Reverse traffic can be combined and routed to FP or DFB reverse transmitters, and redundant (back-up) transmitters may also be utilized. The platform provides for reverse segmentation through the addition of transmitters. Up to four transmitters - one per reverse input port - can be configured using the eight position optical interface board. Where fiber counts are limited, the six-position optical interface module allows for space to add advanced Baseband Digital Reverse, reverse path segmentation technology using Scientific-Atlanta's bdr™ system. The six-position optical interface board has two transmitter mounting positions. If the reverse path is not segmented, one position is used for the primary reverse transmitter and the other for an optional redundant transmitter. For dual reverse segmentation, two transmitters are installed, each dedicated to reverse traffic from a pair of station reverse input ports.

The Model 6944 Node RF launch amplifier module is common to all configurations from the most basic to a fully featured, forward and reverse segmented node. The forward path of the RF launch amplifier includes four high level distribution outputs. Utilizing a plug-in splitter, the outputs for ports one and six can be split and routed to ports two and five respectively, thereby providing six output ports, two high level and four lower level. The reverse path in the RF launch amplifier module is passive. Each of the four reverse path inputs includes a plug-in location for an optional three state reverse switch.

There are three forward configuration modules for the Model 6944 Node, each specific to the level of forward path segmentation desired. When the forward path of the node is not segmented, a standard forward configuration module is utilized, and the four station output ports are fed from a common receiver. A dual forward segmentation module is utilized when two receivers are installed - with each providing unique broadcast services to a pair of station output ports. A quad forward segmentation module is utilized when four receivers are installed - with each providing unique broadcast services to one of four dedicated station output ports.

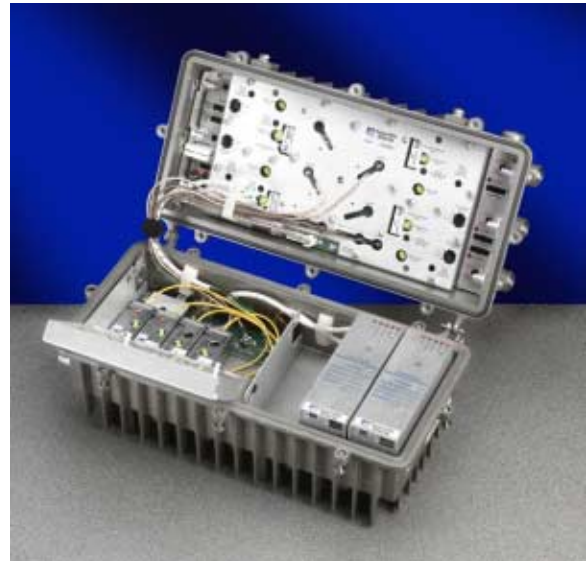

# Model 6944 Four Port Optoelectronic Node – 5-65/86-870 MHz



## Features

- Six port 1 GHz RF platform
- 15 ampere continuous power passing
- Independent scalability of forward and reverse path
- Reverse segmentation capable in fiber limited systems with bdr™ digital reverse
- Reverse four port (quad) segmentation with four optical transmitters
- Reverse two port (dual) segmentation with two optical transmitters (redundancy optional)
- Forward four port (quad) segmentation with four 1310/1550 nm optical receivers
- Forward two port (dual) segmentation with two 1310/1550 nm optical receivers (redundancy optional)
- Standard fiber management tray (9") provides fiber and connector storage for up to 6 connector pairs
- Extended fiber management tray (12") provides fiber and connector storage for up to 12 connector pairs and room for mounting WDM's and couplers
- Screwless seizures for ease of connector installation
- 40 to 90 V AC high efficiency switch mode power supply
- Optional power supply redundancy
- Local test points and LED indicators on optical receivers and transmitters simplify installation and maintenance
- Optional status monitoring and control (TNCS or other compatible element management system required)
- Optional 3-state reverse switch (on/off/-6 dB) allows each reverse input to be isolated for noise and ingress troubleshooting (status monitoring required)

# Model 6944 Four Port Optoelectronic Node – 5-65/86-870 MHz



**No Segmentation**

**One Forward Optical Receiver and One Reverse Optical Transmitter**

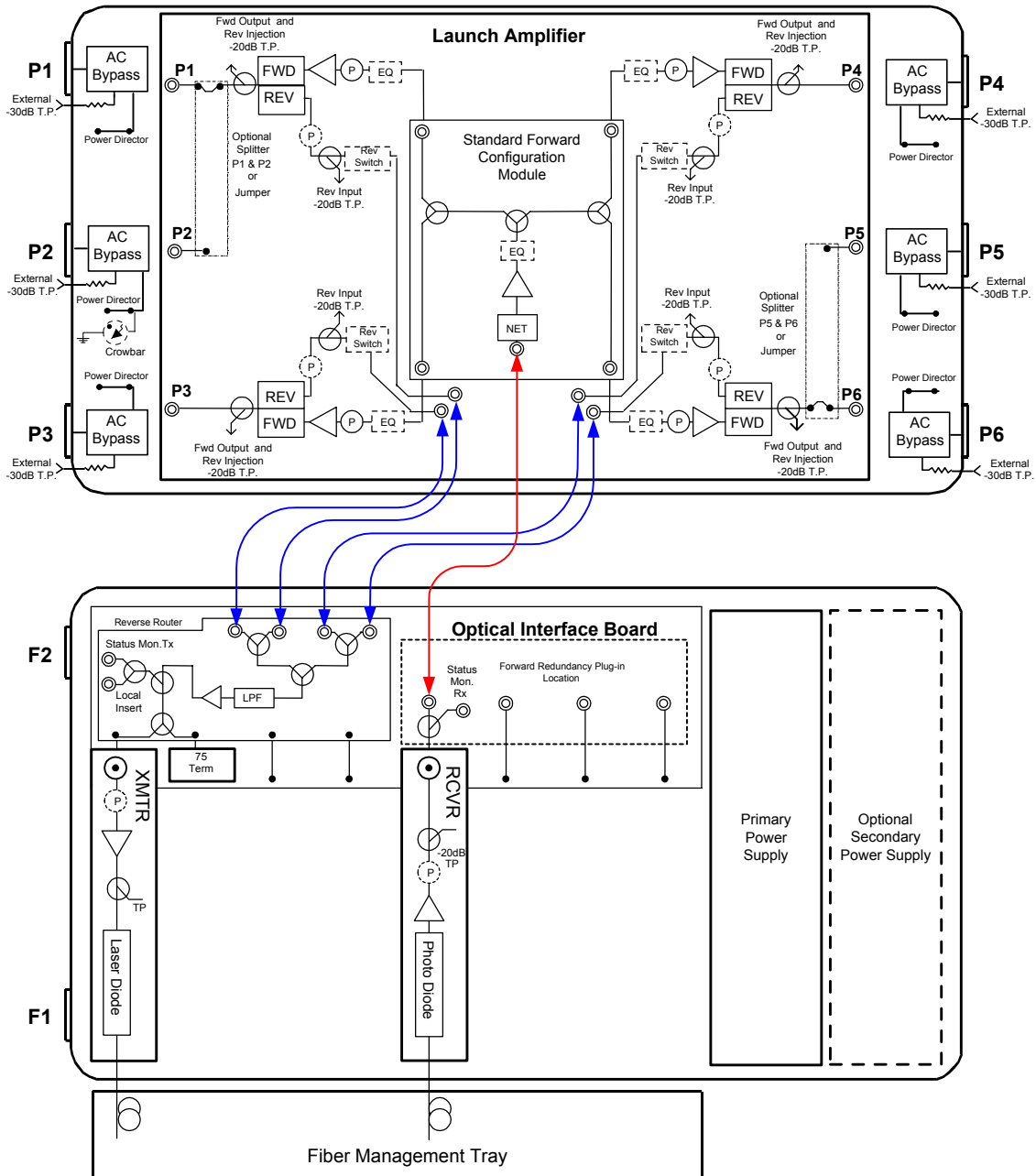

## Dual Forward and Dual Reverse Segmentation

### Two Forward Optical Receivers and Two Reverse Optical Transmitters

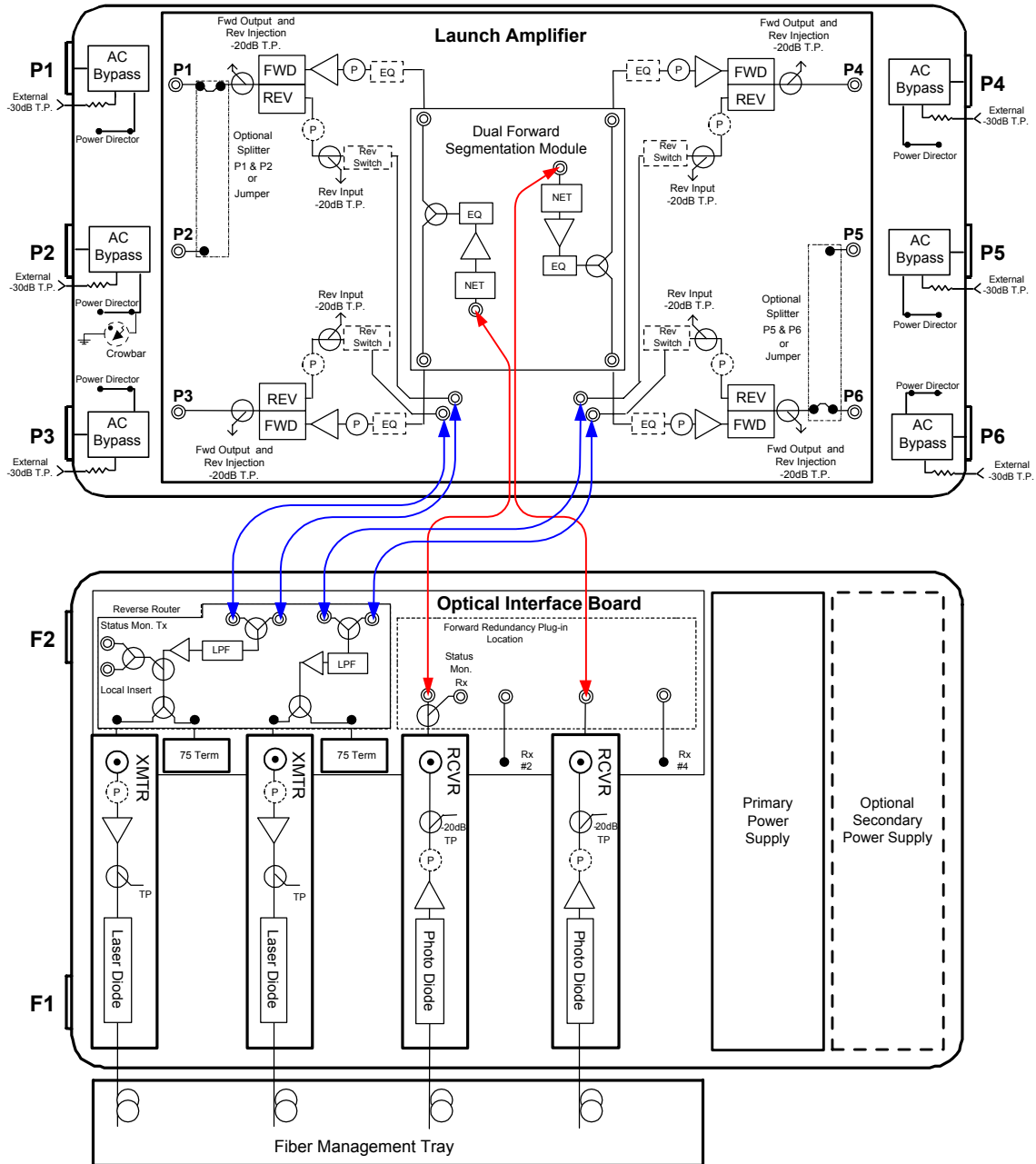

## Quad Forward and Quad Reverse Segmentation

### Four Forward Optical Receivers and Four Reverse Optical Transmitters

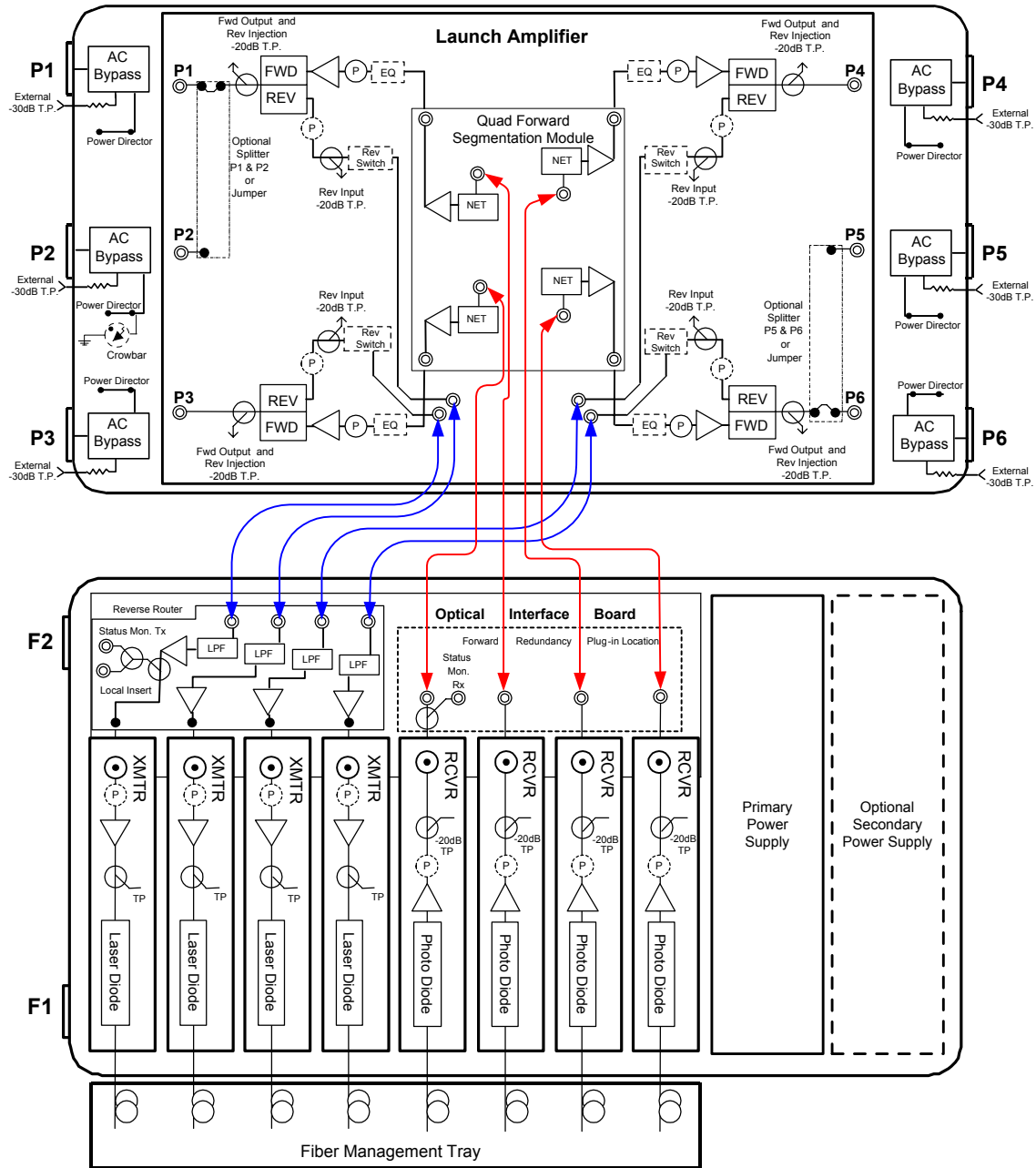

## Six Position Optical Interface Board with Forward and Reverse Plug-In Modules

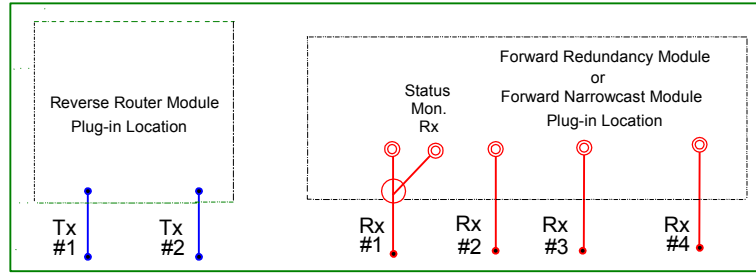

p/n 591129  
6 Position Optical Interface Board for 6944 (installed in housing lid)

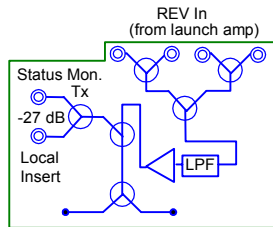

p/n 591162  
Standard (1X) Reverse Router Module  
(Two Wide) 5-65 MHz  
(used when reverse segmentation is not needed,  
allows redundancy)

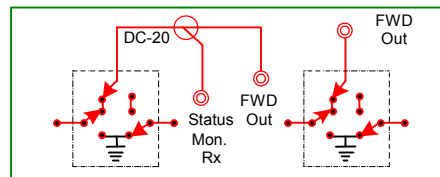

p/n 591148  
Forward Redundancy Module  
(used for redundancy with either dual or no segmentation)

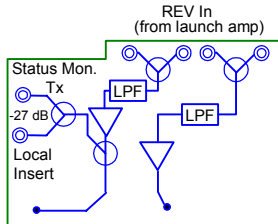

p/n 591165  
Dual Segmentation (2X) Reverse Router Module  
(Two Wide) 5-65 MHz  
(no redundancy)

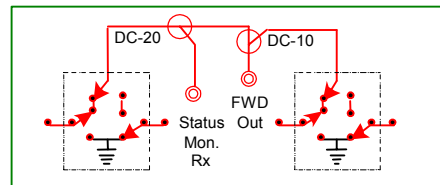

p/n 591150  
Forward Narrowcast (Tiering) Module  
(used for combining broadcast and narrowcast RX outputs,  
allows redundancy)

## Eight Position Optical Interface Board with Forward and Reverse Plug-in Modules

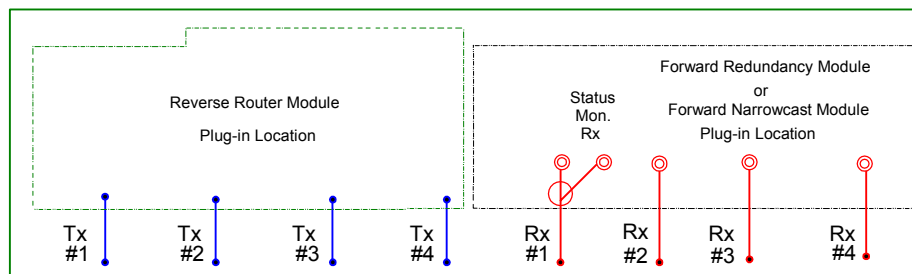

p/n 590946  
8 Position Optical Interface Board for 6944 (Installed in housing lid)

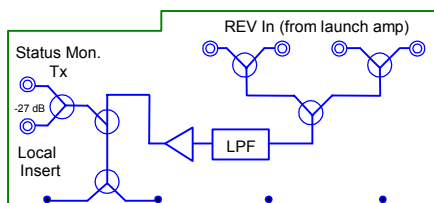

p/n 591153  
Standard (1X) Reverse Router Module  
(Four Wide) 5-65 MHz  
(used when reverse segmentation is not needed,  
allows redundancy)

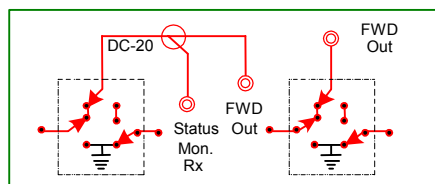

p/n 591148  
Forward Redundancy Module  
(used for redundancy with either dual or no segmentation)

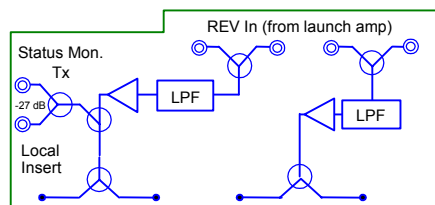

p/n 591156  
Dual Segmentation (2X) Reverse Router Module  
(Four Wide), 5-65 MHz  
(allows redundancy)

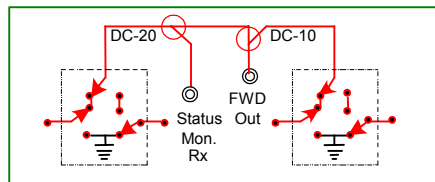

p/n 591150  
Forward Narrowcast (Tiering) Module  
(used for combining broadcast and narrowcast RX outputs,  
allows redundancy)

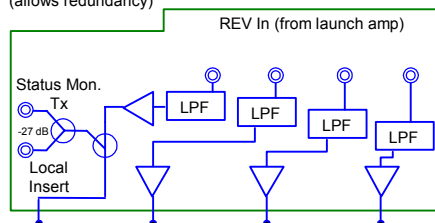

p/n 591159  
Quad Segmentation (4X) Reverse Router Module  
(Four Wide) 5-65 MHz  
(no redundancy)



## Optical Section Specifications

Optical Section - Forward Receiver Module	Units	6944 Standard RX	Notes
Wavelength	nm	1310 and 1550	
Optical Input Range	mW dBm	0.5 to 1.6 -3 to + 2	
Pass Band	MHz	52-870	
Frequency Response	dB	± 0.75	1
Tilt (± 1.5 dB)	dB	0	
Optical Input Test Point (± 20%)	V DC	1V/mW	
Optical Input Power Threshold for Rx On/Off (for Rx Redundancy)	dBm	-4 / -6	3
RF Output Level @ 0 dBm Optical Input	dBmV	Refer to chart (below)	2
RF Output Test Point (± 1.0 dB)	dB	- 20	

**Receiver RF Output Level Vs Transmitter OMI  
(using Standard Receiver)**

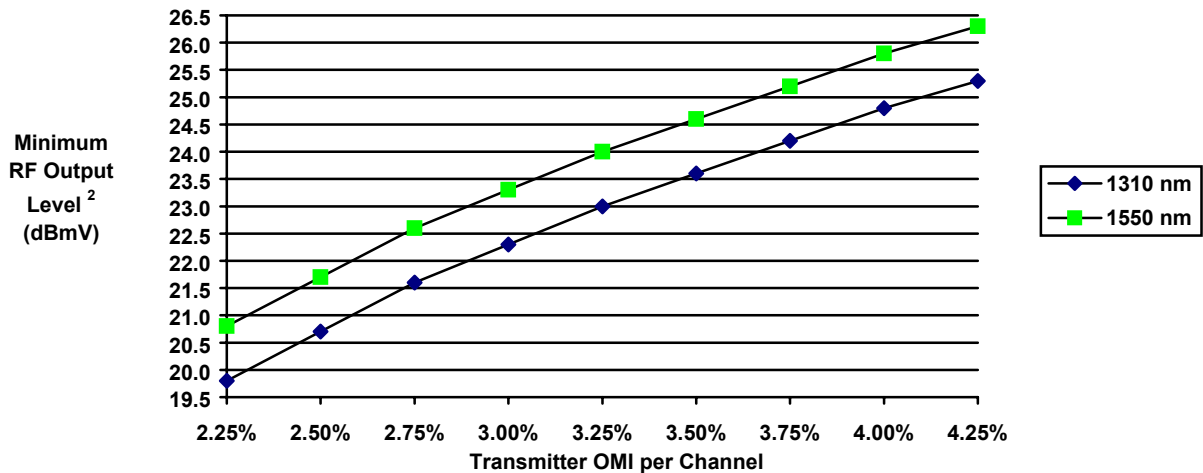

**Notes for Optical Section Specifications:**

1. For forward receiver module only. Does not include frequency response contributions from forward optical transmitter.
2. Minimum receiver RF output level for the stated transmitter percent OMI/ch. (Optical Modulation Index per channel), with receiver optical input power of 0 dBm. To determine RF output levels at other optical input power, add (or subtract) 2 dB in RF level for each 1 dB increase (or decrease) in receiver optical input power.
3. Redundant Control Module (RCM) or status monitoring transponder is required for Rx redundancy. Threshold stated is for RCM. Threshold is adjustable via element management software if Transponder is used (TNCS or equivalent). Optical input power below the "Off" threshold causes an RF switch from Primary Rx to Redundant Rx. Optical input power above the "On" threshold causes an RF switch back to Primary Rx.

*For reverse optical transmitter and link performance, see the "Analog Reverse Optical Transmitters for Model 6940/6944 and GainMaker® Optoelectronic Stations" data sheet, and the Model 6940/44 bdr data sheet(s).*

Unless otherwise noted, the above specifications reflect typical station performance at stated reference levels in the recommended operating configuration(s). Unless otherwise noted, specifications are based on measurements made in accordance with NCTA Recommended Practices for Measurements on Cable Television Systems using standard frequency assignments and are referenced to (20°C) 68°F.

# Model 6944 Four Port Optoelectronic Node – 5-65/86-870 MHz



## RF Section Specifications

General Station Performance	Units	Forward	Reverse	Notes
Pass Band	MHz	86-870	5-65	
Return Loss	dB	16	16	21
Fwd Port to Port Isolation (with jumper)	dB	86 – 550 MHz 551 – 870 MHz	60 50	see Reverse Station Performance 12,13
Fwd Port to Port Isolation (with splitter)	db	86 – 550 MHz 551 – 870 MHz	60 40	see Reverse Station Performance 13
Hum Modulation @ 12 A	dB	70 (86-750 MHz)	60 (5-10 MHz)	
	dB	65 (751-870 MHz)	65 (11-65 MHz)	
Hum Modulation @ 15 A	dB	65 (86-750 MHz)	60 (5-10 MHz)	
	dB	60 (751-870 MHz)	65 (11-65 MHz)	
Internal RF Test Points ( $\pm 1.0$ dB)	dB	-20	-20	
External RF Test Points ( $\pm 1.5$ dB)	dB	-30	-30	

Launch Amplifier Performance - Forward	Units	Forward	Notes	
Amplifier Type	--	PHD		
Operational Gain (minimum)	dB	26	4,12	
Frequency Response	dB	$\pm 0.5$ dB	12	
Internal Tilt ( $\pm 1$ dB)	dB	+10	1,3	
Noise Figure @...	dB	870 MHz 750 MHz 650 MHz 550 MHz 86 MHz	9.5 10 11 12.5 19	2
Reference Output Levels @...	dBmV	870 MHz 750 MHz 650 MHz 550 MHz 86 MHz	47.5 45.7 44 42.5 35.5	
Reference Output Tilt (86-870 MHz)	dB	12	1,5	
<b>64 PAL B/G Channels (CW) with digital</b>			16	
Composite Triple Beat	dB	76	6	
Cross Modulation	dB	72	6	
Composite Second Order (high side)	dB	70	6	
<b>64 PAL I Channels (CW) with digital</b>			17	
Composite Beat	dB	71	6	
Cross Modulation	dB	72	6	
<b>42 CENELEC Channels (CW)</b>			19	
Composite Triple Beat	dBuV	111.5	6	
Cross Modulation	dBuV	112	6	
Composite Second Order (high side)	dBuV	114	6	
<b>78 NTSC channels (CW) with digital</b>			15	
Composite Triple Beat	dB	74	6	
Cross Modulation	dB	71	6	
Composite Second Order (high side)	dB	71	6	

Forward Insertion Loss	Units	with no Module installed	with Redundancy Module installed	with Narrowcast Module installed	Notes
<b>Optical Interface Board and Plug-Ins</b> (Loss from specified optical receiver RF output to launch amplifier RF input)					
Receiver position 1	dB	-1.0	-2.5	-2.5	18
Receiver position 2	dB	0	-1.5	-2.5	18
Receiver position 3 and 4	dB	0	-0.5	-12.0	18

Unless otherwise noted, the above specifications reflect typical station performance at stated reference levels in the recommended operating configuration(s). Unless otherwise noted, specifications are based on measurements made in accordance with NCTA Recommended Practices for Measurements on Cable Television Systems using standard frequency assignments and are referenced to (20°C) 68°F.

# Model 6944 Four Port Optoelectronic Node – 5-65/86-870 MHz



## RF Section Specifications, continued

Launch Amplifier Performance - Reverse	Units	Reverse	Notes
Frequency Response	dB	+/- 0.5	11
Internal Tilt (+/- 1 dB)	dB	-0.5	11
Insertion Loss	dB	- 3.5	8,11

Station Performance - Reverse (Station port input to optical transmitter input)	Units	With no segmentation	with Dual segmentation	with Quad segmentation	Notes
Amplifier Type	--	PP	PP	PP	
Path to Path Isolation	dB	na	>50	>48	14
Insertion loss	dB	-3	-3	-3	9,11
Noise Figure	dB	14.5	14.5	14.5	10,11
<b>CENELEC Distortions</b>					
Discrete Third Order	dBuV	110	110	110	7,19,20
Discrete Second Order	dBuV	102	102	102	7,19,20

Station Delay Characteristics			
Forward (Chrominance to Luminance Delay)		Reverse (Group Delay in 1.5 MHz BW)	
Frequency (MHz)	Delay (nS)	Frequency (MHz)	Delay (nS)
91.25 - 94.83	8	5.0 - 6.5	46
97.25 - 100.83	5	6.5 - 8.0	25
103.25 - 106.83	3	8.0 - 9.5	13
112.25 - 116.68	3	60.5 - 62.0	10
		62.0 - 63.5	12
		63.5 - 65.0	15

Unless otherwise noted, the above specifications reflect typical station performance at stated reference levels in the recommended operating configuration(s). Unless otherwise noted, specifications are based on measurements made in accordance with NCTA Recommended Practices for Measurements on Cable Television Systems using standard frequency assignments and are referenced to (20°C) 68°F.

## RF Section Specifications, continued

### Notes for RF Section Specifications:

1. Reference output tilt and internal tilt are both "Linear" tilt.
2. Launch amplifier forward noise figure specified with interstage equalizer (ISEQ) installed to achieve reference tilt.
3. Forward internal tilt specified with factory installed 0 dB interstage equalizer (ISEQ).
4. Launch amplifier forward gain from RF input to station output port, with (ISEQ) installed to achieve reference tilt. Stated gain applies for all forward segmentation configurations.
5. The forward reference output tilt specified is achieved via field installation of appropriate ISEQ, in conjunction with the internal tilt of the launch amplifier and the tilt associated with the optical link (transmitter/receiver combination).
6. Station performance can be determined by combining optic performance and launch amplifier performance. Stated distortion performance is for launch amplifier section operated at reference output levels and tilt.
7. RF level at the RF input to the optical transmitter (RF output of specified reverse plug-in module).
8. Launch amplifier reverse insertion loss from station reverse input(s) to launch amplifier reverse output. Launch amplifier module has passive loss only in the reverse path (no gain stage).
9. Station reverse insertion loss from station reverse input(s) to the RF input of the optical transmitter (RF output of the specified reverse plug-in module).
10. Reverse noise figure at station input, with specified degree of reverse segmentation (appropriate reverse plug-in module installed in optical interface board) and 0 dB reverse input pad in launch amplifier.
11. All reverse specifications are with reverse switch installed.
12. With jumper installed in launch amplifier RF signal director location(s).
13. Forward port to port isolation is specified as the isolation between any two ports that are configured to be on separate segmentation paths. This is the minimum loss that a forward signal measured at any output port will incur if measured at an alternate (undriven) port.
14. Reverse path to path isolation is specified as the isolation between any two reverse paths that are configured as separate segmentation paths. This is the minimum loss that a reverse signal present at the input of any optical transmitter will incur if measured at an alternate (undriven) transmitter input.
15. Loaded with 78 NTSC carriers from 91 – 550 MHz. "Digital" refers to 550 - 870 MHz loading with 52 QAM carriers at -6 dB relative to analog video carrier levels.
16. Loaded with 64 PAL B/G carriers from 112 – 600 MHz. "Digital" refers to 600 - 870 MHz loading with 45 QAM carriers at -6 dB relative to analog video carrier levels.
17. Loaded with 64 PAL I carriers from 88 – 600 MHz. "Digital" refers to 600 - 870 MHz loading with 45 QAM carriers at -6 dB relative to analog video carrier levels.
18. Insertion loss from optical receiver RF output to launch amplifier RF input, with specified forward plug-in module installed in the optical interface board. Subtract this loss from the launch amplifier operational gain to determine forward station gain from optical receiver output to station output.
19. Tested per CENELEC Standard EN50083-3. RF output level associated with -60 dBc distortion is specified.
20. Typical reverse RF level is < 80 dBuV.
21. Model 6944 Node with bdr has minimum reverse return loss of 15 dB.

# Model 6944 Four Port Optoelectronic Node – 5-65/86-870 MHz



## Specifications

Electrical	Units				Notes
Max. AC Through Current (continuous)	Amps	15			
Max. AC Through Current (surge)	Amps	25			
<b>Component DC Power Consumption (typical)</b>		<b>@ +24 VDC</b>	<b>@ +15 VDC</b>	<b>@ -6 VDC</b>	<b>1</b>
Launch Amplifier with 4 PHD hybrids	Amps	1.68	-	-	
Standard (1X) Forward Configuration Module	Amps	0.42	-	-	
Dual (2X) Forward Segmentation Module	Amps	0.45	-	-	
Quad (4X) Forward Segmentation Module	Amps	0.90	-	-	
Standard (1X) Reverse Router Module	Amps	-	0.07	-	
Dual Segmentation (2X) Reverse Router Module	Amps	-	0.13	-	
Quad Segmentation (4X) Reverse Router Module	Amps	-	0.25	-	
Forward Redundancy Module	Amps	0.04			
Forward Narrowcast Module	Amps	0.04			
Status Monitoring Transponder	Amps	0.15	-	-	
Standard Optical Receiver	Amps	0.25	0.01	0.035	
High Gain Optical Receiver	Amps	0.35	0.01	0.035	
6940/44 Reverse Transmitter - High Gain FP	Amps	0.09	-	0.07	
6940/44 Reverse Transmitter - High Gain DFB	Amps	0.09	-	0.09	
6940/44 Reverse Switch	Amps	0.02	-	-	
Power Supply DC Current Rating	Amps	4.5	0.5	1.5	1
Power Supply Operating Efficiency	%	85			
AC Input Low Voltage Cutoff	V AC	33			
Minimum Restart Voltage	V AC	41			

Station Powering Data														
6944 Station	I <sub>DC</sub> (Amps at 24 V DC)		AC Voltage											
			90	85	80	75	70	65	60	55	50	45	41	
1x1 Configuration (1 Std Receiver & 1 DFB or FP Transmitter)	2.59	AC Current (A)	1.1	1.2	1.2	1.2	1.2	1.2	1.2	1.2	1.5	1.6	1.8	2.0
		Power (W)	75	75	75	74	74	74	74	74	74	74	75	76
2x2 Configuration (2 Std Receivers & 2 DFB or FP Transmitters)	2.96	AC Current (A)	1.3	1.3	1.3	1.3	1.3	1.4	1.6	1.7	1.8	2.0	2.3	
		Power (W)	86	86	86	86	86	85	85	86	86	86	87	
4x4 Configuration (4 Std Receivers & 4 DFB or FP Transmitters)	4.09	AC Current (A)	1.6	1.7	1.7	1.8	1.8	1.9	2.2	2.3	2.5	2.8	3.2	
		Power (W)	120	120	119	119	119	119	120	120	120	121	121	

Data is based on stations configured for 2-way operation with status monitoring transponder. AC currents specified are based on measurements made with typical CATV type ferro-resonant AC power supply (quasi-square wave), and standard version DC power supply (pn 590902).

**Note:**

- The total DC power consumption of installed components should not exceed the power supply DC current rating.

Environmental	Units	
Operating Temperature Range	degrees	-40°C to 60°C (-40°F to 140°F)
Relative Humidity Range	percent	5% to 95%
Mechanical		
Housing Dimensions	Weight	
51.3 cm L x 27.4 cm H x 27.4 cm D (20.2 in. L x 10.8 in. H x 10.8 in. D)	Station with 2 RX, 2 TX, 2 power supplies:	17.7 kg (39 lbs)
	Station with 4 RX, 4 TX, 2 power supplies:	19.1 kg (42 lbs)

# Model 6944 Four Port Optoelectronic Node – 5-65/86-870 MHz



## Ordering Information

The **Prisma® Node Ordering Matrix** provides ordering information for configured nodes. This page contains ordering information for required and optional accessories that may not be included as part of a configured node. Please consult with Sales or Access Networks Applications Engineering to determine the best configuration for your particular need.

The following **Required Accessories** must be ordered separately (not included via Prisma Node Ordering Matrix):

Required Accessories for Model 6944 Node	Part Number
Plug-in Pads (attenuators) <ul style="list-style-type: none"> <li>1 required per Forward Fiber Optic Receiver Output</li> <li>1 required per each Reverse RF Input used</li> <li>1 required per Reverse Fiber Optic Transmitter</li> </ul>	See Pad (attenuator) part number table
Plug-in Forward Equalizer - Available in 1.5 dB steps from 0 to 15 dB at 870 MHz <ul style="list-style-type: none"> <li>1 required per Forward RF output*</li> </ul> *note – when using the standard (1x) forward configuration module, the EQ on that module (common to all 4 outputs) may also be used to set output tilt.	See EQ/Inverse EQ part number table

The following **Optional Accessories** may be ordered separately:

Optical Transmitters, Receivers and Related Parts	Part Number		
Note: Transmitters and Receivers include coax cable for connection to launch amplifier			
6940/44 - Standard Gain Optical Receiver with SC/APC connector	590922		
6940/44 - Standard Gain Optical Receiver with SC/UPC connector	590923		
6940/44 - High Gain Optical Receiver with SC/APC connector *	590926		
6940/44 - High Gain Optical Receiver with SC/UPC connector *	590927		
6944 - 1310 nm FP Optical Transmitter - High Gain, with SC/APC connector	590942		
6944 - 1310 nm FP Optical Transmitter - High Gain, with SC/UPC connector	590943		
6944 - 1310 nm DFB Optical Transmitter - High Gain, with SC/APC connector	590938		
6944 - 1310 nm DFB Optical Transmitter - High Gain, with SC/UPC connector	590939		
6944 - 1550 nm DFB Optical Transmitter - High Gain, with SC/APC connector	4005119		
6944 - 1550 nm DFB Optical Transmitter - High Gain, with SC/UPC connector	4005121		
SC/APC (green) Bulkhead Mating Adaptor (mounts in fiber handling tray), (qty 10)	4006328		
SC/UPC (blue) Bulkhead Mating Adaptor (mounts in fiber handling tray), (qty 10)	4006329		
Plug-In Modules for 6944 Optical Interface Board	Use with Optical Interface Board:		
	6 Position pn 591129	8 Position pn 590946	
Std. Reverse Router Module (4 wide), 5-65MHz	-	X	591153
Dual Segmentation (2X) Reverse Router Module (4 wide), 5-65 MHz	-	X	591156
Quad Segmentation (4X) Reverse Router Module(4 wide), 5-65 MHz	-	X	591159
Standard (1X) Reverse Router Module (2 wide), 5-65 MHz	X	-	591162
Dual Segmentation (2X) Reverse Router Module (2 wide), 5-65 MHz	X	-	591165
Forward Redundancy Module	X	X	591148
Forward Narrowcast Module	X	X	591150
Plug-In Modules for Launch Amplifier			
Optional 2 Way RF Splitter (for activation of auxiliary ports)			747951
Standard (1X) Forward Configuration Module (for no segmentation)			591138
Dual (2X) Forward Segmentation Module			591141
Quad (4X) Forward Segmentation Module			591144
6940/44 – Reverse Switch (one may be ordered for each reverse input port)			590956
Related Equipment			
6940/44 – Standard DC Power Supply 40 - 90 V AC			590902
6940/44 – Crowbar Surge Protector			736253
Redundant Control Module - Required for receiver redundancy operation when Status Monitoring Transponder is <i>not</i> used			741509
Status Monitoring Transponder			See Transponder Data Sheet
75 Ohm Transmitter Terminator (used when no TX in redundant slot)			591133
75 Ohm SMB Terminator (for female SMB connector termination)			591134
SMB to F Test Cable Assembly			590961
6940/44 – RF Test Probe			562580

\* Standard gain receiver is recommended.

# Model 6944 Four Port Optoelectronic Node – 5-65/86-870 MHz



## Ordering Information, continued

### Forward Equalizers / Inverse Equalizers

870 MHz Linear Forward Equalizers	Part Number
0 dB (jumper)	717929
1.5 dB	590986
3.0 dB	590987
4.5 dB	590988
6.0 dB	590989
7.5 dB	590990
9.0 dB	590991
10.5 dB	590992
12.0 dB	590993
13.5 dB	590994
15.0 dB	590995
870 MHz Inverse Equalizers	Part Number
1.5 dB	590010
3.0 dB	591011
4.5 dB	591012
6.0 dB	591013
7.5 dB	591014
9.0 dB	591015
10.5 dB	591016

### Pads (attenuators)

Pad Value (dB)	Part Number	Pad Value (dB)	Part Number
0	279500	0.5	565231
1	279501	1.5	565232
2	279502	2.5	565233
3	279503	3.5	565234
4	279504	4.5	565235
5	279505	5.5	565236
6	279506	6.5	565237
7	279507	7.5	565238
8	279508	8.5	565239
9	279509	9.5	565240
10	279510	10.5	565241
11	279511	11.5	565242
12	279512	12.5	565243
13	279513	13.5	565244
14	504151	14.5	565245
15	504152	15.5	565246
16	504153	16.5	565247
17	504154	17.5	565248
18	504155	18.5	565249
19	504156	19.5	565250
20	504157	20.5	565251
75 ohm terminator	279524		



Scientific-Atlanta, the Scientific-Atlanta logo, Prisma, and GainMaker are registered trademarks of Scientific-Atlanta, Inc. bdr is a trademark of Scientific-Atlanta, Inc.

Specifications and product availability are subject to change without notice.

© 2004 Scientific-Atlanta, Inc. All rights reserved.

Scientific-Atlanta, Inc.  
1-800-722-2009 or 770-236-6900  
www.scientificatlanta.com

Part Number 744478 Rev F  
July 2004