

Preface

The Cisco Aironet Power Injector products increase wireless LAN deployment flexibility of Cisco Aironet Access Points and Bridges by providing an alternative powering option to local power, inline power-capable multiport switches, and multiport power patch panels.

The single-port Cisco Aironet Power Injector combines 48-VDC power (supplied by the external power supply) with the data signal, sending both to the Cisco Aironet Access Point or Bridge.

The Cisco Aironet Power Injector Media Converter converts fiber media signals to Category 5 Ethernet media and combines the data signal with power for delivery to the access point or bridge. The power injector accepts 48-VDC power from either the barrel connector of the local power supply or an alternative 48-VDC power source.

The power injectors provide up to 15 W (depending on the Cisco power supply model) over the unused wire pairs of a Category 5 Ethernet cable, supplying enough power for a distance of 328 ft. (100 m) on the Cisco Aironet 350, 1100, 1200 Series Access Points and the Cisco Aironet 350 Series Bridges.

This guide covers the following Cisco Aironet Power Injectors:

- Cisco Aironet Power Injector Media Converter (AIR-PWRINJ-FIB)
- Cisco Aironet Power Injector (AIR-PWRINJ3)

Cisco Aironet Power Injector Media Converter

The Cisco Aironet Power Injector Media Converter provides both power and data to a connected Cisco Aironet Access Point. The device provides the following functions:

- Converts fiber media to Category 5 Ethernet media
- Uses the unused wires in an Ethernet cable to supply inline 48-VDC power to the access point

The power injector media converter is ideal for incorporating an access point into a fiber-optic network and can be used with 350, 1100, and 1200 series access points and 350 series bridges.

The power injector media converter receives data over the fiber-optic network through its MT-RJ fiber connector. The fiber-optic data signals are converted to Ethernet data signals and sent to the access point through the injector's Category 5 RJ-45 port. A Category 5 Ethernet cable connects the injector to the access point. The injector's power supply connects to a wall outlet or power strip to supply the power. An alternate 48-VDC power source can be used instead of the power supply. The power injector media converter can be mounted on most horizontal and vertical surfaces. To avoid overheating and possible failure, do not stack or tie together (bundle) the power injector and its AC power adapter.



Caution

In multiple installations the power injectors and power supplies must not touch each other and have at least 0.5 in. (1.27 cm) of open air space for circulation on 5 sides of the plastic case.

The following illustration shows the key features of the Cisco Aironet Power Injector Media Converter.

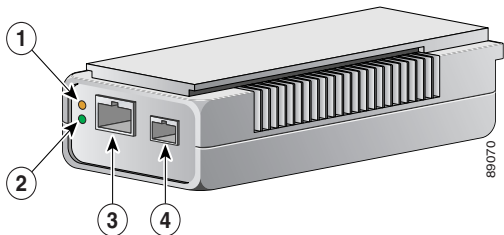

1	Activity status LED	3	100BASE-TX to device
2	Power status LED	4	100BASE-FX to network

The following illustration shows typical installation scenarios for the Cisco Aironet Power Injector Media Converter.

Wiring closet

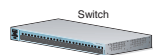

Fiber

Switch

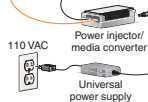

110 VAC

Power injector/
media converter

Universal
power supply

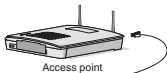

Access point

Category 5 Ethernet cable
w/power <100 meters

Scenario 1 -Typical installation in wiring closet

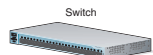

Fiber >100 meters

Switch

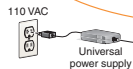

110 VAC

Power injector/
media converter

Universal
power supply

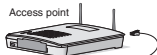

Access point

Category 5 Ethernet cable
w/power

48 VDC

Scenario 2 -Access point in remote location 100 VAC not available nearby

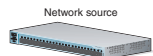

Fiber >100 meters

Network source

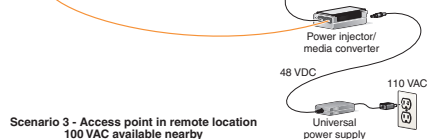

48 VDC

Power injector/
media converter

110 VAC

Universal
power supply

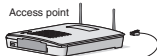

Access point

Category 5 Ethernet cable
w/power <100 meters

Scenario 3 - Access point in remote location 100 VAC available nearby

Cisco Aironet Power Injector

The Cisco Aironet Power Injector provides both power and data to a connected access point or bridge. The device serves the following functions:

- It provides Category 5 Ethernet media to the access point or bridge.
- It uses the unused wires in an Ethernet cable to supply inline 48-VDC power to an access point or bridge.

The power injector provides an easy and economical way to provide data and power to an access point or bridge located in areas where power is not available. The power injector is used with the following Cisco Aironet wireless products:

- 350 series access points and bridges
- 1100 series access points
- 1200 series access points

A Category 5 Ethernet cable connects the power injector to a 10/100 Ethernet switch, hub, or network, and another cable carries power and data to the access point's or bridge's Ethernet port. The power injector's power supply connects to a wall outlet or power strip. The power injector can be mounted on most horizontal and vertical surfaces. **To avoid overheating and possible failure, do not stack or tie together (bundle) the power injector and its AC power adapter.**

The following illustration shows the key features of the power injector.

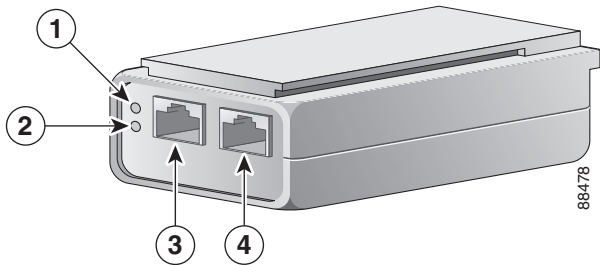

1	Device status LED	3	10/100BASE-TX to device
2	Power status LED	4	10/100BASE-TX to network

The following illustration shows a typical installation.

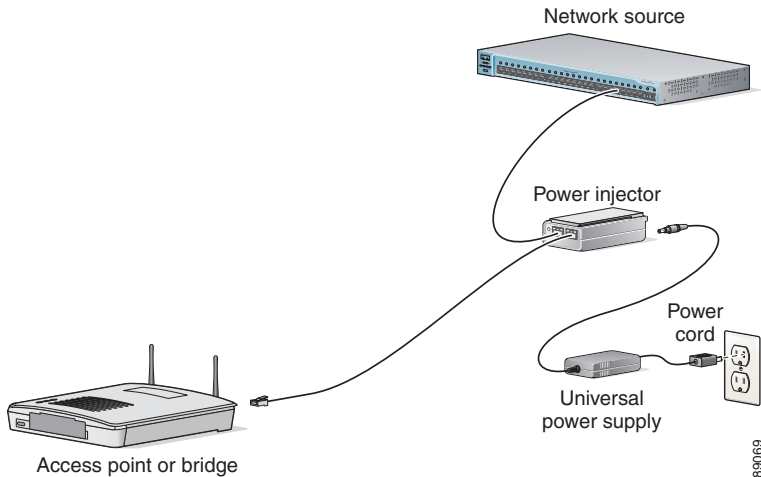

Unpacking the Power Injector

The following items are shipped with both models of the power injector:

- Category 5 Ethernet cable
- This installation guide
- Electrical tie-wrap with screw mount hole, wall anchor, and screw

If any item is missing or damaged, contact your Cisco representative or reseller.

Additional Requirements

Use the power supply that shipped with your access point to supply 48-VDC power for the injector. If you install the access point or bridge in an environmental air space such as above a suspended ceiling, check national and local safety codes to make sure that the Ethernet cable you connect to the unit meets applicable standards.

Release notes for these products are on Cisco.com. Browse to the following page:

<http://www.cisco.com/en/US/docs/wireless/power/release/notes/pwrinjrn.html>



Note

The Cisco Aironet Power Injector Media Converter (AIR-PWRINJ-FIB) provides adequate fire resistance and low smoke-producing characteristics suitable for operation in a building's environmental air space in accordance with Section 300-22(C) of the National Electrical Code (NEC) and Sections 2-128, 12-010(3), and 12-100 of the Canadian Electrical Code, Part 1, C22.1.



Note

The Cisco Aironet Power Injector (AIR-PWRINJ3) is not suitable for operation in a building's environmental air space and should not be installed in these environments.



Note

The AC power adapter for either model power injector is not suitable for operation in a building's environmental airspace and should not be installed in these environments. When installing the power injector media converter into a building's environmental air space, the power supply pigtail option must be used.

**Note**

The maximum distance that is supported for in-line power is 328 ft. (100 m), including the length of the 6.5-ft. (2-m) Ethernet cable provided with both power injector models.

Installing the Power Injector Media Converter

Follow these steps to install the power injector media converter:

1. Plug a Category 5 Ethernet cable into the port on the media converter labeled *100 Base Tx To Device*.
2. Plug the other end of the Ethernet cable into the Ethernet Port on the access point.
3. Plug the fiber-optic network cable to the port on the media converter labeled *100 Base Fx To Network*.
4. Plug the other end of the cable to the fiber-optic source.
5. Connect a suitable 48-VDC power source, such as the power pack that shipped with your access point or the power supply pigtail option, to the power receptacle labeled *DC48V*.

6. Secure the 48-VDC power cord in the retaining clips on the power injector as shown in the following illustration:

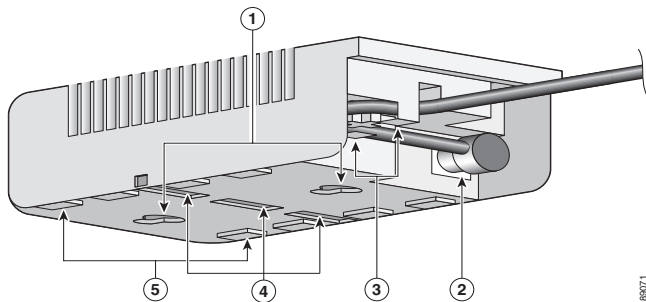

1	Keyhole mounting holes	4	Tie wrap mounting slot
2	48-VDC barrel connector	5	Mounting tabs
3	Power cord retaining clips		

7. Secure the media converter by mounting it to a vertical or horizontal surface using the supplied tie wrap mounting kit or using the keyhole mounting holes on the back of the unit.

To avoid overheating and possible failure, do not stack or tie together (bundle) the power injector and its AC power adapter.

When power is applied to the power injector media converter, the Power LED glows green. When a device is discovered, the Status LED glows green continuously.

Installing the Power Injector

Follow these steps to install the power injector:

1. Plug a Category-5 Ethernet cable into the port on the power injector labeled *10/100Base Tx to Device*.
2. Plug the other end of the Ethernet cable into the Ethernet Port on the access point or bridge.
3. Plug a Category-5 Ethernet cable into the port on the power injector labeled *10/100 Base Tx to Network*.
4. Plug the other end of the Ethernet cable into your 10/100 Ethernet switch, hub, or network.

5. Connect a suitable 48-VDC power source to the power receptacle labeled *DC48V*.

To avoid overheating and possible failure, do not stack or tie together (bundle) the power injector and its AC power adapter.

When power is applied, the Power LED glows green. The Device Status LED is dark until a device is discovered and then it glows green. If the power injector is not connected to a device capable of receiving inline power, or if it is connected incorrectly, the Power LED glows amber continuously.

6. Secure the power injector by mounting it to a vertical or horizontal surface using the supplied tie wrap mounting kit or using the keyhole mounting holes on the back of the unit.

Mounting Instructions

You can mount both models to most vertical or horizontal surfaces using the supplied tie wrap mounting kit. If you need a more secure mounting method, you can also use the mounting keyholes on the bottom of the unit.

Using the Tie Wrap Mounting Kit

The supplied tie wrap mounting kit consists of the following parts:

- A plastic tie wrap
- A #10 wall anchor and #10 screw
- An adhesive-backed plastic mounting plate

Follow these steps to mount the power injector with the supplied tie wrap mounting kit. It may be helpful to refer to the illustration on page 11.

1. Mark the position on the surface where you want to mount the power injector.
2. To mount the power injector using the wall anchor and screw, follow the steps below. If you are using the plastic mounting bracket, go to Step 3.
 - a. Drill a 5/32-in. (4-mm) hole at the location you marked.
 - b. Install the #10 wall anchor in the hole.
 - c. Insert the #10 screw into the hole of the tie wrap and into the wall anchor. Tighten the screw just enough to keep it secure in the wall anchor.
 - d. Slide the end of the tie wrap into the tie wrap mounting slot on the back of the power injector.
 - e. Insert the end of the tie wrap into its locking slot and cinch it up.
 - f. Use a Phillips head screw driver to tighten the screw into the wall anchor.
3. Follow these steps to mount the power injector using the plastic mounting plate:

- a. The mounting plate has an adhesive back, so make sure the surface on which you intend to mount the plate is clean.
- b. Remove the protective tape from the mounting plate to expose the adhesive backing.
- c. Press and hold the plate to make sure the plate adheres to the surface.



Note

You can also install the plate using two #10 screws, or you can use the screws to augment the adhesive backing.

- d. Thread the plastic tie wrap through the slot in the mounting plate and then into the tie wrap mounting slot on the back of the power injector.
- e. Insert the tie wrap into its locking slot and cinch it up.

Using the Keyhole Mounting Holes

To mount the power injector to a vertical or horizontal surface using the keyhole mounting holes, you will need the following parts and tools:

- Two #6 plastic wall anchors
- Two #6 x 1-in. (2.5 cm) sheet-metal screws

- A drill and a 3/16-in (0.48-cm) drill bit
- A Phillips head screw driver
- A small hammer

Follow these steps to mount the power injector:

1. Mark the locations on the surface where you will drill the holes for the wall anchors or screws.



Note

Make sure the holes are spaced 3 1/8 in. (7.94 cm) apart.

2. Drill a 3/16-in. (4.7-mm) hole at each marked location.
3. If you are using #6 wall anchors, use a hammer to install them in the holes.
4. Start the #6 screws into the wall anchors (or the surface).
5. Use a Phillips head screwdriver to drive the screws into the wall anchors (or surface) until there is a gap of approximately 1/4 in. (0.6 cm) between the surface and the screw heads.
6. Line up the large end of the keyholes on the power injector with the screws.
7. Insert the power injector into the keyhole and slide it down into the small end of the keyhole.



Note

If the power injector is not securely fastened to the keyholes, remove it and slightly reduce the length the screws extend. Continue making small adjustments until you are satisfied.

Specifications

This table lists specifications for the power injectors:

Specification	Power Injector Media Converter (AIR-PWRINJ-FIB)	Power Injector (AIR-PWRINJ3)
Electrical	Input voltage: 48-VDC, 15W	
Connectors	1 MT-RJ (fiber) 1 RJ-45 (Cat 5 Ethernet) 1 barrel	2 RJ-45 (Cat 5 Ethernet) 1 barrel
Wire pairs used	Injects power into two unused pairs in the Category 5 cable: 4 and 5 (negative) and 7 and 8 (positive).	
Specification	Power Injector Media Converter (AIR-PWRINJ-FIB)	Power Injector (AIR-PWRINJ3)
Dimensions	5.4 in. x 2.1 in. x 1.3 in. (13.7 cm x 5.3 cm x 3.3 cm)	
Stacking restrictions	Do not stack. Do not bundle the power injector and AC power adapter.	Do not stack. Do not bundle the power injector and AC power adapter.

Regulatory Information

The following information is for FCC compliance of Class B devices:

The equipment described in this manual generates and may radiate radio-frequency energy. If it is not installed in accordance with Cisco's installation instructions, it may cause interference with radio and television reception. This equipment has been tested and found to comply with the limits for a Class B digital device in accordance with the specifications in part 15 of the FCC rules. These specifications are designed to provide reasonable protection against such interference in a residential installation. However, there is no guarantee that interference will not occur in a particular installation.

Modifying the equipment without Cisco's written authorization may result in the equipment no longer complying with FCC requirements for Class A or Class B digital devices. In that event, your right to use the equipment may be limited by FCC regulations, and you may be required to correct any interference to radio or television communications at your own expense.

You can determine whether your equipment is causing interference by turning it off. If the interference stops, it was probably caused by the Cisco equipment or one of its peripheral devices. If the equipment causes interference to radio or television reception, try to correct the interference by using one or more of the following measures:

- Turn the television or radio antenna until the interference stops.

- Move the equipment to one side or the other of the television or radio.
- Move the equipment farther away from the television or radio.
- Plug the equipment into an outlet that is on a different circuit from the television or radio. (That is, make certain the equipment and the television or radio are on circuits controlled by different circuit breakers or fuses.)

Modifications to this product not authorized by Cisco Systems, Inc. could void the FCC approval and negate your authority to operate the product.

Applicable Standards

Except where indicated, both models meet the following standards:

- FCC Part 15.107 and 15.109 Class B
- ICES-003 Class B (Canada)
- AS/NZS 3548 Class B
- VCCI Class B
- EN 301.489-1 and 17
- EN 55022
- EN 55024
- EN 60950

- UL 60950
- CSA C22.2 No. 60950
- IEC 60825 (power injector media converter)
- IEC 60950
- UL 2043 (power injector media converter)

