



USER GUIDE



Cisco Unified Communications Manager Express for Cisco Unified IP Phone 521G and 524G User Guide

- 1 Overview
- 2 Operating Your Phone
- 3 Phone Features Index
- 4 Cisco One-Year Limited Hardware Warranty Terms

1 Overview







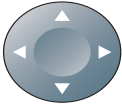

This guide provides operating instructions, and feature descriptions for the Cisco Unified IP Phone models 521G and 524G. The Cisco Unified IP Phone 521G has a single line and the 524G has four lines.

Physical Description

Your Cisco Unified IP Phones 521G and 524G has soft keys and dedicated buttons, allowing you to place and receive phone calls, put calls on hold, transfer calls, make conference calls, and access other features.



203241

	Name	Description
1	LCD screen	Displays information such as line/call status, phone number, date, time, and soft key tabs.
2	4-way navigation pad and select (center) button 	Allows you to scroll through soft button features, and displays phone numbers from your Placed Calls, when phone is on-hook. Use select button to select an item that is highlighted on the screen.
3	Soft keys buttons	Engages the functions displayed on the corresponding LCD tabs.
4	Cisco Unified Communications Manager Express phone model types	Shows the Cisco Unified IP Phone Model Number
5	Messages button 	Provides access to voice message service.
6	Hold button 	Allows an active call to be put on hold.
7	Setup button 	Provides access to phone options and directory services.
8	Volume button 	Increases or decreases handset, headset, ringer, or speakerphone volume.
9	Mute button 	Toggles mute on and off.
10	Speaker button 	Toggles speaker on and off.
11	Headset button 	Toggles headset on and off.
12	Keypad	Functions like a traditional telephone keypad.
13	Handset	Functions like a traditional handset.

Connecting Your Phone

This section shows and describes the connectors on your Cisco Unified IP phone.

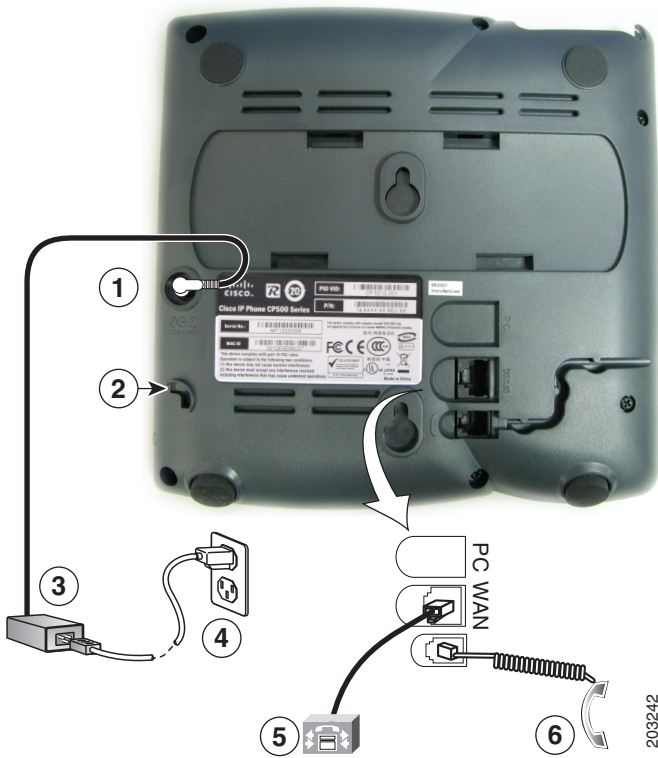

203242

1	Optional DC adapter port (DC5V) for phones not provided with inline power
2	Headset Port
3	AC-to-DC power supply
4	AC power cord
5	Network port (10/100 SW) for connecting to the network
6	Handset port

Adjusting the Handset Rest

When you connect your phone, you can adjust the handset rest so that the receiver does not slip out of the cradle. To adjust the handset:

1. Set the handset aside and pull the square plastic tab from the handset rest.
2. Rotate the tab halfway.
3. Slide the tab back into the handset rest. An extension protrudes from the top of the rotated tab. Return the handset to the handset rest.

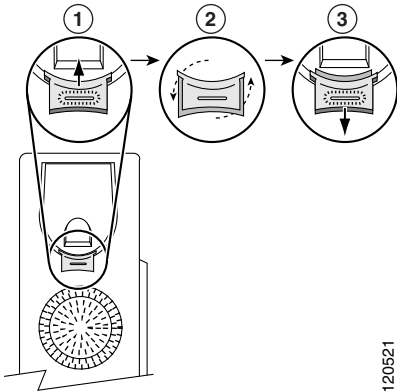

2 Operating Your Phone

This section describes how to operate your Cisco Unified IP phone and includes information on soft keys and phone features.



Note Because there are differences in phone and site configuration, not all features described here may apply to your phone. Consult your system administrator.

Soft Key Descriptions

Your Cisco Unified IP phone is equipped with soft keys for call features and options. Soft keys are listed along the bottom of the LCD screen and activated using the corresponding buttons. Soft keys can change according to the state of the phone.

Following is a comprehensive list of soft keys offered on the Cisco Unified IP Phones 521G and 524G. Functions depend on your system configuration.

Soft Key	Function
<<or>>	Navigates left and right through entry without deleting character.
Add	Allows addition of a new entry
Answer	Answers incoming call.
Callback	Notifies callers that called line is free.
Cancel	Cancels last selection.
cbarge	Allows callers to join a shared-line call.
CFwdALL	Forwards all calls.
Clear	Clears the entire entry.
Confrn	Connects callers to a conference call.

Soft Key	Function
Delete	Deletes selected number.
Delchr	Deletes a character.
Dial	Dials displayed number.
DnD	Enables Do-Not-Disturb feature.
Down	Decreases LCD screen contrast.
EditDial	Selects number and activates cursor for editing.
EndCall	Ends current call.
Exit	Exits from current selection.
Flash	Provides hookflash functionality for three-way calling and call waiting services provided by the PSTN or Centrex service.
GPickUp	Selectively picks up calls coming into a phone number that is member of the pickup group.
Hold	Places active call on hold. Resumes on hold call.
Login	Provides PIN-controlled access to restricted phone features. Contact your local administrator for additional instructions.
LiveRcd	Enables the user to record a phone conversation.
more	Scrolls through additional soft key options (for example, use the more soft key to locate the DnD soft key).
NewCall	Opens new line on speakerphone to place call.
Ok	Confirms selection.
Park	Forwards calls to location from which call can be retrieved by anyone in the system.
PickUp	Selectively picks up calls coming into another extension.
Play	Plays ring sound samples.
Redial	Redials last number dialed.
Remove	Removes conference participant.
RmLstC	Removes Last Participant from the Conference Call.
Resume	Returns to active call.
Save	Saves last change.
Search	Initiates search in local directory.
Select	Selects highlighted option.
TrnsfVM	Transfers a call to voice mail.
Trnsfr	Transfers active calls to another extension.
Up	Increases LCD screen contrast.
Update	Updates content.

Phone Features

This section provides information on using your phone's features and includes:



- Basic—Place a Call, 6
- Additional Options—Place a Call, 7
- Answer a Call, 7
- End a Call, 7

- Hold and Resume a Call, 7
- Mute a Call, 7
- Manage Call Waiting, 8
- Retrieve Voice Messages, 8
- Adjust the Volume for the Current Call, 8
- Adjust the Ring Volume, 8
- Select the Ring Type, 8
- Adjust the Display Contrast, 9
- Divert Incoming Calls, 9
- Park a Call, 9
- Call-Blocking (Toll Bar) Override, 9
- View Multiple Calls, 10
- Transfer a Call, 10
- Cancel Transfer, 10
- Transfer to Voice Mail, 10
- Forward All Calls, 10
- Pick Up Calls, 11
- Place and Establish Conference Call, 11
- End a Conference Call, 11
- Live Record a Call, 12
- Join a Shared-Line Call, 12
- Place Call from Your Local Directory, 12
- Program Personal Speed-Dial Buttons, 12
- Place a Call from Your System Speed-Dial Directory or Fast Dial, 13
- View Call History, 13
- Place a Call from Call History, 13
- Clear Call History, 13
- Use the Intercom Feature, 14
- Activate Do Not Disturb, 14

Basic—Place a Call

Use one of the following methods to place a call:

- Lift the handset and dial the number.
- Dial the number, and then lift the handset.
- Dial the number, and then press the **Dial** soft key.
- Press the **line** button for your extension, and then dial.
- Press the **Speaker** button, and then dial.
- Press the **New Call** soft key, and then dial.
- If you are using a headset, press the **Headset** button, and then dial. Or, if  is lit, press **New Call** and enter a number.
- Dial the number, and then press the **Headset** button.
- If you have selected a number from a directory, press the **Dial** soft key.

- Press **Redial** to dial the last number, or press the **Navigation** button (with the phone idle) to see your **Placed Calls**.
- If you are placing a call while another call is active (using the same line), press the **Hold** button, and then press **New Call** and enter the number.
- If you are dialing from the **Setup**, choose **Call History** and select **Missed Calls**, **Received Calls**, or **Placed Calls**.
- If you are dialing on-hook, without a dial tone (predial), enter a number, then lift the handset go off-hook, press **Dial**, , or .



Note Use the backspace (<<) soft key to erase digits that you enter incorrectly.



Additional Options—Place a Call

To place a call while another call is active (using a different line):

1. Press the line button for a new line. The first call is automatically placed on hold.
2. Enter a number.



Answer a Call

Use one of the following methods to answer a call:

- Press  to answer with a headset, if unlit. Or, if  is lit, press **Answer**.
- Press  to answer with the speakerphone or press **Answer**.
- Press **Answer** to switch from a connected call to answer a new call, or, if the call is ringing on a different line, press the line button.
- Press **Answer** to answer a call using call waiting.
- Press **DnD** to send a call to your voice messaging system.

End a Call

Use one of the following methods to end a call:

- Hang up the handset or press **EndCall**.
- If you are using a headset, press . Or, to keep headset mode active, press **EndCall**.
- If you are using a speakerphone, press  or **EndCall**.
- Press **EndCall** to hang up one call, and preserve another call on the same line. If necessary, remove the call from hold first.

Hold and Resume a Call

Engaging the Hold feature typically generates music or a beep to the caller.

To put a call on hold, use the following method:

1. Make sure the call you want to put on hold is highlighted.
2. Press the **Hold** button.

To remove a call from hold on the current line, use the following method:

1. Make sure the appropriate call is highlighted.
2. Press **Resume**.

To remove a call from hold on a different line, press the appropriate line. If a single call is holding on this line, the call automatically resumes. If multiple calls are holding, scroll to the appropriate call and press **Resume**.

Mute a Call

With Mute enabled, you can hear other parties on a call and they cannot hear you. You can use Mute in conjunction with the handset, headset, or a speakerphone.

Press  to toggle Mute on, red light will light when active.

Press  to toggle Mute off.

Manage Call Waiting

If you are on a call when a second call comes in, you will hear a call-waiting tone and, or, see a flashing indicator light on the handset rest, depending on the configuration of your phone.

To answer the new call on the same line, use the following method:

1. Use the **Navigation** button to select the call.
2. Press **Answer** to answer the call. The call on the other line is automatically put on hold.

To return to the original call, use the following method:

1. Use the **Navigation** button to reselect the call.
2. Press **Resume** to reconnect to the call.

For calls on a separate line:

- Press the **Line** button for the incoming call. The call on the other line is automatically put on hold.

To return to the original call:

- Press the **Line** button associated with the original call.

Retrieve Voice Messages

To retrieve voice messages, use the following method:

1. Select an available line by lifting the handset, pressing the speakerphone button, or pressing a line button. Listen for the dial tone.
2. Press the **Messages** button, and follow the voice instructions.



Note Cisco Unity Express is the default voice message service that your phone systems use. For more information on voice mail, go to cisco.com and search for [Cisco Unity Express User Guide](#).

Adjust the Volume for the Current Call

To adjust the handset, speakerphone, or headset volume for the current call, use the following method:

1. During a call, press the **Up** or **Down Volume** button.
2. Press **Save** to apply the new volume level to future calls.

Adjust the Ring Volume

- Press the **Up** or **Down Volume** button while the handset is in its cradle.

Select the Ring Type

To change the ringer sound, use the following method:

1. Press the **Setup** button and select **Settings**.
2. Press **2** for Ring Type, or use the **Navigation** button to scroll to Ring Type and press **Select**.
3. Use the **Navigation** button to scroll through the list of ring types.
4. Press **Play** to hear samples.
5. Highlight the ring you want, and then press the **Select**.
6. Press **Ok** to select your setting.
7. Press **Save** to save the setting, or press **Cancel** to exit to the previous menu without changing the setting.
8. Press **Exit** to return to the main directory menu.

Adjust the Display Contrast

To adjust the contrast in your LCD Display, use the following method:

1. Press the **Setup** button.
2. Press **1** for Contrast, or use **Select**.
3. Use the **Down** or **Up** soft key to change the contrast.
4. Press **Ok**.
5. Press **Save** or **Exit**.
6. Press **Ok** to select your contrast setting.
7. Press **Save** to save the setting, or press **Cancel** to exit to the previous menu without changing the setting.
8. Press **Exit** to return to the main directory menu.

Divert Incoming Calls

To forward any incoming call to the call-forward destination set on the Cisco Unified IP phone:

- Press the **DnD** soft key.



Note If the call-forward destination is not set, pressing the **DnD** soft key disables the ringer.

Park a Call

Call park allows a phone user to place a call on hold at a designated parking spot from which the call can be retrieved by anyone on the system.



Note Contact your system administrator for your call park slot number.

To park a call:

- Press **Park**.

The Cisco Unified Communications Manager Express system automatically selects an available call park slot and displays the number on the Cisco Unified IP phone screen.

To park a call to a specific call park slot:

- Press the transfer button followed by the call part slot number provided by your system administrator.

To retrieve a parked call, use one of the following methods:

- If your phone receives a call park notification, press **PickUp** followed by the asterisk (*).
- Press **PickUp** followed by the call park slot number.

Call-Blocking (Toll Bar) Override

Call blocking prevents unauthorized use of phones. It is implemented by matching a pattern of specified digits during a specified time of day and day of week or date. The call-blocking override feature allows individual phone users to override the call blocking that has been defined.



Note Contact your system administrator for your personal identification number (PIN).

To place calls when call-blocking is enabled, use the following method:

1. Press **Login** on the Cisco Unified IP phone.
2. Enter the PIN that is associated with the phone.

Transfer a Call

To transfer a selected call to another number, use the following method:

1. During a call, press **Trnsfr**. The call is placed on hold.
2. Dial the number to which you want to transfer the call.
3. Press **Trnsfr** to complete the transfer or wait for the call to be answered. Speak to the transfer recipient. Then press the **Trnsfr** button or hang up the handset.
4. If the transfer fails, press **EndCall** then press **Resume** to return to the original call.

Cancel Transfer

1. To cancel your consult call-transfer attempt:
 - Press **EndCall**.
2. To reconnect to the original caller:
 - Press **Resume**.

Transfer to Voice Mail

To transfer a call to the recipient's voice mail, use the following method:

1. Press **TrnsfVM** to place the call on hold.
2. Enter the recipient's extension number and press **TrnsfVM** again.

Forward All Calls

To forward all incoming calls to another number, use the following method:

1. Press **CFwdALL**. You hear a confirmation beep.
2. Dial the number to which you want to forward all your calls. Dial the number exactly as you would if you were placing a call to that number. Remember to include locally required prefix numbers.
3. Press the pound key (#) or **EndCall**. The phone display is updated to show that calls are to be forwarded.



Note To forward calls to voice mail, manually enter the voice-mail number, or use the soft key and button sequence of **CFwdALL** plus the **Messages** button, followed by the **EndCall**.

To forward calls to a speed-dial number, use the soft key and button sequence of the **CFwdALL** plus a **speed-dial** button, followed by **EndCall**

To cancel call forwarding:

- Press **CFwdALL**.

Pick Up Calls

To pick up a call that is on hold or a call that is ringing at another extension, use the following method:

1. Press **PickUp**.
2. Dial the extension number of the Cisco Unified IP phone that you want to pick up. Call control is transferred to your phone.

To selectively pick up a call ringing at a number that belongs to a pickup group:

- Press **GPickUp**. If only one pickup group is defined in the entire Cisco Unified Communications Manager Express system, call control is transferred to your phone.
- If the ringing telephone and your phone are in the same pickup group, press the asterisk (*) to transfer call control to your phone.

- If the ringing telephone and your phone are in different pickup groups, dial the pickup group number where the phone is ringing to transfer call control to your phone.

Place and Establish Conference Call

To place a conference call, use the following method:

1. During a call, press **Confrn** to open a new line and put the first party on hold.
2. Place a call to another number.
3. When the call connects, press **Confrn** again to add the new party to the call.

To establish a conference call between two- and three-parties to a Cisco Unified IP phone, one active and the other on hold:

- Press **Confrn**.

To establish a conference call between two- and three-party calls already present on a Cisco Unified IP phone, using separate line buttons, one active and the other on hold:

1. Press **Confrn**.
2. Press the **Line** button of the call you want to add to the conference.



Note Your system administrator will have configured the system for three-party or eight-party ad-hoc conferences.

End a Conference Call

- To end the conference call:
1. Hang up the handset, or press **EndCall**.



Note Depending on the configuration, when the conference call initiator disconnects, the conference call terminates.

Alternate Method to End Conference Call

Call initiators can disconnect from the conference by hanging up the handset. The other parties remain on the conference call.

Live Record a Call

Call initiators can use the **LiveRcd** soft key to record an active call, private line or conference call. To record a call, use this method:

1. Press the **LiveRcd**. This puts the other party on-hold and initiates a call to the configured live record number.
2. Press the **LiveRcd** again to stop the recording.

Join a Shared-Line Call

User can join a call on a shared line using the **cBarge** softkey.

To join the shared-line call, use the following method:

1. Highlight the remote-in-use call that you want to join.
2. Press the **more** to navigate to **cBarge** and press **cBarge**.

Place Call from Your Local Directory

To access the local phone directory established by the administrator, use the following method:

1. Press the **Setup** button and select **Directory**.
2. Press the **Navigation Up** or **Down** button or select the **Local Directory**.
3. Press the **Navigation Up** or **Down** button to select the **Last**, **First**, or **Number** field search option.

4. Using the keypad, enter the last name or first name for the entry.
When entering letters, select the appropriate number key of the letter you want, and press that key a number of times that equals the position of the target letter. For example, to enter a B, press the 2 key two times, and to enter a C, press the 2 key three times. Use the backspace (<<) soft key to make corrections while entering data.
5. Press **Search** to find your selection.
6. If your search results in multiple listings, use the **Navigation Up** or **Down** button to select the correct number.
7. If your search results in multiple pages, use the **Next** and **Prev** softkeys to move back and forth between the previous and next pages.
8. Press **Dial** to dial the selected number.

Program Personal Speed-Dial Buttons

After an administrator defines one or more speed-dial instances for a Cisco Unified IP phone, you can reprogram numbers that are not locked or program numbers into an instance that has an empty dial string:

1. Select an available phone line by lifting the handset, pressing **NewCall**, or pressing a line button. Listen for the dial tone.
2. Press the pound key (#).
3. Press the speed-dial button that you want to program. A short beep confirms that you are starting to program this button.
4. Enter the speed-dial number. The digits appear on the phone display. When you are entering speed-dial numbers, use the backspace (<<) soft key to erase digits that you entered incorrectly.

To remove a speed-dial number without replacing it with a new one:

1. Press the pound key (#).
2. Press the same speed-dial button a second time to indicate that you are done entering the speed-dial digits and to store the new speed-dial number.
3. Hang up the handset, or press a new speed-dial button and repeat this procedure.

Place a Call from Your System Speed-Dial Directory or Fast Dial

To place a call from your system speed-dial directory, use the following method:

1. Select an available Cisco Unified IP Phone line (off hook or **NewCall**) and get a dial tone.
2. Press the **Setup** button and go to **CME Services**, and select **Speed Dial**.
3. Use the **Navigation** button to scroll through the options. Use **Select** to select speed-dial options.
 - Press 2 for Local Speed Dial.
 - Press 3 for Personal Speed Dial (functionality varies depending on your system configuration).
4. Use the **Navigation** button to scroll through the speed-dial phone list.
5. To dial the selected phone number, either press **Select** or enter the number on the keypad.
6. Press **Cancel** to go to the previous page.

View Call History

To view recent missed, received, or placed calls:

1. Press the **Setup** button and select **Call History**.
2. Use the **Navigation** button to scroll and select the desired call list. Press **Select**, or
 - Press 1 on the keypad for Missed Calls.
 - Press 2 on the keypad for Received Calls.
 - Press 3 on the keypad for Placed Calls.
3. Press **Exit** to return to the previous directory menu.

Place a Call from Call History

To place a call to a number in the call history list:

1. Use the **Navigation** button to scroll through the Call History list.
2. Use **Select** to select a phone number. The digits will appear on the phone display.

To dial the number as it appears on the phone display:

- Press **Dial**.

To edit the number on the phone display before dialing:

1. Press **EditDial** to place the cursor at the beginning of the number on the phone display.
2. Use the keypad to edit the digits as needed. Use **delChr** to erase digits that you enter incorrectly.
3. Press **Dial** to place the call.

Clear Call History

To clear all numbers in the directory histories

- Press **Clear**.



Note The **Clear** soft key clears all call history lists. Selective clearing of call history lists is not supported.

Use the Intercom Feature

Cisco Unified Communications Manager Express supports intercom functionality for one-way and press-to-answer voice connections using a dedicated pair of intercoms on two phones that speed-dial each other.

To use the intercom feature:

1. Press the **Speaker** button and get dial tone.
2. Press the speed dial key or dial the directory number to start the intercom call.



Note The called Cisco Unified IP phone automatically answers the call in speakerphone mode with mute activated or deactivated depending on configuration. The phone beeps to alert the recipient to the incoming call.

To respond to an intercom call:

- If Mute key is lit, Press the **Mute** button, or lift the handset.
- If Mute key is not lit, reply to caller hands free.

Activate Do Not Disturb

For visual call alerting and information without audible ringing, use Do Not Disturb (DnD). Calls receive normal call-forward-busy and no-answer treatment.

To activate the Do-Not-Disturb feature:

1. Press **DnD**.
2. A text message indicates that the phone is in Do-Not-Disturb mode.



Note Pressing the DnD soft key while the phone is ringing immediately forwards the call to the call-forward destination set on the phone. If the call-forward destination is not set, pressing the DnD soft key disables the ringer.

To deactivate the Do-Not-Disturb feature, repeat Step 1.

3 Phone Features Index

This section provides an alphabetical list of features for your Cisco Unified IP phone. Features supported in Smart Phone Control Protocol (SPCP) are marked as “Supported”.

Table 1 Features supported in SPCP protocols.

Phone Features, page reference	SPCP
Activate Do Not Disturb, page 13	Supported
Additional Options—Place a Call, page 7	Supported
Adjust the Display Contrast, page 9	Supported
Adjust the Ring Volume, page 8	Supported
Adjust the Volume for the Current Call, page 8	Supported
Answer a Call, page 7	Supported
Basic—Place a Call, page 6	Supported
Call-Blocking (Toll Bar) Override, page 9	Supported
Clear Call History, page 13	Supported
Divert Incoming Calls, page 9	Supported
End a Call, page 7	Supported
End a Conference Call, page 11	Supported
Forward All Calls, page 10	Supported
Hold and Resume a Call, page 7	Supported
Join a Shared-Line Call, page 11	Supported*
Live Record a Call, page 11	Supported*
Manage Call Waiting, page 8	Supported
Mute a Call, page 7	Supported
Park a Call, page 9	Supported
Pick Up Calls, page 10	Supported
Place a Call from Call History, page 13	Supported
Place a Call from Your System Speed-Dial Directory or Fast Dial, page 12	Supported
Place and Establish Conference Call, page 11	Supported
Place Call from Your Local Directory, page 11	Supported
Program Personal Speed-Dial Buttons, page 12	Supported
Retrieve Voice Messages, page 8	Supported
Select the Ring Type, page 8	Supported
Transfer to Voice Mail, page 10	Supported*
Transfer a Call, page 10	Supported
Use the Intercom Feature, page 13	Supported
View Call History, page 12	Supported



Note Phone features marked with “*” sign are supported in Cisco Unified Communications Manager Express version 4.3 and higher.

4 Cisco One-Year Limited Hardware Warranty Terms

There are special terms applicable to your hardware warranty and various services that you can use during the warranty period. Your formal Warranty Statement, including the warranties and license agreements applicable to Cisco software, is available on Cisco.com. Follow these steps to access and download the *Cisco Information Packet* and your warranty and license agreements from Cisco.com.

1. Launch your browser, and go to this URL:

http://www.cisco.com/univercd/cc/td/doc/es_inpk/cetrans.htm

The Warranties and License Agreements page appears.

2. To read the *Cisco Information Packet*, follow these steps:

- a. Click the **Information Packet Number** field, and make sure that the part number 78-5235-03C0 is highlighted.
- b. Select the language in which you would like to read the document.
- c. Click **Go**.

The Cisco Limited Warranty and Software License page from the Information Packet appears.

- d. Read the document online, or click the **PDF** icon to download and print the document in Adobe Portable Document Format (PDF).

Note You must have Adobe Acrobat Reader to view and print PDF files. You can download the reader from Adobe's website: <http://www.adobe.com>

3. To read translated and localized warranty information about your product, follow these steps:

- a. Enter this part number in the Warranty Document Number field:

78-10747-01C0

- b. Select the language in which you would like to view the document.
- c. Click **Go**.

The Cisco warranty page appears.

- d. Read the document online, or click the **PDF** icon to download and print the document in Adobe Portable Document Format (PDF).

You can also contact the Cisco service and support website for assistance:

http://www.cisco.com/public/Support_root.shtml.

Duration of Hardware Warranty

One (1) Year

Replacement, Repair, or Refund Policy for Hardware

Cisco or its service center will use commercially reasonable efforts to ship a replacement part within ten (10) working days after receipt of a Return Materials Authorization (RMA) request. Actual delivery times can vary, depending on the customer location.

Cisco reserves the right to refund the purchase price as its exclusive warranty remedy.

To Receive a Return Materials Authorization (RMA) Number

Contact the company from whom you purchased the product. If you purchased the product directly from Cisco, contact your Cisco Sales and Service Representative.

Complete the information below, and keep it for reference.

Company product purchased from	
Company telephone number	
Product model number	
Product serial number	
Maintenance contract number	



Americas Headquarters
Cisco Systems, Inc.
170 West Tasman Drive
San Jose, CA 95134-1706
USA

www.cisco.com
Tel: 408 526-4000
800 553-NETS (6387)
Fax: 408 527-0883

Asia Pacific Headquarters
Cisco Systems, Inc.
168 Robinson Road
#28-01 Capital Tower
Singapore 068912

www.cisco.com
Tel: +65 6317 7777
Fax: +65 6317 7799

Europe Headquarters
Cisco Systems International BV
Haarlerbergpark
Haarlerbergweg 13-19
1101 CH Amsterdam
The Netherlands

www-europe.cisco.com
Tel: 31 0 800 020 0791
Fax: 31 0 20 357 1100

Cisco has more than 200 offices worldwide. Addresses, phone numbers, and fax numbers are listed on the Cisco Website at www.cisco.com/go/offices.

Cisco, Cisco Systems, the Cisco logo, and the Cisco Systems logo are registered trademarks or trademarks of Cisco Systems, Inc. and/or its affiliates in the United States and certain other countries. All other trademarks mentioned in this document or Website are the property of their respective owners. The use of the word partner does not imply a partnership relationship between Cisco and any other company. (0705R)

© 2008 Cisco Systems, Inc. All rights reserved.

78-18529-01