



Cisco Unity Bridge Design Guide

Cisco Unity Bridge Version 3.0

Published June 11, 2004



Preface

Audience

The *Cisco Unity Bridge Design Guide* is intended for anyone responsible for the design or configuration of a Cisco Unity Bridge system.

Document Conventions

The *Cisco Unity Bridge Design Guide* uses the following conventions:

Note: Means reader take note. Notes contain helpful suggestions or references to material not covered in the document.

Caution! Means reader be careful. In this situation, you might do something that could result in equipment damage or loss of data.

Additional Cisco Unity Documentation

For descriptions and the URLs of Cisco Unity documentation on Cisco.com, refer to the *Cisco Unity Documentation Guide*. The document is shipped with Cisco Unity and is available at http://www.cisco.com/univercd/cc/td/doc/product/voice/c_unity/about/index.htm.

Obtaining Documentation

Cisco provides several ways to obtain documentation, technical assistance, and other technical resources. These sections explain how to obtain technical information from Cisco Systems.

Cisco.com

You can access the most current Cisco documentation on the World Wide Web at this URL:

<http://www.cisco.com/univercd/home/home.htm>

You can access the Cisco website at this URL:

<http://www.cisco.com>

International Cisco websites can be accessed from this URL:

http://www.cisco.com/public/countries_languages.shtml

Documentation CD-ROM

Cisco documentation and additional literature are available in a Cisco Documentation CD-ROM package, which may have shipped with your product. The Documentation CD-ROM is updated regularly and may be



more current than printed documentation. The CD-ROM package is available as a single unit or through an annual or quarterly subscription.

Registered Cisco.com users can order a single Documentation CD-ROM (product number DOC-CONDOCCD=) through the Cisco Ordering tool:

http://www.cisco.com/en/US/partner/ordering/ordering_place_order_ordering_tool_launch.html

All users can order monthly or quarterly subscriptions through the online Subscription Store:

<http://www.cisco.com/go/subscription>

Ordering Documentation

You can find instructions for ordering documentation at this URL:

http://www.cisco.com/univercd/cc/td/doc/es_inpk/pdi.htm

You can order Cisco documentation in these ways:

- Registered Cisco.com users (Cisco direct customers) can order Cisco product documentation from the Networking Products MarketPlace:

<http://www.cisco.com/en/US/partner/ordering/index.shtml>

- Nonregistered Cisco.com users can order documentation through a local account representative by calling Cisco Systems Corporate Headquarters (California, U.S.A.) at 408 526-7208 or, elsewhere in North America, by calling 800 553-NETS (6387).

Documentation Feedback

You can submit comments electronically on Cisco.com. On the Cisco Documentation home page, click Feedback at the top of the page.

You can e-mail your comments to bug-doc@cisco.com.

You can submit comments by using the response card (if present) behind the front cover of your document or by writing to the following address:

Cisco Systems
Attn: Customer Document Ordering
170 West Tasman Drive
San Jose, CA 95134-9883

We appreciate your comments.

Obtaining Technical Assistance

Cisco provides Cisco.com, which includes the Cisco Technical Assistance Center (TAC) website, as a starting point for all technical assistance. Customers and partners can obtain online documentation,



troubleshooting tips, and sample configurations from the Cisco TAC website. Cisco.com registered users have complete access to the technical support resources on the Cisco TAC website, including TAC tools and utilities.

Cisco.com

Cisco.com offers a suite of interactive, networked services that let you access Cisco information, networking solutions, services, programs, and resources at any time, from anywhere in the world.

Cisco.com provides a broad range of features and services to help you with these tasks:

- Streamline business processes and improve productivity
- Resolve technical issues with online support
- Download and test software packages
- Order Cisco learning materials and merchandise
- Register for online skill assessment, training, and certification programs

To obtain customized information and service, you can self-register on Cisco.com at this URL:

<http://tools.cisco.com/RPF/register/register.do>

Technical Assistance Center

The Cisco TAC is available to all customers who need technical assistance with a Cisco product, technology, or solution. Two types of support are available: the Cisco TAC website and the Cisco TAC Escalation Center. The type of support that you choose depends on the priority of the problem and the conditions stated in service contracts, when applicable.

We categorize Cisco TAC inquiries according to urgency:

- Priority level 4 (P4)—You need information or assistance concerning Cisco product capabilities, product installation, or basic product configuration. There is little or no impact to your business operations.
- Priority level 3 (P3)—Operational performance of the network is impaired, but most business operations remain functional. You and Cisco are willing to commit resources during normal business hours to restore service to satisfactory levels.
- Priority level 2 (P2)—Operation of an existing network is severely degraded, or significant aspects of your business operations are negatively impacted by inadequate performance of Cisco products. You and Cisco will commit full-time resources during normal business hours to resolve the situation.
- Priority level 1 (P1)—An existing network is “down,” or there is a critical impact to your business operations. You and Cisco will commit all necessary resources around the clock to resolve the situation.



Cisco TAC Website

The Cisco TAC website provides online documents and tools to help troubleshoot and resolve technical issues with Cisco products and technologies. To access the Cisco TAC website, go to this URL:

<http://www.cisco.com/tac>

All customers, partners, and resellers who have a valid Cisco service contract have complete access to the technical support resources on the Cisco TAC website. Some services on the Cisco TAC website require a Cisco.com login ID and password. If you have a valid service contract but do not have a login ID or password, go to this URL to register:

<http://tools.cisco.com/RPF/register/register.do>

If you are a Cisco.com registered user, and you cannot resolve your technical issues by using the Cisco TAC website, you can open a case online at this URL:

<http://www.cisco.com/tac/caseopen>

If you have Internet access, we recommend that you open P3 and P4 cases online so that you can fully describe the situation and attach any necessary files.

Cisco TAC Escalation Center

The Cisco TAC Escalation Center addresses priority level 1 or priority level 2 issues. These classifications are assigned when severe network degradation significantly impacts business operations. When you contact the TAC Escalation Center with a P1 or P2 problem, a Cisco TAC engineer automatically opens a case.

To obtain a directory of toll-free Cisco TAC telephone numbers for your country, go to this URL:

<http://www.cisco.com/warp/public/687/Directory/DirTAC.shtml>

Before calling, please check with your network operations center to determine the Cisco support services to which your company is entitled: for example, SMARTnet, SMARTnet Onsite, or Network Supported Accounts (NSA). When you call the center, please have available your service agreement number and your product serial number.

Obtaining Additional Publications and Information

Information about Cisco products, technologies, and network solutions is available from various online and printed sources.

- The Cisco Product Catalog describes the networking products offered by Cisco Systems, as well as ordering and customer support services. Access the Cisco Product Catalog at this URL:

http://www.cisco.com/en/US/products/products_catalog_links_launch.html

- Cisco Press publishes a wide range of networking publications. Cisco suggests these titles for new and experienced users: Internetworking Terms and Acronyms Dictionary, Internetworking Technology



Handbook, Internetworking Troubleshooting Guide, and the Internetworking Design Guide. For current Cisco Press titles and other information, go to Cisco Press online at this URL:

<http://www.ciscopress.com>

- Packet magazine is the Cisco quarterly publication that provides the latest networking trends, technology breakthroughs, and Cisco products and solutions to help industry professionals get the most from their networking investment. Included are networking deployment and troubleshooting tips, configuration examples, customer case studies, tutorials and training:

<http://www.cisco.com/go/packet>

- iQ Magazine is the Cisco bimonthly publication that delivers the latest information about Internet business strategies for executives. You can access iQ Magazine at this URL:

<http://www.cisco.com/go/iqmagazine>

- Internet Protocol Journal is a quarterly journal published by Cisco Systems for engineering professionals involved in designing, developing, and operating public and private internets and intranets. You can access the Internet Protocol Journal at this URL:

http://www.cisco.com/en/US/about/ac123/ac147/about_cisco_the_internet_protocol_journal.html

- Training—Cisco offers world-class networking training. Current offerings in network training are listed at this URL:

http://www.cisco.com/en/US/learning/le31/learning_recommended_training_list.html



Chapter 1: Introduction—Planning a Migration to Cisco Unity with the Cisco Unity Bridge

The Cisco Unity Bridge acts as a networking gateway between Cisco Unity and an Avaya Octel system on an Octel analog network. With the Bridge, Cisco Unity subscribers can send messages to and receive messages from Octel subscribers.

This *Cisco Unity Bridge Design Guide* provides you with the information you need to plan a deployment of the Bridge. The focus of this Guide is to discuss the implications of the design decision you will make. The detailed information you will need to implement the plan can be found in the following Bridge documentation:

- The *Cisco Unity Bridge System Requirements, and Supported Hardware and Software* document, available at http://www.cisco.com/en/US/products/sw/voicesw/ps2237/products_system_requirements_list.html
- The *Cisco Unity Bridge Installation Guide*, available at http://www.cisco.com/en/US/products/sw/voicesw/ps2237/prod_installation_guides_list.html
- The *Cisco Unity Bridge Networking Guide*, available at http://www.cisco.com/en/US/products/sw/voicesw/ps2237/products_installation_and_configuration_guides_list.html

Creating a Migration Project Plan—Preliminary Goals and Expectations

Consider the following when planning the migration:

- Find out whether there are factors—external to the tasks that are directly related to the migration—that may affect the migration schedule. For example, personnel or budget constraints may need to be considered.
- Take into account other significant projects that will occur at the same time as the migration, such as phone system changes or e-mail network changes.
- Document the Exchange and Active Directory network, if you intend to install Cisco Unity in a Unified Messaging configuration. This information will help you determine whether network updates are needed.
- Find out whether there are project dependencies that may affect the schedule, such as the acquisition of hardware and software.



- Determine whether there are geographic or administrative limitations to consider that affect which Octel servers can be migrated and when they can be migrated.
- Document the Octel network and servers. This information will help you determine the order in which the Octel servers should be migrated.
- Define the migration phases: determine the order in which the Octel servers will be migrated and whether more than one Octel server will be migrated at a time. In most cases, it makes sense to migrate an entire Octel server to Cisco Unity; however, if necessary, a subset of Octel subscribers on one Octel server can be migrated. In addition, you should plan for a testing phase to address Octel analog networking issues, and a pilot phase to allow the migration team to come up to speed.
- Create a project schedule that details the start and end dates of each phase of the project.
- Determine if there is a target completion date or pace for the migration. Or will the dates be determined by the project plan?
- Investigate and define the tolerance level and adaptive capability of the user population. How much communication and training will be necessary to ensure usability and acceptance of the new system during the course of the migration?

Determining Avaya Dependence and Relationship

Different companies have varying levels of dependency on Avaya. For example, some have a contract with Avaya or a third party for ongoing administration of the Octel network. Some companies play a more active role in the administration of their own Octel network. Communication and coordination with those responsible for administration of the Octel network is crucial during the course of the migration. For all phases of the migration, be sure to consider what work will be required of Avaya or another third party administrator, and the cost of doing the work.

Evaluating Feature Parity and Usability

What are the most critical features of the current voice messaging system? Migration plans should include mapping the critical and popular features of the current voice messaging system to the features in Cisco Unity. You may need to send out a survey to the subscribers to solicit their feedback.

We recommend that you compare the existing voice mail network to what Cisco Unity will provide when it is fully deployed throughout the network.

- Which features in your current system map directly to equivalent features in Cisco Unity?
- Which features do not map directly, but Cisco Unity provides acceptable alternatives?
- Which features do not map to similar Cisco Unity features?
- Which features does Cisco Unity provide that the existing voice mail network does not provide?

When you have created a list, prioritize the items, making note of the following considerations:



- Is it critical for the feature to remain intact during each phase of the migration?
- What would the impact be if the feature were temporarily unavailable or limited during a particular migration phase?

Creating a Migration Planning Team

Key people from different teams need to be involved during the planning and implementation phases of the migration. When forming the migration team, include a representative from:

- The group responsible for the phone network.
- The group responsible for the Octel voice network. There should be someone on the team that has the contacts and authority to request and schedule administrative changes to the Octel network, request network statistics, reports and configuration, and so on.
- The group responsible for the corporate e-mail network.
- The group responsible for the corporate Active Directory network.
- The group responsible for internal voice and e-mail support issues.
- The executive group.
- The group responsible for workplace resources.

Understanding Network Topologies and Data

Octel Network

Gathering General Network Information

Familiarity with the topology and administration of the existing Octel voice mail network is critical to successful migration planning. The following data should be gathered for consideration when making migration decisions:

- Network addressing numbering plan
- Total number of servers
- Total number of subscribers
- Geographical distribution
- Phone system(s)
- Phone network routing
- Analog network stability/risk



- Traffic reports
- Traffic patterns
- Critical vs. non-critical locations
- Current network traffic statistics
- Distribution lists
- Feature packages
- Special Applications

Compiling Specific Information for Each Octel Server in the Network

A worksheet should be compiled for reference during migration planning and deployment. This information will be referenced frequently and should be kept up to date on a regular basis throughout the project. Record the following for each Octel server in the network:

- Location
- Number of subscribers
- Model
- Software release
- Access phone number
- Type(s) of network access in use
- Type(s) of network transmission in use
- Is Octel analog networking licensed?
- Is Octel analog networking currently in use?
- Number of analog ports
- Node number
- Node serial number
- Digits in mailbox
- Mailbox range
- Network address range
- Prefix(es) to dial (from other Octel servers)
- Allow name transmission?



- Transmission schedule (normal, urgent, administrative)
- Node response allowed?
- System Manager contact information
- Avaya contact information

Testing the Health of the Existing Octel Analog Network Prior to Introduction of the Cisco Unity Bridge

Cisco Unity Bridge communication with Octel servers in the network relies heavily upon dependable phone system communication. In many cases, the existing Octel network relies primarily on Octel digital networking for delivery of network messages between nodes. Octel analog networking may be used only as backup connectivity between the Octel servers in the network, or as primary connectivity to a limited number of sites. As a result, testing or verification of analog connectivity between the various Octel servers in the network may be neglected, or the configuration may not be up to date with the existing network.

To avoid the risk of analog connectivity problems negatively affecting the success of the Cisco Unity migration, steps should be taken to test the analog connectivity between the Octel servers in the network and the location(s) where the Cisco Unity Bridge will be located. Testing will allow existing issues to be identified and addressed in the isolation of the Octel analog network. Those responsible for problem resolution can fix the problems in the environment with which they are most familiar, without having to consider whether the Cisco Unity Bridge is contributing to the problem behavior, and without the pressure and time constraints of making changes during deployment of Cisco Unity and the Bridge.

The steps below detail the ideal way to test the Octel network health. If an Octel server is not available for testing, simulate the steps as closely as possible. The cost and resources necessary to conduct the testing prior to introducing the Cisco Unity Bridge to the Octel analog network will be more than justified. Once the Cisco Unity Bridge is introduced, it becomes a challenge to accurately identify the source of communication problems and determine ownership of the resolution.

1. Identify or acquire an Octel server (with Octel analog networking capability) for use as a test system.
2. As closely as possible, physically locate the test Octel server where the Cisco Unity Bridge will be located. Use the same environment in which the Bridge will exist, including applicable IP/analog gateways, phones system, hunt groups, and so on.
3. Identify existing test mailboxes on each production Octel server in the network. If none are available, request their addition.
4. Configure an Octel analog networking node profile on each Octel server in the network with the serial number of the test Octel server.
5. Create a test mailbox on the test Octel server.
6. Configure an Octel analog networking profile on the test Octel server for each Octel server in the network.



7. Send test messages in all routes and in both directions, from the test Octel server to all production nodes and from each production node to the test Octel server.
8. Test other critical analog networking functionality, such as administrative name retrieval.
9. For each analog route between the test Octel server and the production Octel servers, document any failures that occur, or any other questionable behavior.
10. Engage Avaya (or whoever is responsible) to investigate any connectivity problems within the existing Octel voice network. Provide details for all failures, and request investigation and resolution.
11. As issues are resolved, retest to verify the resolution.
12. When message delivery is successful between the test Octel and all production servers:
 - Document the phone number, extension, and dialing sequence configured on each node profile on the test Octel. These numbers should be used when configuring the Octel Node profiles on the Cisco Unity Bridge server(s).
 - Document the phone number, extension, and dialing sequence configured on each production Octel for the test Octel server. These numbers should be used when configuring the production Octel servers to communicate with the Cisco Unity Bridge server(s).
 - Document all issues encountered and the steps that were taken to resolve them. This will provide a reference resource if the problems return, or if similar behavior is observed.

Cisco Unity Voice Network—Present and Future

Make note of the following:

- What, if any, Cisco Unity systems have already been deployed within the organization?
- What will the Cisco Unity network look like after successful deployment of the Cisco Unity Bridge?

Consider the following:

- Network addressing numbering plan
- Total number of servers
- Total number of subscribers
- Geographical distribution
- Phone system(s)
- Phone network routing
- Which Cisco Unity clients will be used?
- Will the configuration(s) be Unified Messaging, Voice Messaging, or both?



Understanding Interoperability During Migration

Automatic Bridge Subscriber Creation, Modification, and Deletion

As part of the Cisco Unity Bridge networking feature, the CsBridgeConnector component on a Cisco Unity bridgehead server automatically processes text names that are received from Octel servers via the Cisco Unity Bridge. Because of differences in the implementation of addressing by name via the phone on Cisco Unity vs. Octel, name searching on Cisco Unity for the resulting auto-created first and last names does not always occur as expected.

Below is a brief description of the behavior that occurs when you address an Octel NameNet entry by name via the Octel phone conversation, and when you address a Bridge Subscriber by name via the Cisco Unity phone conversation.

Addressing via Octel

Octel systems use a single 3- to 20-character (ASCII 7 bit) field for mailbox name. This single field is used for matching when an Octel subscriber is addressing by name via the phone.

This same field is the string that is passed when another Octel node requests a name for a mailbox via Octel analog networking. This same information is subsequently stored in the NameNet directory of the requesting node to allow addressing by name on the remote system. Therefore, NameNet directory name spellings are consistent throughout all Octel nodes on the Network.

Typically, these mailbox names are stored last name first. Whether the names are stored first name first or last name first, the format is usually kept consistent throughout all nodes on the network. No matter which format a customer has chosen to use, subscribers addressing by name have no configuration options on how they wish to spell the names. Spelled names are matched against this single mailbox name field, as entered.

Addressing via Cisco Unity

Cisco Unity has three different fields for storing the mailbox name of a subscriber: First Name, Last Name (both with a maximum of 32 Unicode characters), and Display Name (with a maximum of 128 Unicode characters).

The First Name and Last Name fields are used for matching when a Cisco Unity subscriber is addressing by name via the phone. This allows subscribers the flexibility to personalize their options for addressing by name; each subscriber can choose either first name first or last name first.

Display Name is a display only field that displays when a subscriber is searching on names in a PC-based client application.

There are a number of decisions to be made related to the automatic creation, modification, and deletion of Bridge subscribers, and how to automatically process the information received.



For detailed discussions of these issues, refer to the “About Bridge Networking” chapter of the *Cisco Unity Bridge Networking Guide*. This guide is available at http://www.cisco.com/en/US/products/sw/voicesw/ps2237/products_installation_and_configuration_guides_list.html.

High-Level Example Migration Plan in Five Phases

Planning Phase

- Establish migration planning team
- Set goals and expectations
- Determine Avaya dependence and relationship
- Conduct user surveys
- Evaluate feature parity and usability
- Document Octel network information
 - General Octel network information
 - Octel server networking details
- Document target Cisco Unity end state
- Determine dependencies
- Identify support teams
 - Pre-production phases
 - Day one support
 - On-going support
- Identify end-user training requirements
- Establish proposed migration schedule
 - Lab testing
 - Alpha pilot
 - Site migration order and priorities
- Identify project risks



Lab Testing Phase

- Create and communicate a schedule
- Document entrance criteria and dependencies
 - Identify lab test team
 - Acquire all necessary hardware and software
 - Obtain necessary licenses
 - Arrange replication of the corporate database
 - Communicate plans to Avaya or to the Octel network administrator
 - Test the mailboxes configured on Octel production servers
 - Create test requirements and procedures
 - Obtain applicable approvals
- Deploy Exchange and Cisco Unity for pilot location
- Deploy Cisco Unity bridgehead server
- Deploy Cisco Unity Bridge(s)
- Prepare the network
 - Resolve names and IP addresses
 - Grant permissions to the Cisco Unity Bridge(s) to relay e-mail through the Exchange SMTP virtual server
 - Configure SMTP connectors (if applicable) for routing between Exchange and the Cisco Unity Bridge(s)
 - Extend the Active Directory schema
 - Set up the Voice Connector for Bridge Networking
- Configure the Cisco Unity server designated as the bridgehead
 - Designate the bridgehead server
 - Set Bridge options
 - Configure the subscriber template that will be used for auto-created Bridge subscribers
 - Create and configure Bridge delivery locations
- Configure settings on all Cisco Unity servers in the network
 - Set the primary location addressing options



- Create Cisco Unity subscriber accounts for lab test users
- Add the serial number and mailbox ID to Cisco Unity subscriber accounts
- Configure the phone system for the Cisco Unity Bridge(s)
- Configure the Bridge(s)
 - Install the License File Wizard and the license file
 - Configure the system settings and Digital Networking settings
 - Configure the Unity Node profile(s)
 - Configure the Octel Node profile(s)
 - Configure the line settings
- Configure the Octel servers
 - Create an Octel analog networking profile for Cisco Unity and the Bridge
- Create Bridge subscribers
- Conduct tests
 - Message delivery tests
 - MAC and administration tests
- Verify that exit criteria have been met

Pilot Testing Phase

- Create and communicate a schedule
- Document entrance criteria and dependencies
 - Verify completion of lab test phase
 - Acquire all necessary hardware and software
 - Obtain necessary licenses
 - Communicate plans to Avaya or to the Octel network administrator
 - Test mailboxes configured on Octel production servers
 - Obtain applicable approvals
 - Draft a schedule for the migration
 - Determine the Cisco Unity Bridge server location



- Determine Cisco Unity Bridge server Octel Node distribution, if multiple Bridge servers will be deployed
- Determine Voice Connector location and dedicated server requirements
- Plan to deploy Cisco Unity and Exchange in a data center where the Cisco Unity bridgehead will be located
- Plan to deploy Cisco Unity and Exchange in the data center of the pilot site
- Identify pilot users
- Identify and communicate special addressing considerations for pilot users
- Deploy Cisco Unity bridgehead server
- Deploy Cisco Unity Bridge(s)
- Prepare the network
 - Resolve names and IP addresses
 - Grant permissions to the Cisco Unity Bridge(s) to relay e-mail through the Exchange SMTP virtual server
 - Configure SMTP connectors (if applicable) for routing between Exchange and the Cisco Unity Bridge(s)
 - Extend the Active Directory schema
 - Set up the Voice Connector for Bridge Networking
- Configure the Cisco Unity server designated as the bridgehead
 - Designate the bridgehead server
 - Set Bridge options
 - Configure the subscriber template that will be used for auto-created Bridge subscribers
 - Create and configure Bridge delivery locations
- Configure settings on all Cisco Unity servers in the network
 - Set the primary location addressing options
- Create Cisco Unity subscriber accounts for pilot users
- Add the serial number and mailbox ID to Cisco Unity subscriber accounts
- Configure the phone system for the Cisco Unity Bridge(s)
- Configure the Bridge(s)
 - Install the License File Wizard and the license file



- Configure the system settings and Digital Networking settings
- Configure the Unity Node profile(s)
- Configure the Octel Node profile(s)
- Configure the line settings
- Configure the Octel servers
 - Create an Octel analog networking profile for Cisco Unity and the Bridge
 - Configure necessary prefixes for pilot Cisco Unity subscribers
- Create Bridge subscribers
- Conduct tests
 - Message delivery tests
 - MAC and administration tests
- Verify that exit criteria have been met

Migrate Location 1 Phase

- Create and communicate a schedule
- Document entrance criteria and dependencies
 - Verify completion of pilot test phase
 - Communicate plans to Avaya or to the Octel network administrator
 - Plan to deploy Cisco Unity and Exchange in the data center of the site to be migrated
- Delete from the bridgehead server the Bridge subscriber accounts for subscribers who are being migrated
- Create Cisco Unity subscriber accounts on the respective home server(s) for subscribers who are being migrated, including legacy mailbox and serial numbers
- Delete from the applicable Bridge server the Octel Node that is being migrated
- Add to all Bridge servers the Unity Node that is being migrated
- For the serial number being migrated to Cisco Unity, modify the Octel analog networking profile on each Octel system to use analog transmission to the phone number of the applicable Bridge server
- Remove from the network the Octel that is being migrated
- Delete from the bridgehead server the Bridge delivery location for the Octel node that is being migrated



- Conduct tests
 - Message delivery tests
 - MAC and administration tests
- Verify that exit criteria have been met

Migrate Location 2 Phase

- See all tasks in the “Migrate Location 1 Phase” section.



Migrating from Octel to Cisco Unity—An Illustrative Design Story

The following design story illustrates a typical migration from Octel to Cisco Unity via the Cisco Unity Bridge (note that the design story makes use of a fictional company, “ComPany LLC”). The narrative takes you through the various migration stages, explaining the reasons behind the decisions made, and describing how the choices that were made affected the implementation.

Introduction

ComPany LLC had employees in multiple offices across the United States, as well as in several offices in Europe and Asia. Prior to beginning the migration to Cisco Unity, they used an Octel Network for voice mail worldwide. Each branch office had an Octel system, and the corporate headquarters in New York had four Octel systems. Aria systems were used in the United States, and Serenade systems were used in Europe and Asia. Within each region, Octel digital networking was used, and connectivity between the Aria and Serenade systems was provided through Octel analog networking.

ComPany decided to implement Cisco Unity as their new voice messaging system. Their existing Octel environment was primarily digital, with analog transmission used only for failover. At the end of the implementation, when all systems were converted to Cisco Unity, voice mail networking was entirely digital. However, it is important to note that during the transition period between voice messaging systems, the use of analog networking was required. This meant that analog connectivity testing was done prior to implementation, and analog troubleshooting staff was available throughout the migration.

Prior to the migration, all Octel systems were administered by Avaya, and the phone system, Exchange, and Active Directory were administered in-house. The Cisco Unity network would also be administered and supported by the in-house teams. This meant that Avaya support needed to be coordinated during the migration, and the in-house teams needed to be trained to support voice messaging.

Before working on a migration strategy, ComPany realized it was best to understand both the starting point and desired end point. Therefore, ComPany began by documenting their existing Octel network. They also created and distributed a survey to understand the voice mail features used actively by their employees, as well as identifying unused features in the current system, and a wish list of desired functionality. Because Active Directory and Exchange were already deployed company-wide, they would be introducing Cisco Unity into the existing environment to provide Unified Messaging. This meant it was critical that they also document their existing Active Directory and Exchange implementation. When all of the data was compiled and evaluated, they began planning their Cisco Unity network.

Migration Phase One: Planning

Through the employee survey, and documentation of their existing environment and planned environment, ComPany identified the functionality that was critical to their daily business. In a migration environment where two unique systems interoperate, there are limitations on voice messaging that do not exist in a homogeneous environment. Taking this into account, ComPany determined there were some things that had



to work properly regardless of the costs (real and perceived), and others that could be compromised on during the migration. At their first migration planning meeting, they compiled and prioritized a list of requirements within three categories: Critical, Beneficial, and Optional.

Critical Functionality

- Limit the amount of money spent for Avaya administration
- Standardize the dial plan
- Prove the concept
- Configure the Bridges to allow for the most efficient delivery
- Use the current infrastructure
- Determine strategy for handling distribution list impacts
- Retain current addressing scheme

Beneficial Functionality

- Provide voice name confirmation when addressing all users
- Limit hardware costs
- Minimize impacts to intra-corporate office communications
- Minimize PSTN toll charges

Optional Functionality

- Allow outside callers to call a single number and be able to reach the voice mail of any subscriber
- Retain Octel messages after migration
- Allow GUI client access
- Keep the conversation consistent with the conversation of the current system
- Allow extended absence notification
- Provide a broadcast messages feature

During the migration there would be additional technical support overhead required, and varied functionality available to users depending on the system they use. Therefore, ComPany also decided that the migration should be completed as quickly as feasible. They imposed a six-month time restriction on the portion of the migration that most affects users (that is, six months from the pilot implementation date to the final planned Octel decommissioning date).

With the priorities and time frame decided, the technical team began planning a phased deployment strategy that would provide for all the critical elements, and allow for implementation of beneficial and optional elements based on return on investment criteria. They determined that the ROI considerations were:



monetary cost, administrative resources, user impact, schedule impact, and long term value. The phased conversion to Cisco Unity was chosen to allow training and support to occur at a pace that the technical team could handle.

ComPany also decided to take this opportunity to standardize mailbox numbers for all employees to 7 digits. This would allow employees to send a voice message to another employee by using the same number they use to call that employee. Currently employee mailboxes were distributed across Octel systems, based on geographic location; that same means of distribution would be carried across to Cisco Unity.

During this initial planning phase, ComPany also decided on a plan for two small sites in Asia. These sites used Octel voice mail, but Exchange had not yet been deployed. ComPany did not want to deploy Cisco Unity or Exchange at these two sites until other issues could be resolved, and the time frame for this was uncertain. Voice messaging with these Asian sites was minimal, and there was no problem with keeping in place the Cisco Unity Bridge solution implemented for the phased migration, to allow continued voice messaging connectivity.

The technical implementation team met several times to produce the following outline of the implementation details and schedule.

Cisco Unity Servers

- Cisco Unity servers co-located in each data center with the partner Exchange server
- Primary location configuration and addressing options defined
- Cisco Unity subscriber account attributes defined
- Distribution List administration policy defined

Cisco Unity Bridgehead Server

- Cisco Unity bridgehead server located in the corporate data center
- Bridge Options defined
- Unknown Caller settings defined
- Bridge delivery location configuration defined
- Auto-created Bridge subscriber settings defined
- Pre-populated directory with some Bridge subscriber accounts, including recorded voice names

Exchange Servers

- Additional Exchange server added for the Voice Connector
- Voice Connector Exchange server located in the corporate data center
- Plan defined for adding a second Voice Connector, with criteria defining when it would be necessary



- Necessary mail routing changes documented (allow relaying, SMTP connector, MX records)

Octel Systems

- Plan defined for any necessary Avaya administrative support
- New serial number configured on the network for testing and pilot
- Octel server settings for Bridge nodes defined
- Distribution List administration policy defined

Cisco Unity Bridge Servers

- Delivery Schedules defined to allow for the most efficient delivery
- Two Bridge servers, one located in the corporate data center (with U.S. and Asia Octel nodes defined) and one in the London data center (with Europe Octel nodes defined)
- Bridge server settings defined

Administrative

- Pilot group chosen in Stamford, Connecticut
- Organizational changes that are required in Active Directory defined (schema extensions, new OU for Bridge subscribers, locations OU)
- Naming conventions defined
- OS and Exchange patch installation scheduled
- Third-party software requirements defined and testing scheduled
- Backup strategy defined and tested

The order of migration to Cisco Unity was determined based on the locations between which the majority of the voice mail traffic occurred. The goal was to minimize messaging between users on different voice mail systems. The greatest traffic was among the Octel systems at the corporate offices, next was traffic among the European sites, and finally the traffic between the corporate offices and Stamford, Connecticut. A relatively moderate amount of voice messaging traffic occurred between the other sites. The following order was chosen for migration:

1. Stamford pilot users.
2. Remaining Stamford subscribers.
3. Subscribers on the four corporate Octel systems.
4. Other Octel systems in the U.S.



5. Octel systems in Europe.

Bridge networking infrastructure was implemented to handle the estimated maximum messaging load from the time at which all Stamford subscribers were using Cisco Unity, to the time at which the corporate site was also converted to Cisco Unity.

Proof of concept was an important requirement and each site was dependant on Octel networking for daily business, so it was decided that a new node would be introduced to the Octel network, first for testing and then as a pilot environment for a group of production users. The cost of having this new node programmed on every Octel was balanced by the benefits of a small-scale test of the implementation plans in the production environment.

In preparation for the next phase, ComPany needed to make the necessary modifications to the existing systems, and then to begin acquiring and configuring the additional hardware, software, and licensing that would be required for Bridge networking. Because much of the infrastructure would need to be in place to begin the testing phase, the scheduled start date was based on completion of these tasks. The testing phase was scheduled to last one month, with the pilot to follow immediately after. Given the pilot start date and the six-month migration plan, key milestones and dependencies were identified for the following: management approval, Avaya support, testing, user notification and training, and implementation of each system.

Migration Phase Two: Testing

The effort to determine and test the planned configuration and user settings for Cisco Unity was done separately as part of the Cisco Unity implementation planning. This migration test phase was specifically designed to test the planned implementation for migration.

Prior to beginning the Cisco Unity Bridge testing, an Octel system with a new serial number, node, prefix, and phone number was added to the network, and test mailboxes were created on all Octel systems. Bi-directional message flow between Stamford and all other sites was tested by using Octel analog networking. Adjustments to message delivery settings (for example, retry interval and dial string) were made as necessary for each site. Because many voice mail networking routes used digital networking, testing the analog networking with an Octel allowed any existing analog connectivity issues to be resolved before introducing the Bridge variable.

To begin Bridge testing, the network needed to be prepared by extending the Active Directory schema and installing the Cisco Unity bridgehead server, the Cisco Unity pilot server, the Cisco Unity Bridge servers, and the Voice Connector server. On each server, the options and settings were configured, and the following objects were created, according to the conventions defined in the planning phase:

- On the pilot Cisco Unity server, test Unity subscribers with legacy Bridge properties
- On both Bridge servers, a Unity Node that represented the serial number previously used on the test Octel
- Bridge delivery locations for each Octel system (including prefixes)



- On the U.S. Bridge, Octel Nodes for each U.S. and Asia Octel system
- On the London Bridge, Octel Nodes for each Europe Octel system
- Test Bridge subscribers
- Test public distribution lists with both Cisco Unity and Bridge subscribers

Bridge placement in the U.S. and Europe was planned to minimize PSTN toll charges and the impact of the analog connectivity issues. Message delivery with this configuration during the testing phase proved successful, and thus allowed the Octel node delivery schedules on the Bridge to be configured for timely message delivery.

A test plan was developed to test Cisco Unity Bridge networking for the following:

- Bi-directional message flow
- Blind addressing
- Subscriber addressing
- Administration
- Directory synchronization

This test plan was first used in the testing phase, but was also reused as a sanity check at each phase of the migration.

Based on the findings of the test phase, ComPany developed internal tracing and troubleshooting reference materials for tier 1 and tier 2 technical support.

The goals of the testing phase were to evaluate network impacts, test Cisco Unity and Bridge administration, evaluate directory synchronization, develop a test plan, understand how to troubleshoot Bridge networking, and test message delivery. These goals were accomplished on schedule, so the creation of user documentation and training materials began in preparation for the pilot phase.

There was one final issue that needed to be considered before the pilot phase could begin, and that was a plan for handling administrative tasks. A support plan was in place for the existing Octel systems, and a new plan had been outlined for Cisco Unity at the point at which the migration was completed. However, in the interim while both systems were in place, additional administration and coordination was required. Therefore, ComPany developed a process to handle subscriber moves, adds, and changes during the migration, including public and system distribution list updates, and documented Bridge directory synchronization and NameNet implications.



Migration Phase Three: Pilot

The pilot site was chosen because of its size and proximity to the corporate offices, and because of the Octel configuration. The Stamford Octel homed 400 subscribers, divided among three addressable prefixes. For the pilot, only the mailboxes that corresponded to one prefix were moved to Cisco Unity. On each of the Octel systems, this one prefix was changed to correspond to the new node profile and serial number now being used for communicating with the Cisco Unity Bridge. This allowed network message addressing to remain the same for all employees.

The infrastructure for the Stamford office was housed at the corporate offices, and the Cisco Unity server would be located there as well. The Cisco Unity server designated to home the pilot users was scaled to handle all 400 subscribers who would be homed there at the completion of the migration.

The goals of the pilot phase were for ComPany to see the results of their requirements and compromises in a live environment, to obtain feedback on the Cisco Unity implementation and on its interoperability with the Octel environment, and to get a feel for message delivery timing and reliability. To obtain the best feedback on the implementation, it was important that the pilot group include a cross section of the voice mail user base. Because the 100 pilot users were chosen based on their phone prefix, they represented many organizations and job functions.

The pilot implementation was also the first opportunity to test the user training, documentation, and technical support. The pilot users were notified in advance and provided with high level information on Cisco Unity and Bridge networking. Over a weekend, new mailboxes with legacy Bridge properties were created for the pilot users, and their phones were changed to forward to Cisco Unity for voice mail. Their Octel mailboxes no longer accepted messages, but they were left in place for one week to allow subscribers to review existing messages.

On day one, the pilot subscribers were provided with written documentation and an opportunity to attend a live training session on Cisco Unity. The majority of the documentation covered Cisco Unity features and functionality, especially any features or functions that were unavailable, new, or different in Cisco Unity. In addition, material was presented on the issues subscribers might see during the migration phase, primarily regarding how to address network messages, including details on blind addressing, auto-creation of Bridge subscribers, and Bridge subscriber addressing via the phone (TUI) and online (GUI) user interfaces.

The pilot phase lasted three weeks, during which time the test plan was completed, necessary configuration modifications were made, and feedback from subscribers was requested on both the functionality and training. The decision to proceed to the next phase included evaluation of network and support impacts, and implementation of feedback received from subscribers and the technical support teams.

Migration Phase Four: First Octel Replaced with Cisco Unity

Phase four began with advance notification to the remaining Stamford Octel subscribers. Once again, over a weekend, new subscriber accounts were created in Cisco Unity for each migrating subscriber. The Stamford Octel was removed from the network; again, subscribers were allowed one week to review existing



messages, but no new messages would be received on this system. The Cisco Unity server used in the pilot phase was now home to all 400 subscribers from the Stamford Octel system.

To complete this migration phase, the migration team did the following:

- Deleted any existing Bridge subscriber accounts for the migrating Stamford subscribers
- Created Cisco Unity subscriber accounts with legacy properties for migrating subscribers
- Deleted the Octel Node for the Stamford Octel from the U.S. Bridge server
- Modified Octel profiles for the pilot serial number to include two additional prefixes
- Deleted the Bridge delivery location for the Stamford Octel from the Cisco Unity bridgehead
- Removed the Stamford Octel from the network

On day one, the users were again provided with written documentation on Cisco Unity, and had an opportunity to attend a live training session.

Note: Cisco Unity provides for creation of personal distributions lists, and the documentation given to users included a recommendation that subscribers use these lists only for employees in their office until the migration was completed. Though it is possible to add Bridge subscribers and Cisco Unity subscribers network-wide to the lists, ComPany determined that during the migration, the support costs outweighed the benefits of this functionality. Meanwhile, public distribution lists were made available, and individual assistance was provided when necessary to ensure that distribution list needs were met during the migration.

During this time, all technical support resources across ComPany were given training and reference materials on Cisco Unity. Though many areas would not be migrating to Cisco Unity for some time, the entire voice mail network was now a heterogeneous environment, and Octel users could also be affected by the changes, because they would be addressing messages to Cisco Unity subscribers. Because the environment was constantly changing, a web page was created with information on the current migration status of each site. This proved to be a valuable resource for both the support staff and the employees.

As in phase three, evaluations of the network impacts and user feedback were done. No new issues were discovered, and the preparation for the conversion of the corporate office to Cisco Unity was completed. The next phase began on schedule two weeks after the end of phase four.

Migration Phase Five: Second Octel Replaced with Cisco Unity

The corporate office Octel systems were migrated to Cisco Unity next. This phase would be made up of the largest number of subscriber conversions, and technical resources were planned accordingly. In this phase, Cisco Unity would represent multiple serial numbers previously assigned to Octel systems.

As before, subscribers were provided with advanced notice of the voice mail changes, and were given Cisco Unity documentation and training.

To complete this migration phase, the migration team did the following:



- Deleted any existing Bridge subscriber accounts for the migrating New York subscribers
- Created Cisco Unity subscriber accounts with legacy properties for the migrating subscribers
- Deleted from the U.S. Bridge the Octel Nodes for the New York Octel systems
- Added to both Bridges the Unity Nodes for the New York serial numbers
- Modified profiles for the New York serial numbers on the Aria systems, to route to the U.S. Bridge phone number via Octel analog networking
- Modified profiles for the New York serial numbers on the Serenade systems to route to the London Bridge phone number via Octel analog networking
- Deleted from the Cisco Unity bridgehead the Bridge delivery locations for the New York Octel systems
- Removed the New York Octel systems from the network

The test plan was run again in this new configuration, and the impacts and feedback were evaluated by the support team.

Now that the corporate migration was completed, a process was documented that incorporated information from both the Stamford and corporate office migrations, detailing the following:

- Installing and configuring each Cisco Unity
- Testing connectivity within the Cisco Unity network
- Testing Octel connectivity
- Migrating subscribers

Documenting this process was especially important, because the remaining sites were located around the world, and local support teams would need to be relied on to handle the majority of the Cisco Unity implementations at their sites.

Migration Phase Six: Additional Octel Systems Replaced with Cisco Unity

Additional Cisco Unity servers were configured to replace each Octel in the U.S. and then in Europe as the migration proceeded. The documented processes for migration were repeated as each Cisco Unity system was built and deployed at the remaining sites.

One or two Octel systems were migrated at a time, depending on size and physical location. In each case the same serial number was retained so that the remaining Octel systems would only need to be updated to use analog networking to route calls to the appropriate Bridge phone number, instead of to the now decommissioned Octel system. With each migrated system, both Bridge servers were programmed with the new Unity nodes, and the corresponding Octel node and Bridge delivery location were deleted.



When the final U.S. site was migrated to Cisco Unity and the Octel node was deleted from the New York Bridge, the New York Bridge now handled voice messaging only to the two Asia Octel systems. All other voice mail traffic was either internal to the Cisco Unity network, or routed through the London Bridge to the Europe Octel systems.

At several points during the migration, evaluations of documentation and message delivery performance were done, and modifications were made as necessary. For example, London was the first site in Europe to be converted, and because the Europe sites used Serenade systems, some adjustments were necessary to the subscriber documentation and training materials.

Migration Phase Seven: Planned Migration Completed

When the final Octel system in Europe was replaced with Cisco Unity, the last Octel node configured on the London Bridge was deleted. Because each Unity node had also been programmed on the New York Bridge, the London Bridge was no longer necessary, and so it was removed from the network.

Because the sites in Asia were still using Octel voice mail, the New York Bridge, Cisco Unity bridgehead server, Voice Connector Exchange server, and legacy properties on each Cisco Unity subscriber account remained in place to allow voice messaging between Cisco Unity and Octel subscribers. A plan was put in place for the support team in New York to handle ongoing moves, adds, and changes involving the Asia systems, and for support of the Bridge networking systems. The IT organization continued their efforts to migrate the Asia sites to Exchange, and in correlation to Cisco Unity. When the migration to Unified Messaging was completed, the New York support team would be responsible for removing the remaining components of Bridge networking.

The majority of the implementation team refocused on other efforts, as the Cisco Unity voice mail systems were now supported by the in-house IT staff that had been trained throughout the migration process. The success of the migration was communicated to all employees, along with information on voice messaging to the remaining Octel users in Asia for the near future, and the updated voice mail support process.



Chapter 2: Migration Details—Network-Wide Settings

Numbering Plans and Network Addressing

Ideally, network voice messaging numbering plans are set up to be consistent with phone system number plans. This allows voice mail subscribers to send network voice messages by using the same sequence of numbers they use when placing a phone call. Keep in mind that the network address length should be consistent throughout your organization, and a 7- or 10-digit network address length is usually used.

When a voice message is exchanged between two systems via Octel analog networking, there are two pieces of information that are used to uniquely identify the sender and the recipient: the node serial number and the mailbox number for both the sender and the recipient. Addressing prefixes exist to allow subscribers who are addressing a network message to do so by using the 7- or 10-digit network address. Multiple prefixes can be assigned to a single location to allow routing of different network addresses to the same node serial number. These prefixes are used only for addressing. When the voice mail server has identified which location the message needs to be routed to and the destination mailbox, the prefix is no longer needed. This means that the prefix itself is not exchanged between systems as part of message delivery.

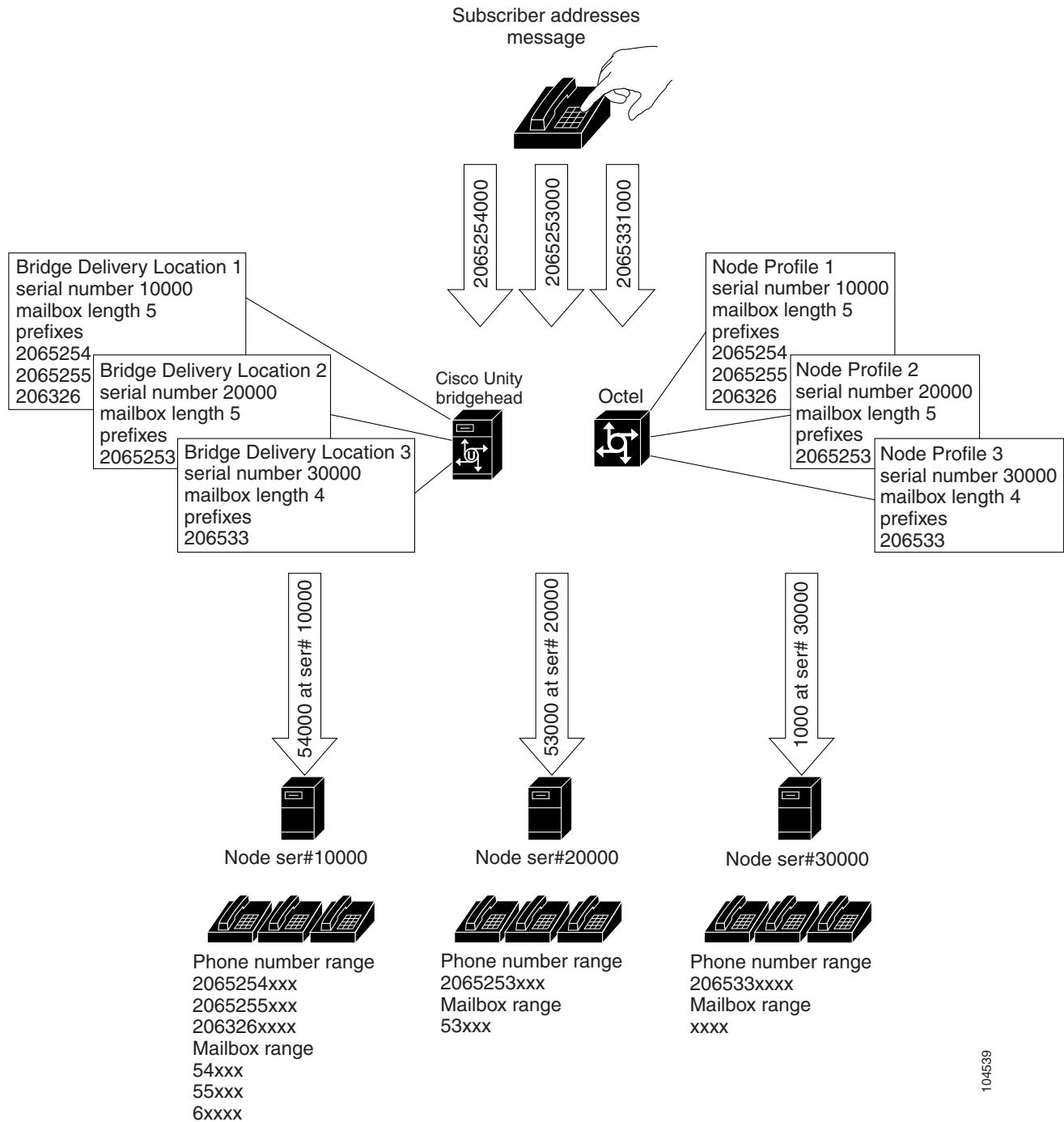
On an Octel system, a node profile is configured for each node (remote system) with which it will communicate. The node profile includes, among other things, the serial number of the remote system, the number of digits in a mailbox on the remote system, and the addressing prefixes that are used for local subscribers when addressing network messages to this node.

Similarly, on a Cisco Unity system, a Bridge delivery location is configured for each Octel node with which the Cisco Unity Bridge will communicate. The Bridge delivery location includes the serial number of the remote system, the number of digits in a mailbox on the remote system, and the addressing prefixes that are used for local subscribers to address network messages to this node.

Figure 1 shows an example of network addressing, configured similarly on Cisco Unity Bridge delivery locations and Octel analog networking node profiles.



Figure 1: Network Addressing



104539



In a Cisco Unity voice network where all of the systems access the same directory, only one Bridge delivery location needs to be configured for each Octel server. In the Octel voice network, each server accesses its own local directory; therefore, the node profiles for all other nodes need to be configured on each server.

Logical Octel Node Assignment Within the Cisco Unity Directory

Cisco Unity 4.0(3) and later and Cisco Unity Bridge 3.0(1) and later are designed to allow flexibility in numbering plans. When the Octel subscribers for a particular server are migrated to Cisco Unity, the administrator has the ability to retain the previous Octel node serial number and mailbox identity for each subscriber. In this manner, the Cisco Unity identity of the subscriber can be configured optimally for functioning within the Cisco Unity network, independent of the numbering plan used within the Octel network. When a Cisco Unity subscriber sends or receives a voice message via the Cisco Unity Bridge, the Legacy Mailbox and Unity Node Serial Number attributes of the subscriber are used. For all other Cisco Unity functions these two fields are ignored.

Figure 2 and Figure 3 illustrate this for an Octel with the node ser# 10000, whose subscribers are migrated to the Cisco Unity organization.

Figure 2: Subscribers on Octel Node Ser#10000 Prior to Migration to Cisco Unity

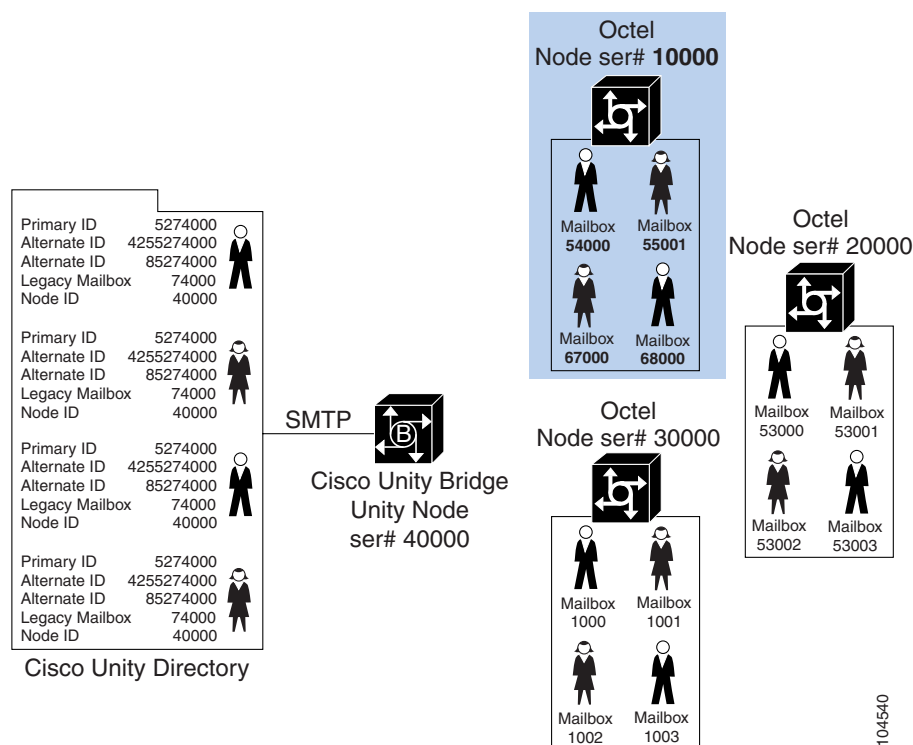
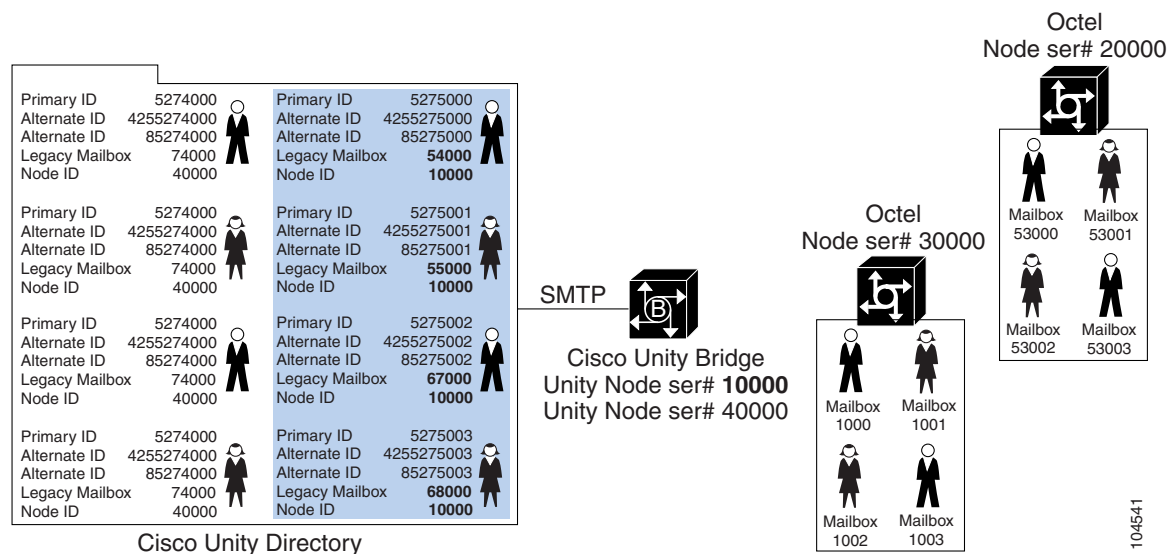




Figure 3: Subscribers on Octel Node Ser#10000 Subsequent to Migration to Cisco Unity



The numbering plan flexibility provides many benefits:

- The configuration changes on other Octel systems in the network are minimized when subscribers at one Octel node migrate to Cisco Unity.
- The Cisco Unity administrator can take full advantage of primary and alternate ID capabilities, to optimize the voice mail numbering plan for the organization.
- More flexibility is possible when phone system or phone number changes happen concurrently with the voice mail migration.

Distribution Lists

Cisco Unity Subscribers in Octel Distribution Lists

When Cisco Unity and the Bridge are configured to communicate with Octel servers via analog networking, the inclusion of Cisco Unity subscribers in a distribution list on an Octel server is no different from including any other subscriber from a remote Octel analog networking node. The network address of a Cisco Unity subscriber can be added to a distribution list whether or not a NameNet directory entry exists on the local Octel server.

However, a distribution list created on one Octel server is not necessarily available to Octel subscribers on other Octel servers in the network. The administrative processes and tools used for updating distribution lists on multiple Octel servers in the network vary. Check with the Octel administrator for details specific to your situation.



When Cisco Unity represents Octel nodes in the network, the presence of Cisco Unity does not necessarily require changes to the processes and tools used for updating distribution lists. However, the number of moves, adds, and changes associated with a migration from Octel to Cisco Unity will be larger than normal. Therefore, it is important to consider how the presence of Cisco Unity may affect distribution lists on the Octel servers, and to understand the distribution list modification process.

Octel Subscribers in Cisco Unity Distribution Lists

In the Cisco Unity network, a Bridge subscriber object representing the remote Octel subscriber must be present in the directory in order to add an Octel subscriber to a public or private distribution list. Be sure to take this into consideration when planning how Bridge subscriber objects will be administered in the Cisco Unity network. Carefully read the “About Bridge Networking” chapter in the *Cisco Unity Bridge Networking Guide*, which describes in detail the relevant alternatives and behavior. (The *Cisco Unity Bridge Networking Guide* is available at http://www.cisco.com/en/US/products/sw/voicesw/ps2237/products_installation_and_configuration_guides_list.html.) Most importantly, understand the conditions under which you will delete a Bridge subscriber object, either automatically or manually.

When a Bridge subscriber object is deleted, it is removed from any distribution lists of which it is a member. This is true of both private and public Cisco Unity distribution lists. When subscribers from an Octel server are being migrated to the Cisco Unity network, any Bridge subscriber objects formerly associated with those subscribers must be deleted from the Cisco Unity bridgehead server. Then, Cisco Unity subscriber objects for the migrated subscribers are added on the Cisco Unity server designated as their home server. The distribution list membership for the deleted Bridge subscribers is now gone, and the new Cisco Unity subscribers must be added to the desired lists. This is one of the more challenging aspects of a migration from Octel to Cisco Unity. In addition, public and private distribution lists in Cisco Unity are significantly different implementations, and the alternatives available to handle the two different types during migration differ as well.

Cisco Unity Public Distribution Lists

Public distribution lists in the Cisco Unity network are stored in the global directory and are available for use by subscribers on all Cisco Unity servers. Because they are kept in the global directory, any Cisco Unity server in the network has the ability to determine which public distribution lists a particular subscriber object is a member of. For this reason, there are a number of possibilities available for ensuring that deleted Bridge subscribers appear in the desired distribution lists when re-added as full Cisco Unity subscribers.

Regardless of the approach chosen, it is always a good idea to periodically export the Cisco Unity public distribution list membership for Bridge subscribers on the Cisco Unity bridgehead server. This will ensure there is always a record of this data available if recovery is ever necessary.

In a situation where a Bridge subscriber object is being removed, a new Cisco Unity subscriber object will be created in its place, and membership in the same public distribution lists is desired, you should export the distribution list membership information for the Bridge subscriber, before the object is deleted. Then, the



exported information can be imported along with the other values for the new Cisco Unity subscriber, by using the Cisco Unity Bulk Import tool.

Whether the Cisco Unity public distribution list membership for new subscribers will be based on previous Bridge subscriber objects or not, remember that the Cisco Unity Bulk Import tool allows you to specify public distribution membership in the CSV file used for import. Multiple public distribution lists can be specified for each import record, and each record can specify a unique set of public distribution lists.

The Cisco Unity Bulk Import tool can also be used to update public distribution list membership for existing subscriber objects. If it is ever necessary to change distribution list membership for a large group of subscriber objects after they have been created, this tool provides the ability to specify the changes in a CSV file and update all records in a single step.

Cisco Unity subscriber templates also provide a means for specifying public distribution list membership for subscribers at the time of creation. If a large number of subscribers are to be added to the same public distribution list(s), specify the list(s) in the subscriber template used to import or create the subscribers.

Cisco Unity Private Distribution Lists

Unlike public distribution lists, Cisco Unity private distribution list membership information is not stored in the global directory. Information is available for the private lists of a particular subscriber, but only locally on each Cisco Unity server. In addition, membership information for a subscriber—detailing which private distribution lists a particular subscriber is a member of—is not available.

When a Bridge subscriber object is deleted in the process of migrating someone to Cisco Unity, existing Cisco Unity subscribers may experience a mysterious disappearance of the Bridge subscriber from their private distribution lists. Therefore, we recommend that when Bridge subscriber existence within the Cisco Unity network is known to be temporary or subject to frequent change—which is common in Octel to Cisco Unity network migrations—you advise Cisco Unity subscribers to avoid inclusion of Bridge subscribers in their private distribution lists.

Instead, provide Cisco Unity public distribution lists in the network to include any commonly addressed groups of Bridge subscribers. Inform Cisco Unity subscribers of these lists, and recommend that they be used rather than private distribution lists. The Cisco Unity administrator can maintain these lists as the migration progresses, restoring membership of deleted Bridge subscribers with the appropriate Cisco Unity subscriber objects as the members migrate from Octel to Cisco Unity.

Networking Configuration Considerations for Existing Octel Servers

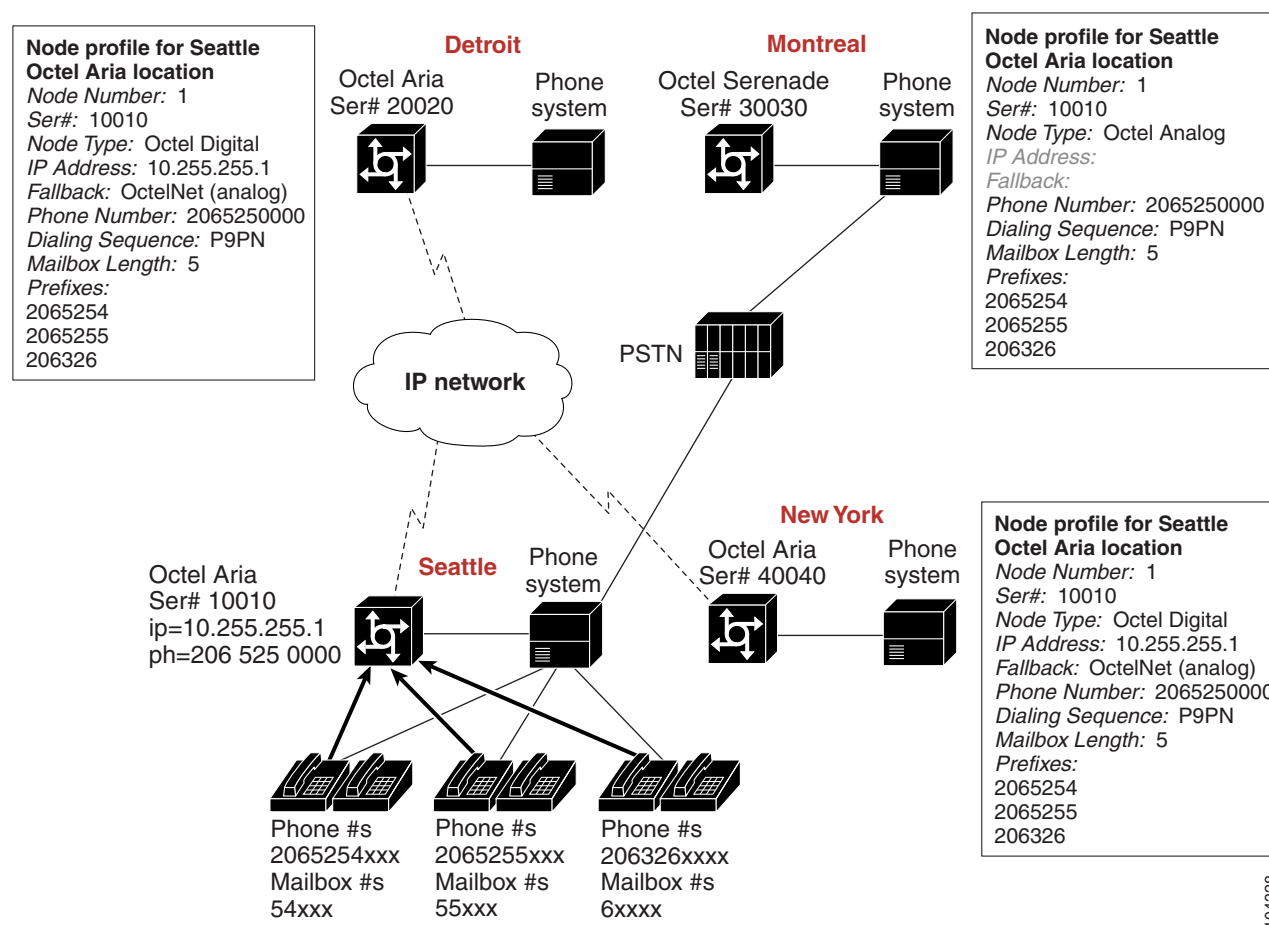
Considerations for Partial Server Migration

If the first subscribers being migrated from Octel to Cisco Unity are only a subset of the subscribers currently on a particular Octel server, additional steps need to be taken on the existing Octel servers to ensure that addressing within the network remains the same.



When you choose a subset of subscribers on an existing Octel server for migration to Cisco Unity, it is important to select the group based on their network addressing prefixes. Consider the example in Figure 4, which shows a company with four Octel servers: an Octel Aria server in Seattle, one in Detroit, and one in New York; and an Octel Serenade server in Montreal.

Figure 4: Network Node Configuration on Octel Servers in the Network



Note the configuration of the Octel networking profiles on the Detroit, New York, and Montreal servers for network addressing with Seattle.

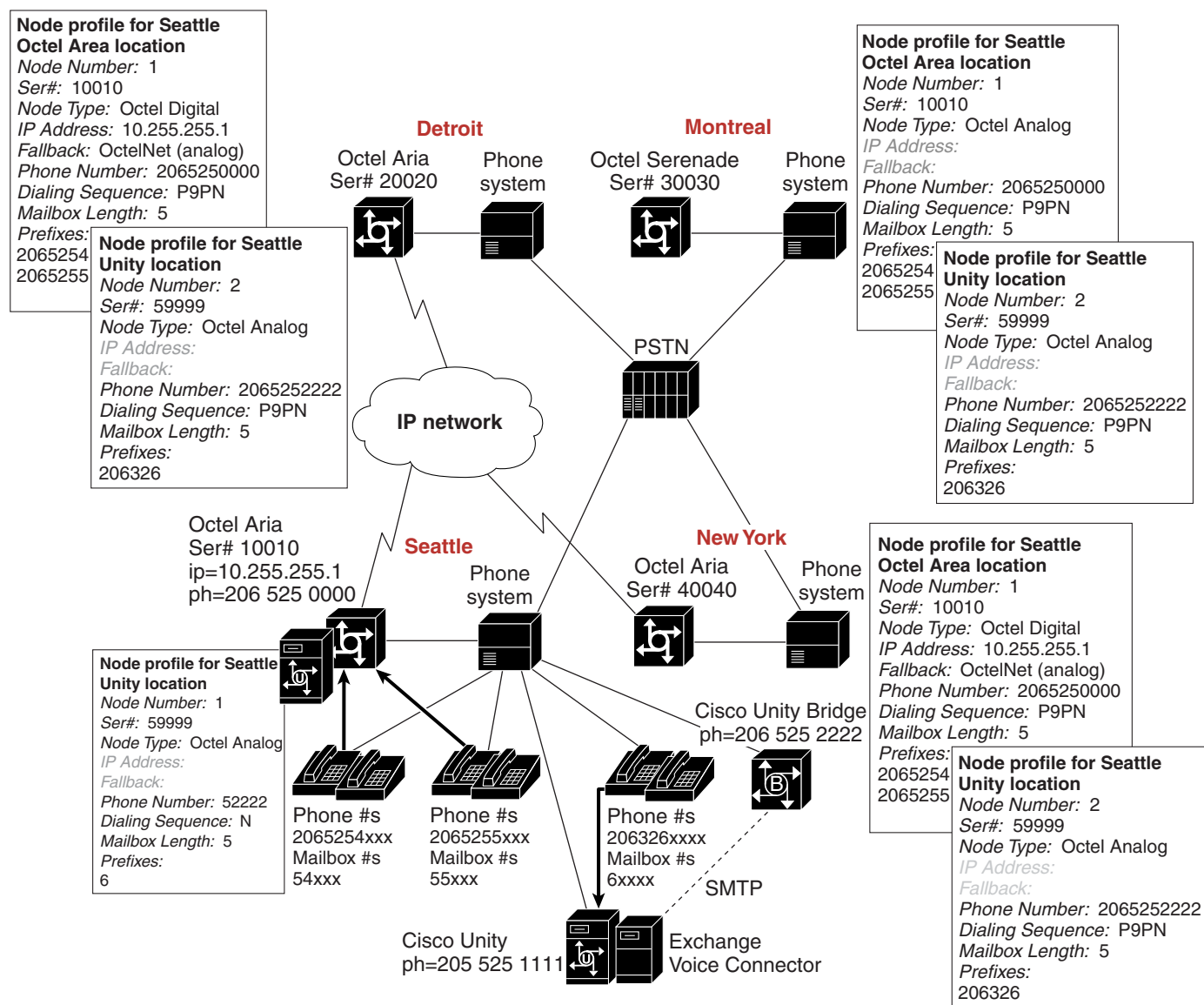
In this example:

- A 10-digit network addressing numbering plan is used, consistent with the area code and phone number of the subscribers.
- A subset of the subscribers in Seattle will be the first subscribers migrated from Octel to Cisco Unity.
- Octel digital networking is used to exchange network messages to and from the Seattle Octel and Detroit and New York, with Octel analog networking configured as the fallback transmission method.



- Octel analog networking is used to exchange network messages to and from the Seattle Octel and Montreal, because of the differences in digital networking between Aria and Serenade.
- Subscribers in Seattle fall into three distinguishable phone number/network address ranges: 2065254xxx, 2065255xxx and 206326xxxx. All local phone extensions and mailboxes are 5 digits.
- The subset of subscribers chosen for migration from the Seattle Octel to the Seattle Cisco Unity is the group of subscribers with network addresses that fit the 206326xxxx pattern.

Figure 5: Changes to the Network Node Configuration to Accommodate a Migration to Cisco Unity



104329



In Figure 5 we see the Octel server configuration changes that were required to support the migration of the Seattle subscribers with a network address range of 206326xxxx to Cisco Unity.

On the Detroit, New York, and Montreal Octel servers a new Octel analog networking node profile was created for a new serial number (59999) assigned to Cisco Unity and the Bridge. The network addressing prefix assigned to this profile is 206326, and 5-digit mailbox lengths have been specified. Note that these node profiles contact the Bridge at phone number 2065252222. The phone number for the Seattle Octel is still 2065250000.

On the Detroit, New York, and Montreal Octel servers the 206326 network addressing prefix was removed from the node profiles for serial number 10010.

In order to allow subscribers who are homed on the Seattle Octel server to send network messages to Seattle Cisco Unity subscribers, a new Octel analog networking node profile was created for new serial number 59999, assigned to Cisco Unity and the Bridge. The network addressing prefix assigned to this profile is 6, and 5-digit mailbox lengths have been specified. This allows continued use of the 5-digit message addressing expected by the Seattle Octel subscribers when they send messages to the migrated subscribers now on Cisco Unity.

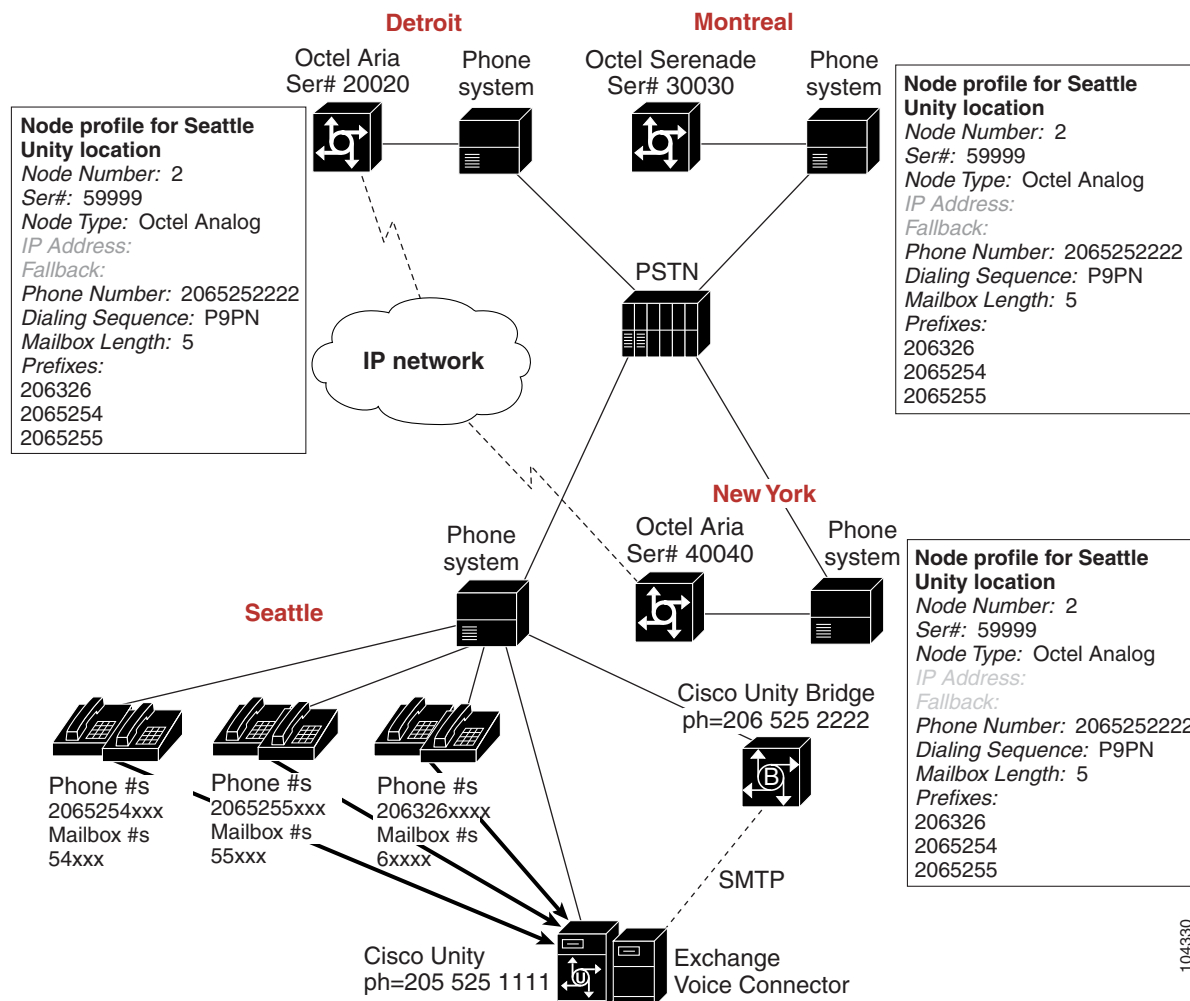
Note: This network addressing would conflict with the old Octel mailboxes of the migrated Seattle subscribers. If the 6xxxx mailboxes are not deleted immediately, the mailbox numbers should be changed so that they do not conflict. Alternatively, the network addressing could be configured so that Seattle Octel subscribers address messages to Seattle Cisco Unity subscribers by using the number 206326xxxx.

The phone number on the Seattle Octel that is configured for the Seattle Cisco Unity Bridge is 52222. Because these servers are on the same phone system, it is necessary only to dial the extension of the Bridge server.

Note that Cisco Unity and the Bridge have separate phone numbers, in contrast to the Octel servers, where the same access phone number is used for Octel analog networking and for regular caller access to the server. The phone lines connected to the Bridge are in a separate extension group than those for accessing Cisco Unity. Any remote Octel server that will communicate via Octel analog networking with the Bridge needs to be configured with the Bridge access phone number.



Figure 6: Node Profiles for Seattle on the Other Octel Servers, Post Migration



104330

Figure 6 shows the node profiles for Seattle on the other Octel servers at the point at which the remaining subscribers from the Seattle Octel have migrated to Cisco Unity.

On the Detroit, New York, and Montreal servers, the node profile for serial number 10100 is no longer used.

The remaining network addressing prefixes for Seattle (2065254 and 2065255) have now been added to the serial number 59999 analog networking profiles.

At this point, all Cisco Unity subscribers formerly homed on the Seattle Octel that have been migrated to the Seattle Cisco Unity are configured with a legacy mailbox value that is the same as their former Octel mailbox, and with a node serial number value of 59999.

The Cisco Unity bridgehead server is configured with Bridge delivery locations for Detroit, New York, and Montreal with the applicable serial numbers.



The Cisco Unity Bridge is configured with Octel Node profiles for Detroit, New York, and Montreal with the applicable serial numbers and access phone numbers.

The Cisco Unity Bridge is configured with a Unity Node profile for serial number 59999.

Typical Single Server Migration Steps

After the initial Octel server has been migrated to Cisco Unity, a fairly consistent set of steps can be followed to migrate subscribers on any one of the remaining Octel servers in the network to Cisco Unity. Specific details vary, depending on the server type (for example, Aria vs. Serenade) and on the existing transmission type (digital vs. analog). The number of Octel servers to which configuration changes need to be made decreases as the migration progresses. Other than that, the steps to migrate subscribers from the second Octel server to Cisco Unity are the same steps needed to migrate subscribers from the twentieth Octel server, or the fiftieth, and so on.

In Figure 7 and Figure 8, details of the Octel and Cisco Unity node profiles on the Bridge have been added, and the Bridge delivery locations are configured in Cisco Unity. We will be migrating New York next, so those are the node profiles we will look at on the Octel servers.

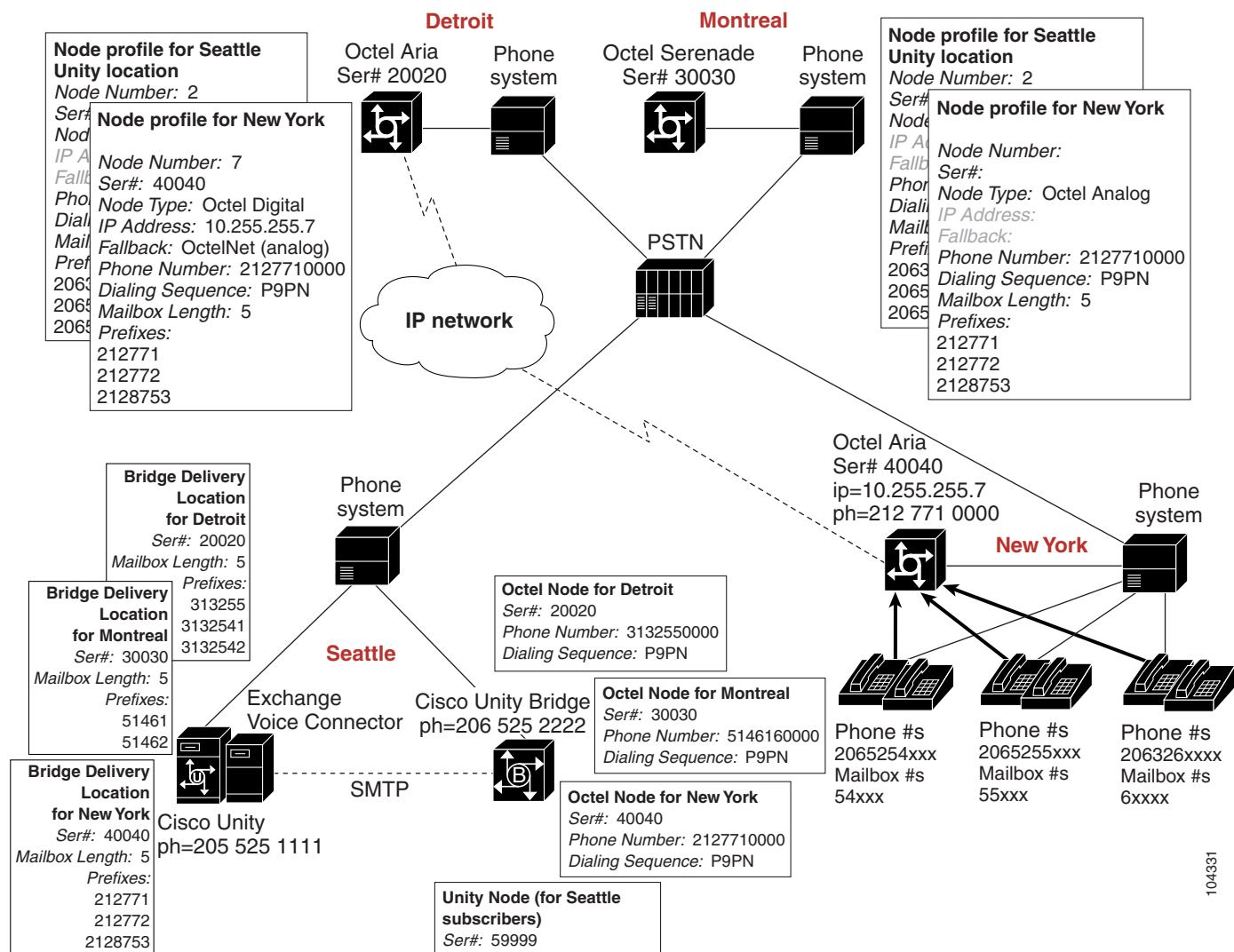
The steps to migrate the New York subscribers from the Octel server to Cisco Unity are as follows:

- Delete from the Cisco Unity bridgehead server any existing Bridge subscribers that represent New York Octel subscribers. If necessary, export subscriber information for these Bridge subscribers before deleting them, by using the Subscriber Information Dump tool. Information from this export (for example, public distribution list membership, and primary and alternate extensions) can be used when importing the Cisco Unity subscriber accounts for New York on the New York Cisco Unity server(s).
- Create/import Cisco Unity subscribers for New York on the New York Cisco Unity server(s). These subscriber accounts should all have their Unity Node Serial Number set to 40040 (the serial number of the former New York Octel server), and their Legacy Mailbox IDs set to whatever their mailbox numbers were on the New York Octel server. These properties are used when the New York subscribers send messages to or receive messages from the remaining Octel subscribers in the network via the Cisco Unity Bridge. The Cisco Unity primary and alternate IDs for these subscribers can be set to whatever is desired within the Cisco Unity network, without affecting their identity within the Octel network.
- Delete the Octel Node for the New York Octel server from the Bridge.
- Add a Unity Node for the former New York Octel serial number to the Bridge (40040).
- Modify the networking profile for New York on the Detroit Octel. The node type needs to be changed to Octel analog (from digital) and the access phone number should be that of the Cisco Unity Bridge in Seattle.
- Modify the networking profile for New York on the Montreal Octel. The node type is already Octel analog, so the only change necessary is to configure the access phone to that of the Cisco Unity Bridge in Seattle.



- Delete the Bridge delivery location for New York from the Cisco Unity bridgehead.
- Remove the New York Octel server from the IP network. The system can be left up and running for some period of time so that subscribers can call in and retrieve any messages left on the system.

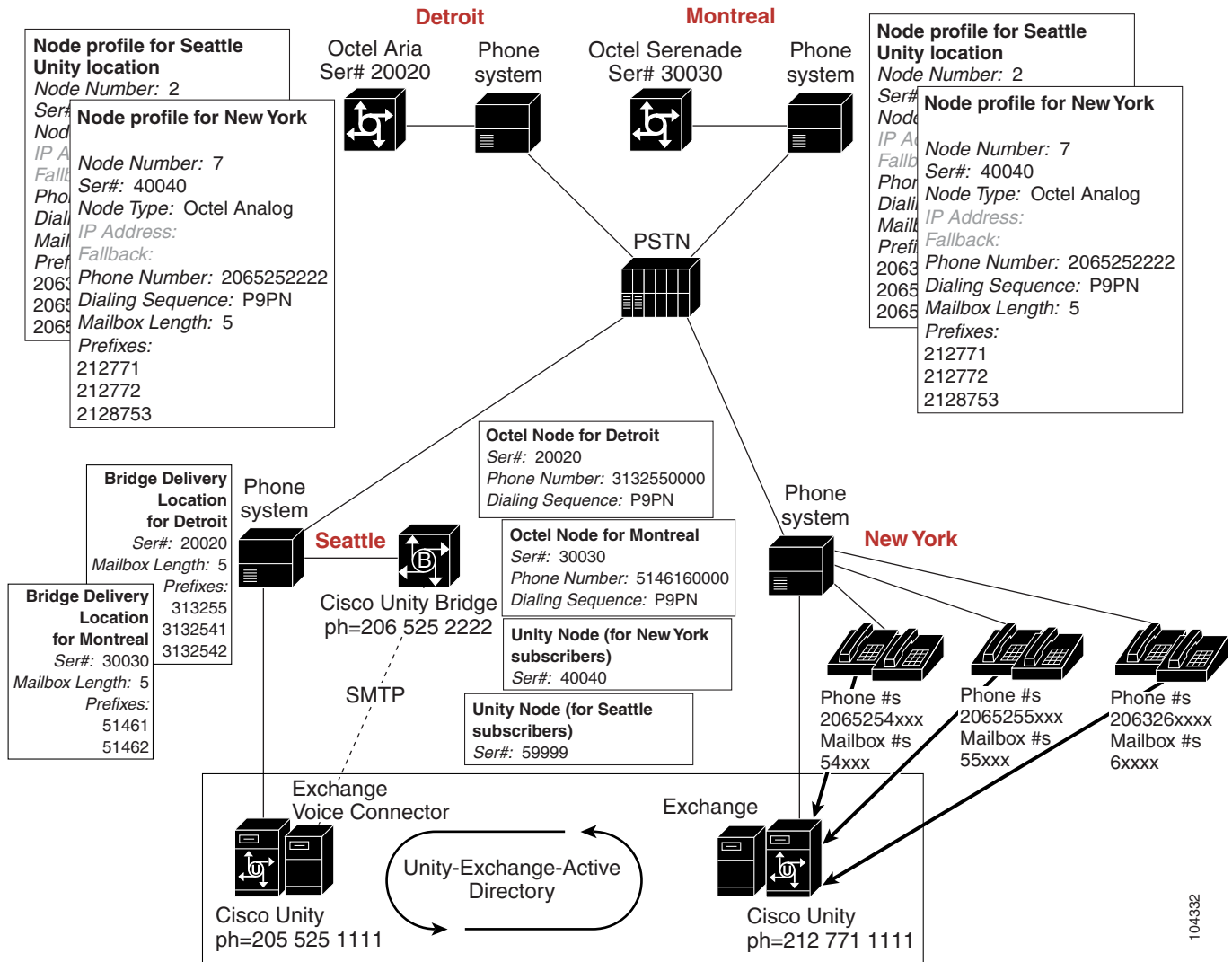
Figure 7: Network Configuration Prior to New York Migration to Cisco Unity



104331



Figure 8: Network Configuration After the New York Migration to Cisco Unity



104332

Octel Server Node Profile Considerations When Multiple Bridges Are in Use for the Same Cisco Unity Network

An Octel analog network is point-to-point. What this means is that if subscribers on all Octel servers need to be able to send a message to anyone in the network, each server is configured to contact and communicate with every other node. When Cisco Unity and the Bridge are used to communicate with Octel servers in the network, there are some differences in the way analog traffic routing is set up, especially during an Octel-to-Cisco Unity network migration, where numerous Octel serial numbers will be represented by Cisco Unity



and the Bridge(s). The best way to illustrate this is to consider a scenario where multiple Bridges represent Cisco Unity in the Octel analog network, and where Cisco Unity represents more than one serial number.

First, consider the following example of an Octel analog network prior to introduction of Cisco Unity and the Bridge.

Figure 9: Octel Analog Network with Ten Servers

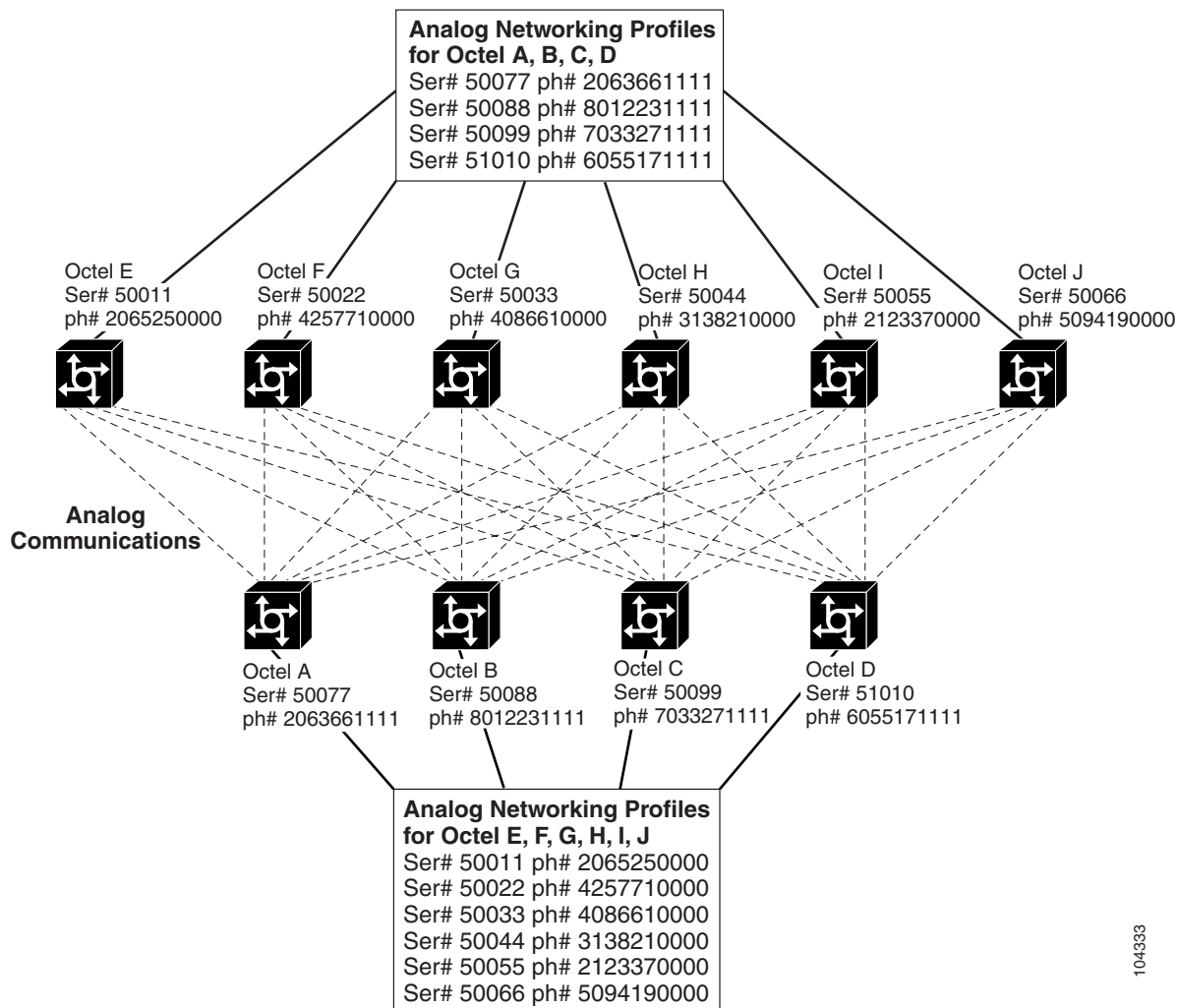


Figure 9 illustrates an Octel analog network with 10 servers, or nodes. The illustration shows a subset of the analog routes: the routes necessary for Octel A, B, C, or D to communicate with Octel E, F, G, H, I, or J.

Observe that the analog networking profiles necessary to communicate with Octel A, B, C, or D are configured identically on the Octel E, F, G, H, I, and J servers. Likewise, the analog networking profiles necessary to communicate with Octel E, F, G, H, I, or J are configured identically on the Octel A, B, C, and D servers.

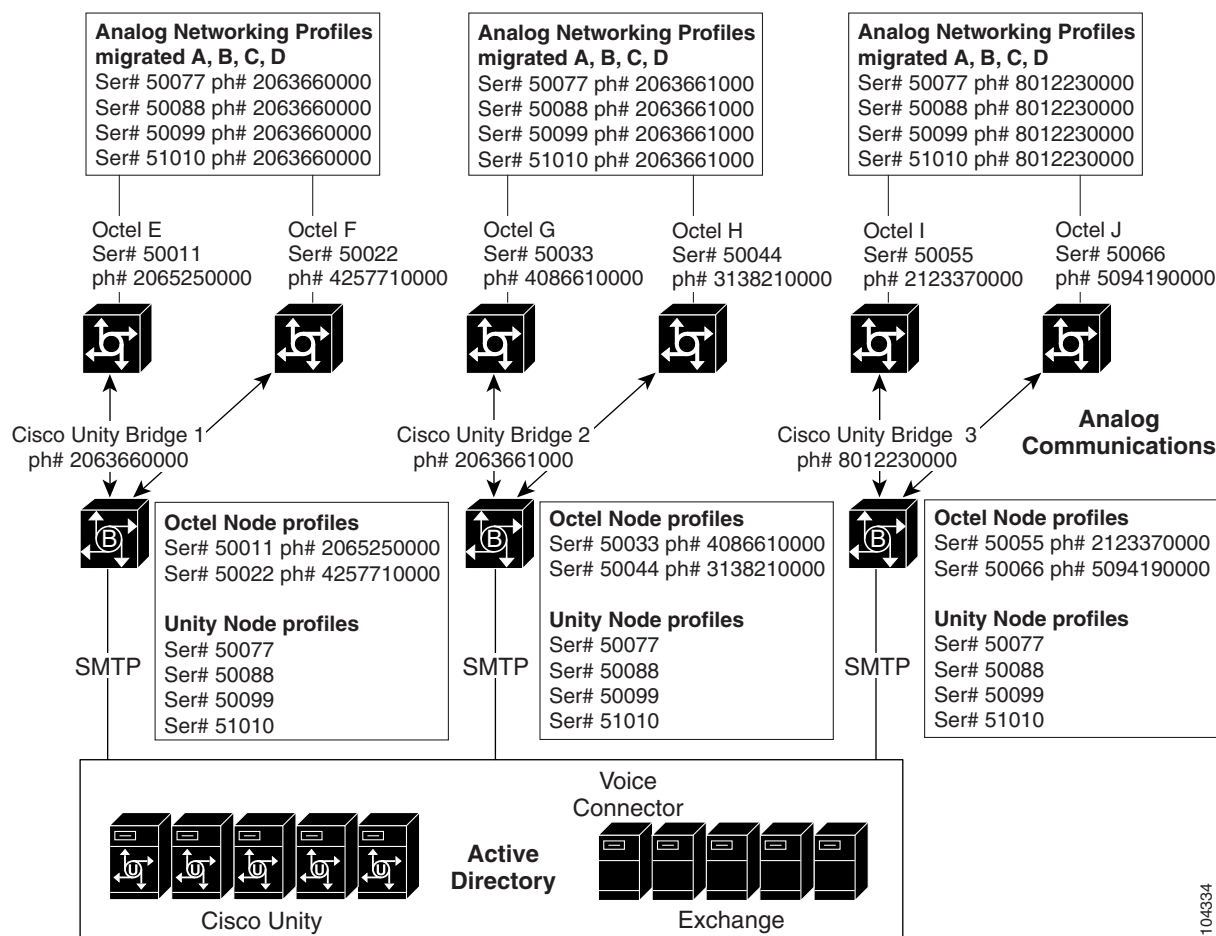


Each analog networking profile configured on any server has a different phone number, which is the phone number required to call that particular server.

If a new Octel server (for example, Octel K) were added to the analog network, a new analog networking profile would be configured on every other server in the network. All analog networking profiles for Octel K would be configured with the same phone number, which is the phone number needed to contact Octel K.

Figure 10 shows the same analog network, midway through an Octel-to-Cisco Unity network migration.

Figure 10: Same Analog Network, Midway Through the Migration



104334

In Figure 10, the subscribers from Octel A, B, C, and D have been migrated to Cisco Unity. Three Bridge servers are configured for communication with the rest of the Octel network.

Analog Networking Profiles on Octel E and F

- The phone numbers specified for A, B, C, and D are identical on each profile.



- Every node profile that is configured to communicate with Cisco Unity has the phone number of Bridge 1, because Bridge 1 is configured to communicate with Octel E and F.

Analog Networking Profiles on Octel G and H

- The phone numbers specified for A, B, C, and D are identical on each profile.
- Every node profile that is configured to communicate with Cisco Unity has the phone number of Bridge 2, because Bridge 2 is configured to communicate with Octel G and H.

Analog Networking Profiles on Octel I and J

- The phone numbers specified for A, B, C, and D are identical on each profile.
- Every node profile that is configured to communicate with Cisco Unity has the phone number of Bridge 3, because Bridge 3 is configured to communicate with Octel I and J.

Observe that the phone numbers used to communicate with Cisco Unity are not the same on every Octel in the network. Each Octel in the network communicates with only one of the Bridges. Octel E and F always communicate with Bridge 1, G and H with Bridge 2, and I and J with Bridge 3.

Keep this in mind if your migration will utilize more than a single Bridge server. When subscribers on an Octel server are migrated to Cisco Unity, and when Cisco Unity takes on representation of the former Octel server serial number for those subscribers, the phone number changes for that profile on the other Octel servers in the network must be based on the Bridge with which the Octel will communicate.

For example, if Octel E were next to be migrated to Cisco Unity, the request to update the phone numbers on the other Octel servers in the network would be as follows:

- Change phone number for ser# 50011 profile on Octel F to 2063660000 (Bridge 1)
- Change phone number for ser# 50011 profile on Octel G to 2063661000 (Bridge 2)
- Change phone number for ser# 50011 profile on Octel H to 2063661000 (Bridge 2)
- Change phone number for ser# 50011 profile on Octel I to 8012230000 (Bridge 3)
- Change phone number for ser# 50011 profile on Octel J to 8012230000 (Bridge 3)

Determining Where to Physically Locate the Bridge(s)

When making decisions about the physical location of the Bridge server(s), there are a number of factors to consider. Ideally, the Bridge server(s) should be located where:

- The phone system capacity is capable of handling the traffic
- Phone system reliability is optimal
- Service personnel will have physical access



- It is cost effective in terms of phone calls to the Octel servers
- SMTP network connectivity to the Exchange server(s) that host the Voice Connector(s) is reliable and efficient

If a single location meets all of the above criteria, then the decision is straightforward. When a location meets some but not all of the above criteria, then you will have to weigh the pros and cons of the potential locations.

For example, suppose a location meets all of the above criteria except that it is not the most cost effective in terms of phone calls to the Octel servers. To get an idea of the potential cost of long distance charges for phone calls between the Bridge and Octel servers, you will need to look at message traffic patterns on the Octel network. Additionally, for organizations that use Cisco CallManager (which routes calls over a private IP phone network), the long distance charges will only be incurred when the network or WAN bandwidth is unavailable and Cisco CallManager routes calls over the PSTN. In this case, you would also need to look at Cisco CallManager reports.

When making the decision, consider not just the initial phase of a network migration, but all phases. Message traffic between the Bridge and Octel servers will be greatest midway through the migration. Also consider the length of each phase of the migration.

For example, assume that 70 percent of the Octel to Cisco Unity migration will happen in a short period of time, followed by a long period of interoperation between the Bridge and the remaining Octel servers, followed by a rapid migration of the final 30 percent of the Octel servers. It may be best to consider the physical deployment of the Bridge servers based on the middle phase of the migration, when 70 percent of the subscribers are on Cisco Unity, and 30 percent are still using Octel.

Expected traffic load is usually the most obvious factor in deciding whether more than one Bridge server will be necessary. But there may be situations where more than one Bridge is deployed based simply on the desired analog call traffic flow. When using multiple Bridges, consider whether it is better to:

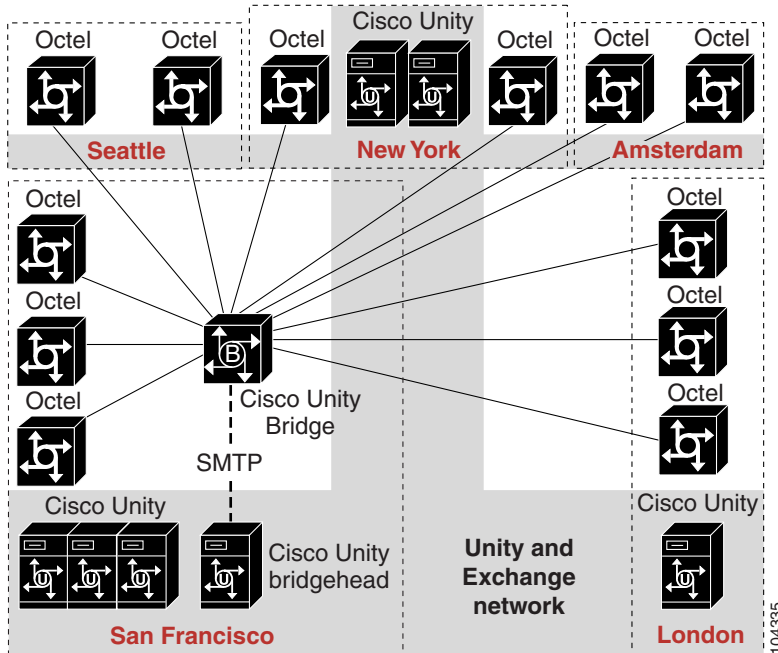
- Centrally locate the servers for ease of maintenance, or
- Place them in separate locations to take advantage of the lowest cost phone call routing.

Figures 11 through 14 show different physical locations for the Bridge midway through a migration. These approaches are not intended as recommendations but are meant as aids in visualizing the possibilities.

Note: Only one Bridge server in the Cisco Unity network can be configured to communicate with a particular Octel node. When multiple Bridge servers are used in the same Cisco Unity network, determine which Bridge servers and which Octel nodes will communicate. Distribute the Octel Node profiles on the Bridge servers accordingly. Configure the Bridge delivery locations on the bridgehead to be consistent with this distribution.



Figure 11: One Bridge Server in San Francisco



In Figure 11, because the majority of subscribers are in San Francisco, it makes sense to put at least one Bridge server in San Francisco so that all calls between the Bridge and San Francisco Octel servers are local (or made by Cisco CallManager over the LAN).



Figure 12: One Bridge Server in San Francisco and One in London

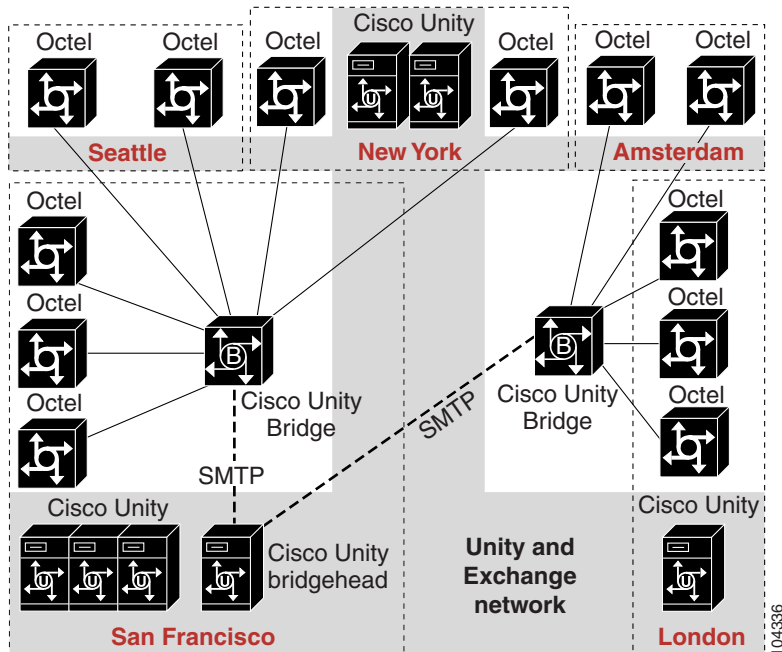


Figure 12 shows a Cisco Unity Bridge server in San Francisco, and one in London. Octel message traffic patterns suggested it would be more cost effective to put a Bridge server in London, rather than relying on a single server in San Francisco. This way, messaging between subscribers in San Francisco and London is via SMTP. This layout also avoids international toll charges between all sites in the U.S. and Europe.



Figure 13: Two Bridge Servers in San Francisco

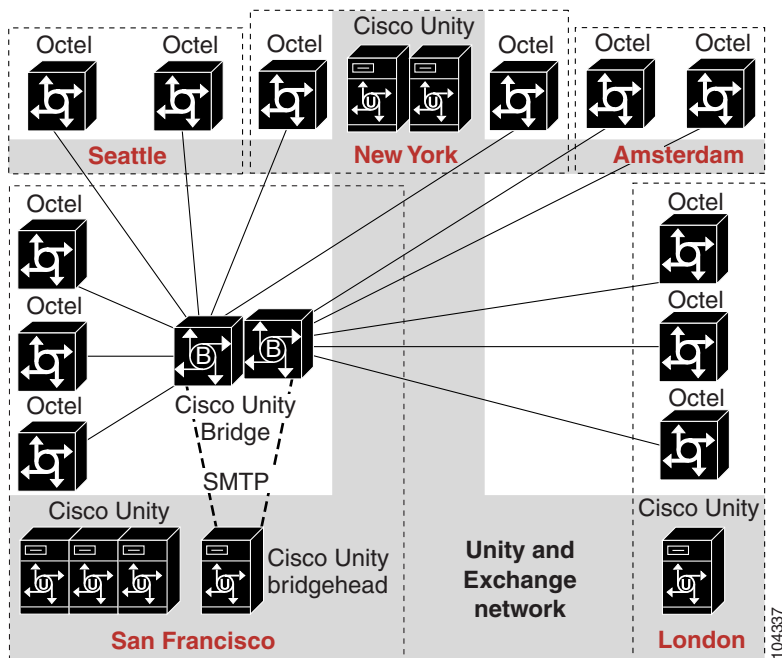


Figure 13 shows two Cisco Unity Bridge servers in San Francisco. In this case, it was determined that message traffic would not be too heavy between the U.S. and Europe, and therefore it made more sense to deploy two Bridge servers in San Francisco. The Bridge server that messages with Europe was configured to make calls during off hours, when the long distance toll charges are lower.



Figure 14: A Bridge Server in San Francisco, New York, and London

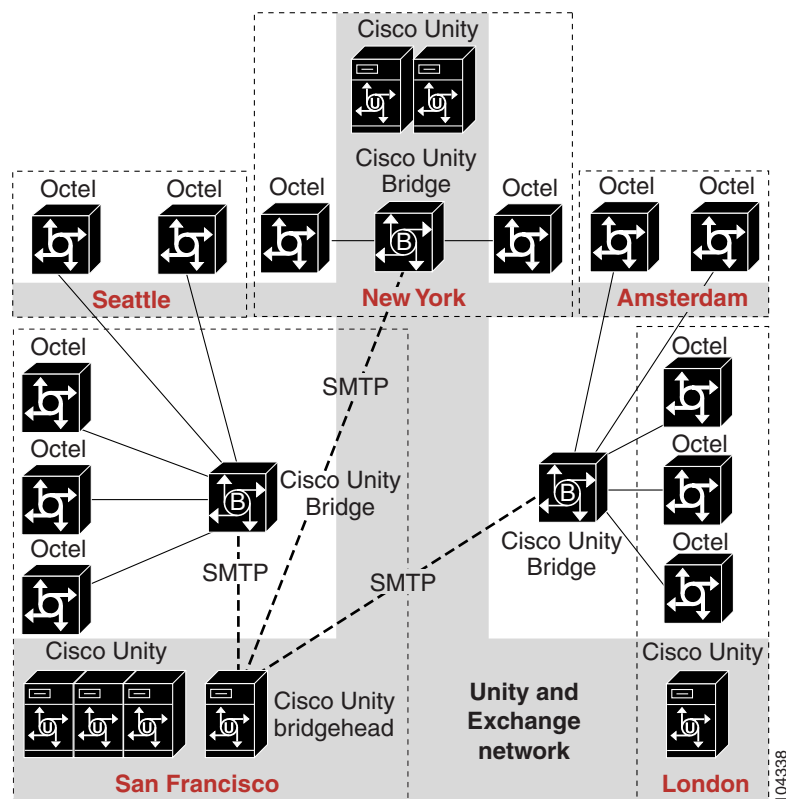


Figure 14 shows three Cisco Unity Bridge servers. In this case, it was decided that message traffic volume would be high enough to justify having a Bridge server in San Francisco, one in New York, and one in London.

Workgroup vs. Domain for the Cisco Unity Bridge Server

It is not necessary for the Cisco Unity Bridge server to be a member server in a domain. Configuration of the Bridge as a workgroup member is sufficient. The Cisco Unity Bridge does not store or search for subscriber directory information in Active Directory. All subscriber directory information is stored locally in the starfish.mdb MS Access database.

Configuration of the Bridge as a member server in a domain may be preferable when use of domain accounts and permissions is desired, or in situations where doing so aids in server name resolution or authentication.

Configuring the Bridge as a domain controller is not a supported configuration.



Chapter 3: Performance—Optimizing Installation and Configuration for Your Environment

Determining the Number of Cisco Unity Bridge Ports Needed

Estimating exactly how much traffic to expect to and from the Bridge is a challenge. All of the following information can be used to help calculate useful figures:

- Historical data on network voice message traffic.
- Subscriber population statistics and familiarity with the voice messaging habits of subscribers in various departments or locations.
- A determination of the point in the migration at which the message traffic between the Cisco Unity network and the Octel systems will be the heaviest. Theoretically this point would be reached when the migration is 50 percent complete (when half of the users are on Cisco Unity and half are on Octel).

When you have computed an approximate estimate of the peak traffic levels between Cisco Unity and Octel subscribers, also consider the following:

- Audio of a voice message is played in real time. Thus, a 30-second voice message takes 30 seconds to transmit.
- In addition to the actual recording time for voice message audio (or fax transmission) there is additional time necessary for various processing tasks. For example:
 - Dialing and receiving a connect for each outbound call
 - Servers identifying each other and performing call completion tasks for each call
 - Processing of each recipient of a particular message
- When an Octel subscriber sends a message to an Octel distribution list that includes the network addresses of Cisco Unity subscribers, or when a Cisco Unity subscriber sends a message to a distribution list that includes Bridge subscribers (which represent Octel subscribers), the list is flattened before the message is delivered via Octel analog networking. What this means is that if subscriber X on Cisco Unity sends a message to a distribution list that includes Bridge subscribers A, B, C, D, and E, the message transmission from the Bridge to the Octel includes a single message transmission, with transmission of five recipient addresses. The reverse is also true from Octel to the Bridge.



Analog Message Delivery Call Durations

There is no restriction on the maximum number of messages delivered on a message delivery call, or the total duration of a message delivery call, between the Bridge server and an Octel server.

The number of maximum simultaneous calls placed from the Bridge to the same Octel node, and the threshold at which additional calls are initiated, is determined by the “Queued Call Threshold” and “Max. Ports per Node” settings on the System Settings page of the Bridge server. (Refer to the “System Settings” section of the “Reference: Settings on the Bridge Server” chapter of the *Cisco Unity Bridge Networking Guide* for additional details on these parameters. The *Cisco Unity Bridge Networking Guide* can be found at http://www.cisco.com/en/US/products/sw/voicesw/ps2237/products_installation_and_configuration_guides_list.html.

The number of maximum simultaneous calls placed from an Octel to the same Unity node serial number on the Bridge, and the threshold at which additional calls are initiated, is determined by the settings on the Octel server for the applicable networking node profile. Note that the Bridge can represent multiple node serial numbers, which increases the potential maximum number of simultaneous calls placed from an Octel server to the Bridge.

See Table 1 for details on the analog message delivery call durations.

Table 1. Analog Message Delivery Call Durations

Delivery Call Phase	Duration
Analog call setup: initiate > dial > connect (applicable to outbound calls only)	5–20 seconds
Protocol overhead per message delivery call	30–35 seconds
Message overhead per message	5–10 seconds plus recording audio duration
Recipient overhead per each recipient of message	8–20 seconds

Analog Administrative Call Durations

There is no restriction on the maximum number of tasks performed during an administrative analog call, or the total duration of an administrative analog call, between the Bridge server and an Octel server.

No more than one administrative call at a time will ever be made from the Bridge to the same remote Octel server.

There is no restriction on the number of simultaneous inbound or outbound administrative calls that can be in process at once, other than the fact that the Bridge cannot place more than one call simultaneously to the same remote Octel server.

See Table 2 for details on the analog administrative call durations.



Table 2. Analog Administrative Call Durations

Delivery Call Phase	Duration
Analog call setup: initiate > dial > connect (applicable to outbound calls only)	5–20 seconds
Protocol overhead per administrative call	44–49 seconds
Administrative name retrieval per subscriber	<ul style="list-style-type: none">• 16–24 seconds (if there is a recorded name)• 10–14 seconds (if there is no recorded name)

Estimation Example

With the information found in Tables 1 and 2, and in the following list, while taking into consideration all of the information you have about voice network traffic patterns and user message habits, you can begin to estimate the number of Bridge ports that will be necessary to handle the expected traffic.

We recommend you do the following:

- Characterize the typical calls that you expect will occur (see Figures 15 and 16 and for examples).
- Estimate how many of each of these calls you expect will occur during various times of the day, and on various days of the week.
- Consider that one port on the Bridge will provide 60 minutes of call time per hour.
- Consider whether traffic patterns will result in steady traffic to particular nodes, or sporadic traffic to different nodes. Long continuous calls deliver the same messages more efficiently than many calls all at once or sporadic call placement.
- Consider that having enough ports to deliver all messages over a 24-hour period may not be sufficient for timely delivery if the majority of the traffic takes place during the span of a few hours. Consider the typical traffic during the heaviest traffic period of the day, on the busiest day of the week.



Figure 15: Outbound Message Delivery Call—Example 1

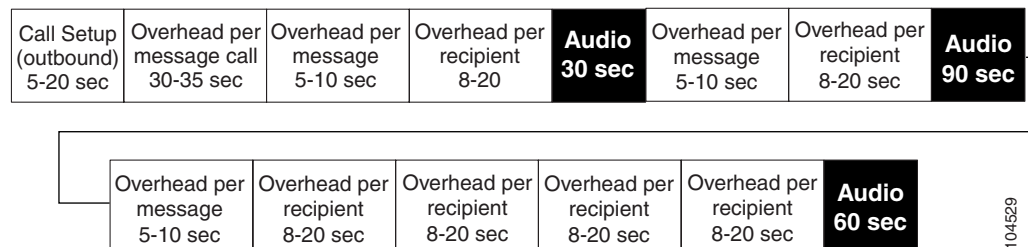


Figure 15 illustrates one outbound message delivery call that includes: one 30-second voice message to one recipient; one 90-second voice message to one recipient; and one 60-second voice message to four recipients. The total time necessary to process this call would be anywhere from 4 minutes and 38 seconds to 6 minutes and 25 seconds.

Figure 16: Outbound Message Delivery Call—Example 2

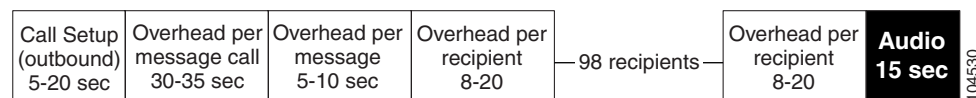


Figure 16 illustrates one outbound message delivery call that includes just one 15-second voice message to one hundred recipients. The total time necessary to process this call would be anywhere from 14 minutes and 15 seconds to 34 minutes and 40 seconds.

Determining How Many Bridges Will Be Needed

When you have estimated the total number of analog Bridge ports that are required to handle the traffic at the heaviest period of the migration, you can use this information to determine how many Bridge servers you will need to deploy for the migration.

The following should be considered when determining how many Bridge servers to deploy:

- Determine the maximum number of Bridge ports configurable on the platform intended for use as the Bridge server. For this information, refer to the applicable *Cisco Unity Bridge System Requirements, and Supported Hardware and Software* document, available at http://www.cisco.com/en/US/products/sw/voicesw/ps2237/products_system_requirements_list.html.
- Even if one Bridge server is sufficient to handle all of the expected traffic, does the geographical layout of the network make it advantageous to deploy multiple Bridge servers? For example, if there were heavy network traffic in one particular campus, it might be most effective to install a Bridge on campus and therefore handle phone calls between the Bridge and those Octel servers within the phone



system, and then locate another Bridge optimally for phone access to the other Octel servers in the network.

- Are there other geographical advantages to deploying more than one Bridge server, even when the traffic load does not appear to require it? For example, there are significant advantages to locating one Bridge in the United States and another in Europe.

Note: (For Cisco Unity Bridge use with Avaya Interchange) The Avaya Interchange acts as a single node in the Octel Analog Network, with a single serial number. Because a particular Octel node can only be configured on a single Bridge in the Cisco Unity network, traffic to an Octel node is limited to the maximum capacity of a single Bridge. If the Avaya Interchange is handling network messages for a large number of servers opposite Cisco Unity, this needs to be considered. The maximum analog port capacity on the largest Avaya Interchange platform at the time of this writing is 30 ports.

Voice Connector Considerations

Installing More than One Voice Connector and Installing the Voice Connector on a Dedicated Exchange Server

When deciding whether to install more than one Voice Connector, and whether the Voice Connector should be installed on a dedicated Exchange server, consider the following recommendations:

- If messages processed by the Voice Connector are expected to exceed 2,500 per day, we recommend that you deploy a dedicated Exchange server—on which no other mailboxes will be homed—for the Voice Connector.
- If messages processed by the Voice Connector are expected to exceed 7,500 per day, and if the G.711 codec is used to format messages sent between Cisco Unity and the Bridge, we recommend that the Voice Connector be installed on a server running Exchange 2000 or Exchange 2003 Enterprise edition. (If Exchange Enterprise edition is not an option, we recommend that you deploy an additional dedicated Exchange server for an additional Voice Connector.)
- If messages processed by the Voice Connector are expected to exceed 50,000 per day, regardless of message format, we recommend that you deploy an additional dedicated Exchange server for an additional Voice Connector.

Choosing a Voice Connector Installation Location

The Voice Connector(s) are installed on one or more Exchange 2000 or Exchange 2003 servers within the Cisco Unity network. Note the following considerations:

- The Voice Connector must not be installed on an Exchange cluster server.
- All voice messages sent from Cisco Unity subscribers to remote Octel subscribers via the Bridge will be routed via the Voice Connector.



- All voice messages sent from remote Octel subscribers to Cisco Unity subscribers via the Bridge will be routed via the Voice Connector.
- The Voice Connector registers with Exchange. For the Bridge, the Voice Connector is registered for the OMNI address type. All messages sent between the Cisco Unity network and the Bridge have the OMNI address type. When more than one Voice Connector is installed in the network, Exchange uses the lowest cost route to determine which Voice Connector to route to.
- Bridge servers are outside of the Exchange organization. This means that SMTP traffic to the Bridge servers must enter the Exchange organization via an SMTP host, and must leave the organization via an SMTP host. Often, this SMTP host is the Windows Default SMTP Virtual Server on the Exchange server where the Voice Connector is installed. However, depending on your organization, the network may be configured for mail to route in and out of the organization via other specified SMTP servers.
- Depending on your network, and the physical placement of the Bridge server(s) relative to the server on which the Voice Connector is installed, the routing of messages between these points may traverse long geographic routes. When this occurs, your organization may prefer to configure most of the routing between the points within the Exchange organization, or outside the Exchange organization via the LAN, WAN, or Internet. The Digital Networking ESMTP Server configuration on the Bridge, and the configuration of the Bridge delivery locations on the bridgehead server, are your primary means of configuring the routing of messages to and from the Voice Connector, using the preferred network routes.

Figure 17 shows a generic Exchange network with one Voice Connector installed, one server in the network through which all SMTP traffic in and out of the organization is routed, and two Bridge servers. The illustration shows the flow for an inbound and an outbound voice message via the Bridge.



Figure 17: Inbound and Outbound Voice Message Flow Via the Bridge

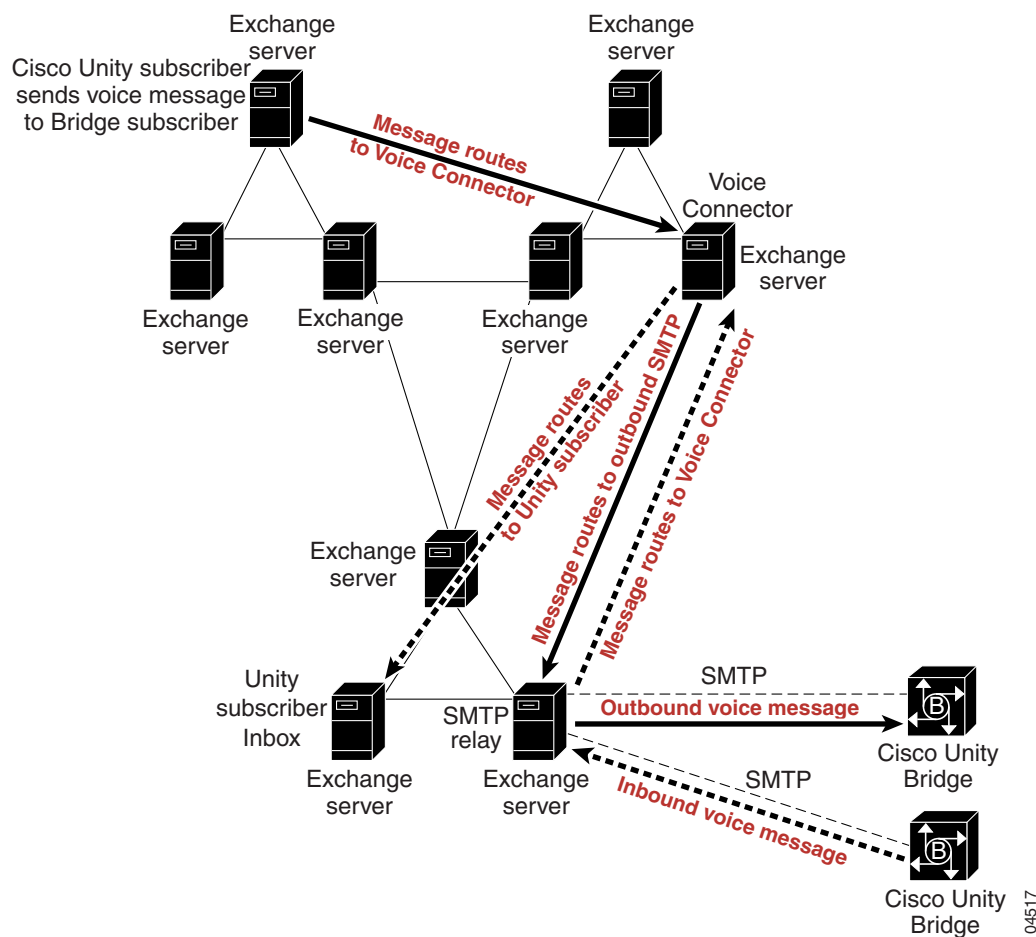
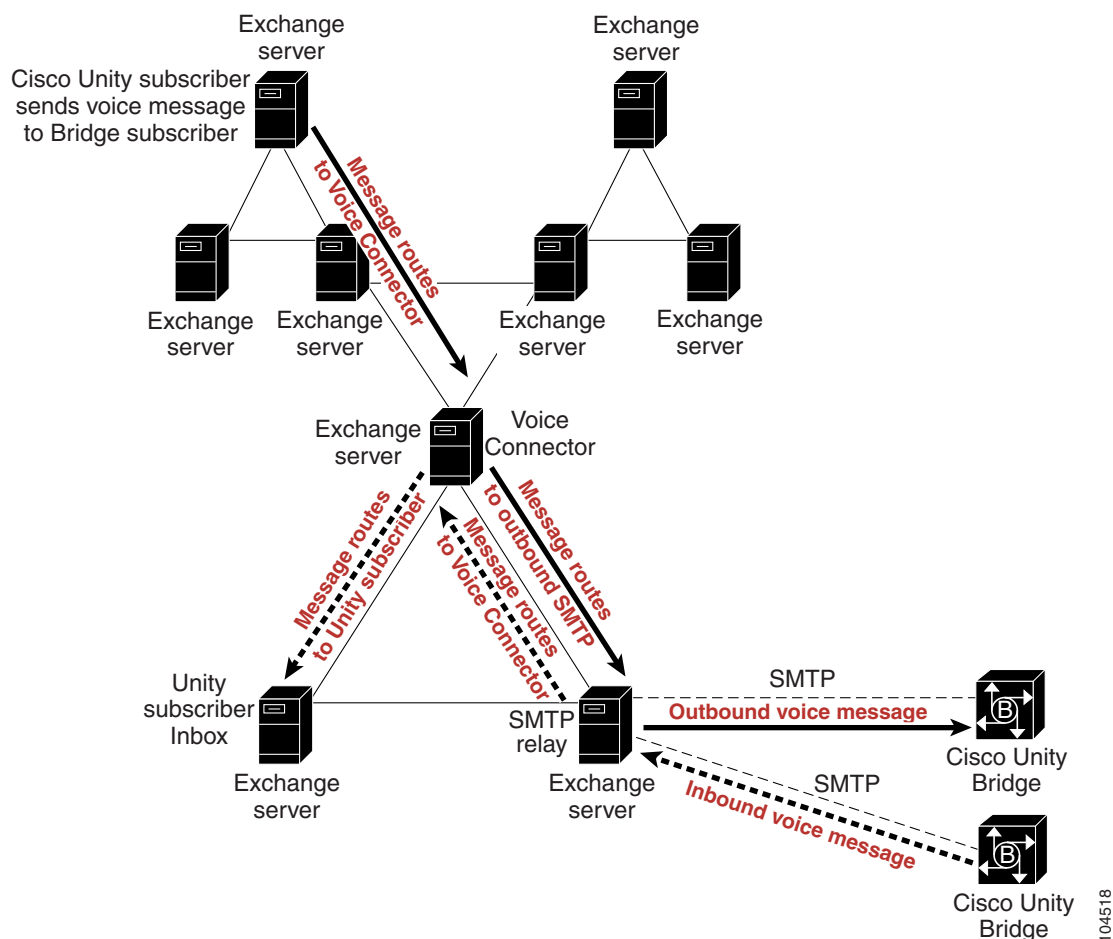


Figure 17 illustrates the considerations for locating the Bridge(s) in relationship to an SMTP relay server for the organization. Locating the Voice Connector within close routing proximity to the point at which SMTP traffic routes in and out of the organization can reduce the amount of intra-Exchange routing that needs to occur. See Figure 18.



Figure 18: Inbound and Outbound Voice Message Flow Via the Cisco Unity Bridge—Sample Route Optimization



Understanding Voice Connector Storage Considerations

Exchange Database Storage

When voice message traffic to and from the Bridge servers is more than a few thousand messages per day, storage space consumed on the Exchange server(s) hosting the Cisco Unity Voice Connector becomes significant as well. This storage issue is related to Exchange and Windows 2000 SMTP Virtual Server processing of messages that are routed to and from destinations external to the organization. If Bridge voice message traffic is expected to exceed 2,000 to 3,000 messages per day, it is important to consider this issue when sizing disk space resources for the Exchange server(s). The additional storage consumed can be characterized as Voice Connector disk space consumption in the message store.



Voice Connector Disk Space Consumption in the Message Store

In order to quantify your database storage needs, calculate the sum of the message file size of all messages expected to be processed by the Voice Connector, making use of data for the heaviest expected 24-hour period (counting the 24-hour period from one daily Exchange online defrag maintenance to the next).

Table 3 shows the recommended storage requirements for the Exchange server `priv1.edb` and `priv1.stm` files. This recommendation is specific to the needs of the Voice Connector, and does not include whatever additional storage is required on the server for other activity.

Table 3. Recommended Voice Connector Storage Requirements for Exchange Server Files

Messages Processed per 24-Hour Period	Average Message Size	Recommended Priv* Storage ¹
20,000	1 minute, G.711: ~640 KB	40 GB
10,000	1 minute, G.711: ~640 KB	20 GB
5,000	1 minute, G.711: ~640 KB	12 GB
20,000	1 minute, G.729a: ~80 KB	10 GB
10,000	1 minute, G.729a: ~80 KB	5 GB
5,000	1 minute, G.729a: ~80 KB	3 GB

The Exchange 2000 Standard Edition maximum database size is 16 GB. This limitation applies to the combined size of the `.edb` and `.stm` files for the database. If more than 16 GB is expected, Exchange 2000 Enterprise Server should be used on the server(s) hosting a Cisco Unity Voice Connector. For additional information, refer to the following Microsoft KB articles on the Microsoft Support website: number 296614 and number 322317.

Free space within the store is reclaimed during online defrag, but the overall size does not shrink. Therefore, subsequent 24-hour periods of lesser traffic would not reduce disk space consumption of `priv1.edb` and `priv1.stm`. Running an offline defrag will reclaim space, but this would not be considered a permanent solution unless the reclaimed space had been used up during a one-time peak that is not expected to occur again.

¹ To perform an in-place restore, Microsoft recommends that your disks have at least as much free space as the size of the database itself plus a minimum of 10 percent. For example, a 35 GB database would require an 80 GB partition.



Exchange Log File Storage

As with any Exchange server where traffic is heavy, the disk space consumed by Exchange transaction logs must also be considered when Voice Connector traffic is heavy. Note the following recommendations:

- Allow 10 GB of additional disk space for every 15,000 messages processed by the Voice Connector.
- Transaction logs are deleted each time an Exchange backup is run on the server. Schedule daily Exchange backups on the server that hosts the Voice Connector to prevent excessive disk space consumption. (For additional information on how Exchange transaction logs work, refer to the Microsoft Support website.)

Voice Connector Log File Storage—Diagnostic Logs

When the Voice Connector diagnostic log level is set to the default (the setting “3 – Error”), the amount of disk space consumed by the logs is negligible (less than 50 MB for the default 14-day retention period).

When the Voice Connector diagnostic log level is set to the most verbose level (the setting “5 – Function”), the amount of disk space consumed by the logs can be significant in heavy traffic conditions. If you set the diagnostic log level to this verbose setting, we recommend that you allow 100 MB of disk space per 10,000 processed messages.

For example, if the Voice Connector processes 5,000 messages (combined in and out) per day, with a diagnostic log level set to “5 – Function,” with the default 14-day log retention, you would need to allow 700 MB of disk space.

Voice Connector Log File Storage—Performance Logs

We recommend that you allow 1 MB disk space per 10,000 messages processed for Voice Connector performance logs.

For example, if the Voice Connector processes 5,000 messages (combined in and out) per day, with the default 14-day log retention, you would need to allow 7 MB of disk space.

Understanding Voice Connector Processing Considerations

When the Voice Connector is installed on a dedicated Exchange server, the impact on memory and CPU resource consumption on the server is relatively minor, even when processing in excess of 10,000 voice messages per 24 hours between the Bridge and Cisco Unity subscribers. However, when a Voice Connector processing an identical amount of traffic is installed on a server that homes thousands of subscriber mailboxes, the impact sometimes appears to be more than cumulative. It appears that more resources are necessary to process the combined activity than the cumulative resource consumption of the same Voice Connector and mailbox processing on independent servers.

Adherence to the guidelines and consideration of storage limitations described in this document will ensure that Voice Connector resource consumption does not become an issue.



Installing Multiple Voice Connectors, and Understanding Associated Routing Considerations

Advantages of Installing Multiple Voice Connectors

- Allows distribution of Voice Connector message processing among multiple Exchange servers. This is sometimes necessary to avoid excessive database storage.
- Allows more strategic placement of Voice Connectors within the network, leading to the streamlining of message routing.

Disadvantages of Installing Multiple Voice Connectors

- Message tracking and troubleshooting become more complex, because you need to know through which Voice Connector a particular message should have been routed.
- The installation of multiple Voice Connectors requires a better understanding of Exchange message routing.

Limitations for Installing Multiple Voice Connectors

- Multiple Voice Connectors cannot be installed on the same Exchange server.
- Multiple Voice Connectors with the same cost can be installed in the same Exchange routing group. Note, however, that even though the Voice Connectors can be configured to have the same routing costs, the Voice Connector that is used for each message is determined by Exchange, and cannot be manually configured.
- If multiple Voice Connectors in the same routing group are configured with different routing costs, the Voice Connector with the higher cost will never be used, unless the server hosting the lower-cost Voice Connector is down.
- Installing multiple Voice Connectors does not provide full redundancy. Exchange queues messages for a Voice Connector as usual, regardless of whether the Voice Connector is running normally. Exchange will route messages to a secondary Voice Connector only if the server hosting the preferred Voice Connector is completely down. Any messages that have already been queued for a Voice Connector that is on a server that goes down will remain in the queue for that Voice Connector; they are not re-queued to another Voice Connector.

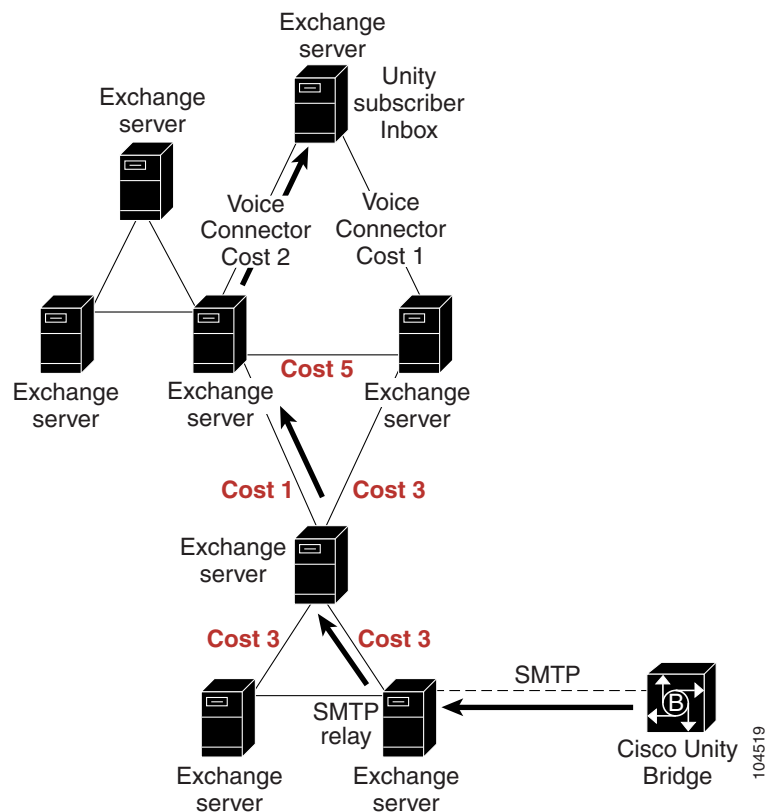
Voice Connector Cost Routing Considerations

When multiple Voice Connectors are installed in different Exchange routing groups, the Voice Connector to which a particular message is routed is determined by Exchange, based on the cumulative cost of routing to the connector, including the cost set on the connector itself. Note that the calculated cost considers only the



cost required to reach the destination of the Voice Connector, not the final destination of the message. Consider the example shown in Figure 19.

Figure 19: Voice Connector Cost Routing



In Figure 19, a voice message is routed from the Bridge to the Exchange organization via the server configured for SMTP relay. When the message enters the Exchange organization, there are two Voice Connectors to which the message could be routed, one with a cost of 1 and one with a cost of 2. Because Exchange determines the route based on the total cost of the route to the Voice Connector (including the Voice Connector cost), in this example the Voice Connector with the higher cost will be used. The total cost of the route to the Voice Connector with a cost of 2 is $3 + 1 + 2 = 6$. The total cost of the route to the Voice Connector with a cost of 1 is $3 + 3 + 1 = 7$. Therefore, the Voice Connector with the cost of 2 will be chosen. Also note that the connection with cost 5 was not a factor in how Exchange determined where to route the message to the Voice Connector, because this leg of the route is not determined until the Voice Connector processes the message.

Manual Distribution of Traffic to Multiple Voice Connectors

When you have determined that more than one Voice Connector will be needed, due to heavy traffic, there are a number of ways to manually distribute the traffic to best use the Voice Connectors.

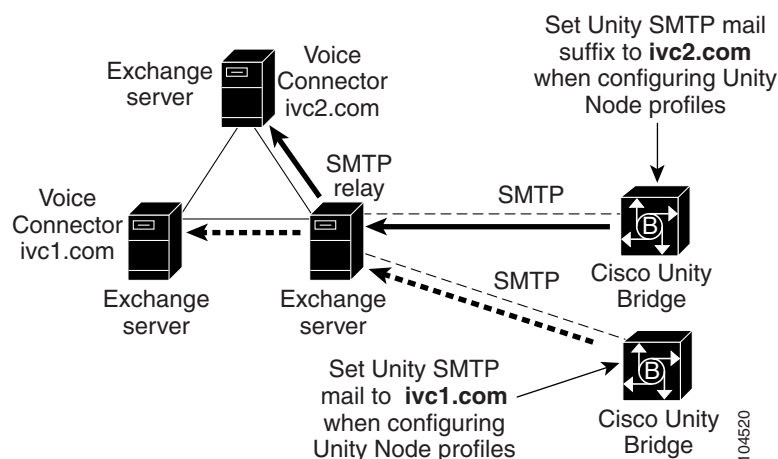


One approach is to route message traffic from each Bridge server to a specific Voice Connector. This can be done by using special recipient policies and SMTP connectors (see Figure 20). For detailed information on using special recipient policies, refer to the following procedures in the “Troubleshooting Bridge Networking” chapter of the *Cisco Unity Bridge Networking Guide*:

- “To Create a Special Recipient Policy for the Voice Connector”
- “To Apply the Special Recipient Policy to the Voice Connector”
- “To Configure the Bridge to Use the Special Recipient Policy”
- “To Configure an Exchange SMTP Connector to Route Messages from the Bridge Server Directory to the Voice Connector”

The *Cisco Unity Bridge Networking Guide* is available at http://www.cisco.com/en/US/products/sw/voicesw/ps2237/products_installation_and_configuration_guides_list.html.

Figure 20: Routing Message Traffic to a Specific Voice Connector



Cisco Unity Bridgehead Server Considerations

Configuring More Than One Cisco Unity Bridgehead Server

In most cases, we recommend that you configure only one server in the Cisco Unity network as the bridgehead for networking with the Bridge. Using a single bridgehead server:



- Reduces the complexity of administration
- Eliminates excess directory processing
- Simplifies redistribution of traffic among multiple Bridge servers

However, you may consider configuring an additional bridgehead server when the number of Bridge subscribers is expected to exceed practical administration boundaries. The Active Directory contacts associated with the Bridge subscribers created on the bridgehead are created in the same Active Directory container. If more than 50,000 Bridge subscribers are expected for all Bridge delivery locations, this number of contacts in a single Active Directory container may be unwieldy.

When a second bridgehead server is configured, the contacts associated with the Bridge subscribers that are created on the second bridgehead server can be created in a separate Active Directory container.

Dedicating a Cisco Unity Bridgehead Server Solely for Bridge Networking

If more than 5,000 Bridge subscribers will be homed on the bridgehead server—whether the subscribers are imported manually or auto-created—we recommend that the bridgehead be dedicated for this purpose. In this circumstance, the bridgehead server should not be the home server of regular Cisco Unity subscribers or be used for extensive call processing.

There are no configuration or licensing differences between a Cisco Unity server that is used for multiple purposes, including the bridgehead role, and a Cisco Unity server that is dedicated for use as the bridgehead. When we use the term “dedicated,” we mean simply refraining from using the server for purposes other than networking with the Bridge.

When a Cisco Unity server is dedicated as the bridgehead for the Bridge, its primary purpose is directory synchronization with the Bridge servers and administration of Bridge delivery locations and Bridge subscribers. Actual calls placed or received by this Cisco Unity server will be minimal. Though the server used for this purpose should have substantial processing and storage capabilities, the need for licensed voice ports on this server will be minimal.

Cisco Unity Bridgehead Processing Considerations

The CsBridgeConnector service on the bridgehead is responsible for monitoring changes to Cisco Unity subscriber data in the network, and sending the information to the Bridge. CsBridgeConnector is also the service that processes directory information about Octel subscribers received from the Bridge, including automatic modification of Bridge subscriber objects, when applicable. Directory information is exchanged between the bridgehead and the Bridge server via SMTP messages. These messages are specially formatted e-mails (called vCards) that contain adds, changes, and deletes of record(s). Each record contains the name of the subscriber, the mailbox number, and the voice name, which has been encoded by using the MIME protocol.



CsBridgeConnector Outbound FDD Processing to the Cisco Unity Bridge

Time Needed to Process Cisco Unity Subscriber Records, Outbound to the Cisco Unity Bridge (Full Directory Data)

Full directory data information (vCards) for Cisco Unity subscribers in the network is primarily processed and sent to the Bridge under two conditions:

- The administrator initiates a full directory synchronization of Cisco Unity subscriber data to the Bridge via the Bridge Options > Synchronization page of the Cisco Unity Administrator.
- The administrator configures a new Unity Node profile on the Bridge server, and the Bridge sends a full directory data request to the bridgehead for all Cisco Unity subscribers that are configured with the serial number that matches the newly added Unity Node.

The maximum rate for processing these records and sending them to the Bridge is approximately 3,600 records per hour. This approximation is based on a bridgehead platform with a single 1 GHz CPU, and Cisco Unity subscribers who have 5-second recorded voice names.

Maximum Records Per Outbound Directory Message

To ensure dependable processing and delivery of outbound directory messages, the maximum size of each message is regulated by the CsBridgeConnector service. By default, the maximum file size of directory messages sent from the bridgehead to the Bridge server(s) is approximately 500 KB.

Assuming a 5-second recorded voice name for each Cisco Unity subscriber:

- When the voice names are recorded with the G.711 codec, a maximum of approximately 10 records are included per outbound SMTP directory message from the bridgehead to the Bridge server.
- When the voice names are recorded with the G.729a codec, a maximum of approximately 70 records are included per outbound SMTP directory message from the bridgehead to the Bridge server.



Directory Synchronization Performance on the Cisco Unity Bridgehead

Table 4. Directory Sync Performance Issues

Records Processed	Approximate Increase in CsBridge-Connector Service Physical Memory Processing	Approximate Increase in CsBridge-Connector Service Virtual Memory Processing	CsBridge-Connector CPU Percentage Increase	Total Percentage Increase in Bridgehead Processing
3,000 vCards per hour, from the Bridge	1 MB	2 MB	2 percent	25 percent The significant increase in total processing of the bridgehead server in this condition is due the database processing performed by other Cisco Unity services when modifying or creating subscriber objects.
3,000 vCards per hour, to the Bridge	1 MB	2 MB	2 percent	2 percent



Subscriber Object Presence on Various Servers During the Migration

To calculate how many subscriber or directory objects of any type will be present on a server at any point during the course of the migration, use the guidelines shown in Table 5. These guidelines will provide you with conservative estimates.

Note: When planning Cisco Unity server resources for any server in the network, keep in mind the importance of basing your figures on the total number of Octel and Cisco Unity subscribers, even early in the migration when most subscriber mailboxes are still homed on the Octel servers.

Table 5. Guidelines for Calculating Server Resources Needed per Subscriber and Directory Object

Object	Numbers to Calculate
Unity Bridgehead Server	
Subscriber objects in the local subscriber table of the UnityDb SQL database	All Octel subscribers in the voice network plus regular Cisco Unity subscribers that are homed locally
Subscriber objects in the global subscriber table of the UnityDb SQL database	All Octel and Cisco Unity subscribers in the voice network
Recorded voice name WAV files stored in \CommServer\Streamfiles (storage size based on codec used for recording)	All Octel and Cisco Unity subscribers in the voice network
Any Other Cisco Unity Server in the Network	
Subscriber objects in the local subscriber table of the UnityDb SQL database	Regular Cisco Unity subscribers that are homed locally
Subscriber objects in the global subscriber table of the UnityDb SQL database	All Octel and Cisco Unity subscribers in the voice network
Recorded voice name WAV files stored in \CommServer\Streamfiles (storage size based on codec used for recording)	All Octel and Cisco Unity subscribers in the voice network
Active Directory	
User objects	All Cisco Unity subscribers in the voice network
Contact objects	All Octel subscribers in the voice network
Recorded voice name storage on User or Contact objects (storage size based on codec used for recording)	All Octel and Cisco Unity subscribers in the voice network



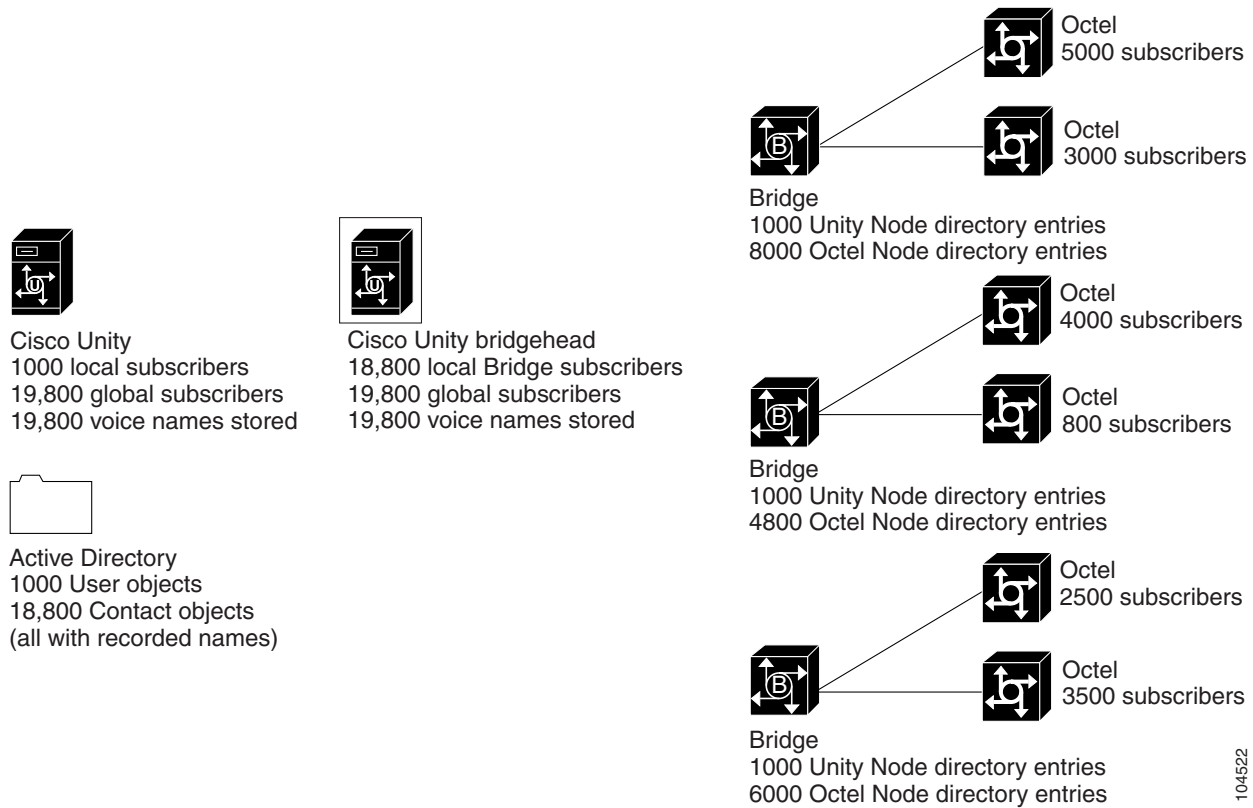
Object	Numbers to Calculate
Bridge server	
Octel Node directory entries	All Octel subscribers homed on Octel servers with which this Bridge communicates
Unity Node directory entries	All Cisco Unity subscribers in the voice network
Recorded voice name file (storage size for all names based on G.711 or equivalent)	All Octel subscribers homed on Octel servers with which this Bridge communicates, multiplied times 2, plus all Cisco Unity subscribers in the voice network

For additional information on Cisco Unity server and Active Directory data storage considerations, refer to the *White Paper: Active Directory Capacity Planning, Cisco Unity Version 3.0(3) and Later (With Microsoft Exchange)* and the *White Paper: Cisco Unity Data and the Directory (With Microsoft Exchange)*. Both white papers are available at http://www.cisco.com/en/US/products/sw/voicesw/ps2237/prod_white_papers_list.html.

The sequence of illustrations below (see Figures 21 through 27) shows how subscriber object distribution will change during an Octel to Cisco Unity migration. Observe how and where the object totals change at each phase. The illustrations assume the maximum possible number of Bridge subscribers on the bridgehead server and Octel Node directory entries on the Bridge server(s) that will exist at any point. For example, if all Octel subscribers are imported as Bridge subscribers and/or Octel Node directory entries at the onset of the migration, the maximum totals are likely to be reached. If Bridge subscriber and Octel Node directory entries will only be created due to name propagation, based on voice messages sent from Cisco Unity to Octel, the number of Bridge subscribers and Octel Node directory entries at any point may be less.



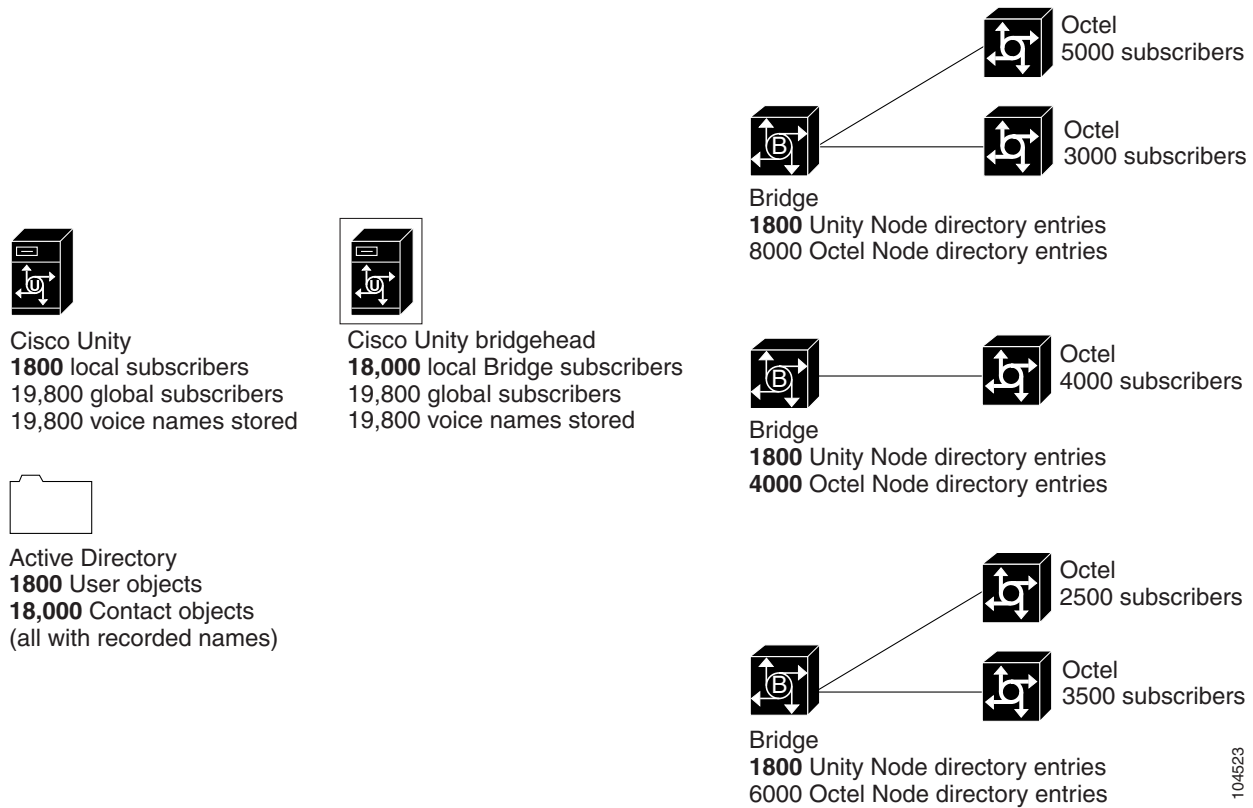
Figure 21: Initial Cisco Unity Deployment with 1,000 Cisco Unity Subscribers



104522



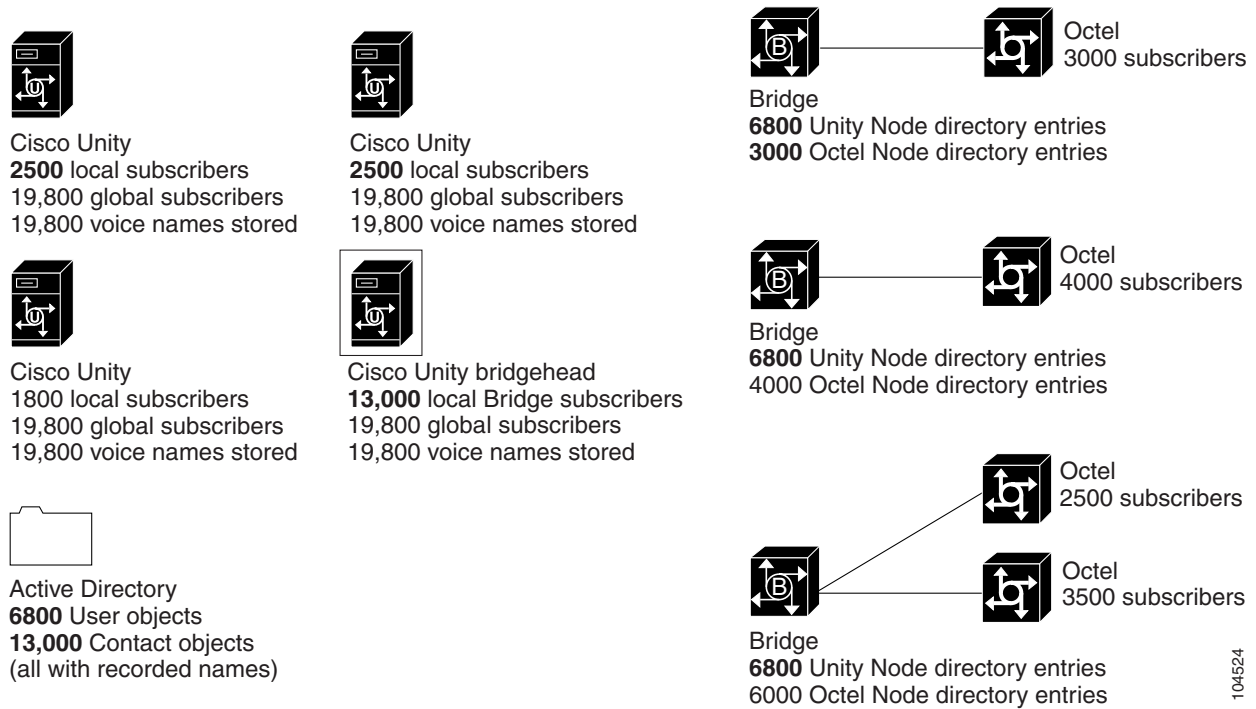
Figure 22: Migration of an Octel Node of 800 Subscribers to an Existing Cisco Unity Server



104523



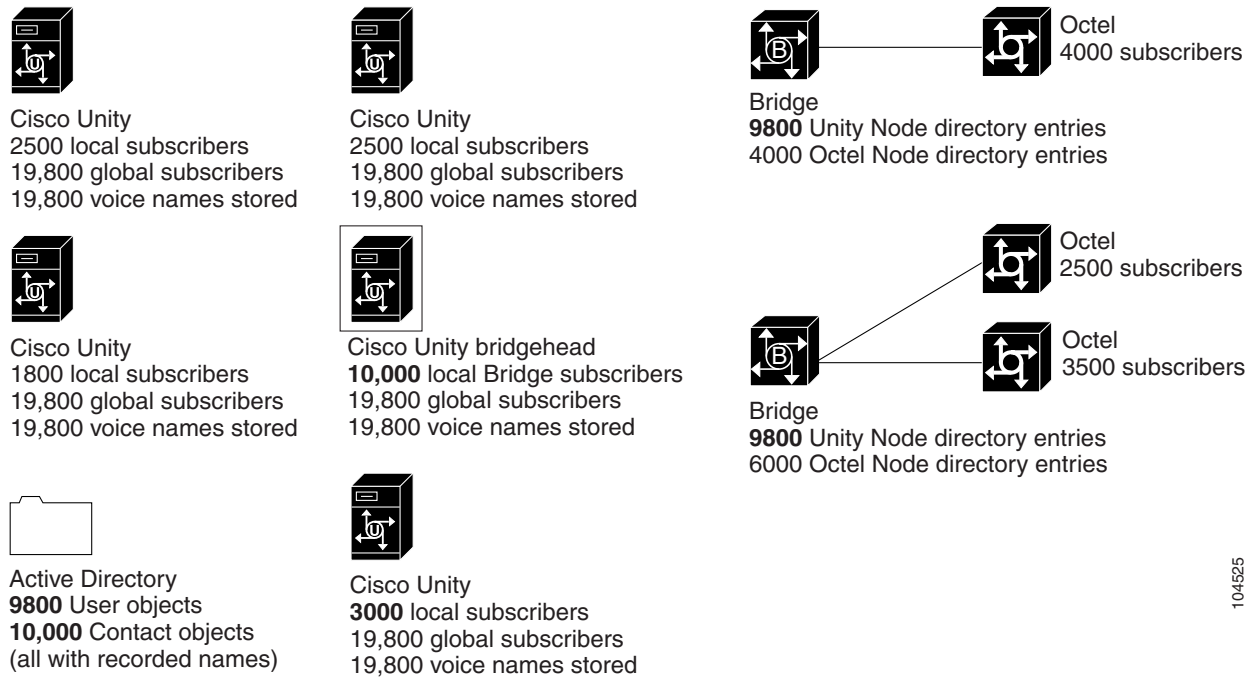
Figure 23: Migration of an Octel Node of 5,000 Subscribers to Two New Cisco Unity Servers



104524



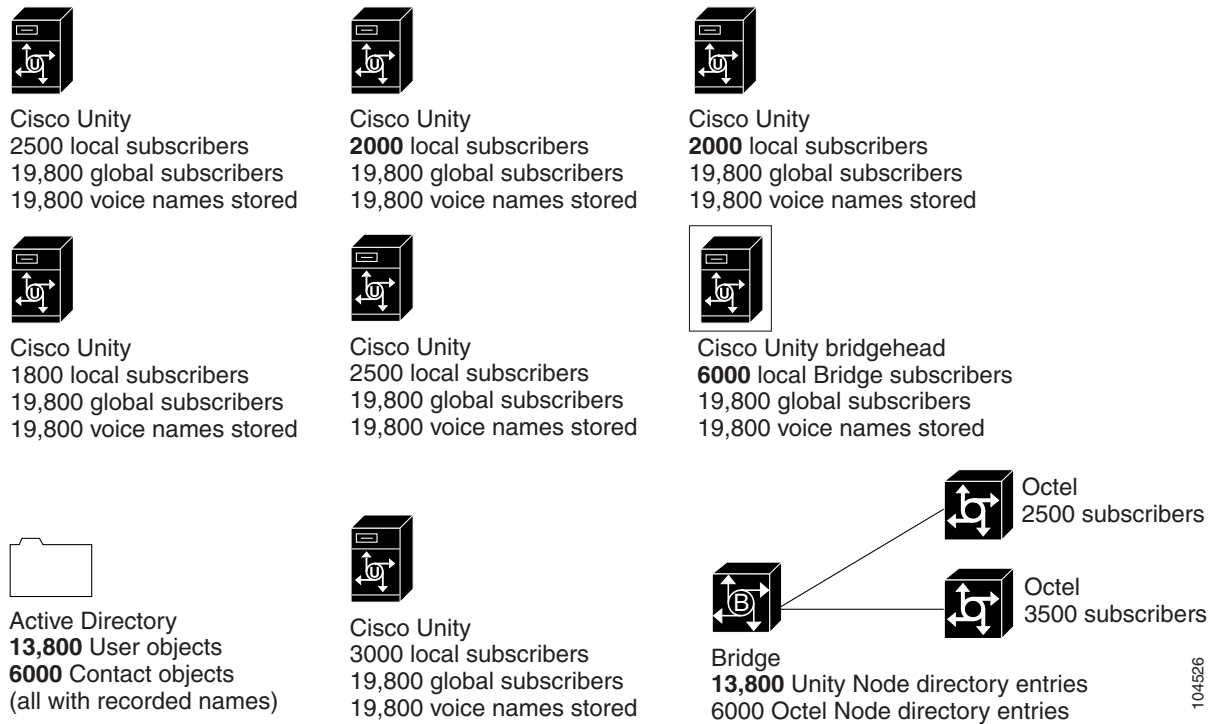
Figure 24: Migration of an Octel Node of 3,000 Subscribers to a New Cisco Unity Server



104525



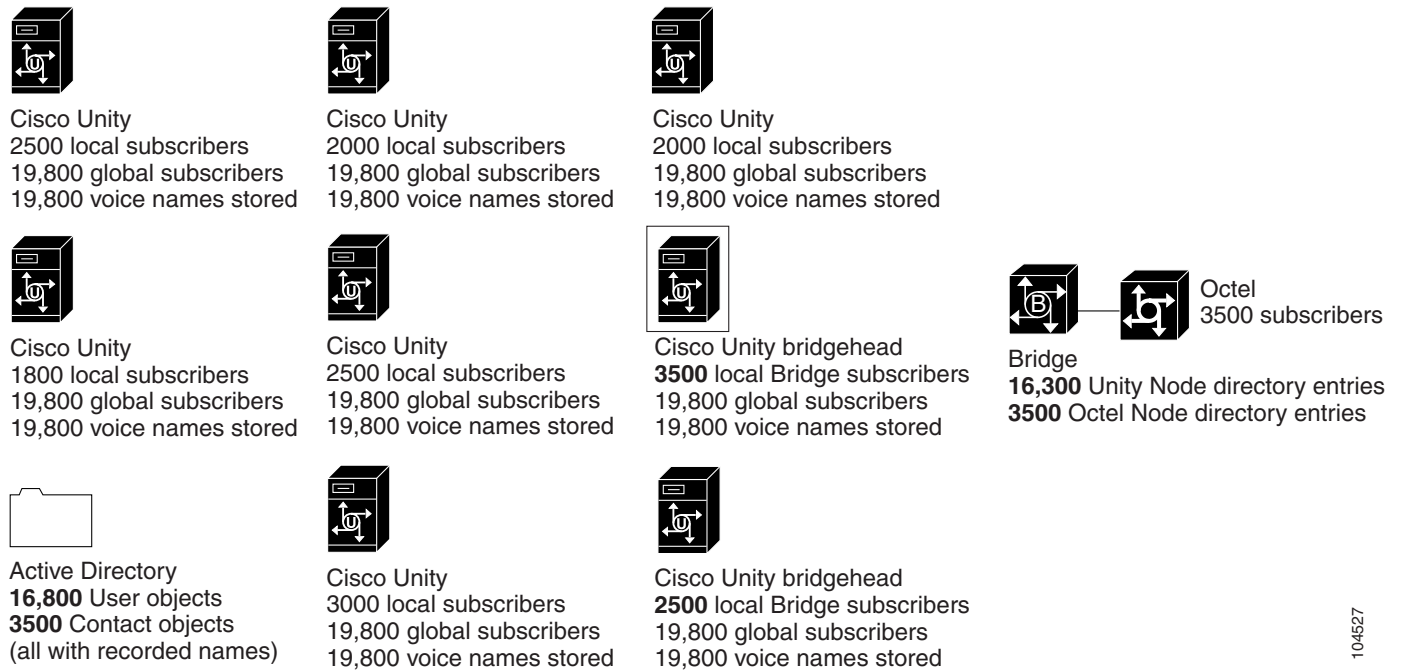
Figure 25: Migration of an Octel Node of 4,000 Subscribers to Two New Cisco Unity Servers



104526



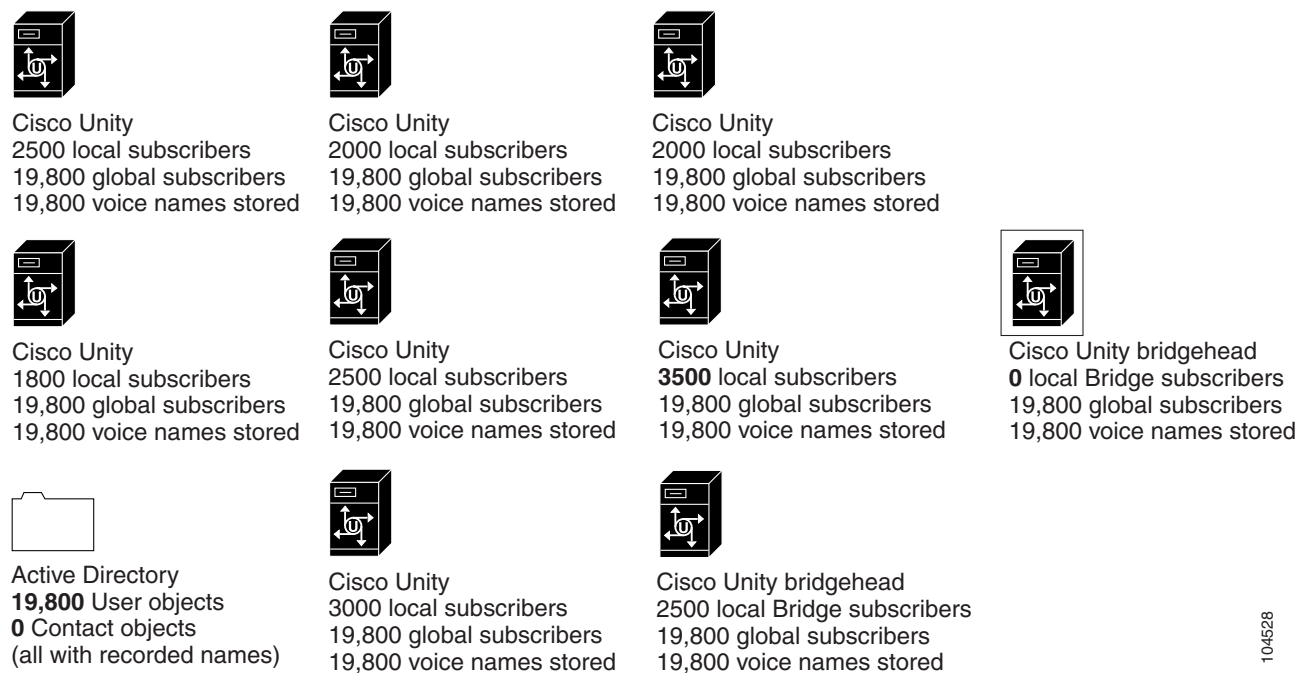
Figure 26: Migration of an Octel Node of 2,500 Subscribers to a New Cisco Unity Server



104627



Figure 27: Migration of the Final Octel Node of 3,500 Subscribers to a New Cisco Unity Server



10-4528

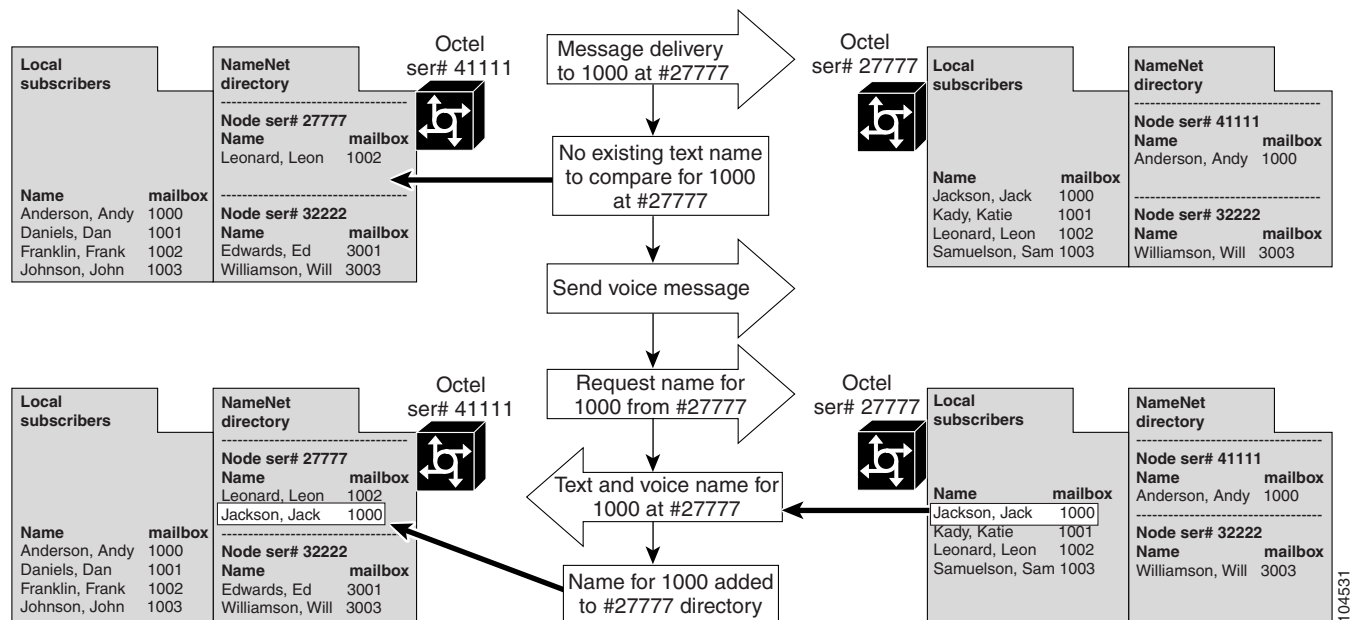


Chapter 4: Interoperability Behavior to Watch for During the Migration

Text Name Mismatch

When a voice message is delivered from one Octel analog networking node to another, if the sending node does not have the mailbox number and text name for the recipient in the NameNet directory, in addition to delivering the message the sending node will send an administrative request to the receiving node to retrieve the text and voice name for the recipient mailbox. The mailbox and text name are added to the NameNet directory on the sending Octel. See Figure 28.

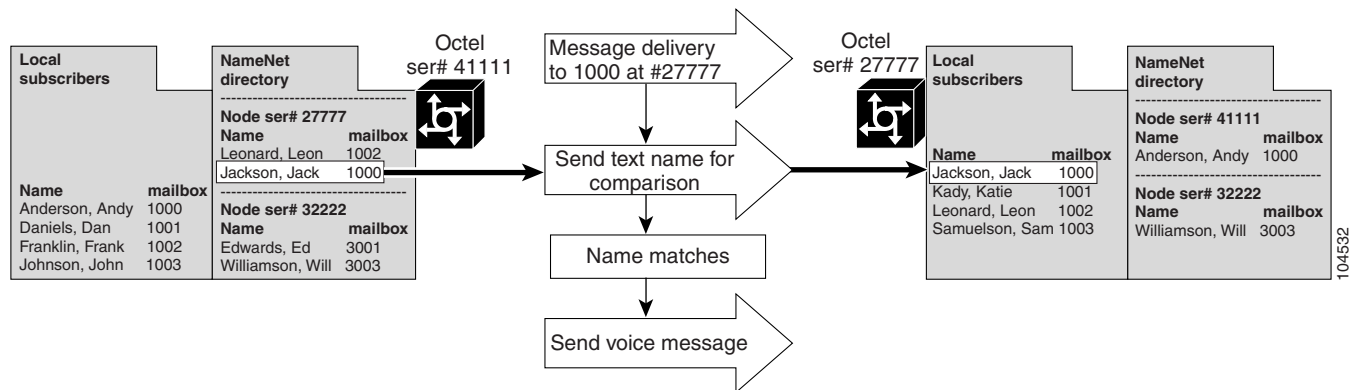
Figure 28: Name Propagation Due to Voice Message Sending Within the Octel Analog Network, the First Time a Message Is Sent



When the sending node has a NameNet entry for the recipient, every time a message is delivered to the receiving node for the recipient mailbox number, the sending node first sends the existing text name for the recipient to the receiving node and waits for confirmation that the text name matches the current entry on the receiving node. If the name matches, the message is delivered. See Figure 29.



Figure 29: Name Confirmation During Voice Message Delivery Within the Octel Analog Network, After a Name Has Propagated From One Node to the Node From Which the Voice Message Originates



The behavior shown in Figure 29 is part of the Octel analog networking protocol. The reason for the name comparison implementation is to ensure that messages are not inadvertently delivered to an unintended recipient.

For example, John Doe works for Company A, where his mailbox on the Octel is 1000. John leaves the company. Sam Jones is hired to replace John, and Sam is now assigned mailbox 1000 on the Octel. This information is not necessarily pushed to the other Octels in the network. If the other Octels in the network have the text and voice name of John Doe in their NameNet directories, and if subscribers address a message to the network address associated with mailbox 1000 on the Octel to which Sam is assigned, they will hear the recorded voice name for John Doe. In this circumstance, they would have no way of knowing that they are leaving a message that will be received by someone other than the person whose recorded voice name they just heard.

Therefore, if a name does not match on a message delivery attempt, the sending node does not deliver the message. The message is returned as non-deliverable to the sender. The sending node then schedules an administrative retrieval of the current name for the mailbox from the receiving node. The new text and voice name are retrieved and the NameNet directory on the sending node is updated.

There are obvious cases where differences in the text name would result in a nondelivery, and subsequent administrative retrieval of a current name (for example, John Doe and Sam Jones, or Lisa Anderson and Mark Williams). Other cases are more subtle. For example:

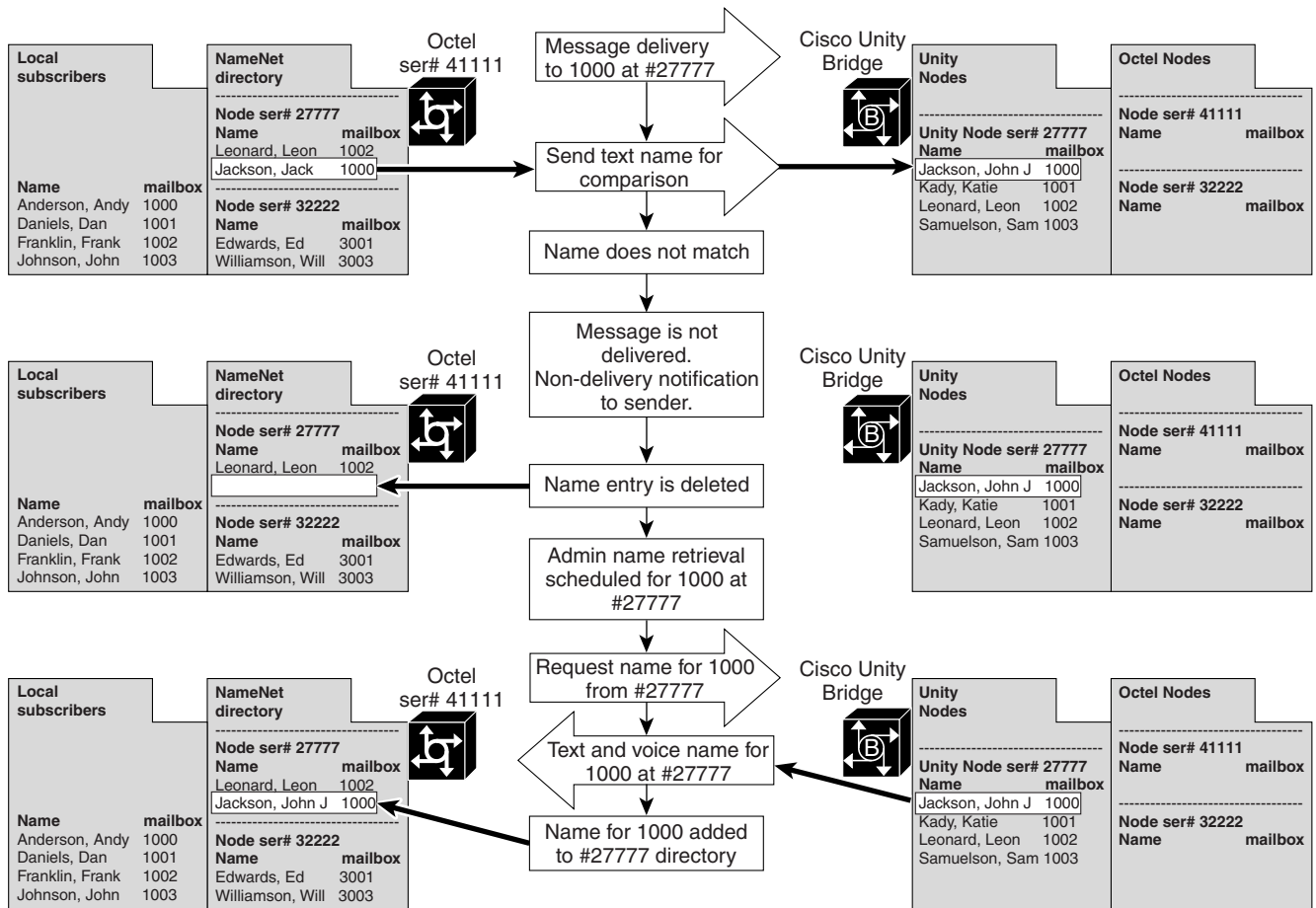
- Tate, Jon → Tate, John (spelling correction)
- Smith, Mary → Jones, Mary (marriage or legal name change)
- Smith, Mary → Smith-Jones, Mary (marriage)

In cases like these, the human leaving the message would likely know that it is actually still the same person at the mailbox. But the name comparison functionality built into the analog protocol cannot make such assumptions.



The effect of this implementation, when first migrating an Octel server to Cisco Unity and the Bridge, can be significant. Consider a scenario where an Octel server in the network is being replaced by Cisco Unity and the Bridge. There are a number of reasons why subscriber names may not be spelled exactly the same on Cisco Unity as they were on the former Octel server. For example, many customers use the migration to Cisco Unity as an opportunity to perform cleanup work on the names of subscribers. In addition, the Unity subscriber names stored on the Bridge for propagation to other Octel servers are the display name attributes of the Unity subscriber. The Unity display name allows more characters and flexibility than the Octel mailbox name entry. See Figure 30.

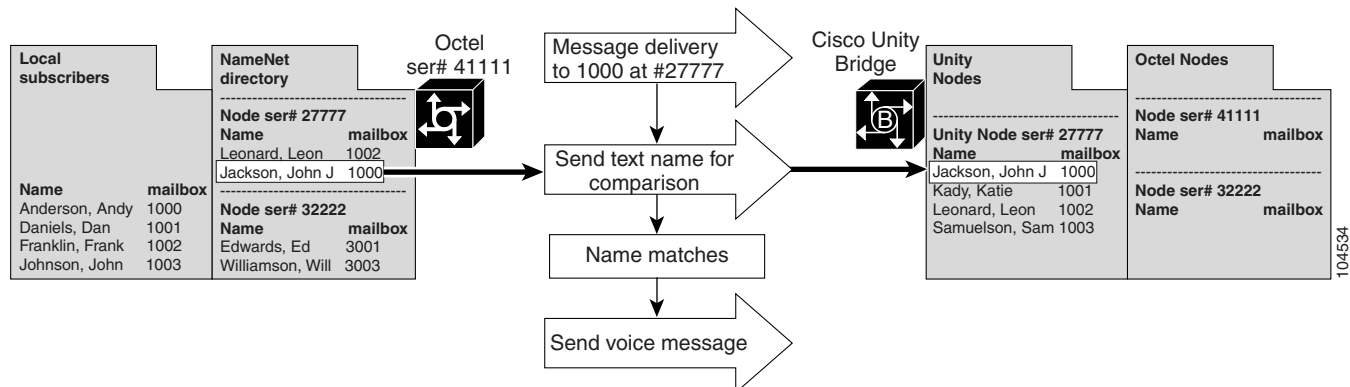
Figure 30: Text Name Mismatch Results in Failure to Delivery a Voice Message



When an Octel node has retrieved an updated name from the Bridge server, successful message delivery to this recipient will resume. See Figure 31.



Figure 31: Successful Text Name Confirmation When Delivering a Voice Message



Loss of NameNet Entries on Octel When Prefixes Are Reassigned

When a migration of Octel subscribers to Cisco Unity requires reassignment of an addressing prefix on the other Octel servers in the network, consider the impact this may have on the availability of NameNet entries for subscribers on the other Octel servers. Consider the example illustrated in Figures 4 and 5 in Chapter 2, which shows a migration scenario involving subscribers in Detroit, Montreal, Seattle, and New York.

In this scenario, the Detroit Octel was configured with a single node for Seattle with addressing prefixes of 2065254, 2065255, and 206326, prior to any Seattle subscribers migrating to Cisco Unity. Over time, as Detroit Octel subscribers sent messages to Seattle Octel subscribers, the NameNet directory for Seattle on the Detroit Octel became populated with the text and voice names associated with Seattle mailboxes 54xxx, 55xxx, and 6xxxx. Detroit subscribers sending network messages to 2065254xxx, 2065255xxx, and 206326xxxx would come to expect that they will hear recorded name confirmation when addressing these subscribers.

When the 206326 subscribers migrate to Cisco Unity from the Seattle Octel, the 206326 prefix is reassigned to the new profile for Cisco Unity and the Bridge, with serial number 59999. Detroit Octel subscribers can still address messages to these subscribers by using a network address of 206326xxxx, but now these addresses are associated with the new 59999 profile, which does not yet have NameNet entries for mailboxes 6xxxx. The first Detroit Octel subscribers to send messages to these Seattle subscribers will not hear recorded name confirmation, but instead will hear confirmation of the mailbox number and location. These first messages will result in administrative calls from the Detroit Octel to the Bridge to retrieve the text and voice names of these subscribers, provided to the Bridge by the Unity bridgehead. Over time, the NameNet directory will repopulate with the text and voice names for the Seattle Unity subscribers and the expected voice confirmation and address-by-name capability will be restored.

This same behavior will occur on other Octel servers in the network as well. Each Octel server keeps its own NameNet directory for the nodes with which it communicates.



If desired, the impact to Octel subscribers can be minimized by manually populating the NameNet directories on the Octel servers for the node profiles to which a prefix has been newly assigned. This will trigger the Octel server to retrieve the text and voice names for these mailboxes from the Bridge, so they are present the first time an Octel subscriber attempts to address to them after the recipients have migrated from Octel to Cisco Unity. Consult your Octel administrator or Octel documentation for details on the specific instructions and capabilities for your particular Octel model and version.

Adding the Network Address of a Remote Octel Subscriber to a Cisco Unity Distribution List

Adding a remote Octel subscriber to a Cisco Unity distribution list requires that a Bridge subscriber for the Octel subscriber be present in the Cisco Unity network. This requirement is sometimes unexpected when subscribers and administrators who are accustomed to working with the Octel system move to Cisco Unity. Octel allows you to add the network address of a subscriber on a remote Octel analog networking node to a distribution list, without requiring that a NameNet entry for the remote subscriber be present. Be sure to consider this when planning whether Bridge subscribers will be explicitly imported on the Cisco Unity bridgehead, and when planning auto-creation and modification settings on the bridgehead for Bridge subscribers.

Notable Nondelivery Receipt Behavior

The Cisco Unity Bridge and Cisco Unity simulate the behavior of an Octel node within the network as closely as possible. But there is a limitation related to the handling of non-deliverable messages.

An Octel server is a single entity, with a self-contained directory of subscriber mailboxes and the capability to place and receive Octel analog networking calls. For this reason, the Octel always has the information necessary to determine whether a message from a remote Octel server should be accepted during processing of the message delivery call. If a recipient Octel determines that a message should not be accepted, for example because of an invalid mailbox, a full mailbox, or a mailbox that is not accepting network messages, it does not accept the message from the remote Octel. See Figures 32 and 33.

Figure 32: Mailbox 1000 on Node with Ser# 20000 Exists and Is Accepting Network Messages

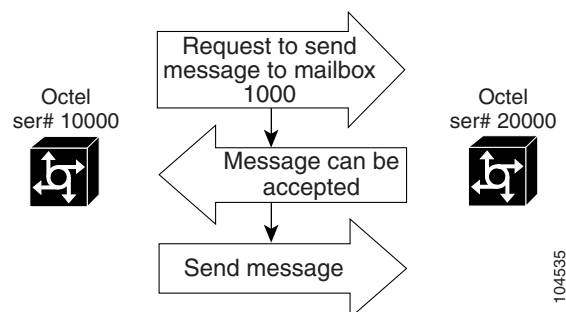
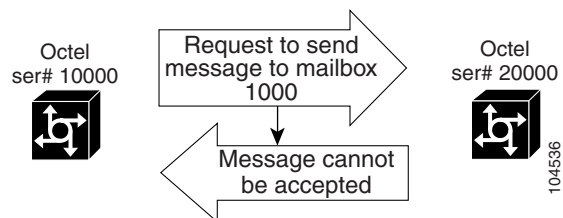


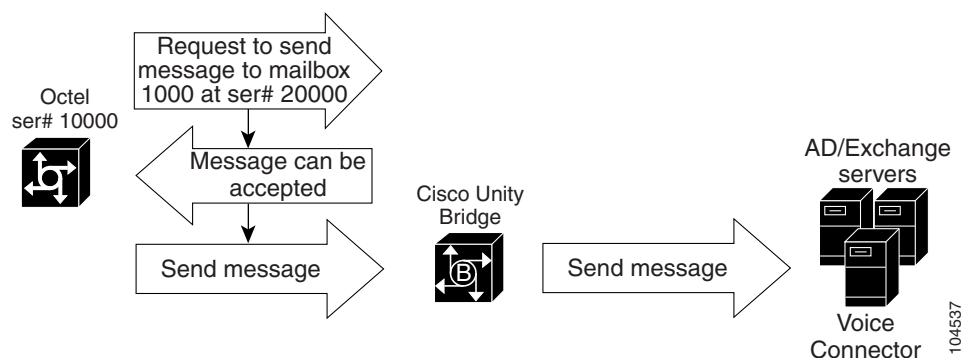


Figure 33: Mailbox 1000 on Node with Ser# 20000 Does Not Exist or Is Not Accepting Network Messages



Cisco Unity and the Bridge, on the other hand, synchronize subscriber information via the sending of SMTP messages. The Unity subscriber information on the Bridge is expected to be consistent with the actual Unity database, but this consistency is not assumed for the purpose of receiving messages. For example, occasional lag time in directory updates or other temporary conditions can occur. In addition, specific information about Unity subscriber mailboxes, for example whether the mailbox is full, is not tracked on the Bridge server. For this reason, the Bridge will always accept an inbound message from an Octel server as long as the node information for the destination is valid. See Figure 34.

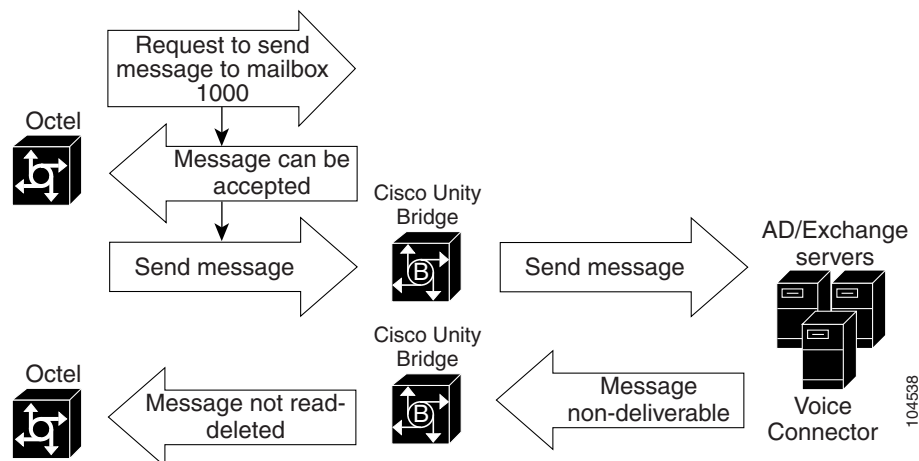
Figure 34: Bridge Accepts Message for Mailbox 1000, Checking Only That It Is Configured to Accept Messages for Unity Node with Ser# 20000



In a circumstance where the Bridge accepts a message from the Octel, but the message is later returned to the Bridge as non-deliverable, the Bridge must now place a call to the Octel to provide nondelivery notification. Because this circumstance does not normally occur in the Octel analog network (as the Octel server can determine during the delivery call whether to accept the message in the first place), the ability for the Bridge to provide a nondelivery notification to the Octel is limited. In this case, the Bridge delivers a “non-read” notification. The prompt that the Octel subscriber hears when receiving this notification varies depending on the Octel type. In most cases, it will be worded slightly differently than the prompt normally heard when a network message could not be delivered (for example, “the message was not read,” or something similar). See Figure 35.



Figure 35: Voice Connector Determines There Is No Cisco Unity Subscriber Configured as Legacy Mailbox 1000 with Remote Node ID of 20000, or That the Mailbox Exists But Cannot Accept Messages



Recorded Names Included in Messages From Octel, But Not From Cisco Unity

When a voice message is delivered from an Octel via Octel analog networking, the sending Octel usually includes the recorded voice name of the sending subscriber at the beginning of the message. Cisco Unity subscribers have the capability to specify in their own subscriber conversation whether to include sender information prior to playing a message. A Cisco Unity subscriber who has enabled this option may experience hearing the recorded name of a sender twice when listening to a message from a remote Octel subscriber: once announced by the Cisco Unity conversation, based on the recorded name stored for the associated Bridge subscriber object, and again as the beginning of the voice message received from the remote Octel server.

When a Cisco Unity subscriber sends a message to a subscriber on a remote Octel server via the Cisco Unity Bridge, the recorded voice name of the sender is not included at the beginning of the message. Octel subscribers receiving network messages from Cisco Unity subscribers via the Bridge may notice this discrepancy.



Appendix A: Sample Performance Data

Cisco Unity Bridge Server Storage Considerations

Table 6. Bridge Server Storage Considerations

Object	Disk Space Consumption
<p>Database</p> <p>The Bridge uses a Microsoft Access database to store its data. The database file name is starfish.mdb. The Directory table in starfish.mdb, which stores all Unity Node directory entries and Octel Node directory entries, will be the largest table in the starfish.mdb database.</p>	<ul style="list-style-type: none">• Allow 25 MB for 10,000 directory entries• Allow 125 MB for 20,000 directory entries• Allow 500 MB for 40,000 directory entries
<p>Recorded Voice Names for Unity Node Directory Entries</p> <p>The Bridge server contains folders named with the serial number of each Unity Node. Each folder contains recorded voice name files for the directory entries associated with the node. The files for Unity Node directory entries are stored in the G.711 format (8 KB per second).</p>	<ul style="list-style-type: none">• Disk space storage for a 2-second voice name will be 16 KB, a 5-second voice name will be 40 KB, and so on.• For example: 5,000 Unity Node directory entries with an average of 3-second voice name recordings will consume 120 MB on the Bridge server (5,000 x 24 KB).



Object	Disk Space Consumption
<p>Recorded Voice Names for Octel Node Directory Entries</p> <p>The Bridge server contains folders named with the serial number of each Octel Node. Each folder contains recorded voice name files for the directory entries associated with the node. The files for Octel Node directory entries are stored in the G.711 format (8 KB per second).</p> <p>Additionally, once a recorded voice name for an Octel subscriber has been included in a directory update sent to Unity, a copy of the recording is stored with the propagation data sent. Therefore, the recorded voice name for an Octel Node directory entry effectively consumes disk space equivalent to two times the size of the recording.</p> <p>Note: When G.729a is selected as the Unity Node codec, transcoding to G.729a occurs on the fly when sending a directory message to the bridgehead. All Octel subscriber recorded voice names are stored on the Bridge in G.711 regardless of Unity Node codec settings.</p>	<ul style="list-style-type: none">• Disk space storage for a 2-second voice name will be 16 KB, a 5-second voice name will be 40 KB, and so on.• For example, 5,000 Octel Node directory entries with an average 3-second voice name recording will consume 240 MB on the Bridge server (5,000 x 24 KB x two copies of each voice recording).
<p>Propagation Records</p> <p>The Bridge sends Octel subscriber directory information to the bridgehead in the form of vCards within the SMTP directory messages. The vCard information by default is stored on the Bridge server in the changes.vcf file for 60 days.</p>	<p>Allow 1 MB disk space per 5,000 vCards sent from the Bridge to the bridgehead for any 60-day period.</p>
<p>Queued Analog Messages to Octel</p> <p>Once queued for analog delivery to an Octel node, the files are in G.711 format for playout via the Brooktrout TR114.</p> <p>This is true whether the original message from Cisco Unity arrived in G.711 or G.729a.</p>	<ul style="list-style-type: none">• A 30 second message is approximately 240 KB• 100 messages x 240 KB is approximately 24 MB• A 60 second message is approximately 480 KB• 100 messages x 480 KB is approximately 48 MB



Object	Disk Space Consumption
<p>Queued SMTP Messages to Cisco Unity</p> <p>Rarely do SMTP messages queue for any significant amount of time when outbound to Cisco Unity. However, if Retention Days for Temporary SMTP Messages is set for more than zero days on the Digital Networking page in the Bridge Administrator, copies of all messages sent to Cisco Unity are stored on the Bridge server, and disk space for the messages needs to be considered. The amount of disk space consumed by the SMTP messages depends on whether the Bridge is configured to send messages by using the G.711 codec or the G.729a codec.</p>	<p>G.711</p> <ul style="list-style-type: none">• Approximately 10 KB per second• A 60 second message is approximately 600 KB• 100 messages x 600 KB is approximately 60 MB <p>G.729a</p> <ul style="list-style-type: none">• Approximately 1.25 KB per second• A 60 second message is approximately 75 KB• 100 messages x 75 KB is approximately 7.5 MB

Directory Synchronization Considerations

Initial Directory Propagation

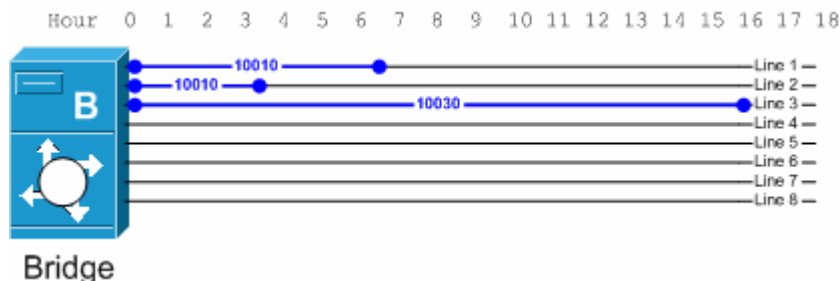
When first configuring the Bridge(s) to communicate with Octel servers, consider the following issues related to directory propagation.

If you are using MBUpload.exe on the Bridge server to bulk import mailboxes, and to have the Bridge retrieve the names from the Octel server(s), allow 6 to 7 hours per 1,000 Octel subscribers for a node. These figures are based on the maximum recorded voice name length of 8 seconds, and assume that all Octel subscribers have a recorded voice name, so your actual time may be less. The Bridge will only place one administrative call to any single Octel node at a time, but can call any number of separate Octel nodes simultaneously.

- Example 1 (see Figure 36): 8 port Bridge server; MBUpload.exe used to import the following mailboxes on the Bridge:
 - 1,000 mailboxes for node serial number 10010
 - 500 mailboxes for node serial number 10020
 - 2,500 mailboxes for node serial number 10030

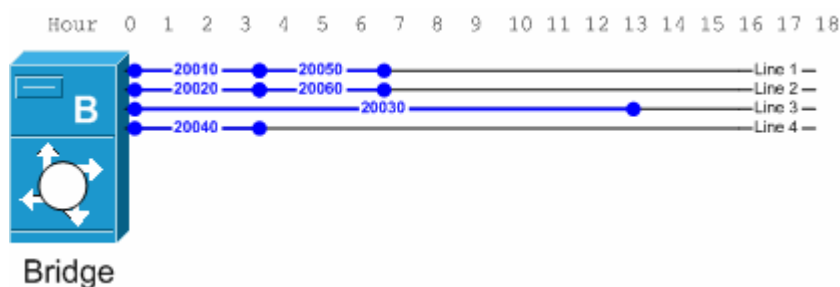


Figure 36: Maximum Analog Call Durations to Retrieve Names from Remote Octel Servers



- Example 2 (see Figure 37): 4 port Bridge server; MBUpload.exe used to import the following mailboxes on the Bridge1:
 - 500 mailboxes for node serial number 20010
 - 500 mailboxes for node serial number 20020
 - 2,000 mailboxes for node serial number 20030
 - 500 mailboxes for node serial number 20030
 - 500 mailboxes for node serial number 20050
 - 500 mailboxes for node serial number 20060

Figure 37: Maximum Analog Call Durations to Retrieve Names from Remote Octel Servers



The analog administrative retrieval of names from Octel servers will result in SMTP directory messages being sent from the Bridge to the Cisco Unity bridgehead. The rate and size of these messages will vary greatly, depending on whether the remote Octel subscribers have recorded voice names, and how long the recordings are. A good estimate to use when the Bridge is retrieving a long list of records from an Octel node would be approximately 150 to 250 records per hour per analog line (assuming continuous administrative retrieval and approximately 10 records per message). The Bridge will process all records as received, but will send SMTP directory messages to the bridgehead with an interval of 60 seconds between each message. In Example 1, this would mean that the Bridge is processing approximately 45 to 75 SMTP directory messages containing 450 to 750 vCards for the first three plus hours, 30 to 50 SMTP directory



messages containing 300 to 500 vCards for the next three plus hours, and 15 to 25 SMTP directory messages containing 150 to 250 vCards for approximately nine hours. If the processing of messages during the first three plus hours results in more than 60 messages per hour, SMTP directory messages queued for delivery to the bridgehead may back up temporarily, but will eventually all be sent as the 60-second interval allows. The SMTP directory messages are spaced at 60 second send intervals to ensure proper sequencing. A backlog of SMTP directory messages has no impact on delivery of voice messages. Voice messages are always sent immediately from the Bridge to Cisco Unity upon processing.

Keep an eye on the Exchange server on which the Voice Connector is installed, and monitor the following:

- Disk space consumed by Exchange logs as the Voice Connector handles a large volume of directory messages.
- Disk space consumed by the Exchange databases as the Voice Connector handles a large volume of directory messages.

Additionally, monitor the resources for the Digital Networking (vpim.exe) and Unity Bridge (starfish.exe) services on the Bridge server. If the Unity Node profiles on the Bridge server are configured such that the Bridge is sending recorded voice names to Unity in G.729a format, the average size of the messages sent to Cisco Unity will usually be somewhat less, but the resources necessary to convert the G.711 recordings of the Bridge to G.729a in the SMTP messages can result in heavy periods of % Processing Time consumed by the Digital Networking (vpim.exe) service.

When first configuring Cisco Unity to communicate with the Bridge, or when an Octel node is first migrated to Cisco Unity, consider the following issues related to directory propagation:

If you have a large number of Cisco Unity subscribers in your network (more than 2,000), or have just imported a large number of Cisco Unity subscribers into your network, there may be a period of heavy SMTP directory message traffic from the bridgehead server to the Bridge. Keep an eye on the Exchange server on which the Voice Connector is installed, and monitor the following:

- Disk space consumed by Exchange logs as the Voice Connector handles a large volume of directory messages.
- Disk space consumed by the Exchange databases as the Voice Connector handles a large volume of directory messages.

Additionally, monitor the resources for the Digital Networking (vpim.exe) and Unity Bridge (starfish.exe) services on the Bridge server. The Unity bridgehead can send 300 or more directory messages per hour to the Bridge, containing 3,000 or more records. If the majority of Cisco Unity subscribers have recorded voice names, and if those names are in the G.729a format, the % Processing Time for the Digital Networking (vpim.exe) service may show usage of 80 to 90 percent for periods as the Bridge processes the inbound directory messages. This behavior is specific to conditions when the bridgehead is sending full directory data for a group of Cisco Unity subscribers associated with a particular Node ID, which only occurs when first adding a Unity Node profile to the Bridge server, or when manually initiating a send of full Cisco Unity subscriber data to the Bridge. Sequencing of all other directory messages sent from the



bridgehead to the Bridge (for example, regular moves, adds, and changes) is such that a heavy processing spike on the Bridge server will not be common.

In general, when first deploying a Bridge, allow as much initial directory propagation between the Bridge and Cisco Unity to finish as your situation allows before subscribers start sending messages. After the initial directory propagation has concluded, there will be minimal affects from normal directory propagation patterns, unless you add a substantial number of subscribers at one time.

Effect of Multiple Bridge Servers on Directory Synchronization

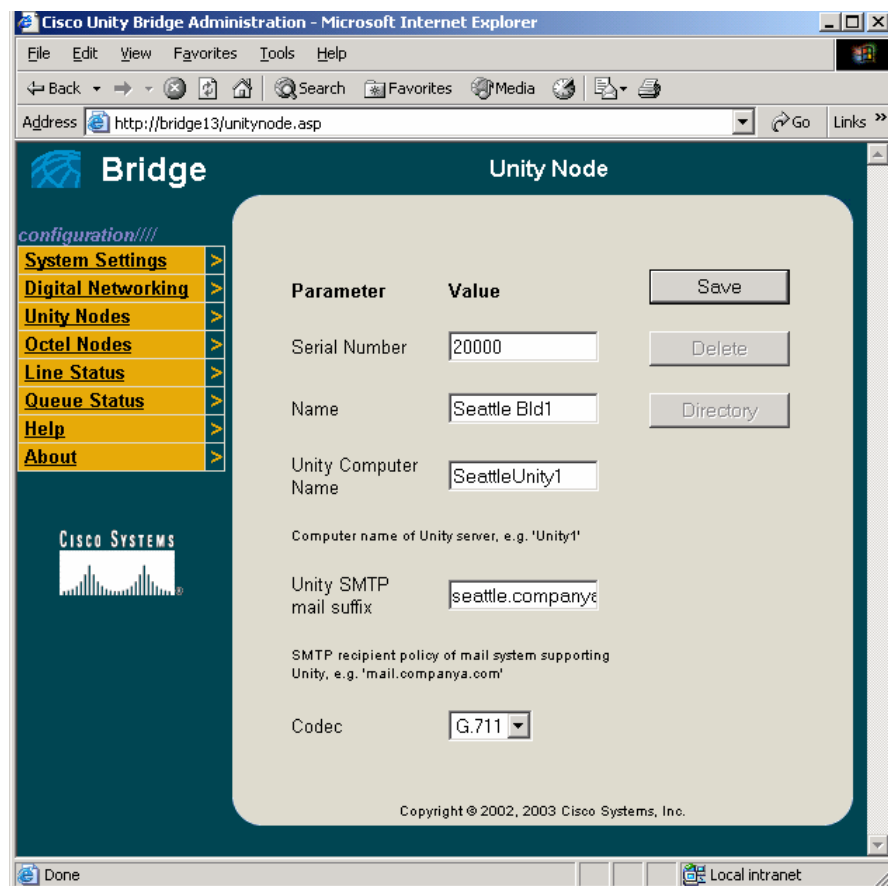
Cisco Unity subscriber update information must be sent to each Bridge server. Therefore, using two Bridge servers will result in twice the directory message traffic from the bridgehead(s) to the Bridge(s). Likewise, three Bridge servers will result in three times the directory message traffic, and so on.

A bridgehead server combined with a Bridge server (or servers) can represent the serial number of each Octel whose subscribers have migrated to Cisco Unity. Up to 998 nodes can be represented. On the Bridge server, you add a Unity Node for each node that the bridgehead and Bridge servers represent in the network. Each Unity Node is identified by serial number, and each Cisco Unity subscriber is assigned a serial number that corresponds to a Unity Node serial number.

Figure 38 shows that the Unity Node does not require much in the way of configuration settings. Therefore, the disk space that a Unity Node consumes on the Bridge server is negligible.



Figure 38: Unity Node Page in the Bridge Administrator



Effect of Multiple Unity Nodes on Directory Synchronization Between Cisco Unity and the Bridge

Directory messages from the bridgehead server to the Bridge are batched per Unity Node. A single directory message can contain multiple add, change, and delete requests, but only for one Unity Node. The number of Unity Nodes affects the number of directory messages sent to the Bridge, but not the number of requests. Therefore, the number of Unity Nodes does not affect the amount of the data that is sent over the network.

For example, assume that one Unity Node has been configured on the Bridge, and that all Cisco Unity subscribers are assigned the Unity Node serial number. If you were to add a new Unity Node, and reassign half of the subscribers to the serial number of the new Unity Node, the number of directory messages sent from the bridgehead to the Bridge server would increase. However, the total amount of data sent from the bridgehead to the Bridge would be the same.



Effect of Multiple Unity Nodes on the Processing of Analog Voice Messages

Analog voice messages from an Octel node to the Bridge are batched by serial number. A message from an Octel subscriber that is addressed to three Cisco Unity subscribers who have the same serial number would be delivered to all three recipients on the same call, with one transmission of the message. However, a message from an Octel subscriber that is addressed to three Cisco Unity subscribers who have different serial numbers would result in three separate calls and transmissions of the message, as illustrated in Figures 39 and 40. The transmission of three separate messages either ties up three separate ports (if three ports are available), or if only one port is available, the port is tied up three times as long. Either way, the three transmissions result in three messages processed on the Bridge server, and three separate messages sent from the Bridge to Cisco Unity. This results in an increase in network traffic and processing by Exchange and the Voice Connector.

Figure 39: Voice Messages Sent from an Octel Node to the Bridge Where Cisco Unity Recipients Are Represented By Multiple Serial Numbers

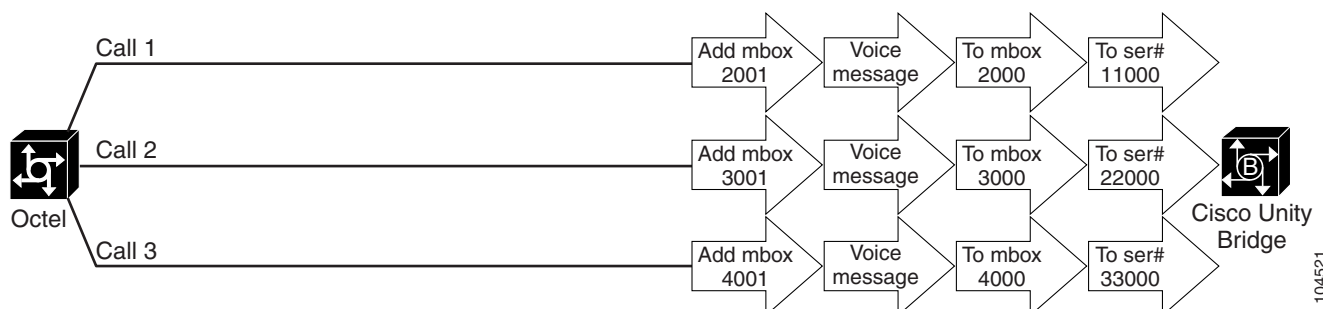
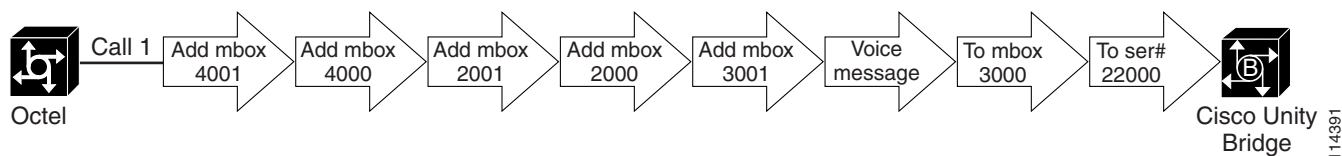


Figure 40: Voice Messages Sent From an Octel Node to the Bridge Where Cisco Unity Recipients Are Represented by a Single Serial Number



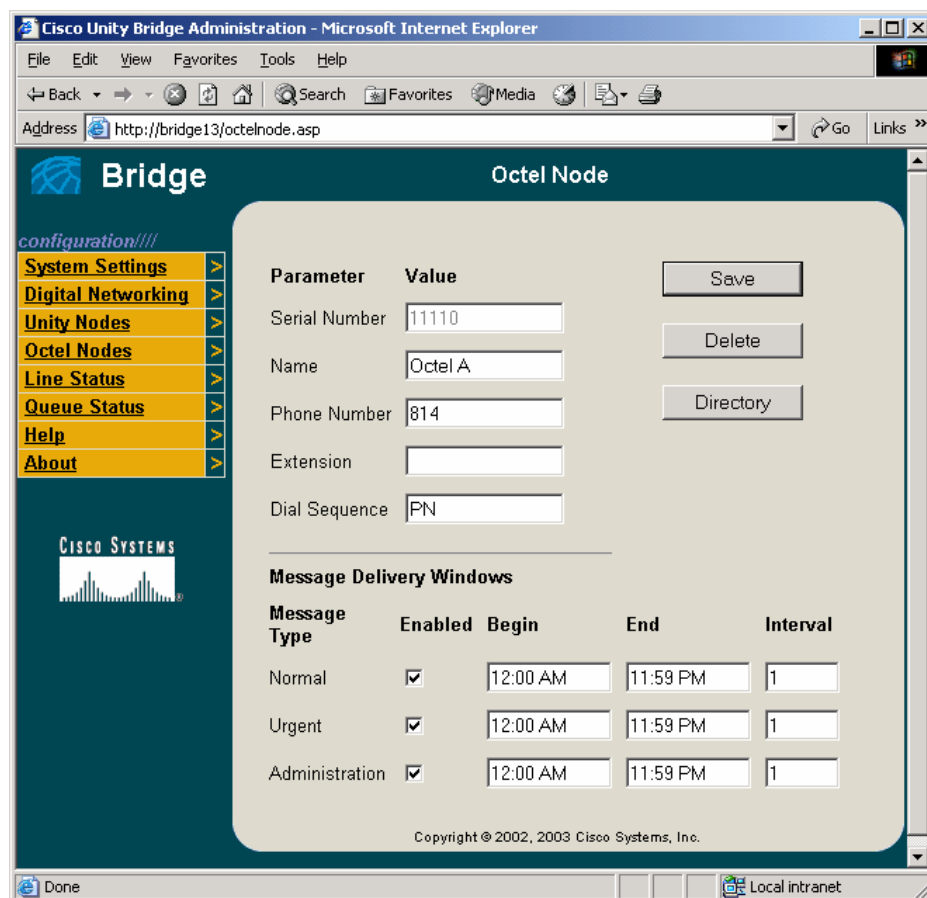
Octel Node Considerations

A bridgehead server combined with a Bridge server (or servers) can communicate with up to 998 Octel nodes in the Octel analog network. On the Bridge server, you add an Octel Node for each node with which the bridgehead and Bridge servers will communicate. Each Octel Node is identified by serial number.



Figure 41 shows that the Octel Node does not require much in the way of configuration settings. Therefore, the disk space that a Unity Node consumes on the Bridge server is negligible.

Figure 41: Octel Node Page in the Bridge Administrator



Effect of Multiple Octel Nodes on Directory Synchronization Between the Bridge and Cisco Unity

Directory messages from the Bridge to the bridgehead server are batched per Octel Node. A single directory message can contain multiple add, change, and delete requests, but only for one Octel Node. The number of Octel Nodes affects the number of directory messages sent to the bridgehead, but not the number of requests. Therefore, the number of Octel Nodes does not affect the amount of the data that is sent over the network.

The main factor in directory synchronization traffic is the total number of Octel Node directory entries, and how often they are updated. The number of Octel Nodes to which the Octel Node directory entries are distributed is less of an issue. Note that only one copy of the Octel subscriber directory information is sent to the bridgehead, regardless of the number of Unity Nodes configured.



Effect of Multiple Octel Nodes on the Processing of Analog Voice Messages

Each Octel Node has three delivery windows, each with its own schedule (see Figure 41). Outgoing messages from the Bridge to an Octel node are placed in queues. The Bridge maintains three queues for each node—one queue each for normal, urgent, and administrative messages. Queued messages are processed in first-in-first-out (FIFO) order. The more Octel Nodes that are configured, the more server resources will be consumed for analog call processing.

Performance Impact of Directory Synchronization to the Bridge

Table 7 describes the performance impact to the Bridge server of the Digital Networking service (vpim.exe) and the Bridge service (starfish.exe). These are the two main services that make up the Bridge software.

Table 7. Performance Impact to the Bridge Server

Service	Processing Rate	Physical Memory Increase	Virtual Memory Increase	CPU Percentage Increase
Digital Networking service processing changes from Cisco Unity	3,000 vCards per hour	2 MB	0 to 5 MB	7 percent
Cisco Unity Bridge service processing changes from Cisco Unity	3,000 vCards per hour	None	None	None
Digital Networking service processing changes to Cisco Unity	Maximum rate	2 MB	0 to 5 MB	<ul style="list-style-type: none">• G.729: Maximum available• G.711: 60 percent
Cisco Unity Bridge service processing changes to Cisco Unity	Maximum rate	None	None	None



Unity Nodes

Table 8. Unity Node Description

Maximum number of Unity Nodes	998
HDD/database consumption per Unity Node	Impact is negligible for the node object itself. For more information, see Unity Node Directory Entries.
Impact of X number of Unity Nodes on directory synchronization between the bridgehead and the Bridge server	<p>The number of messages sent from the bridgehead to the Bridge server increases when more Unity nodes are being represented, because each message sequence can contain only the subscribers with the same Unity Node serial number. However, the total amount of data sent from the bridgehead to the Bridge server is the same regardless of the number of Unity nodes.</p> <p>Cisco Unity subscriber update information must be sent to each Bridge server. Therefore, using two Bridge servers results in twice the directory message traffic from the bridgehead(s) to the Bridge(s). Three Bridge servers would result in three times the directory message traffic, and so on.</p>
Impact of X number of Unity Nodes on the processing of analog voice messages under load	<p>There is no significant difference, in terms of the resources required to process X number of calls or X number of messages.</p> <p>For example, a message from an Octel subscriber that is addressed to six Cisco Unity subscribers, where the six subscribers are represented by different serial numbers (two subscribers to each of three serial numbers) will result in three separate calls to deliver the message to the Bridge. If the same message is addressed to six Cisco Unity subscribers who are all represented by the same serial number, the message is delivered to all recipients on the same call, with only one transmission of the message.</p>



Octel Nodes

Table 9. Octel Node Description

Maximum number of Octel Nodes	998
HDD/database consumption per Octel Node	Impact is negligible for the node object itself. For more information, see Unity Node Directory Entries.
Impact of X number of Octel Nodes on directory synchronization between the bridgehead and the Bridge server	<p>Having more Octel Nodes for same total number of Octel Node directory entries would result in potentially more SMTP directory message traffic from the Bridge to the bridgehead. However, the total number of subscriber updates sent in the messages would be the same. The main factor in directory sync traffic is total number of Octel Node directory entries, and the number of updates for them that occur. Relative to that, the number of Octel Nodes that the Octel Node directory entries are distributed across is less of an issue.</p> <p>Only one copy of Octel subscriber directory information is sent to the bridgehead, regardless of the number of Unity Nodes configured.</p>
Impact of X Octel Nodes on the processing of analog voice messages under load	For each Octel Node there are three delivery windows—each with its own schedule and queue handling—for the Bridge to maintain. More Octel Nodes configured results in more server resources consumed for analog call processing.



Corporate Headquarters

Cisco Systems, Inc.
170 West Tasman Drive
San Jose, CA 95134-1706
USA
www.cisco.com
Tel: 408 526-4000
800 553-NETS (6387)
Fax: 408 526-4100

European Headquarters

Cisco Systems International
BV
Haarlerbergpark
Haarlerbergweg 13-19
1101 CH Amsterdam
The Netherlands
www-europe.cisco.com
Tel: 31 0 20 357 1000
Fax: 31 0 20 357 1100

Americas Headquarters

Cisco Systems, Inc.
170 West Tasman Drive
San Jose, CA 95134-1706
USA
www.cisco.com
Tel: 408 526-7660
Fax: 408 527-0883

Asia Pacific Headquarters

Cisco Systems, Inc.
Capital Tower
168 Robinson Road
#22-01 to #29-01
Singapore 068912
www.cisco.com
Tel: +65 317 7777
Fax: +65 317 7799

Cisco Systems has more than 200 offices in the following countries and regions. Addresses, phone numbers, and fax numbers are listed on **the Cisco Web site at www.cisco.com/go/offices.**

Argentina • Australia • Austria • Belgium • Brazil • Bulgaria • Canada • Chile • China PRC • Colombia • Costa Rica • Croatia • Czech Republic • Denmark • Dubai, UAE • Finland • France • Germany • Greece • Hong Kong SAR • Hungary • India • Indonesia • Ireland • Israel • Italy • Japan • Korea • Luxembourg • Malaysia • Mexico • The Netherlands • New Zealand • Norway • Peru • Philippines • Poland • Portugal • Puerto Rico • Romania • Russia • Saudi Arabia • Scotland • Singapore • Slovakia • Slovenia • South Africa • Spain • Sweden • Switzerland • Taiwan • Thailand • Turkey • Ukraine • United Kingdom • United States • Venezuela • Vietnam • Zimbabwe

Copyright © 2004 Cisco Systems, Inc. All rights reserved. Cisco, Cisco Systems, the Cisco Systems logo, Aironet, Catalyst, Cisco IOS, and IP/TV are registered trademarks or trademarks of Cisco Systems, Inc. and/or its affiliates in the U.S. and certain other countries. All other trademarks mentioned in this document or Web site are the property of their respective owners. The use of the word partner does not imply a partnership relationship between Cisco and any other company. (0304R)

Printed in the USA