



# TSBroadcaster User's Guide Cisco's OCAP Object Carousel Solution

# **Please Read**

## **Important**

Please read this entire guide. If this guide provides installation or operation instructions, give particular attention to all safety statements included in this guide.

# Notices

## Trademark Acknowledgments

Cisco and the Cisco logo are trademarks or registered trademarks of Cisco and/or its affiliates in the U.S. and other countries. A listing of Cisco's trademarks can be found at [www.cisco.com/go/trademarks](http://www.cisco.com/go/trademarks).

OCAP is a trademark of Cable Television Laboratories, Inc.

Other third party trademarks mentioned are the property of their respective owners.

The use of the word partner does not imply a partnership relationship between Cisco and any other company. (1009R)

## Publication Disclaimer

Cisco Systems, Inc. assumes no responsibility for errors or omissions that may appear in this publication. We reserve the right to change this publication at any time without notice. This document is not to be construed as conferring by implication, estoppel, or otherwise any license or right under any copyright or patent, whether or not the use of any information in this document employs an invention claimed in any existing **or** later issued patent.

## Copyright

© 2006, 2012 Cisco and/or its affiliates. All rights reserved. Printed in the United States of America.

Information in this publication is subject to change without notice. No part of this publication may be reproduced or transmitted in any form, by photocopy, microfilm, xerography, or any other means, or incorporated into any information retrieval system, electronic or mechanical, for any purpose, without the express permission of Cisco Systems, Inc.

---

# Contents

<b>About This Guide</b> .....	ix
<b>Chapter 1</b>	<b>Introducing Cisco's OCAP Object Carousel Solution: The TSBroadcaster</b>
Overview .....	1-1
OCAP Object Carousel Acronyms and Terms.....	1-2
Functional Overview .....	1-9
The TSBroadcaster System View .....	1-13
Setting Up An Application to Play Out in a Stream .....	1-15
<b>Chapter 2</b>	<b>Setting Up the TSBroadcaster</b>
Overview .....	2-1
Configure the DNCS for the TSBroadcaster.....	2-2
Set Password and Time Zone .....	2-11
Shut Down the Server.....	2-13
Configure the TSBroadcaster Client Machines.....	2-14
Configure Delivery System Parameters.....	2-16
Add Audio and Video Content.....	2-17
<b>Chapter 3</b>	<b>Using the TSBroadcaster</b>
Overview .....	3-1
Log In to the TSBroadcaster .....	3-3
Get to Know the TSBroadcaster User Interface .....	3-6
Stream Management.....	3-14
Create an OCAP Stream.....	3-15
Edit the OCAP Stream.....	3-18
Create an OCAP Service .....	3-22
Edit an OCAP Service.....	3-26
Delete a Stream.....	3-29
Delete a Service .....	3-30
Create a Carousel .....	3-32
Edit a Carousel .....	3-35
Delete a Carousel .....	3-38
Configure the Stream Event Channel .....	3-40

## Contents, Continued

	Clear a Stream Event Channel .....	3-43
	Create A/V Content .....	3-45
	Edit A/V Content .....	3-48
	Delete A/V Content.....	3-51
	Create an A/V Content Component .....	3-53
	Edit an A/V Content Component .....	3-56
	Delete an A/V Content Component .....	3-59
	Log Out of the TSBroadcaster .....	3-62
<b>Chapter 4</b>	<b>Managing Output</b>	
	Overview .....	4-1
	Create a Player.....	4-2
	Edit a Player.....	4-4
	Delete a Player.....	4-5
	Re-Send a Player .....	4-6
	Create a Transfer Player.....	4-7
	Edit a Transfer Player .....	4-9
	Delete a Transfer Player.....	4-10
	Re-Send a Transfer Player.....	4-11
	Resend the Latest XAIT Data .....	4-12
<b>Chapter 5</b>	<b>Managing Application Sets</b>	
	Overview .....	5-1
	Develop an Application Set.....	5-3
	Edit an Application Set .....	5-6
	Import an Application Set .....	5-9
	File Commands for Application Development .....	5-12
	Create an Application Set .....	5-24
	Add a File to the Application Set.....	5-26
	Delete an Application Set.....	5-28
	Download an Application Set .....	5-29
	Modify the DSM-CC File System.....	5-30
	Move Objects for an Application.....	5-32
	Place Objects In or Out of the Carousel .....	5-34

## Contents, Continued

Add a Directory.....	5-36
Import a File.....	5-38
Import a Content Directory .....	5-40
Add a Stream Event.....	5-42
Remove an Object from the TSBroadcaster.....	5-45
Edit an Object .....	5-47
Edit Object Properties.....	5-51
Edit a Stream Event .....	5-56
Remove a Stream Event .....	5-58
Restore Defaults .....	5-60
Add a Group.....	5-62
Move Objects From One Group to Another.....	5-65
Edit a Group .....	5-68
Delete a Group .....	5-70
Set Group Priorities .....	5-72
Add an Application to an Application Set.....	5-73
Edit an Application in an Application Set.....	5-77
Delete an Application from an Application Set.....	5-79
<b>Chapter 6</b>	<b>Managing Playouts</b>
Overview.....	6-1
View Scheduled Playouts .....	6-3
Change a Playout Time .....	6-5
Find Applications for a Service.....	6-7
Add a Playout.....	6-9
Edit a Playout .....	6-15
Break a Playout Into Two Independent Playouts.....	6-19
Manage Bit Rates.....	6-21
Delete a Playout .....	6-25

## Contents, Continued

<b>Chapter 7</b>	<b>Managing Updates</b>	
	Overview .....	7-1
	Create Polled Update .....	7-3
	Edit Polled Update.....	7-5
	Delete Polled Update.....	7-7
	Add a Directory to the Application Set .....	7-8
	Add a File to the Application Set.....	7-10
	Update an Object.....	7-12
	Update a Text File .....	7-14
	Remove an Object .....	7-16
<b>Chapter 8</b>	<b>Managing Stream Events</b>	
	Overview .....	8-1
	Send a Defined Stream Event .....	8-2
	Inject a Free Stream Event.....	8-4
<b>Chapter 9</b>	<b>Viewing Logs, Builds, and Archives</b>	
	Overview .....	9-1
	View the Current Event Log.....	9-3
	View Logs.....	9-5
	Dump Event Logs .....	9-7
	Download a Stream Build.....	9-9
	Download the Latest Build .....	9-11
	Download Archives.....	9-12
	Delete an Archive.....	9-14
	Server Management.....	9-15
	Retrieve a Model .....	9-17
	Suspend a Server.....	9-19
	Drop a Role .....	9-20
	Load a Model.....	9-21
	Assume a Role .....	9-25
	Drop a Partner .....	9-27
	Resume to a Checking Active Partner State or Standby.....	9-28

## Contents, Continued

	Refresh State Data .....	9-29
	Create a Trusted Host.....	9-30
	Edit a Trusted Host.....	9-32
	Delete a Trusted Host.....	9-34
	Monitor Status .....	9-36
<b>Chapter 10</b>	<b>TSBroadcaster Administration</b>	
	Overview .....	10-1
	Create User Accounts .....	10-2
	Change Passwords.....	10-4
	Edit User Privileges .....	10-6
	Delete User.....	10-8
	File System Description.....	10-9
	Maintain the TSBroadcaster .....	10-13
	TSBroadcaster Properties.....	10-15
	Configure A/V Content.....	10-21
	Configure ASI Output .....	10-24
	Deployment Options .....	10-25
<b>Chapter 11</b>	<b>Troubleshooting</b>	
	Overview .....	11-1
	Cannot Access TSBroadcaster from Browser.....	11-2
	Cannot Access the TSBroadcaster Login Page from Browser.....	11-3
	Java Applet Fails .....	11-4
	Cannot Drag Files on Linux Desktop.....	11-5
	Cannot Access the Navigation Bar .....	11-6
	Cannot Tune to Stream .....	11-7
	Player or Transfer Player Fails .....	11-8
	Time Changes Break Log File Display .....	11-9
	You Accidentally Delete the Wrong Thing .....	11-10
	Applications Start at the Wrong Times.....	11-11
	OCAP Explorer.....	11-12

**Contents**, Continued

**Chapter 12    TSBroadcaster APIs and SNMP Monitoring**

    Overview ..... 12-1

    Java API..... 12-2

    XML API..... 12-3

    SNMP Monitoring..... 12-5

# About This Guide

## Introduction

Cisco's solution for the OCAP Object Carousel incorporates the TSBroadcaster product from Strategy & Technology Limited (S&T). The TSBroadcaster allows you to manage, schedule, and broadcast interactive TV applications for OCAP standards. The TSBroadcaster can feed into a multiplexer to add interactive TV capability to broadcast content. The TSBroadcaster can also add interactive TV not associated with broadcast content. Or, the TSBroadcaster can provide a self-contained feed (with its own audio and video [A/V] content) for local modulation to support development and testing. Multiple users can enter information into the TSBroadcaster through a Web-enabled interface and a variety of application program interfaces (APIs).

The main body of this manual is written to cover the operation of a single OCAP Object Carousel deployed with integrated stream playout on a single SunFire V240 server. This guide provides the information needed to install, configure, and operate the TSBroadcaster.

## Purpose

Use this guide as a reference for configuring and using the TSBroadcaster.

## Requirements

The procedures in this guide are for systems operating System Release (SR) 4.0 or later and TSBroadcaster version 1.0.0.6.

## Audience

This guide is written for DNCS operators, system engineers, and Cisco Service engineers.

## About This Guide, Continued

### Related Publications

The following documents are referenced in this manual:

- *OCAP Installation and Upgrade Instructions* (part number 732578, expected published date: winter 2005)
- *System Release 4.0 CD Upgrade Installation Instructions* (part number 740015, expected published date: winter 2005)
- *System Release 4.0 Unipack Installation Instruction* (part number 4000636, expected published date, winter 2005)
- *System Release 4.0 Release Notes* (part number 4001703, expected published date: winter 2005)
- *OCAP Architecture Guide* (part number 738184, expected published date, winter 2005)
- *Configuring the DBDS System for Using the Common Download Process With OpenCable™ Hosts Application Guide* (part number 4011041, expected published date: winter 2005)

### Document Version

This is the second release of this document.

# Chapter 1

## Introducing Cisco's OCAP Object Carousel Solution: The TSBroadcaster

### Introduction

Cisco's solution for the OCAP Object Carousel incorporates the TSBroadcaster product from Strategy & Technology Limited (S&T). The TSBroadcaster allows you to manage, schedule, and broadcast interactive TV applications for OCAP standards. The TSBroadcaster can feed into a multiplexer to add interactive TV capability to broadcast content. The TSBroadcaster can also add interactive TV not associated with broadcast content. Or, the TSBroadcaster can provide a self-contained feed (with its own AV content) for local modulation to support development and testing. Multiple users can enter information into the TSBroadcaster through a Web-enabled interface and a variety of APIs. This chapter provides a list of acronyms used in this guide and a brief overview of the TSBroadcaster.

The TSBroadcaster may also be deployed in distributed and dual-redundant configurations. The differences in configuration and deployment of the TSBroadcaster and independent TSPlayers are covered in **Chapter 4, Managing Output**.

### In This Chapter

This chapter contains the following topics.

Topic	See Page
OCAP Object Carousel Acronyms and Terms	1-2
Functional Overview	1-9
The TSBroadcaster System View	1-13
Setting Up An Application to Play Out in a Stream	1-15

# OCAP Object Carousel Acronyms and Terms

## Introduction

This section provides a list of acronyms that are used throughout this guide. You should become familiar with these acronyms to help you better understand the OCAP Object Carousel concepts presented.

## List of Acronyms

The following acronyms are used in this guide.

- **AIT** - Application Information Table
- **API** - Application Program Interface
- **BFS** - Broadcast File System.
- **CA** - Conditional Access
- **CATV** - Cable TV
- **CRC** - Cyclic Redundancy Check
- **DHCP** - Dynamic Host Configuration Protocol
- **DII** - Download Information Indication
- **DSI** - Download Server Initiate
- **DVB** - Digital Video Broadcasting
- **EAS** - Emergency Alert System
- **ES** - Elementary Stream
- **FCC** - Federal Communications Commission
- **HDTV** - High Definition Television
- **HTML** - Hypertext Mark-up Language
- **HTTP** - Hypertext Transport Protocol
- **IP** - Internet Protocol
- **JDK** - Java Development Kit
- **MAC** - Media Access Control
- **MHP** - Multimedia Home Platform
- **MPEG** - Moving Picture Expert Group
- **MSO** - Multiple System Operator
- **MPTS** - Multiprogram Transport Streams
- **NTSC** - National Television Systems Committee
- **NVOD** - Near-Video-On-Demand
- **OCAP** - OpenCable Application Platform
- **OOB Channel** - Out-Of-Band channel

## OCAP Object Carousel Acronyms and Terms, Continued

- **OOB-FDC** - Out-Of-Band Forward-Data-Channel
- **OOB-RDC** - Out-Of-Band Reverse-Data-Channel
- **OS** - Operating System
- **PCR** - Program Clock Reference
- **PES** - Packetized Elementary Stream
- **PID** - Packet Identification number
- **PMT** - Program Map Table
- **POD** - Point of Deployment module
- **PPV** - Pay-Per-View
- **PSIP** - Program and System Information Protocol
- **SI** - Service Information
- **SNMP** - Simple Network Management Protocol
- **SPTS** - Single-Program Transport Streams
- **UI** - User Interface
- **VCT** - Virtual Channel Table
- **VOD** - Video-On-Demand
- **XAIT** - Extended Application Information Table

# OCAP Object Carousel Acronyms and Terms, Continued

## List of Terms

Refer to the following list for a description of the terms used in this guide.

Term	Description
Bound Application	<p>A bound application is an application that is bound to program content. The application is terminated when the user tunes to another channel service. Bound applications are typically signaled and delivered on the same data transport stream as the video. The life of the application is tied to a television program.</p> <p>An application that lets you participate in interactive voting, such as voting for a contestant on a television show, would be an example of a bound application.</p>
Build	<p>A build is the binary data of the transport stream. The build makes up all of the data or files in a transport stream.</p>
DSM-CC Object Carousel	<p>A Digital Storage Media – Command and Control (DSM-CC) object carousel for delivery on a QAM transport stream or QPSK or CMTS path. All OCAP applications may either share carousels or have their own dedicated carousels.</p> <p>You may need another object carousel when the bit rate of a single carousel exceeds the maximum bit rate that a particular receiver can handle. You may also need multiple object carousels to provide support for commercial separation or requirements for downstream remultiplexing and redistribution.</p>
Group	<p>A group is a container for DSM-CC objects. A “group” defines the set of files and directories should be broadcast together in the same module, if possible.</p> <p>Grouping is used for setting the priority of a file. The priority defines how often the group of files will be repeated.</p>

## OCAP Object Carousel Acronyms and Terms, Continued

Term	Description
Model	<p>A model is the saved TSBroadcaster configuration. The model is a representation of the configuration choices you made through the GUI. You can retrieve models containing development configurations, demonstrations, and test cases to be swapped in and out as often as necessary.</p> <p>A model contains all the information needed to perform its function:</p> <ul style="list-style-type: none"> <li>• Transport Stream definitions</li> <li>• Applications to be played out</li> <li>• Schedule for application playout</li> <li>• Players allocated for Transport Streams</li> <li>• Application update polling instructions</li> <li>• User account information</li> </ul>
Module	<p>A module is a physical data block that is used to broadcast file and directory data. The physical size limitations for a module are 64KB for a module containing multiple files and 1MB for a module containing a single file.</p>
Object Carousel	<p>The Object Carousel works like the Broadcast File Server in delivering data. In a TSBroadcaster system, you can have both an Object Carousel and a Broadcast File Server or one or the other. The descriptors for the transport streams are different depending upon the device.</p>
Player	<p>A player takes a TSBroadcaster build and turns the data into a stream. You can use a player for inband and system information (SI) data. The player is used for locally managed content.</p> <p>The player is a process that runs on the server. The player sends the data over TXmux using an Ethernet connection.</p>
Role	<p>A TSBroadcaster server will only operate if it has been assigned a role. A role is essentially the name of the job that the server is performing. The actual value of the role does not matter for a standalone server.</p>

## OCAP Object Carousel Acronyms and Terms, Continued

Term	Description
Service	<p>A service is a set of resources signaled from a single PMT. It is equivalent to an MPEG “Program” or the generic term “Channel.”</p> <p>If you are broadcasting applications that are bound to a set of services, then you will need to define that set of services. When the receiver is tuned to one of these services by a viewer, the applications associated with that service will be launched. For bound applications, you need one service per “channel” that you wish to signal applications on.</p> <p>If you are broadcasting unbound applications, then you need a service to allow the object carousels to be referenced. There is no need to make this a service visible to the viewer, although it must be signaled to allow the receiver to access it and read the unbound application content from the associated carousel(s). For unbound applications, you need a single service to act as an access point to the object carousel.</p>
Stream Event	<p>A stream event is an event that can happen at an arbitrary time. One example of a stream event is a ticker tape application that scrolls across the bottom of the TV screen.</p>

# OCAP Object Carousel Acronyms and Terms, Continued

Term	Description
Transfer Player	<p>A transfer player is the same as a player, but you can also use it for out of band data and unbound applications. When you create a Transfer Player, you will see the following additional fields:</p> <ul style="list-style-type: none"> <li>• Type - The type defines the type of data that a transfer player can send in the stream. A transfer player can send XAIT and CVT data for downloads. You define the type when you create a stream.</li> <li>• Transfer URL- The Transfer URL identifies where the Transfer Player will send the data. The TSBroadcaster uses these two URLs: <ul style="list-style-type: none"> <li>– http://dnscatm:8085 - This URL sends data to the DNCS.</li> <li>– http://localhost:8086/tsbroadcaser/transfer - This URL loops back to the TSBroadcaster for accepting XAIT and local outputs.</li> </ul> </li> <li>• OOB OC Address List - The list of broadcast IP address for each hub.</li> </ul> <p><b>Important:</b> You can use both a player and a transfer player, but we recommend that you always use a Transfer Player.</p>
Unbound Application	<p>An unbound application is an application that is not bound to program content. Unbound applications can be loaded regardless of which program is tuned.</p> <p>Unbound applications are signaled out-of-band (OOB) and carried using a Digital Storage Media – Command and Control (DSM-CC) object carousel for delivery on a QAM transport stream or QPSK or CMTS path.</p> <p>Some typical examples of unbound applications might be an electronic program guide navigator or an instant messaging application that lets viewers send instant messages to each other while watching television shows.</p>

## OCAP Object Carousel Acronyms and Terms, Continued

Term	Description
XAIT	The Extended Application Information Table (XAIT) is a signaling methods used for unbound applications. The Applications Information Table (AIT) method is used for signaling bound applications.
XTD File	An XTD file points to where the files are stored locally on the TSBroadcaster. The .xtd files are stored on the user's client computer. They contain information that allows users to re-create a "Develop Application" configuration so that they get back to where they left off. Users can see the settings by re-opening the file in the "Develop Application" screen, and they may subsequently modify the application content or associated signaling and re-save the .xtd file.

# Functional Overview

## How the TSBroadcaster Operates

The TSBroadcaster provides management, scheduling, and playout facilities for OCAP and Multimedia Home Platform (MHP) applications. The OCAP Object Carousel provides scheduled playout of the applications in fully formed Transport Streams that conform to OCAP standards. Optionally, you can inject local audio and video (A/V) content into the stream. The Transport Streams are played out through an ASI interface that may be connected directly to a modulator or fed into re-multiplexing equipment. The TSBroadcaster provides a user interface (UI) for Transport Stream definition.

The TSBroadcaster provides one or more digital storage media - command and control (DSM-CC) object carousels in each Transport Stream and it allocates a maximum bandwidth for each carousel. The TSBroadcaster allows multiple applications to share an object carousel, and it allows each application to run in its own sub-directory. The TSBroadcaster dynamically manages the allocation of bandwidth for each application in the carousel. This approach optimizes carousel bandwidth usage and provides a robust transmission scheme that simplifies the management of downstream re-multiplexing.

The TSBroadcaster provides a UI for “drag-and-drop” application construction and can be used with a wide range of application development environments, ranging from command-line compilers, through IDEs to specialized MHP and OCAP application development tools.

The TSBroadcaster provides facilities to update applications while they are being played out. The TSBroadcaster can poll and import data from the Internet to allow an application to receive updates automatically from FTP or Web sites, and it also provides a mechanism to update data in response to command driven updates. Updates can be applied to individual files, or whole directories can be updated in a single transaction. The TSBroadcaster provides a rapid update mechanism to minimize the latency of individual file updates, and it will automatically rebuild the carousel when it needs to change the carousel structure to accommodate updates. Changes in modules and the download information indication (DII) are tracked and their versions are incremented as required to signal updates efficiently.

The TSBroadcaster provides support for inserting “do it now” stream events and provides a UI through which stream events may be inserted with the required data.

You can deploy the TSBroadcaster in many different configurations to meet the requirements for distribution and resilience. You can use the TSBroadcaster to define the configuration that builds, updates, and delivers Transport Streams and out-of-band (OOB) components to the required interfaces. The TSBroadcaster also allows you to back up and restore configurations.

# Functional Overview, Continued

The TSBroadcaster provides password-protected user accounts that control access to the system and allows you to manage the event log and Transport Stream build records.

## How Much Data Can the TSBroadcaster Support?

The practical limits provided in this section revolve around the size of the content and the performance required at the limit. So the numbers that we provide are limits of practical performance rather than absolute limits. The limit in any real case will depend on its individual characteristics.

The available bandwidth, file size, CPU usage, and the required time to deliver a file all determine the number of carousels, applications, and modules that the TSBroadcaster can support.

### Number of Supported Streams

For a TSBroadcaster/TSPlayer on a single machine there is only a single ASI output, thus limiting the number of supported streams to 1. Additional TSPlayers are needed to increase the number of supported streams.

Out-of-band transport streams are generated automatically to hold a carousel marked as “out-of-band.” The TSBroadcaster supports a single out-of-band object carousel only, in accordance with the OCAP specification 22.2.2.1. A separate transport stream is used for inband data.

### Number of Supported Carousels

The TSBroadcaster typically supports less than 20 carousels per service and 50 carousels per stream.

### Number of Supported Applications

There is no limit to the number of applications defined in the TSBroadcaster, although the time taken to retrieve the model will increase with the overall size of the application content.

Currently, the TSBroadcaster supports less than 20 applications per service, 100 applications per stream, and applications as large as 10 MB. The size of the application that you can use depends on the capability of the receiver. The TSBroadcaster can support any acceptable file types that the application supports.

# Functional Overview, Continued

## Number of Supported Modules

The TSBroadcaster can signal approximately 130 modules in a single Download Information Indication (DII). Prior to TSBroadcaster 1.03, all carousels contained only a single DII. In TSBroadcaster 1.03 and beyond, you can define multiple DIIs to allow a larger number of modules. We do not provide recommendations beyond 250 supported modules.

You can identify the current number of modules by using the feature “Download Latest Build” and counting the module entries in the “stream-control” file. Future versions of the TSBroadcaster will contain an enhancement in this area.

## File Size Guidelines

There is no minimum file size for applications. The maximum size is limited by MHP specification at 254 sections (slightly more than 1 MB). Some non-compliant OCAP stream generators allow some non-compliant receivers to receive files that are greater than 1MB. There is a change request being raised to change the OCAP specification to allow files larger than 1MB with the correct signaling. A directory is limited to less than 512 entries.

## Set-Top Bit Rate Capacity

HD set-tops can support up to 19.4 Mbps, average, and the peak bit rates are allowed to spike up to the limit of the data channel (typically 38.811 Mbps).

## How To Enhance Performance

Performance depends on the behavior of the application, the available bit rate, the size of the application, the characteristics of the receiver, and the particular aspect of performance you are measuring.

You can enhance startup performance by separating content needed at application startup into a separate group and giving it a higher priority than other content. If an application contains class or uncompressed data files, compressing them may improve performance by reducing the size of the data to be broadcast. Compressing graphics files (assuming they have been properly optimized for broadcast) generally does not provide any significant compression and may be counter-productive as the receiver has to decompress the content when it receives the module. You should place content that can be compressed in groups with compression selected. Content that *cannot* be compressed should be placed in separate groups.

If an application cannot be entirely cached in receiver memory, then the performance may be improved by placing content that is required often or that is needed for startup into groups with increased priority. This setup will increase the frequency of this content at the expense of other content, and thus may improve performance by shortening the acquisition time of that content. However, the acquisition time of other content will be lengthened.

## Functional Overview, Continued

The service gateway (top-level directory), DII, and download server initiate (DSI) repetition periods may all be shortened, at the expense of repetition rate of the rest of the content. This setup may improve performance if the acquisition time of this content is a limiting factor. This time is controlled by a setting in the broadcaster properties file.

The carousel data may be broadcast in interleaved or non-interleaved modes, controlled by a setting in the broadcaster properties file. Non-interleaved broadcast generally produces less waiting time, but interleaved broadcast may result in faster acquisition by receivers that cannot handle the higher burst bit rates of non-interleaved mode.

Putting the modules of different applications on different DIIs may reduce the load on a receiver loading a particular application. This depends on whether the receiver loads the whole carousel or just selected DIIs.

Increasing bit rate will result in shorter acquisition times all round, with the caveat that if a receiver cannot handle the higher bit rate, it may have to re-try. The re-try could result in slower acquisition times.

Reducing the size of an application and its data will generally improve acquisition time and receiver memory management.

Improving the efficiency of the application coding will improve application performance. The acquisition time of an OCAP application is frequently many times shorter than the time the application takes to initialize and display the first screen. Consequently, tuning carousel delivery may often fail to have any significant effect on application startup time.

# The TSBroadcaster System View

## Introduction

The following illustration shows the interfaces and major components of TSBroadcaster. The components may be deployed on a single server or distributed across more than one server. The components are described in more detail later in this section.

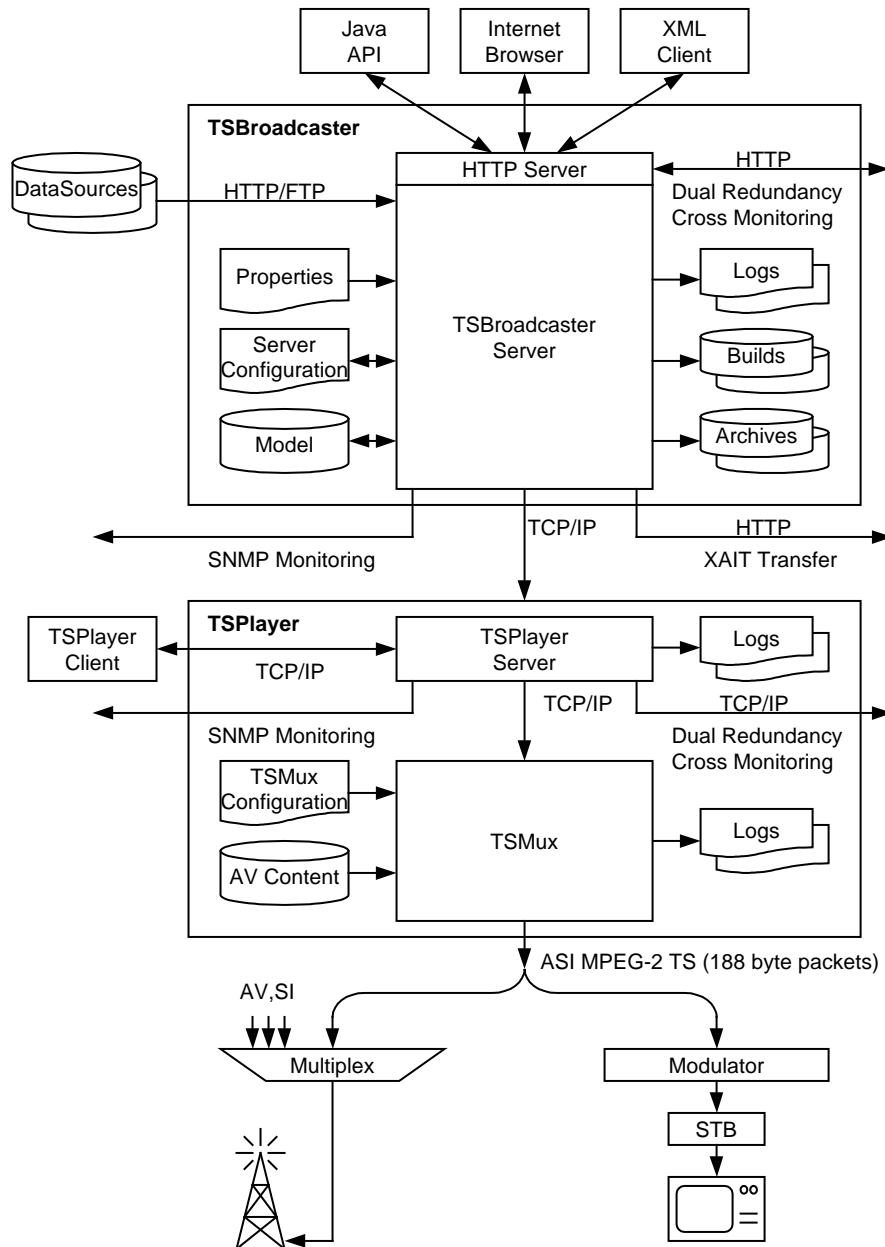

**The TSBroadcaster System**

# The TSBroadcaster System View, Continued

## TSBroadcaster Server

The TSBroadcaster Server component maintains a model that contains all the information needed to perform its function:

- Transport Stream definitions
- Applications to be played out
- Schedule for application playout
- Players allocated for Transport Streams
- Application update polling instructions
- User account information

The TSBroadcaster handles all transactions initiated by clients through the HTTP interface. The server may modify the model and its own configuration in response to the transactions.

The component launches processes to poll HTTP and FTP data sources to check for application data updates. The component includes a process that builds the Transport Stream and updates it in response to:

- Application playouts starting and stopping
- Updates to application data files
- Changes in the model

When a Transport Stream is built or updated, the new data is sent via TCP/IP to one or more TSPlayers that are nominated to play out the Transport Stream.

TSBroadcaster Servers may be configured to operate in dual-redundant mode with a partner, in which case they cross-monitor each other. The component maintains an event log and an archive of all the Transport Streams it has built.

## TSPlayer Server

The TSPlayer Server component plays out the Transport Stream built by the TSBroadcaster Server, incorporating updates as they become available. The component maintains an event log.

## TSMux

The TSMux component receives a continuous stream of data from the TSPlayer server and sends it out through an ASI interface. If directed, the TSMux will multiplex in locally stored A/V content. The component maintains an event log.

# Setting Up An Application to Play Out in a Stream

## Introduction

This section provides an overview of the process to use to set up an application to play out in a stream. Detailed procedures for each stage are covered in this document.

## Process Overview

The following process is an end-to-end example of setting up an application to play out in the stream.

**Note:** This process assumes that you have already set up the server and identified the time zone and users.

Stage	Description	See Page(s)
1.	Configure the client machines.	2-14
2.	Log in to the TSBroadcaster as a general purpose user.	3-3
3.	Create a stream or edit an existing stream.	3-15 and 3-18
4.	Create a service or edit an existing service.	3-22 and 3-26
5.	Create a carousel or edit an existing carousel.	3-32 and 3-35
6.	Create a transfer player or edit an existing transfer player.	4-7 and 4-9
7.	Add a scheduled playout or edit an existing scheduled playout.	6-9 and 6-15
8.	Confirm the bit rates for the playout.	6-21

# Chapter 2

## Setting Up the TSBroadcaster

### Introduction

To integrate the TSBroadcaster into the Digital Broadband Delivery System (DBDS), you must configure equipment and add the audio and video content. This chapter provides the procedures to properly set up the TSBroadcaster.

### In This Chapter

This chapter contains the following topics.

Topic	See Page
Configure the DNCS for the TSBroadcaster	2-2
Set Password and Time Zone	2-11
Shut Down the Server	2-13
Configure the TSBroadcaster Client Machines	2-14
Configure Delivery System Parameters	2-16
Add Audio and Video Content	2-17

# Configure the DNCS for the TSBroadcaster

## Introduction

To make the TSBroadcaster work in the Digital Broadband Delivery System (DBDS), you must configure the DNCS for the TSBroadcaster. This section provides the necessary steps for configuring the DNCS to work with the TSBroadcaster.

In this section, you will complete the following tasks:

- Configure an MPEG Source for the TSBroadcaster
- Configure a QAM for the TSBroadcaster
- Create a Session for the TSBroadcaster

## Before You Begin

To properly configure the DNCS to work with the TSBroadcaster, the following information must correlate on both systems:

- The DNCS source ID must match the TSBroadcaster OCAP source ID.
- The MPEG Program number on the DNCS must match the Service ID on the TSBroadcaster.

Work closely with your system integrators to make sure that you assign the correct information to both systems. Use the following table to record the information.

<b>DNCS Information</b>	<b>TSBroadcaster Information</b>
DNCS Source ID _____	OCAP Source ID _____
MPEG Program Number _____	Service ID _____

# Configure the DNCS for the TSBroadcaster, Continued

## Configure an MPEG Source for the TSBroadcaster

To configure an MPEG Source for the TSBroadcaster, complete the following steps.

1. On the DNCS Administrative Console, click the **DNCS** tab.
2. Click the **Element Provisioning** tab.
3. Click **MPEG Source**.

**Result:** The MPEG Source List window opens.

4. Click **File > New**. The Set Up MPEG Source window opens with the Basic Parameters tab in the forefront.
5. Click the **Headend Name** arrow and select the headend associated with this MPEG source.
6. In the **MPEG Source Name** field, type the name of this MPEG source (for example, **SATSB**). You can use up to 20 alphanumeric characters.

**Note:** You must create an MPEG source for each carousel and for each Audio and Video stream.

7. Will this MPEG source be providing VOD data?
  - If **yes**, click the **Device Type** arrow and select **Service Group Object**. If you do not see Service Group Object as an option, click in the Device Type field and type **Service Group Object**. Go to step 8.
  - If **no**, click the **Device Type** arrow and select the type of MPEG source you are adding (for example, IRT, MDR, and so forth). Go to step 8.
8. In the **IP Address** field, type the IP address for this MPEG source. Be careful to properly place the dots (.) between numbers.

**Example:** 10.10.20.30

9. In the **Physical Address** field, type the MAC address for this MPEG source.

**Example:** 02:02:02:02:02:02

10. Click **Apply**.

**Result:** The system saves the basic parameters for this MPEG source in the DNCS database. The previously disabled Connectivity tab becomes available.

11. On the **Set Up MPEG source** window, click the **Connectivity** tab.

**Result:** The Connectivity window opens with an illustration of any devices already connected to this MPEG source. (If no devices are yet connected, the illustration field will be empty.)

## Configure the DNCS for the TSBroadcaster, Continued

12. Click **Create Port**. The Port Number Prompt window opens.
13. In the **Port Number** field, type the number that identifies the output port on this MPEG source that is physically connected to the input port on the associated program QAM, MQAM, or GQAM modulator. Start with the first available port number.
14. In the **Transport Stream ID** field, type the number that identifies the transport stream going from this MPEG source to the associated program QAM, MQAM, or GQAM modulator.  
**Important:** You will need this number when you set up the QAM, MQAM, or GQAM modulator.
15. Click the **Transport Protocol** arrow and select **ASI** for the type of output card that is installed in this MPEG source.
16. Click **OK**.  
  
The system saves this information in the DNCS database and closes the Port Number Prompt window. The Connectivity tab updates with the new port and transport stream information. The Modify Port and Delete Port options become available.  
  
**Note:** When you set up the associated program QAM, MQAM, or GQAM modulator, the system will automatically complete the Connect To fields on this window.
17. Click **Apply**.  
  
**Result:** The system saves the MPEG source information in the DNCS database and updates the Connectivity illustration to include the new port information.
18. Click **Save**.  
  
**Result:** The system saves the MPEG source information in the DNCS database and closes the Set Up MPEG Source window. The MPEG Source List window updates to include the new MPEG source.
19. The next step is to Configure an MQAM for the TSBroadcaster. Go to **Configure an MQAM for the TSBroadcaster**, next in this section.

# Configure the DNCS for the TSBroadcaster, Continued

## Configure an MQAM for the TSBroadcaster

To configure an MQAM for the TSBroadcaster, complete the following steps.

**Note:** This procedure assumes you are using an MQAM. The steps for configuring a QAM or GQAM are nearly identical. For more detailed information on configuring a QAM or GQAM, refer the DNCS online help.

1. On the DNCS Administrative Console, click the **DNCS** tab.
2. Click the **Element Provisioning** tab.
3. Click **QAM**.

**Result:** The QAM List window opens.

4. Click **File > New > MQAM**.

**Result:** The Set Up MQAM window opens with the Basic Parameters tab in the forefront

5. Click the **Headend Name** arrow and select the headend in which this program MQAM modulator resides.
6. In the **QAM Name** field, type the name of this MQAM modulator. You can use up to 15 alphanumeric characters.

**Note:** Cisco recommends that you establish a naming scheme that allows you to easily identify the MQAM modulator and where it resides.

**Example:** A name of **VODhub1MQ43** could represent an MQAM modulator, whose IP address ends in 43, and that processes VOD data for Hub 1.

7. In the **IP Address** field, type the IP address for this MQAM modulator. Be careful to properly place the dots (.) between numbers.
8. In the **Physical Address** field, type the MAC address for this MQAM modulator.
9. In the **Subnet Mask** field, type the subnet mask where this MQAM modulator resides, based on the following guidelines:
  - If your system uses a standard network configuration, type **255.255.255.0**.
  - If your system uses another type of network configuration, type the subnet mask as assigned by your system administrator.

## Configure the DNCS for the TSBroadcaster, Continued

10. In the **Transport Stream ID** field in each **RF OUT** row, and type the number identifying the transport stream(s) carrying data from this MQAM modulator out to the hubs on your system.

**Note:** You must specify unique transport stream IDs for all four output ports on the MQAM modulator.

11. Click the **Modulation Type** arrow in each **RF OUT** row, and select 64-QAM for the modulation mode.
12. For each output port on this MQAM modulator, click in the **Channel Center Frequency (MHz)** field in each **RF OUT** row, and type the frequency of the channel you will use to send data from this MQAM modulator to the hubs on your system. Cisco recommends that you enter a value in 6 MHz increments from 91 to 867.
13. Click **Apply**.

**Result:** The system saves the MQAM modulator information you have entered thus far into the DNCS database.

14. On the **Set Up MQAM window**, click the **Advanced Parameters** tab.

**Result:** The Advanced Parameters window opens.

**Important:** The system inserts the **Configuration File Name** automatically. Do not change this field without first consulting Cisco Services. The system configuration file tells the MQAM modulator which version of software it should be running.

15. Define which hubs will receive program/service data from this MQAM modulator as follows:
  - To send data from this MQAM modulator to only specific hubs in the headend, select the hub name in the **Available Hubs** field, and then click **Add**. The hub name moves into the Selected Hubs field. Repeat this step for each hub you want to receive data from this MQAM modulator.
  - To send data from this MQAM modulator to all hubs in the headend, make sure no hubs appear in the Selected Hubs field.

**Note:** To remove a hub from the Selected Hubs field, select the hub name, and then click **Remove**. The hub name moves into the Available Hubs field.

## Configure the DNCS for the TSBroadcaster, Continued

16. Click **Apply**.  
**Result:** The system saves this information into the DNCS database. The previously disabled Connectivity tab becomes available.
17. On the **Set Up MQAM** window, click the **Connectivity** tab.  
**Result:** The Connectivity window opens with an illustration of the devices already connected to this MQAM modulator.
18. If not already selected, click to select the **Input 1 Port** option.
19. In the **Connect To** area, click the **Headend Name** arrow and select the headend that contains the MPEG source that is physically connected to the selected input port on this MQAM modulator.
20. Click the **Device Type** arrow and select the IRT type for the MPEG source device being used to send data to the selected input port on this MQAM modulator.
21. Click the **Device Name** arrow and select the name previously defined for the MPEG source associated with the selected input port on this MQAM modulator.  
**Example:** satsb
22. Click **Apply**.  
**Result:** The system saves this information into the DNCS database and updates the screen so that it shows the information you entered.
23. The next step is to create a session for the TSBroadcaster. Go to **Create a Session for the TSBroadcaster**, next in this section.

# Configure the DNCS for the TSBroadcaster, Continued

## Create a Session for the TSBroadcaster

To create a session for the TSBroadcaster, complete the following steps.

1. On the DNCS Administrative Console, click the DNCS tab.
2. Click the System Provisioning tab.
3. Click Source.

**Result:** The Source List window opens.

4. Click File > New.

**Result:** The Set Up Source window opens.

5. In the **Source Name** field, type the name that you will use to identify this source. You can use up to 20 alphanumeric characters.

**Example:** tsb01

**Note:** Cisco recommends that you use a naming scheme that indicates the source type (analog or digital), the channel number the service will use, and the service name. For example, a source name of **D02 WeatherScan** indicates that this is a digital source (**D**) providing content on channel 2 (**02**) for the WeatherScan service.

6. In the **Source ID** field, type the number you will use to identify this source. Typically, the source ID is 1000 plus the number of the channel offering the service. For example, the source ID for a service appearing on channel 2 would be **1002**. You can use up to 5 numeric characters.

**Important:**

- You must use a number that is greater than 200 for the source ID. Source ID numbers 1 through 200 are reserved for system-built service sources.
- Remember the service source ID. You will need it as you continue to set up the service. This source ID must match the OCAP Source ID in the TSBroadcaster.

7. Click **Save**.

**Result:** The system saves the service source information in the DNCS database and closes the Set Up Source window. The Source List window updates to include the new service source.

8. In the Source List window, highlight the source you defined in step 5.

**Example:** tsb01

## Configure the DNCS for the TSBroadcaster, Continued

9. Click **File > Source Definitions**.  
**Result:** The Source Definition window opens.
10. Click **File > New Digital**.  
**Result:** The Digital Source Set Up window opens.
11. Click in the first **Session ID** field and type 12 zeros.  
**Note:** The system inputs the colons for you.
12. Click in the second **Session ID** field and type the Service Source ID you used when you added the source in step 6.
13. Click **Next**.  
**Result:** The Define Session window opens.
14. Because this source will be providing broadcast (audio/video) programming rather than system information, click the **Broadcast programming** option.
15. Click **Next**.  
**Result:** The Session Setup window opens.
16. Click the **Input Device** arrow and select the type of device (the MPEG source) that will be providing the service content (for example, an MDR or IRT).  
**Example:** satsb
17. In the **MPEG Program Number** field and type the program number being fed into the transport stream.  
**Important:** The service ID on the TSBroadcaster and the MPEG Program Number must match the program number supplied by the content provider. For the carousel, this number must match only the service ID in the TSBroadcaster.
18. In the **Bandwidth** field and type **2**.
19. Click **Next**.  
**Result:** The Output Selection Policy window opens.

## Configure the DNCS for the TSBroadcaster, Continued

20. Click the **Select Outputs from list** option.

**Result:** A list of QAMs appears.

21. Select the QAM with the Output TS ID that you want to use.

22. Click **Next**.

**Result:** The Save Source Definition window opens.

23. Click **Save**.

**Result:** The system saves the source definition in the DNCS database, and starts the session you built for it. The Source Definition List window updates to include the new source information.

# Set Password and Time Zone

## Introduction

This section provides the information for setting the password and time zone for the TSBroadcaster.

## Assumptions

The information provided in this section assumes that the initial installation and configuration steps of the server have already been performed.

## Set the sandt User Password

The TSBroadcaster provides an **sandt** account on the operating system to allow you to manage the installation without using the **root** account.

**Note:** The default account for the TSBroadcaster is sandt.

To set the sandt user password, complete the following steps.

1. At the **Username:** prompt, log in as **root**.
2. At the password prompt, type the password that was used during the installation of the TSBroadcaster or that you set during configuration.
3. At the **#** prompt, type **passwd sandt**.
4. When prompted, type the password that you have selected and type it again to confirm it.
5. Type **exit** to log out.

## Set the TSBroadcaster Time Zone

To set the time zone for the TSBroadcaster, complete the following steps.

1. At the **Username:** prompt, log in as **sandt**.
  2. At the password prompt, type the password that you specified in **Set the sandt User Password**.
- Result:** The command prompt appears.
3. To find an appropriate time zone for the TSBroadcaster to operate in, type the following command at the command prompt:

```
cd /sandt/java/jre/lib/zi
```

**Result:** The initial hierarchy of continents or areas is displayed.

4. Use the **cd** command to navigate to the continent or area that contains the time zone in which you will be operating the TSBroadcaster.

**Note:** The time zones for each continent or area are found in subdirectories.

## Set Password and Time Zone, Continued

5. Make note of the continent and time zone combination in which you will be operating the TSBroadcaster. For example `America/New_York`.
6. Edit the following file to change the value of `system.timeZone` to the value you noted in step 5 and save the edit:  
  
`/media1/tsbroadcaster/broadcaster.properties`
7. Type **exit** to log out.

# Shut Down the Server

## Shutting Down the Server

To shut down the server, complete the following steps.

**Important:** Always use this method to shut down the server before powering it down; otherwise, the disks can be corrupted.

1. At the **Username:** prompt, log in as **root**.
2. At the password prompt, type the password that you specified during configuration.
3. At the # prompt, type **shutdown -I 6 -g0 -y**.

**Note:** As an alternate method to shutting down the server, you can press the Power button behind the front cover once, briefly. This method will also initiate a controlled shutdown.

**Result:** When the machine is safely shut down, it can be physically powered off.

# Configure the TSBroadcaster Client Machines

## Introduction

This section provides the requirements and instructions for configuring the TSBroadcaster client machines.

## Client Machine Requirements

The TSBroadcaster client machines must meet the following specifications:

- Launch an Internet browser that is running Java 1.4.2 to support the launching of Java applets.

**Note:** The TSBroadcaster has been tested with Netscape, Microsoft Internet Explorer, and Mozilla.

- Provide sufficient disk space to install at least the Java 1.4.2 JRE. Contact Sun Microsystems for the appropriate ranges.
- Provide sufficient memory and processor power to run Java applets with acceptable performance. Contact Sun Microsystems for the appropriate ranges.

## Install Java 1.4.2

Each client machine must have an Internet browser that is running Java 1.4.2 to support the launching of Java applets that form part of the TSBroadcaster UI. Obtain a Java 1.4.2 SDK or JRE installer for the operating system of your client machine. Installers for various operating systems are available on the Internet, at the following location:

<http://java.sun.com/j2se/>

Install the Java SDK or JRE on each client machine (this will require Service Pack 2 or higher on Windows 2000 computers). If you have no requirement for Java on the machine except to run the TSBroadcaster client, select the JRE, as it is smaller and quicker to install. Ensure that the Java you are installing is selected as the default JRE or SDK for the browser that you intend to use to access TSBroadcaster.

# Configure the TSBroadcaster Client Machines, Continued

## Set Up Java Policy Files

Each client needs a Java policy file to allow the application development applet to access the client file system.

To set up a Java policy file on each client, complete the following steps.

1. Create a **.java.policy** on each client and insert the text below, replacing **<address>** with the actual address of the machine on which the TSBroadcaster is installed:

```
grant codeBase "http://<address>:8080/-" {  
    permission java.security.AllPermission;  
};
```

2. If a client is to access more than one TSBroadcaster server, repeat step 1 for each machine, inserting the appropriate address each time.
3. Copy the policy file to the home directory of each user on the client machine as follows:
  - For **users** on a standard Windows 2000 client machine, type this directory path:

```
C:\Documents And Settings\<user>\.java.policy
```

- For **DNCS users** on a Sun machine, type this directory path:

```
export/home/dncs
```

## Setting Up ASI Output

By default, the TSBroadcaster produces a full transport stream and outputs the transport stream as packet mode ASI stream. This output will provide a signal that can be passed to many common modulators and received directly by OCAP receivers.

To alter the characteristics of the ASI stream or filter elementary streams out for delivery to multiplex systems, see **Configure ASI Output** in Chapter 10 of this guide.

# Configure Delivery System Parameters

## Introduction

This section provides instructions for configuring the delivery system parameters.

## Configure OCAP Delivery System Parameters

By default, TSBroadcasters for OCAP systems are configured for modulation with the following parameters.

<b>Frequency</b>	699 MHz
<b>Modulation Mode</b>	SCTE Mode 1 (64 QAM)

If your receiver relies on inband SI from the TSBroadcaster for tuning, configure the modulator and receiver to use these settings and tune your receiver.

If your receiver relies on out-of-band (OOB) SI from a headend system for tuning or you cannot use the settings above, you need to change the TSBroadcaster settings. You will need to ensure that transport stream and service parameters are consistent between the TSBroadcaster and the transmission system (which may be re-multiplexing and re-mapping the inband transport stream from TSBroadcaster). To do this through the TSBroadcaster client UI, see Chapter 3, **Using the TSBroadcaster**, for instructions on **Create an OCAP Stream** and on **Create an OCAP Service**. When you have entered parameters that are consistent with the headend settings, tune your receiver.

When you tune your receiver, you should find a single transport stream containing two services. If you cannot find a signal when you tune your receiver, see **Cannot Tune to Stream** in Chapter 11, **Troubleshooting**.

# Add Audio and Video Content

## Adding Audio and Video Content

The TSBroadcaster is provided with sample A/V content to provide A/V for development, testing, and demonstration. By default, the services defined within the TSBroadcaster reference this A/V content.

For OCAP systems, the TSBroadcaster is not supplied with NTSC A/V content by default, although it is set up to use “show reel content” supplied by Starz. TSBroadcaster currently provides signaling for two sets of A/V content, called **FindingNemo** and **LostInTranslation**. To use this content, you must request and receive permission from Starz.

To change the A/V content, see **Chapter 3, Using the TSBroadcaster**.

# Chapter 3

## Using the TSBroadcaster

### Introduction

This chapter provides the information you need to log in and out of the TSBroadcaster and information to help you become familiar with the user interface. Procedures are also provided for creating and modifying OCAP streams, services, and carousels. This chapter also provides procedures for adding and editing audio and video content.

### In This Chapter

This chapter contains the following topics.

Topic	See Page
Log In to the TSBroadcaster	3-3
Get to Know the TSBroadcaster User Interface	3-6
Stream Management	3-14
Create an OCAP Stream	3-15
Edit the OCAP Stream	3-18
Create an OCAP Service	3-22
Edit an OCAP Service	3-26
Delete a Stream	3-29
Delete a Service	3-30
Create a Carousel	3-32
Edit a Carousel	3-35
Delete a Carousel	3-38
Configure the Stream Event Channel	3-40

## Overview, Continued

Topic	See Page
Clear a Stream Event Channel	3-43
Create A/V Content	3-45
Edit A/V Content	3-48
Delete A/V Content	3-51
Create an A/V Content Component	3-53
Edit an A/V Content Component	3-56
Delete an A/V Content Component	3-59
Log Out of the TSBroadcaster	3-62

# Log In to the TSBroadcaster

## Introduction

This section provides information about the user accounts that are created when the TSBroadcaster is installed and provides instructions for logging in to the TSBroadcaster through a Java-enabled Internet browser. For instructions on creating, editing, and deleting user accounts, see Chapter 10, **TSBroadcaster Administration**.

## User Accounts and Login

The TSBroadcaster provides secure access to its functions through user accounts. A user account is associated with a user name and a password and has a number of privileges and permissions that determine what access the user has to the system functions. The TSBroadcaster user accounts are completely separate from and independent of the operating system user accounts.

The TSBroadcaster is shipped with two default user accounts.

<b>Username</b>	<b>Password</b>	<b>Description</b>
admin	admin	A user account provided solely for user account administration
demo	demo	A general purpose user account with privileges for everything except user account administration

# Log In to the TSBroadcaster, Continued

## Logging In to the TSBroadcaster Through an Internet Browser

To log in to the TSBroadcaster through an Internet browser, complete the following steps.

1. Launch a Java-enabled Internet browser.
2. Type the following URL into the browser address bar:

http://address:8080/tsbroadcaster

For the address, use the IP address of the TSBroadcaster server.

**Result:** The TSBroadcaster will redirect you to the Login Page.

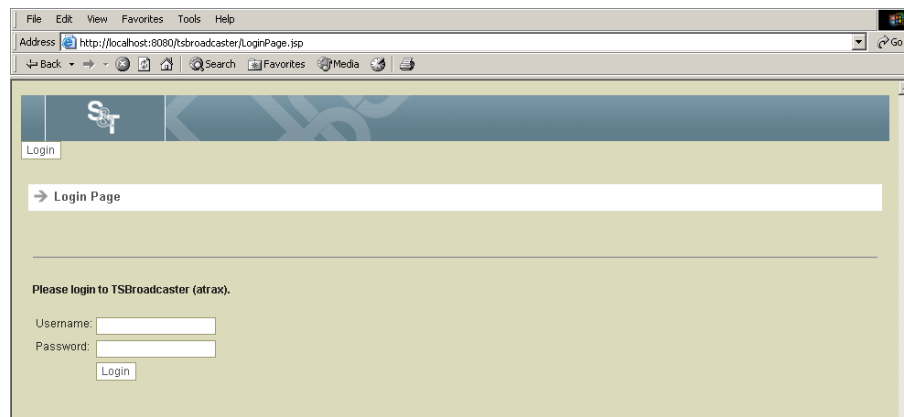

3. Did the Login Page appear?
  - If **yes**, go to step 4.
  - If **no** or you cannot make a connection at all, see **Chapter 11, Troubleshooting**.
4. At the **Username** field, type your user name.
5. At the **Password** field, type your password.

# Log In to the TSBroadcaster, Continued

6. Click **Login**.

**Result:** After a successful login, the TSBroadcaster displays the Home Page. This page shows the version you are currently using and the functions available to the user. A summary snapshot of the streams and outputs set up on the system are also shown.

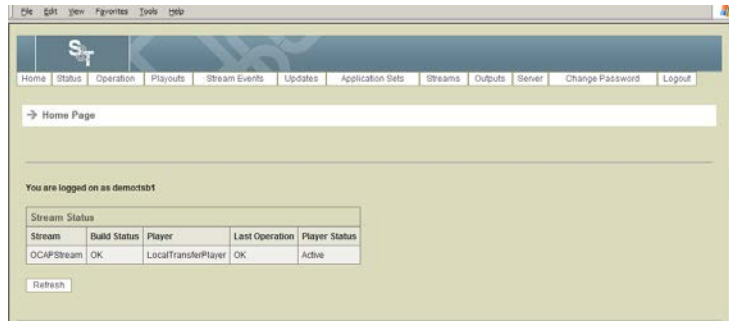

7. Verify that you are using the correct version of TSBroadcaster. Look at the bottom of the Home Page to identify the version you are using.

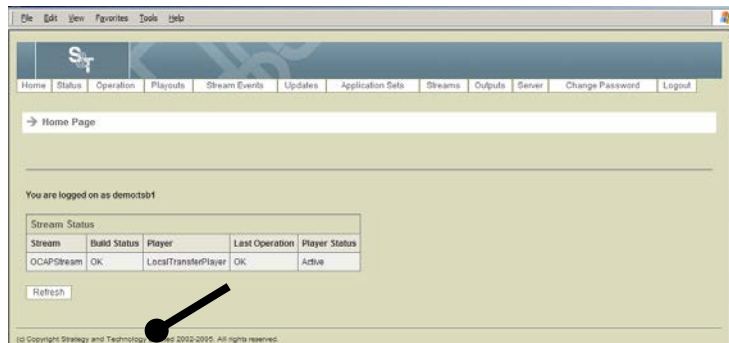

# Get to Know the TSBroadcaster User Interface

## Introduction

After you log in to the TSBroadcaster for the first time, you should take a few minutes to become familiar with the TSBroadcaster user interface. This section describes the page layout and navigation of the TSBroadcaster screens. Information about each screen in the user interface is also provided.

## Page Layout

The TSBroadcaster provides a page-based user interface with a standard layout that is broken down into the following areas.

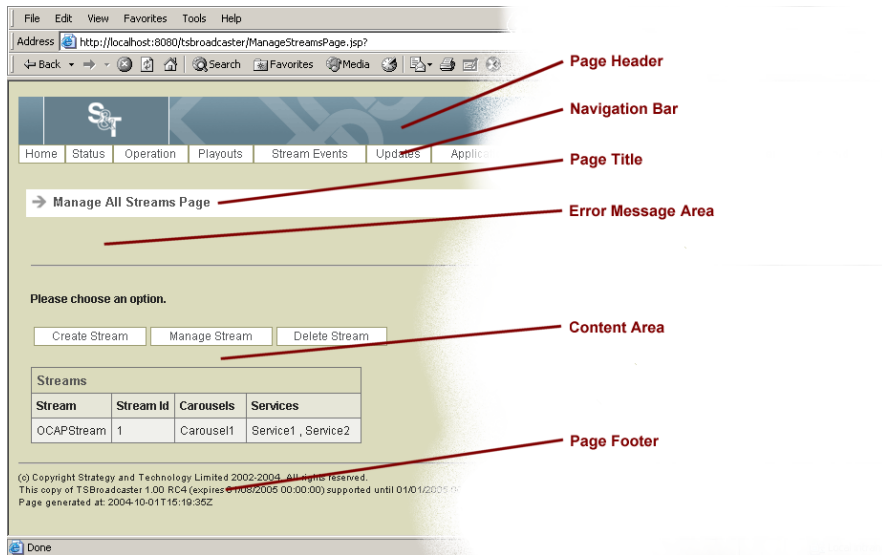

## Get to Know the TSBroadcaster User Interface, Continued

Refer to the following table for a description of each area on the TSBroadcaster screens.

Area	Description
<b>Page header</b>	The top of the page contains standard branding to indicate that you are within the TSBroadcaster UI.
<b>Navigation bar</b>	The navigation bar contains a set of buttons that allow you to navigate rapidly between the different functional areas of TSBroadcaster. The buttons presented in this area are tailored to the privileges of the TSBroadcaster user that is logged in.
<b>Page title</b>	The title of the page is displayed here to clearly identify where you are in the UI.
<b>Error message area</b>	This area is used to display an error message if the TSBroadcaster detects an error in a command or data entry.
<b>Content area</b>	This area displays the data related to the page and the associated commands. This area may contain tabular data, buttons, input forms, selection forms, or Java applets.
<b>Page footer</b>	The bottom of the page contains the information about the TSBroadcaster version, license information, and the time at which the page was generated.

# Get to Know the TSBroadcaster User Interface, Continued

## Selection Pages

At many points within the TSBroadcaster UI, you are requested to select an item on which to perform an operation, such as displaying, editing, or deleting the item. Because this is a common step, the UI for the TSBroadcaster provides a standard page format for performing these operations. The page contains a single drop-down selection box allowing you to select the item, and a button to perform the operation on the selected item. To exit a selection page without operation, press the back button of the Internet Browser or select a button from the TSBroadcaster navigation bar.

A typical TSBroadcaster selection page is shown below.

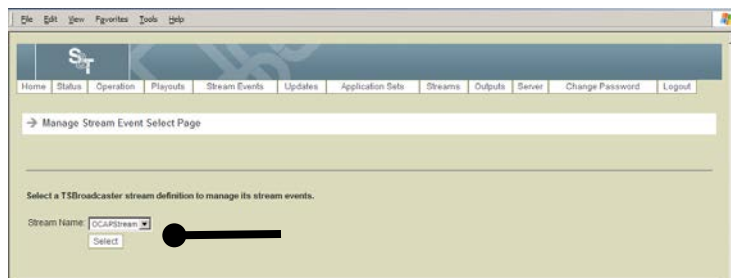

# Get to Know the TSBroadcaster User Interface, Continued

## Data Entry Pages

At many points within the TSBroadcaster UI, you are requested to create or edit an item by entering data on a form. Because this is a common step, the TSBroadcaster provides a standard page format for it. The page contains a form with data entry fields for all the information that you have to provide, and a button to save the newly created or edited item. To exit a data entry page without entering any data, press the back button of the Internet Browser or select a button from the TSBroadcaster navigation bar.

A typical TSBroadcaster data entry page is shown below.

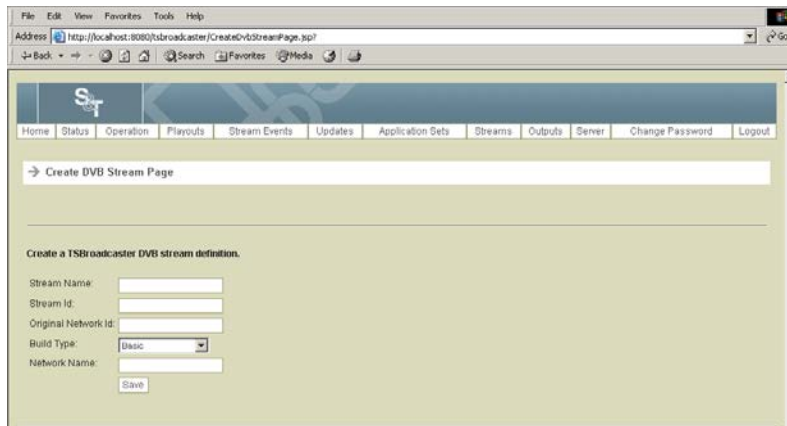

The TSBroadcaster provides the following types of fields for data entry.

Field	Description
<b>Read only</b>	Provides contextual information for the create or edit operation
<b>Text field</b>	Allows the entry of a single line of text, normally a name, number, or a timestamp
<b>Text box</b>	Allows the entry of multiple lines of descriptive text
<b>Selection</b>	Allows the entry of one of a number of alternatives. Wherever possible, the TSBroadcaster uses selection fields for selection from a constrained list of values
<b>Check box</b>	Allows the entry of a Boolean value
<b>File field</b>	Allows the selection of a file path from the client file system, either by typing in the path or by browsing to the appropriate path using a file dialog

*Continued on next page*

# Get to Know the TSBroadcaster User Interface, Continued

## Data Types

The TSBroadcaster supports input of a variety of data types through the UI. Wherever possible, data types that consist of a constrained list of values are entered using selection fields to minimize the risk of error.

You may enter data, however, using a number of different formats as shown in the following table.

Data Type	Description
<b>Names</b>	<p>Enter names using upper-, lower-, or mixed-case alphanumeric characters, including non-western alphanumerics, and the underscore character (“_”)</p> <p>Name fields are composed of an alphabetic character followed by zero or more alphanumeric characters or underscores. The software uses Java functions to check characters for validity to allow for non-ASCII characters, but it is recommended that names are restricted to the characters A-Z, a-z, 0-9 and “_” (the permitted characters from the ASCII character set).</p>
<b>Integer numbers</b>	<p>Enter integer numbers as either decimal numbers or unsigned hexadecimal numbers with a leading zero (“0x”) or (“0X”).</p>
<b>Floating point numbers</b>	<p>Enter floating point numbers as signed or unsigned decimal numbers, with or without an embedded decimal point, and with or without a signed exponent designated by “E” or “e.”</p> <p>The term <i>floating point</i> means that there is no fixed number of digits before and after the decimal point; that is, the decimal point can float. A floating point number is a real number that can contain a fractional part. The following are floating-point numbers:</p> <ul style="list-style-type: none"><li>• 3.0</li><li>• -111.5</li><li>• ½</li><li>• 3E-5</li></ul> <p>The last example is a computer shorthand for scientific notation. It means 3*10<sup>-5</sup> (or 10 to the negative 5th power multiplied by 3).</p>

## Get to Know the TSBroadcaster User Interface, Continued

Data Type	Description
<b>Timestamps</b>	<p>Enter timestamps in ISO 8601 format, yyyy-MM-dd HH-mm-ss, with an optional “T” instead of the space between the date and time. Timestamps are interpreted in the default time zone of the TSBroadcaster or as the Coordinated Universal Time (UTC) if a “Z” is appended.</p> <p><b>Examples:</b></p> <p>2005-09-10 17:15:00 - This timestamp indicates quarter past five in the afternoon on the tenth of September 2005 in the TSBroadcaster default time zone (with daylight saving if applicable).</p> <p>2005-10-31T01:30:00Z - This timestamp indicates half-past one in the morning on the thirty-first of October 2005 in the UTC time zone.</p>
<b>Durations</b>	<p>Enter Playout durations in hours, minutes, and seconds using the format hh:mm:ss. Short durations may be entered as a floating point number.</p> <p><b>Note:</b> You can accurately and conveniently specify times for scheduling applications by clicking and dragging on a time chart as described in <b>View Scheduled Playouts</b> in Chapter 6.</p>

# Get to Know the TSBroadcaster User Interface, Continued

## Error Messages

When the TSBroadcaster detects an error in a command or data entry, it displays an error message in the error message display area, and also, if appropriate, highlights the legend of the field in error. If the TSBroadcaster displays an error, you can modify the data and try again; abandon the operation by pressing the back button of the Internet Browser; or select a button from the TSBroadcaster navigation bar.

A typical TSBroadcaster error message display is shown below.

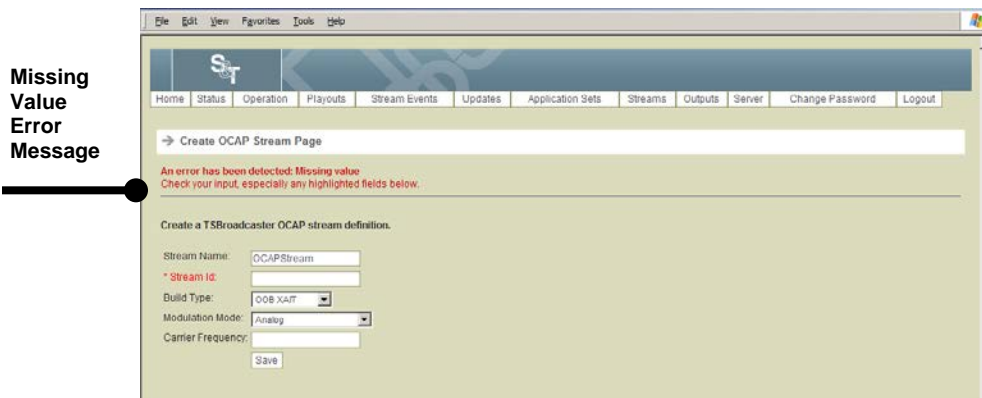

The TSBroadcaster provides the following error messages.

Error Messages	Description
<b>Duplicate value</b>	Attempt to create a second example of something that must be unique
<b>Invalid value</b>	Attempt to enter a value that is out of range
<b>Missing value</b>	Attempt to omit a value that must be present
<b>Not found</b>	Attempt to select something that does not exist at this time
<b>Missing element</b>	An XML file omits an element that is must be present
<b>Invalid element</b>	An XML file has an element that is not recognized
<b>Invalid outer element</b>	An XML file has an outer element that is not recognized

## Get to Know the TSBroadcaster User Interface, Continued

Error Messages	Description
<b>Missing attribute</b>	An XML file omits an attribute that must be present
<b>Invalid attribute</b>	An XML file has an attribute that is not recognized
<b>No privilege</b>	Attempt to perform an operation without the appropriate privilege
<b>Not logged in</b>	Attempt to perform an operation without being logged in
<b>Already logged in</b>	Attempt to log in when already logged in
<b>Invalid password</b>	Attempt to log in with invalid password
<b>Format error</b>	Attempt to enter incorrectly formatted data
<b>Invalid operation</b>	Attempt to perform an operation that does not exist
<b>Operation failed</b>	Attempt to perform an operation that has failed (the log may contain more specific information)
<b>In use</b>	Attempt to delete an object that is being used
<b>Open failed</b>	Attempt to open a file failed
<b>Save failed</b>	Attempt to save a file failed
<b>Invalid state</b>	Attempt to perform an operation that TSBroadcaster cannot perform in its current state
<b>Not available</b>	Attempt to obtain a resource that is not available
<b>HTTP error</b>	HTTP error detected
<b>Unknown error</b>	Unknown error detected

# Stream Management

## Introduction

You can use the TSBroadcaster to set up and manage Transport Stream definitions. A Transport Stream definition determines the structure and content of the Transport Streams generated by the TSBroadcaster.

## Components of the Transport Stream

A Transport Stream generated by the TSBroadcaster is an MPEG Transport Stream that contains the following components:

- One Program Allocation Table (PAT) - the PAT references the PMT of each service
- One Program Map Table (PMT) per program/service - the PMT references
- The object carousels allocated to the service
- The AIT for the service
- The elementary stream defined by the stream event channel
- The components of the AV content selected for the service
- One Application Information Table (AIT) per program/service
- Zero or more DSM-CC Object Carousels
- Optional elementary Stream to carry DSM-CC Stream Events
- AV content - The AV content defines the characteristics of the audio and video components multiplexed into the transport stream, thus allowing them to be referenced from PMTs

## Transport Stream Modifications

When you modify a Transport Stream, the TSBroadcaster immediately regenerates the Transport Stream to match the new definition. The version numbers of the tables in the Transport Stream are automatically incremented to reflect the changes.

The TSBroadcaster needs specific OCAP information about the Transport Stream and the services carried in it to be able to produce the OCAP tables. The TSBroadcaster provides a specific interface for stream and service management for OCAP.

**Important:** You must have **ManageStreams** privileges to modify a transport stream.

# Create an OCAP Stream

## Creating an OCAP Stream

To create an OCAP stream, complete the following steps.

**Important:** When creating or editing a stream that will be re-multiplexed for onward transmission, the data entered in the TSBroadcaster must match the configuration expected in the multiplexing equipment.

1. Log in to the TSBroadcaster as a user with the appropriate privileges. See **Log In to the TSBroadcaster**, earlier in this chapter.

**Result:** After a successful login, the Home Page opens.

2. Click the **Streams** button from the navigation bar.

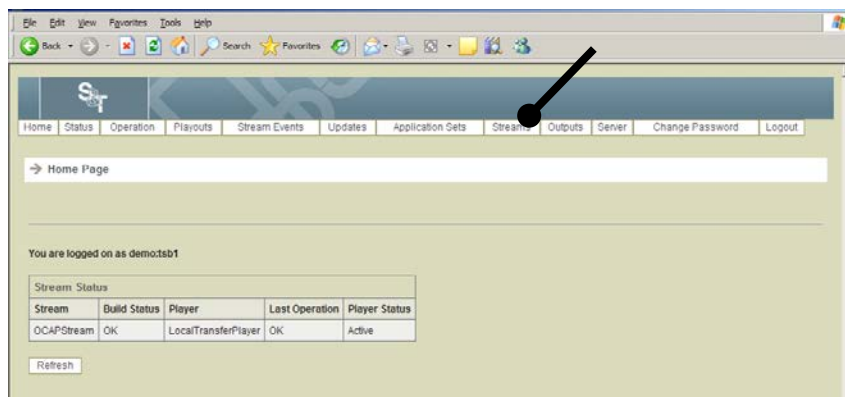

**Result:** The TSBroadcaster displays the Manage All Streams page.

## Create an OCAP Stream, Continued

3. Click the **Create Stream** button on the Manage All Streams Page.

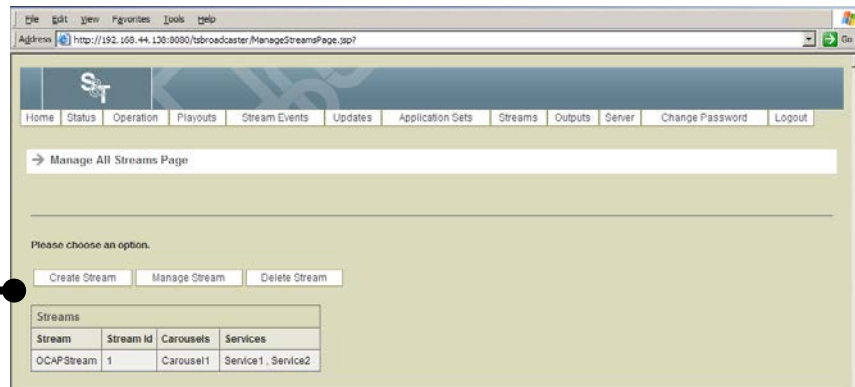

**Result:** The Create OCAP Stream Page opens.

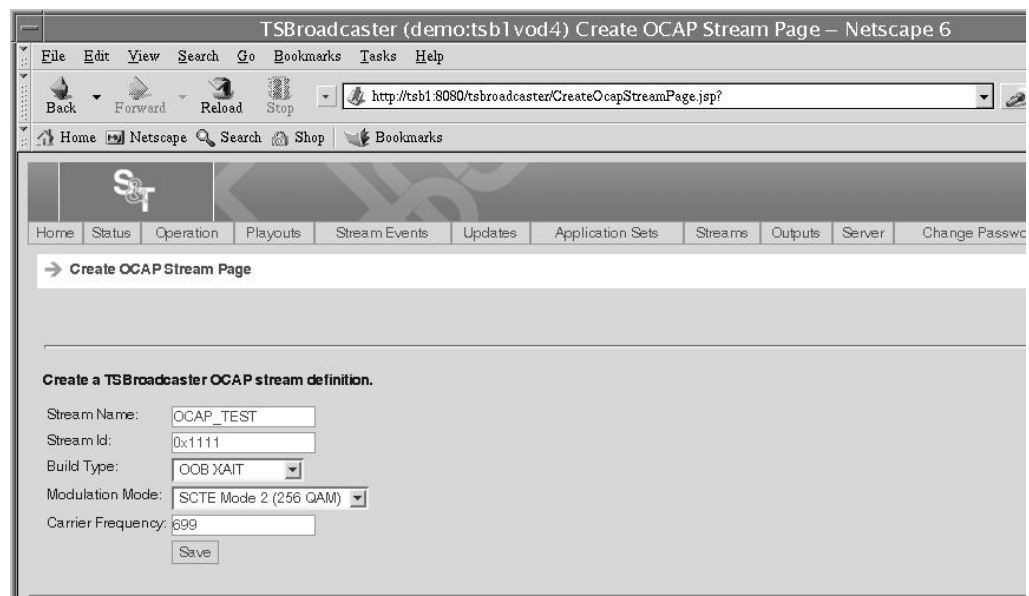

## Create an OCAP Stream, Continued

4. Enter the following data on the Create OCAP Stream Page.

<b>Stream Name</b>	The name used by the TSBroadcaster to refer to the new Transport Stream definition												
<b>Stream ID</b>	The Transport Stream ID that is a unique value to identify the stream												
<b>Build Type</b>	<p>The type of OCAP-specific tables for each build type that should be generated in the Transport Stream.</p> <table border="1"> <thead> <tr> <th>Build Type</th> <th>Table Type</th> </tr> </thead> <tbody> <tr> <td>OOB XAIT</td> <td>XAIT</td> </tr> <tr> <td>IB SI</td> <td>MGT, LVCT, STT</td> </tr> <tr> <td>IB SI AND XAIT</td> <td>MGT, LVCT, STT, XAIT</td> </tr> <tr> <td>IB SI NOT STT</td> <td>MGT, LVCT</td> </tr> <tr> <td>NO SI NO XAIT</td> <td>None</td> </tr> </tbody> </table>	Build Type	Table Type	OOB XAIT	XAIT	IB SI	MGT, LVCT, STT	IB SI AND XAIT	MGT, LVCT, STT, XAIT	IB SI NOT STT	MGT, LVCT	NO SI NO XAIT	None
Build Type	Table Type												
OOB XAIT	XAIT												
IB SI	MGT, LVCT, STT												
IB SI AND XAIT	MGT, LVCT, STT, XAIT												
IB SI NOT STT	MGT, LVCT												
NO SI NO XAIT	None												
<b>CDS Reference</b>	Text field not used in this version (set to "1")												
<b>MMS Reference</b>	Text field not used in this version (set to "1")												
<b>Modulation Mode</b>	<p>The modulation mode of the Transport Stream can be one of the following:</p> <ul style="list-style-type: none"> <li>• Analog</li> <li>• SCTE Mode 1 (64-QAM)</li> <li>• SCTE Mode 2 (256-QAM)</li> <li>• ATSC (8-VSB)</li> <li>• ATSC (16-VSB)</li> </ul>												
<b>Carrier Frequency</b>	Text field indicating the carrier frequency (Hz) of the Transport Stream												
<b>Transport Type</b>	Checkbox not used in this version (leave unchecked)												
<b>Path Select</b>	Checkbox not used in this version (leave unchecked)												
<b>Out Of Band</b>	Checkbox not used in this version (leave unchecked)												

5. Click the **Save** button to create a new OCAP Transport Stream definition.

# Edit the OCAP Stream

## Editing the OCAP Stream

To edit the OCAP stream, complete the following steps.

1. Log in to the TSBroadcaster as a user with the appropriate privileges. See **Log In to the TSBroadcaster**, earlier in this chapter.

**Result:** After a successful login, the Home Page opens.

2. Click the **Streams** button from the navigation bar.

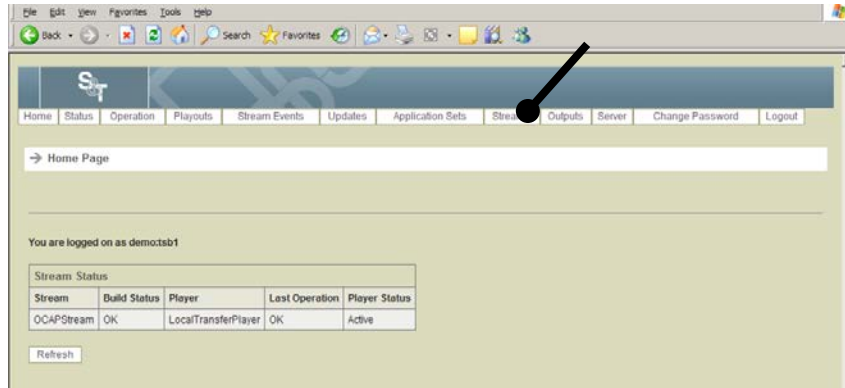

**Result:** The Manage All Streams Page opens.

3. Click the **Manage Stream** button on the **Manage All Streams** Page.

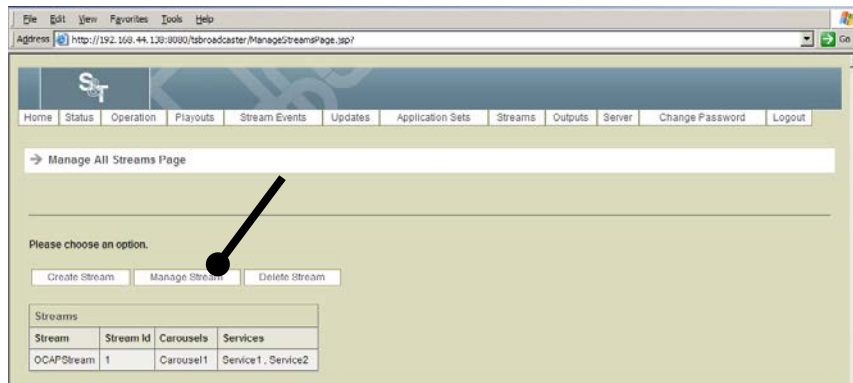

**Result:** The Manage Stream Select Page opens.

## Edit the OCAP Stream, Continued

4. Select the stream from the drop-down list that you want to edit and click **Select**.

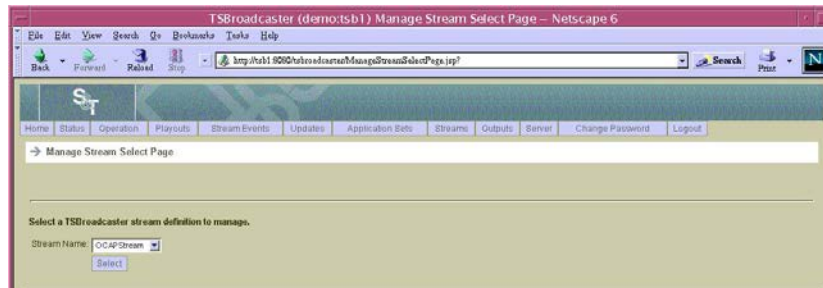

**Result:** The Manage OCAP Stream Page opens.

# Edit the OCAP Stream, Continued

- Click the **Edit Stream** button on the Manage OCAP Stream Page.

The screenshot shows a web browser window displaying the 'Manage OCAP Stream Page'. The browser address bar shows 'http://localhost:8080/tsbroadcaster/ManageStreamPage.jsp'. The page has a navigation menu with items like Home, Status, Operation, Playouts, Stream Events, Updates, Application Sets, Streams, Outputs, Server, Change Password, and Logout. Below the menu is a breadcrumb trail: 'Manage OCAP Stream Page'. The main content area is titled 'Manage TSBroadcaster stream OCAPStream.' and features an 'Edit Stream' button. Below this are several tables and sections:

Stream Id	Build Type	CDS Reference	MMS Reference	Modulation	Carrier Frequency	Transport Type	Path Select	Out Of Band
1	IB SI AND XAIT	1	1	SCTE Mode 1 (64 QAM)	699000000			

Below the table are buttons for 'Configure Stream Event Channel' and 'Clear Stream Event Channel'. The 'Stream Event Channel' section contains a table:

PID	Assoc. Tag	Prog. Assoc. Tag
0x401	41	42

Buttons for 'Create Carousel', 'Edit Carousel', and 'Delete Carousel' are present. The 'Carousels' section contains a table:

Name	Id	PID	Assoc. Tag	bits/sec
Carousel1	1	0x101	11	10000000

Buttons for 'Create Service', 'Edit Service', and 'Delete Service' are present. The 'Services' section contains a table:

Name	Title	Content	Service Id	PMT PID	AIT PID	AIT Assoc. Tag	OCAP Source Id	OCAP Service Type	Major/Minor Channel	Scr.	Hide	Hide Guide	Included Carousels
Service1	Serv1	FindingNemo	1	0x201	0x301	31	0x1	ATSC Digital TV	100:101	no	no	no	Carousel1
Service2	Serv2	LostInTranslation	2	0x202	0x302	32	0x2	ATSC Digital TV	100:102	no	no	no	Carousel1

Buttons for 'Create Content', 'Edit Content', and 'Delete Content' are present. The 'Content' section contains a table:

Name	PCR PID	Component PIDs
FindingNemo	0x601	0x501, 0x601
LostInTranslation	0x602	0x502, 0x602
fred	0x40	

**Result:** The Edit OCAP Stream Page opens.

## Edit the OCAP Stream, Continued

6. To change the attributes of a stream, enter the following data on the Edit OCAP Stream Page.

<b>Stream Name</b>	The name used by the TSBroadcaster to refer to the new Transport Stream definition												
<b>Stream ID</b>	The Transport Stream ID that is a unique value to identify the stream												
<b>Build Type</b>	<p>The type of OCAP-specific tables for each build type that should be generated in the Transport Stream.</p> <table border="1"> <thead> <tr> <th>Build Type</th> <th>Table Type</th> </tr> </thead> <tbody> <tr> <td>OOB XAIT</td> <td>XAIT</td> </tr> <tr> <td>IB SI</td> <td>MGT, LVCT, STT</td> </tr> <tr> <td>IB SI AND XAIT</td> <td>MGT, LVCT, STT, XAIT</td> </tr> <tr> <td>IB SI NOT STT</td> <td>MGT, LVCT</td> </tr> <tr> <td>NO SI NO XAIT</td> <td>None</td> </tr> </tbody> </table>	Build Type	Table Type	OOB XAIT	XAIT	IB SI	MGT, LVCT, STT	IB SI AND XAIT	MGT, LVCT, STT, XAIT	IB SI NOT STT	MGT, LVCT	NO SI NO XAIT	None
Build Type	Table Type												
OOB XAIT	XAIT												
IB SI	MGT, LVCT, STT												
IB SI AND XAIT	MGT, LVCT, STT, XAIT												
IB SI NOT STT	MGT, LVCT												
NO SI NO XAIT	None												
<b>CDS Reference</b>	Text field not used in this version (set to "1")												
<b>MMS Reference</b>	Text field not used in this version (set to "1")												
<b>Modulation Mode</b>	<p>The modulation mode of the Transport Stream can be one of the following:</p> <ul style="list-style-type: none"> <li>• Analog</li> <li>• SCTE Mode 1 (64-QAM)</li> <li>• SCTE Mode 2 (256-QAM)</li> <li>• ATSC (8-VSB)</li> <li>• ATSC (16-VSB)</li> </ul>												
<b>Carrier Frequency</b>	Text field indicating the carrier frequency (Hz) of the Transport Stream												
<b>Transport Type</b>	Checkbox not used in this version (leave unchecked)												
<b>Path Select</b>	Checkbox not used in this version (leave unchecked)												
<b>Out Of Band</b>	Checkbox not used in this version (leave unchecked)												

7. Click the **Save** button to save the changes to the stream.

# Create an OCAP Service

## Introduction

This section provides guidelines and a procedure for creating an OCAP service.

## Guidelines

Follow these guidelines when you create an OCAP service:

- When you create an OCAP service, PAT and PMT are not version-checked, so an administrator should not change them after putting them into a production system. Changes would not be seen by an OCAP implementation until after a set-top is reset. Each carousel will have its own PMT Packet Identification numbers (PIDs) as well. Additionally, all audio and video content will have its own PMT PIDs.
- The PMT PID and the carousel PID should be set to a *common* value.
- PIDs 0x20 to 0x1FFA are available for use by TSBroadcaster. Some PIDs allowed by TSBroadcaster may be reserved for special processing in OCAP headends and modulators. Each PID in a TSBroadcaster stream definition must be unique

## Creating an OCAP Service

To create an OCAP service, complete the following steps.

**Important:** When creating or editing a service that will be re-multiplexed for onward transmission, the data entered in the TSBroadcaster must match the configuration expected in the multiplexing equipment.

1. Log in to the TSBroadcaster as a user with the appropriate privileges. See **Log In to the TSBroadcaster**, earlier in this chapter.

**Result:** After a successful login, the Home Page opens.

2. Click the **Streams** button from the navigation bar.

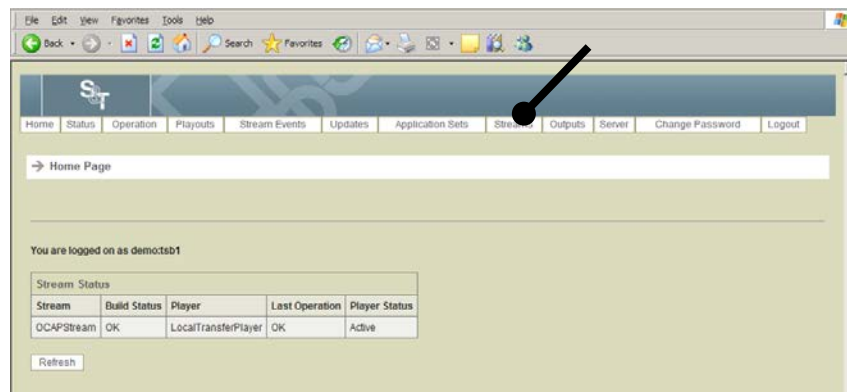

**Result:** The Manage All Streams page opens.

# Create an OCAP Service, Continued

3. Click the **Manage Stream** button on the **Manage All Streams Page**.

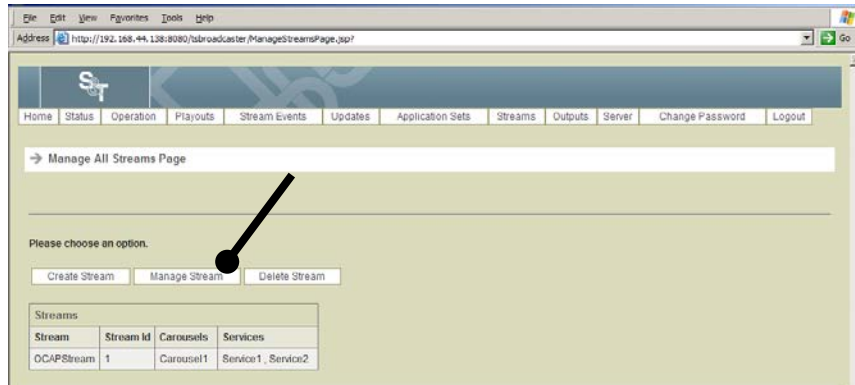

**Result:** The Manage Stream Select Page opens.

4. Select the stream from the drop-down list for which you want to create an OCAP service.

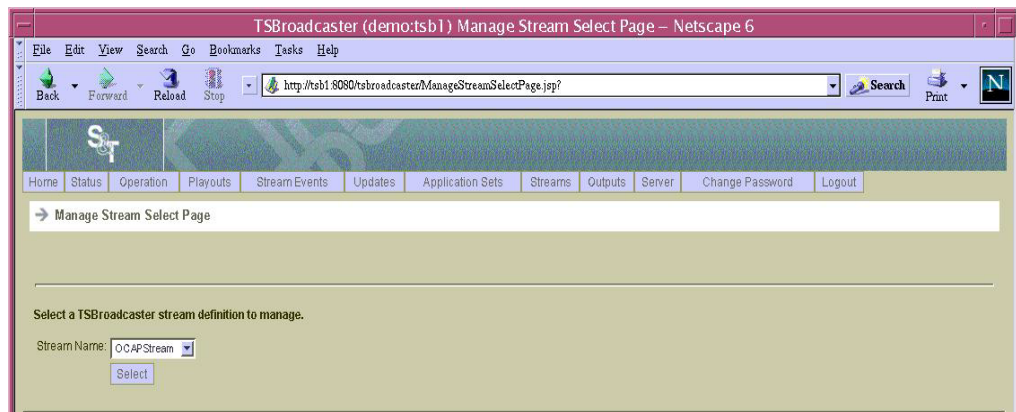

**Result:** The Manage OCAP Stream Page opens.

# Create an OCAP Service, Continued

- Click the **Create Service** button on the Manage OCAP Stream Page.

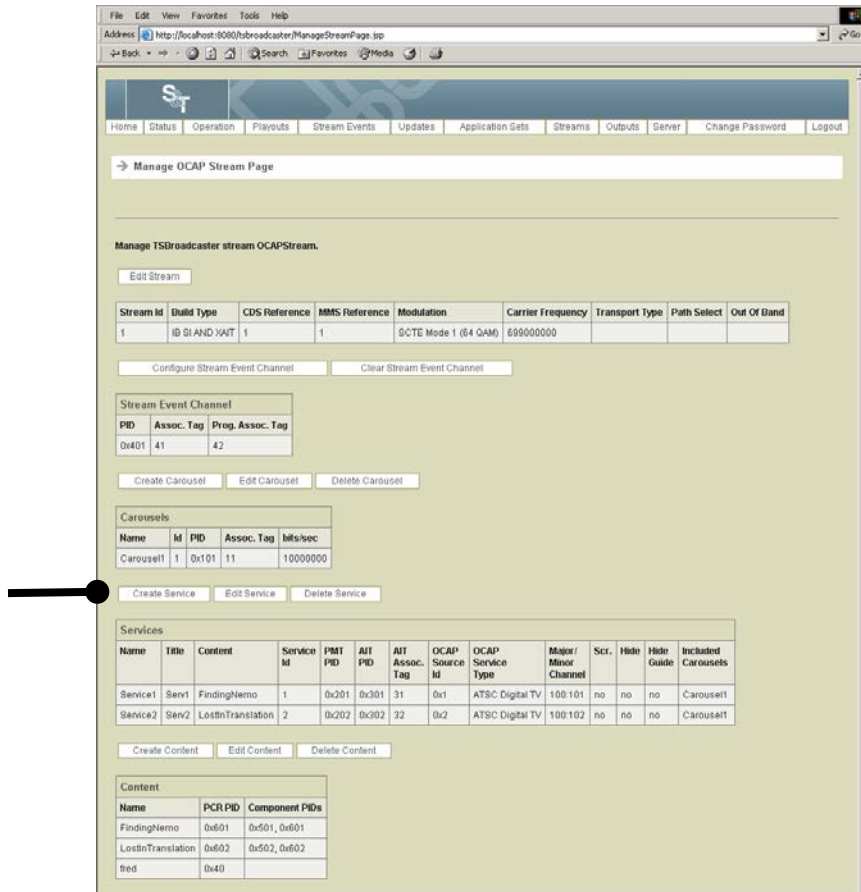

**Result:** The Create Service Page opens with the stream name populated.

## Create an OCAP Service, Continued

6. Enter the following data on the Create Service Page.

<b>Service Name</b>	The name that identifies the new service
<b>Title</b>	The name that will be inserted into the SI tables for this service
<b>Content</b>	The AV content that should be referenced by the PMT of this service (may be blank if the service does not have AV content)
<b>Service ID</b>	The MPEG Program Number of this service
<b>PMT PID</b>	The Program ID (PID) to be used for the Program Map Table (PMT) of this service
<b>AIT PID</b>	The PID to be used for the Application Interface Table (AIT) of this service
<b>AIT Assoc. Tag</b>	The association tag to be used to reference the AIT from the PMT of this service
<b>Carousel</b>	A check box that is created for each carousel indicating whether it is to be referenced from the PMT of this service
<b>OCAP Source ID</b>	The OCAP source ID of this service
<b>OCAP Service Type</b>	An indication of how this service is to be signaled: <ul style="list-style-type: none"> <li>• Analog TV</li> <li>• ATSC Digital TV</li> <li>• ATSC Audio Only</li> <li>• IB SI NOT STT</li> <li>• ATSC Data Broadcast</li> </ul>
<b>Major Channel Number</b>	The major channel number
<b>Minor Channel Number</b>	The minor channel number
<b>Scrambled</b>	A check box indicating if the service is scrambled
<b>Hidden</b>	A check box indicating whether to hide the service
<b>Hide Guide</b>	A check box indicating whether to hide the guide

7. Click the **Save** button to create a new OCAP Service definition.

# Edit an OCAP Service

## Editing an OCAP Service

To edit an OCAP service, complete the following steps.

1. Log in to the TSBroadcaster as a user with the appropriate privileges. See **Log In to the TSBroadcaster**, earlier in this chapter.

**Result:** After a successful login, the Home Page opens.

2. Click the **Streams** button from the navigation bar.

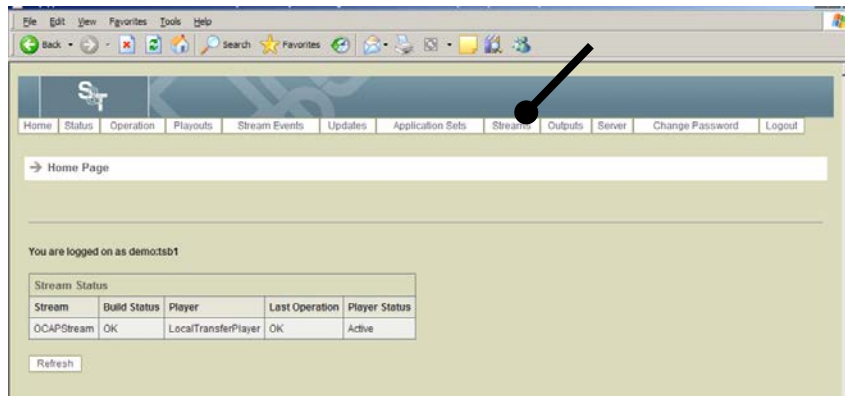

**Result:** The TSBroadcaster displays the **Manage All Streams** page.

3. Click the **Manage Stream** button on the **Manage All Streams** Page.

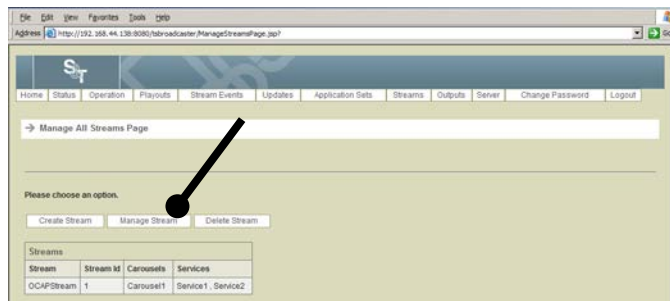

**Result:** The Manage Stream Select Page opens.

# Edit an OCAP Service, Continued

4. Select the required stream for which you want to edit an OCAP service and click **Select**.

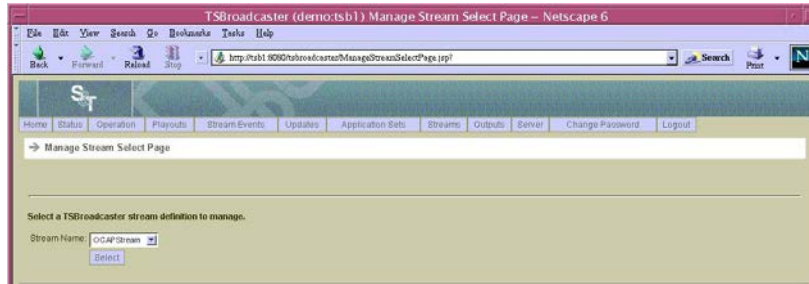

**Result:** The Manage OCAP Stream Page opens.

5. Click the **Edit Service** button on the Manage OCAP Stream Page.

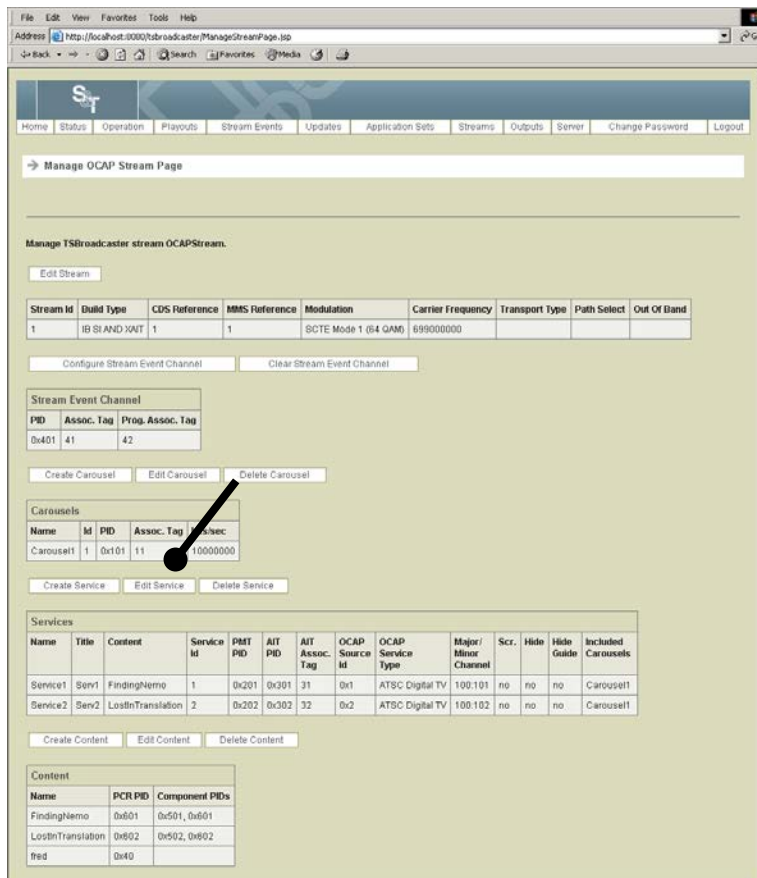

**Result:** The Edit Service Select Page opens.

## Edit an OCAP Service, Continued

6. Select the service that you want to edit and click Select.

**Result:** The Edit Service Page opens.

7. Enter the following information on the Edit Service Page.

<b>Service Name</b>	The name used by the TSBroadcaster to refer to the new service
<b>Title</b>	The name that will be inserted into the SI tables for this service
<b>Content</b>	The AV content that should be referenced by the PMT of this service (may be blank if the service does not have AV content)
<b>Service ID</b>	The MPEG program number of this service. This ID must match the MPEG program number on the DNCS.
<b>PMT PID</b>	The PID to be used for the PMT of this service
<b>AIT PID</b>	The PID to be used for the AIT of this service
<b>AIT Assoc. Tag</b>	The association tag to be used to reference the AIT from the PMT of this service
<b>Carousel</b>	A check box that is created for each carousel indicating whether it is to be referenced from the PMT of this service
<b>OCAP Source Id</b>	The OCAP source ID of this service. This ID must match the source ID on the DNCS.
<b>OCAP Service Type</b>	The service type to indicate how this service is to be signaled: <ul style="list-style-type: none"> <li>• Analog TV</li> <li>• ATSC Digital TV</li> <li>• ATSC Audio Only</li> <li>• IB SI NOT STT</li> <li>• ATSC Data Broadcast</li> </ul>
<b>Major Channel Number</b>	The major channel number
<b>Minor Channel Number</b>	The minor channel number
<b>Scrambled</b>	A check box indicating if the service is scrambled
<b>Hidden</b>	A check box indicating whether to hide the service
<b>Hide Guide</b>	A check box indicating whether to hide the guide

8. Click the **Save** button to save the changes to the service.

# Delete a Stream

## Deleting a Stream

To delete a stream, complete the following steps.

1. Log in to the TSBroadcaster as a user with the appropriate privileges. See **Log In to the TSBroadcaster**, earlier in this chapter.

**Result:** After a successful login, the Home Page opens.

2. Click the **Streams** button from the navigation bar.

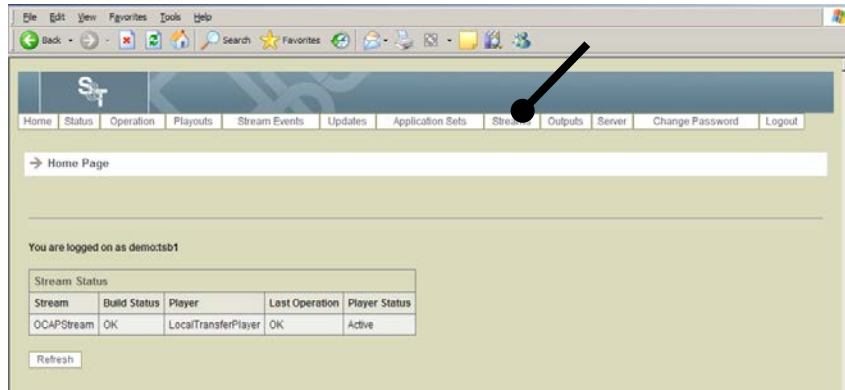

**Result:** The Manage All Streams page opens.

3. Click the **Delete Stream** button on the Manage All Streams Page.

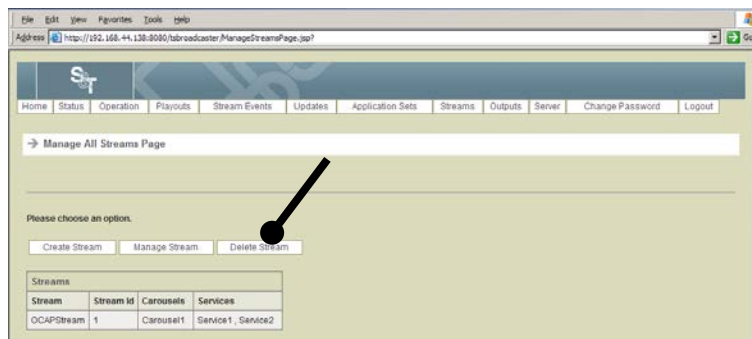

**Result:** The Delete Stream Page opens.

4. Select the stream you wish to delete.
5. Click the **Delete** button to delete the stream.

**Result:** This step removes all associated playouts and outputs from the system.

# Delete a Service

## Deleting a Service

To delete an OCAP service, complete the following steps.

1. Log in to the TSBroadcaster as a user with the appropriate privileges. See **Log In to the TSBroadcaster**, earlier in this chapter.

**Result:** After a successful login, the Home Page opens.

2. Click the **Streams** button from the navigation bar.

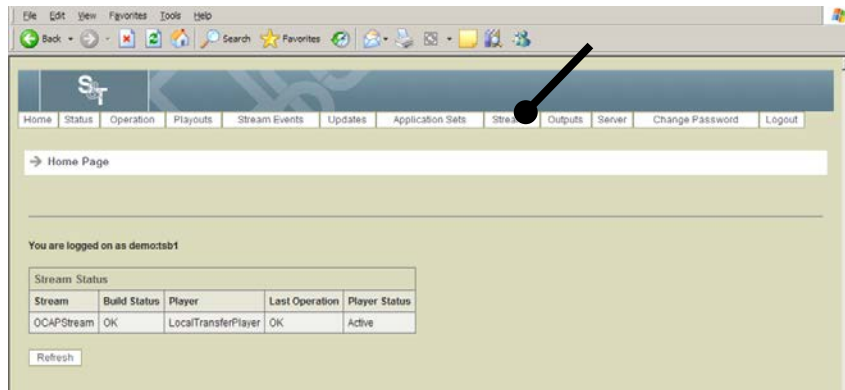

**Result:** The **Manage All Streams** page opens.

3. Click the **Manage Stream** button on the Manage All Streams Page.

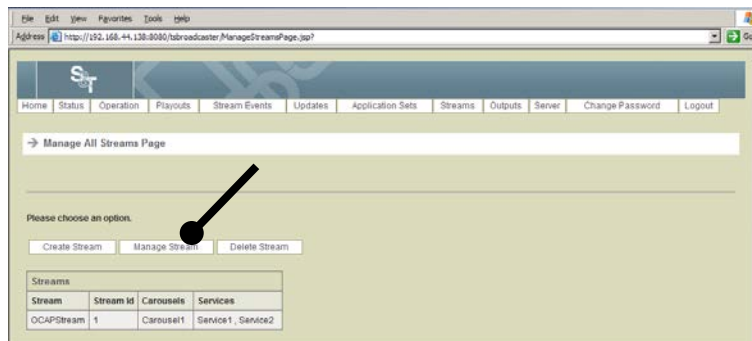

**Result:** The Manage Stream Select Page opens.

# Delete a Service, Continued

4. Select the stream you wish to delete for the service and click the **Select** button.

**Result:** The Manage OCAP Stream Page opens.

5. Click the **Delete Service** button on the **Manage OCAP Stream Page**.

The screenshot shows the 'Manage OCAP Stream Page' in a web browser. The page has a navigation menu at the top with options like Home, Status, Operation, Playouts, Stream Events, Updates, Application Sets, Streams, Outputs, Server, Change Password, and Logout. Below the navigation is a title bar for 'Manage OCAP Stream Page'. The main content area is titled 'Manage TSBroadcaster stream OCAPStream.' and includes an 'Edit Stream' button. There are several tables and form sections: 'Stream ID' table with columns like Build Type, CDS Reference, MMS Reference, Modulation, Carrier Frequency, Transport Type, Path Select, and Out Of Band; 'Stream Event Channel' table with columns PID, Assoc. Tag, and Prog. Assoc. Tag; 'Carousels' table with columns Name, Id, PID, Assoc. Tag, and bits/sec; and 'Services' table with columns Name, Title, Content, Service Id, PMT PID, AIT PID, AIT Assoc. Tag, OCAP Source Id, OCAP Service Type, Major/Minor Channel, Scr., Hide, Hide Guide, and Included Carousels. A 'Delete Service' button is highlighted with a black arrow. At the bottom, there are 'Create Content', 'Edit Content', and 'Delete Content' buttons, and a 'Content' table with columns Name, PCR PID, and Component PIDs.

**Result:** The Delete Service Page opens.

6. Select the service you wish to delete.
7. Click the **Delete** button to delete the service.

# Create a Carousel

## Introduction

A DSM-CC object carousel allows you to transfer files. This section provides a procedure for creating a DSM-CC object carousel.

## Creating a New DSM-CC Object Carousel

To create a new DSM-CC carousel, complete the following steps.

**Important:** When creating or editing a carousel that will be re-multiplexed for onward transmission, the data entered in the TSBroadcaster must match the configuration expected in the multiplexing equipment.

1. Log in to the TSBroadcaster as a user with the appropriate privileges. See **Log In to the TSBroadcaster**, earlier in this chapter.

**Result:** After a successful login, the Home Page opens.

2. Click the **Streams** button from the navigation bar.

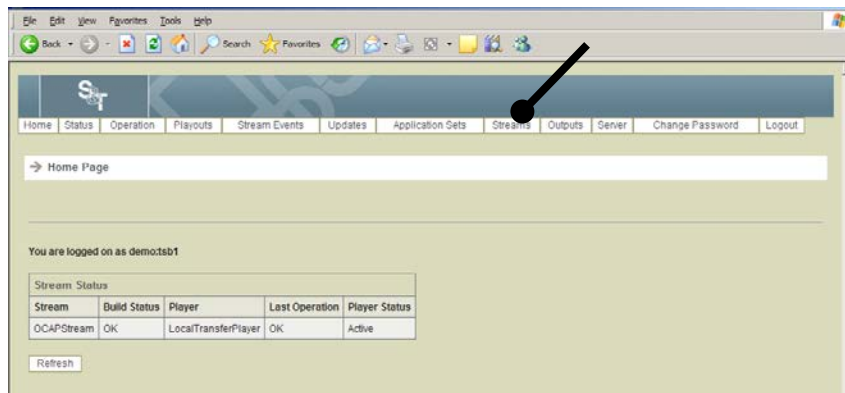

**Result:** The Manage All Streams page opens.

3. Click the **Manage Stream** button on the Manage All Streams Page.

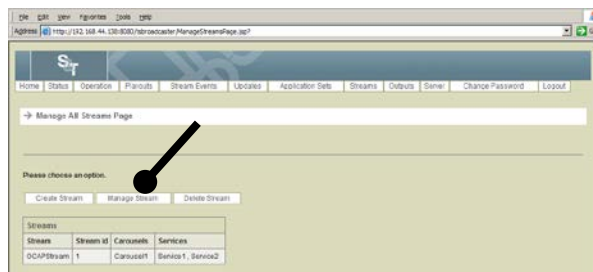

**Result:** The Manage Stream Select Page opens.

# Create a Carousel, Continued

4. Select the stream for which you want to create a new object and click the **Select** button.

**Result:** The Manage OCAP Stream Page opens.

5. Click the **Create Carousel** button on the **Manage OCAP Stream Page**.

Manage OCAP Stream Page

Manage TSBroadcaster stream OCAPStream.

Edit Stream

Stream Id	Build Type	CDS Reference	MMS Reference	Modulation	Carrier Frequency	Transport Type	Path Select	Out Of Band
1	IB SI AND XAIT	1	1	SCTE Mode 1 (64 QAM)	699000000			

Configure Stream Event Channel Clear Stream Event Channel

Stream Event Channel

PID	Assoc. Tag	Prog. Assoc. Tag
0x401	41	42

Create Carousel Edit Carousel Delete Carousel

Carousels

Name	Id	PID	Assoc. Tag	bits/sec
Carousel1	1	0x101	11	10000000

Create Service Edit Service Delete Service

Services

Name	Title	Content	Service Id	PMT PID	AIT PID	AIT Assoc. Tag	OCAP Source Id	OCAP Service Type	Major/Minor Channel	Scr.	Hide	Hide Guide	Included Carousels
Service1	Serv1	FindingNemo	1	0x201	0x301	31	0x1	ATSC Digital TV	100:101	no	no	no	Carousel1
Service2	Serv2	LostInTranslation	2	0x202	0x302	32	0x2	ATSC Digital TV	100:102	no	no	no	Carousel1

Create Content Edit Content Delete Content

Content

Name	PCR PID	Component PIDs
FindingNemo	0x601	0x501, 0x601
LostInTranslation	0x602	0x502, 0x602
fred	0x40	

**Result:** The Create Carousel Page opens.

## Create a Carousel, Continued

6. Enter the following data on the Create Carousel Page.

<b>Carousel Name</b>	The name used by the TSBroadcaster to refer to the new carousel
<b>Carousel ID</b>	The carousel ID (also known as the download ID). The TSBroadcaster must be configured to use download IDs that are distinct from the numbers used for Broadcast File System (BFS). We recommend that you choose BFS Source IDs with values less than 0x00007FFF and that you configure the TSBroadcaster with carousel IDs with values greater than 0x00007FFF.
<b>PID</b>	The PID to be used to carry this carousel in the Transport Stream
<b>Assoc. Tag</b>	The association tag to be used to reference the carousel from a PMT
<b>Bit Rate (bits/sec)</b>	The maximum bit rate allocated for this carousel. The TSBroadcaster will manage the allocation of bit rate to applications played out in the carousel.

7. Click the **Save** button to create a new carousel.

# Edit a Carousel

## Editing a Carousel

To edit the attributes of a carousel, complete the following steps.

1. Log in to the TSBroadcaster as a user with the appropriate privileges. See **Log In to the TSBroadcaster**, earlier in this chapter.

**Result:** After a successful login, the Home Page opens.

2. Click the **Streams** button from the navigation bar.

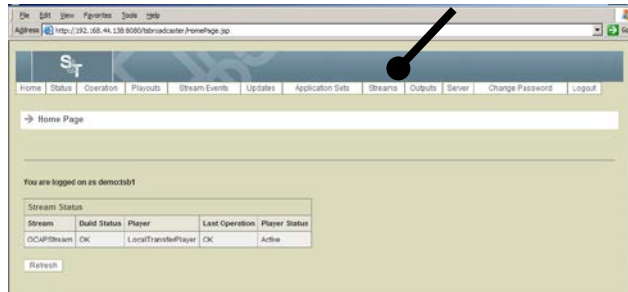

**Result:** The Manage All Streams page opens.

3. Click the **Manage Stream** button on the Manage All Streams Page.

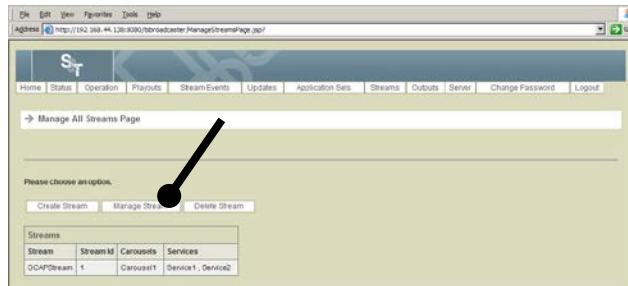

**Result:** The Manage Stream Select Page opens.

4. Select the stream for which you want to create a new object and click the **Select** button.

**Result:** The Manage OCAP Stream Page opens.

# Edit a Carousel, Continued

- Click the **Edit Carousel** button on the Manage OCAP Stream Page and select the required service.

The screenshot shows the 'Manage OCAP Stream Page' interface. At the top, there is a navigation menu with options like Home, Status, Operation, Playouts, Stream Events, Updates, Application Sets, Streams, Outputs, Server, Change Password, and Logout. Below this is a breadcrumb trail: 'Manage OCAP Stream Page'. The main content area is titled 'Manage TSBroadcaster stream OCAPStream.' and contains several sections:

- Edit Stream:** A button to edit the stream.
- Stream Table:** A table with columns: Stream Id, Build Type, CDS Reference, MMS Reference, Modulation, Carrier Frequency, Transport Type, Path Select, and Out Of Band. It contains one row with values: 1, IB SI AND XAIT, 1, 1, SCTE Mode 1 (64 QAM), 699000000, and empty cells for the last three columns.
- Stream Event Channel:** Two buttons: 'Configure Stream Event Channel' and 'Clear Stream Event Channel'.
- Stream Event Channel Table:** A table with columns: PID, Assoc. Tag, and Prog. Assoc. Tag. It contains one row: 0x401, 41, 42. A black arrow points to the 'Edit Carousel' button below this table.
- Carousels:** Three buttons: 'Create Carousel', 'Edit Carousel', and 'Delete Carousel'.
- Carousels Table:** A table with columns: Name, Id, PID, Assoc. Tag, and bits/sec. It contains one row: Carousel1, 1, 0x101, 11, 10000000.
- Services:** Three buttons: 'Create Service', 'Edit Service', and 'Delete Service'.
- Services Table:** A table with columns: Name, Title, Content, Service Id, PMT PID, AIT PID, AIT Assoc. Tag, OCAP Source Id, OCAP Service Type, Major/Minor Channel, Scr., Hide, Hide Guide, and Included Carousels. It contains two rows: Service1 (FindingNemo) and Service2 (LostInTranslation).
- Content:** Three buttons: 'Create Content', 'Edit Content', and 'Delete Content'.
- Content Table:** A table with columns: Name, PCR PID, and Component PIDs. It contains three rows: FindingNemo, LostInTranslation, and fred.

**Result:** The Edit Carousel Select Page opens.

## Edit a Carousel, Continued

6. Select the carousel you wish to edit and click the Select button.

**Result:** The Edit Carousel Page opens.

7. Enter the following data on the Edit Carousel Page.

<b>Carousel ID</b>	The carousel ID (also known as the download ID). The TSBroadcaster must be configured to use download IDs that are distinct from the numbers used for Broadcast File System (BFS). We recommend that you choose BFS Source IDs with values less than 0x00007fff and that you configure the TSBroadcaster with carousel IDs with values greater than 0x00007fff
<b>PID</b>	The PID to be used to carry this carousel in the Transport Stream
<b>Assoc. Tag</b>	The association tag to be used to reference the carousel from a PMT
<b>Bit Rate (bits/sec)</b>	The maximum bit rate allocated for this carousel. The TSBroadcaster will manage the allocation of bit rate to applications played out in the carousel

8. Click the **Save** button to save the changes to the carousel.

# Delete a Carousel

## Deleting a Carousel

To delete a carousel, complete the following steps.

1. Log in to the TSBroadcaster as a user with the appropriate privileges. See **Log In to the TSBroadcaster**, earlier in this chapter.

**Result:** After a successful login, the Home Page opens.

2. Click the **Streams** button from the navigation bar.

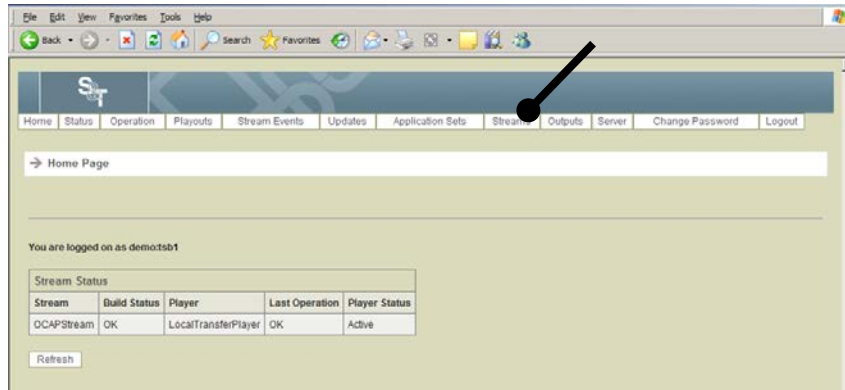

The Manage All Streams page opens. This page shows a table of Transport Stream Definitions, and presents a set of buttons to manage them.

3. Click the **Manage Stream** button on the Manage All Streams Page.

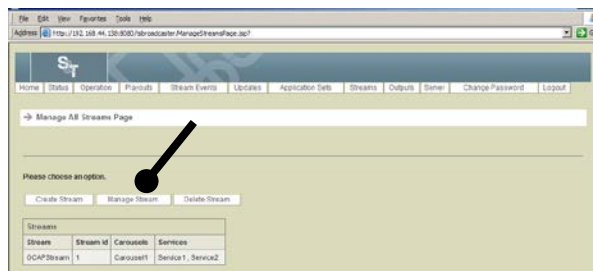

**Result:** The Manage Stream Select Page opens.

4. Select the stream for which you want to create a new object and click the **Select** button.

**Result:** The Manage OCAP Stream Page opens.

# Delete a Carousel, Continued

5. Click the **Delete Carousel** button on the Manage OCAP Stream Page.

The screenshot shows a web browser window displaying the 'Manage OCAP Stream Page'. The page has a navigation menu at the top with options like Home, Status, Operation, Playouts, Stream Events, Updates, Application Sets, Streams, Outputs, Server, Change Password, and Logout. Below the navigation is a breadcrumb trail: 'Manage OCAP Stream Page'. The main content area is titled 'Manage TSBroadcaster stream OCAPStream.' and contains several sections:

- Edit Stream**: A table with columns: Stream Id, Build Type, CDS Reference, MMS Reference, Modulation, Carrier Frequency, Transport Type, Path Select, Out Of Band. Row 1: 1, IB SI AND XAIT, 1, 1, SCTE Mode 1 (64 QAM), 699000000.
- Configure Stream Event Channel** and **Clear Stream Event Channel** buttons.
- Stream Event Channel**: A table with columns: PID, Assoc. Tag, Prog. Assoc. Tag. Row 1: 0x401, 41, 42.
- Create Carousel**, **Edit Carousel**, and **Delete Carousel** buttons. A black arrow points to the 'Delete Carousel' button.
- Carousels**: A table with columns: Name, Id, PID, Assoc. Tag, bits/sec. Row 1: Carousel1, 1, 0x101, 11, 10000000.
- Create Service**, **Edit Service**, and **Delete Service** buttons.
- Services**: A table with columns: Name, Title, Content, Service Id, PMT PID, AIT PID, AIT Assoc. Tag, OCAP Source Id, OCAP Service Type, Major/Minor Channel, Scr., Hide, Hide Guide, Included Carousels. Rows: Service1 (Serv1, FindingNemo, 1, 0x201, 0x301, 31, 0x1, ATSC Digital TV, 100:101, no, no, no, Carousel1), Service2 (Serv2, LostInTranslation, 2, 0x202, 0x302, 32, 0x2, ATSC Digital TV, 100:102, no, no, no, Carousel1).
- Create Content**, **Edit Content**, and **Delete Content** buttons.
- Content**: A table with columns: Name, PCR PID, Component PIDs. Rows: FindingNemo (0x601, 0x501, 0x601), LostInTranslation (0x602, 0x502, 0x602), fred (0x40, ).

**Result:** The Delete Carousel Page opens.

6. Select the carousel you wish to delete.
7. Click the **Delete** button to delete the carousel.

# Configure the Stream Event Channel

## Configuring the Stream Event Channel

The TSBroadcaster supports only *one* stream event channel. The stream event channel identifies the PID where the stream event will reside. To configure a stream event channel, complete the following steps.

**Important:** When creating or editing a stream event channel that will be re-multiplexed for onward transmission, the data entered in the TSBroadcaster must match the configuration expected in the multiplexing equipment.

1. Log in to the TSBroadcaster as a user with the appropriate privileges. See **Log In to the TSBroadcaster**, earlier in this chapter.

**Result:** After a successful login, the Home Page opens.

2. Click the **Streams** button from the navigation bar.

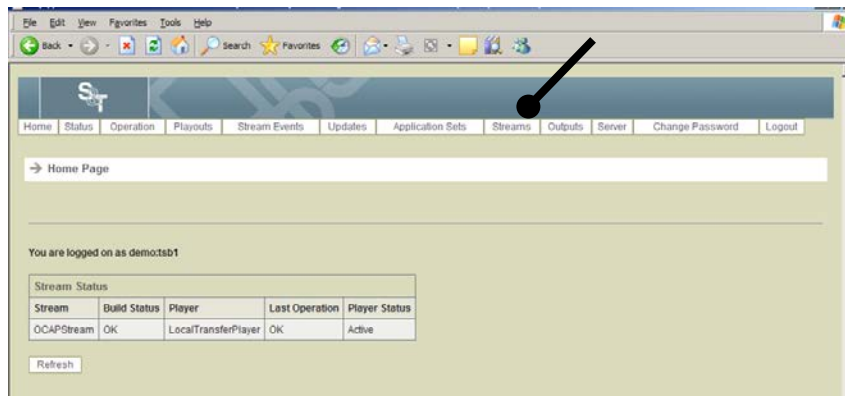

**Result:** The Manage All Streams page opens.

3. Click the **Manage Stream** button on the Manage All Streams Page.

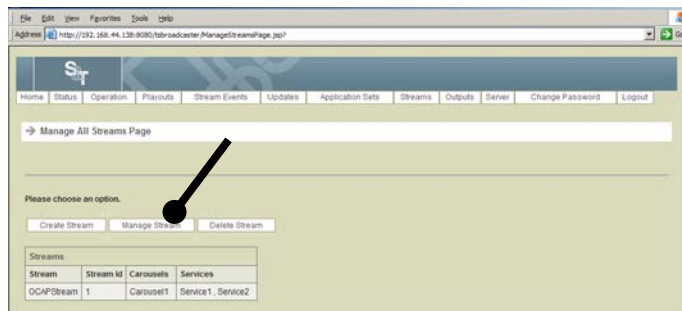

**Result:** The Manage Stream Select Page opens.

# Configure the Stream Event Channel, Continued

4. Select the stream for which you want to configure a stream event channel and click the **Select** button.

**Result:** The Manage OCAP Stream Page opens.

5. Click the **Configure Stream Event Channel** button on the Manage OCAP Stream Page.

Manage TSBroadcaster stream OCAPStream.

Edit Stream

Stream Id	Build Type	CDS Reference	MMS Reference	Modulation	Carrier Frequency	Transport Type	Path Select	Out Of Band
1	IB SI AND XAT	1	1	SCTE Mode 1 (64 QAM)	699000000			

Configure Stream Event Channel    Clear Stream Event Channel

Stream Event Channel

PID	Assoc. Tag	Prog. Assoc. Tag
0x401	41	42

Create Carousel    Edit Carousel    Delete Carousel

Carousels

Name	Id	PID	Assoc. Tag	bits/sec
Carousel1	1	0x101	11	10000000

Create Service    Edit Service    Delete Service

Services

Name	Title	Content	Service Id	PMT PID	AIT PID	AIT Assoc. Tag	OCAP Source Id	OCAP Service Type	Major/Minor Channel	Scr.	Hide	Hide Guide	Included Carousels
Service1	Serv1	FindingNemo	1	0x201	0x301	31	0x1	ATSC Digital TV	100:101	no	no	no	Carousel1
Service2	Serv2	LostInTranslation	2	0x202	0x302	32	0x2	ATSC Digital TV	100:102	no	no	no	Carousel1

Create Content    Edit Content    Delete Content

Content

Name	PCR PID	Component PIDs
FindingNemo	0x601	0x501, 0x601
LostInTranslation	0x602	0x502, 0x602
fred	0x40	

**Result:** The Configure Stream Event Channel Page opens.

## Configure the Stream Event Channel, Continued

6. Enter the following data on the Configure Stream Event Channel Page.

<b>PID</b>	The PID to be used to carry stream events in this Transport Stream. Enter the PID in hexadecimal or decimal. The range for the PID is 0x21 to 0x1ffe.
<b>Assoc. Tag</b>	The association tag to be used to reference the stream event channel from a PMT
<b>Prog. Assoc. Tag</b>	The program association tag to be used in a deferred reference to the stream event channel from a PMT

7. Click the **Save** button to save the stream event channel configuration.

# Clear a Stream Event Channel

## Clearing a Stream Event Channel

To clear a stream event channel, complete the following steps.

1. Log in to the TSBroadcaster as a user with the appropriate privileges. See **Log In to the TSBroadcaster**, earlier in this chapter.

**Result:** After a successful login, the Home Page opens.

2. Click the **Streams** button from the navigation bar.

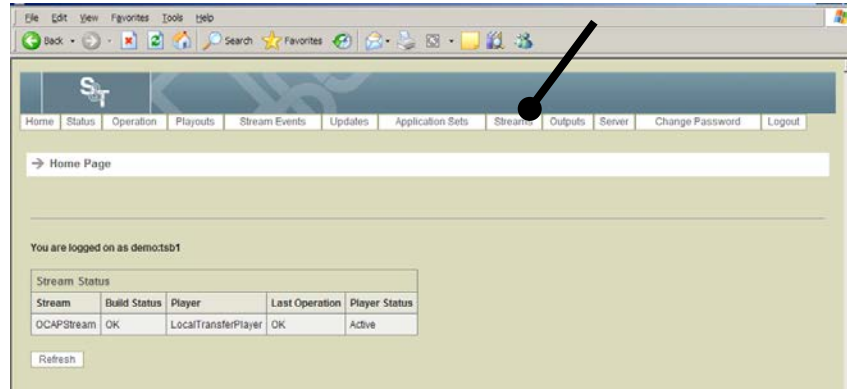

**Result:** The Manage All Streams page opens.

3. Click the **Manage Stream** button on the Manage All Streams Page.

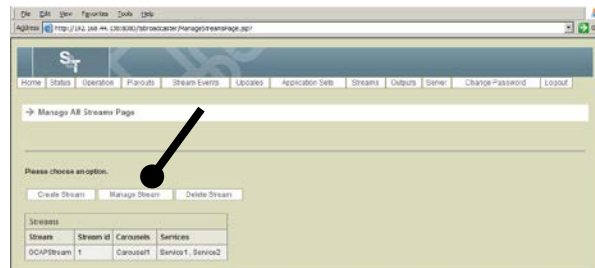

**Result:** The Manage OCAP Stream Page opens.

# Clear a Stream Event Channel, Continued

- Click the **Clear Stream Event Channel** button on the Manage OCAP Stream Page to remove the stream event channel from the Transport Stream.

Manage OCAP Stream Page

Manage TSBroadcaster stream OCAPStream.

Edit Stream

Stream Id	Build Type	CDS Reference	MMS Reference	Modulation	Carrier Frequency	Transport Type	Path Select	Out Of Band
1	IB SI AND XAIT	1	1	SCTE Mode 1 (64 QAM)	699000000			

Configure Stream Event Channel    Clear Stream Event Channel

Stream Event Channel

PID	Assoc. Tag	Prog. Assoc. Tag
0x401	41	42

Create Carousel    Edit Carousel    Delete Carousel

Carousels

Name	Id	PID	Assoc. Tag	bits/sec
Carousel1	1	0x101	11	10000000

Create Service    Edit Service    Delete Service

Services

Name	Title	Content	Service Id	PMT PID	AIT PID	AIT Assoc. Tag	OCAP Source Id	OCAP Service Type	Major/Minor Channel	Scr.	Hide	Hide Guide	Included Carousels
Service1	Serv1	FindingNemo	1	0x201	0x301	31	0x1	ATSC Digital TV	100:101	no	no	no	Carousel1
Service2	Serv2	LostInTranslation	2	0x202	0x302	32	0x2	ATSC Digital TV	100:102	no	no	no	Carousel1

Create Content    Edit Content    Delete Content

Content

Name	PCR PID	Component PIDs
FindingNemo	0x601	0x501, 0x601
LostInTranslation	0x602	0x502, 0x602
fred	0x40	

# Create A/V Content

## Introduction

The TSBroadcaster enables you to play audio and video streams from the services within a transport stream. The actual A/V streams may be multiplexed into the Transport Stream either within the TSBroadcaster or externally in a multiplexer downstream from TSBroadcaster. For instructions on how to multiplex your own content into TSBroadcaster, see **Configuring A/V Content** in Chapter 10.

## Creating A/V Content

To create A/V content, complete the following steps.

**Important:** When creating or editing A/V content, the data entered in the TSBroadcaster must match the A/V feed provided in local data insertion or in the multiplexing equipment.

1. Log in to the TSBroadcaster as a user with the appropriate privileges. See **Log In to the TSBroadcaster**, earlier in this chapter.

**Result:** After a successful login, the Home Page opens.

2. Click the **Streams** button from the navigation bar.

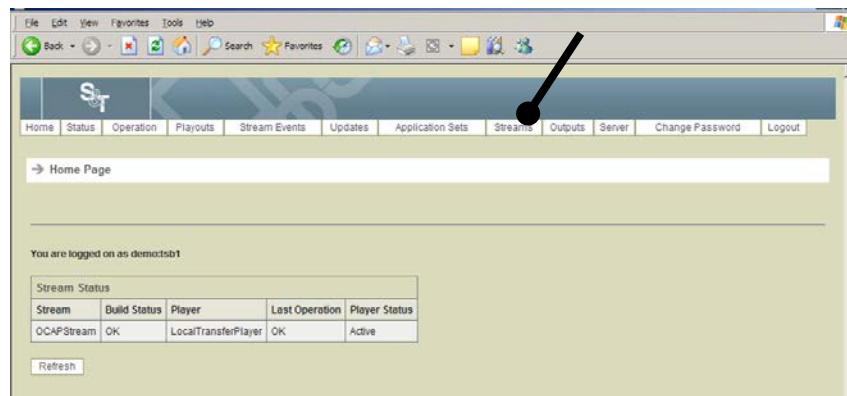

**Result:** The Manage All Streams page opens.

3. Click the **Manage Stream** button on the Manage All Streams Page.

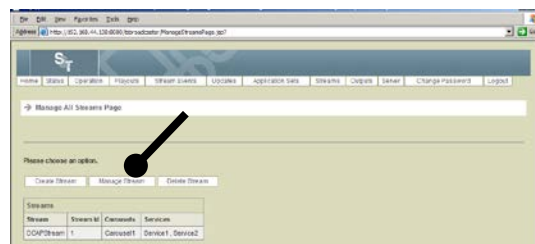

**Result:** The Manage Stream Select Page opens.

# Create A/V Content, Continued

4. Select the stream for which you want to create a new object and click the **Select** button.

**Result:** The Manage OCAP Stream Page opens.

5. Click the **Create Content** button on the Manage OCAP Stream Page.

Manage TSBroadcaster stream OCAPStream.

Stream Id	Build Type	CDS Reference	MMS Reference	Modulation	Carrier Frequency	Transport Type	Path Select	Out Of Band
1	IB SI AND XAIT	1	1	SCTE Mode 1 (64 QAM)	699000000			

Stream Event Channel

PID	Assoc. Tag	Prog. Assoc. Tag
0x401	41	42

Carousels

Name	Id	PID	Assoc. Tag	bits/sec
Carousel1	1	0x101	11	10000000

Services

Name	Title	Content	Service Id	PMT PID	AIT PID	AIT Assoc. Tag	OCAP Source Id	OCAP Service Type	Major/Minor Channel	Scr.	Hide	Hide Guide	Included Carousels
Service1	Serv1	FindingNemo	1	0x201	0x301	31	0x1	ATSC Digital TV	100:101	no	no	no	Carousel1
Service2	Serv2	LostInTranslation	2	0x202	0x302	32	0x2	ATSC Digital TV	100:102	no	no	no	Carousel1

Content

Name	PCR PID	Component PIDs
FindingNemo	0x601	0x501, 0x601
LostInTranslation	0x602	0x502, 0x602
fred	0x40	

**Result:** The Create Content Page opens.

## Create A/V Content, Continued

6. Enter the following data on the Create Content Page.

<b>Content Name</b>	The name used by TSBroadcaster to refer to the new A/V content. Enter the full directory path for the content <b>Example:</b> /media/tsmux/tsmusparams
<b>PCR PID</b>	The PID that is used to determine the PCR of the A/V content

7. Click the **Save** button to save the A/V content reference.

# Edit A/V Content

## Editing A/V Content

To edit the A/V content, complete the following steps.

1. Log in to the TSBroadcaster as a user with the appropriate privileges. See **Log In to the TSBroadcaster**, earlier in this chapter.

**Result:** After a successful login, the Home Page opens.

2. Click the **Streams** button from the navigation bar.

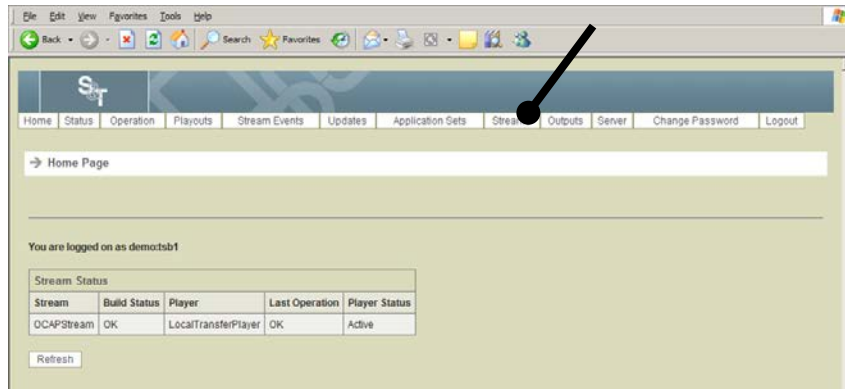

**Result:** The Manage All Streams page opens.

3. Click the **Manage Stream** button on the Manage All Streams Page.

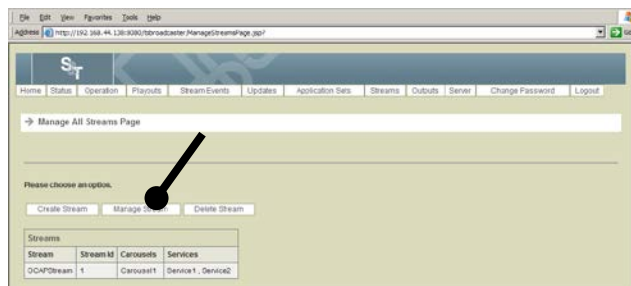

**Result:** The Manage Stream Select Page opens.

# Edit A/V Content, Continued

4. Select the stream for which you want to create a new object and click the **Select** button.

**Result:** The Manage OCAP Stream Page opens.

5. Click the **Edit Content** button on the Manage OCAP Stream Page and select the required A/V content.

Manage TSBroadcaster stream OCAPStream.

Edit Stream

Stream Id	Build Type	CDS Reference	MMS Reference	Modulation	Carrier Frequency	Transport Type	Path Select	Out Of Band
1	IB SI AND XAIT	1	1	SCTE Mode 1 (64 QAM)	699000000			

Configure Stream Event Channel    Clear Stream Event Channel

Stream Event Channel

PID	Assoc. Tag	Prog. Assoc. Tag
0x401	41	42

Create Carousel    Edit Carousel    Delete Carousel

Carousels

Name	Id	PID	Assoc. Tag	bits/sec
Carousel1	1	0x101	11	10000000

Create Service    Edit Service    Delete Service

Services

Name	Title	Content	Service Id	PMT PID	AIT PID	AIT Assoc. Tag	OCAP Source Id	OCAP Service Type	Major/Minor Channel	Scr.	Hide	Hide Guide	Included Carousels
Service1	Serv1	FindingNemo	1	0x201	0x301	31	0x1	ATSC Digital TV	100:101	no	no	no	Carousel1
Service2	Serv2	LostInTranslation	2	0x202	0x302	32	0x2	ATSC Digital TV	100:102	no	no	no	Carousel1

Create Content    Edit Content    Delete Content

Content

Name	PCR PID	Component PIDs
FindingNemo	0x601	0x501, 0x601
LostInTranslation	0x602	0x502, 0x602
fred	0x40	

**Result:** The Manage Content Page opens.

# Edit A/V Content, Continued

- Click the **Edit Content** button on the Manage Content Page

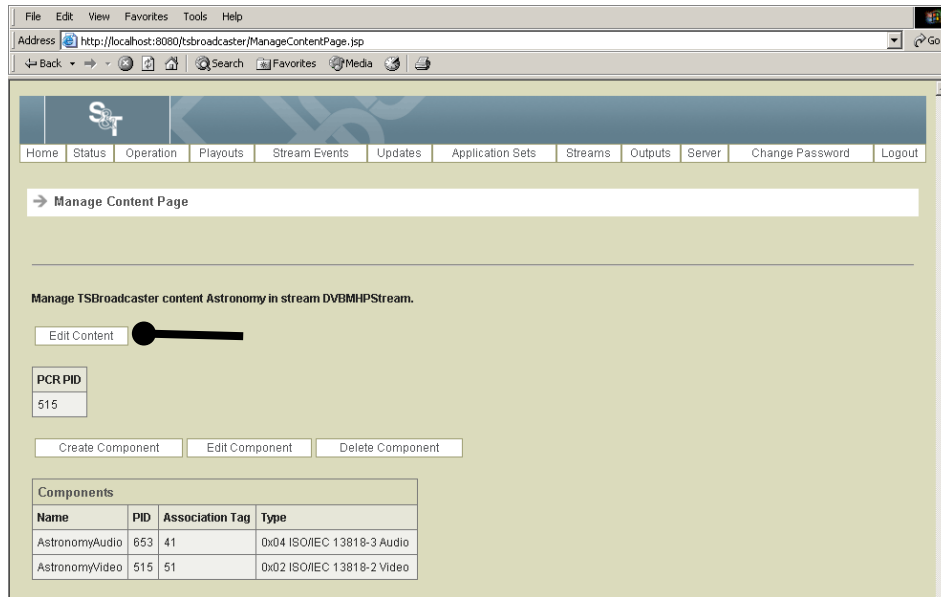

**Result:** The Edit Content Page opens.

- Enter the following data on the Edit Content Page.

<b>Content Name</b>	The name used by TSBroadcaster to refer to the new A/V content
<b>PCR PID</b>	The PID that is used to determine the PCR of the A/V content

- Click the **Save** button to save the changes to the content.

# Delete A/V Content

## Deleting A/V Content

To delete A/V content, complete the following steps.

1. Log in to the TSBroadcaster as a user with the appropriate privileges. See **Log In to the TSBroadcaster**, earlier in this chapter.

After a successful login, the Home Page opens.

2. Click the **Streams** button from the navigation bar.

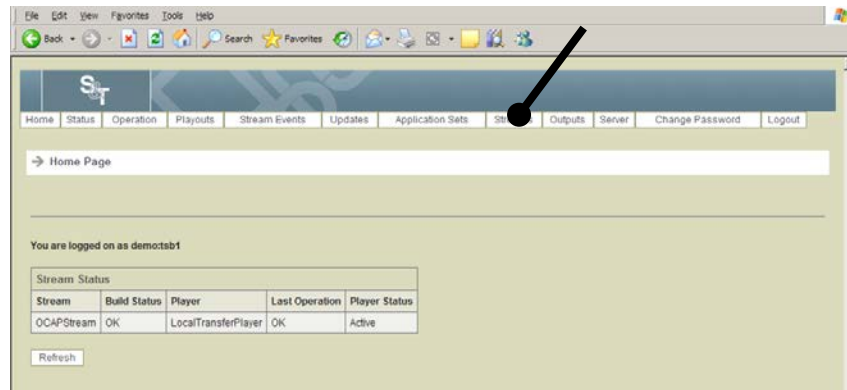

**Result:** The Manage All Streams page opens.

3. Click the **Manage Stream** button on the Manage All Streams Page.

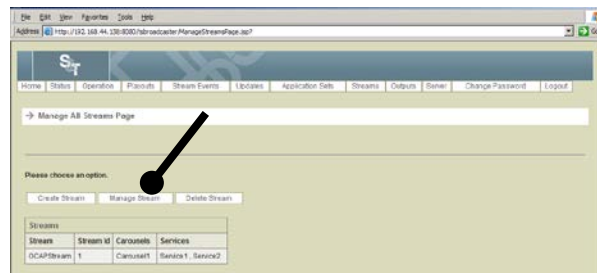

**Result:** The Manage OCAP Stream Page opens.

# Delete A/V Content, Continued

- Click the **Delete Content** button on the Manage OCAP Stream Page.

The screenshot shows a web browser window displaying the 'Manage OCAP Stream Page'. The page has a navigation menu at the top with links like Home, Status, Operation, Playouts, Stream Events, Updates, Application Sets, Streams, Outputs, Server, Change Password, and Logout. Below the navigation is a breadcrumb trail: 'Manage OCAP Stream Page'. The main content area is titled 'Manage TSBroadcaster stream OCAPStream.' and includes an 'Edit Stream' button. There are several tables and form sections:

- Stream Table:** A table with columns: Stream Id, Build Type, CDS Reference, MMS Reference, Modulation, Carrier Frequency, Transport Type, Path Select, and Out Of Band. It contains one row with Stream Id 1.
- Stream Event Channel Table:** A table with columns: PID, Assoc. Tag, and Prog. Assoc. Tag. It contains one row with PID 0x401.
- Carousels Table:** A table with columns: Name, Id, PID, Assoc. Tag, and bits/sec. It contains one row for Carousel1.
- Services Table:** A table with columns: Name, Title, Content, Service Id, PMT PID, AIT PID, AIT Assoc. Tag, OCAP Source Id, OCAP Service Type, Major/Minor Channel, Scr., Hide, Hide Guide, and Included Carousels. It contains two rows for Service1 and Service2.
- Content Table:** A table with columns: Name, PCR PID, and Component PIDs. It contains three rows: FindingNemo, LostInTranslation, and fred.

At the bottom of the page, there are buttons for 'Create Content', 'Edit Content', and 'Delete Content'. A black circle highlights the 'Delete Content' button.

**Result:** The Delete Content Page opens.

- Select the A/V content you wish to delete.
- Click the **Delete** button to delete the A/V content.

# Create an A/V Content Component

## Introduction

An A/V content component defines the information needed to allow a PMT to refer to one Elementary Stream of A/V content.

## Creating an A/V Content Component

To create an A/V content component, complete the following steps.

**Important:** When creating or editing an A/V content component, the data entered in the TSBroadcaster must match the configuration expected in local A/V data insertion or in any multiplexing equipment.

1. Log in to the TSBroadcaster as a user with the appropriate privileges. See **Log In to the TSBroadcaster**, earlier in this chapter.

**Result:** After a successful login, the Home Page opens.

2. Click the **Streams** button from the navigation bar.

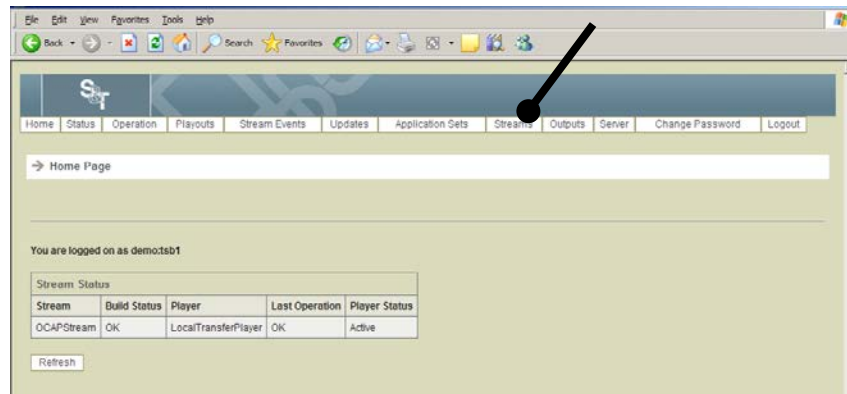

**Result:** The Manage All Streams page opens.

3. Click the **Manage Stream** button on the Manage All Streams Page.

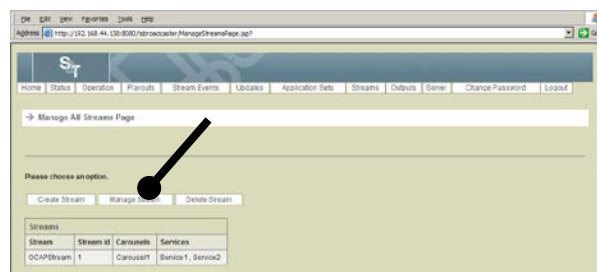

**Result:** The Manage Stream Select Page opens.

# Create an A/V Content Component, Continued

- Select the stream for which you want to create the A/V content and click the **Select** button.

**Result:** The Manage OCAP Stream Page opens.

- Click the **Edit Content** button on the Manage OCAP Stream Page and select the required A/V content.

Address: http://localhost:8080/tsbroadcaster/ManageStreamPage.jsp

Home Status Operation Playouts Stream Events Updates Application Sets Streams Outputs Server Change Password Logout

→ Manage OCAP Stream Page

Manage TSBroadcaster stream OCAPStream.

Edit Stream

Stream Id	Build Type	CDS Reference	MMS Reference	Modulation	Carrier Frequency	Transport Type	Path Select	Out Of Band
1	IB SI AND XAT	1	1	SCTE Mode 1 (64 QAM)	699000000			

Configure Stream Event Channel Clear Stream Event Channel

Stream Event Channel

PID	Assoc. Tag	Prog. Assoc. Tag
0x401	41	42

Create Carousel Edit Carousel Delete Carousel

Carousels

Name	Id	PID	Assoc. Tag	bits/sec
Carousel1	1	0x101	11	10000000

Create Service Edit Service Delete Service

Services

Name	Title	Content	Service Id	PMT PID	AIT PID	AIT Assoc. Tag	OCAP Source Id	OCAP Service Type	Major/Minor Channel	Scr.	Hide	Hide Guide	Included Carousels
Service1	Serv1	FindingNemo	1	0x201	0x301	31	0x1	ATSC Digital TV	100:101	no	no	no	Carousel1
Service2	Serv2	LostInTranslation		0x202	0x302	32	0x2	ATSC Digital TV	100:102	no	no	no	Carousel1

Create Content Edit Content Delete Content

Content

Name	PCR PID	Component PIDs
FindingNemo	0x601	0x501, 0x601
LostInTranslation	0x602	0x502, 0x602
fred	0x40	

**Result:** The Manage Content Page opens.

# Create an A/V Content Component, Continued

- Click the **Create Component** button on the Manage Content Page.

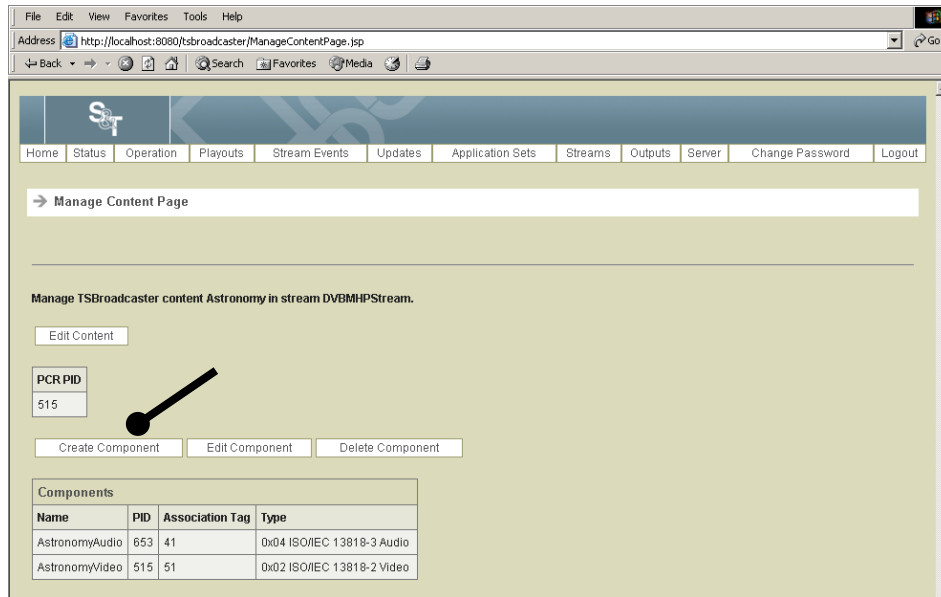

**Result:** The Create Content Component Page opens.

- Enter the following data on the Create Content Component Page.

<b>Component Name</b>	The name used by TSBroadcaster to refer to the new component
<b>PID</b>	The PID that will be used to carry the component
<b>Association Tag</b>	The association tag to be used to reference the component from a PMT
<b>Type</b>	The stream type of the component: <ul style="list-style-type: none"> <li>0x01 ISO/IEC 11172 Video (0x01)</li> <li>0x02 ISO/IEC 13818-2 Video</li> <li>0x03 ISO/IEC 11172 Audio</li> <li>0x04 ISO/IEC 13818-3 Audio</li> <li>0x05 ISO/IEC 13818-1 private sections</li> <li>0x06 ISO/IEC 13818-1 PES/private data</li> <li>0x81 AC3 Audio</li> </ul>

- Click the **Save** button to save the component.

# Edit an A/V Content Component

## Editing an A/V Content Component

To edit an A/V content component, complete the following steps.

1. Log in to the TSBroadcaster as a user with the appropriate privileges. See **Log In to the TSBroadcaster**, earlier in this chapter.

After a successful login, the Home Page opens.

2. Click the **Streams** button from the navigation bar.

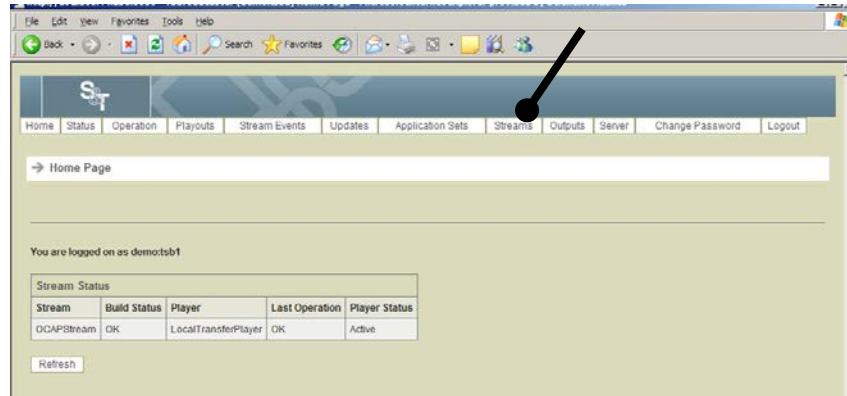

**Result:** The Manage All Streams page opens.

3. Click the **Manage Stream** button on the Manage All Streams Page.

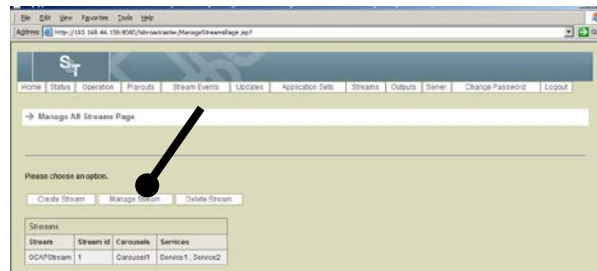

**Result:** The Manage Stream Select Page opens.

# Edit an A/V Content Component, Continued

- Select the stream for which you want to edit the A/V content and click the **Select** button.

**Result:** The Manage OCAP Stream Page opens.

- Click the **Edit Content** button on the Manage OCAP Stream Page and select the required A/V content.

The screenshot shows the 'Manage OCAP Stream Page' in a web browser. The page has a navigation menu at the top with links like Home, Status, Operation, Playouts, Stream Events, Updates, Application Sets, Streams, Outputs, Server, Change Password, and Logout. Below the menu is a title bar and a main content area. The main content area is titled 'Manage TSBroadcaster stream OCAPStream.' and contains several sections:

- Edit Stream:** A button to edit the stream.
- Stream Details Table:**

Stream Id	Build Type	CDS Reference	MMS Reference	Modulation	Carrier Frequency	Transport Type	Path Select	Out Of Band
1	IB SI AND XAIT	1	1	SCTE Mode 1 (64 QAM)	699000000			
- Stream Event Channel:** A table with columns PID, Assoc. Tag, and Prog. Assoc. Tag.
 

PID	Assoc. Tag	Prog. Assoc. Tag
0x401	41	42
- Carousels:** A table with columns Name, Id, PID, Assoc. Tag, and bits/sec.
 

Name	Id	PID	Assoc. Tag	bits/sec
Carousel1	1	0x101	11	10000000
- Services:** A table with columns Name, Title, Content, Service Id, PMT PID, AIT PID, AIT Assoc. Tag, OCAP Source Id, OCAP Service Type, Major/Minor Channel, Scr., Hide, Hide Guide, and Included Carousels. A black circle highlights the 'Edit Content' button below this table.
 

Name	Title	Content	Service Id	PMT PID	AIT PID	AIT Assoc. Tag	OCAP Source Id	OCAP Service Type	Major/Minor Channel	Scr.	Hide	Hide Guide	Included Carousels
Service1	Serv1	FindingNemo	1	0x201	0x301	31	0x1	ATSC Digital TV	100:101	no	no	no	Carousel1
Service2	Serv2	LostInTranslation	2	0x202	0x302	32	0x2	ATSC Digital TV	100:102	no	no	no	Carousel1
- Content:** A table with columns Name, PCR PID, and Component PIDs.
 

Name	PCR PID	Component PIDs
FindingNemo	0x601	0x501, 0x601
LostInTranslation	0x602	0x502, 0x602
fred	0x40	

**Result:** The Manage Content Page opens.

*Continued on next page*

# Edit an A/V Content Component, Continued

- Click the **Edit Component** button on the Manage Content Page and select a component.

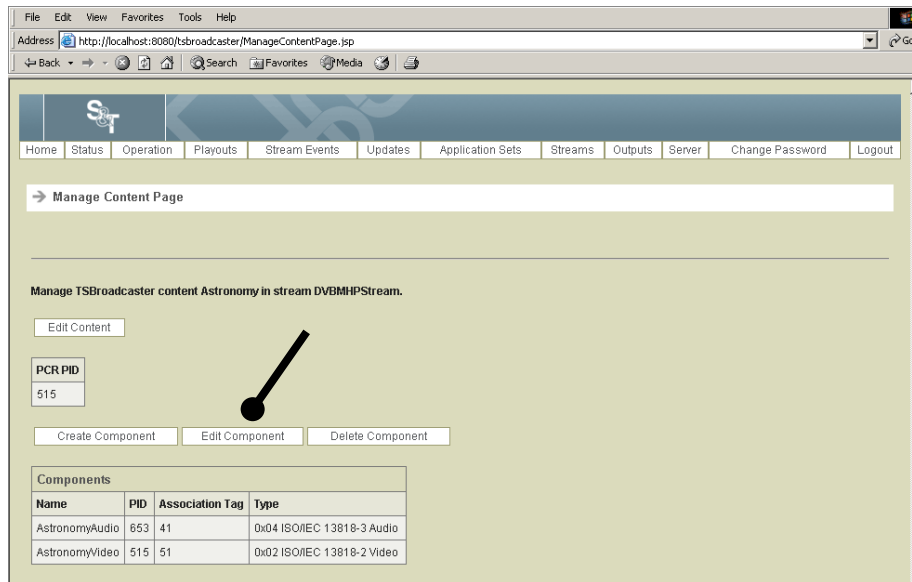

**Result:** The Edit Content Component Page opens.

- Enter the following information on the Create Content Component Page.

<b>Component Name</b>	The name used by TSBroadcaster to refer to the new component
<b>PID</b>	The PID that will be used to carry the component
<b>Association Tag</b>	The association tag to be used to reference the component from a PMT
<b>Type</b>	The stream type of the component: <ul style="list-style-type: none"> <li>• 0x01 ISO/IEC 11172 Video (0x01)</li> <li>• 0x02 ISO/IEC 13818-2 Video</li> <li>• 0x03 ISO/IEC 11172 Audio</li> <li>• 0x04 ISO/IEC 13818-3 Audio</li> <li>• 0x05 ISO/IEC 13818-1 private sections</li> <li>• 0x06 ISO/IEC 13818-1 PES/private data</li> <li>• 0x81 AC3 Audio</li> </ul>

- Click the **Save** button to save the changes to the component.

# Delete an A/V Content Component

## Deleting an A/V Content Component

To delete an A/V Content Component, complete the following steps.

1. Log in to the TSBroadcaster as a user with the appropriate privileges. See **Log In to the TSBroadcaster**, earlier in this chapter.

**Result:** After a successful login, the Home Page opens.

2. Click the **Streams** button from the navigation bar.

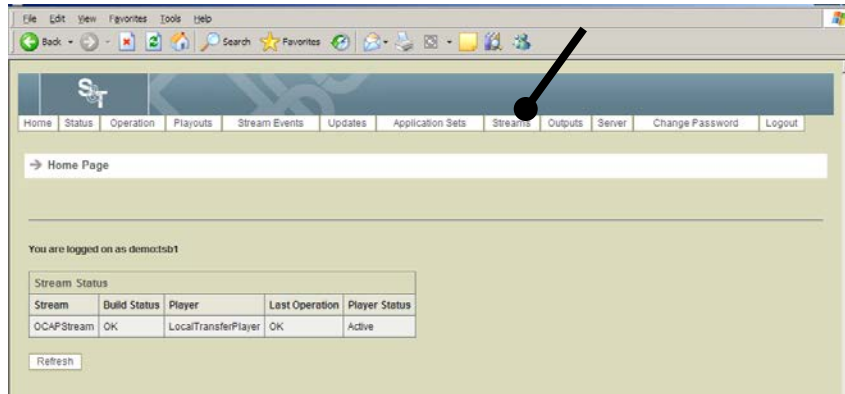

**Result:** The Manage All Streams page opens.

3. Click the **Manage Stream** button on the Manage All Streams Page.

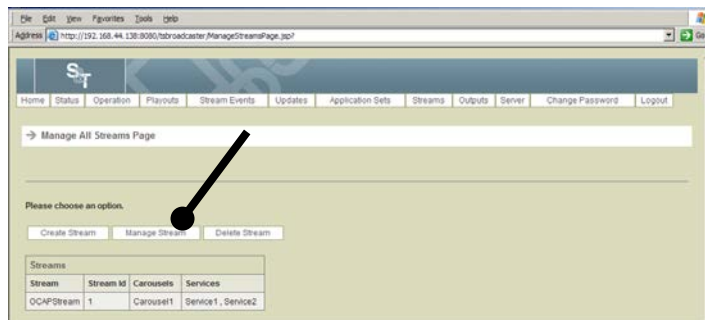

**Result:** The Manage Stream Select Page opens.

# Delete an A/V Content Component, Continued

4. Select the stream for which you want to delete A/V content and click the **Select** button.

**Result:** The Manage OCAP Stream Page opens.

5. Click the **Edit Content** button on the Manage OCAP Stream Page and select the required A/V content.

Address: http://localhost:8080/tsbroadcaster/ManageStreamPage.jsp

Home Status Operation Playouts Stream Events Updates Application Sets Streams Outputs Server Change Password Logout

→ Manage OCAP Stream Page

Manage TSBroadcaster stream OCAPStream.

Edit Stream

Stream Id	Build Type	CDS Reference	MMS Reference	Modulation	Carrier Frequency	Transport Type	Path Select	Out Of Band
1	IB SI AND XAT	1	1	SCTE Mode 1 (64 QAM)	699000000			

Configure Stream Event Channel Clear Stream Event Channel

Stream Event Channel

PID	Assoc. Tag	Prog. Assoc. Tag
0x401	41	42

Create Carousel Edit Carousel Delete Carousel

Carousels

Name	Id	PID	Assoc. Tag	bits/sec
Carousel1	1	0x101	11	10000000

Create Service Edit Service Delete Service

Services

Name	Title	Content	Service Id	PMT PID	AIT PID	AIT Assoc. Tag	OCAP Source Id	OCAP Service Type	Major/Minor Channel	Scr.	Hide	Hide Guide	Included Carousels
Service1	Serv1	FindingNemo	1	0x201	0x301	31	0x1	ATSC Digital TV	100:101	no	no	no	Carousel1
Service2	Serv2	LostInTranslation		0x202	0x302	32	0x2	ATSC Digital TV	100:102	no	no	no	Carousel1

Create Content Edit Content Delete Content

Content

Name	PCR PID	Component PIDs
FindingNemo	0x601	0x501, 0x601
LostInTranslation	0x602	0x502, 0x602
fred	0x40	

**Result:** The Manage Content Page opens.

# Delete an A/V Content Component, Continued

6. Click the **Delete Component** button on the Manage Content Page.

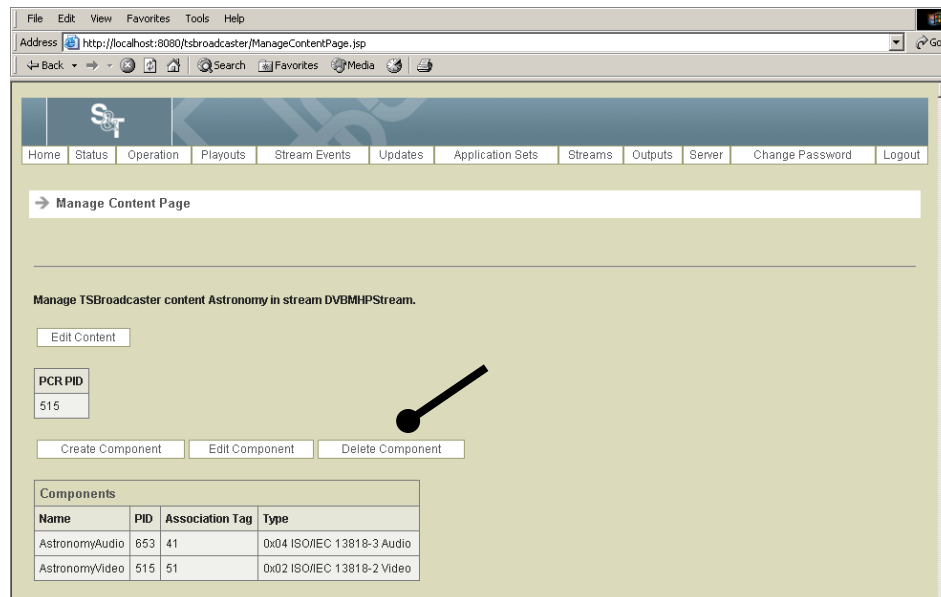

**Result:** The Delete Content Component Page opens.

7. Select the component you wish to delete.
8. Click the **Delete** button to delete the component.

# Log Out of the TSBroadcaster

## Logging Out of the TSBroadcaster

When you have finished using TSBroadcaster, you may simply close your Internet Browser and the session will be closed.

If you wish to switch between users or ensure that the TSBroadcaster cannot be accessed through your browser, click the **Logout** button from the navigation bar. This will terminate your session and return you to the TSBroadcaster Login Page.

# Chapter 4

## Managing Output

### Introduction

The TSBroadcaster allows you to set up and manage Transport Stream output. The different outputs play out the Transport Streams that are defined in the TSBroadcaster. When a Transport Stream is deleted, its outputs are automatically deleted too.

This chapter provides information on creating and modifying players and transfer players.

**Important:** Instructions are provided for creating both a player and a transfer player. The transfer player is used for the OCAP object carousel.

### Types of Output

You can set up several outputs through the TSBroadcaster. The outputs are:

- A player output defines a connection to a TSPlayer that provides continuous payout of a Transport Stream over an ASI connection.
- A transfer player output is an OCAP-specific extension of the player output. It defines a connection to a TSPlayer and an additional transfer interface to an OCAP headend system to transfer out-of-band extended application interface table (XAIT) information when the set of unbound applications is changed.

### In This Chapter

This chapter contains the following topics.

Topic	See Page
Create a Player	4-2
Edit a Player	4-4
Delete a Player	4-5
Re-Send a Player	4-6
Create a Transfer Player	4-7
Edit a Transfer Player	4-9
Delete a Transfer Player	4-10
Re-Send a Transfer Player	4-11
Resend the Latest XAIT Data	4-12

# Create a Player

## Introduction

You can create *players* if you are using *bound* applications or applications that do not need to go out of band. For applications that require XAIT transactions or the CVT code version table, create a *transfer player* instead. We recommend that you create transfer players for all Cisco applications. See **Create a Transfer Player**, next in this chapter.

## Creating a Player

To create a player, complete the following steps.

**Important:** Be sure to enter a password in the password field when you create a player. Leaving the field blank can result in the TSPlayer timing out.

1. Log in to the TSBroadcaster as a user with the appropriate privileges. See **Log In to the TSBroadcaster** in Chapter 3.

**Result:** After a successful login, the Home Page opens.

2. Click the **Outputs** button from the navigation bar.

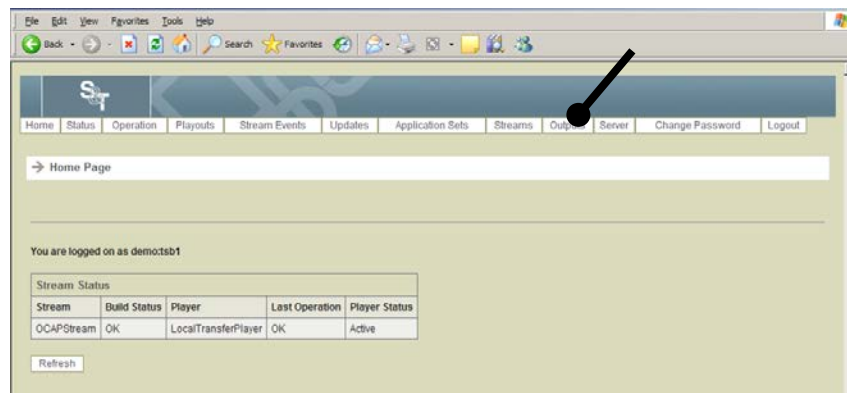

**Result:** The Manage Outputs Page opens.

# Create a Player, Continued

- Click the **Create Player** button on the Manage Outputs Page.

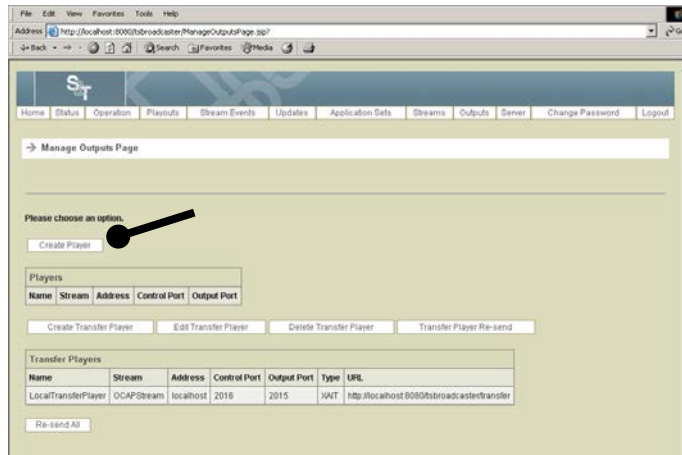

**Result:** The Create Player Page opens.

- Did the system prompt you for a user name?
  - If **yes**, click **Cancel** and go to step 5.
  - If **no**, go to step 5.
- Enter the following information on the Create Player Page.

<b>Player Name</b>	The name used by TSBroadcaster to refer to the new player
<b>Player Stream</b>	The Transport Stream to be played out
<b>Address</b>	The IP address of the TSPlayer
<b>Control Port</b>	The IP port of the TSPlayer used to control the player. For a standard TSPlayer the control port is 2016
<b>Output Port</b>	The IP port of the TSPlayer used to play out the Transport Stream. For a standard TSPlayer the output port is 2015
<b>Password</b>	The password (not echoed) of the TSPlayer. For a standard TSPlayer the password is <b>apw</b> <b>Important:</b> Be sure to enter a password in this field. Leaving this field blank can result in the TSPlayer timing out.

- Click the **Save** button to create a new player.

# Edit a Player

## Editing a Player

To edit a player, complete the following steps.

1. Log in to the TSBroadcaster as a user with the appropriate privileges. See **Log In to the TSBroadcaster**, in Chapter 3.

**Result:** After a successful login, the **Home Page** opens.

2. Click the **Outputs** button from the navigation bar.

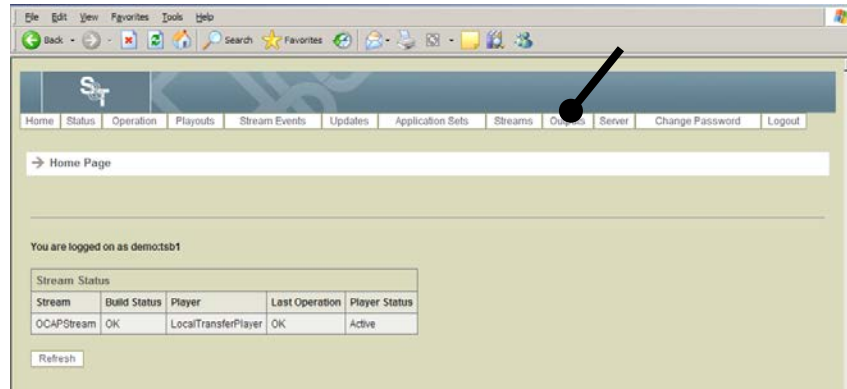

**Result:** The Manage Outputs Page opens.

3. Select the **Edit Player** button on the Manage Outputs Page

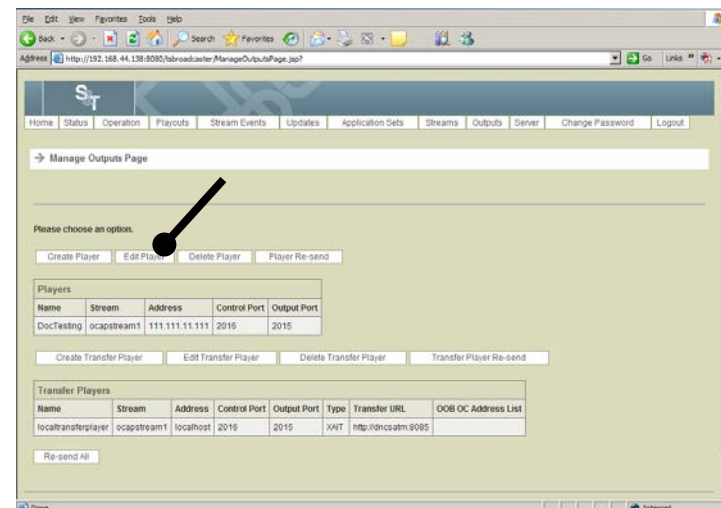

**Result:** The Edit Player Select Page opens.

4. Select the required player and click **Select**.

**Result:** The **Edit Player Page** opens.

5. Make any required changes to the player, and click the **Save** button to save the changes. See **Create a Player**, earlier in this chapter, for the field descriptions.

# Delete a Player

## Deleting a Player

To delete a player, complete the following steps.

1. Log in to the TSBroadcaster as a user with the appropriate privileges. See **Log In to the TSBroadcaster**, in Chapter 3.

**Result:** After a successful login, the Home Page opens.

2. Click the **Outputs** button from the navigation bar.

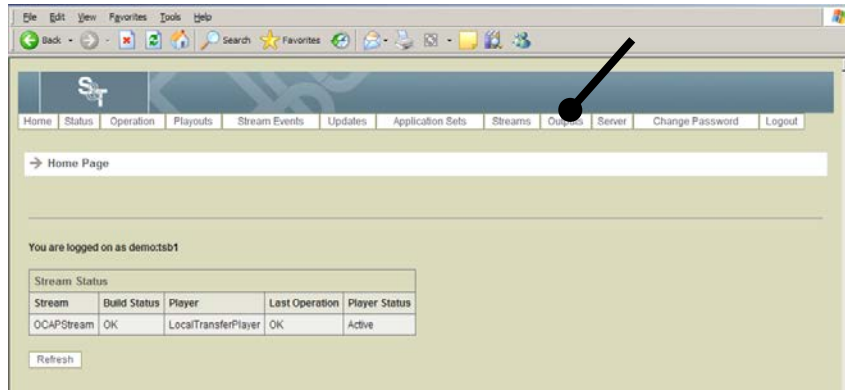

**Result:** The **Manage Outputs Page** opens.

3. Click the **Delete Player** button on the Manage Outputs Page.

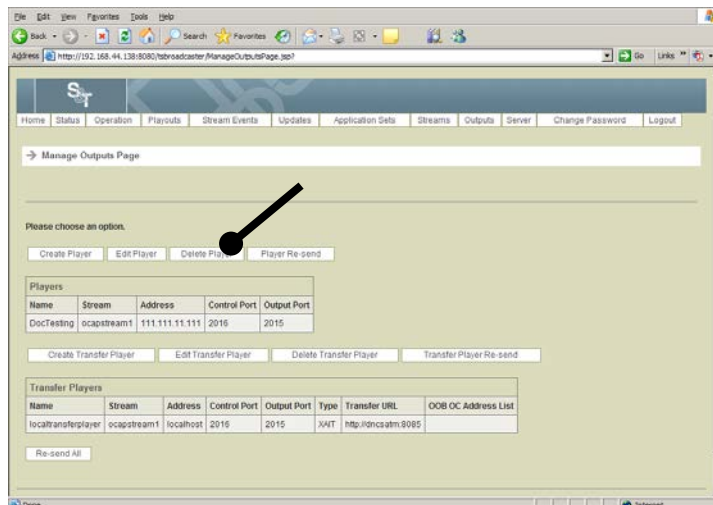

**Result:** The **Delete Player Page** opens.

4. Select the player you wish to delete and click **Delete**.

# Re-Send a Player

## Introduction

At times you may need to re-send a player. For example, you may need to resend the player for testing purposes.

## Re-Sending a Transfer Player

To re-send a player, complete the following steps.

1. Log in to the TSBroadcaster as a user with the appropriate privileges. See **Log In to the TSBroadcaster** in Chapter 3.

**Result:** After a successful login, the Home Page opens.

2. Click the **Outputs** button from the navigation bar.

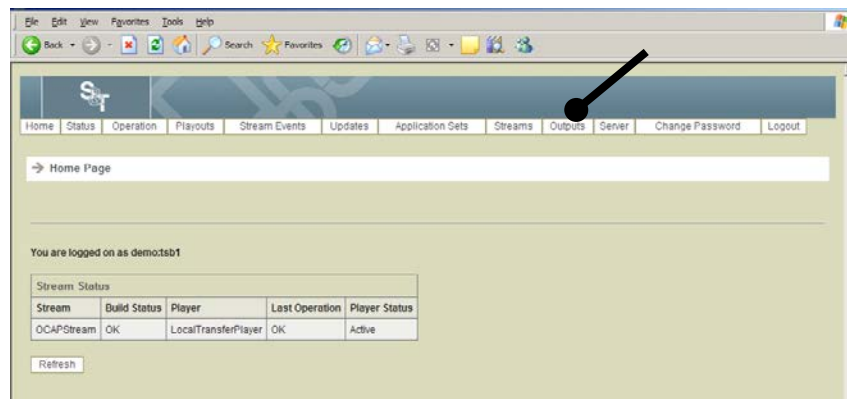

**Result:** The Manage Outputs Page opens.

3. Click the **Player Re-send** button on the Manage Outputs Page.

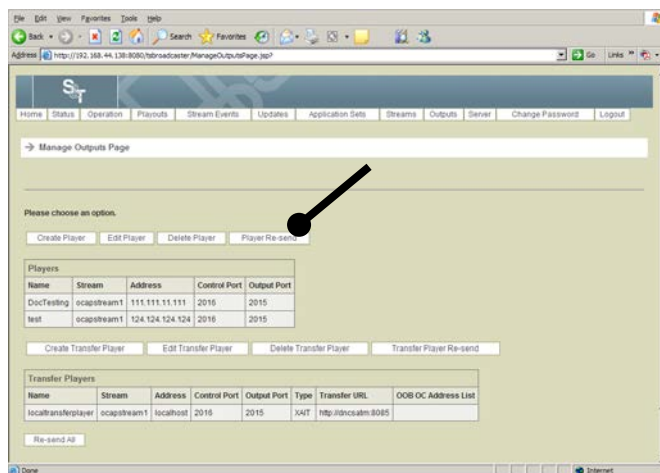

**Result:** The Re-send Player Page opens.

4. Select the player to which you wish to re-send data and click **Re-send** to re-send the last data to the player and across the interface.

# Create a Transfer Player

## Introduction

Create transfer players for applications that require XAIT transactions or the CVT code version table. We recommend that you create transfer players for all Cisco applications.

## Creating a Transfer Player

To create a transfer player, complete the following steps.

**Important:** Be sure to enter a password in the password field when you create a transfer player. Leaving the field blank can result in the TSPlayer timing out.

1. Log in to the TSBroadcaster as a user with the appropriate privileges. See **Log In to the TSBroadcaster** in Chapter 3.

**Result:** After a successful login, the Home Page opens.

2. Click the **Outputs** button from the navigation bar.

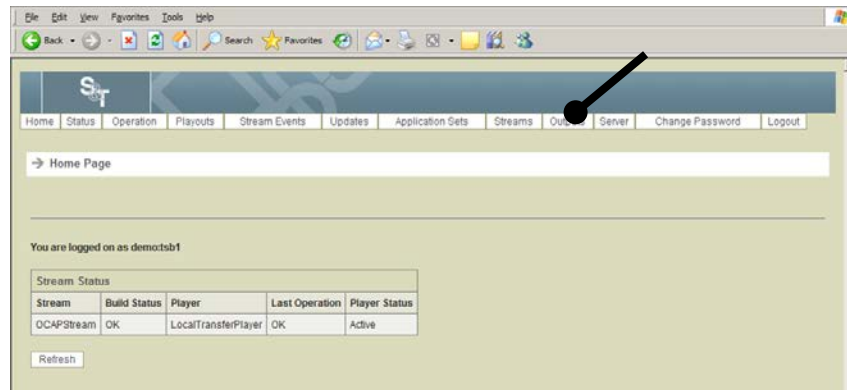

**Result:** The Manage Outputs Page opens.

3. Click the **Create Transfer Player** button on the Manage Outputs Page.

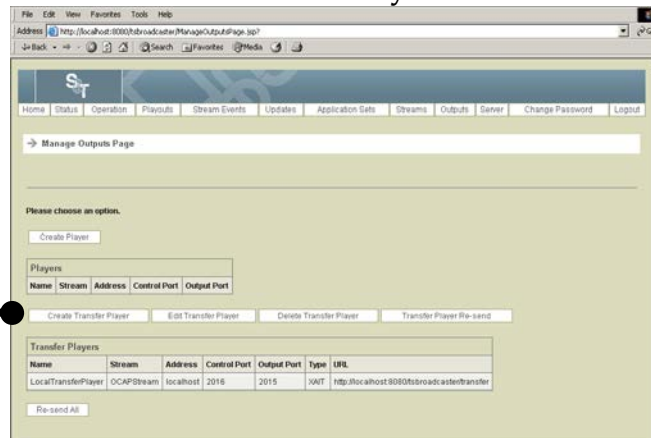

**Result:** The Create Transfer Player Page opens.

## Create a Transfer Player, Continued

4. Enter the following information on the Create Transfer Player Page.

<b>Player Name</b>	The name used by TSBroadcaster to refer to the new transfer player
<b>Player Stream</b>	The Transport Stream to be played out
<b>Address</b>	The IP address of the TSPlayer
<b>Control Port</b>	The IP port of the TSPlayer used to control the player. For a standard TSPlayer the control port is 2016
<b>Output Port</b>	The IP port of the TSPlayer used to play out the Transport Stream. For a standard TSPlayer the output port is 2015
<b>Password</b>	The password (not echoed) of the TSPlayer. For a standard TSPlayer, the password is apw <b>Important:</b> Be sure to enter a password in this field. Leaving this field blank can result in the TSPlayer timing out.
<b>Transfer Type</b>	The type of data that is sent across the transfer interface. Only the XAIT transfer type is available at this time
<b>URL</b>	The URL that implements the transfer interface to the OCAP headend: <a href="http://dnccsatm:8085">http://dnccsatm:8085</a> The URL above ties into the DNCS and the OXAIT manager running on it. When the XAIT changes, the change is notified across this interface The TSBroadcaster provides a loopback transfer interface to allow transfer testing without an OCAP head end, at: <a href="http://address:8080/tsbroadcaster/transfer">http://address:8080/tsbroadcaster/transfer</a> For the address, use the IP address of the TSBroadcaster server. When this interface is used, changes in the XAIT are logged by TSBroadcaster. The transfer interface URL entered in the transfer player must reference the XAIT transfer interface provided on the headend equipment. If you have problems integrating OCAP headend equipment, contact Cisco Services.
<b>OOB OC Address</b>	The broadcast IP address for each set-top network.

5. Click the **Save** button to create a new transfer player.

# Edit a Transfer Player

## Editing a Transfer Player

To edit a transfer player, complete the following steps.

1. Log in to the TSBroadcaster as a user with the appropriate privileges. See **Log In to the TSBroadcaster** in Chapter 3.

**Result:** After a successful login, the Home Page opens.

2. Click the **Outputs** button from the navigation bar.

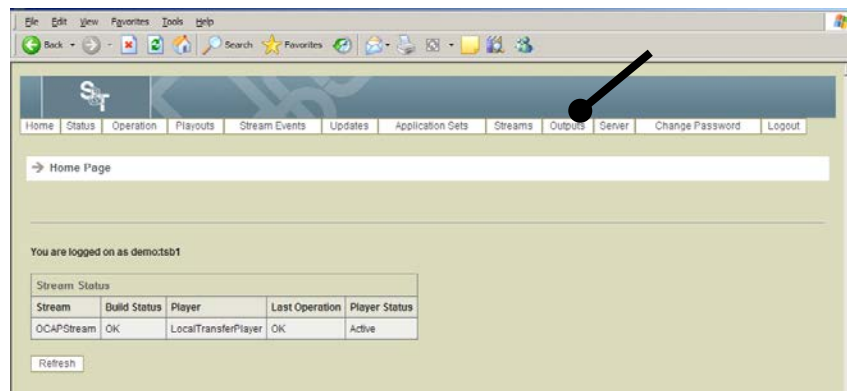

**Result:** The Manage Outputs Page opens.

3. Select the **Edit Transfer Player** button on the Manage Outputs Page

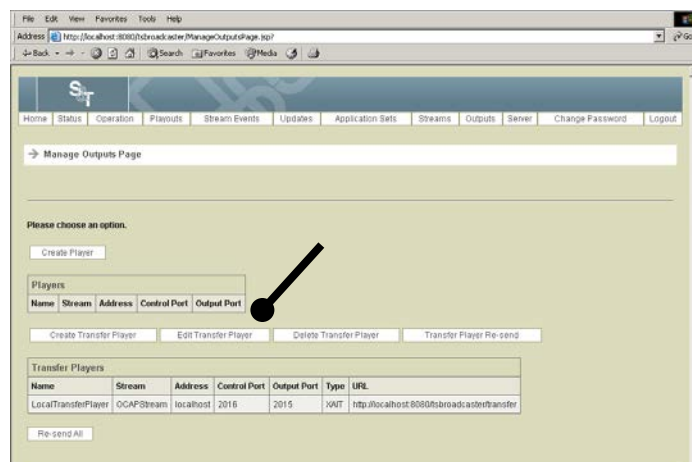

**Result:** The Edit Transfer Player Select Page opens.

4. Select the required transfer player and click **Select**.

**Result:** The Edit Transfer Player Page opens.

5. Make any required changes to the transfer player, and click the **Save** button to save the changes. See **Create a Transfer Player**, earlier in this chapter, for the field descriptions.

# Delete a Transfer Player

## Deleting a Transfer Player

To delete a transfer player, complete the following steps.

1. Log in to the TSBroadcaster as a user with the appropriate privileges. See **Log In to the TSBroadcaster** in Chapter 3.

**Result:** After a successful login, the Home Page opens.

2. Click the **Outputs** button from the navigation bar.

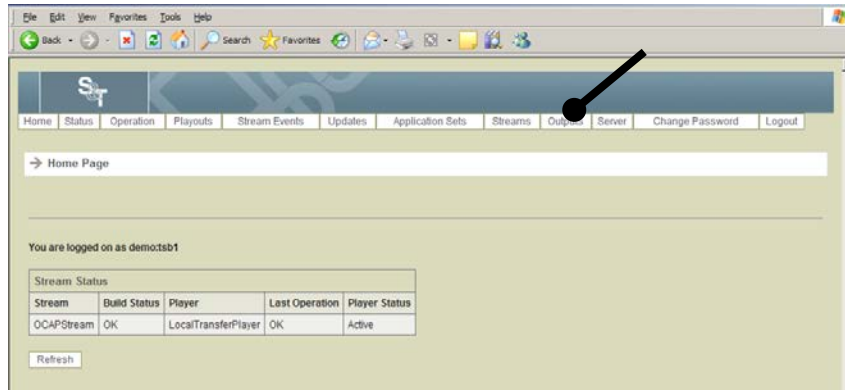

**Result:** The **Manage Outputs Page** opens.

3. Click the **Delete Transfer Player** button on the Manage Outputs Page.

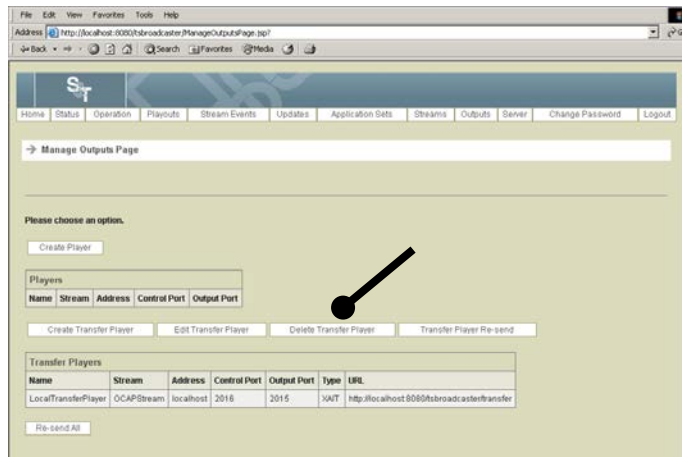

**Result:** The **Delete Transfer Player Page** opens.

4. Select the transfer player you wish to delete and click **Delete**.

# Re-Send a Transfer Player

## Introduction

At times you may need to re-send a transfer player. For example, you may need to resend the transfer player for testing purposes or if the XAIT is lost on the DNCS.

## Re-Sending a Transfer Player

To re-send a transfer player, complete the following steps.

1. Log in to the TSBroadcaster as a user with the appropriate privileges. See **Log In to the TSBroadcaster** in Chapter 3.

**Result:** After a successful login, the **Home Page** opens.

2. Click the **Outputs** button from the navigation bar.

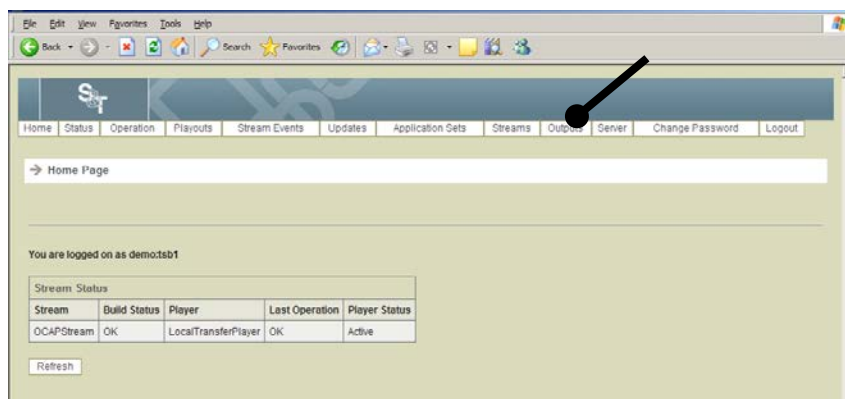

**Result:** The **Manage Outputs Page** opens.

3. Click the **Transfer Player Re-send** button on the Manage Outputs Page.

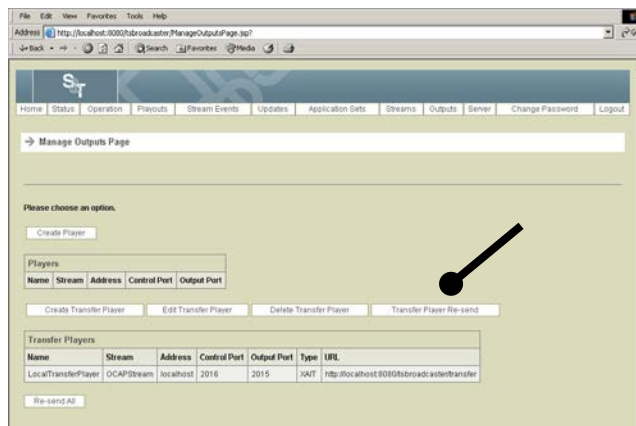

**Result:** The **Re-send Transfer Player Page** opens.

4. Select the transfer player to which you wish to re-send data and click **Re-send** to re-send the last data to the transfer player and across the transfer interface

# Resend the Latest XAIT Data

## Introduction

You can use the Resend All feature to resend the latest XAIT data to the URL specified in the transfer player definition for each transfer player defined. This feature resends the latest inband transport stream build to the inband player specified in each player or transfer player defined. You can use Resend All to bring all the defined outputs up to date or result in an error condition.

## Resending the Latest XAIT Data

To resend the latest XAIT data, complete the following steps.

1. Log in to the TSBroadcaster as a user with the appropriate privileges. See **Log In to the TSBroadcaster** in Chapter 3.  
**Result:** After a successful login, the **Home Page** opens.
2. Click the **Outputs** button from the navigation bar.

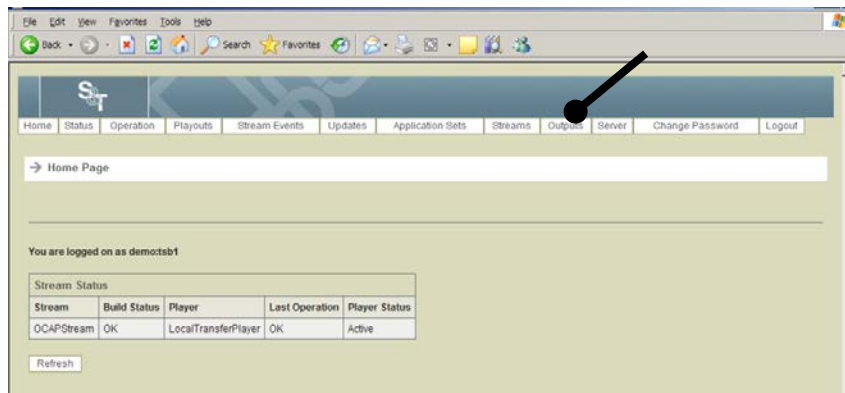

**Result:** The **Manage Outputs Page** opens.

# Resend the Latest XAIT Data, Continued

3. Click the **Re-send All** button on the Manage Outputs Page.

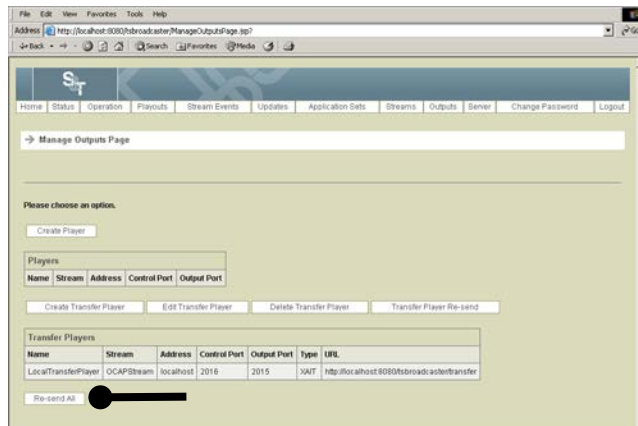

**Result:** The latest inband transport stream build is sent to the inband player specified in each player or transfer player defined and all of the defined outputs are brought up to date.

# Chapter 5

## Managing Application Sets

### Introduction

The TSBroadcaster allows you to create and manage application sets. An application set defines one or more OCAP applications and consists of the following elements:

- A file system containing the application class files, assets, and data. This shows how the application set is deployed in a DSM-CC file system.
- Application signaling that identifies the application(s) carried in the application set. Typically, one application will be signaled in the application set, but more applications may be signaled if required.
- Physical transmission characteristics of the file system, comprising the recommended overall bit rate to be allocated to the application set and a set of groups containing the DSM-CC file system objects. Objects that are placed in the same group will be transmitted together in one or more modules. The TSBroadcaster allows you to define whether the modules carrying a group of objects will be compressed, and it allows you to specify the repetition rate of those modules, relative to the modules of other groups within the application set.

You can use the TSBroadcaster to test and run OCAP applications from any development system, including Java compilers, IDEs and specialized development tools for OCAP. To load an application into the TSBroadcaster, you must copy in the code and data files, and then provide the supporting information needed to transmit and run the application.

### In This Chapter

This chapter contains the following topics.

Topic	See Page
Develop an Application Set	5-3
Edit an Application Set	5-6
Import an Application Set	5-9
File Commands for Application Development	5-12
Create an Application Set	5-24
Add a File to the Application Set	5-26
Delete an Application Set	5-28

## Overview, Continued

<b>Topic</b>	<b>See Page</b>
Download an Application Set	5-29
Modify the DSM-CC File System	5-30
Move Objects for an Application	5-32
Place Objects In or Out of the Carousel	5-34
Add a Directory	5-36
Import a File	5-38
Import a Content Directory	5-40
Add a Stream Event	5-42
Remove an Object from the TSBroadcaster	5-45
Edit an Object	5-47
Edit Object Properties	5-51
Edit a Stream Event	5-56
Remove a Stream Event	5-58
Restore Defaults	5-60
Add a Group	5-62
Move Objects From One Group to Another	5-65
Edit a Group	5-68
Delete a Group	5-70
Set Group Priorities	5-72
Add an Application to an Application Set	5-73
Edit an Application in an Application Set	5-77
Delete an Application from an Application Set	5-79

# Develop an Application Set

## Introduction

You can load an application set by developing it from scratch for initial import into the TSBroadcaster or for an iterative cycle of application set development and testing. To develop an application set, you must have the directory structure on your computer by which the application set will be delivered.

## Developing an Application Set

To develop an application set, complete the following steps.

1. Log in to the TSBroadcaster as a user with the appropriate privileges See **Log In to the TSBroadcaster** in Chapter 3.

**Result:** After a successful login, the Home Page opens.

2. Click the **Application Sets** button from the navigation bar.

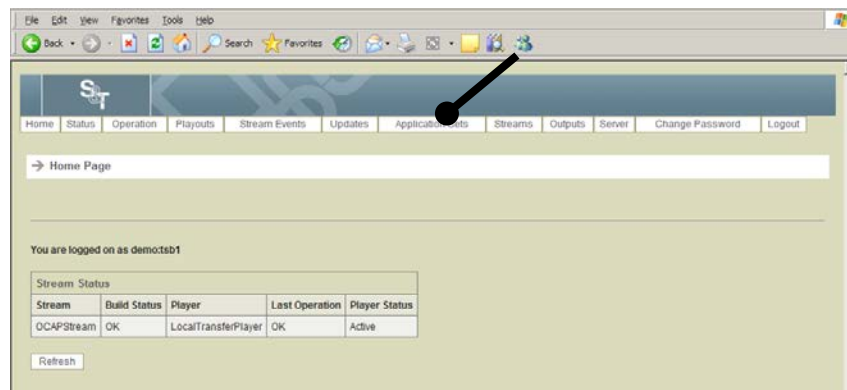

**Result:** The Manage Application Sets Page opens.

# Develop an Application Set, Continued

3. Click the **Develop Application Set** button.

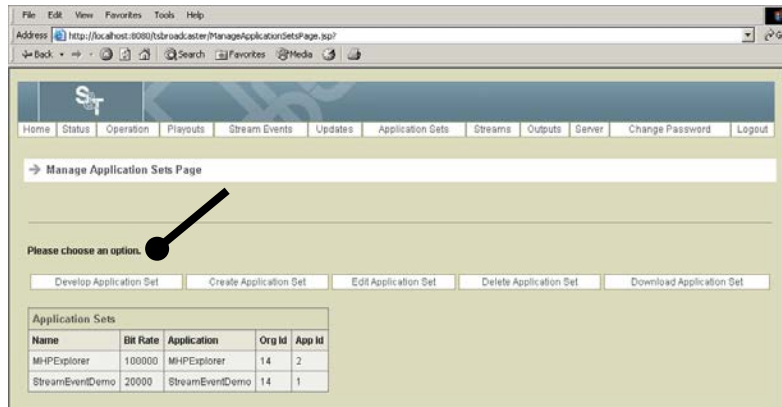

**Result:** The Application Developer Page opens. This page should display an empty file system in the left-hand pane of the Content pane and show only a (Root) directory on the right-hand pane. If this page does not display, see **Java Applet Fails in Chapter 11, Troubleshooting**.

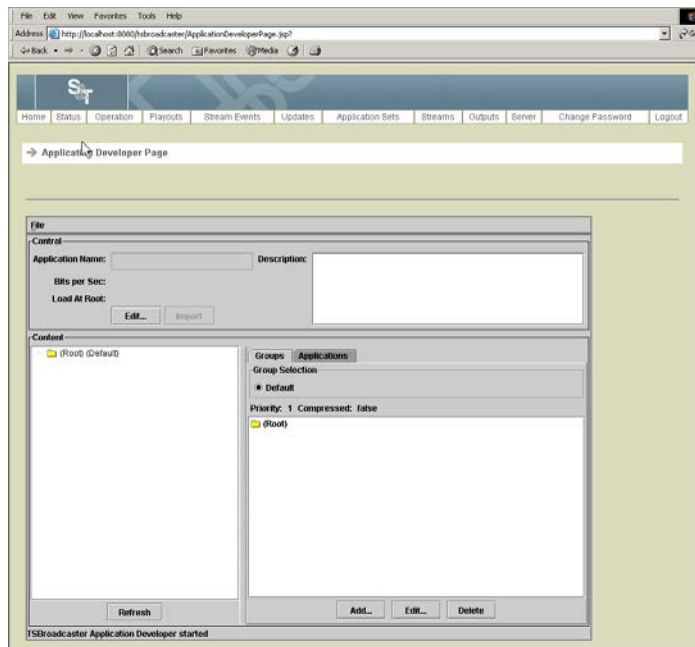

## Develop an Application Set, Continued

4. To add files to the DSM-CC file system, use one of these methods:
  - Drag a directory from a file browser (such as Netscape or Windows Explorer) onto the client machine to the (Root) directory or a directory that you have previously added.

**Note:** This step adds the directory itself and the whole sub-tree of files and sub-directories beneath it to the DSM-CC file system. Using this approach, you cannot modify the structure of the file system underneath the directory that you dragged in; however, if you add or remove files under that directory on the client machine, the changes will automatically be included every time you update the application set. If you are importing Java classes into a DSM-CC file system, this method is better. With this method, new classes that are generated as a result of code changes are automatically picked up, and it is unlikely that you will want to change the class structure manually.

- Right-click on the (Root) directory, select **Add Directory** and supply the directory name, and then click **OK** to create a DSM-CC directory.

**Note:** You can then build up the file system by dragging files over the icon of the new directory, and use Add Directory to add further sub-directories to the new directory. Subsequently, you can add and remove files and directories individually and you can drag any file or directory to a new location. If you are building a DSM-CC file system from disparate sources, then manually creating the directories is a better option. This method is better because you can drag files in from different locations and subsequently modify the file structure.

**Result:** The selected files will be placed into the root directory of the DSM-CC file system.

5. To move the objects around in the DSM-CC file system, select the objects and drag them over the icon of the directory where you want them. Objects that you can move are marked with a red dot.

# Edit an Application Set

## Introduction

You can edit an application set to give it a name and to specify whether to load the application at the root directory. You can use this feature when a file structure has already been defined for the application set, and you want to edit the contents of the application set.

## Editing an Application Set

To edit an application set, complete the following steps.

1. Log in to the TSBroadcaster as a user with the appropriate privileges. See **Log In to the TSBroadcaster** in Chapter 3.

**Result:** After a successful login, the Home Page opens.

2. Click the **Application Sets** button from the navigation bar.

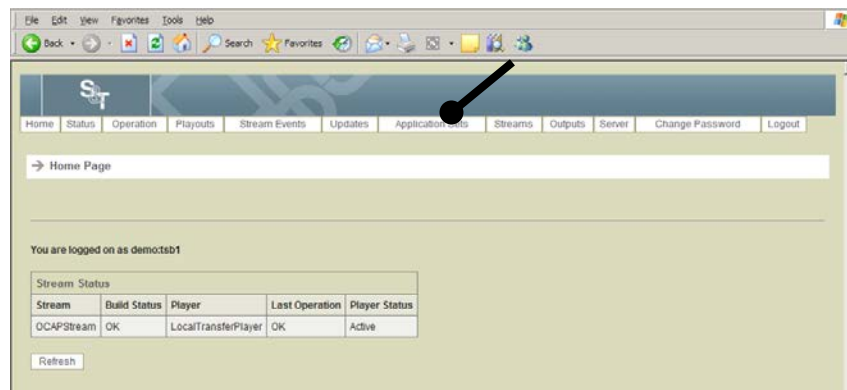

**Result:** The Manage Application Sets Page opens.

## Edit an Application Set, Continued

3. Click the **Develop Application Set** button.

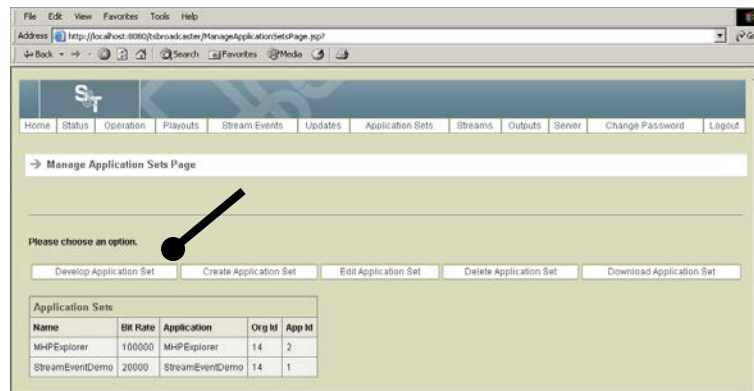

**Result:** The Application Developer Page opens.

4. Select the row that contains the application you want to edit.

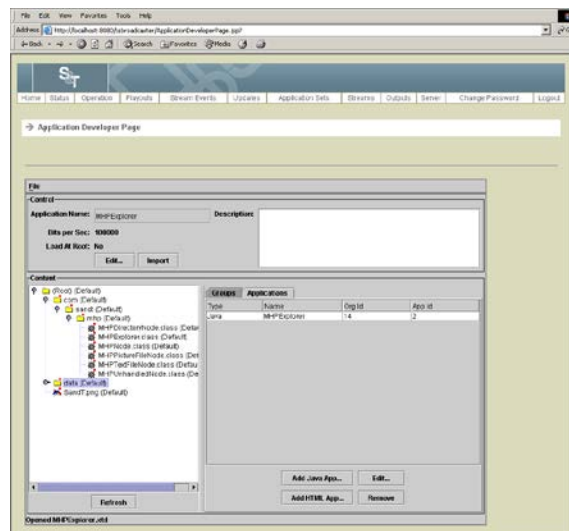

5. Click the **Edit** button.

**Result:** The Edit Application Attributes Page opens.

## Edit an Application Set, Continued

6. Enter the following information on the Edit Application Attributes Page.

<b>Application Name</b>	The name of the application set. This is a modifiable drop down list. You can select the name of an existing application set to overwrite it when you import this one, or you can choose a new name to create a new application set
<b>Description</b>	A description of the application set
<b>Bits per Sec</b>	The recommended bit rate for this application set
<b>Load at Root</b>	<p>A check box to indicate whether to load the application into the root of the object carousel or into its own directory below the root directory. When an application set is not loaded at the root, the application set is placed in its own directory (named after the Application Name) of the object carousel service gateway. The base directory attribute of the application signaling is also modified to reflect the new location</p> <p><b>Note:</b> Typically, you should not load OCAP application sets at the root. Each set should have an independent file system in its own directory.</p>

7. Click the **OK** button to save the changes to the application set.

# Import an Application Set

## Introduction

You can import the application set into TSBroadcaster if you have completed the following steps:

- Defined the DSM-CC file system
- Defined the group structure (or use the default)
- Defined the stream events
- Defined application set characteristics

## Importing an Application Set

To import an application set, complete the following steps.

1. Log in to the TSBroadcaster as a user with the appropriate privileges. See **Log In to the TSBroadcaster** in Chapter 3.

**Result:** After a successful login, the Home Page opens.

2. Click the **Application Sets** button from the navigation bar.

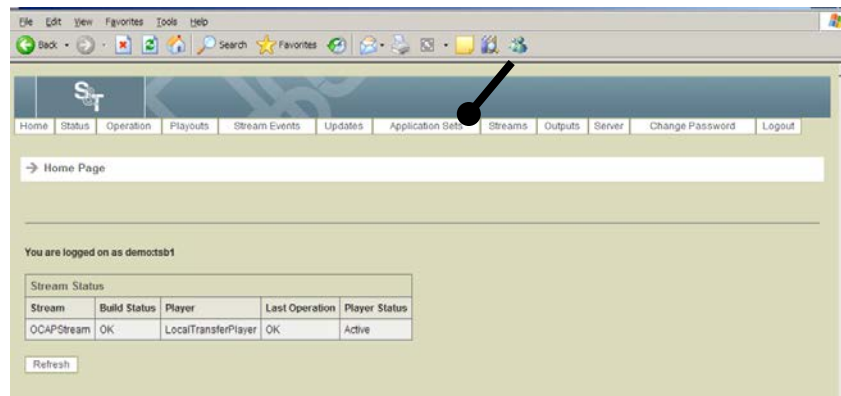

**Result:** The Manage Application Sets Page opens.

# Import an Application Set, Continued

3. Click the **Develop Application Set** button.

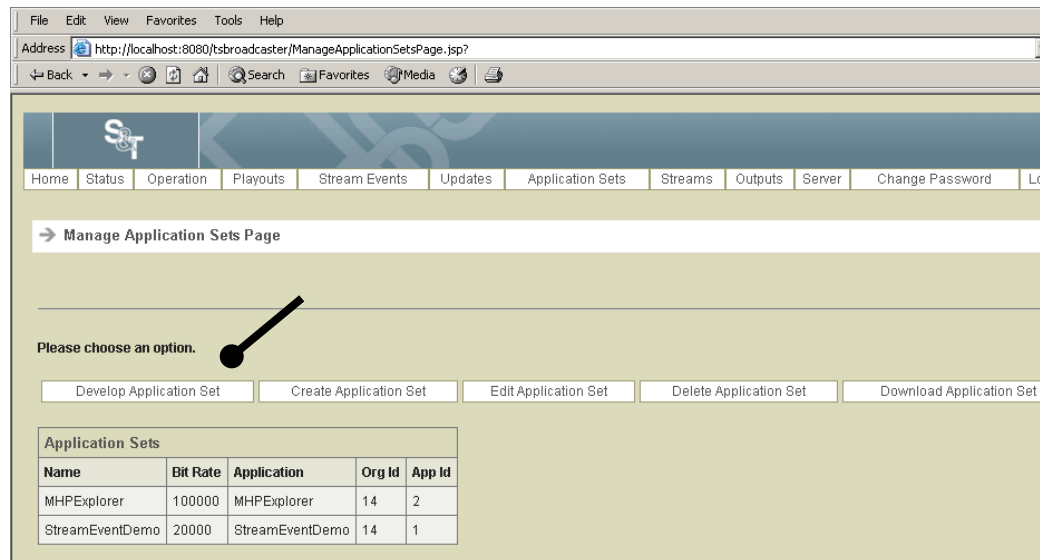

**Result:** The Application Developer Page opens.

# Import an Application Set, Continued

4. Click the **Import** button.

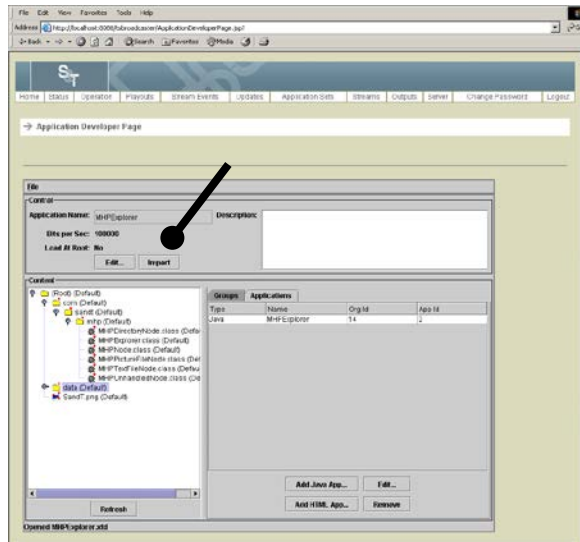

**Result:** If you have not saved the configuration that you are importing as a “project” on the client machine, the TSBroadcaster prompts you to save the project configuration as a file with extension **.xtd**. You can at that point save the project, decline the offer, or cancel the entire import operation.

The path of the project file must not contain any spaces; otherwise the file will fail to load when subsequently opened.

## Notes:

- If you save the project file in a directory containing the client files and directories that you have included, the project file will contain only relative paths, which makes the project more portable.
- The TSBroadcaster will ask you to confirm that you want to create a new application set or overwrite an existing one. If you confirm, the TSBroadcaster imports and saves the new application set.
- If you overwrite an application set while it is being played out, the application will be automatically updated in the output stream. So by keeping the Application Developer Page open while you are developing and testing an application set, you can make changes to your code and the file system, and then select Import to load the new changes immediately.

# File Commands for Application Development

## Introduction

This section covers the following file commands that you can use while you are developing applications:

- Open a File
- Create New File
- Close a File
- Save a File
- Save a File to Specified Location
- Export a File

## Open a File

To open a project file that you have previously saved to the client machine, complete the following steps.

1. Log in to the TSBroadcaster as a user with the appropriate privileges. See **Log In to the TSBroadcaster** in Chapter 3.

**Result:** After a successful login, the Home Page opens.

2. Click the **Application Sets** button from the navigation bar.

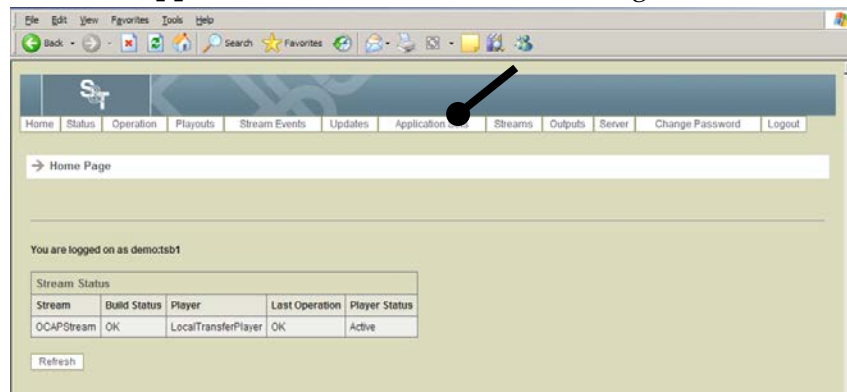

**Result:** The Manage Application Sets Page opens.



# File Commands for Application Development, Continued

## Create a New File

To reset the application developer back to its original state, you can create a new file. To create a new file, complete the following steps.

1. Log in to the TSBroadcaster as a user with the appropriate privileges. See **Log In to the TSBroadcaster** in Chapter 3.

**Result:** After a successful login, the Home Page opens.

2. Click the **Application Sets** button from the navigation bar.

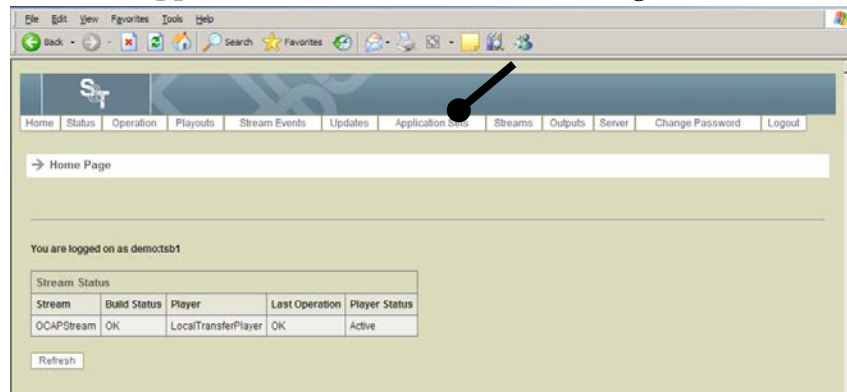

**Result:** The Manage Application Sets Page opens.



# File Commands for Application Development, Continued

## Close a File

You can also reset the application developer back to its original state by closing a file. To close a file, complete the following steps.

1. Log in to the TSBroadcaster as a user with the appropriate privileges. See **Log In to the TSBroadcaster** in Chapter 3.

**Result:** After a successful login, the Home Page opens.

2. Click the **Application Sets** button from the navigation bar.

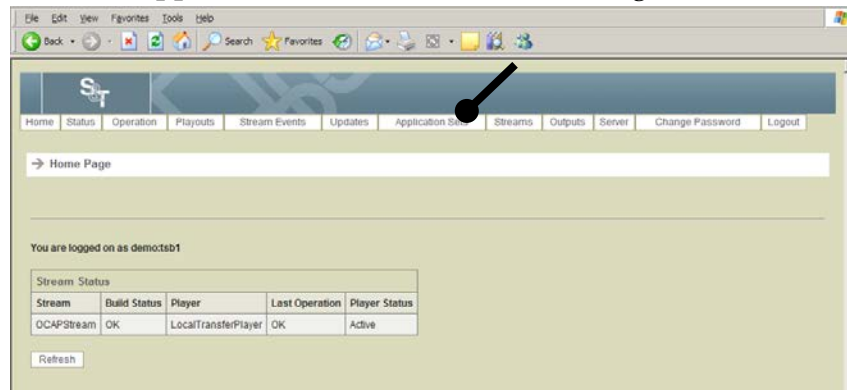

**Result:** The Manage Application Sets Page opens.

# File Commands for Application Development, Continued

3. Click the **Develop Application Set** button.

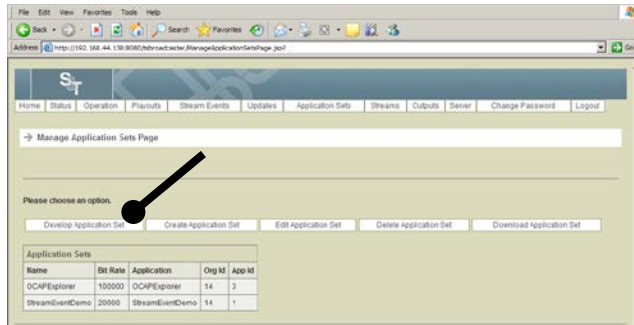

**Result:** The Application Developer Page opens.

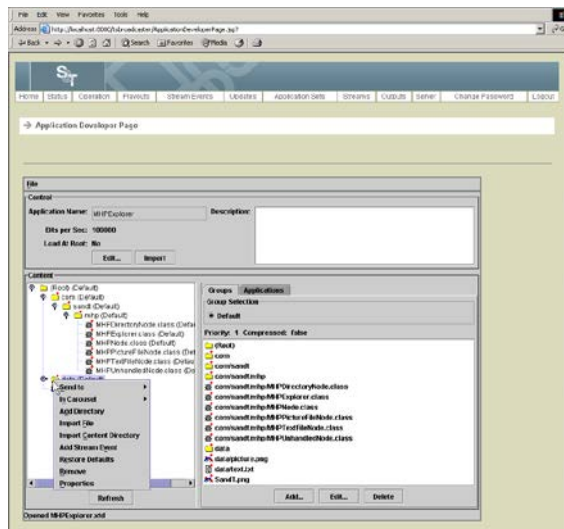

4. Make sure the **Applications** tab is selected, and select **File** and then **Close**.

**Result:** The Application Developer Page is cleared and returns to its original state.

# File Commands for Application Development, Continued

## Save a File

To save a project file, complete the following steps.

1. Log in to the TSBroadcaster as a user with the appropriate privileges. See **Log In to the TSBroadcaster** in Chapter 3.

**Result:** After a successful login, the Home Page opens.

2. Click the **Application Sets** button from the navigation bar.

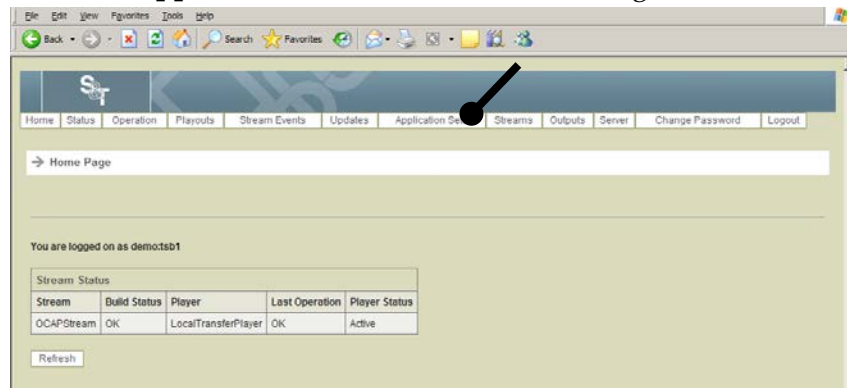

**Result:** The Manage Application Sets Page opens.



# File Commands for Application Development, Continued

## Save a File in a Specified Location

To save a project file in a specified location, complete the following steps.

1. Log in to the TSBroadcaster as a user with the appropriate privileges. See **Log In to the TSBroadcaster** in Chapter 3.

**Result:** After a successful login, the Home Page opens.

2. Click the **Application Sets** button from the navigation bar.

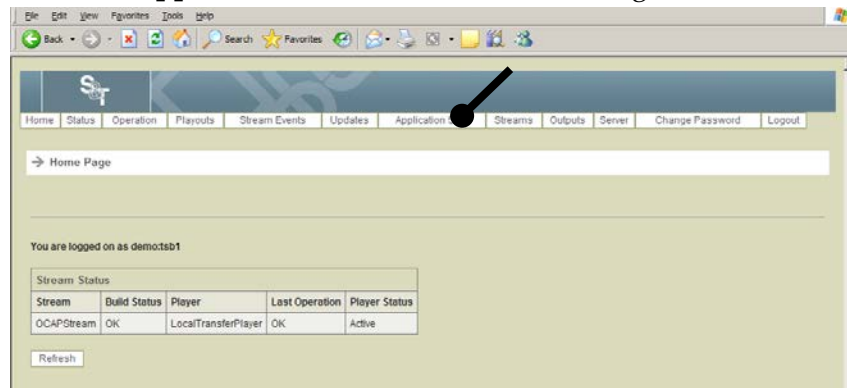

**Result:** The Manage Application Sets Page opens.

## File Commands for Application Development, Continued

3. Click the **Develop Application Set** button.

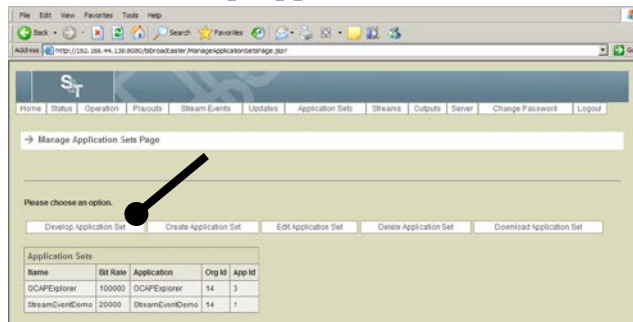

**Result:** The Application Developer Page opens.

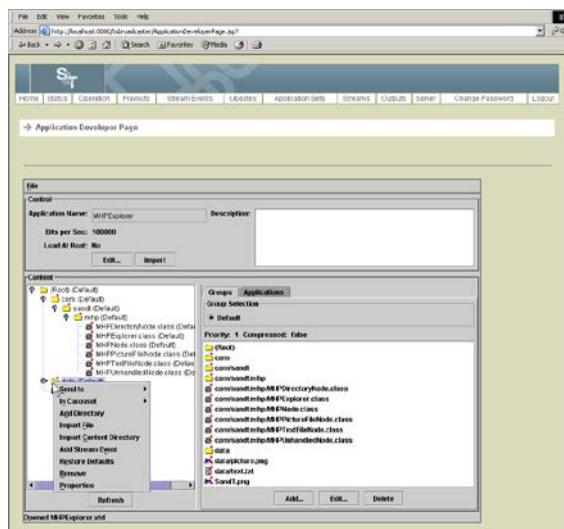

4. Make sure the Applications tab is selected, and select **File** and then **Save As**.

**Result:** The TSBroadcaster prompts you to save the project configuration as a file with extension `.xtd`.

5. Select the file you want to save and click **Save**.

**Result:** The file is saved with an `xtd` extension.

# File Commands for Application Development, Continued

## Export a File

To save the application set itself in a format that can be distributed to other TSBroadcasters with minimal effort, you can export a file. To export a file, complete the following steps.

1. Log in to the TSBroadcaster as a user with the appropriate privileges. See **Log In to the TSBroadcaster** in Chapter 3.

**Result:** After a successful login, the Home Page opens.

2. Click the **Application Sets** button from the navigation bar.

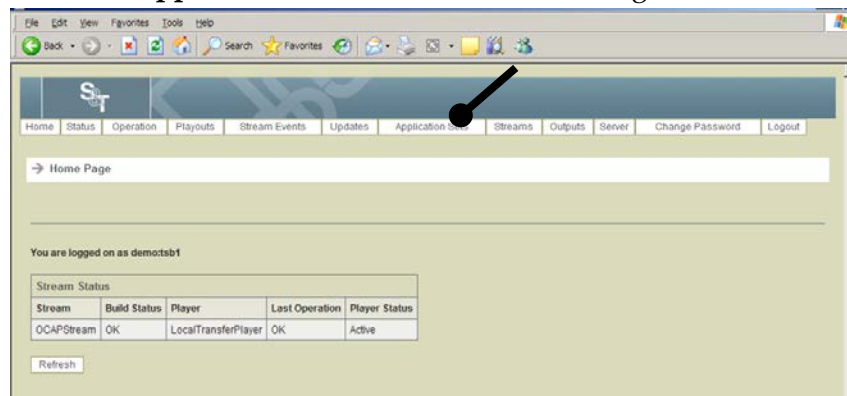

**Result:** The Manage Application Sets Page opens.

## File Commands for Application Development, Continued

3. Click the **Develop Application Set** button.

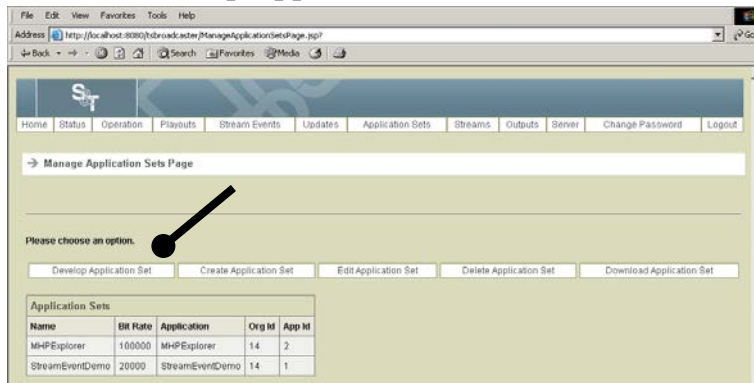

**Result:** The Application Developer Page opens.

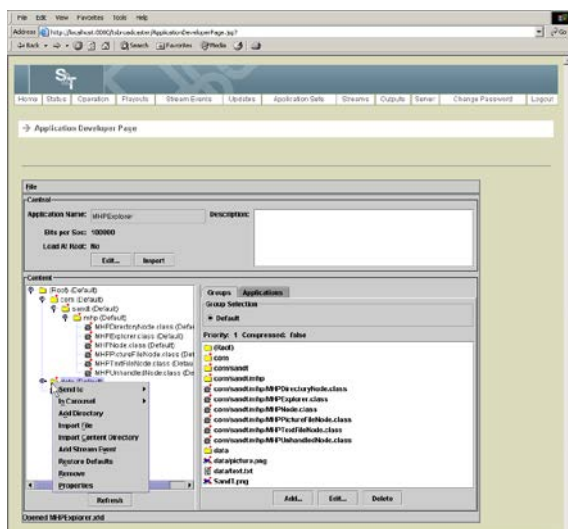

4. Make sure the Applications tab is selected, and select **File** and then **Export**.

**Result:** The TSBroadcaster prompts you to save the application set as a file with extension .zip.

5. Select the file you want to save and click **Save**.

**Result:** The file is saved with an xtd extension.

# Create an Application Set

## Introduction

The Create Application Set function in the TSBroadcaster allows you to import a *distributed* application set with minimal effort. You can use this feature to bring in a zip file that contains a set of application files and the parameters for the files. Do not confuse “create an application set” with “develop an application set” or with “download an application set.” The Develop Application Set function is where you actually create the application sets. The Download Application Set is where you distribute the application sets that you have created.

## Prerequisite

To create an application set, you must first develop an application set and create a definition file.

## Creating an Application Set

To create an application set, complete the following steps.

1. Log in to the TSBroadcaster as a user with the appropriate privileges. See **Log In to the TSBroadcaster** in Chapter 3.

**Result:** After a successful login, the Home Page opens.

2. Click the **Application Sets** button from the navigation bar.

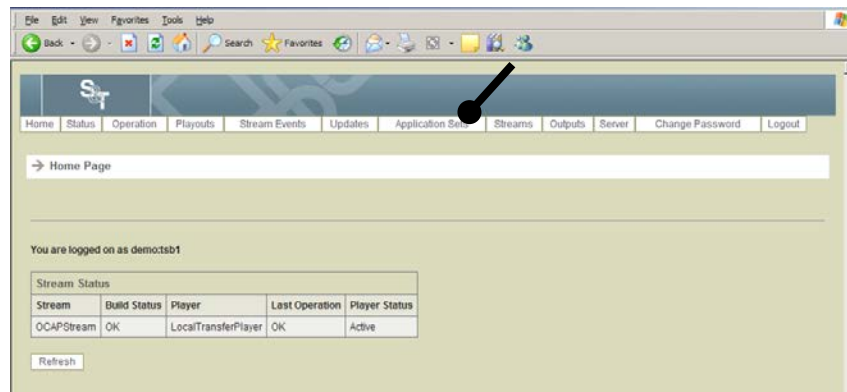

**Result:** The Manage Application Sets Page opens.

# Create an Application Set, Continued

3. Click the **Create Application Set** button.

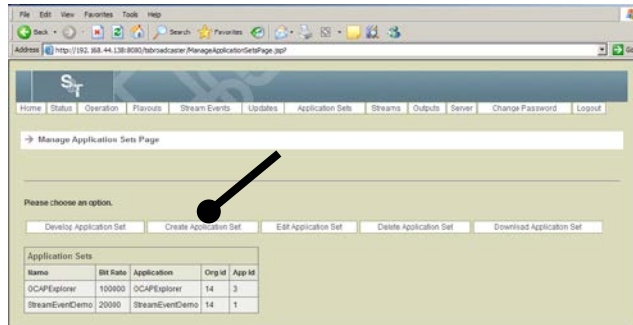

**Result:** The Create Application Set Page opens.

4. Enter the following information on the Create Application Set Page.

<b>Application Set Name</b>	The name of the application set
<b>Description</b>	A description of the application set
<b>Definition File</b>	<p>The file path from which the application set definition will be read. You can create a definition file in two ways:</p> <ul style="list-style-type: none"> <li>• By using the <b>File&lt;Export</b> menu item in the Application Developer Page</li> <li>• By clicking the <b>Download Application Set</b> button on the Manage Application Sets Page</li> </ul>
<b>Load At Root</b>	<p>A check box to indicate whether to load the application into the root of the object carousel or into its own directory below the root directory. When an application set is not loaded at the root, the application set is placed in its own directory (named after the Application Name) of the object carousel service gateway. The base directory attribute of the application signaling is also modified to reflect the new location</p> <p><b>Note:</b> Typically, you should not load OCAP application sets at the root. Each set should have an independent file system in its own directory.</p>

5. Click the **Save** button to create a new application set.

# Add a File to the Application Set

## Adding a File to the Application Set

To add a file to the application set, complete the following steps.

1. Log in to the TSBroadcaster as a user with the appropriate privileges. See **Log In to the TSBroadcaster** in Chapter 3.

**Result:** After a successful login, the Home Page opens.

2. Click the **Application Sets** button from the navigation bar.

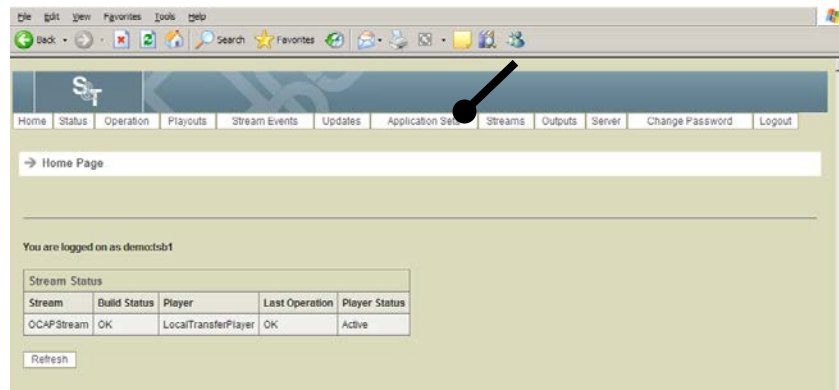

**Result:** The Manage Application Sets Page opens.

3. Click the **Edit Application Set** button.

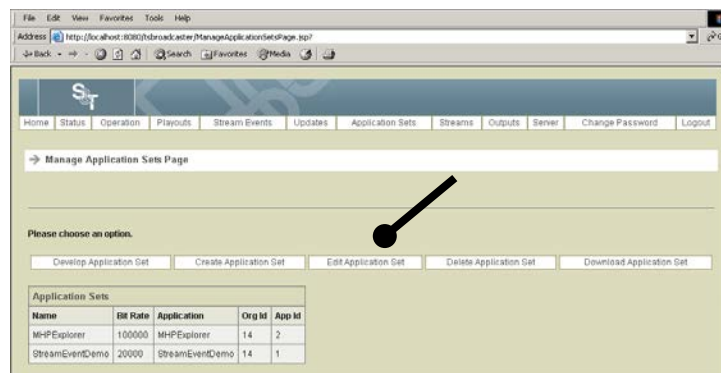

**Result:** The Edit Application Set Select Page opens.

## Add a File to the Application Set, Continued

4. Select the application set you want to edit and click **Select**.

**Result:** The Edit Application Set Page opens.

5. Enter the following information on the Edit Application Set Page.

<b>Application Set Name</b>	The name of the application set
<b>Description</b>	A description of the application set
<b>Definition File</b>	The file path from which the application set definition will be read. You can create a definition file in two ways: <ul style="list-style-type: none"><li>• By using the <b>File&lt;Export</b> menu item in the Application Developer Page</li><li>• By clicking the <b>Download Application Set</b> button on the Manage Application Sets Page</li></ul>
<b>Load At Root</b>	A checkbox defining whether this application is to be loaded at the root of the object carousel file system, or under its own directory  <b>Note:</b> This value should match the setting chosen when developing the application.

6. Click the **Save** button to save any changes to the application set.

# Delete an Application Set

## Deleting an Application Set

To delete an application set, complete the following steps.

1. Log in to the TSBroadcaster as a user with the appropriate privileges. See **Log In to the TSBroadcaster** in Chapter 3.

**Result:** After a successful login, the Home Page opens.

2. Click the **Application Sets** button from the navigation bar.

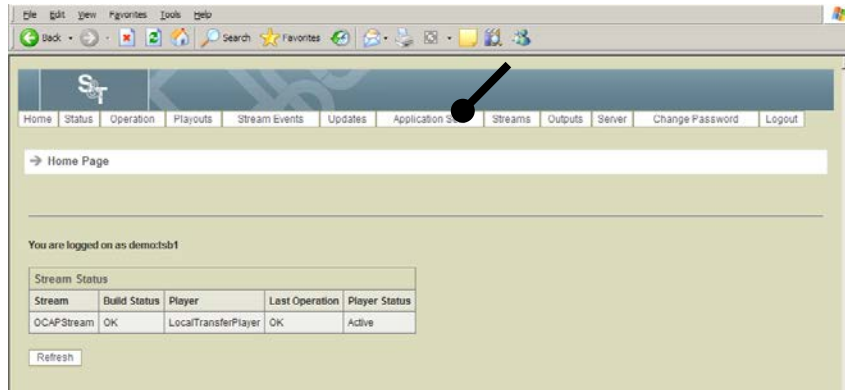

**Result:** The Manage Application Sets Page opens.

3. Click the **Delete Application Set** button to delete the application set.

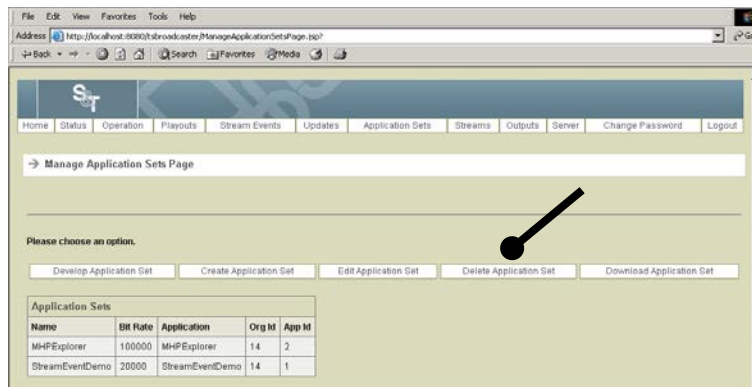

# Download an Application Set

## Introduction

Use this procedure to distribute an application set that has already been developed in a format that can be loaded into other TSBroadcasters with minimal effort. This feature allows you to obtain a zipped copy of the application set on the server.

## Downloading an Application Set

To download an application set, complete the following steps.

1. Log in to the TSBroadcaster as a user with the appropriate privileges. See **Log In to the TSBroadcaster** in Chapter 3.

**Result:** After a successful login, the **Home Page** opens.

2. Click the **Application Sets** button from the navigation bar.

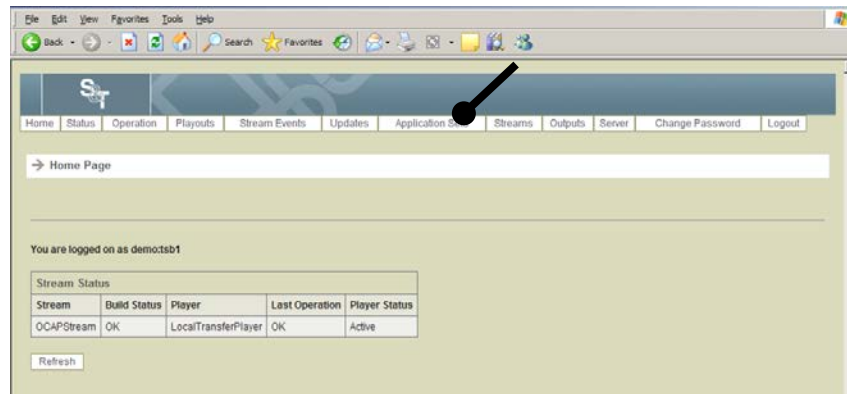

**Result:** The Manage Application Sets Page opens.

3. Click the **Download Application Set** button.

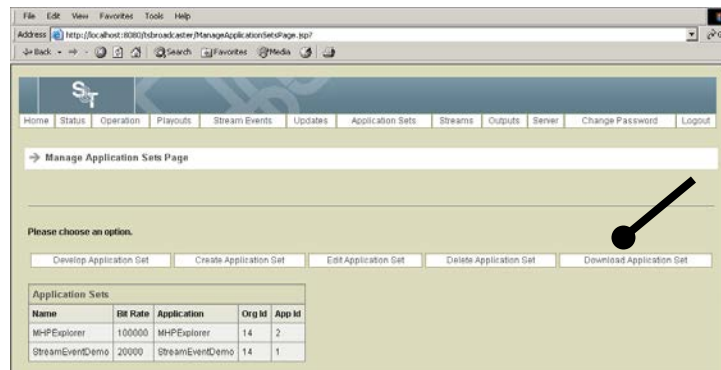

**Result:** The Download Application Set Selection Page opens.

4. Select the application set you wish to download and click **Download**.

**Result:** The system prompts you whether you want to open or save the file.

5. Click **Save** to save the file to the desired location.

# Modify the DSM-CC File System

## Modifying the DSM-CC File System

To modify the DSM-CC file system, complete the following steps.

1. Log in to the TSBroadcaster as a user with the appropriate privileges. See **Log In to the TSBroadcaster** in Chapter 3.

**Result:** After a successful login, the Home Page opens.

2. Click the **Application Sets** button from the navigation bar.

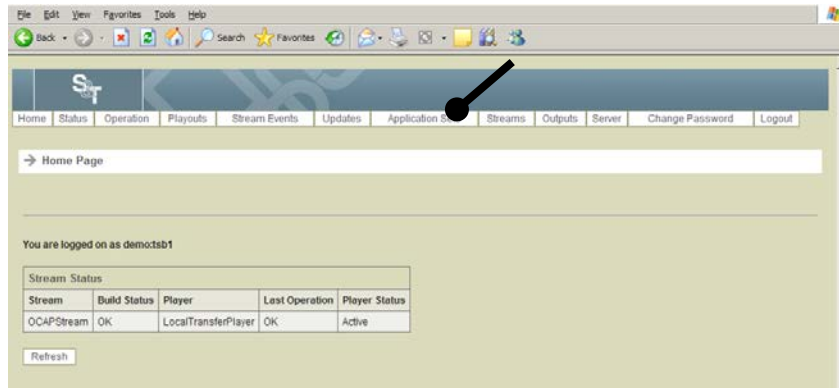

**Result:** The Manage Application Sets Page opens.

3. Click the **Develop Application Set** button.

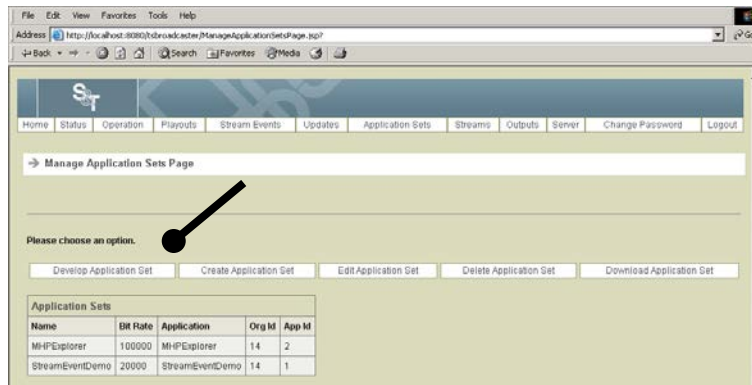

**Result:** The Application Developer Page opens.

# Modify the DSM-CC File System, Continued

4. Make sure the Applications tab is selected. Select the file system object you want to modify, and right-click to display a pop-up menu.

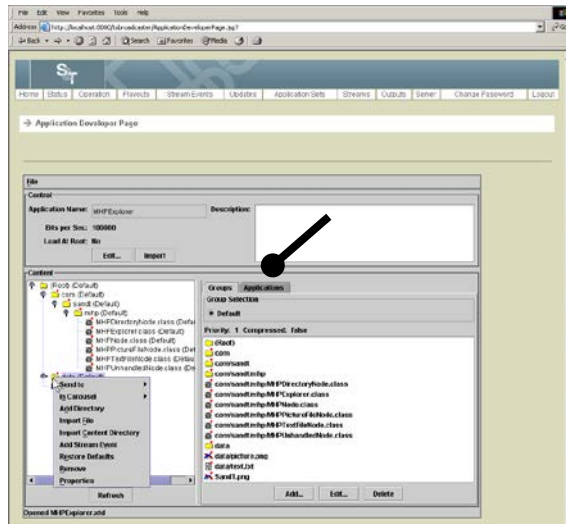

5. Use the options on the pop-up menu to modify the DSM-CC file system as needed.

# Move Objects for an Application

## Moving Objects

To move an object in the directory structure for an application, complete the following steps.

1. Log in to the TSBroadcaster as a user with the appropriate privileges. See **Log In to the TSBroadcaster** in Chapter 3.

**Result:** After a successful login, the Home Page opens.

2. Click the **Application Sets** button from the navigation bar.

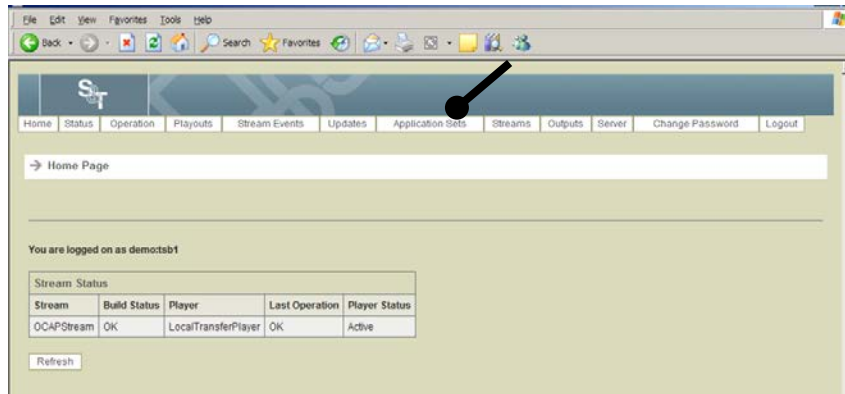

**Result:** The Manage Application Sets Page opens.

# Move Objects for an Application, Continued

3. Click the **Develop Application Set** button.

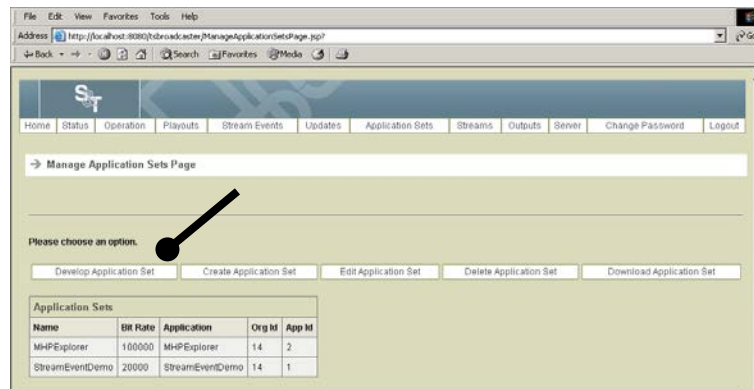

**Result:** The Application Developer Page opens.

4. Make sure the Applications tab is selected and then select the file system object you want to modify, and right-click to display a pop-up menu.

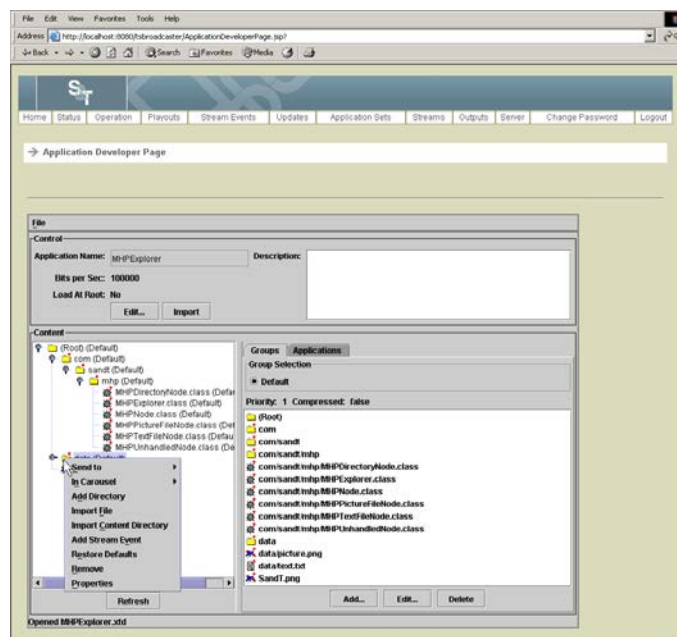

5. Select **Send to** and move the object into the group you select.

# Place Objects In or Out of the Carousel

## Placing Objects In or Out of the Carousel

To place objects in or out of the carousel, complete the following steps.

**Note:** The root object is always included in the carousel and cannot be removed.

1. Log in to the TSBroadcaster as a user with the appropriate privileges. See **Log In to the TSBroadcaster** in Chapter 3.

**Result:** After a successful login, the Home Page opens.

2. Click the **Application Sets** button from the navigation bar.

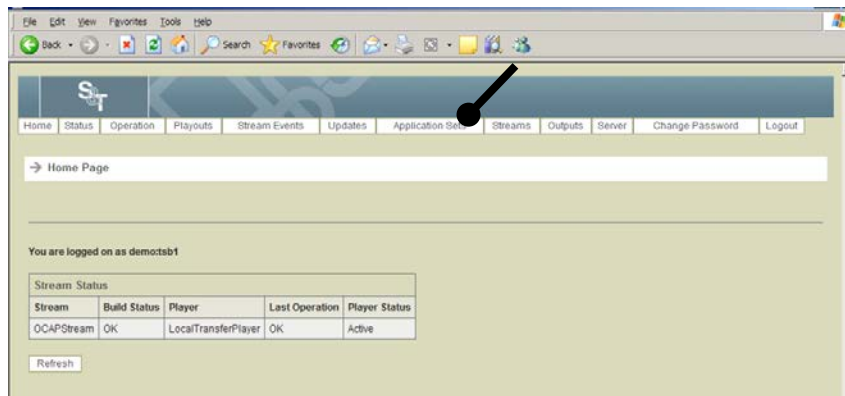

**Result:** The Manage Application Sets Page opens.

3. Click the **Develop Application Set** button.

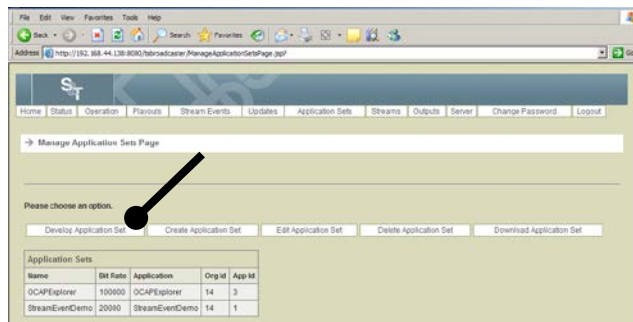

**Result:** The Application Developer Page opens.

## Place Objects In or Out of the Carousel, Continued

- From the left pane, select the file system object you want to place in the carousel, and right-click to call up a pop-up menu.

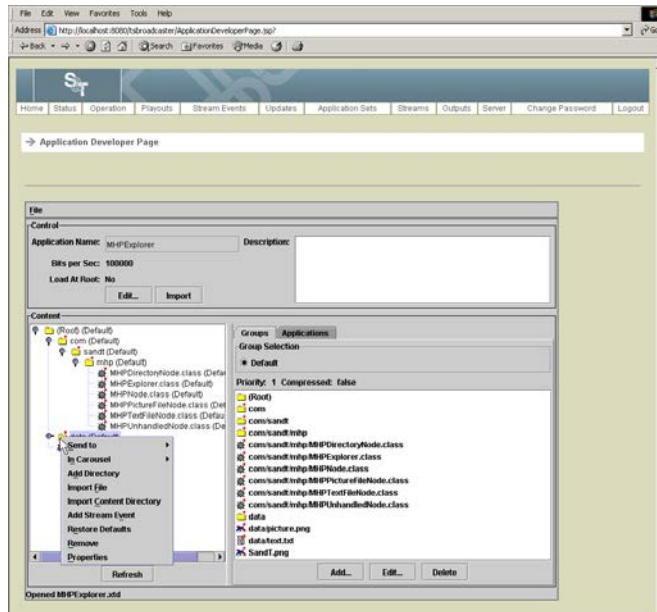

- Select **In Carousel** to place objects in or out of the carousel.

**Result:** The system displays In or Out.

- This option selects if the object is in or out of the carousel as follows:
  - Click **In** to include files or directories that have been imported as part of a directory sub-tree.
  - Click **Out** to exclude files or directories that have been imported as part of a directory sub-tree. Objects that have been excluded from the carousel are shown in blue.

**Note:** This option is not available for (Root), which is always included.

# Add a Directory

## Introduction

The Add Directory option is available for (Root) and directories that have been added using Add Directory.

## Adding a Directory

To add a directory to the carousel, complete the following steps.

1. Log in to the TSBroadcaster as a user with the appropriate privileges. See **Log In to the TSBroadcaster** in Chapter 3.

**Result:** After a successful login, the Home Page opens.

2. Click the **Application Sets** button from the navigation bar.

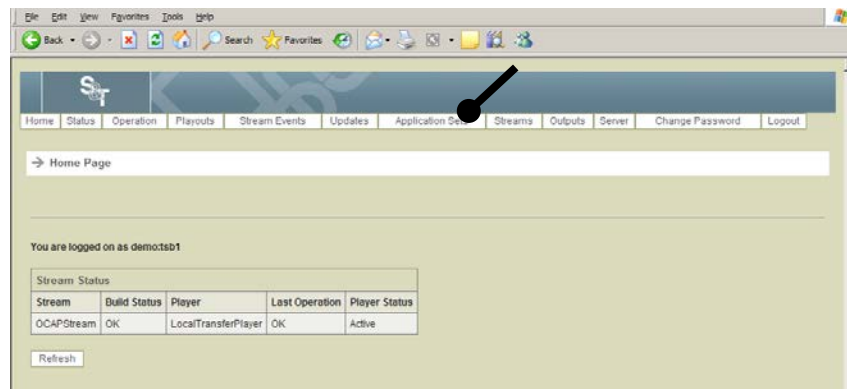

**Result:** The Manage Application Sets Page opens.

3. Click the **Develop Application Set** button.

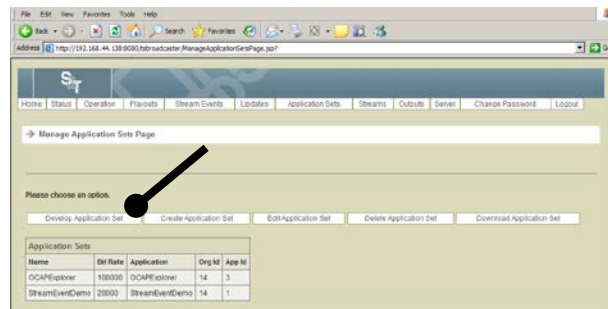

**Result:** The Application Developer Page opens.

## Add a Directory, Continued

4. Make sure the Applications tab is selected. From the left pane, select the file system object for which you want to add a directory, and right-click to display a pop-up menu.

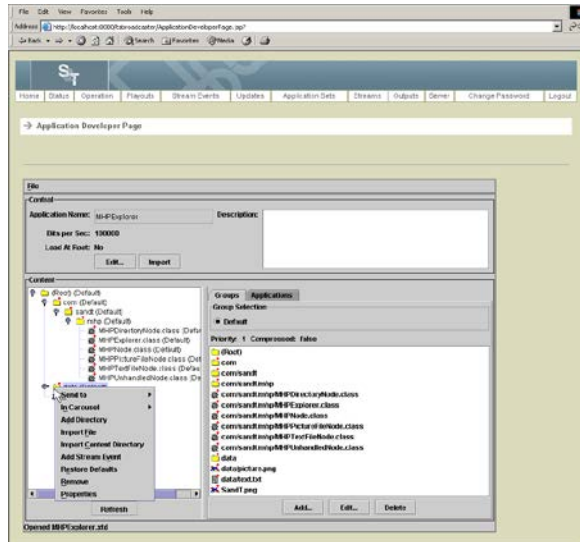

5. Select **Add Directory** to open the property dialog for this object.  
**Result:** The Add Directory window opens.
6. Enter the name of the directory and click **OK**.
7. Click **File** and then **Save**.  
**Result:** The Save Application Definition window opens.
8. Select a location and enter a file name for the directory.
9. Click **Save** to save the directory in the specified location.

# Import a File

## Importing Files

The Import File option is available for (Root) and directories that have been added using Add Directory.

1. Log in to the TSBroadcaster as a user with the appropriate privileges. See **Log In to the TSBroadcaster** in Chapter 3.

**Result:** After a successful login, the Home Page opens.

2. Click the **Application Sets** button from the navigation bar.

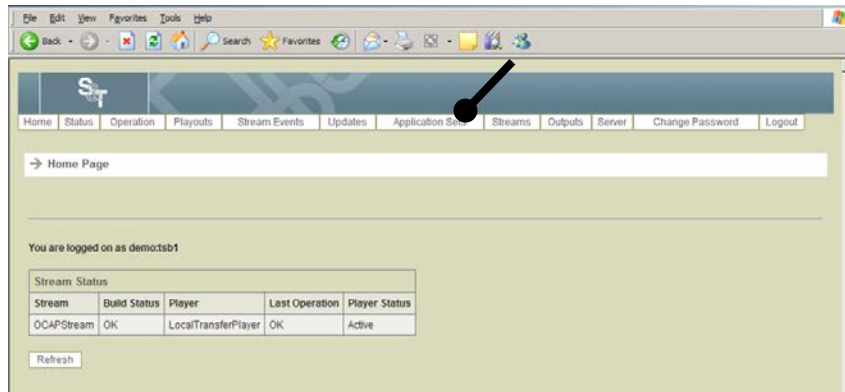

**Result:** The Manage Application Sets Page opens.

3. Click the **Develop Application Set** button.

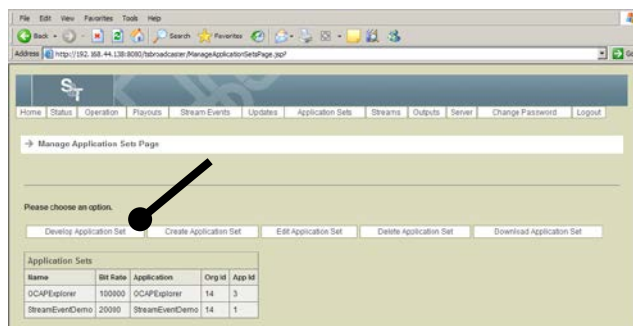

**Result:** The Application Developer Page opens.

## Import a File, Continued

4. Make sure the Applications tab is selected. From the left pane, select the file system object where you want to import the file, and right-click to display a pop-up menu.

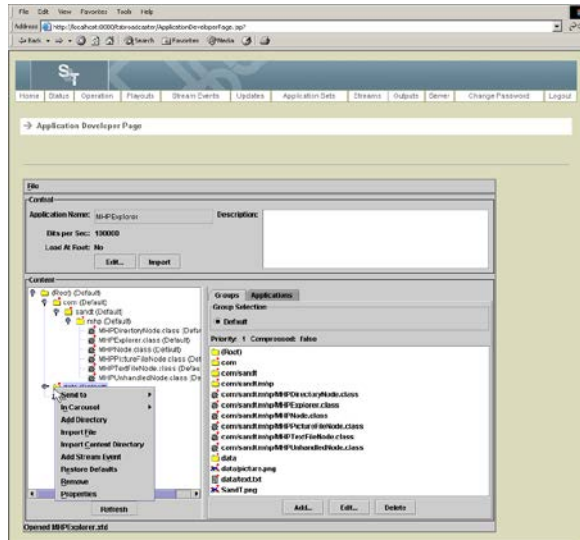

5. Select **Import File**.  
**Result:** The system prompts you for a file name.
6. Select the file that you want to import and click **Open**.  
**Result:** The file is imported to the selected directory.

# Import a Content Directory

## Importing a Content Directory

To import a content directory, complete the following steps.

1. Log in to the TSBroadcaster as a user with the appropriate privileges. See **Log In to the TSBroadcaster** in Chapter 3.

**Result:** After a successful login, the Home Page opens.

2. Click the **Application Sets** button from the navigation bar.

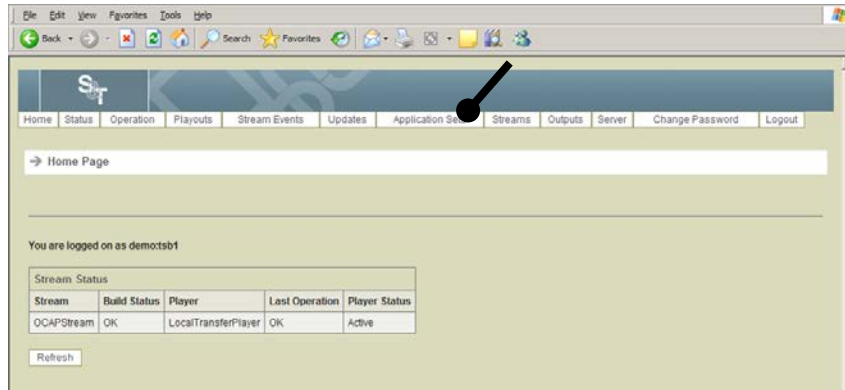

**Result:** The Manage Application Sets Page opens.

3. Click the **Develop Application Set** button.

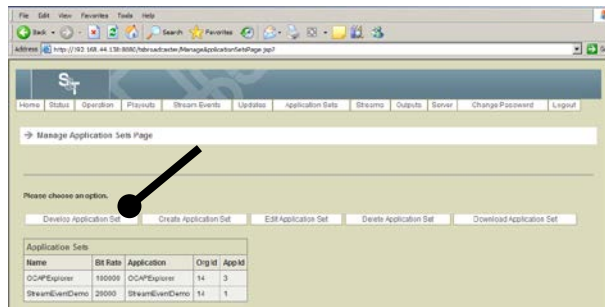

**Result:** The Application Developer Page opens.

# Import a Content Directory, Continued

4. Make sure the Applications tab is selected. From the left pane, select the file system object where you want to import a content directory, and right-click to call up a pop-up menu.

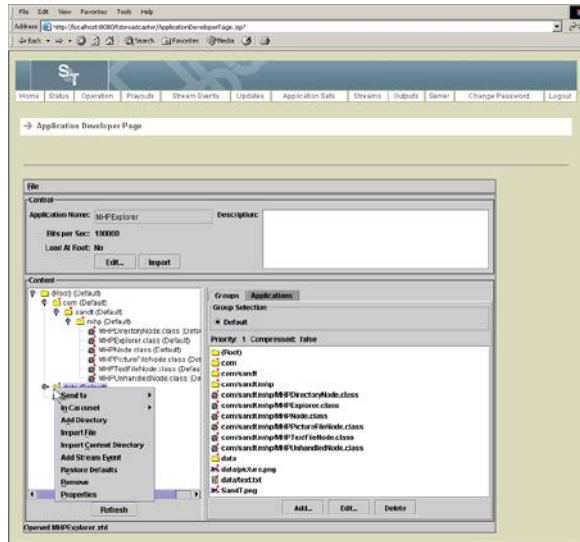

5. Select **Import Content Directory**.  
**Result:** The system prompts you for a content directory name.
6. Select the content directory that you want to import and click **Open**.  
**Result:** The content directory is imported to the selected directory.

# Add a Stream Event

## Introduction

A stream event is an event that can happen at an arbitrary time. One example of a stream event is a ticker tape application that scrolls across the bottom of the TV screen. A stream event is added to an active stream and is visible from the user's perspective. A default application from Strategy & Technology allows you to overlay a video stream with a transparent window that shows updates in red that have been made from the TSBroadcaster interface.

## Adding a Stream Events

To add a stream event, complete the following steps.

1. Log in to the TSBroadcaster as a user with the appropriate privileges. See **Log In to the TSBroadcaster** in Chapter 3.

**Result:** After a successful login, the Home Page opens.

2. Click the **Application Sets** button from the navigation bar.

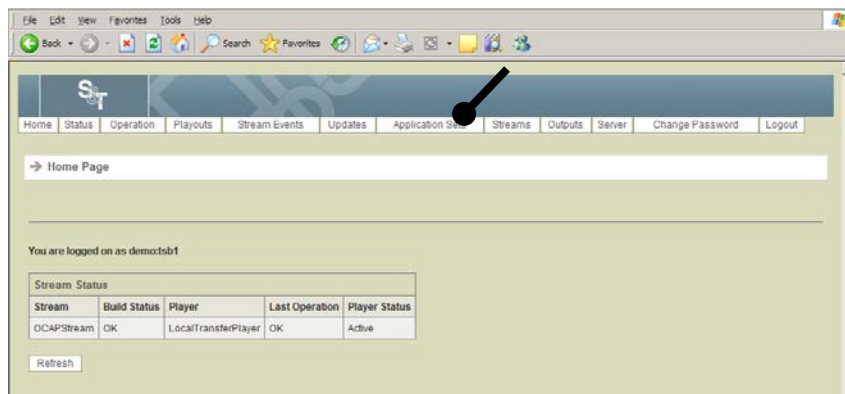

**Result:** The Manage Application Sets Page opens.

3. Click the **Develop Application Set** button.

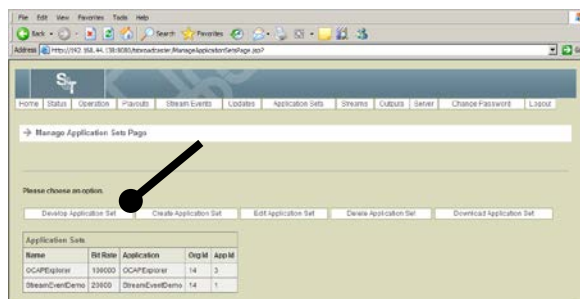

**Result:** The Application Developer Page opens.

## Add a Stream Event, Continued

4. Make sure the Applications tab is selected. From the left pane, select the file system object where you want to add a stream event, and right-click to call up a pop-up menu.

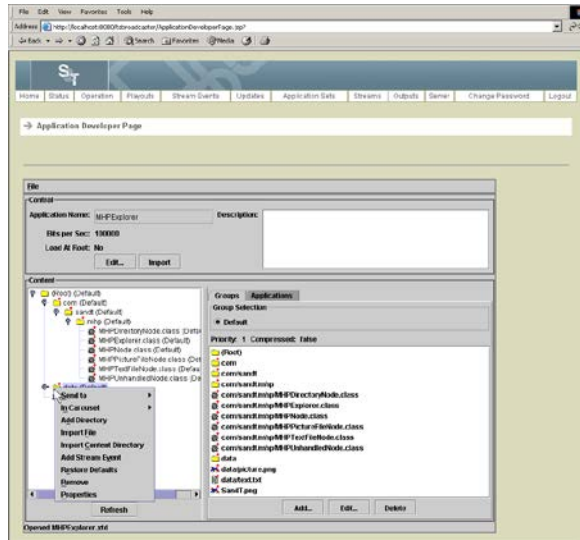

5. Select **Add Stream Event**.  
The system prompts you for the stream event name.
6. Enter the name for the event and click **OK**.  
**Result:** The event is added under the selected directory.
7. Click the **Add** button in the right pane to add another stream event to the object.

**Result:** The TSBroadcaster displays an input dialog box.

A dialog box titled "Add Stream Event" with a close button (X) in the top right corner. It contains three input fields: "Name:", "Id:", and "Prompt Text:". Below the input fields are two buttons: "OK" and "Cancel".

## Add a Stream Event, Continued

8. Enter the following information.

<b>Name</b>	The name of the stream event
<b>ID</b>	The ID of the stream event. If this field is left blank, the TSBroadcaster allocates an event number for you, starting at 1. If the number is already in use, the TSBroadcaster uses another number when the application containing the stream event object is played out
<b>Prompt Text</b>	The prompt that is displayed to collect data to include with the stream event. If this field is left blank, the TSBroadcaster will not prompt for data and will add the stream event without data

9. Click **OK**.

**Result:** The event is added to the selected directory.

# Remove an Object from the TSBroadcaster

## Removing an Object from the TSBroadcaster

To remove an object from the TSBroadcaster, complete the following steps.

**Note:** You can remove any object that has been added, dragged in, or imported directly.

1. Log in to the TSBroadcaster as a user with the appropriate privileges. See **Log In to the TSBroadcaster** in Chapter 3.

**Result:** After a successful login, the Home Page opens.

2. Click the **Application Sets** button from the navigation bar.

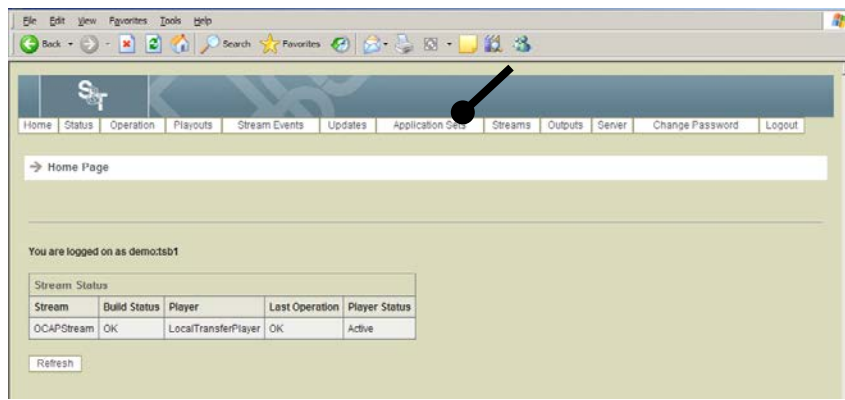

**Result:** The Manage Application Sets Page opens.

3. Click the **Develop Application Set** button.

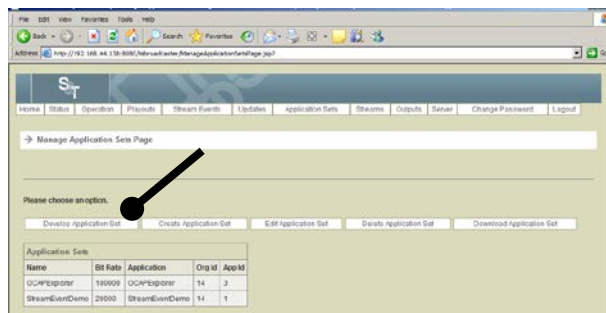

**Result:** The Application Developer Page opens.

## Remove an Object from the TSBroadcaster, Continued

- From the left pane, select the file system object that you want to remove, and right-click to call up a pop-up menu.

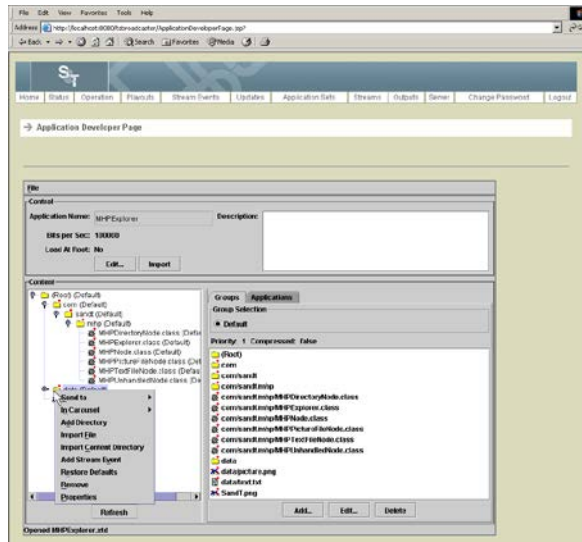

- Select **Remove**.

**Result:** The system prompts you whether you are sure you want to delete the object.

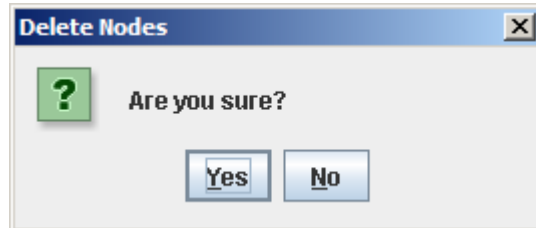

- Click **Yes** to remove the object (and all content beneath the object in the case of directories) from the DSM -CC file system.

# Edit an Object

## Editing an Object

To edit an object, complete the following steps.

1. Log in to the TSBroadcaster as a user with the appropriate privileges. See **Log In to the TSBroadcaster** in Chapter 3.

**Result:** After a successful login, the Home Page opens.

2. Click the **Application Sets** button from the navigation bar.

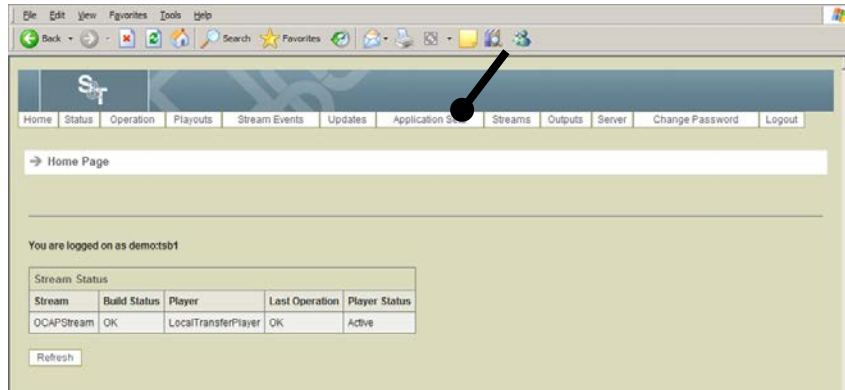

**Result:** The Manage Application Sets Page opens.

3. Click the **Edit Application Set** button.

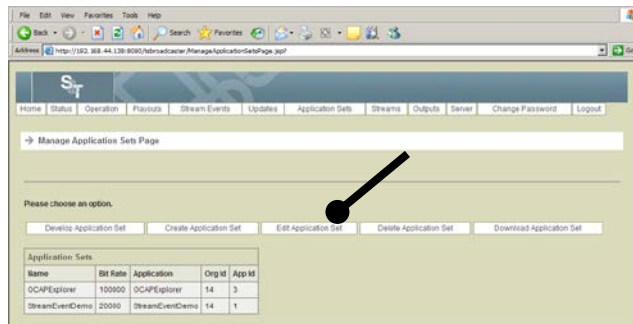

**Result:** The Edit Application Set Select Page opens.

4. Select an application set and click **Select**.

**Result:** The Edit Application Set Page opens.

## Edit an Object, Continued

5. Make sure the Applications tab is selected. Select the file system object for which you want to edit the properties, and right-click to call up a pop-up menu.

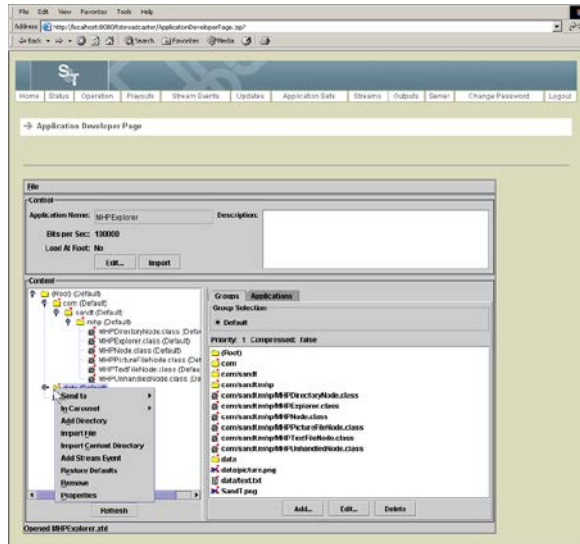

6. Select **Properties**.

**Result:** The Edit Properties window opens. The content of the property dialog depends on what is selected.

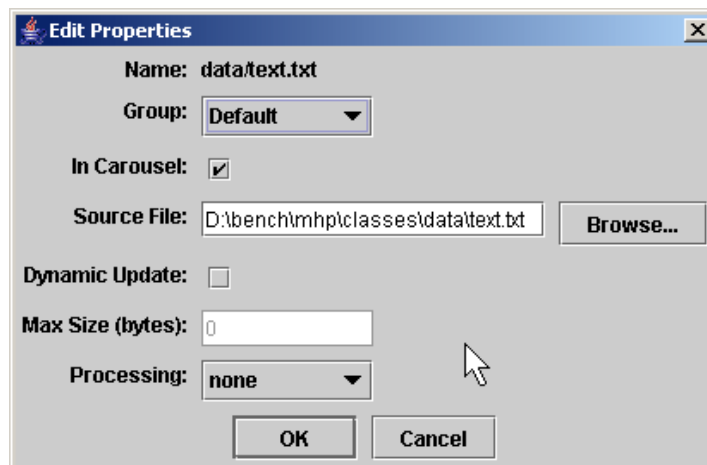

## Edit an Object, Continued

7. Enter the following information on the Edit Properties window.

The following fields are present for a directory that has been dragged in from the client file system:

<b>Group</b>	The group to which the object will be allocated
<b>In Carousel</b>	A checkbox indicating whether the object is in or out of the carousel. This is useful if you wish to exclude files or directories that have been imported as part of a directory sub-tree. Objects that have been excluded from the carousel are shown in blue. This field is not available for <b>(Root)</b> , which is always included
<b>Source Directory</b>	The directory path on the client machine from which the content will be imported into the DSM-CC file system  <b>Note:</b> This field is present for a directory that has been dragged in from the client file system.
<b>Default Group</b>	The default group for all objects in the content sub-tree below the directory  This field is present for a directory that has been dragged in from the client file system.

The following fields are present for a file:

<b>Source File</b>	The path of the file on the client machine from which the content will be imported. This field is read-only for a file that has been imported as part of a directory tree  <b>Note:</b> This field is present for a file.
<b>Dynamic Update</b>	A checkbox to indicate that this file has been selected to receive rapid updates. A file selected for rapid update can be updated directly in the object carousel with very low latency. Rapid updates are useful for presenting time-critical information such as sports scores or stock prices. Files not selected for rapid update are updated during the next carousel rebuild  <b>Note:</b> This field is present for a file.

## Edit an Object, Continued

<b>Max Size (bytes)</b>	<p>The maximum size in bytes reserved for a file selected for rapid update. TSBroadcaster allocates this number of bytes for the contents of the file, and pads out the content with ASCII spaces if it is smaller. If an update for a rapid update file is larger than this size, a one-off carousel rebuild is triggered to update the file and increase its maximum size. Subsequent updates will be performed as rapid updates if they are within the revised maximum size</p> <p><b>Note:</b> This field is present for a file.</p>
<b>Processing</b>	<p>Indicates whether the file will be pre-processed before including it in the carousel. For OCAP files, this field should be set to none</p> <p><b>Note:</b> This field is present for a file.</p>

8. Click **Save**.

# Edit Object Properties

## Editing Object Properties

To edit the properties of an object, complete the following steps.

1. Log in to the TSBroadcaster as a user with the appropriate privileges. See **Log In to the TSBroadcaster** in Chapter 3.

**Result:** After a successful login, the Home Page opens.

2. Click the **Application Sets** button from the navigation bar.

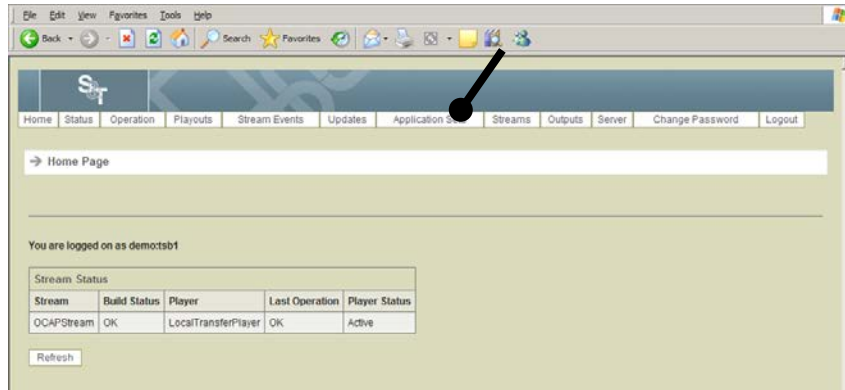

**Result:** The Manage Application Sets Page opens.

3. Click the **Develop Application Set** button.

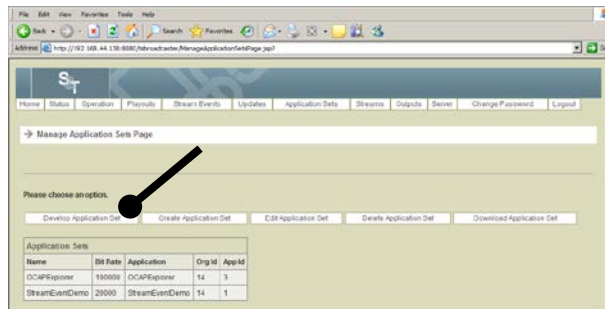

**Result:** The Application Developer Page opens.

# Edit Object Properties, Continued

4. Click **File** and then **Open**.

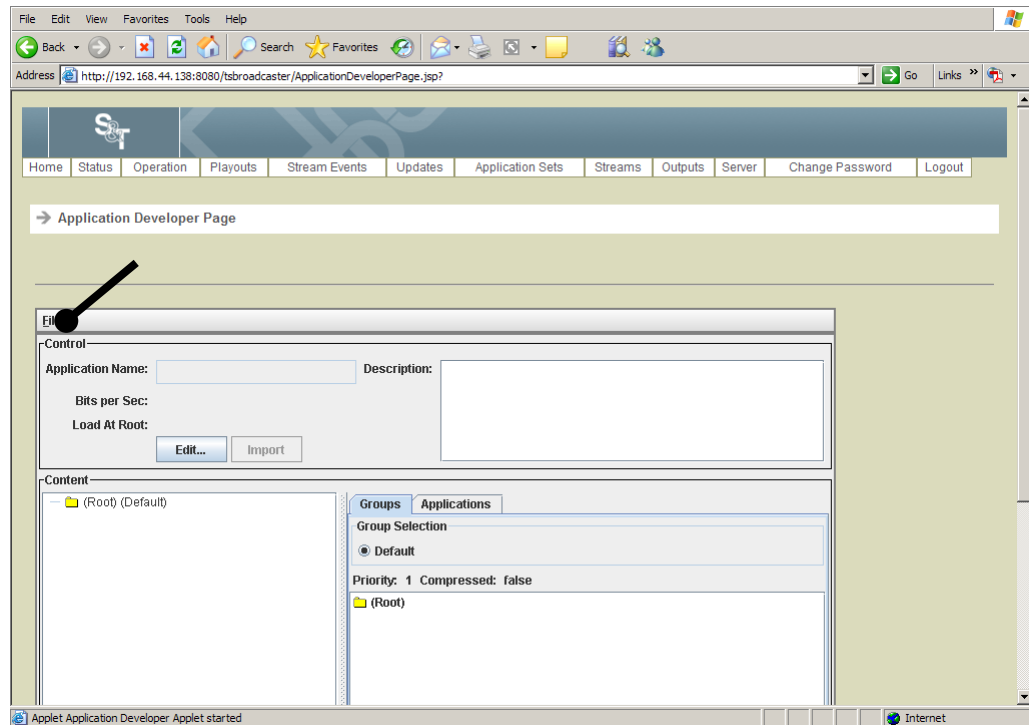

**Result:** The Open Application Set Definition File Page opens.

5. Enter the file name that you want to open and click **Open**.

## Edit Object Properties, Continued

6. Make sure the Applications tab is selected. Select the file system object for which you want to edit the properties, and right-click to call up a pop-up menu.

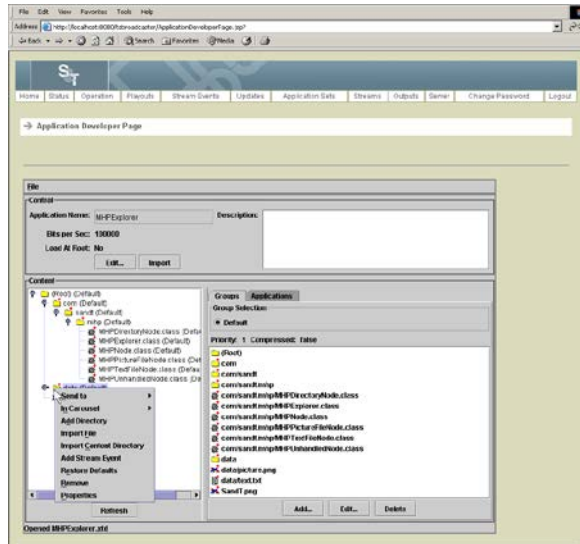

7. Select **Properties**.

**Result:** The Edit Properties window opens. The content of the property dialog depends on what is selected.

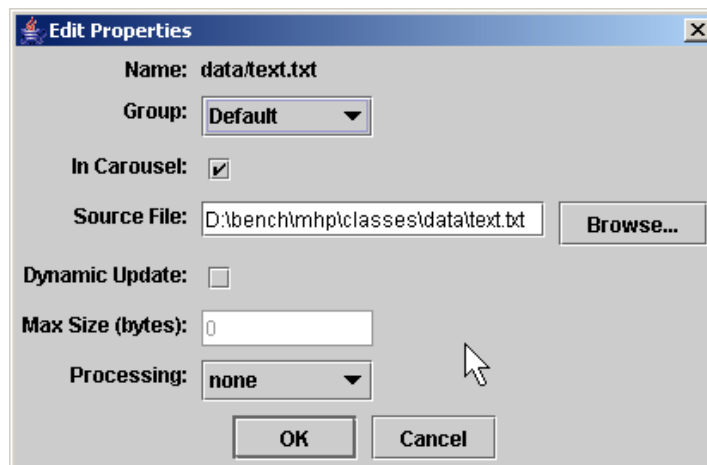

## Edit Object Properties, Continued

8. Enter the following information on the Edit Properties window.

The following fields are present for a directory that has been dragged in from the client file system:

<b>Group</b>	The group to which the object will be allocated
<b>In Carousel</b>	A checkbox indicating whether the object is in or out of the carousel. This is useful if you wish to exclude files or directories that have been imported as part of a directory sub-tree. Objects that have been excluded from the carousel are shown in blue. This field is not available for <b>(Root)</b> , which is always included
<b>Source Directory</b>	The directory path on the client machine from which the content will be imported into the DSM-CC file system  <b>Note:</b> This field is present for a directory that has been dragged in from the client file system.
<b>Default Group</b>	The default group for all objects in the content sub-tree below the directory  This field is present for a directory that has been dragged in from the client file system.

The following fields are present for a file:

<b>Source File</b>	The path of the file on the client machine from which the content will be imported. This field is read-only for a file that has been imported as part of a directory tree  <b>Note:</b> This field is present for a file.
<b>Dynamic Update</b>	A checkbox to indicate that this file has been selected to receive rapid updates. A file selected for rapid update can be updated directly in the object carousel with very low latency. Rapid updates are useful for presenting time-critical information such as sports scores or stock prices. Files not selected for rapid update are updated during the next carousel rebuild  <b>Note:</b> This field is present for a file.

## Edit Object Properties, Continued

<b>Max Size (bytes)</b>	<p>The maximum size in bytes reserved for a file selected for rapid update. TSBroadcaster allocates this number of bytes for the contents of the file, and pads out the content with ASCII spaces if it is smaller. If an update for a rapid update file is larger than this size, a one-off carousel rebuild is triggered to update the file and increase its maximum size. Subsequent updates will be performed as rapid updates if they are within the revised maximum size</p> <p><b>Note:</b> This field is present for a file.</p>
<b>Processing</b>	<p>Indicates whether the file will be pre-processed before including it in the carousel. For OCAP files, this field should be set to none</p> <p><b>Note:</b> This field is present for a file.</p>

9. Click **Save**.

# Edit a Stream Event

## Introduction

The TSBroadcaster adds a tabbed pane called Stream Event Name to the right-hand content pane for each stream event object in the DSM-CC file system, where **name** is the name of the stream event object.

This section provides instructions for editing a stream event.

## Editing a Stream Event

To edit a stream event, complete the following steps.

1. Log in to the TSBroadcaster as a user with the appropriate privileges. See **Log In to the TSBroadcaster** in Chapter 3.

**Result:** After a successful login, the Home Page opens.

2. Click the **Application Sets** button from the navigation bar.

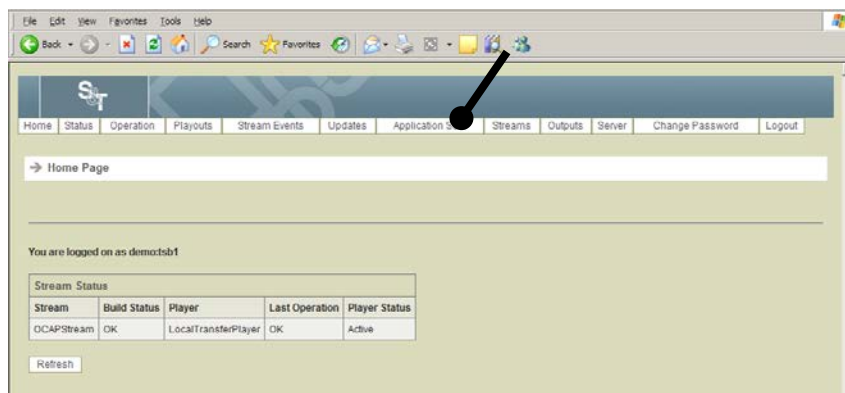

**Result:** The Manage Application Sets Page opens.

3. Click the **Edit Application Set** button.

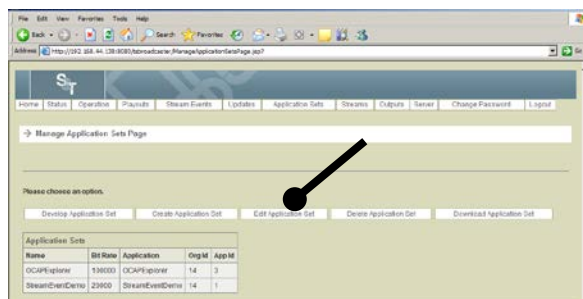

**Result:** The Edit Application Set Select Page opens.

## Edit a Stream Event, Continued

- Select the Application Set for which you want to modify the stream event and click **Select**.
- Click the **Edit** button to modify the stream event data.

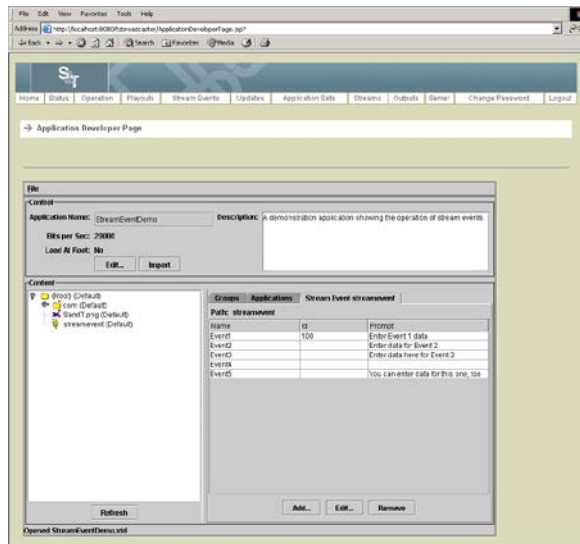

**Result:** The TSBroadcaster displays an input dialog box.

- Enter the following information.

<b>Name</b>	The name of the stream event
<b>ID</b>	The ID of the stream event. If this field is left blank, the TSBroadcaster allocates an event number for you, starting at 1. If the number is already in use, the TSBroadcaster uses another number when the application containing the stream event object is played out
<b>Prompt Text</b>	The prompt that is displayed to collect data to include with the stream event. If this field is left blank, the TSBroadcaster will not prompt for data and will add the stream event without data

- Click **Save**.

# Remove a Stream Event

## Introduction

The TSBroadcaster adds a tabbed pane called Stream Event Name to the right-hand content pane for each stream event object in the DSM-CC file system, where **name** is the name of the stream event object.

This section provides instructions for removing a stream event.

## Removing a Stream Event

To remove a stream event, complete the following steps.

1. Log in to the TSBroadcaster as a user with the appropriate privileges. See **Log In to the TSBroadcaster** in Chapter 3.

**Result:** After a successful login, the Home Page opens.

2. Click the **Application Sets** button from the navigation bar.

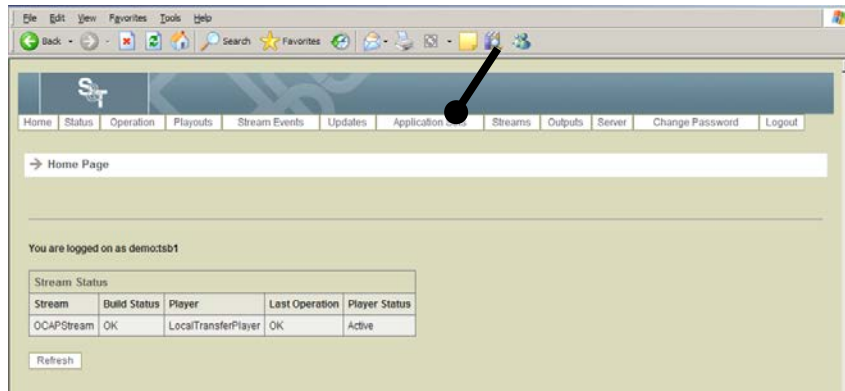

**Result:** The Manage Application Sets Page opens.

3. Click the **Develop Application Set** button.

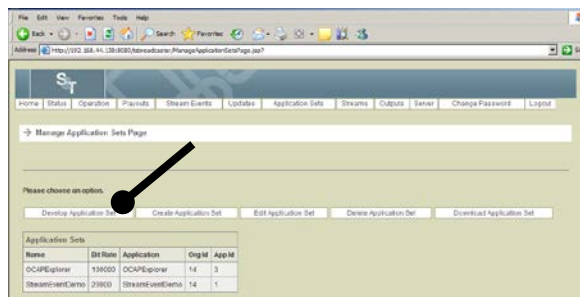

**Result:** The Application Developer Page opens.

# Remove a Stream Event, Continued

4. Select the stream event you want to delete and click the **Remove** button to remove the stream event.

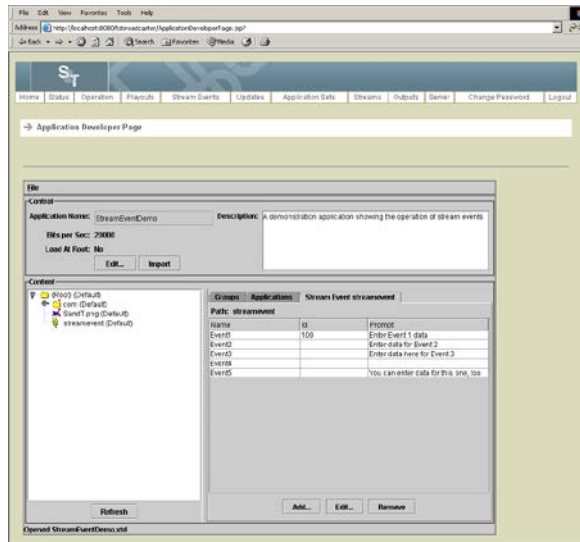

# Restore Defaults

## Introduction

This section provides the procedure to set all of the object properties back to their default values.

## Restoring Defaults

To restore all object properties back to their defaults, complete the following steps.

1. Log in to the TSBroadcaster as a user with the appropriate privileges. See **Log In to the TSBroadcaster** in Chapter 3.

**Result:** After a successful login, the Home Page opens.

2. Click the **Application Sets** button from the navigation bar.

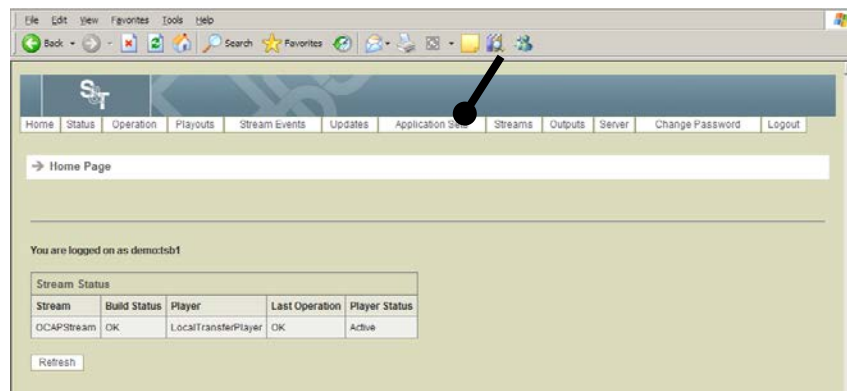

**Result:** The Manage Application Sets Page opens.

3. Click the **Develop Application Set** button.

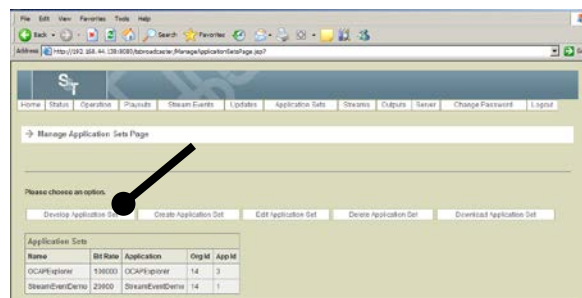

**Result:** The Application Developer Page opens.

## Restore Defaults, Continued

4. Select the file system object for which you want to restore defaults, and right-click to display a pop-up menu.

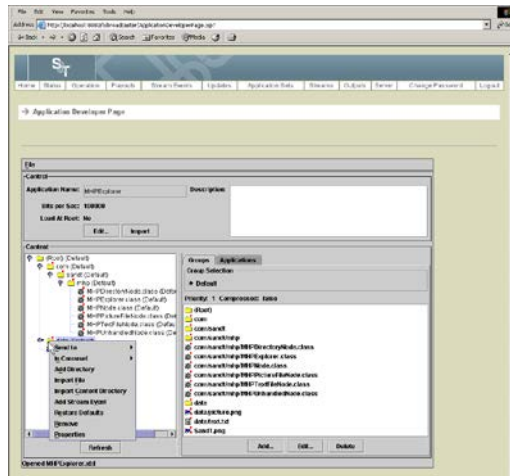

5. Select **Restore Defaults** to reset all object properties back to their default values.

# Add a Group

## Introduction

The TSBroadcaster provides a tabbed pane called Groups in the right-hand content pane. This pane shows the groups that have been defined to hold the objects in the DSM-CC file system. A “group” defines the set of files and directories should be broadcast together in the same module, if possible.

By default, a single group called Default is provided to hold all DSM-CC objects. This default setting will allow applications in the application set to load and run, if enough bandwidth is allocated.

Depending on the characteristics of the contents of the files being broadcast and the characteristics of the receiver population, you may want to distribute the contents of the application set into one or more groups with the appropriate settings.

## Adding a Group

To add a group, complete the following steps.

1. Log in to the TSBroadcaster as a user with the appropriate privileges. See **Log In to the TSBroadcaster** in Chapter 3.

**Result:** After a successful login, the Home Page opens.

2. Click the **Application Sets** button from the navigation bar.

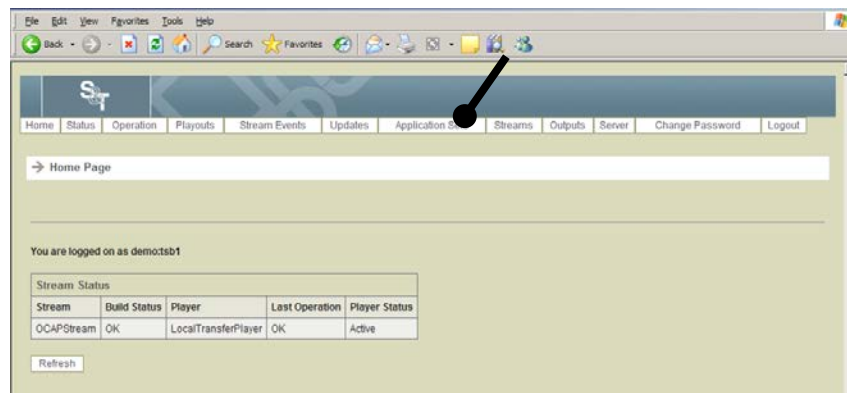

**Result:** The Manage Application Sets Page opens.



## Add a Group, Continued

5. Enter the following information.

<b>Name</b>	The name of the group
<b>Priority</b>	The repetition rate of the modules in the group, relative to modules of other groups in the application set. As an example, if group A has a priority of 3 and group B has a priority of 1, the modules from group A will be played out three times in the time taken to play out the modules from group B once
<b>Compressed</b>	A check box to indicate whether the modules of this group are compressed. If the objects in the group compress well, then the modules will be much smaller and will use less bandwidth to transmit

6. Click the **OK** button to save the group.

# Move Objects From One Group to Another

## Moving Objects From One Group to Another

To move an object from one group to another, complete the following steps.

1. Log in to the TSBroadcaster as a user with the appropriate privileges. See **Log In to the TSBroadcaster** in Chapter 3.

**Result:** After a successful login, the Home Page opens.

2. Click the **Application Sets** button from the navigation bar.

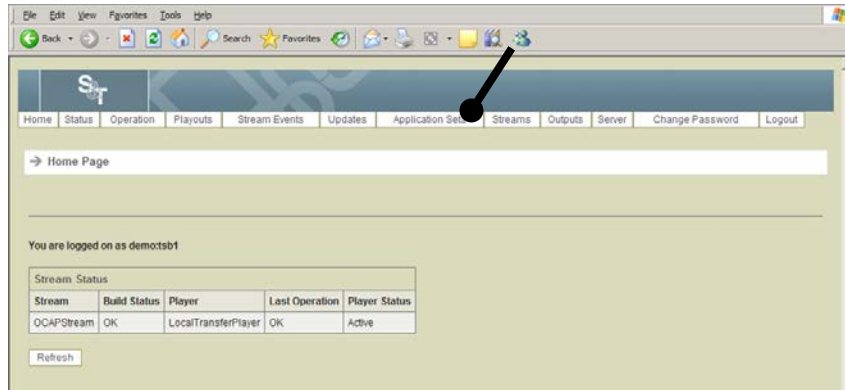

**Result:** The Manage Application Sets Page opens.

3. Click the **Develop Application Set** button.

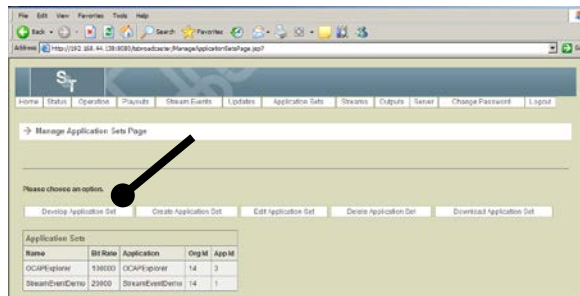

**Result:** The Application Developer Page opens.

# Move Objects From One Group to Another, Continued

4. Select a group by clicking on its radio button to see the objects currently allocated to the group.

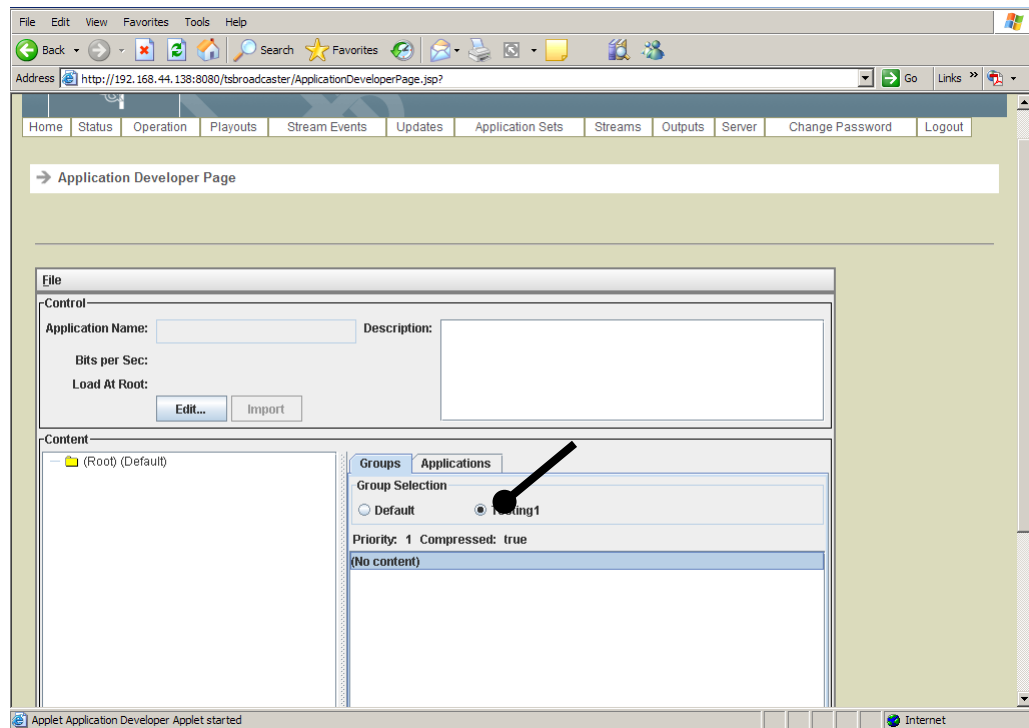

## Move Objects From One Group to Another, Continued

5. Make sure the Groups tab is selected. To move DSM-CC objects from one group to another, you can use any of the following methods:
  - From the left pane, select the object, and then use the **Send to** option in the pop-up menu.
  - From the left pane, select the object, select the **Properties** option in the pop-up menu and select the new group in the dialog.
  - Drag the object(s) over the radio button for the group and release.

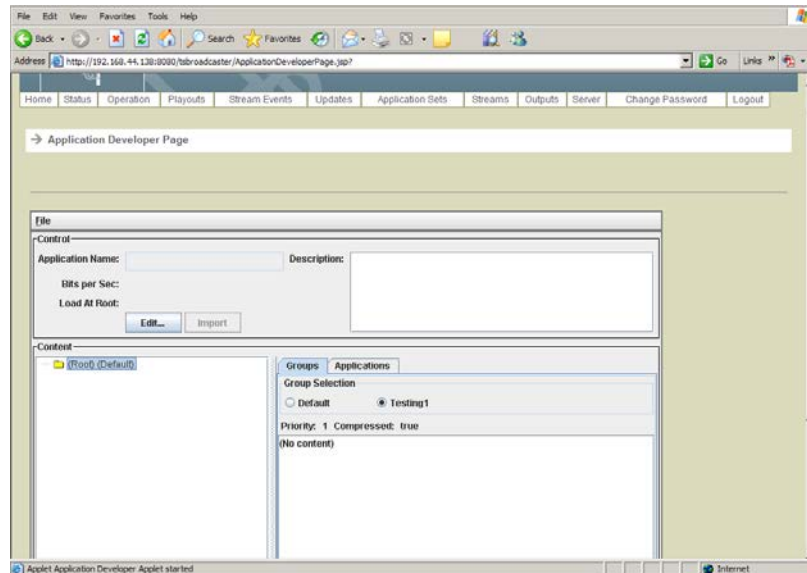

# Edit a Group

## Editing a Group

To edit a group, complete the following steps.

1. Log in to the TSBroadcaster as a user with the appropriate privileges. See **Log In to the TSBroadcaster** in Chapter 3.

**Result:** After a successful login, the **Home Page** opens.

2. Click the **Application Sets** button from the navigation bar.

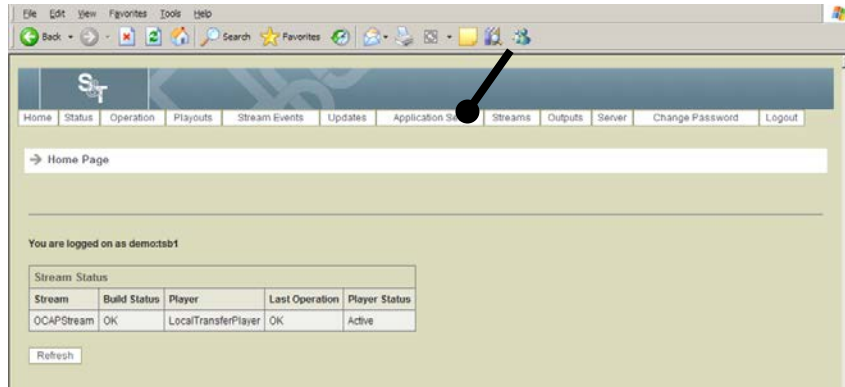

**Result:** The Manage Application Sets Page opens.

3. Click the **Develop Application Set** button.

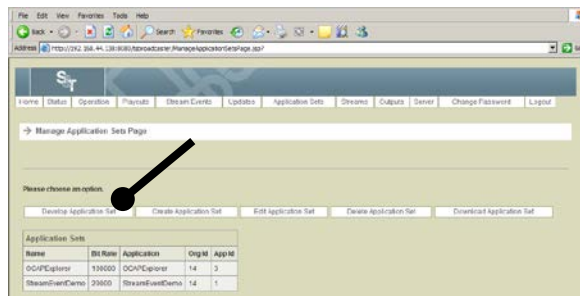

**Result:** The Application Developer Page opens.

## Edit a Group, Continued

4. Make sure the Groups tab is selected. Select a group by clicking on its radio button to see the objects currently allocated to the group.

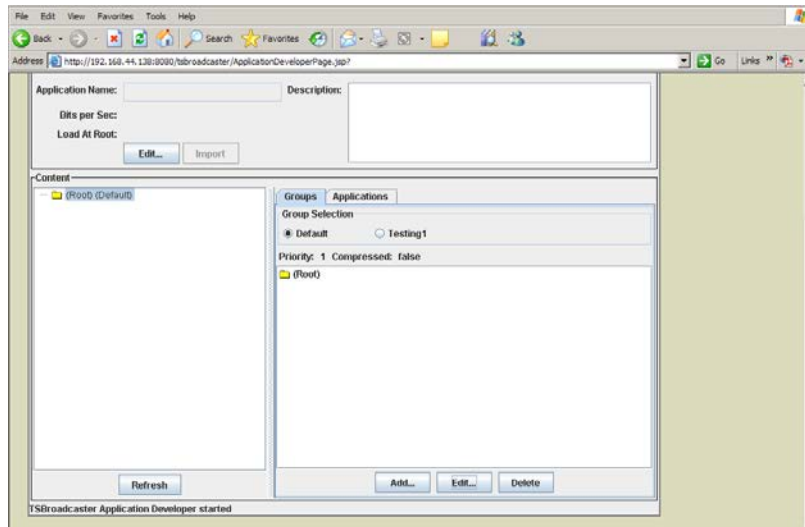

5. Click the **Edit** button.
6. Edit the group information. For field descriptions, see **Add a Group**, earlier in this chapter.
7. Click the **OK** button to save the changes to the group.

# Delete a Group

## Deleting a Group

To delete a group, complete the following steps.

**Important:** Groups must be empty *before* you can delete them.

1. Log in to the TSBroadcaster as a user with the appropriate privileges. See **Log In to the TSBroadcaster** in Chapter 3.

**Result:** After a successful login, the **Home Page** opens.

2. Click the **Application Sets** button from the navigation bar.

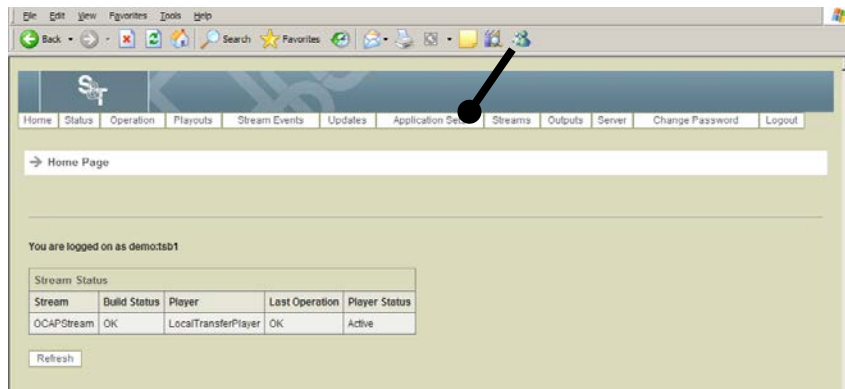

**Result:** The Manage Application Sets Page opens.

3. Click the **Develop Application Set** button.

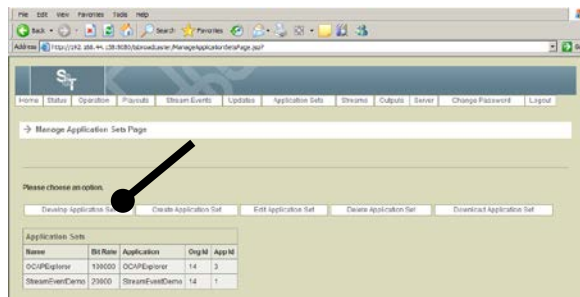

**Result:** The Application Developer Page opens.

## Delete a Group, Continued

4. Select a group by clicking on its radio button to see the objects currently allocated to the group.
5. Click the **Delete** button to delete the selected group.

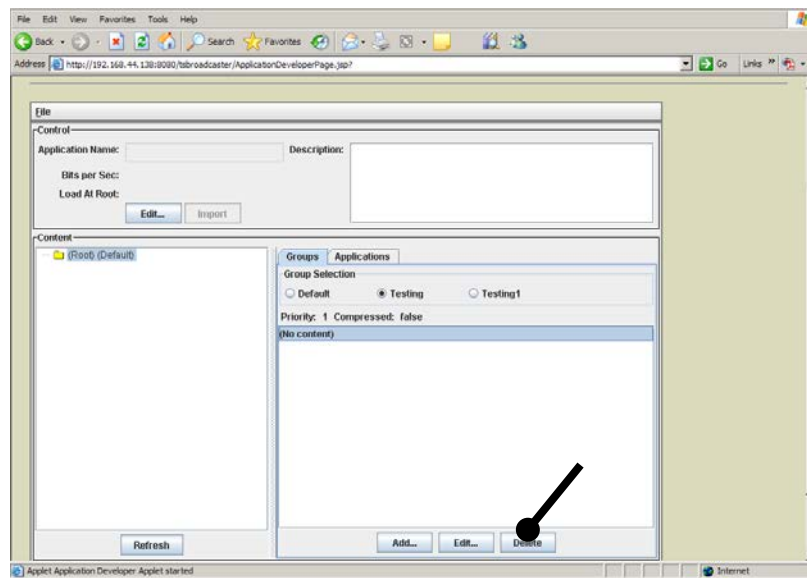

**Important:** The group must be empty before you can delete it.

# Set Group Priorities

## Setting Group Priorities

The efficacy of having groups with different priorities depends on the receiver characteristics. Taking start-up behavior as an example, if the receiver only loads the modules it needs, collecting the start-up objects together in a group of high priority will reduce start-up latency. However, if the receiver loads the whole object carousel before starting the application, having groups of different priorities will increase the time taken to start the application.

Module compression works well for textual data but not for pre-compressed data like JPEG files.

# Add an Application to an Application Set

## Introduction

The TSBroadcaster provides a tabbed pane called **Applications** in the right content pane. This pane shows the applications that have been defined in the application set. This section provides a procedure for adding an application to an application set.

## Adding an Application to an Application Set

To add an application to an application set, complete the following steps.

1. Log in to the TSBroadcaster as a user with the appropriate privileges. See **Log In to the TSBroadcaster** in Chapter 3.

**Result:** After a successful login, the **Home Page** opens.

2. Click the **Application Sets** button from the navigation bar.

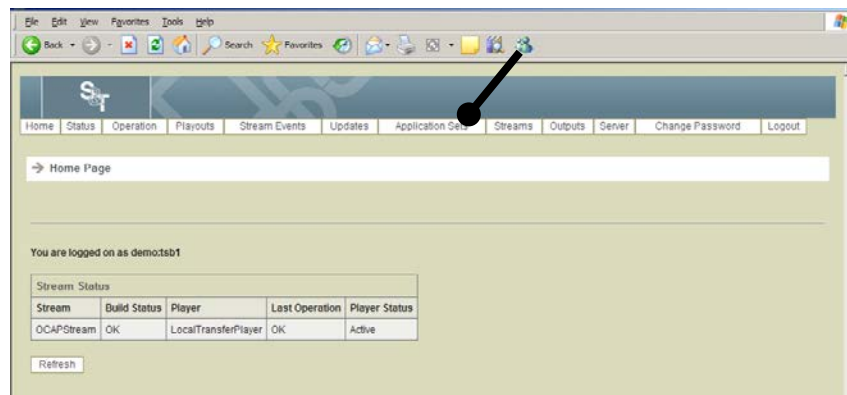

**Result:** The Manage Application Sets Page opens.

## Add an Application to an Application Set, Continued

3. Click the **Develop Application Set** button on the Manage Application Sets Page.

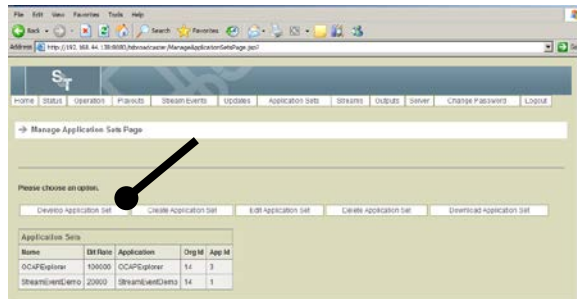

**Result:** The Application Developer Page opens.

4. Make sure the Applications tab is selected. Click the **Add Java App** button to create application signaling for a Java application.

**Note:** The **Add HTML App** button is not used in this version of TSBroadcaster. Any signaling created by this will be ignored.

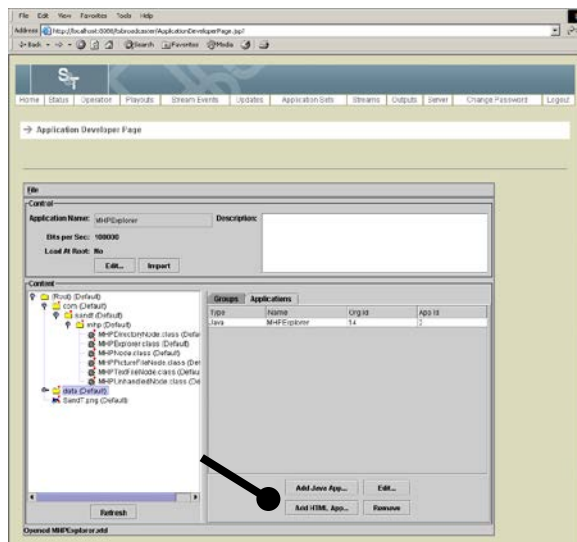

**Result:** The TSBroadcaster displays an input dialog box.

## Add an Application to an Application Set, Continued

5. Enter the following signaling information.

<b>Name</b>	The name of the application
<b>Org ID</b>	The ID of the organization
<b>App Id</b>	The ID of the application
<b>Priority</b>	The priority of the application
<b>Service Bound</b>	An indication of whether the application is service bound. If the application is service bound, it is automatically stopped when the receiver changes channel.
<b>Visibility</b>	An indication of whether the application signaling is visible. The values for visibility are: <ul style="list-style-type: none"><li>• <b>Invisible.</b> Visible to neither users nor applications listing APIs</li><li>• <b>System only.</b> Visible to applications listing APIs only</li><li>• <b>Visible.</b> Visible to users and applications listing APIs</li></ul>
<b>Control Code</b>	The action the application is to carry out. The values are: <ul style="list-style-type: none"><li>• <b>Autostart.</b> The application starts automatically</li><li>• <b>Present.</b> The application is loaded but does not start</li><li>• <b>Destroy.</b> The application is terminated gracefully</li><li>• <b>Kill.</b> The application is terminated</li><li>• <b>Remote.</b> The application is loaded from a remote source</li></ul>

## Add an Application to an Application Set, Continued

<b>Base Directory</b>	The default directory for the application
<b>Classpath Extension</b>	Any additional class paths besides system paths and base directory
<b>Initial Class</b>	The location of the Xlet class from which the application should be started, in standard dotted package notation
<b>Parameters</b>	A space-separated list of parameters passed to the application when it starts up
<b>Icons Locator</b>	A DSM-CC directory path containing the icons for the application
<b>Icon Flags</b>	An integer value that indicates which icon resolutions are available in the icons directory
<b>Profiles</b>	The receiver profiles needed to run this application

6. Click the **OK** button to save the new signaling information.

# Edit an Application in an Application Set

## Editing an Application in an Application Set

To edit an application in an application set, complete the following steps.

1. Log in to the TSBroadcaster as a user with the appropriate privileges. See **Log In to the TSBroadcaster** in Chapter 3.

**Result:** After a successful login, the TSBroadcaster displays the Home Page. This page shows the functions available to the user and a summary snapshot of the streams and outputs set up on the system.

2. Click the **Application Sets** button from the navigation bar.

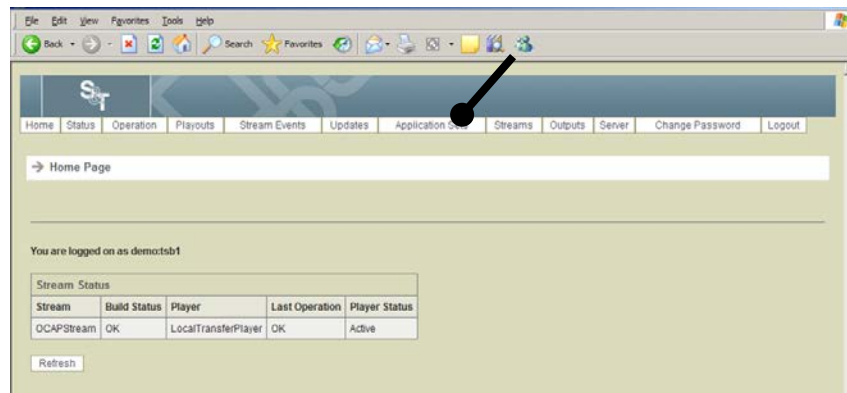

**Result:** The Manage Application Sets Page opens.

## Edit an Application in an Application Set, Continued

3. Click the **Develop Application Set** button on the Manage Application Sets Page.

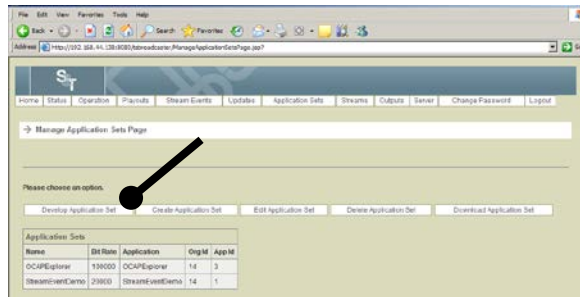

**Result:** The Application Developer Page opens.

4. Select the row that contains the application you want to edit.
5. Click the **Edit** button.

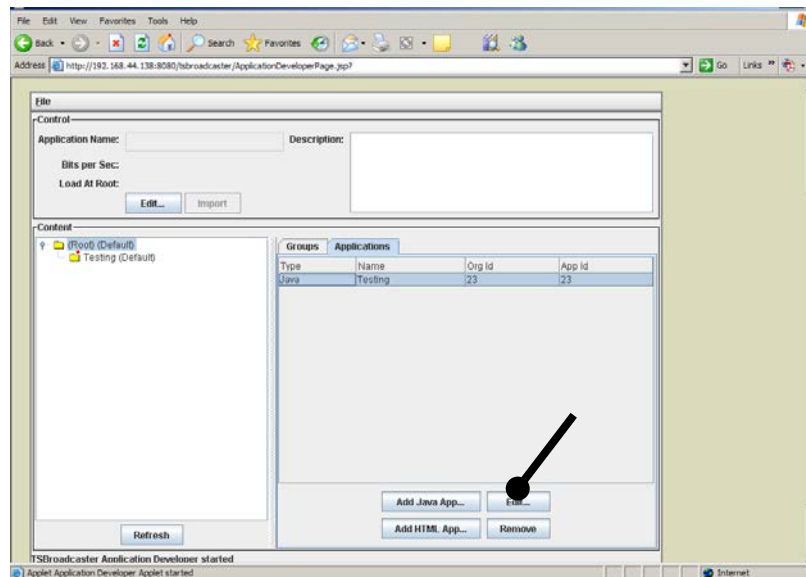

6. Edit the information on the Edit Application window. For a description of the fields, see **Create Application Signaling**, earlier in this chapter.
7. Click the **OK** button to save the changes to the signaling information.

# Delete an Application from an Application Set

## Deleting an Application from an Application set

To delete an application from an application set, complete the following steps.

**Important:** Do *not* delete an application from the application set if you have a layout defined for the application.

1. Log in to the TSBroadcaster as a user with the appropriate privileges. See **Log In to the TSBroadcaster** in Chapter 3.

**Result:** After a successful login, the **Home Page** opens.

2. Click the **Application Sets** button from the navigation bar.

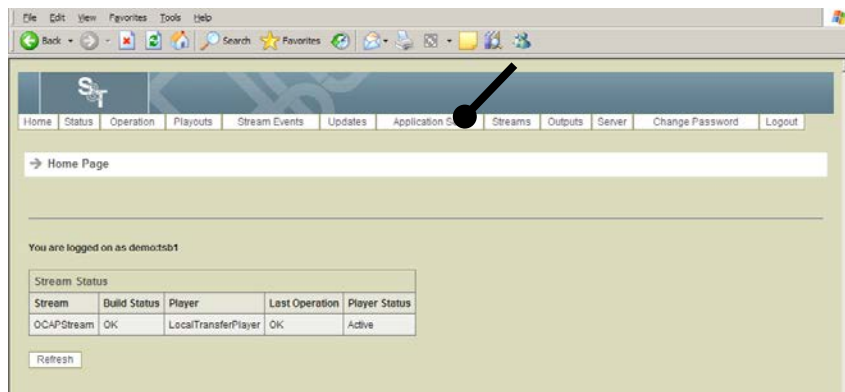

**Result:** The Manage Application Sets Page opens.

3. Make sure the Applications tab is selected. Select the row that contains the application you want to delete.

4. Click the **Remove** button.

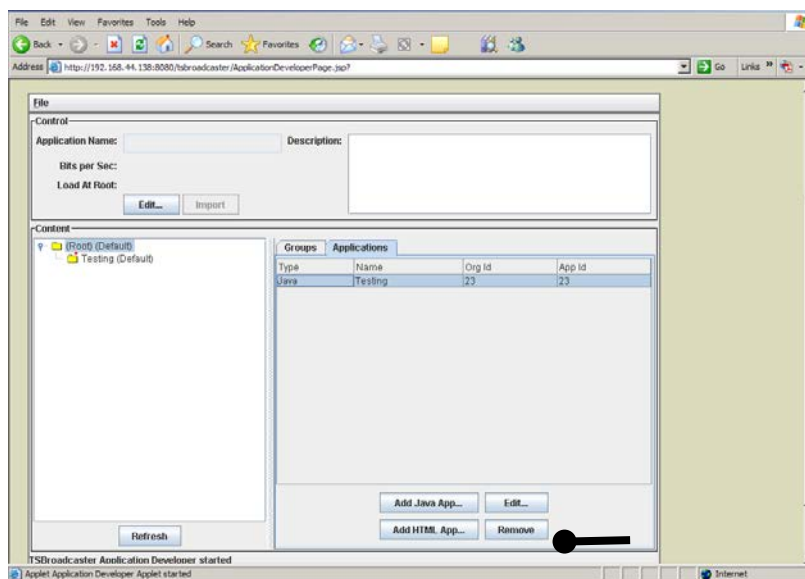

# Chapter 6

## Managing Playouts

### Overview

#### Introduction

The TSBroadcaster allows you to schedule the playout of application sets in a Transport Stream. The TSBroadcaster offers the following features:

- Scheduling of one-off, daily, weekly and continuous scheduled playouts
- Automatic scheduling of application playout and polled updates
- Concurrent playout of multiple applications within a single carousel
- Dynamic allocation of bit rate to applications
- Automatic signaling to remove terminated applications

#### Manage Scheduled Playouts Page

The playout management functions are only available to users who have the ManageSchedule privilege. To access the application set management functions through the Internet browser UI, log in as a user with the appropriate privilege, select the Playouts button from the navigation bar and select a Transport Stream. TSBroadcaster will present the Manage Scheduled Playouts Page. This page shows a summary of the playouts already defined for the stream, and presents a set of buttons to manage them.

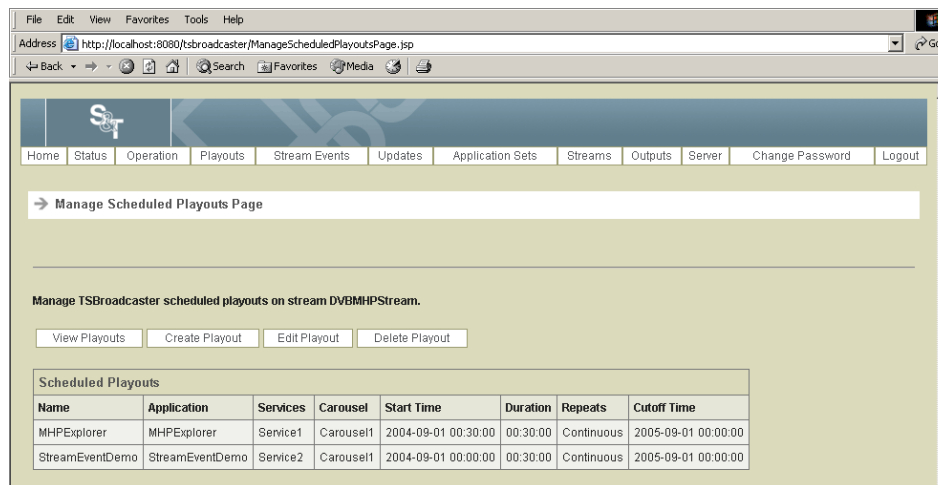

# Overview, Continued

## In This Chapter

This chapter contains the following topics.

<b>Topic</b>	<b>See Page</b>
View Scheduled Playouts	6-3
Change a Playout Time	6-5
Find Applications for a Service	6-7
Add a Playout	6-9
Edit a Playout	6-15
Break a Playout Into Two Independent Playouts	6-19
Manage Bit Rates	6-21
Delete a Playout	6-25

# View Scheduled Playouts

## Viewing Scheduled Playouts

To view scheduled playouts, complete the following steps.

1. Log in to the TSBroadcaster as a user with the appropriate privileges. See **Log In to the TSBroadcaster**, in Chapter 3.

**Result:** After a successful login, the Home Page opens.

2. Click the **Playouts** button from the navigation bar.

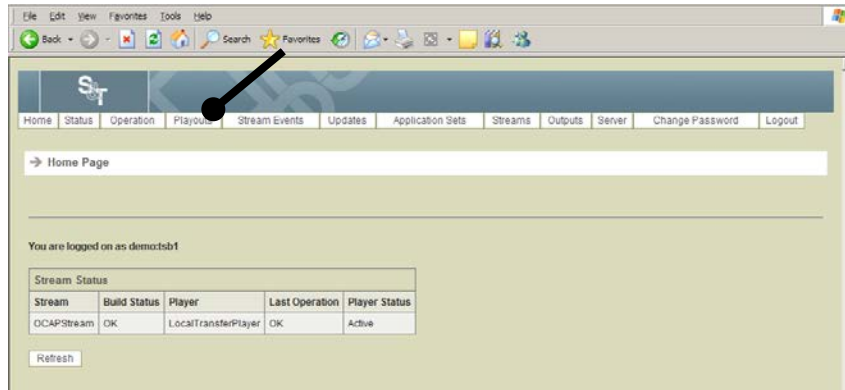

**Result:** The **Manage Scheduled Playouts Select Page** opens.

3. Select a TSBroadcaster stream for which you want to view the playout.

**Result:** The **Manage Scheduled Playout Page** opens.

# View Scheduled Playouts, Continued

4. Click the **View Playouts** button.

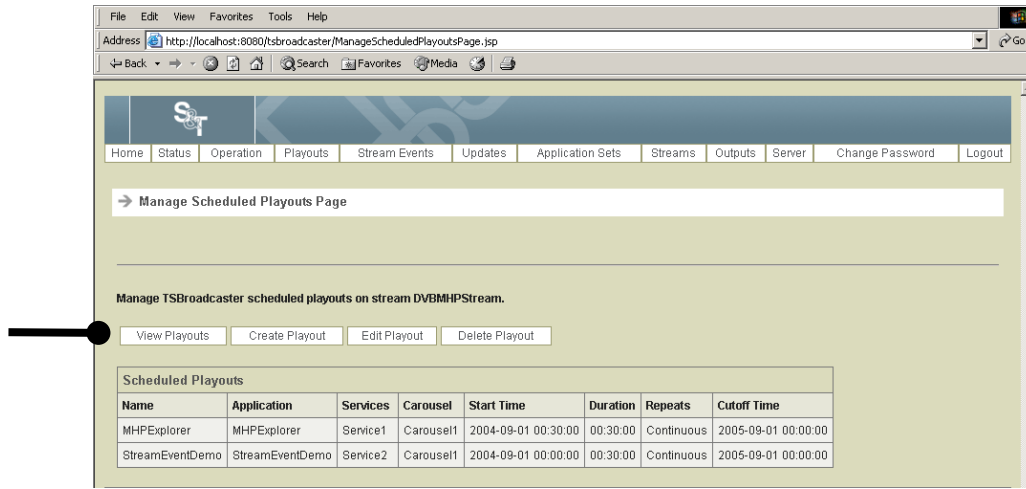

**Result:** The **View Scheduled Playouts Page** opens. This page contains a Java applet, showing a view of the scheduled playouts as bars on a time axis. If the applet fails to launch, consult **Java Applet Fails in Chapter 11, Troubleshooting**.

5. To see more information on a playout, select it by double-clicking on the bar.

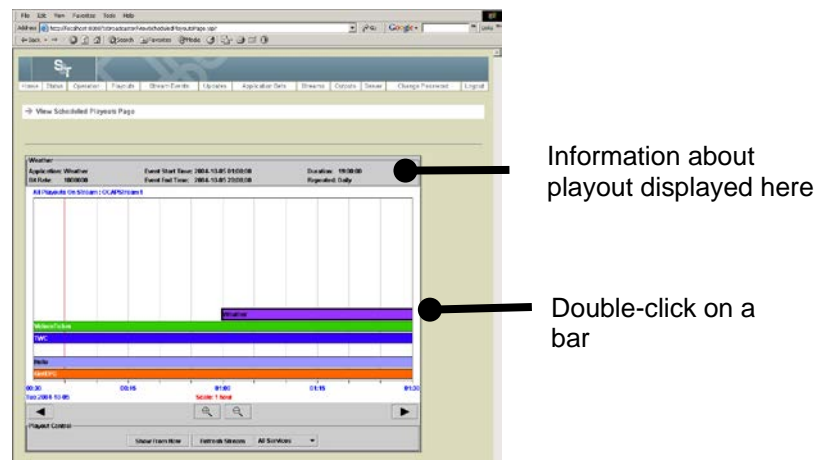

**Result:** The TSBroadcaster highlights the selected bar with a thick outline and displays information about the selected segment of the playout at the top of the graph.

# Change a Playout Time

## Introduction

The TSBroadcaster shows the current time as a red line on the display. The playout times allow you to see what is currently scheduled for playout.

## Changing a Playout Time

To change a playout time, complete the following steps.

1. Log in to the TSBroadcaster as a user with the appropriate privileges. See **Log In to the TSBroadcaster**, in Chapter 3.

**Result:** After a successful login, the Home Page opens.

2. Click the **Playouts** button from the navigation bar.

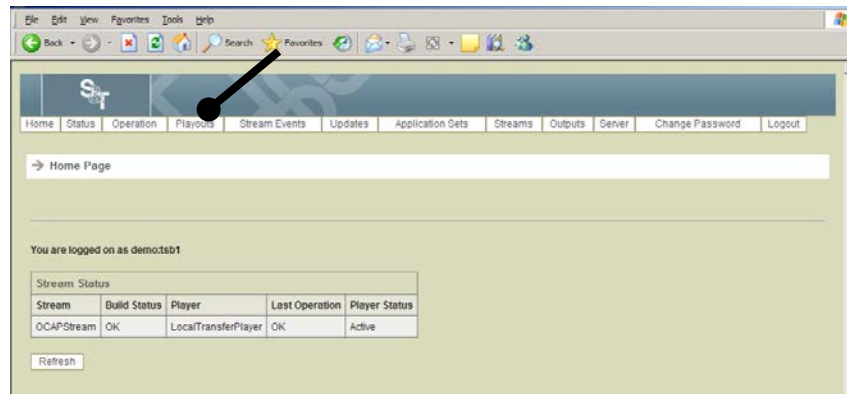

**Result:** The **Manage Scheduled Playouts Select Page** opens.

3. Select a TSBroadcaster stream for which you want to change a playout time.

**Result:** The Manage Scheduled Playout Page opens.

# Change a Playout Time, Continued

4. Click the **View Playouts** button.

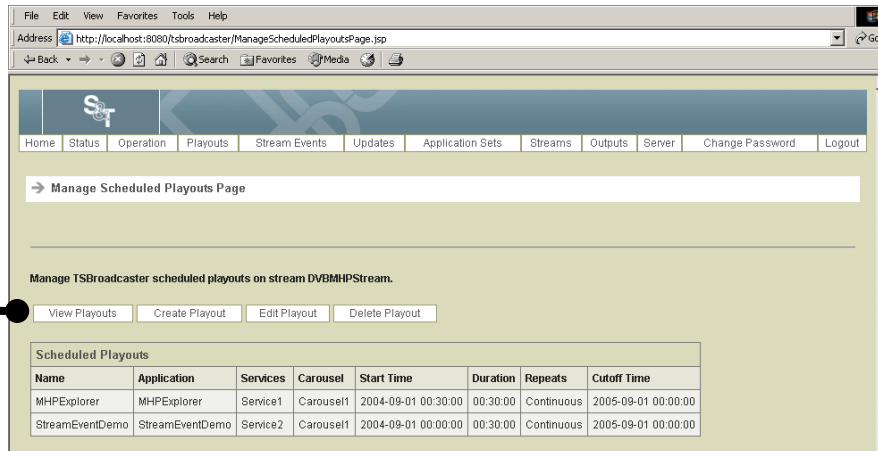

**Result:** The **View Scheduled Playouts Page** opens. This page contains a Java applet, showing a view of the scheduled playouts as bars on a time axis. If the applet fails to launch, consult **Java Applet Fails in Chapter 11**.

5. To change the time window, click the magnifying glass buttons to zoom in and out, and then click the left and right arrows to move backwards and forwards in time.

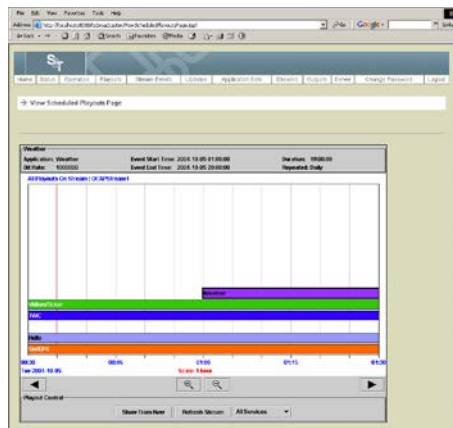

**Note:** To change the time window, you can also drag a bar in the middle to the new location and release it.

**Result:** The TSBroadcaster moves the playout to the new location.

6. Click the **Show From Now** button to move the origin so that it starts at the current time.

# Find Applications for a Service

## Finding Applications for a Service

To see which applications are being signaled on a particular service, complete the following steps.

1. Log in to the TSBroadcaster as a user with the appropriate privileges. See **Log In to the TSBroadcaster** earlier in Chapter 3.

**Result:** After a successful login, the **Home Page** opens.

2. Click the **Playouts** button from the navigation bar.

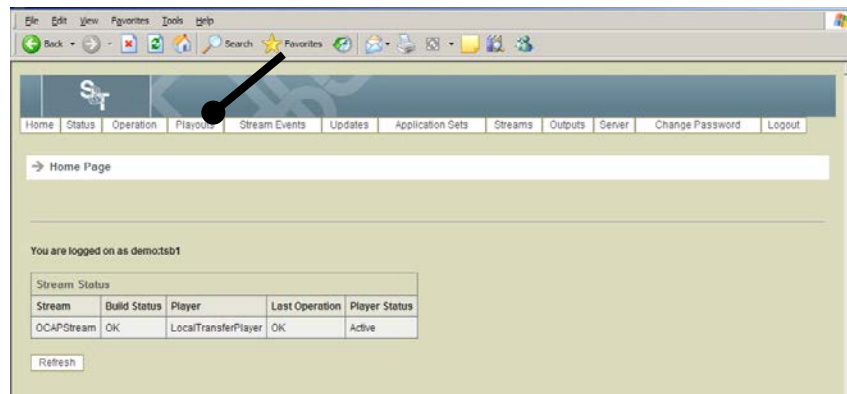

**Result:** The **Manage Scheduled Playouts Select Page** opens.

3. Select a TSBroadcaster stream for which you want to find applications for a service.

**Result:** The **Manage Scheduled Playout Page** opens.

# Find Applications for a Service, Continued

4. Click the **View Playouts** button.

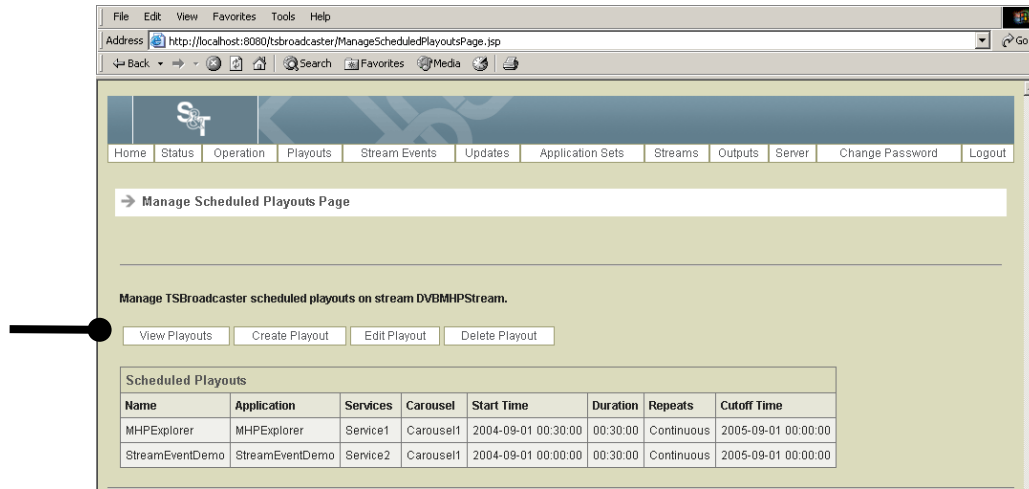

The **View Scheduled Playouts Page** opens. This page contains a Java applet, showing a view of the scheduled playouts as bars on a time axis. If the applet fails to launch, consult **Java Applet Fails** in **Chapter 11**.

5. Click the **All Services** drop-down selection and select the service. The TSBroadcaster refreshes the display every few seconds so that changes made to the scheduled playouts by other users are reflected on the screen.

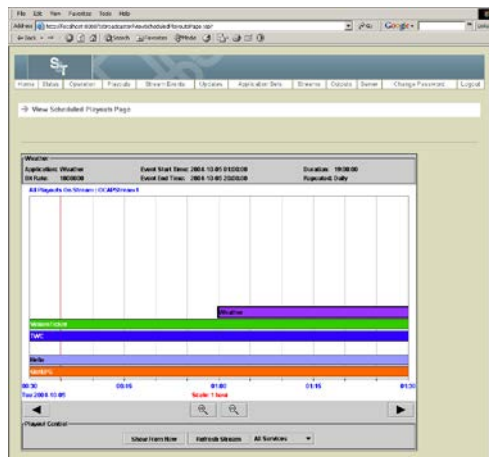

**Result:** Only the playouts that are signaled on that service are displayed.

# Add a Playout

## Introduction

You can add a playout in two ways. You can use the Create Playout button on the GUI, or you can double-click from the View Scheduled Playouts Page while you are viewing other playouts. Both methods are covered in this section.

## Method 1: Adding Playouts

To add a new playout with method 1, complete the following steps.

1. Log in to the TSBroadcaster as a user with the appropriate privileges. See **Log In to the TSBroadcaster**, in Chapter 3.

**Result:** After a successful login, the Home Page opens.

2. Click the **Playouts** button from the navigation bar.

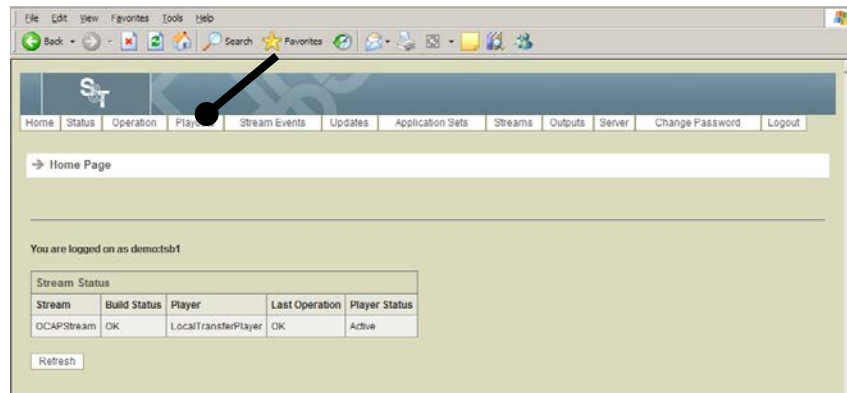

**Result:** The Manage Scheduled Select Playouts Page opens.

3. Select the stream for which you want to create a playout and click **Select**.

**Result:** The Manage Scheduled Playout Page opens.

# Add a **Playout**, Continued

4. Click the **Create Playout** button.

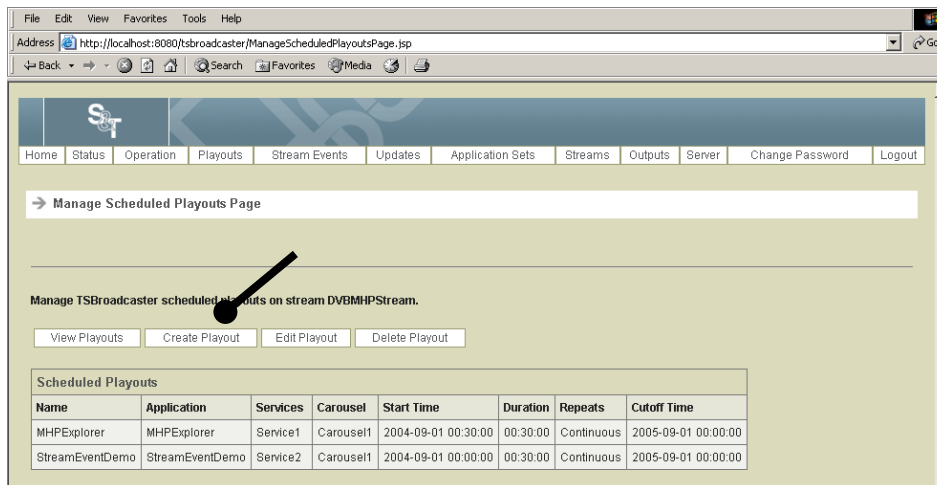

**Result:** The Create Scheduled Playout Page opens.

5. Enter the following information on the Create Scheduled Playout Page.

<b>Playout Name</b>	The name for the playout
<b>Description</b>	The description of the playout
<b>Application Set</b>	The name of the application set associated with the playout
<b>Colour</b>	The color for the playout bar. Enter the color n hexadecimal. For example, black is 0x000000 and white is 0xFFFFFF.
<b>Carousel</b>	The carousel that carries the application file system
<b>Bit Rate (bits/sec)</b>	The desired bit rate in bits per second for the application playout. This rate does not have to be the recommended bit rate
<b>Share Bit Rate</b>	A check box to indicate whether the playout should share any of the bit rate left over in the carousel after all the playouts have been allocated their nominated bit rate

## Add a Payout, Continued

<b>Control</b>	<p>The control code that is signaled for the applications in the application set. The control codes are:</p> <ul style="list-style-type: none"> <li>• <b>As Defined.</b> Applications use their own defined signaling</li> <li>• <b>Autostart.</b> Applications start automatically</li> <li>• <b>Present.</b> Applications are loaded to be started by some other application.</li> <li>• <b>Destroy.</b> Applications terminated gracefully (applications are automatically destroyed when a payout finishes).</li> <li>• <b>Kill.</b> Applications are terminated (applications are automatically destroyed when a payout finishes)</li> </ul>
<b>Start Time</b>	<p>The start time of the payout in the TSBroadcaster time zone. Use the following format for the start time: YYYY-MM-DD HH:MM:SS</p> <p><b>Example:</b> 2005-09-01 00:00:00</p>
<b>Duration</b>	<p>The duration of the payout. Use the following format for the duration: HH:MM:SS</p> <p><b>Example:</b> 00:30:00</p>
<b>Repeat Policy</b>	<p>The frequency that the payout is to be repeated. The values are:</p> <ul style="list-style-type: none"> <li>• <b>No.</b> Played for the stated duration once only</li> <li>• <b>Continuous.</b> Played continuously until the cut-off time</li> <li>• <b>Daily.</b> Played for the stated duration every day until the cut-off time</li> <li>• <b>Weekly.</b> Played for the stated duration every seven days until the cut-off time</li> </ul>
<b>Cut Off Time</b>	<p>The end time for repeated or continuous payouts. Use the following format for the start time: YYYY-MM-DD HH:MM:SS</p> <p><b>Example:</b> 2006-09-01 00:00:00</p>

## Add a Payout, Continued

<b>AppService</b>	A checkbox for each service to indicate whether the application set should be signaled on the service. If a service does not reference the object carousel that carries the application, the check box will be disabled for that service
<b>Parameters</b>	The application parameters to be signaled on each selected service. You can use these parameters to generate service-specific behavior
<b>Out Of Band (OCAP only)</b>	<p>A checkbox to indicate whether the application set should be signaled as an unbound application using OCAP XAIT signaling</p> <p>When you select the Out Of Band check box, the TSBroadcaster presents a dialog requesting the following parameters that are needed for out of band signaling:</p> <ul style="list-style-type: none"> <li>• <b>Abstract Service Name.</b> The name of the abstract service on which the payout will be signaled</li> <li>• <b>Abstract Service ID.</b> The integer identifier of the abstract service. The service ID should be 65537 (0x10001) to 10066329 (0x999999). The same ID can be assigned to multiple payouts.</li> <li>• <b>AutoSelect.</b> A check box to indicate whether the application is automatically selected</li> <li>• <b>Launch Order.</b> A numeric launch order</li> <li>• <b>Storage Priority.</b> The priority to indicate whether the application should be cached in the receiver</li> <li>• <b>Application Version number.</b> The version number of the application</li> </ul> <p><b>Note:</b> Enter the data as required and select the OK button to save the out-of-band signaling parameters. If you subsequently want to edit the parameters, double-click on the Out Of Band check box in the main dialog</p>

6. Click the **Save** button to create a new payout.

# Add a **Playout**, Continued

## Method 2: Adding **Playouts**

To add a new playout with method 2, complete the following steps.

1. Log in to the TSBroadcaster as a user with the appropriate privileges. See **Log In to the TSBroadcaster**, in Chapter 3.

**Result:** After a successful login, the Home Page opens.

2. Click the **Playouts** button from the navigation bar.

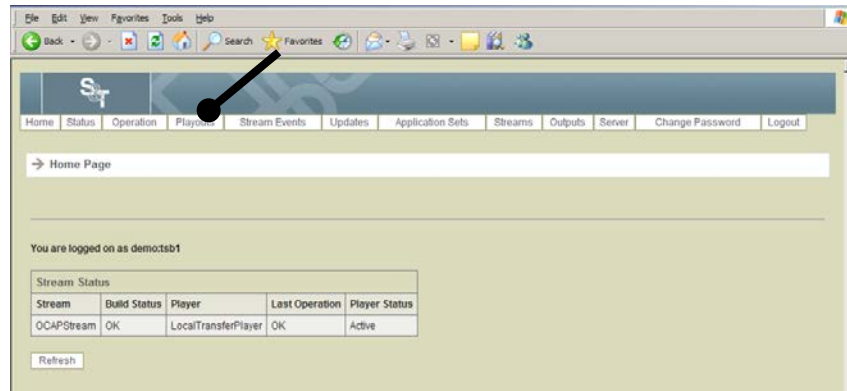

**Result:** The Manage Scheduled Playouts Select Page opens.

3. Select a TSBroadcaster stream for which you want to add a playout.

**Result:** The Manage Scheduled Playout Page opens.

4. Click the **View Playouts** button.

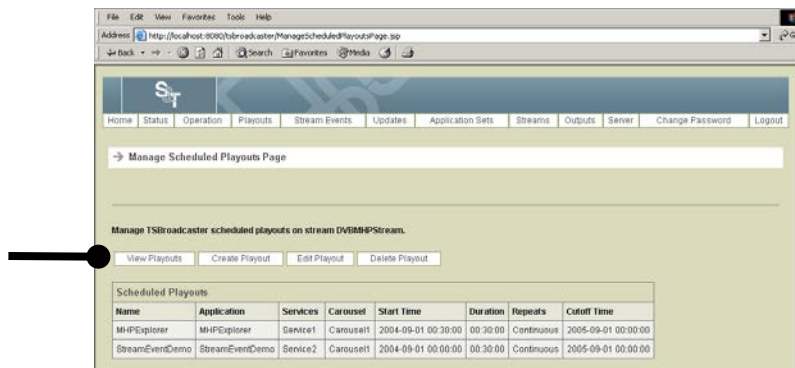

**Result:** The View Scheduled Playouts Page opens. This page contains a Java applet, showing a view of the scheduled playouts as bars on a time axis. If the applet fails to launch, consult **Java Applet Fails** in Chapter 11.

*Continued on next page*

## Add a **Playout**, Continued

5. Double-click on a blank area of the graph at the time you wish the application to start playing.

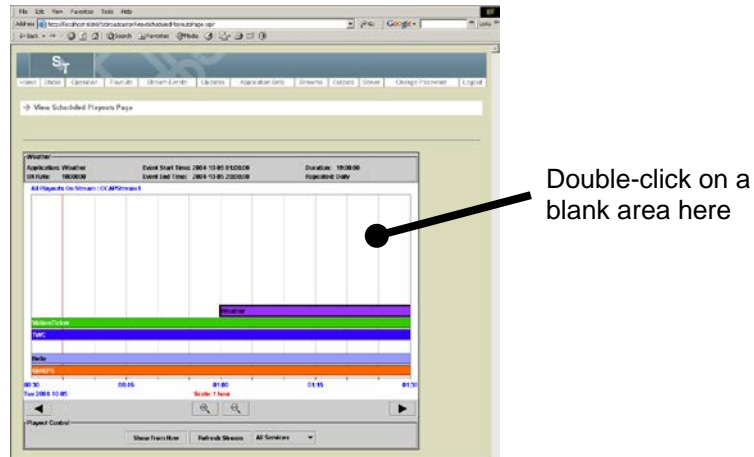

**Result:** The TSBroadcaster displays a New Playout dialog.

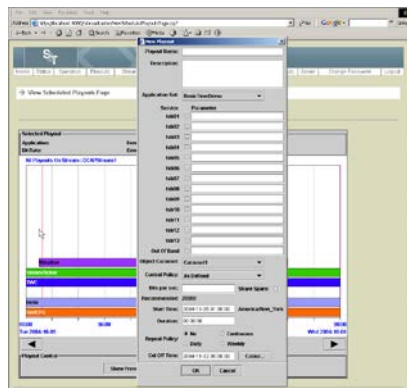

6. Complete the fields on the New Playout window. Use the field descriptions in **Method 1: Adding Playouts** to modify the playout information.
7. Click the **OK** button to save the new playout.

**Note:** If you have created a playout that is currently active, TSBroadcaster requests confirmation before creating the playout.

# Edit a Playout

## Introduction

You can edit a playout in two ways. You can use the Edit Playout button on the GUI, or you can double-click from the View Scheduled Playouts Page while you are viewing other playouts. Both methods are covered in this section.

## Method 1: Editing Playouts

To edit a playout with method 1, complete the following steps.

1. Log in to the TSBroadcaster as a user with the appropriate privileges. See **Log In to the TSBroadcaster**, in Chapter 3.

**Result:** After a successful login, the Home Page opens.

2. Click the **Playouts** button from the navigation bar.

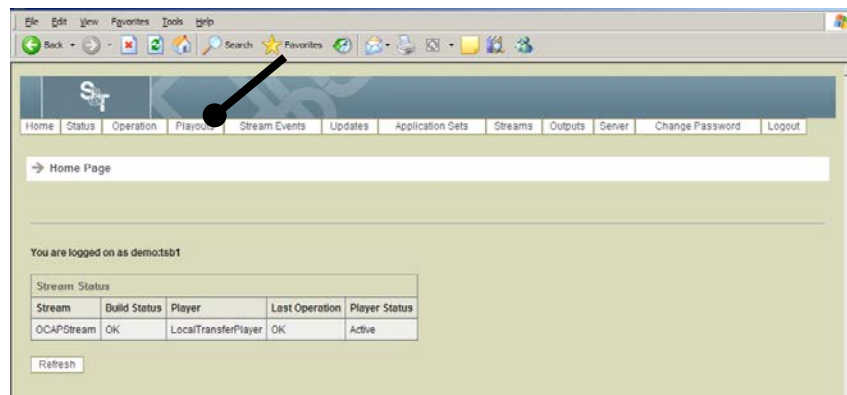

**Result:** The Manage Scheduled Select Playouts Page opens.

3. Select a stream for which you want to edit a playout and click **Select**.

**Result:** The Manage Scheduled Playout Page opens.

## Edit a Playout, Continued

4. Click the **Edit Playouts** button.

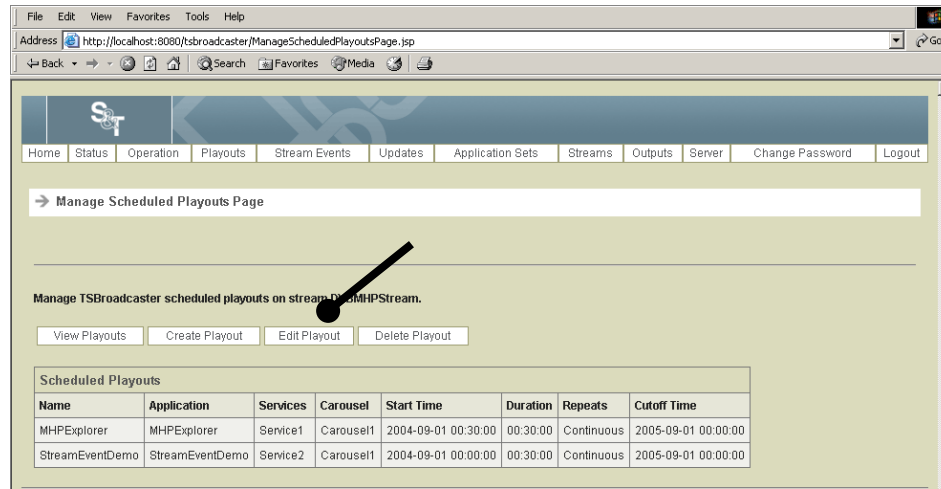

**Result:** The Edit Scheduled Playout Selection Page opens.

5. Select the playout you wish to edit and click **Select**.

**Result:** The Edit Scheduled Playouts Page opens. This page contains a Java applet, showing a view of the scheduled playouts as bars on a time axis. If the applet fails to launch, consult **Java Applet Fails** in **Chapter 11**.

6. Edit the playout information. For field descriptions, see **Method 1: Adding Playouts**, earlier in this chapter.
7. Click the **Save** button to save the changes to the playout.

# Edit a Playout, Continued

## Method 2: Editing a Playout

To edit a playout with method 2, complete the following steps.

1. Log in to the TSBroadcaster as a user with the appropriate privileges. See **Log In to the TSBroadcaster** earlier in Chapter 3.

**Result:** After a successful login, the Home Page opens.

2. Click the **Playouts** button from the navigation bar.

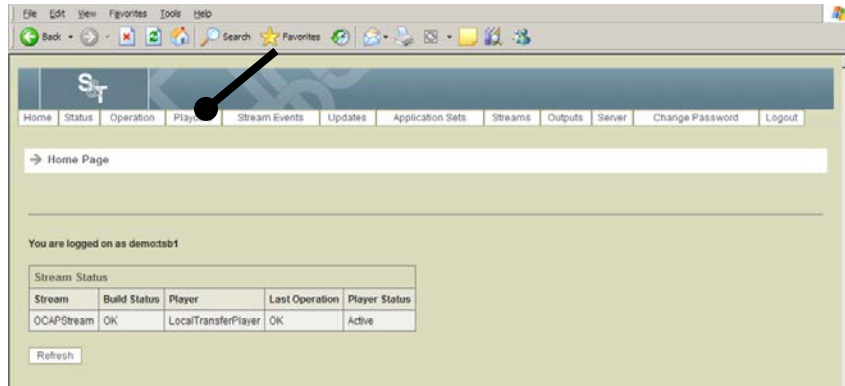

**Result:** The Manage Scheduled Playouts Select Page opens.

3. Select a TSBroadcaster stream for which you want to edit a playout.

**Result:** The Manage Scheduled Playout Page opens.

4. Click the **View Playouts** button.

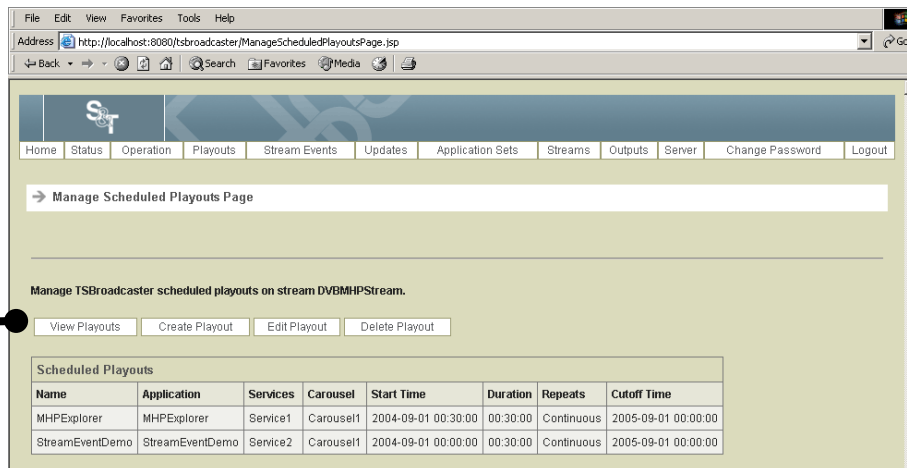

**Result:** The View Scheduled Playouts Page opens. This page contains a Java applet, showing a view of the scheduled playouts as bars on a time axis. If the applet fails to launch, consult **Java Applet Fails** in Chapter 11.

## Edit a Playout, Continued

5. Double-click on the playout bar that you wish to edit.

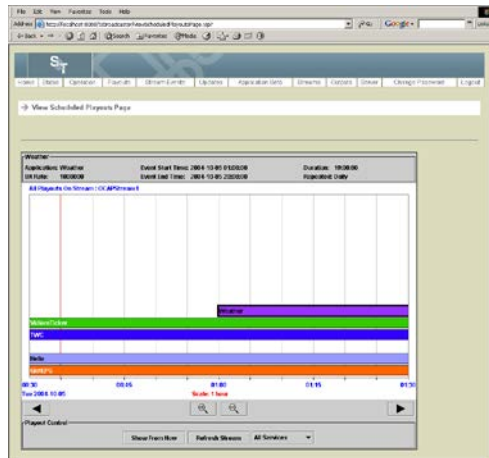

**Result:** The TSBroadcaster displays an **Edit Playout** dialog.

6. Edit any of the information that you want to change on the Edit Playout screen. For field descriptions, see **Method 1: Adding Playouts**, earlier in this chapter.
7. Click the **OK** button to save any changes to the playout.

# Break a Playout Into Two Independent Playouts

## Introduction

In some cases, you may need to change a particular attribute of a repeated playout during its run, without changing the entire run. You can break a playout into two independent playouts. Either playout can be changed independently.

## Breaking a Playout Into Two Independent Playouts

To break a playout into two independent playouts, complete the following steps.

1. Log in to the TSBroadcaster as a user with the appropriate privileges. See **Log In to the TSBroadcaster**, in Chapter 3.

After a successful login, the Home Page opens.

2. Click the **Playouts** button from the navigation bar.

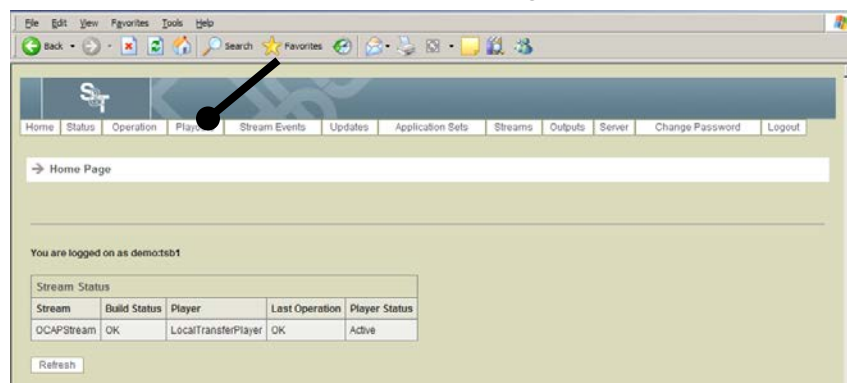

**Result:** The Manage Scheduled Playouts Select Page opens.

3. Select a TSBroadcaster stream for which you want to delete a playout.

**Result:** The Manage Scheduled Playout Page opens.

4. Click the **View Playouts** button.

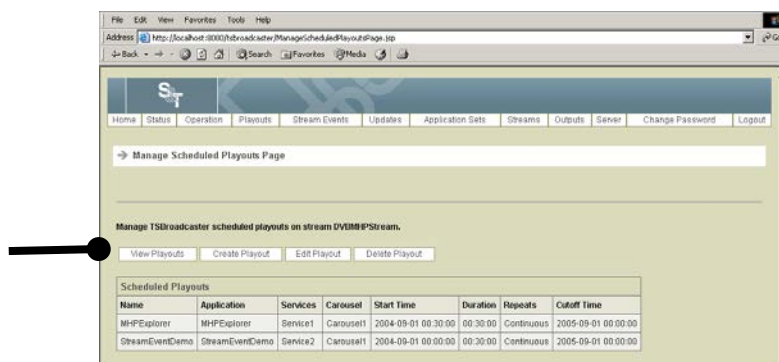

**Result:** The **View Scheduled Playouts Page** opens. This page contains a Java applet, showing a view of the scheduled playouts as bars on a time axis. If the applet fails to launch, consult **Java Applet Fails** in Chapter 11.

## Break a Playout Into Two Independent Playouts, Continued

5. Right-click on the bar representing the first playout that you wish to change.

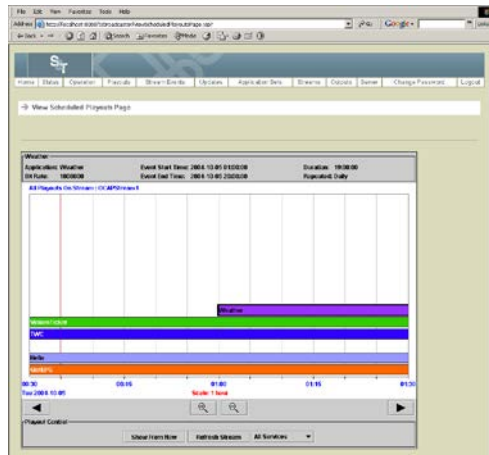

**Result:** A popup window appears with a Start Again option.

**Note:** The Start Again option is not available for a continuous playout.

6. Click the **Start Again** button.

**Result:** You are prompted for a name for a new playout.

7. Enter a name for the playout.

**Result:** The playout will be split into two at the selected point.

# Manage Bit Rates

## Introduction

The total carousel bit rate is partitioned so that each playout is allocated its nominated bit rate, plus, if requested, a share of any spare bit rate left over in the carousel. If an application set is required by more than one playout concurrently, then a single instance is shared between all the playouts that reference it.

## Managing Bit Rates

To see how the bit rate is being allocated in a particular carousel, complete the following steps.

1. Log in to the TSBroadcaster as a user with the appropriate privileges. See **Log In to the TSBroadcaster**, in Chapter 3.

After a successful login, the Home Page opens.

2. Click the **Playouts** button from the navigation bar.

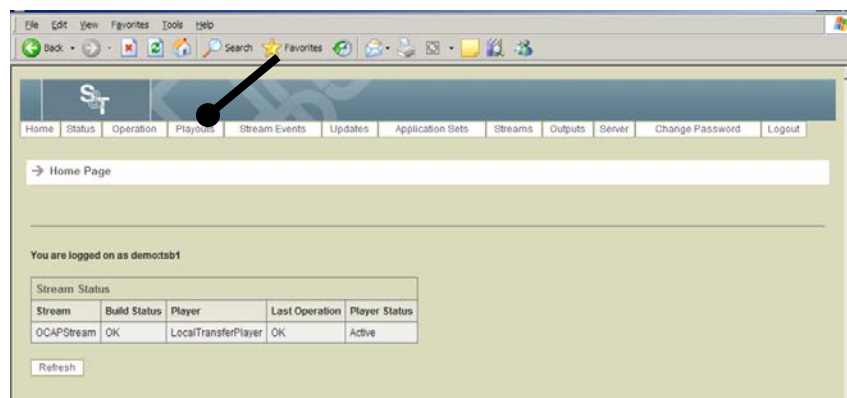

**Result:** The Manage Scheduled Select Playouts Page opens.

3. Select the stream for which you want to manage bit rates and click **Select**.

**Result:** The Manage Scheduled Playout Page opens.

# Manage Bit Rates, Continued

4. Click the **View Playouts** button.

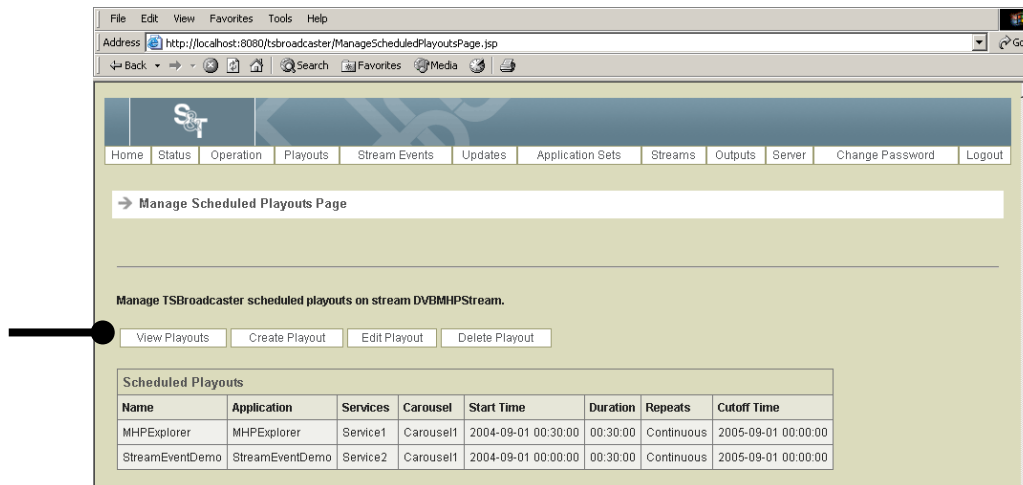

**Result:** The **View Scheduled Playouts Page** opens. This page contains a Java applet, showing a view of the scheduled playouts as bars on a time axis. If the applet fails to launch, consult **Java Applet Fails in Chapter 11**.

5. Click the **All Services** button.

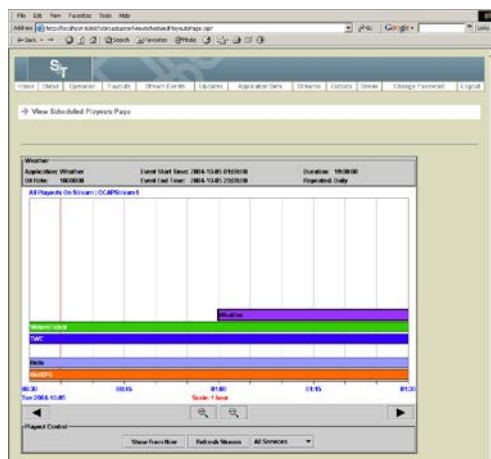

**Result:** A list of services on the carousel appears in a drop-down list.

# Manage Bit Rates, Continued

6. Select the carousel you want to work with.

## Results:

- The view will now show the bit rate allocation for applications over time. If you move the cursor over the display, readout will be presented showing the playout name, the application set name, the requested bit rate and the allocated bit rate.

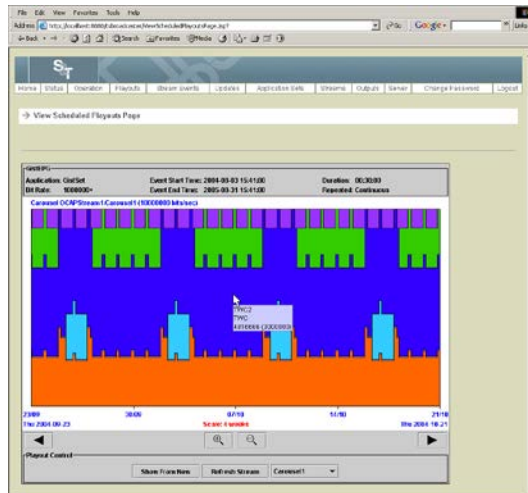

- If more bit rate is requested than is available, the graph shows a pink area to indicate that the playouts are over budget.

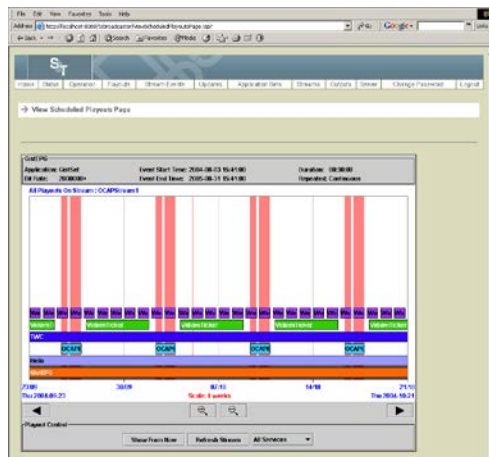

## Manage Bit Rates, Continued

- The basic bit rates for each application set are all scaled down by the same percentage to make the applications fit within the carousel budget.

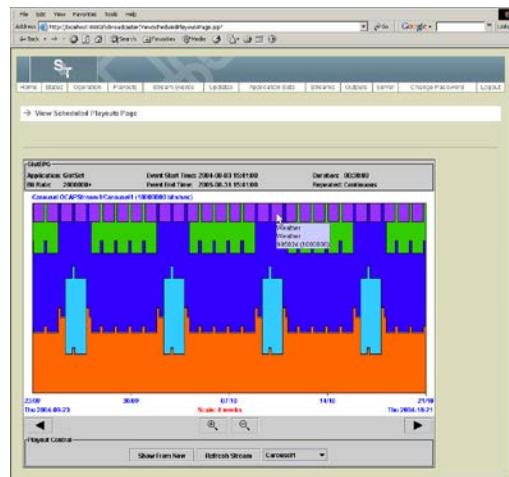

# Delete a Playout

## Introduction

You can delete a playout in two ways. You can use the Delete Playout button on the GUI, or you can right-click from the View Scheduled Playouts Page while you are viewing playouts. Both methods are covered in this section.

## Method 1: Deleting Playouts

To delete a playout with method 1, complete the following steps.

1. Log in to the TSBroadcaster as a user with the appropriate privileges. See **Log In to the TSBroadcaster**, in Chapter 3.

**Result:** After a successful login, the **Home Page** opens.

2. Click the **Playouts** button from the navigation bar.

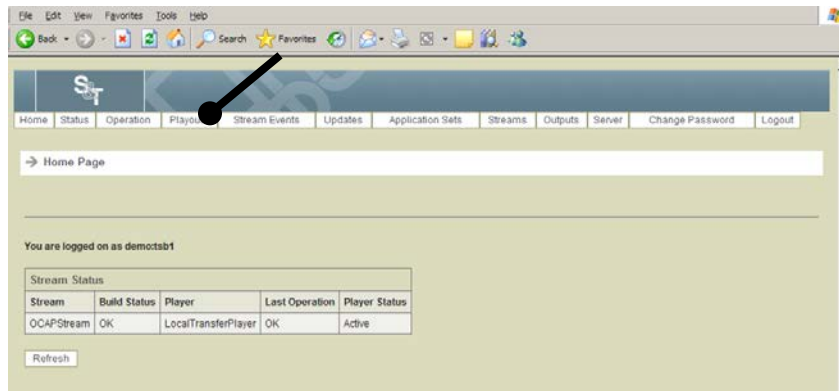

**Result:** The Manage Scheduled Select Playouts Page opens.

3. Select a stream for which you want to delete a playout and click **Select**.

**Result:** The Manage Scheduled Playout Page opens.

# Delete a Payout, Continued

4. Click the **Delete Playouts** button.

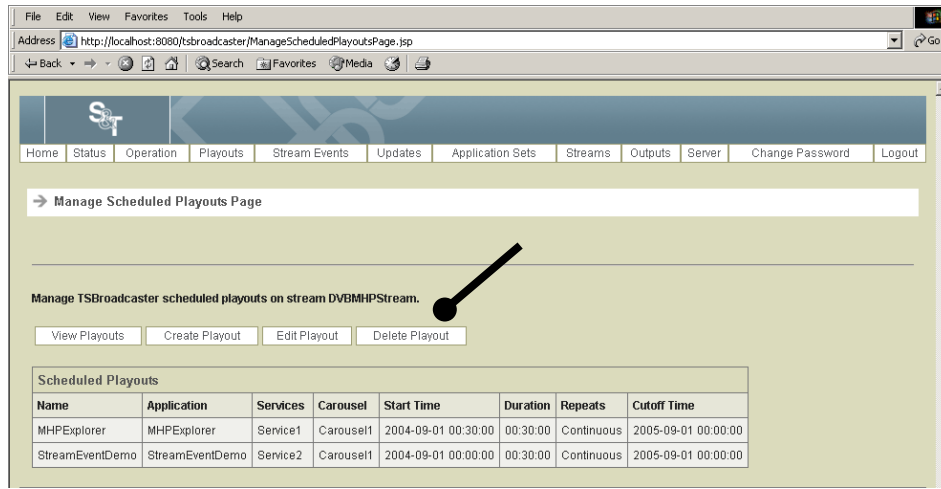

**Result:** The Delete Scheduled Playout Select Page opens.

5. Select the payout you wish to delete
6. Select the **Delete** button to delete the payout.

## Method 2: Deleting Playouts

To delete a payout with method 2, complete the following steps.

1. Log in to the TSBroadcaster as a user with the appropriate privileges. See **Log In to the TSBroadcaster** earlier in Chapter 3.

**Result:** After a successful login, the **Home Page** opens.

2. Click the **Playouts** button from the navigation bar.

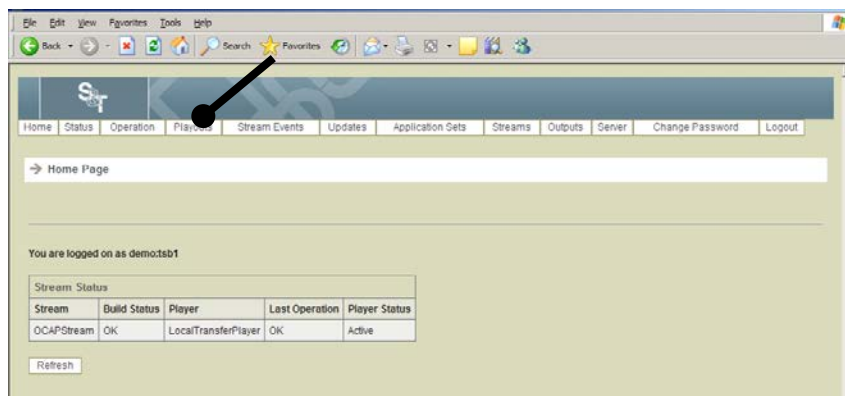

**Result:** The Manage Scheduled Playouts Select Page opens.

# Delete a Playout, Continued

3. Select a TSBroadcaster stream for which you want to delete a playout.  
**Result:** The Manage Scheduled Playout Page opens.
4. Click the **View Playouts** button.

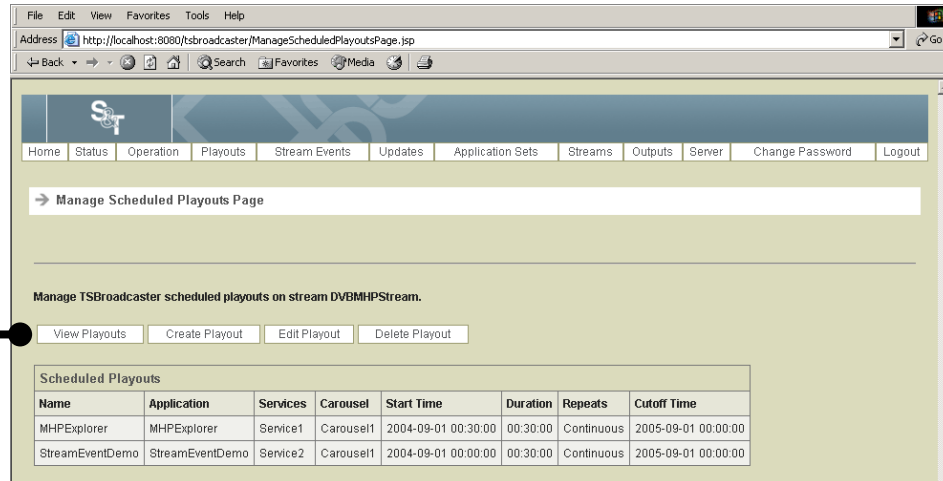

**Result:** The **View Scheduled Playouts Page** opens. This page contains a Java applet, showing a view of the scheduled playouts as bars on a time axis. If the applet fails to launch, consult **Java Applet Fails in Chapter 11**.

5. Right-click on the bar for the playout that you want to delete and select **Remove** from the pop-up menu.

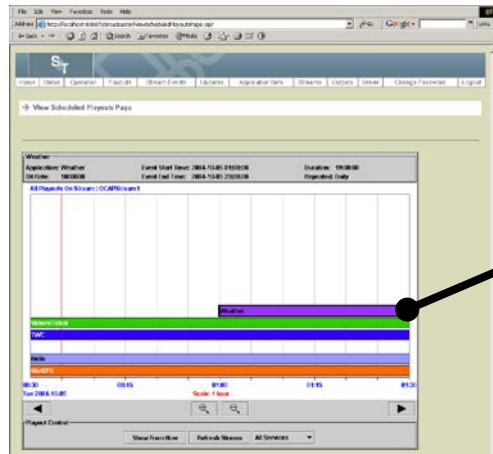

**Result:** The system displays a prompt asking if you want to remove the playout.

6. At the prompt, click **Yes** to delete the playout.

# Chapter 7

## Managing Updates

### Overview

#### Introduction

The TSBroadcaster allows you to update files and directories in application sets while they are being played out.

#### Types of Updates

Two types of updates are supported:

- **Polled updates.** The TSBroadcaster reads data from a specified URL and copies the data found at the URL to the specified location in the file system of an application set. The TSBroadcaster will continue to poll the URL at the specified rate, and it will automatically update the specified location whenever it detects a change in the data from the URL. The TSBroadcaster starts monitoring polled updates a short time before an application set is due to be broadcast. This type of update allows the current data to be in place when the application launches.
- **On-demand updates.** The TSBroadcaster provides a command interface to create and delete files and directories in the file system of an application set, and also to update files and directories with new content.

The type of update you should select for an application depends on the nature of the updates, the requirements for response time, the number of elements being updated, and the processing infrastructure available for producing updates.

In both polled and on-demand updates, updated content is handled differently for files and directories as follows:

- If the target of the update is a file, the TSBroadcaster reads the content from the URL and uses it to replace the existing content of the file.
- If the target of the update is a directory, the URL must contain data in a zip archive format. The TSBroadcaster assumes that the content read from the URL is a zip archive, and unzips the content to obtain a file system. The TSBroadcaster then replaces the entire sub-tree below the target directory with the file system from the zip archive in a single operation.

# Overview, Continued

## How Updates Work

The TSBroadcaster updates the content of the output transport stream when the file system changes. If the updated file is selected for rapid update and the new content fits within the maximum size of the file, the update is preemptively inserted into the output transport stream. In all other cases, the carousel is re-built, allowing the module structure to adapt to the new content. This process takes longer than a rapid update, and is subject to a minimum rebuild interval to ensure carousel stability.

When the TSBroadcaster performs an update, it does *not* change the application set. An update changes the copy of the application set that is currently being played out. When the playout stops, all updates are lost. Whenever an application starts being played out, it will start playing out its original content with polled updates re-applied, if necessary.

## In This Chapter

This chapter contains the following topics.

Topic	See Page
Create Polled Update	7-3
Edit Polled Update	7-5
Delete Polled Update	7-7
Add a Directory to the Application Set	7-8
Add a File to the Application Set	7-10
Update an Object	7-12
Update a Text File	7-14
Remove an Object	7-16

# Create Polled Update

## Creating Polled Updates

To create a polled update, complete the following steps.

1. Log in to the TSBroadcaster as a user with the appropriate privileges. See **Log In to the TSBroadcaster**, in Chapter 3.

**Result:** After a successful login, the Home Page.

2. Click the **Updates** button from the navigation bar.

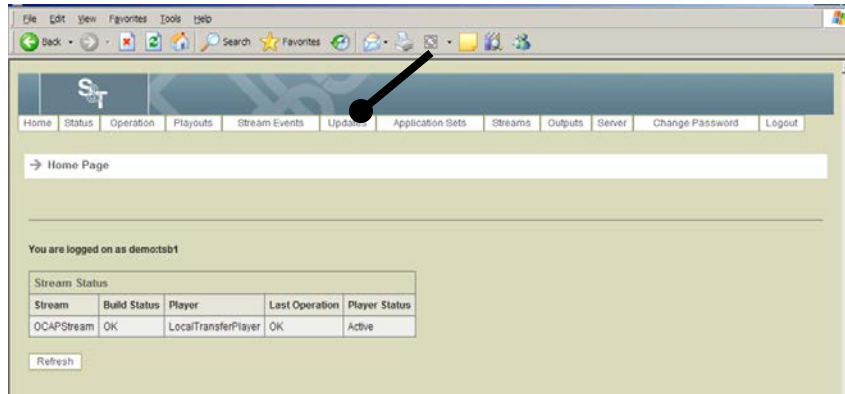

**Result:** The Manage Applications Set Updates Select Page opens.

3. Select an application set and click **Select**.

**Result:** The Manage Updates Page opens.

4. Click the **Create Update** button.

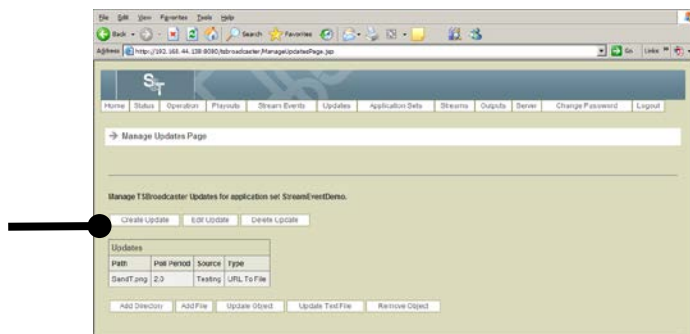

**Result:** The Create Update Page opens.

## Create Polled Update, Continued

5. Enter the following information on the Create Update Page.

<b>Path</b>	The path of the file or directory to be updated in the application set
<b>Poll Period</b>	The poll period in seconds
<b>Source</b>	The URL to be polled. The source data is handled as follows: <ul style="list-style-type: none"><li>• If the path points to a directory in the application set, the TSBroadcaster treats the data retrieved from the URL as a zip archive and replaces the content of the directory with the file system from the zip archive</li><li>• If the path points to a file in the application set, the TSBroadcaster replaces the data in the file with the data retrieved from the URL if a file inside the zip file has changed.</li></ul>

6. Click the **Save** button to create a new polled update.

# Edit Polled Update

## Editing a Polled Update

To edit a polled update, complete the following steps.

1. Log in to the TSBroadcaster as a user with the appropriate privileges. See **Log In to the TSBroadcaster**, in Chapter 3.

**Result:** After a successful login, the **Home Page** opens.

2. Click the **Updates** button from the navigation bar.

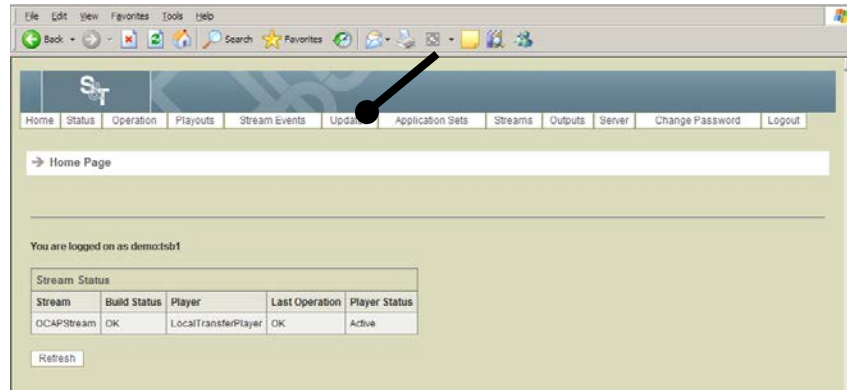

**Result:** The Manage Applications Set Updates Select Page opens.

3. Select an application set and click **Select**.

**Result:** The Manage Updates Page opens.

4. Select the Updates you want to edit and click the **Edit Update** button.

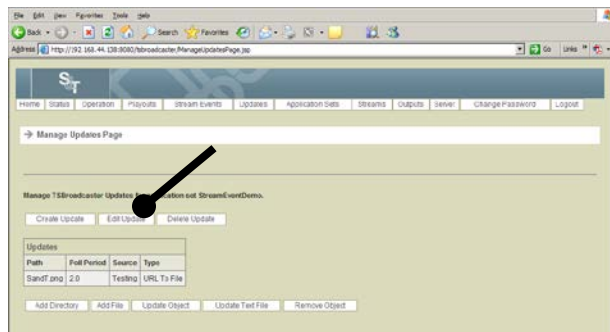

**Result:** The Edit Update Select Page opens.

## Edit Polled Update, Continued

5. Select the path for the update you want to edit and click **Select**.

**Result:** The Edit Update Page opens.

6. Edit the update information. For field descriptions, see **Create Polled Update**, earlier in this chapter.
7. Click the **Save** button to save the changes to the polled update.

**Result:** The TSBroadcaster will re-start polling to ensure that the new content is acquired immediately.

# Delete Polled Update

## Deleting a Polled Update

To delete a polled update, complete the following steps.

1. Log in to the TSBroadcaster as a user with the appropriate privileges. See **Log In to the TSBroadcaster**, in Chapter 3.

**Result:** After a successful login, the Home Page opens.

2. Click the **Updates** button from the navigation bar.

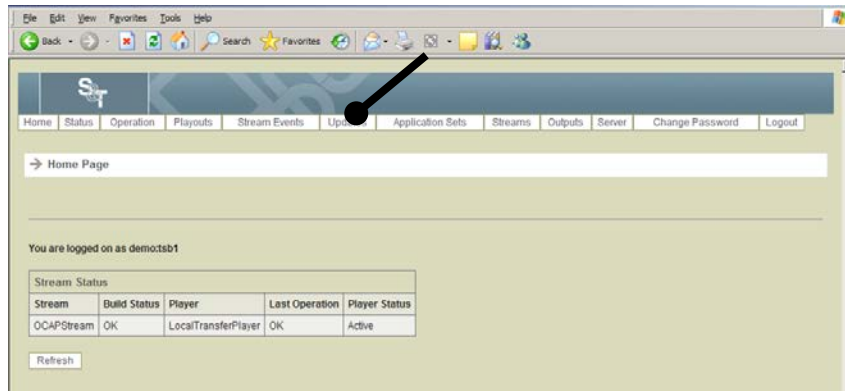

**Result:** The Manage Applications Set Updates Select Page opens.

3. Select an application set and click **Select**.

**Result:** The **Manage Updates Page** opens.

4. Click the **Delete Update** button.

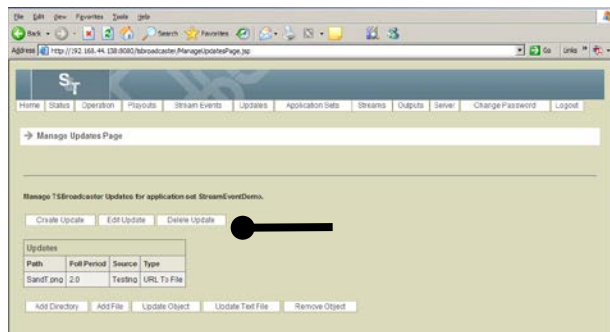

**Result:** The Delete Update Page opens.

5. Select the polled update you wish to delete and click **Delete** to delete the polled update.

**Result:** The contents of the file or directory that were updated by the polled update are left unchanged.

# Add a Directory to the Application Set

## Adding a Directory

To add a directory to the Application set, complete the following steps.

1. Log in to the TSBroadcaster as a user with the appropriate privileges. See **Log In to the TSBroadcaster** earlier in Chapter 3.

After a successful login, the Home Page opens.

2. Click the **Updates** button from the navigation bar.

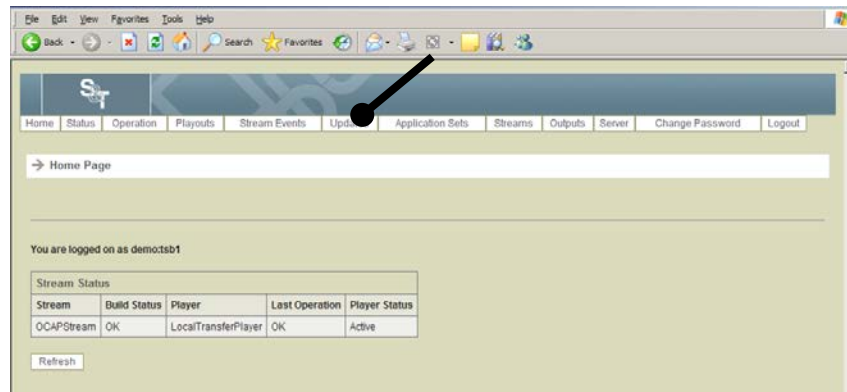

**Result:** The Manage Applications Set Updates Select Page opens.

3. Select an application set and click **Select**.

**Result:** The Manage Updates Page opens.

4. Click the **Add Directory** button.

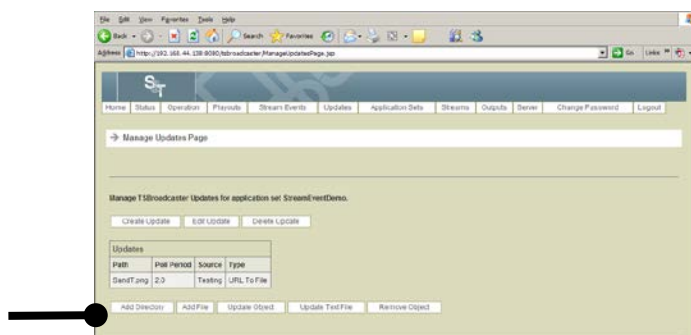

**Result:** The Add Directory Page opens.

## Add a Directory to the Application Set, Continued

5. Enter the following information on the Add Directory Page.

<b>Path</b>	The path of the new directory in the application set. The new directory's parent directory must be an existing directory
<b>Group</b>	The name of the group containing the new directory. If the group does not exist, it will be created as an uncompressed group with a priority of one

6. Click the **Add** button to create a new, empty directory in the application set.

# Add a File to the Application Set

## Adding a File

To add a file to the application set, complete the following steps.

1. Log in to the TSBroadcaster as a user with the appropriate privileges. See **Log In to the TSBroadcaster**, in Chapter 3.

**Result:** After a successful login, the Home Page opens.

2. Click the **Updates** button from the navigation bar.

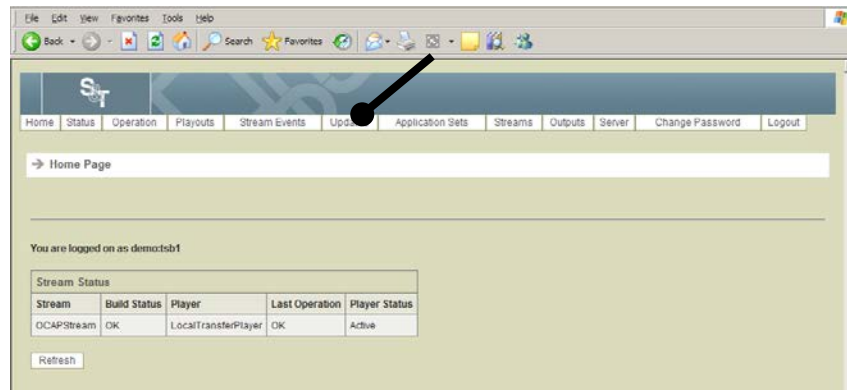

**Result:** The Manage Applications Set Updates Select Page opens.

3. Select an application set and click **Select**.

**Result:** The Manage Updates Page opens.

4. Click the **Add File** button.

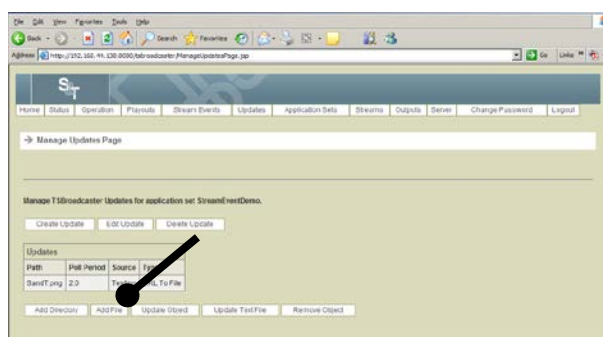

**Result:** The Add File Page opens.

## Add a File to the Application Set, Continued

5. Enter the following information on the Add File Page.

<b>Path</b>	The path of the new file in the application set. The new file's parent directory must be an existing directory
<b>Group</b>	The name of the group containing the new file. If the group does not exist, it will be created as an uncompressed group with a priority of one
<b>Content</b>	The file on the client machine that will be used to supply the initial data for the new file
<b>Rapid Update</b>	A check box to indicate whether the file is subject to rapid updates. If this box is checked, then updates to the file will be delivered with low latency. The size reserved for the rapid update file is set to the size of the client file used to provide the initial content

6. Click the **Add** button to create a new file for the update.

# Update an Object

## Updating an Object

To update an object, complete the following steps.

1. Log in to the TSBroadcaster as a user with the appropriate privileges. See **Log In to the TSBroadcaster**, in Chapter 3.

**Result:** After a successful login, the Home Page opens.

2. Click the **Updates** button from the navigation bar.

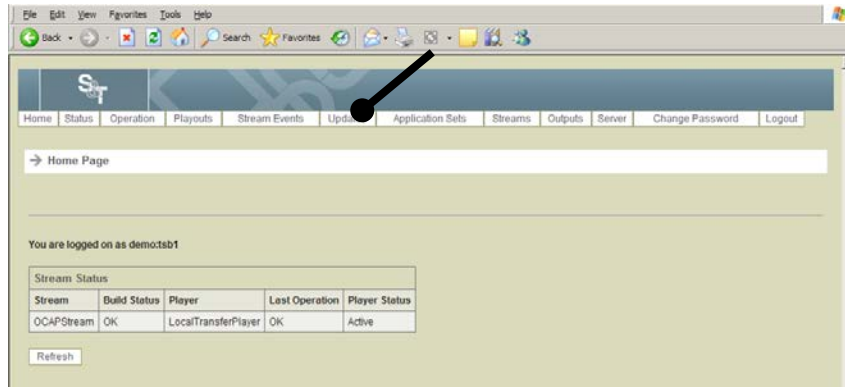

**Result:** The Manage Applications Set Updates Select Page opens.

3. Select an application set and click **Select**.

**Result:** The Manage Updates Page opens.

4. Click the **Update Object** button.

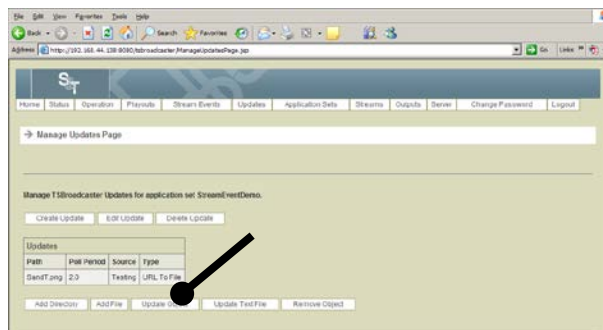

**Result:** The Update Object Page opens.

## Update an Object, Continued

5. Enter the following information on the Update Object Page.

<b>Path</b>	The path of the object in the application set. The new object's parent directory must be an existing directory.
<b>New Content</b>	The path for the file in the client file system that provides the data. The new content can point to two different paths: <ul style="list-style-type: none"><li>• If the path points to a directory in the application set, the TSBroadcaster will treat the data retrieved from the file as a zip archive and replace the content of the directory with the file system from the zip archive.</li><li>• If the path points to a file in the application set, the TSBroadcaster will replace the data in the file with the data retrieved from the file</li></ul>

6. Click the **Update** button to update the object in the application set.

# Update a Text File

## Updating a Text File

To update a text file, complete the following steps.

1. Log in to the TSBroadcaster as a user with the appropriate privileges. See **Log In to the TSBroadcaster**, in Chapter 3.

**Result:** After a successful login, the **Home Page** opens.

2. Click the **Updates** button from the navigation bar.

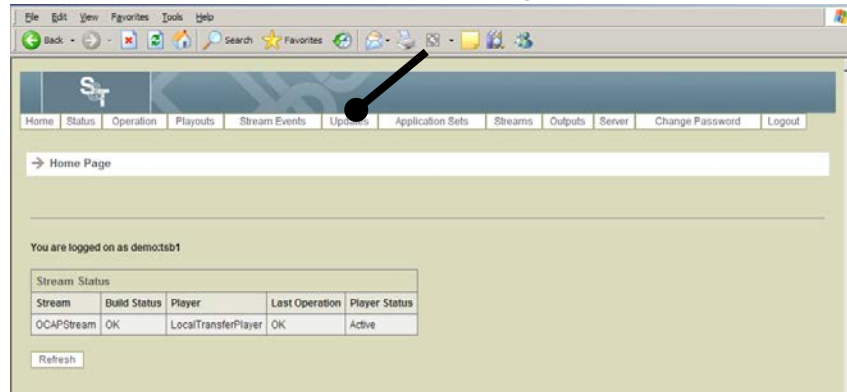

**Result:** The Manage Applications Set Updates Select Page opens.

3. Select an application set and click **Select**.

**Result:** The Manage Updates Page opens.

4. Click the **Update Text File** button.

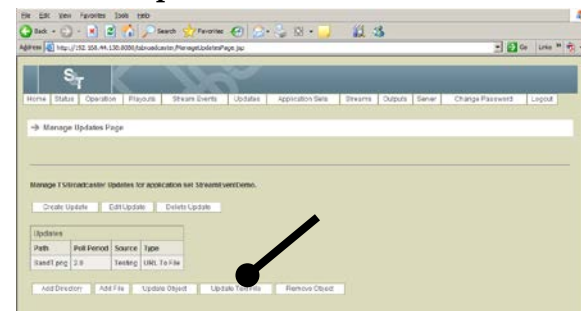

**Result:** The Update Text File Page opens.

## Update a Text File, Continued

5. Enter the following information on the **Update Text File** Page.

<b>Path</b>	The path of the object in the application set. The object must be an existing file.
<b>New Text</b>	The text that you want to use to replace the existing text in the file.

6. Click the **Update** button to update the text file.

# Remove an Object

## Removing an Object

To remove an object, complete the following steps.

1. Log in to the TSBroadcaster as a user with the appropriate privileges. See **Log In to the TSBroadcaster**, in Chapter 3.

**Result:** After a successful login, the Home Page opens.

2. Click the **Updates** button from the navigation bar.

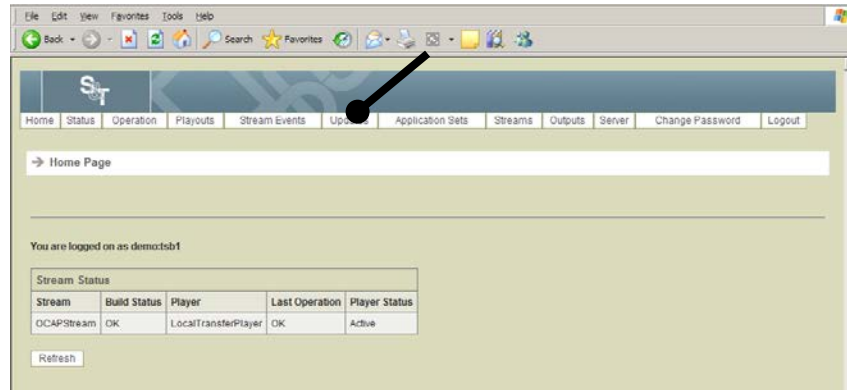

**Result:** The Manage Applications Set Updates Select Page opens.

3. Select an application set and click **Select**.

**Result:** The Manage Updates Page opens.

4. Click **Remove Object** button.

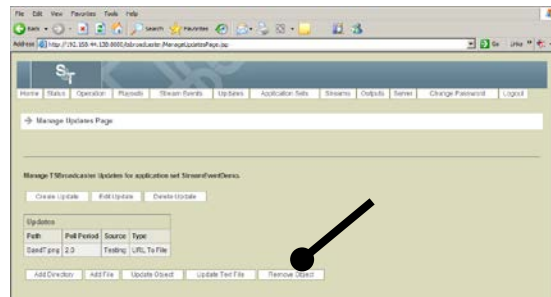

**Result:** The Remove Object Page opens.

5. Enter the path of the object that you want to remove from the application set.
6. Click the **Remove** button to remove the selected object from the application set.

# Chapter 8

## Managing Stream Events

### Overview

#### Introduction

The TSBroadcaster allows you to inject stream events for application sets while they are being played out.

The stream event management functions are available to users who have the OperateStreamEvents privilege.

#### In This Chapter

This chapter contains the following topics.

Topic	See Page
Send a Defined Stream Event	8-2
Inject a Free Stream Event	8-4

# Send a Defined Stream Event

## Introduction

You can use the TSBroadcaster to send a defined stream event. A defined stream event is an application that is displayed immediately on the defined stream.

## Prerequisite

To send a defined stream event you must have defined a stream event in the application set.

## Sending a Defined Stream Event

To send a defined stream event, complete the following step.

1. Log in to the TSBroadcaster as a user with the appropriate privileges. See **Log In to the TSBroadcaster**, in Chapter 3.

**Result:** After a successful login, the Home Page opens.

2. Click the **Stream Events** button from the navigation bar.

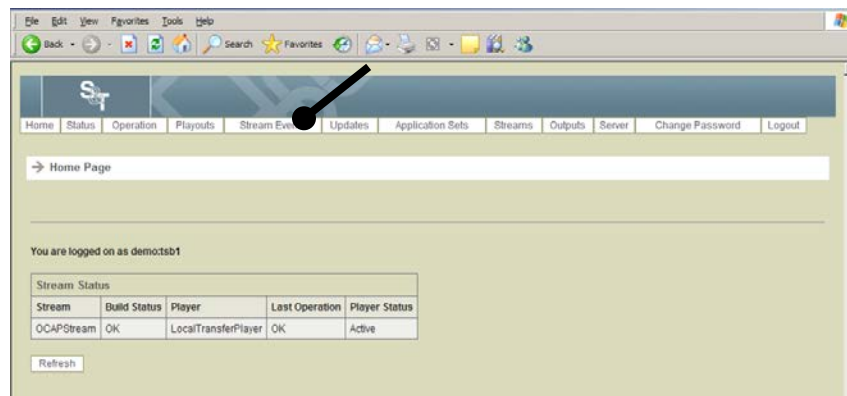

**Result:** The Manage Stream Event Select Page opens.

3. Select a Stream Definition for which you want to manage stream events and click **Select**.

**Result:** The Manage Stream Event Page opens.

4. Enter the data you wish to send next to the stream event.

# Send a Defined Stream Event, Continued

5. Click the **Send** button next to the data you just entered.

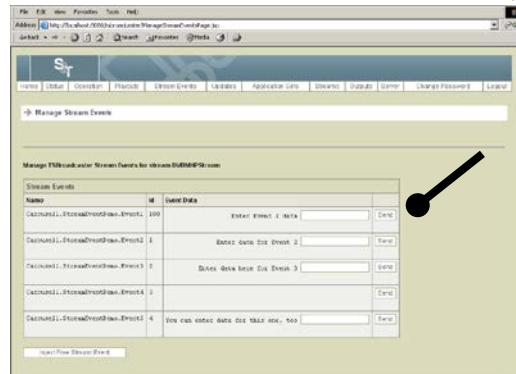

**Result:** The stream event will appear on the receiver very shortly afterwards. Typically the event will appear in 5 seconds, but it may take up to 30 seconds.

# Inject a Free Stream Event

## Injecting a Free Stream Event

To inject a free stream event, complete the following steps.

1. Log in to the TSBroadcaster as a user with the appropriate privileges. See **Log In to the TSBroadcaster**, in Chapter 3.

**Result:** After a successful login, the Home Page opens.

2. Click the **Stream Events** button from the navigation bar.

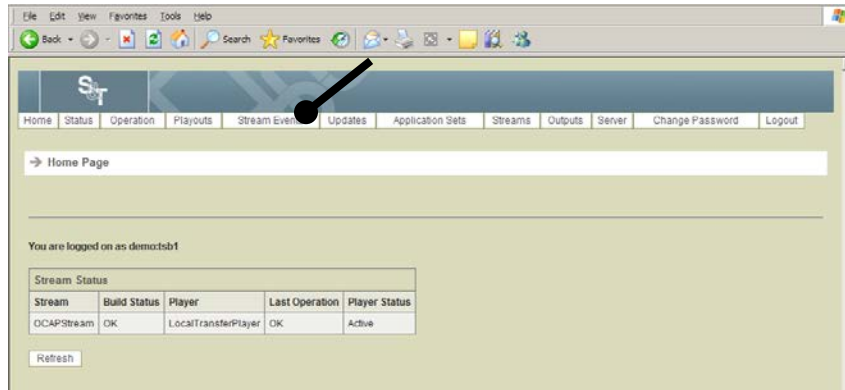

**Result:** The Manage Stream Event Select Page opens.

3. Select a Stream Definition for which you want to manage stream events and click **Select**.

**Result:** The Manage Stream Event Page opens.

4. Click the **Inject Free Stream Event** button.

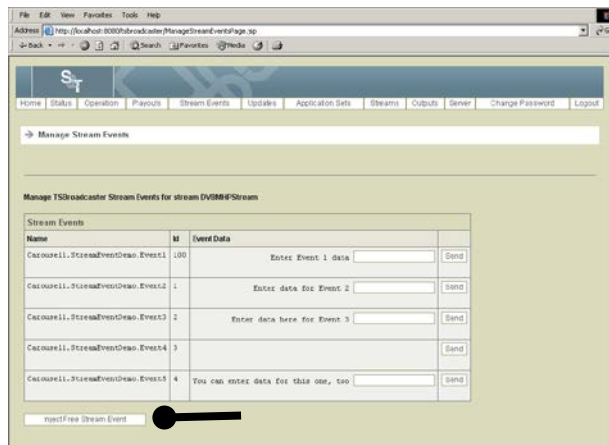

**Result:** The Manage Free Stream Events Page opens.

## Inject a Free Stream Event, Continued

5. Enter the following information on the Manage Free Stream Events Page.

<b>Event ID</b>	The integer identity of the stream event.
<b>Event Data</b>	The data to be carried in the stream event.

6. Click the **Inject Stream Event** button to inject the free stream event.

# Chapter 9

## Viewing Logs, Builds, and Archives

### Overview

#### Introduction

The TSBroadcaster keeps a log of the events that show activity on the system and it maintains a build that is a backup of the database. You can use logs to confirm that changes have been made to the system.

The TS Broadcaster keeps a record of the content and structure of all Transport Streams that it has sent out. The TSBroadcaster logs events daily and produces a new event log for each day. The TSBroadcaster allows you to view and retrieve the event logs.

Each time that a Transport Stream is changed, a playout is scheduled, or the stream is rebuilt to include updated data. The TSBroadcaster produces a “build” directory that contains a complete record of the content of the Transport Stream from that point on. The TSBroadcaster allows you to retrieve the builds for analysis. A stream is updated whenever a change is made to the content. Large changes may take some time to appear in the output.

After a pre-defined period, the TSBroadcaster archives the build and log information for the period into a zipped archive file. The TSBroadcaster also allows you to retrieve and delete archives.

These logging functions are available to users who have the OperateSystem privilege.

#### Event Levels

Each entry in the log is allocated a level that is shown in ascending order of importance:

- **Note.** Provides additional information about the system
- **Event.** Indicates a system state change or a significant operation
- **WARNING.** Indicates that there is an error that may degrade system operation in some limited respects
- **ERROR.** Indicates that there is an error that prevents the system from operating correctly
- **FATAL.** Indicates that there is an error that prevents the system from operating altogether

# Overview, Continued

## In This Chapter

This chapter contains the following topics.

Topic	See Page
View the Current Event Log	9-3
View Logs	9-5
Dump Event Logs	9-7
Download a Stream Build	9-9
Download the Latest Build	9-11
Download Archives	9-12
Delete an Archive	9-14
Server Management	9-15
Retrieve a Model	9-17
Suspend a Server	9-19
Drop a Role	9-20
Load a Model	9-21
Assume a Role	9-25
Drop a Partner	9-27
Resume to a Checking Active Partner State or Standby	9-28
Refresh State Data	9-29
Create a Trusted Host	9-30
Edit a Trusted Host	9-32
Delete a Trusted Host	9-34
Monitor Status	9-36

# View the Current Event Log

## Viewing the Current Log

To view the current Event log, complete the following steps.

1. Log in to the TSBroadcaster as a user with the appropriate privileges. See **Log In to the TSBroadcaster** in Chapter 3.

**Result:** After a successful login, the **Home Page** opens.

2. Click the **Operation** button from the navigation bar.

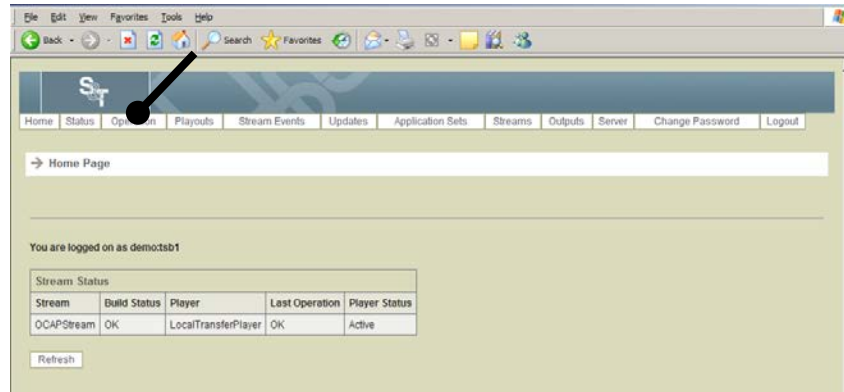

**Result:** The Operate System Page opens.

3. Click the **View Current Log** button.

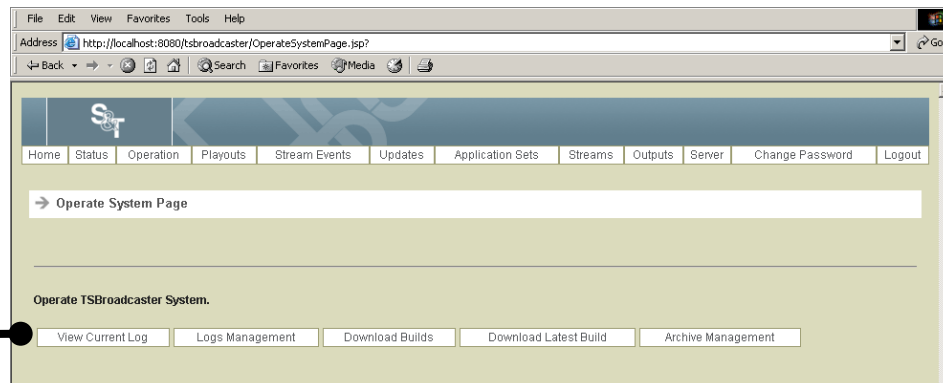

**Result:** The Current Log Select Page opens.

# View the Current Event Log, Continued

- Enter the following information on the View Current Log Select Page.

<b>From</b>	The start time of the selection. Use the format YYYY-MM-DD HH:MM:SS
<b>To</b>	The end time of the selection Use the format YYYY-MM-DD HH:MM:SS
<b>Severity</b>	The type of entry that will be presented. The data is displayed as follows: <ul style="list-style-type: none"> <li><b>All.</b> Show all entries</li> <li><b>Note.</b> Show all entries</li> <li><b>Event.</b> Show entries of Event level and above.</li> <li><b>WARNING.</b> Show entries of level <b>WARNING</b> and above</li> <li><b>ERROR.</b> Show entries of level <b>ERROR</b> and above</li> <li><b>FATAL.</b> Show entries of level <b>FATAL</b> and above</li> </ul>

- Click the **Select** button.

**Result:** The system displays the first page of log entries (most recent first) matching the criteria.

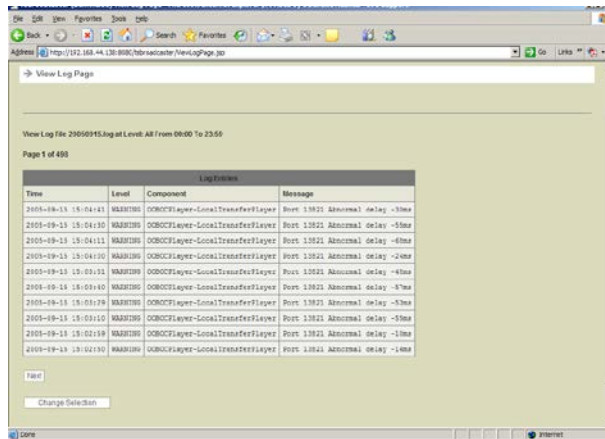

- While viewing the log entries, click the **Next** and **Previous** buttons to move through the selected entries, and select the **Change Selection** button to select a different set of entries.

# View Logs

## Viewing Logs

To view the logs, complete the following steps.

1. Log in to the TSBroadcaster as a user with the appropriate privileges. See **Log In to the TSBroadcaster** in Chapter 3.

**Result:** After a successful login, the **Home Page** opens.

2. Click the **Operation** button from the navigation bar.

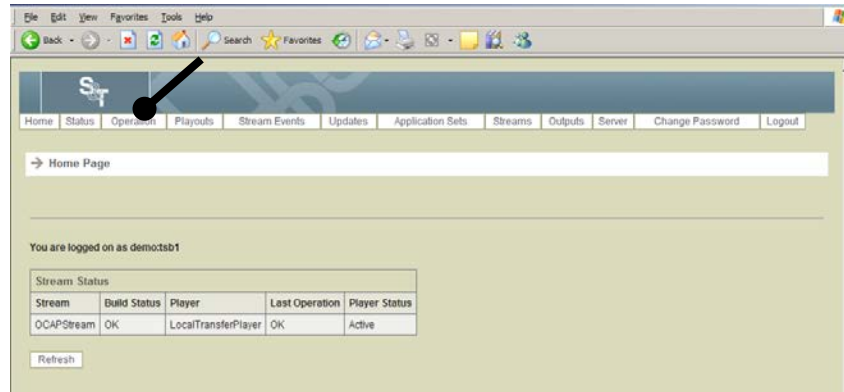

**Result:** The Operate System Page opens.

3. Click the **Logs Management** button on the Operate System Page.

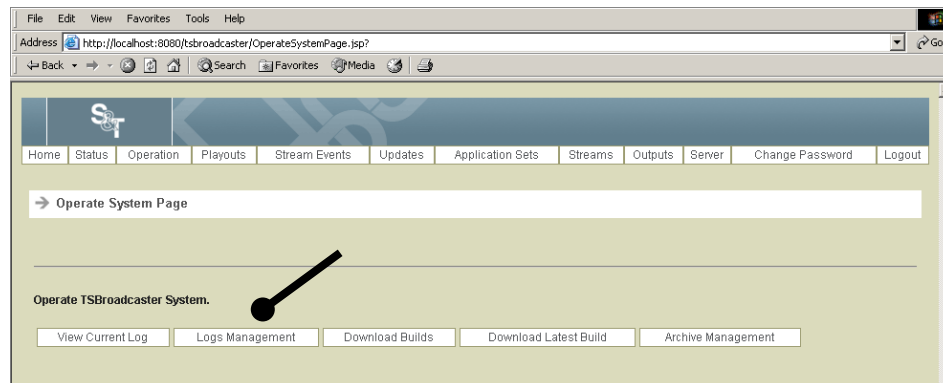

**Result:** The Manage Logs Page opens.

# View Logs, Continued

- Click the **View Log** button.

**Result:** The **View Log Select Page** opens.

- Enter the following information on the View Log Select Page.

<b>From</b>	The start time of the selection Use the format YYYY-MM-DD HH:MM:SS
<b>To</b>	The end time of the selection Use the format YYYY-MM-DD HH:MM:SS
<b>Severity</b>	The type of entry that will be presented. The data is displayed as follows: <ul style="list-style-type: none"> <li><b>All.</b> Show all entries</li> <li><b>Note.</b> Show all entries</li> <li><b>Event.</b> Show entries of Event level and above.</li> <li><b>WARNING.</b> Show entries of level <b>WARNING</b> and above</li> <li><b>ERROR.</b> Show entries of level <b>ERROR</b> and above</li> <li><b>FATAL.</b> Show entries of level <b>FATAL</b> and above</li> </ul>

- Click the **Select** button.

**Result:** The system displays the first page of log entries (most recent first) matching the criteria.

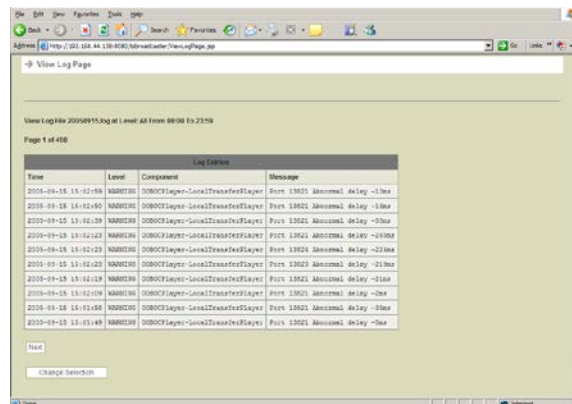

- While viewing the log entries, click the **Next** and **Previous** buttons to move through the selected entries, and select the **Change Selection** button to select a different set of entries.

# Dump Event Logs

## Dumping Event Logs

To dump an event log, complete the following steps.

1. Log in to the TSBroadcaster as a user with the appropriate privileges. See **Log In to the TSBroadcaster** in Chapter 3.

**Result:** After a successful login, the Home Page opens.

2. Click the **Operation** button from the navigation bar.

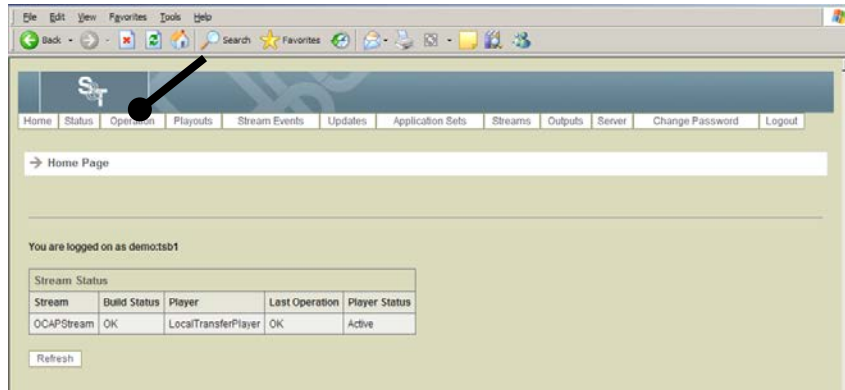

**Result:** The Operate System Page opens.

3. Click the **Logs Management** button.

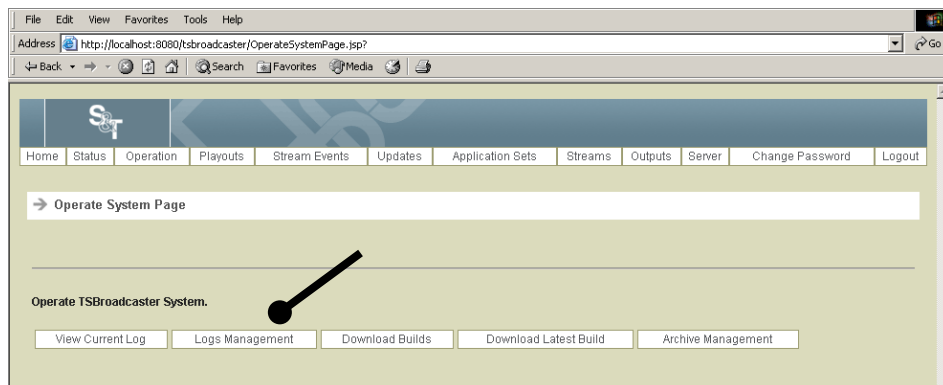

**Result:** The Manage Logs Page opens.

## Dump Event Logs, Continued

4. Click the **Dump Log** button.  
**Result:** The Dump Log Select Page opens.
5. Select a log to retrieve as a file and click **Select**.
6. The system prompts you to either open or save the file.
7. Click **Open** to open the file, and review the log data.
8. If you want to save the file, click **File** and **Save** using the facilities of your Internet browser.

**Note:** The log file is saved as a comma separated file with extension .csv so you can open it using a spreadsheet program.

# Download a Stream Build

## Introduction

A build is a representation of the current data going out of the TSBroadcaster on the carousel. The build includes applications that are going out and the associated PIDs and packages. This section provides a procedure for downloading a stream build. You can use this feature to identify the information that is going out on a carousel at any given time.

## Downloading a Stream Build

To download a stream build, complete the following steps.

1. Log in to the TSBroadcaster as a user with the appropriate privileges. See **Log In to the TSBroadcaster** in Chapter 3.

**Result:** After a successful login, the Home Page opens.

2. Click the **Operation** button from the navigation bar.

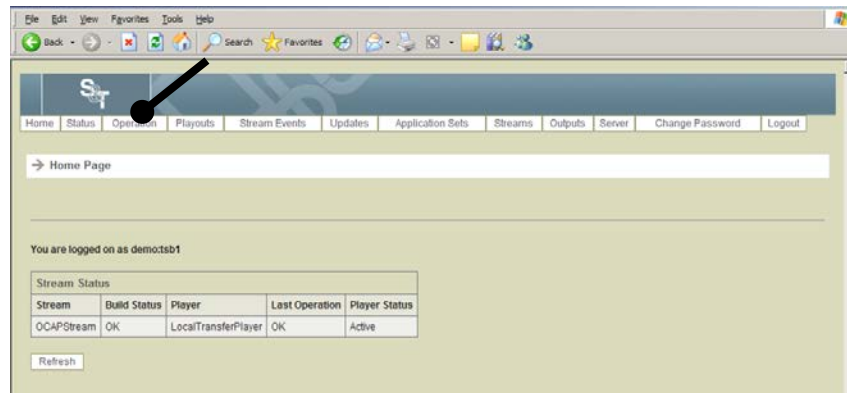

**Result:** The Operate System Page opens.

3. Click the **Download Builds** button and select a stream.

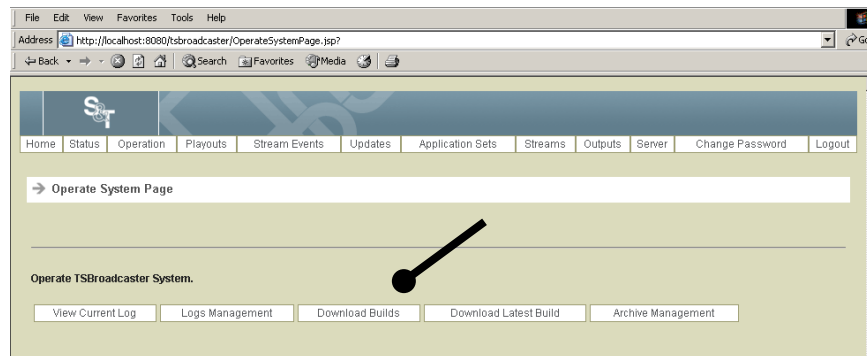

**Result:** The Download Build Select Page opens. The builds are identified with a tag denoting the time at which they were built in UTC time; the format is yyyyMMdd\_HH:mm:ss\_fff.

## Download a Stream Build, Continued

4. Select a TSBroadcaster stream to which you want to download a build and click **Select**.

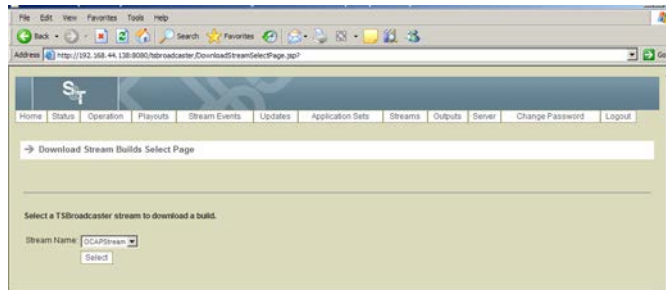

**Result:** The **Download Build Select Page** opens.

5. Select the build that you want to download as a ZIP file and click **Download**.

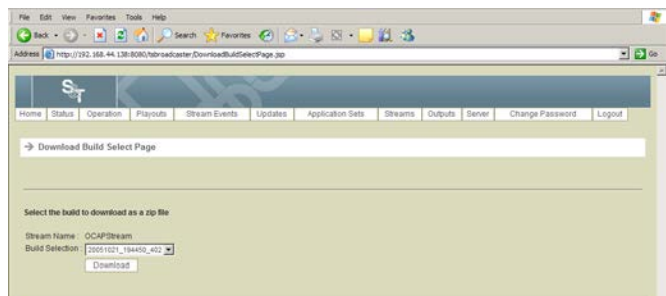

**Result:** The system prompts you to open or save the file.

6. Click **Open** to open the file, and review the contents of the ZIP file.
7. Extract the contents of the ZIP file to the desired location on your hard drive.

# Download the Latest Build

## Downloading the Latest Build

To download the latest build, complete the following steps.

1. Log in to the TSBroadcaster as a user with the appropriate privileges. See **Log In to the TSBroadcaster** in Chapter 3.

**Result:** After a successful login, the Home Page opens.

2. Click the **Operation** button from the navigation bar.

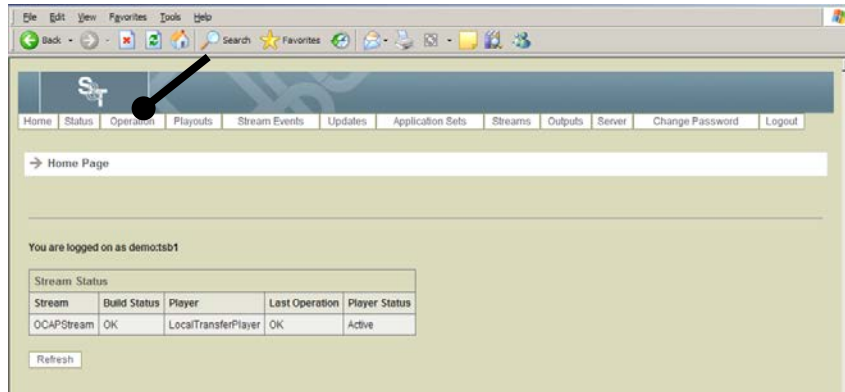

**Result:** The Operate System Page opens.

3. Click the **Download Latest Build** button.

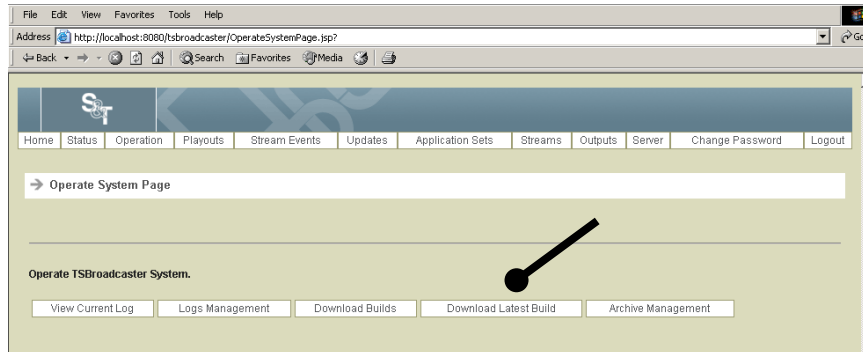

**Result:** The Download Latest Build Select Page opens.

4. Select a TSBroadcaster stream to download its latest build and click **Download**.

**Result:** The system prompts you to open or save the file.

5. Click **Open** to open the file, and review the contents of the ZIP file.
6. Extract the contents of the ZIP file to the desired location on your hard drive.

# Download Archives

## Downloading Archives

To download archives of event logs, complete the following steps.

1. Log in to the TSBroadcaster as a user with the appropriate privileges. See **Log In to the TSBroadcaster** in Chapter 3.

**Result:** After a successful login, the Home Page opens.

2. Click the **Operation** button from the navigation bar.

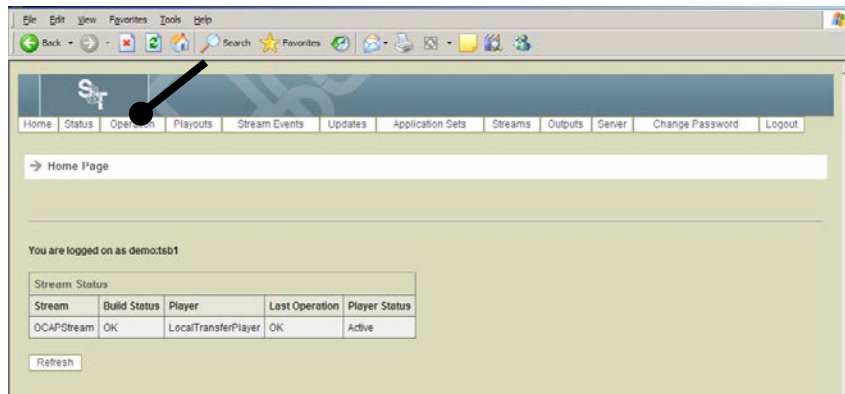

**Result:** The Operate System Page opens.

3. Click the **Archive Management** button on the Operate System Page.

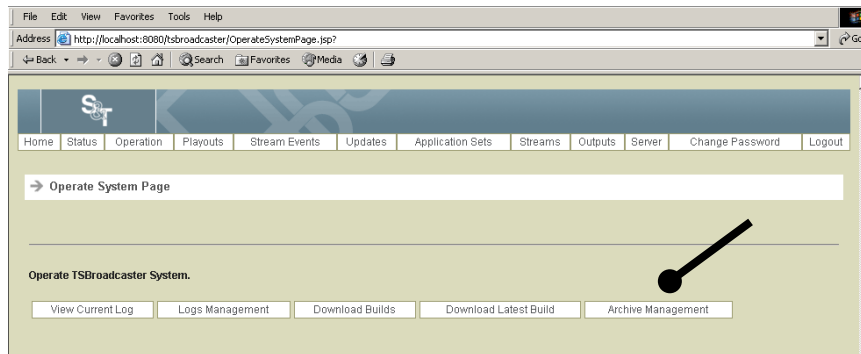

**Result:** The Manage Archive Page opens. The Manage Archive Page shows the archives of builds and logs that are available to download.

## Download Archives, Continued

4. To download an archive, click the **Download** button next to the desired archive.

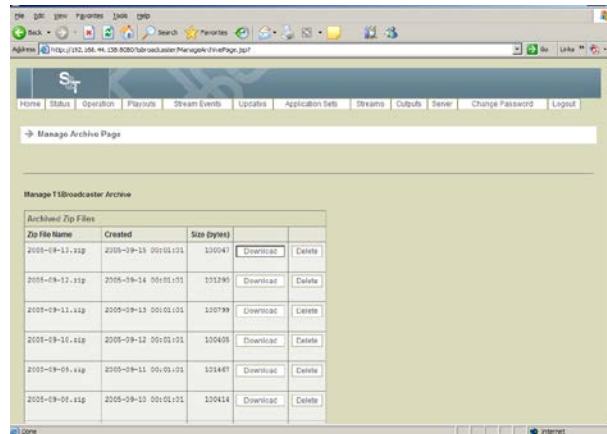

**Result:** The system prompts you to open or save the file.

5. Click **Open** to open the file, and review the contents of the ZIP file.
6. Extract the contents of the ZIP file to the desired location on your hard drive.

# Delete an Archive

## Deleting an Archive

To delete an archive, complete the following steps.

1. Log in to the TSBroadcaster as a user with the appropriate privileges. See **Log In to the TSBroadcaster** in Chapter 3.

**Result:** After a successful login, the Home Page opens.

2. Click the **Operation** button from the navigation bar.

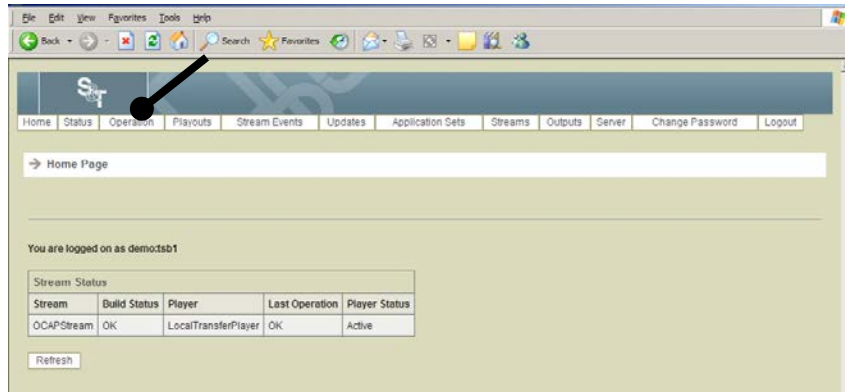

**Result:** The Operate System Page opens.

3. Click the **Archive Management** button on the Operate System Page.

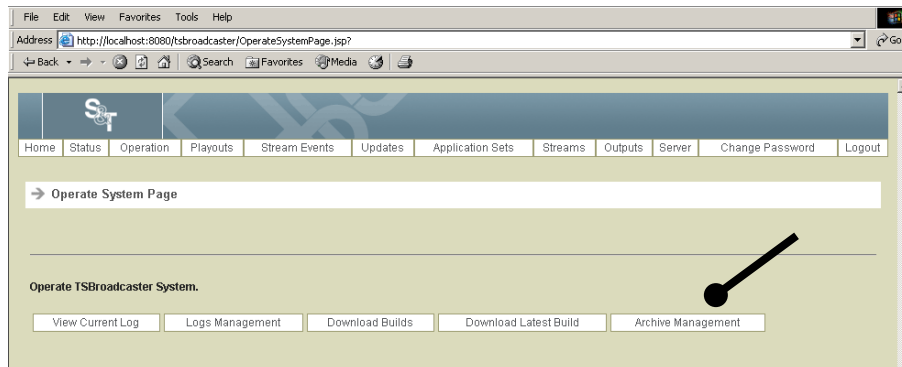

**Result:** The Manage Archive Page opens. The Manage Archive Page shows the archives of builds and logs that are available to download.

4. To delete an archive, click the **Delete** button next to the archive you want to delete.

# Server Management

## Introduction

The TSBroadcaster allows you to manage the state of the server and to run in a dual redundant configuration.

A TSBroadcaster server will only operate if it has been assigned a role. A role is essentially the name of the job that the server is performing. The actual value of the role does not matter for a standalone server.

A TSBroadcaster server can work in partnership with another server to form a dual-redundant pair. Servers will only work in pairs if they both have the same role. When servers are paired up, one of them continues to operate as it normally does, but it also sends its model across to its partner whenever it is changed. The other server does not actively run, but just “shadows.” Its partner accepts changes to its model to keep in step and monitors its partner's activity. If the active server fails or goes down, the shadowing partner takes over.

## Manage Server Page

The server management functions are available to users who have the ManageSystem privilege. To access the stream event management functions through the Internet browser UI, log in as a user with the appropriate privilege and select the Server button from the navigation bar. The TSBroadcaster displays the Manage Server Page. This page shows information about the TSBroadcaster server and presents a set of buttons to manage the server. The TSBroadcaster only presents the buttons for operations available in the current state.

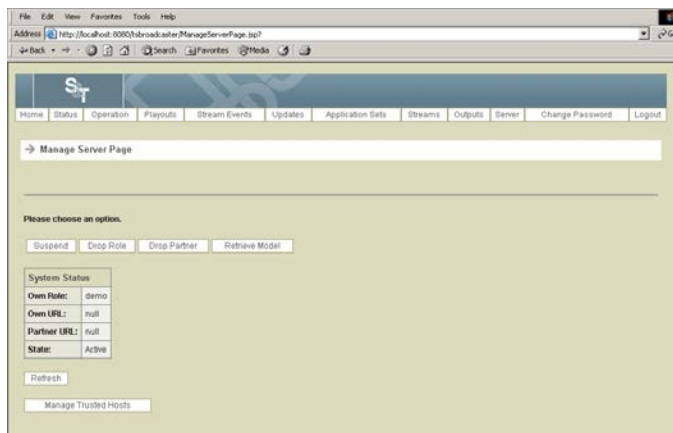

# Server Management, Continued

## Server States

The TSBroadcaster server can pass through a number of states.

State	Description
Standby	If the server does not have a role, it is in this state. It enters this state if it starts without a role, or if its role has been dropped. The server has not read its model from disk, and so the model can be replaced by a different one in this state. If the server cannot read its model from disk, it clears its role and enters this state. When given a role, the server enters the CheckingActivePartner state.
Checking Active Partner	If the server has just started or has just been given a role, it transiently enters this state to see if it has an active partner. If it has not, it enters the <b>Active</b> state; if it has, it enters the <b>Shadowing</b> state and requests a copy of the partner server's model.
Active	If the server has a role and a valid model and does not have an active partner, it enters this state. In this state, it has loaded its model into memory and is now actively building, updating, and sending out Transport Stream data. If any commands change its model, it sends a copy of that model to its partner server.
Failed	If the server was Active but cannot build or send out data, it enters this state. In this state, it continues to attempt to build, update, and send out Transport Stream data; and if it succeeds, it will become Active again. If the server is paired up with another server, this server will enter the Shadowing state and the other server will become Active.
Shadowing	If the server has a role and a valid model and an Active partner, it is in this state. In this state it has loaded its model into memory and will update the model to reflect the state of its partner. If it detects that its partner has disappeared or entered the Failed state, it will become Active.
Suspended	If the server enters this state, it loads its model but does not actively build, update, or send out Transport Stream data.

# Retrieve a Model

## Introduction

A model is the saved TSBroadcaster configuration. The model is a representation of the configuration choices you made through the GUI. You can retrieve models containing development configurations, demonstrations, and test cases to be swapped in and out as often as necessary.

When you use this operation with the Load Model operation, the TSBroadcaster can be check pointed and restored. This feature allows models containing development configurations, demonstrations, and test cases to be swapped in and out as often as necessary.

## When to Retrieve a Model

Follow these important guidelines when you retrieve a model:

- Before you retrieve a model, be sure to view the playouts. Do not retrieve a model when a playout is starting or ending within 30 seconds of the start time or stop time of the playout.
- Be sure to retrieve and save a model *before* you load a new model. You may need to revert to the model that you saved.

## Retrieving a Model

To retrieve a model, complete the following steps.

**Note:** This operation is available in all states except CheckingActivePartner and Standby.

1. Log in to the TSBroadcaster as a user with the appropriate privileges. See **Log In to the TSBroadcaster** in Chapter 3.

**Result:** After a successful login, the Home Page opens.

2. Click the **Server** button from the navigation bar.

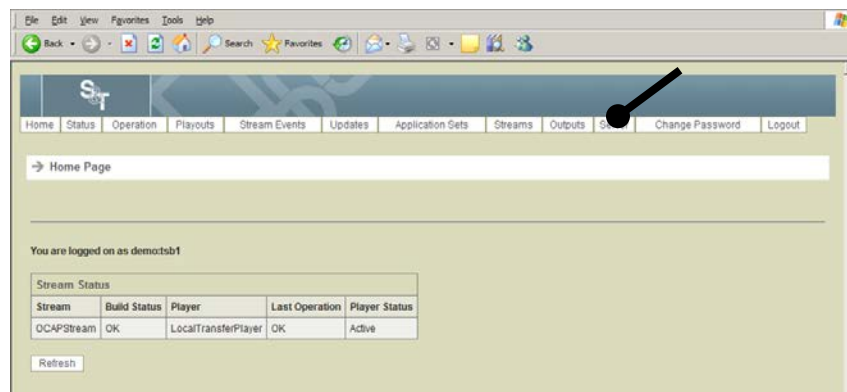

**Result:** The Manage Server Page opens.

## Retrieve a Model, Continued

3. Click the **Retrieve Model** button.

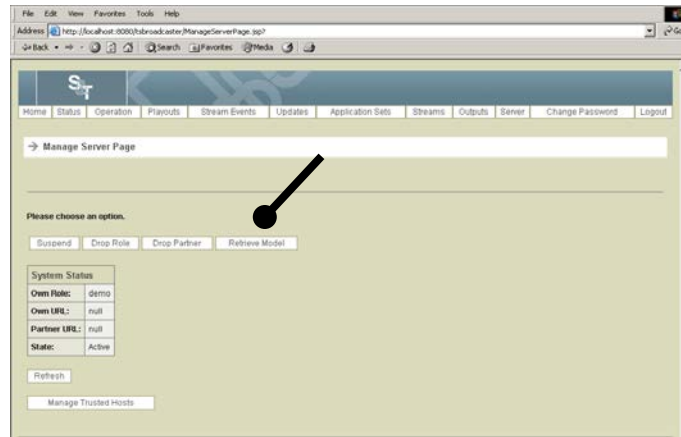

**Result:** The system prompts you to open or save the file.

4. Click **Save**.

**Note:** To view the contents of the ZIP file, you must first extract them onto the local machine.

**Result:** The system prompts you to save the file to a specific location.

5. Browse to the location from where you launched the TSBroadcaster browser and click **Save**.
6. When the system prompts you that the download is complete, click **Close**.

# Suspend a Server

## Suspending a Server

To suspend a server, complete the following steps.

1. Log in to the TSBroadcaster as a user with the appropriate privileges. See **Log In to the TSBroadcaster** in Chapter 3.

**Result:** After a successful login, the Home Page opens.

2. Click the **Server** button from the navigation bar.

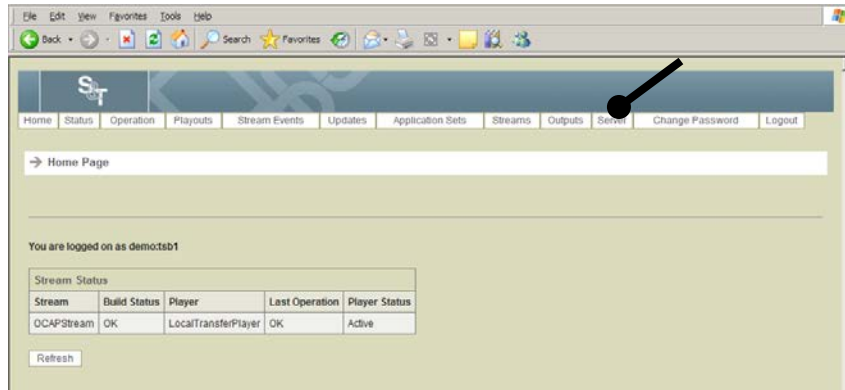

**Result:** The Manage Server Page opens.

3. Click the **Suspend** button on the Manage Server Page to make the TSBroadcaster server enter the Suspended state.

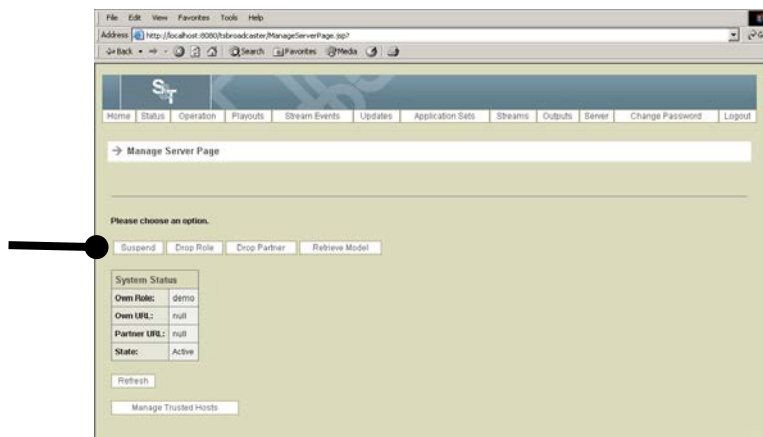

**Note:** This operation is available in all states except CheckingActivePartner and Suspended.

# Drop a Role

## Dropping a Role

To drop a role, complete the following steps.

**Note:** This operation is available in all states except CheckingActivePartner and Standby.

1. Log in to the TSBroadcaster as a user with the appropriate privileges. See **Log In to the TSBroadcaster** in Chapter 3.

**Result:** After a successful login, the Home Page opens.

2. Click the **Server** button from the navigation bar.

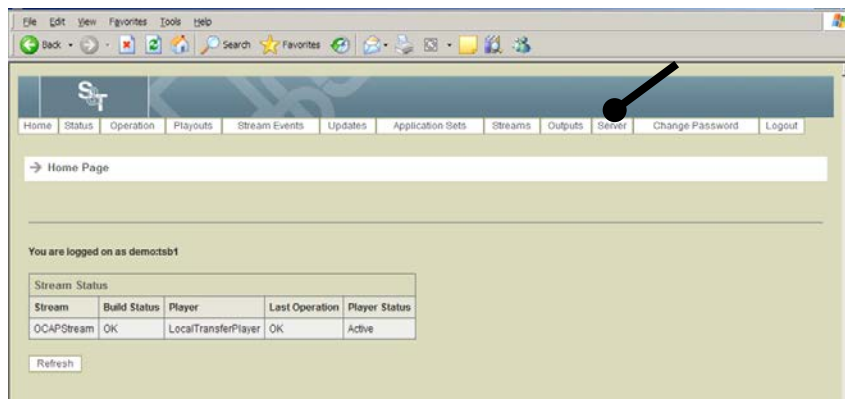

**Result:** The Manage Server Page opens.

3. Click the **Drop Role** button to put the TSBroadcaster into the Standby state.

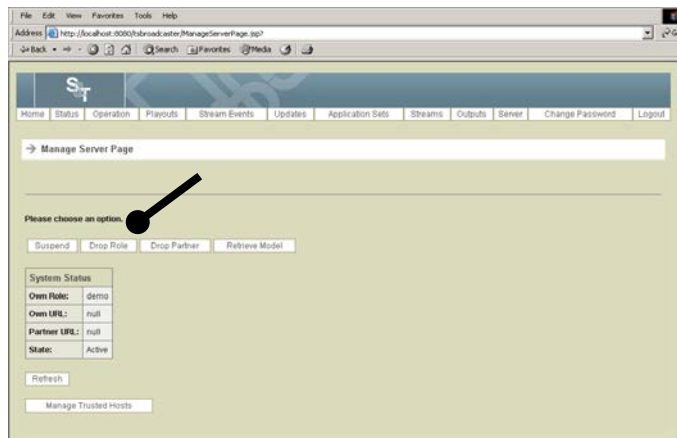

**Result:** This action ensures that you have a clean database.

# Load a Model

## Loading Models

To load a model, complete the following steps.

### Important:

- Be sure to retrieve and save a model *before* you load a new model. You may need to revert to the model that you saved.
- This operation is available in the Standby state.

1. Log in to the TSBroadcaster as a user with the appropriate privileges. See **Log In to the TSBroadcaster** in Chapter 3.

**Result:** After a successful login, the **Home Page** opens.

2. Click the **Server** button from the navigation bar.

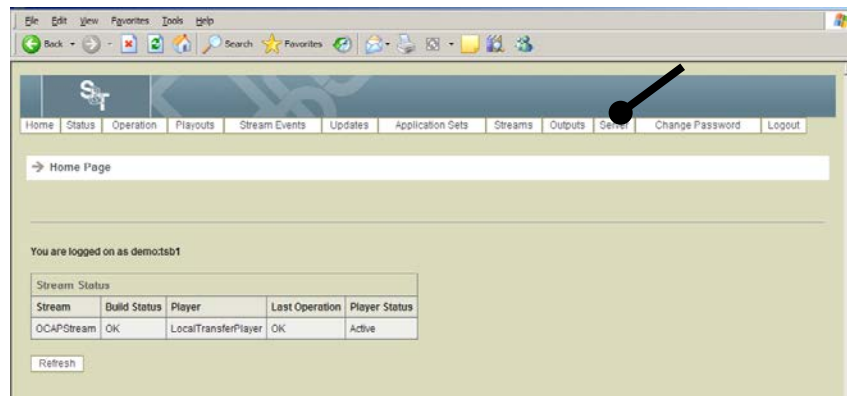

**Result:** The Manage Server Page opens.

## Load a Model, Continued

3. Click **Retrieve Model** to save a backup of your working configuration to the location from which you launch the TSBroadcaster browser. For step-by-step instructions, see **Retrieve a Model**, earlier in this chapter.

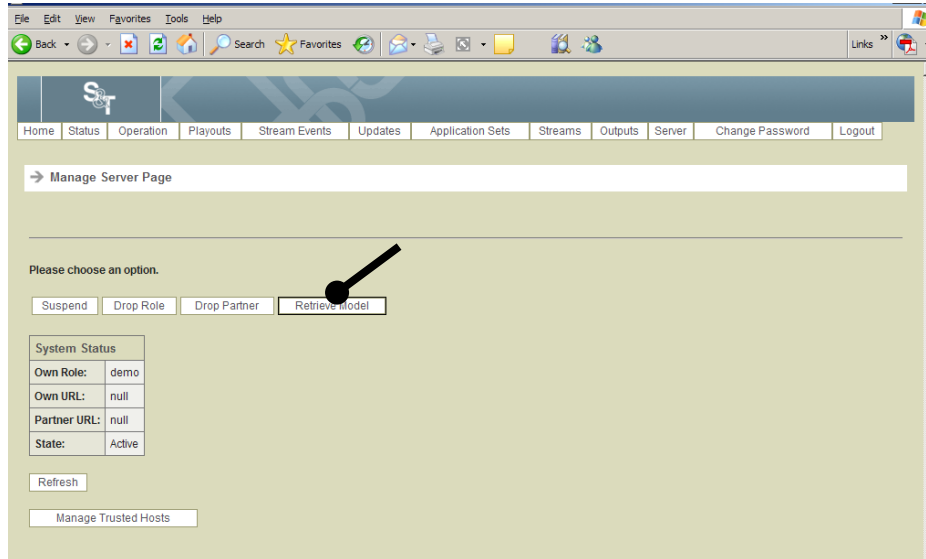

4. Click the **Suspend** button.

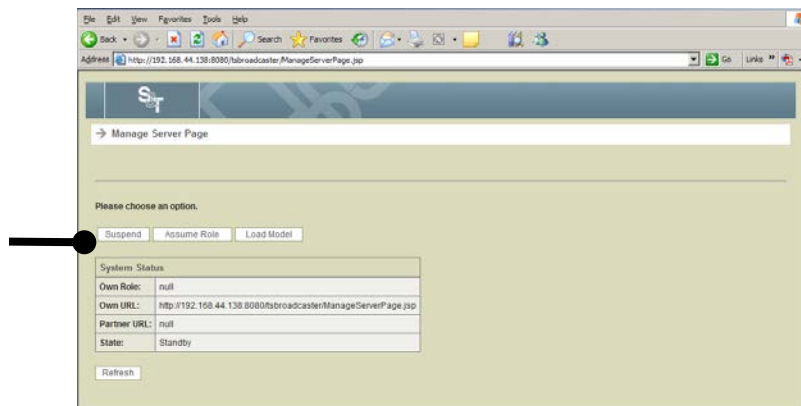

**Result:** The system enters the “Suspended” state.

# Load a Model, Continued

5. Click **Drop Role**.

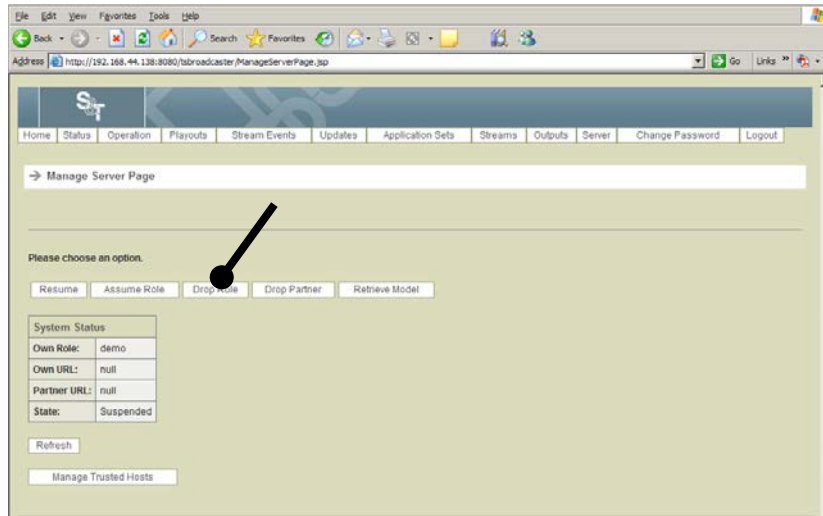

**Result:** The system enters the “Standby” state.

6. Click the **Load Model** button to load the model.

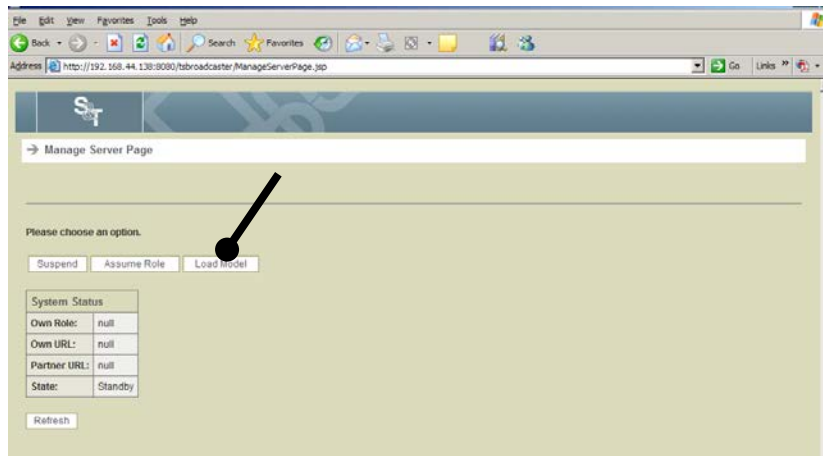

**Result:** The system prompts you to enter the name of the model The Load Model Page opens.

## Load a Model, Continued

7. Enter or browse to the model file that you want to load. Click **Load** to load the file.

**Result:** The Manage Server Page opens again with the system in the “Standby” state.

8. Click **Assume Role**.

**Result:** The Assume Role Page opens.

9. In the Role field, enter **demo** and click **Assume Role**.

**Result:** The system enters the “Checking Active Partner” state.

10. Click **Refresh**.

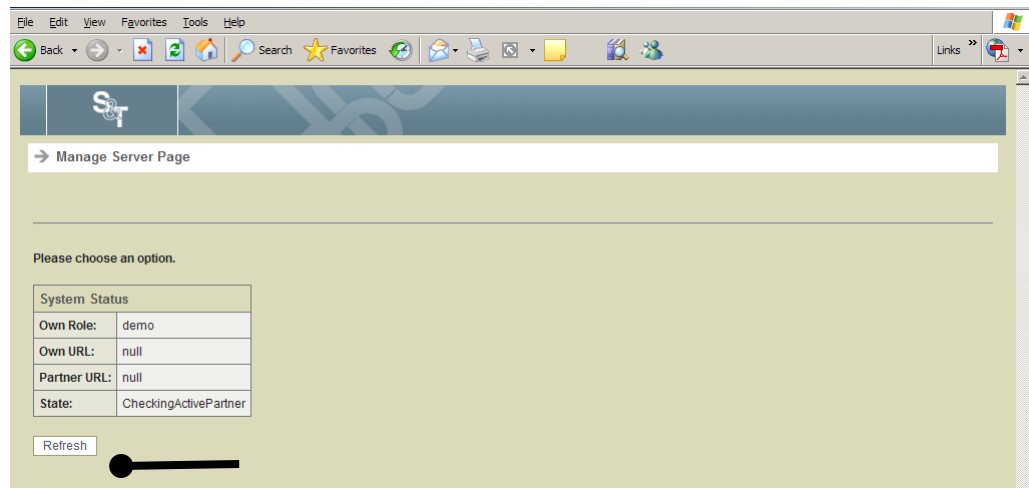

**Result:** The system returns to the “Active” state, and the new model is loaded.

# Assume a Role

## Assuming Roles

When you assume a role, you attach to a partner. To assume a role, complete the following steps.

1. Log in to the TSBroadcaster as a user with the appropriate privileges. See **Log In to the TSBroadcaster** in Chapter 3.

**Result:** After a successful login, the **Home Page** opens.

2. Click the **Server** button from the navigation bar.

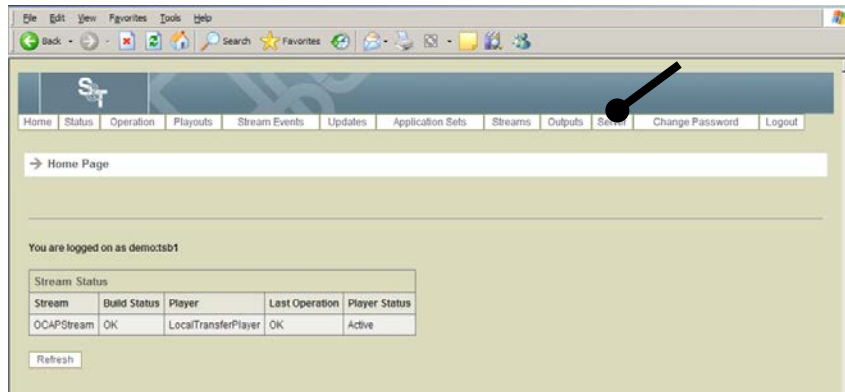

**Result:** The Manage Server Page opens.

3. Click the **Assume Role** button.

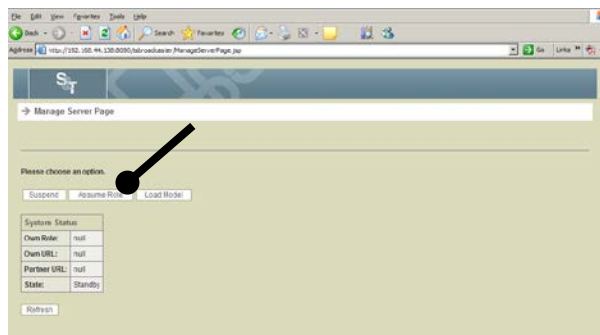

**Result:** The Assume Role Page opens.

## Assume a Role, Continued

- To assume a role, enter the following data on the Assume Role Page.

<b>Role</b>	The description of the role
<b>Own URL</b>	The server's own URL (only required if the server is part of a dual redundant pair)
<b>Partner URL</b>	The partner's own URL (only required if the server is part of a dual redundant pair)

- Click the **Assume Role** button to assume the role and make the TSBroadcaster server enter the CheckingActivePartner state.

**Note:** This operation is available in Standby and Suspended states.

# Drop a Partner

## Dropping a Partner

If you are operating the TSBroadcaster as part of a redundant pair, you can drop a partner to cause the TSBroadcaster to operate in a standalone mode.

### Important:

- Be sure to retrieve and save a model *before* you drop a partner. You may need to revert to the model that you saved.
- This operation is available in all states except CheckingActivePartner and Standby

To drop a partner, complete the following steps.

1. Log in to the TSBroadcaster as a user with the appropriate privileges. See **Log In to the TSBroadcaster** in Chapter 3.

**Result:** After a successful login, the **Home Page** opens.

2. Click the **Server** button from the navigation bar.

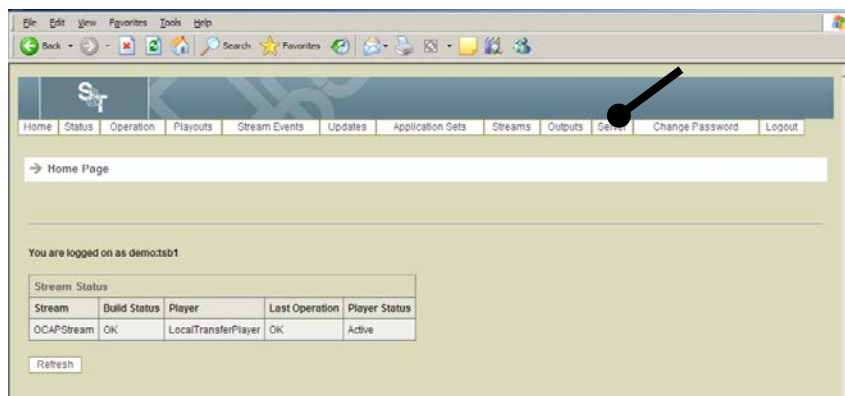

**Result:** The Manage Server Page opens.

3. Click the **Drop Partner** button to stop the TSBroadcaster from operating as one of a redundant pair.

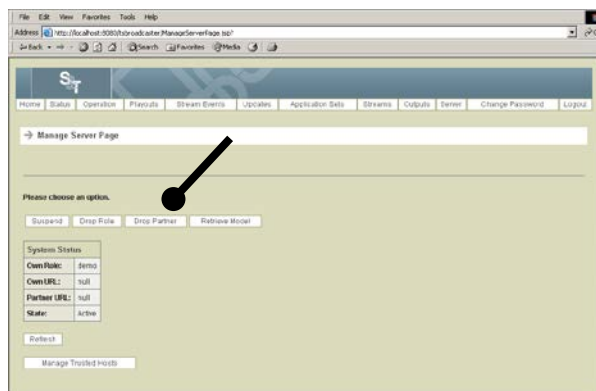

# Resume to a Checking Active Partner State or Standby

## Introduction

After you suspend a server, you can resume to a checking active partner or standby state.

## Resuming the Checking Active Partner State or Standby

To resume a state, complete the following steps.

1. Log in to the TSBroadcaster as a user with the appropriate privileges. See **Log In to the TSBroadcaster** in Chapter 3.

**Result:** After a successful login, the Home Page opens.

2. Click the **Server** button from the navigation bar.

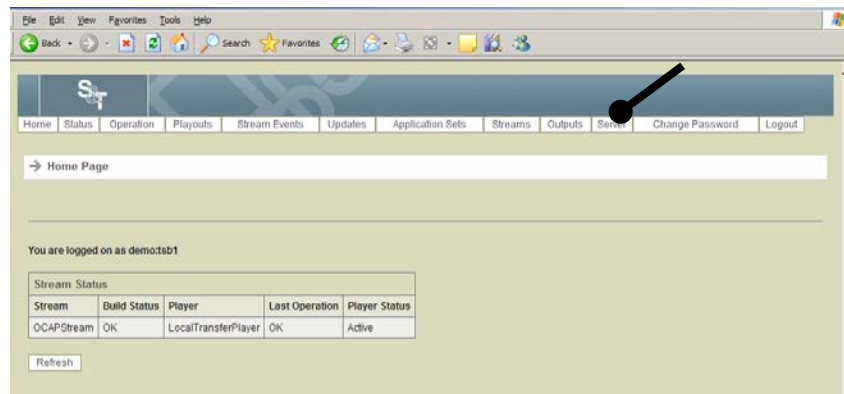

**Result:** The Manage Server Page opens.

3. Click the **Resume** button on the Manage Server Page to make the TSBroadcaster server enter the CheckingActivePartner or Standby states, depending on whether it has a role defined.

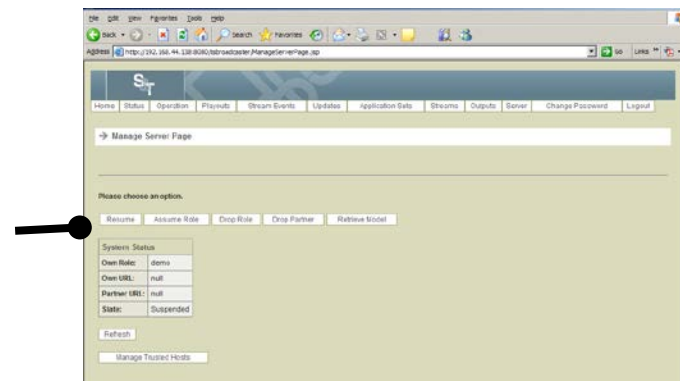

**Note:** This operation is only available when a server is in the Suspended state.

# Refresh State Data

## Refreshing State Data

To refresh state data, complete the following steps.

1. Log in to the TSBroadcaster as a user with the appropriate privileges. See **Log In to the TSBroadcaster** in Chapter 3.

**Result:** After a successful login, the **Home Page** opens.

2. Click the **Server** button from the navigation bar.

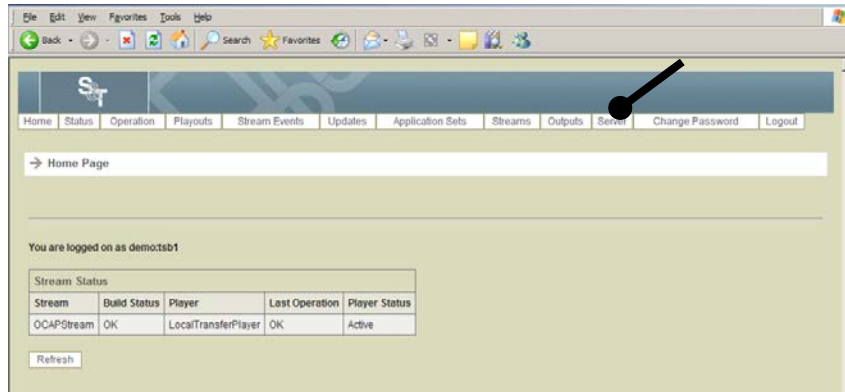

**Result:** The Manage Server Page opens.

3. Click the **Refresh** button to re-display updated state data.

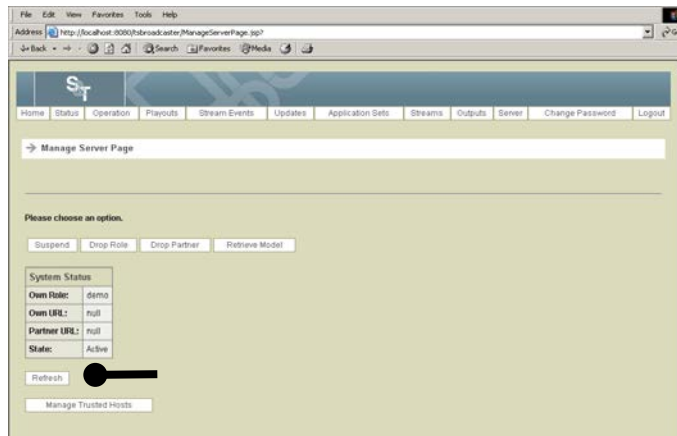

# Create a Trusted Host

## Introduction

The TSBroadcaster allows trusted hosts to perform some operations, such as logging events, without logging in to the server. This allows systems such as data update systems to work closely with the TSBroadcaster without having to distribute TSBroadcaster user account information. A trusted host is represented as a reference address and a mask. To determine if a client is trusted, ensure that the address is on the same base network as the server. If the two are the same, the client is trusted. In other words, the reference address and the address mask are logically ANDed together bitwise. Any address that is “bitwise ANDed” with its netmask will reveal the address of the network to which it belongs.

## Creating a Trusted Host

To create a trusted host, complete the following steps.

1. Log in to the TSBroadcaster as a user with the appropriate privileges. See **Log In to the TSBroadcaster** in Chapter 3.  
**Result:** After a successful login, the Home Page opens.
2. Click the **Server** button from the navigation bar.

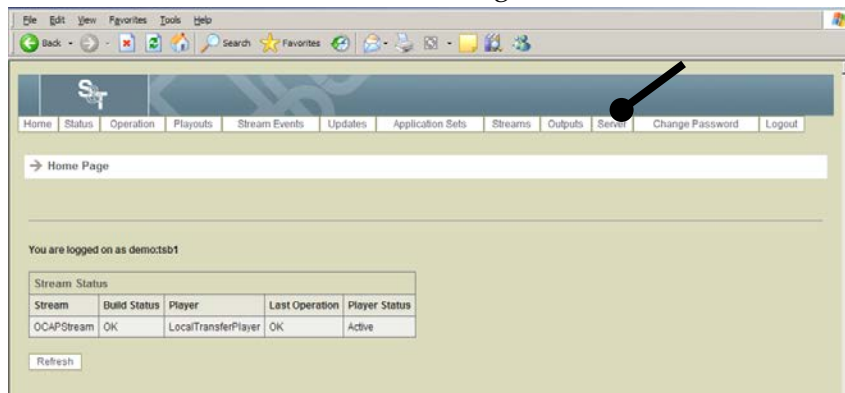

**Result:** The Manage Server Page opens.

# Create a Trusted Host, Continued

- Click the **Manage Trusted Hosts** button.

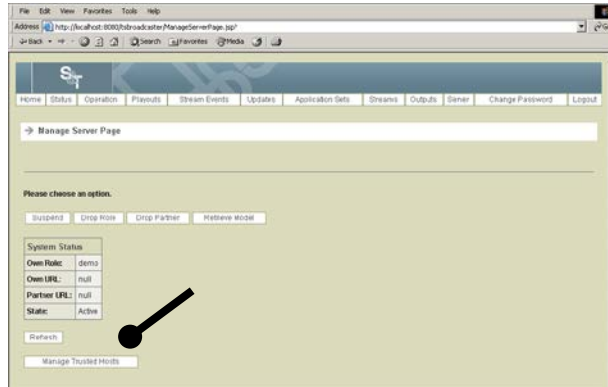

**Result:** The Manage Trusted Hosts Page opens.

- Click the **Create Trusted Host** button on the Manage Trusted Hosts Page.

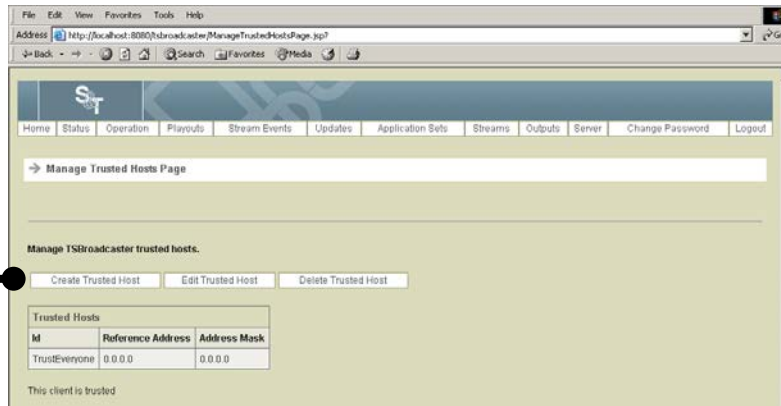

**Result:** The Create Trusted Host Page opens.

- Enter the following information on the Create Trusted Host Page.

<b>ID</b>	The name by which the trusted host is known by TSBroadcaster
<b>Reference Address</b>	The reference address, in standard dotted numeric IP address notation
<b>Address Mask</b>	The mask for the trusted address, in standard dotted numeric IP address notation

- Click the **Save** button to create a new trusted host record.

# Edit a Trusted Host

## Editing a Trusted Host

To edit a trusted host, complete the following steps.

1. Log in to the TSBroadcaster as a user with the appropriate privileges. See **Log In to the TSBroadcaster** in Chapter 3.

**Result:** After a successful login, the Home Page opens.

2. Click the **Server** button from the navigation bar.

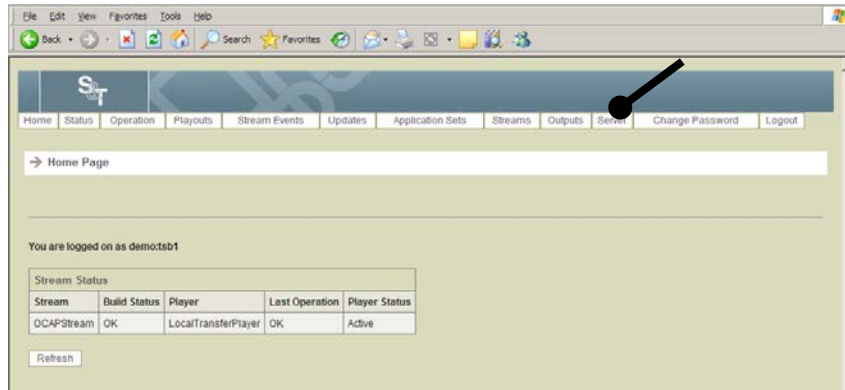

**Result:** The Manage Server Page opens.

3. Click the **Manage Trusted Hosts** button.

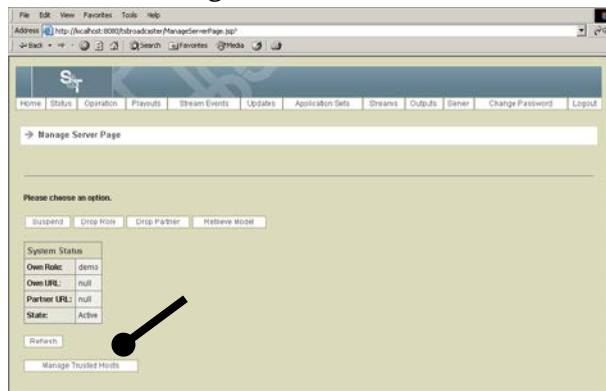

**Result:** The Manage Trusted Hosts Page opens.

## Edit a Trusted Host, Continued

4. Click the **Edit Trusted Host** button.

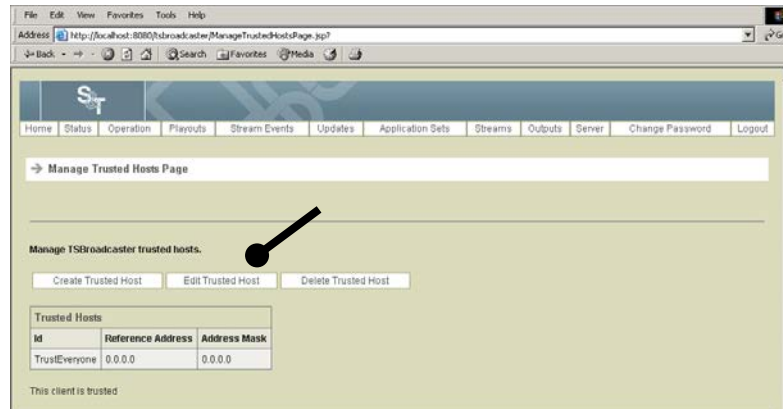

**Result:** The Edit Trusted Host Select Page opens.

5. Select the TSBroadcaster trusted host that you want to edit and click **Select**.

**Result:** The Edit Trusted Host Page opens.

6. Edit the trusted host information. For field descriptions, see **Create a Trusted Host**, earlier in this chapter.
7. Click the **Save** button to save the changes to the trusted host record.

# Delete a Trusted Host

## Deleting a Trusted Host

To delete a trusted host, complete the following steps.

1. Log in to the TSBroadcaster as a user with the appropriate privileges. See **Log In to the TSBroadcaster** in Chapter 3.

**Result:** After a successful login, the **Home Page** opens.

2. Click the **Server** button from the navigation bar.

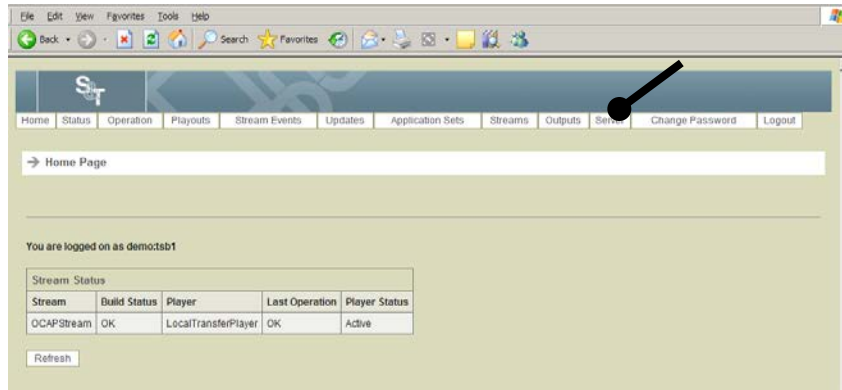

**Result:** The Manage Server Page opens.

3. Click the **Manage Trusted Hosts** button.

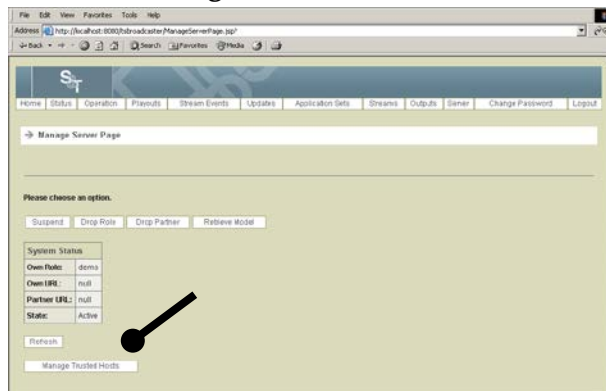

**Result:** The Manage Trusted Hosts Page opens.

## Delete a Trusted Host, Continued

4. Click the **Delete Trusted Host** button.

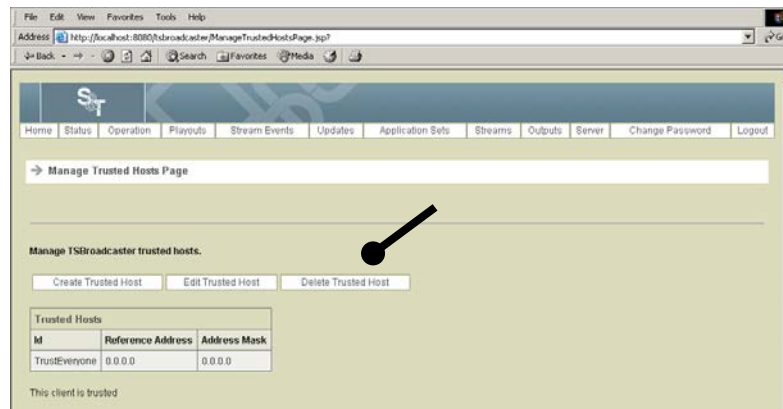

**Result:** The Delete Trusted Host Page opens.

5. Select the trusted host record you wish to delete, and click the **Delete** button to delete the trusted host record.

# Monitor Status

## Introduction

The TSBroadcaster provides a status window that monitors its status and refreshes every few seconds. The status window shows whether TSBroadcaster is delivering information to the outputs successfully. It does not indicate whether the TSPlayer and TSMux software is operating successfully.

## Monitoring Status

To monitor the status, complete the following steps.

1. Log in to the TSBroadcaster as a user with the appropriate privileges. See **Log In to the TSBroadcaster** in Chapter 3.

**Result:** After a successful login, the Home Page opens.

2. Click the **Status** button from the navigation bar.

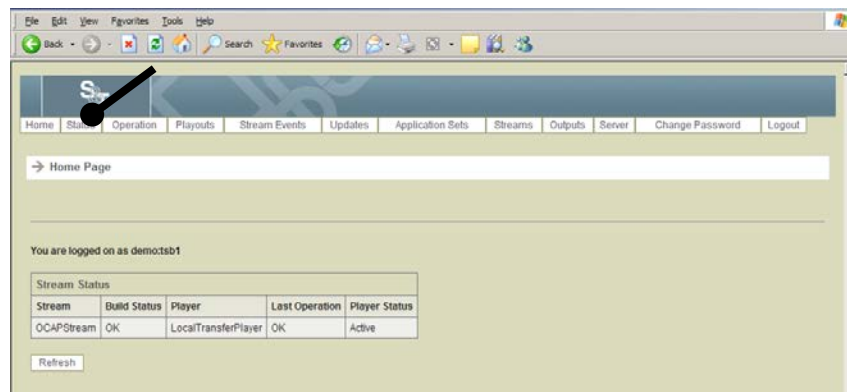

**Result:** The Status Monitor opens in a new window, showing the overall state of the TSBroadcaster.

## Monitor Status, Continued

3. Use the Status Monitor window to determine whether the last build of each stream was successful and whether that build was successfully sent to its nominated output.

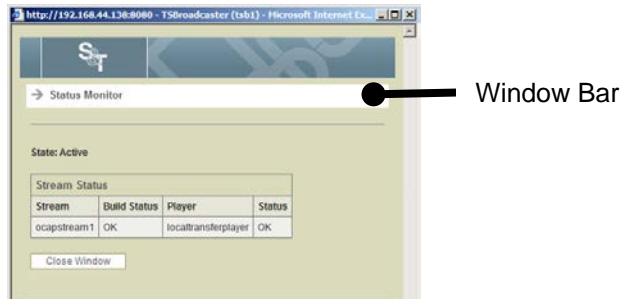

**Note:** If the TSBroadcaster is not operating successfully, the bar of the window is shown in red to attract attention.

# Chapter 10

## TSBroadcaster Administration

### Overview

### Introduction

This chapter provides information on creating and editing user accounts and describes the file system for the TSBroadcaster.

### In this Chapter

This chapter contains the following topics.

Topic	See Page
Create User Accounts	10-2
Change Passwords	10-4
Edit User Privileges	10-6
Delete User	10-8
File System Description	10-9
Maintain the TSBroadcaster	10-13
TSBroadcaster Properties	10-15
Configure A/V Content	10-21
Configure ASI Output	10-24
Deployment Options	10-25

# Create User Accounts

## Introduction

From the Internet browser UI, an administrator can set up and manage user accounts. Each user account is given privileges to determine the user's access to the TSBroadcaster. The user management functions are available to users who themselves have the **Administrator** privilege.

## Creating User Accounts

To create user accounts, complete these steps.

1. Log in to the TSBroadcaster as an administrator user with the appropriate privileges. See **Log In to the TSBroadcaster** in Chapter 3.
2. Click the **Users** button from the navigation bar.

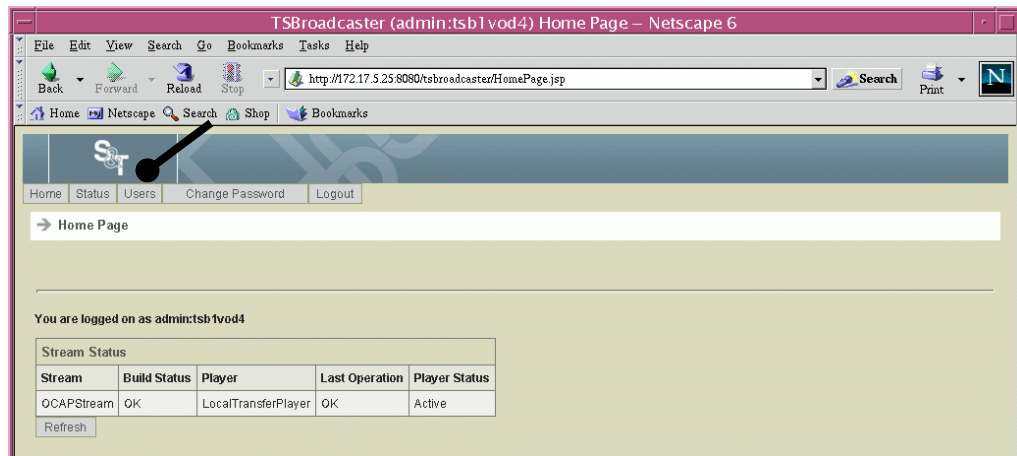

**Result:** The Manage Users Page opens.

3. Click the **Create User** button on the **Manage Users Page**.

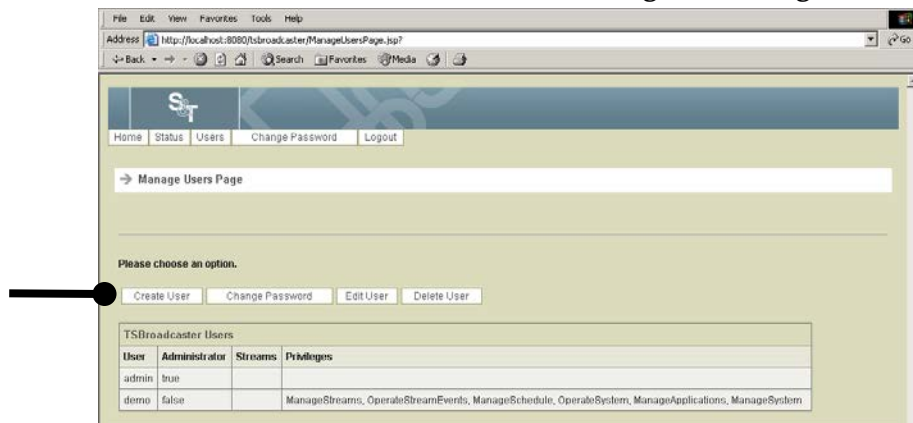

**Result:** The Create User Page opens.

## Create User Accounts, Continued

4. To create a new user account, enter the following data on the Create User page.

<b>Username</b>	The username for the account
<b>Password</b>	The password for the account (not echoed). To change the password, see <b>Change Passwords</b> , next in this chapter
<b>Administrator</b>	A check box indicating whether this account can create and manage the TSBroadcaster user accounts. You cannot change this parameter once you have created a user account
<b>Access to <i>stream</i></b>	A check box for each stream indicating whether this account can schedule applications on the specified transport stream
<b>Privilege ManageSystem</b>	A check box indicating whether this account can configure and manage the TSBroadcaster system
<b>Privilege OperateSystem</b>	A check box indicating whether this account can monitor the system logs and records
<b>Privilege ManageStreams</b>	A check box indicating whether this account can define and edit stream definitions. If this privilege is set on an account, it implicitly has access to all streams
<b>Privilege ManageApplications</b>	A check box indicating whether this account can create, edit, and update data in broadcast applications
<b>Privilege ManageSchedule</b>	A check box indicating whether this account can schedule applications for broadcast
<b>Privilege OperateStreamEvents</b>	A check box indicating whether this account can inject stream events during application broadcast

5. Click the **Save** button to create a new user account.

# Change Passwords

## Changing Passwords

To change passwords for user accounts, complete the following steps.

1. Log in to the TSBroadcaster as an administrator user with the appropriate privileges. See **Log In to the TSBroadcaster** in Chapter 3.

**Result:** After a successful login, the Home Page opens.

2. Click the **Users** button from the navigation bar.

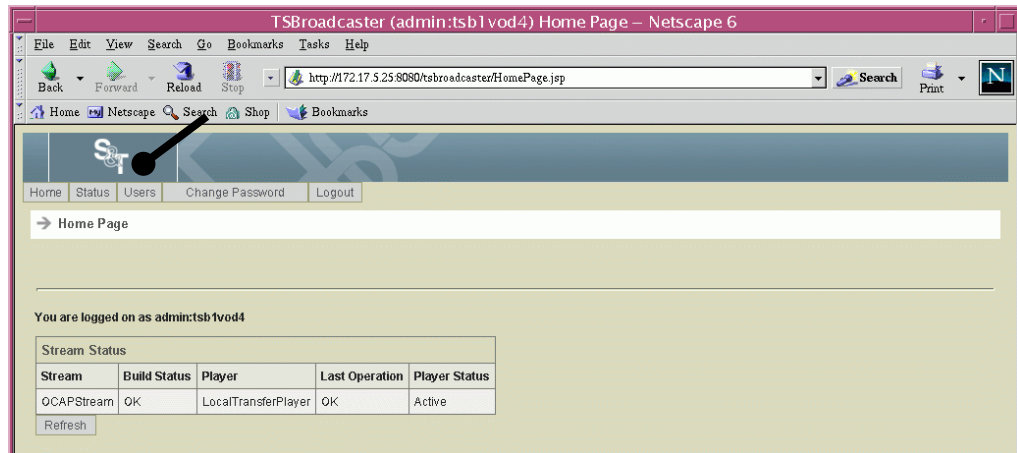

**Result:** The Manage Users Page opens.

3. Click the **Change Password** button on the Manage Users Page.

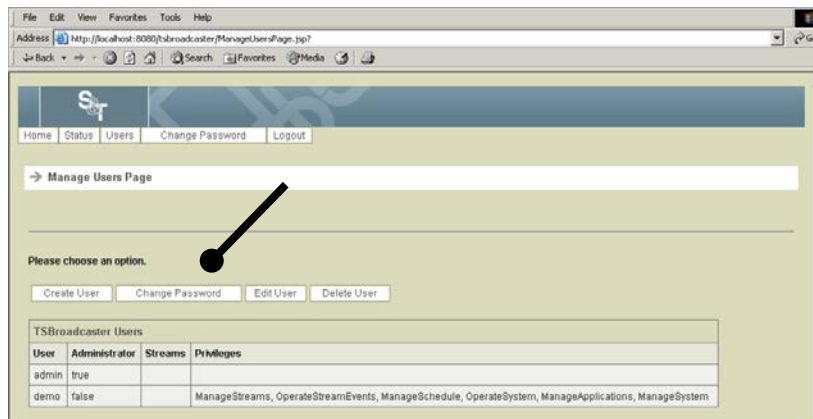

**Result:** The Change Password Page opens.

## Change Passwords, Continued

4. To change the password for a user account, enter the following data on the Change Password page.

<b>Username</b>	Enter the username for the account.
<b>Password</b>	Enter the password for the account (not echoed).
<b>Check Password</b>	Re-enter the password for the account (not echoed). This password must match the password field to verify that it has been typed correctly.

5. Click the **Change Password** button to save the new password for the selected user account.

# Edit User Privileges

## Editing User Privileges

To modify a user's privileges, complete the following steps.

1. Log in to the TSBroadcaster as an administrator user with the appropriate privileges. See **Log In to the TSBroadcaster**, in Chapter 3.

**Result:** After a successful login, the Home Page opens.

2. Click the **Users** button from the navigation bar.

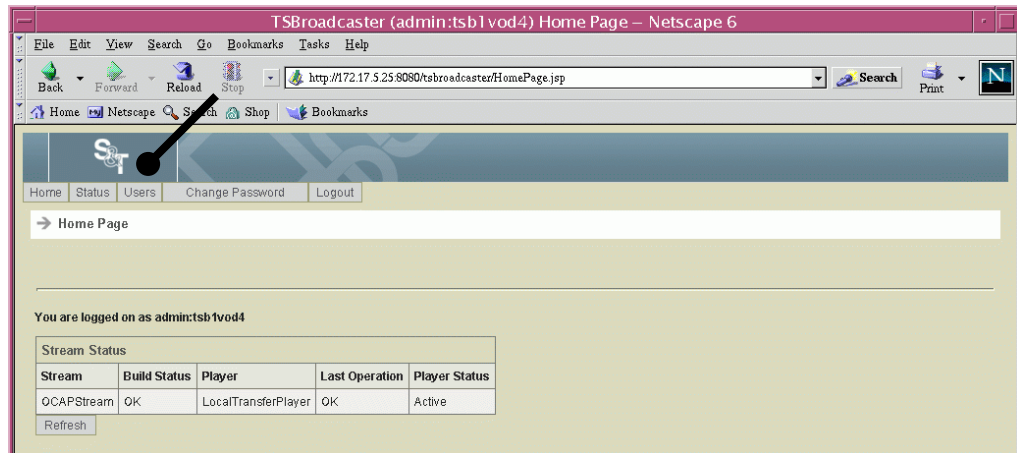

**Result:** The Manage Users Page opens.

3. Select the **Edit User** button and select the required user account.

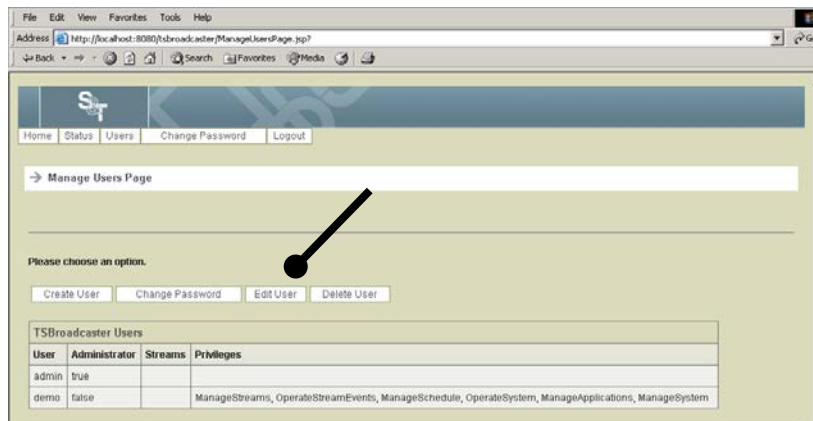

**Result:** The Edit User Page opens.

## Edit User Privileges, Continued

4. Enter the following data on the Edit User Page.

<b>Username</b>	The username for the account
<b>Password</b>	The password for the account (not echoed). To change the password, see <b>Change Passwords</b> , earlier in this chapter
<b>Administrator</b>	A check box indicating whether this account can create and manage the TSBroadcaster user accounts. You cannot change this parameter once you have created a user account
<b>Access to stream</b>	A check box for each stream indicating whether this account can schedule applications on the specified transport stream
<b>Privilege ManageSystem</b>	A check box indicating whether this account can configure and manage the TSBroadcaster system
<b>Privilege OperateSystem</b>	A check box indicating whether this account can monitor the system logs and records
<b>Privilege ManageStreams</b>	A check box indicating whether this account can define and edit stream definitions. If this privilege is set on an account, it implicitly has access to all streams
<b>Privilege ManageApplications</b>	A check box indicating whether this account can create, edit, and update data in broadcast applications
<b>Privilege ManageSchedule</b>	A check box indicating whether this account can schedule applications for broadcast
<b>Privilege OperateStreamEvents</b>	A check box indicating whether this account can inject stream events during application broadcast

5. Click the **Save** button to save the changes to the user account.

# Delete User

## Deleting Users

To delete a user, complete the following steps.

1. Log in to the TSBroadcaster as an administrator user with the appropriate privileges. See **Log In to the TSBroadcaster** in Chapter 3.

**Result:** After a successful login, the Home Page opens.

2. Click the **Users** button from the navigation bar.

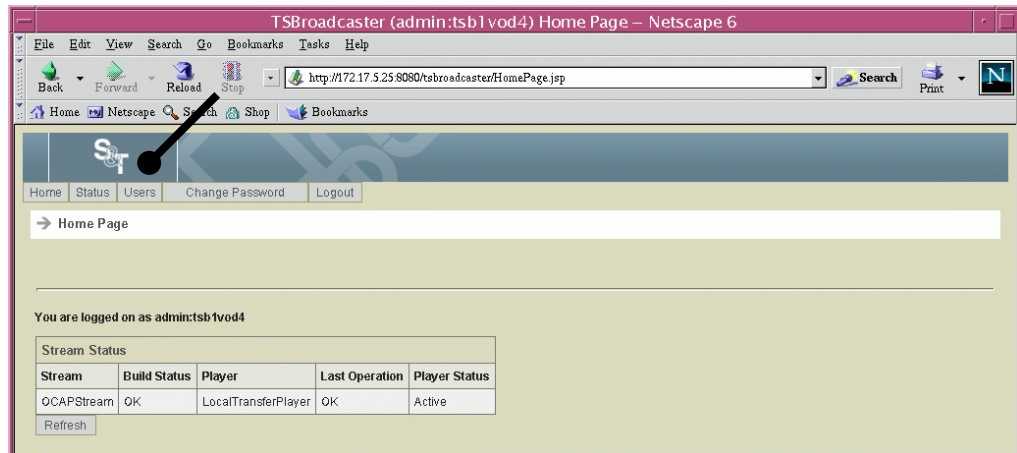

**Result:** The Manage Users Page opens.

3. Click the **Delete User** button on the Manage Users page.

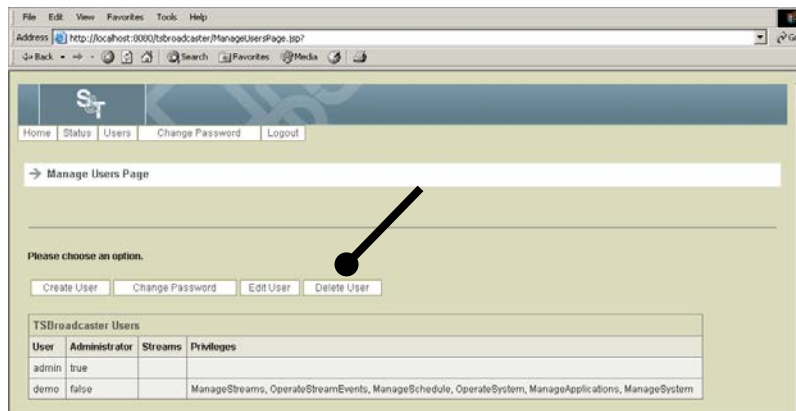

**Result:** The Delete User Page opens.

4. Select the user account you wish to delete.
5. Click the **Delete** button to delete the user account.

# File System Description

## Introduction

The TSBroadcaster file system is installed in **/disk1** directory, which is a link to a partition with sufficient free space to accommodate the TSBroadcaster software and data areas. The TSBroadcaster software file system is installed into the **/disk1/sandt** directory, and a **/sandt** link is created to reference it. The TSBroadcaster data file system is installed into the **/disk1/media1** directory, and a **/media1** link is created to reference it.

All files in the file systems are owned by the **sandt** user except for TSMux executable files that need **root** ownership to assume run-time privileges.

**Important:** The file system must not be changed except as directed in this manual.

## sandt Directory

The sandt directory contains the TSBroadcaster software and the following files.

**Note:** These directories use the British spelling for licence, and they should not be changed.

File	Description
/sandt/copyright	Contains the copyright terms of the TSBroadcaster licence
/sandt/java	Contains Java 1.4 SDK for use by the TSBroadcaster components
/sandt/licences	Contains the licence files for the TSBroadcaster
/sandt/scripts	Contains scripts to start and stop the TSBroadcaster components
/sandt/snmp	Contains SNMP monitoring Java archives and configuration files
/sandt/tsbroadcaster	Contains the TSBroadcaster web archive files under a Tomcat 4.1.24 installation
/sandt/tsmux	Contains TSMux executables
/sandt/tsplayer	Contains TSPlayer Java archives

# File System Description, Continued

## media1/logs Directory

The media1/logs directory contains the following directory and files.

File	Description
/media1/logs	Contains the TSMux log files in a directory
./err_warn_log.txt	Contains the current TSMux errors and warnings log
./err_warn_log.txt.0	Contains the previous TSMux errors and warnings log
./rep_log.txt	Contains the current TSMux report log
./rep_log.txt.0	Contains the previous TSMux report log

## /media1/tsbroadcaster Directory

The /media1/tsbroadcaster directory contains the following files and sub-directories.

File	Description
/media1/tsbroadcaster	Contains the TSBroadcaster data files in a directory
./broadcaster.properties	Defines the TSBroadcaster properties
./server.xml	Defines the TSBroadcaster server attributes
/media1/tsbroadcaster/archive	Contains the archived TSBroadcaster builds and logs in a directory
./yyyy-MM-dd.zip	Contains archived builds and logs up to the specified date in the TSBroadcaster time zone
/media1/tsbroadcaster/build	Contains recent TSBroadcaster builds in a directory
./stream	Contains recent TSBroadcaster builds for the transport stream in a directory
./yyyyMMdd_HHmmss_fff	Contains the TSBroadcaster build of this transport stream at the specified UTC time in a directory
./Content	Contains the definition of the structure and content of this transport stream in a directory

## File System Description, Continued

File	Description
./ocenc.xml	Defines the transport stream structure and content in the format specified in [SOFTOC]
./carousel	Contains the file system for carousel in a directory
./stream-pid-nn	Contains the Transport Stream kit component file number nn that stores the content to be carried on a PID
./stream-control	Contains the Transport Stream kit control XML file
/media1/tsbroadcaster/log	Contains the TSBroadcaster log files in a directory
./yyyyMMdd.log	Contains the log for the specified date in the TSBroadcaster time zone
/media1/tsbroadcaster/model	Contains the files defining the TSBroadcaster model in a directory
/media1/tsbroadcaster/work	Contains the TSBroadcaster work files in a directory

### /media1/tsmux Directory

The /media1/tsmux directory contains the following files.

File	Description
media1/tsmux	Contains the TSMux configuration files in a directory
./tsmux.logconf	Contains the TSMux log configuration
./tsmuxparams	Contains the TSMux input/output configuration
./av-content-file	Contains the A/V content to be added to the output Transport Stream

# File System Description, Continued

## /media1/tsplayer Directory

The /media1/tsplayer contains the following files and sub-directories.

File	Description
/media1/tsplayer	Contains the TSPlayer data files
./TSPlayer.ser	Defines the TSPlayer state
./TSPlayer.log	Contains the TSPlayer log
./yyyyMMdd_HHmms_fff	Contains the Transport Stream kit received by TSPlayer at the specified UTC time in a directory

# Maintain the TSBroadcaster

## Introduction

This section provides the list of maintenance tasks you should perform to enter that the TSBroadcaster continues to operate correctly.

## Maintenance Schedule

Unless otherwise stated, these activities should be carried out at least once per month, but they may be required more often. The frequency depends on the disk space available on the server, the size of the file systems in the object carousels, and how often they are updated.

The maintenance activities should be carried out at times when TSBroadcaster is not active to minimize their effect on the TSBroadcaster operation and performance.

## Required Maintenance

The following table lists the required maintenance tasks that you should perform on the TSBroadcaster.

Task	Description
Back up model files	Using the TSBroadcaster user interface, make a copy of the TSBroadcaster model to provide a backup of your data. You should make a backup whenever you change the model. See <b>Retrieve a Model</b> in Chapter 9 of this guide for further information.
Back up A/V content	Log in to the TSBroadcaster server as a sandt user, and copy the contents of /media1/tsmux to a safe location outside of /sandt or /media1.  You should make backup whenever you modify the A/V content or the /media1/tsmux/tsmuxparams file.
Back up the TSBroadcaster properties	Log in to the TSBroadcaster server as a sandt user, and copy the broadcaster.properties file from the /sandt/tsbroadcaster/ directory to a safe location outside of /sandt or /media1.  You should make a backup whenever you modify the file.
Delete TSBroadcaster archive files	Using the TSBroadcaster UI, delete old archive files, after first retrieving them for long term storage if required. See <b>Download Archives</b> in Chapter 9 of this guide for further information

## Maintain the TSBroadcaster, Continued

Task	Description
Delete Web server log files	Log in to the TSBroadcaster server as a sandt user, and empty the /sandt/tsbroadcaster/tomcat/logs directory.
Delete Web server temporary files	Log in to the TSBroadcaster server as a sandt user, and delete all files in the /sandt/tsbroadcaster/tomcat/temp directory.
Delete TSPlayer log file	Log in to the TSBroadcaster server as a sandt user, and delete the /media1/tsplayer/TSPlayer.log file.  <b>Important:</b> Do not remove log files until you are sure that you do not need them for diagnostic investigation.

# TSBroadcaster Properties

## Introduction

This section provides descriptions for the TSBroadcaster properties. The properties described in this section show the default values in parentheses for optional properties. You can add, change, or remove property values in this file as required. Re-boot the TSBroadcaster server after changing the properties file to start using the new values.

The TSBroadcaster reads in its properties at start-up from the following file:

**`/media1/tsbroadcaster/broadcaster.properties`**

## System Properties

The TSBroadcaster uses the following system properties.

Property	Description
system.serverFile	Defines the location of the server attributes file
system.modelRoot	Defines the directory holding the TSBroadcaster model
system.workRoot	Defines the working directory
system.buildRoot	Defines the directory holding the build files
system.logRoot	Defines the directory holding the log files
system.archiveRoot	Defines the directory holding the archive files
system.timeZone	Defines the time zone used by the system for schedule display and log and archive management
system.locale	Defines the locale of the system for text formatting purposes
system.hexadecimalPids	Defines whether decimal or hexadecimal PIDs are displayed (false)
system.streamEventCount	(5) Defines how many copies of a stream event are inserted into the output stream

## TSBroadcaster Properties, Continued

Property	Description
system.streamEventDelay	(0.1) Defines the period, in seconds, between each copy of a stream event
system.needSomeOutput	(false) Defines whether a system needs at least one connected and working output before it is declared as working correctly for monitoring purposes
system.needAllOutput	(false) Defines whether a system needs to have all its defined outputs working before it is declared as working correctly for monitoring purposes
system.schedulerLeadTime	(2.0) Defines how long, in seconds, before a scheduled event TSBroadcaster starts to update and distribute the new Transport Stream, so that the event is broadcast on time
system.updateLeadTime	(5.0) Defines how long, in seconds, before the start of an application playout TSBroadcaster starts to gather data from polled data update sources so that the data is available when the application is launched
system.buildLaterInterval	(20.0) Defines how long, in seconds, TSBroadcaster will wait before re-building a transport stream in response to data updates. This interval sets the lower limit on latency for non-rapid update data and provides resilience against “chattering” update sources. This interval does not apply to rapid updates
system.update-ConsolidationPeriod	(0.25) Defines how long, in seconds, TSBroadcaster will wait before re-building a transport stream in response to a single data update. This setting provides automated data update systems with the opportunity to make several related updates within this period before the carousel is rebuilt, thus promoting data consistency
system.shadow-UpdatePeriod	(30.0) Defines the minimum interval, in seconds, between successive updates of a partner TSBroadcaster

## TSBroadcaster Properties, Continued

system.ApplicationExpiry-Period	(30.0) Defines the minimum time, in seconds, after an application playout has finished for which TSBroadcaster will insert a “kill” signal into the AIT to ensure that the application stops running on receivers
system.updateBufferInitial-Allocation	(1024) Initial size of buffer used to read and store updates
system.updateErrorRetry-Delay	(60.0) Time, in seconds, to back off following an error trying to read a polled update data source
system.defaultUpdatePoll-Period	(6.0) Default poll period, in seconds, for polled updates

## Transport Stream Properties

The TSBroadcaster uses the following transport stream properties.

Property	Description
stream.MHP	(True – if neither stream.MHEG or stream.OCAP are selected) Defines whether MHP signaling is put into a DVB stream. Ignored if stream.OCAP is true
stream.MHEG	(False) Defines whether MHEG signaling is put into a DVB stream. Ignored if stream.OCAP is true
stream.OCAP	(False) Defines whether OCAP streams are produced for this installation. DVB streams are produced if this is not set
stream.sibitrateallowance	(500000) Bit rate allocation in bits per second to give headroom for SI tables
stream.siperiod	(0.1) Default repetition rate in seconds of SI tables
carousel.streamtype	(11) Type value for carousel reference
carousel.minSectionInterval	(0.0) Minimum interval in seconds between sections with the same table IDs
ait.type	(5) Type value for AIT reference

## TSBroadcaster Properties, Continued

<b>Property</b>	<b>Description</b>
ait.siperiod	(0.1) Repetition rate, in seconds, of AIT tables
service.siperiod	(0.5) Repetition rate, in seconds, of PMT tables
service.pedantic	(Yes) Internal checking flag

# TSBroadcaster Properties, Continued

## OCAP-Specific Transport Stream Properties

The TSBroadcaster uses the following OCAP-specific transport stream properties.

Property	Description
ocap.signallingStreamPid	(8187, 0x1ffb) The PID of packets carrying inband OCAP signalling (MGT, STT, LVCT)
ocap.xaitStreamPid	(8188, 0x1ffc) The PID of packets carrying inband XAIT signalling
ocap.signallingStreamType	(0) The stream type of the OCAP signalling and XAIT streams (not used because they are not referenced from a PMT)
ocap.signallingStream- AssocTag	(0) The association tag of the OCAP signalling and XAIT streams (not used because they are not referenced from a PMT)
ocap.signallingStream- BitRate	(100000) Bitrate allocated for the OCAP signalling and XAIT streams
ocap.mgtRepetitionPeriod	(1.0) Repetition rate, in seconds, of MGT table
ocap.lvctRepetitionPeriod	(1.0) Repetition rate, in seconds, of LVCT tables
ocap.lvctType	(cable) Delivery system value in LVCT tables
ocap.lvctCurrentNext- Indicator	(1) Current next indicator value in LVCT tables
ocap.lvctEtmLocation	(0) ETM location value in LVCT tables
ocap.sttRepetitionPeriod	(1.0) Repetition rate in seconds of STT tables
ocap.sttSystemTime	(Now) Reference time for time values in STT tables
ocap.sttGpsUtcOffset	(0) GPS UTC offset for STT
ocap.sttDsStatus	(0) Daylight saving time status value in STT
ocap.sttDsDayOfMonth	(1) Daylight saving day of month value in STT
ocap.sttDsHour	(1) Daylight saving hour value in STT

# TSBroadcaster Properties, Continued

## Miscellaneous Properties

The TSBroadcaster uses the following miscellaneous properties.

Property	Description
archive.period	(Daily) Defines whether archiving is carried out at daily, weekly, or monthly intervals
archive.keep	(1) Defines, in multiples of the archive period, what amount of historical data is left alone when the archive is run
snmp.trapPort	(none) Defines the port on which the SNMP agent can register an interest in trap data
applet.width	(800) Defines the width of the applets in the browser UI
applet.height	(600) Defines the height of the applets in the browser UI
player.retryDelay	(10.0) Defines the time in seconds to back off following an error on a player output

# Configure A/V Content

## Introduction

The TSBroadcaster supports playout of local audio and video (A/V) content to provide context for development, testing, and demonstration.

## Requirements

To make the TSBroadcaster play out A/V content, you must take the following steps:

- Procure the A/V content you want to play out
- Configure the system to play out the A/V content
- Configure the system to reference the A/V content

Several independent sets of A/V content may be added to the output.

## Procuring A/V Content

The TSBroadcaster requires the A/V content as a file containing a constant bit rate stream of 188 byte Transport Stream packets. The stream must contain one or more elementary streams carrying A/V components, with PCR embedded in at least one component. The stream can be an SPTS, an MPTS, or simply the selected components on their own.

The A/V content may be captured from the output of a digital broadcasting system or generated from A/V content in a different format.

Third-party tools are available to convert from common A/V formats into the required format. One such tool that you can use is the MPEGEncoder available from this URL:

<http://www.mainconcept.com/>

# Configure A/V Content, Continued

## Playing Out A/V Content

To play out A/V content, complete the following steps.

1. Transfer the A/V content file to the to the **/media1/tsmux** directory on either the TSBroadcaster or TSPlayer machine, if separate.
2. Edit the `/media1/tsmux/tsmuxparams` file to include the A/V content file in the list of inputs that the TSMux will process. Specify the following:
  - The location of the file
  - A list of elementary streams to be excluded from the file, referenced by their PIDs. This information allows you to remove redundant SI and other content from the file as it is played out
  - A list of elementary streams to be re-mapped from the PIDs that are in the file to the PIDs that are in the output. This information allows you to avoid PID clashes between the various inputs if you have A/V files with standard PID allocations
3. After making the changes, re-start the machine to allow the changes to be picked up.

The `/media1/tsmux/tsmuxparams` file shipped with TSBroadcaster includes a sample A/V content reference, which may be commented out with a `"#"` character.

```
-i -t 1 -n /media1/tsmux/av.mpg -x 0 480 -m 481:0x601 482:0x501
```

This line includes A/V content from file `/media1/tsmux/av.mpg`. PIDs 0 and 480 (the original PAT and PMT) are excluded, and the remaining two PIDs are re-mapped so that PID 481 is carried on PID 0x601 and PID 482 is carried on PID 0x501.

Further instructions for configuring TSMux input are given in the Sun Microsystems documentation.

# Configure A/V Content, Continued

## Referencing A/V Content

To reference the A/V content so that it will be displayed with a service, you must define what the A/V content is and then reference it from the PMT of one or more services.

To make a content reference, you need to identify the PID carrying the PCR for the content and then identify the PID, type, and association tag of each component.

The PID must refer to the PID carrying the component in the output after any re-mapping and the type must identify the component type. Any association tag may be used, as long as it does not conflict with the association tags of any other components that may be referenced in a PMT.

To reference the content from a service, edit the service and select the A/V content reference as the content for the service.

See **Create AV Content** in Chapter 3 for instructions for defining AV content and for component references.

# Configure ASI Output

## Introduction

The TSMux allows configuration of the format and bit rate of the ASI output. You may need to adjust these to suit your modulator and application. This section provides information for configuring the ASI output.

## ASI Format

ASI provides a fixed rate 270 MHz interface carrying 27 million 10-bit characters per second. Idle characters are used to pad between the desired payload bit rate and this fixed rate. The DVB specification for ASI allows these idle characters to be inserted between each MPEG TS packet ("packet" or "burst" mode) or between each data byte ("byte" or "gap" mode). Equipment with an ASI input should accept either format. However, experience shows that some equipment only works correctly with one or other format.

As shipped, the ASI output from TSMux is in "packet" mode. If your modulator requires "gap" mode, edit /media1/tsmux/tsmuxparams and add " -G 16" to the end of the output control line beginning "-o."

**Important:** ASI cards shipped before 2004 do not support "gap" mode. Contact your supplier if you have such a card and your modulator requires "gap" mode.

## ASI Bit Rate

Some modulators use the received ASI data rate to control their modulator logic or have other constraints on their operation. In this case, the ASI bit rate must be specified exactly. Other modulators provide their own modulation time base and remultiplexer function. In this case, the ASI data rate does not need to be set exactly. For example, some modulators may need the ASI output rate configured as 24128363 while others can function with 24000000 or even 10000000.

As shipped, the ASI output bit rate from TSMux is set to 24128363 for DVB systems and 24000000 for OpenCable Application Platform (OCAP) systems. If your modulator requires an exact bit rate, edit /media1/tsmux/tsmuxparams and replace the bit rate in the output control line beginning "-o" with an exact bit rate.

# Deployment Options

## Introduction

The TSBroadcaster and TSPlayer can be deployed in a number of different ways to provide the capability for distributed and redundant operation. This section provides information on your deployment options. Contact your supplier if you wish to discuss deployment location options to meet a particular requirement.

## Locating the TSBroadcaster and TSPlayers

The TSBroadcaster can be located at a central management site, connected to the TSPlayers at the remote sites by TCP/IP over WAN. This option allows you to manage a distributed playout network from a single site.

The TSPlayers can be located at transmission sites, minimizing the need for ASI or RF distribution, and can be managed remotely, minimizing the need for on-site intervention.

## Using Redundant Pairs

The TSBroadcasters can be deployed in dual-redundant pairs to provide continuous control resilient to the failure of a single TSBroadcaster.

TSBroadcasters can be deployed in 1-to-N redundant configuration. A spare TSBroadcaster may rapidly be brought on-line to replace a failed unit by loading it with a copy of the model file from that unit.

The TSPlayers can be deployed in dual-redundant pairs under the control of the TSBroadcaster to provide continuous transmission resilient to failure of a single TSPlayer.

# Chapter 11

## Troubleshooting

### Overview

### Introduction

This chapter provides solutions to issues that you may encounter while using the TSBroadcaster and provides a solution for each issue. Information on the OCAP Explorer troubleshooting tool is also provided.

### In This Chapter

This chapter contains the following topics.

Topic	See Page
Cannot Access TSBroadcaster from Browser	11-2
Cannot Access the TSBroadcaster Login Page from Browser	11-3
Java Applet Fails	11-4
Cannot Drag Files on Linux Desktop	11-5
Cannot Access the Navigation Bar	11-6
Cannot Tune to Stream	11-7
Player or Transfer Player Fails	11-8
Time Changes Break Log File Display	11-9
You Accidentally Delete the Wrong Thing	11-10
Applications Start at the Wrong Times	11-11
OCAP Explorer	11-12

# Cannot Access TSBroadcaster from Browser

## Issue

You cannot access the TSBroadcaster from your Web browser.

## Solution

If you cannot reach the TSBroadcaster through the Web browser, take the following steps:

- Check that you are typing in the correct address with port 8080.
- Check that the TSBroadcaster has been switched on long enough to finish the boot up process.
- Check that the client machine is connected to the TSBroadcaster server through the network.
- Check that the TSBroadcaster has a license that matches the ASI card serial number and that the license has not expired.

# Cannot Access the TSBroadcaster Login Page from Browser

## Issue

You cannot access the login page for the TSBroadcaster from your browser.

## Solution

If the Manage Server Page appears, try the following:

- If the state is `CheckingActivePartner`, wait a few seconds and select the Refresh button.
- If the state is `Standby`, select the Assume Role button and assume a role.
- If the state remains in `Standby` after assuming a role, select the Load Model button and load a model from a known working configuration.
- If the state is `Shadowing`, you can either work on the partner machine or select the Drop Partner button to stop shadowing the other machine.

# Java Applet Fails

## Issue

The **View Playouts** or **Develop Application** JAVA applets fail.

## Solution

If the **View Playouts** or **Develop Application** applets fail to start, try the following:

- Check that the browser has a Java 1.4.\*\plugin.
- Check that there is a .java.policy file with the address of the TSBroadcaster server in the client user's home directory.

# Cannot Drag Files on Linux Desktop

## Issue

You cannot drag files to another location on your Linux desktop.

## Solution

Some Linux desktops do not support a drag and drop mechanism that is compatible with Java. Load files and directories into the Develop Application Page applet by right-clicking a directory and selecting **Import File** or **Import Content Directory** from the pop-up menu.

# Cannot Access the Navigation Bar

## Issue

You cannot access the navigation bar on the TSBroadcaster GUI.

## Solution

Your login session has timed out due to inactivity. Select the **Login** button to log in again. The navigation bar should now appear.

# Cannot Tune to Stream

## Issue

Your receiver cannot tune to the stream you have selected.

## Solution

If your receiver cannot tune to the stream, try the following:

- Check that the ASI output port is connected to the ASI input port of the modulator.
- Check that the modulator RF output port is connected to the receiver RF input.
- Check that the modulator is on.
- Check the signal is attenuated sufficiently for the receiver (common cable modulator problem).
- Check the settings on the modulator, the delivery parameters in the TSBroadcaster, and the tuning parameters on the receiver all match.
- If you are integrating with an OCAP headend, check that the TSBroadcaster parameters are consistent with the OCAP headend parameters.

# Player or Transfer Player Fails

## Issue

The player or transfer player fails.

## Solution

If the Player or Transfer Player status is **Failed**, try the following:

- If the player is on a separate machine, check that it is on, physically connected, and visible on the network at the specified address.
- Check the player parameters.
- Edit the player parameters and re-enter the password.

# Time Changes Break Log File Display

## Issue

If you change the server time or the TSBroadcaster time zone, data in the build and log files is no longer stored in the order assumed by TSBroadcaster.

## Solution

After changing system time or the TSBroadcaster time zone, delete or move the contents of the log and build directories in /media1/tsbroadcaster to avoid confusion.

# You Accidentally Delete the Wrong Thing

## Issue

While working with TSBroadcaster, you accidentally delete information that you want to keep.

## Solution

Get into the habit of saving the TSBroadcaster model before making changes to TSBroadcaster so that you have a model to restore.

# Applications Start at the Wrong Times

## Issue

If an application does not launch or terminate when the red line on the View Playouts Page meets the end of the relevant playout bar, it indicates that the client system time has not been synchronized with the TSBroadcaster server time.

## Solution

Change the client or server system times to match each other. Then the applications will launch and terminate when the red line crosses the end of the playout bar.

# OCAP Explorer

## Introduction

The OCAP Explorer provides a view of the object carousel file system. You can use this troubleshooting tool to verify that the application is working and to examine the file system of the carousel.

## Troubleshooting with the OCAP Explorer

You can use the OCAP Explorer to navigate around the directory using the Up and Down arrows and select an entry by pressing OK. If you select a directory, OCAP Explorer will browse it. If you select a graphics file, OCAP Explorer will display the graphic (scaled down if needed to fit) and will return to the directory when you press OK. If you select a text file, OCAP Explorer will display the text and allow you to scroll using Up and Down arrows and return to the directory when you press OK. If you select a type of file that OCAP Explorer does not recognize, it will tell you that and return to the directory when you press OK.

The initial class of the OCAP Explorer is `com.sandt.mhp.OCAPExplorer`.

# Chapter 12

## TSBroadcaster APIs and SNMP Monitoring

### Overview

### Introduction

This chapter provides information on the APIs that you can use with the TSBroadcaster. A description of SNMP monitoring is also provided.

### In This Chapter

This chapter contains the following topics.

Topic	See Page
Java API	12-2
XML API	12-3
SNMP Monitoring	12-5

---

# Java API

## Introduction

This section provides information for implementing JAVA APIs. If you cannot implement JAVA APIs, see **XML API**, next in this chapter.

## How Is the JAVA API Implemented

The Java API is implemented as a set of client classes. Each client class provides methods to implement all the interactions with TSBroadcaster described in this manual.

The client classes are supported by a set of data and model classes. The data classes provide strongly typed primitive data types for the parameters of the interactions described in this manual. The model classes provide strongly typed, XML-backed data structures implementing the data structures described in this manual.

The Java API is documented using javadoc notation in JAVA API in the Sun Microsystem documentation.

# XML API

## Introduction

The XML API provides an alternative API that can be used in environments where writing Java programs is not practicable. XML APIs are intended to provide a simple scripting interface that can be driven from the command line or other automated system.

## XML API Contents

The XML API consists of a small Java client program that reads in the TSBroadcaster commands from a file in XML format and executes them. It can also retrieve information from the TSBroadcaster and save it to a file. The script performs the following operations:

- Logs in to TSBroadcaster
- Prints a message to standard output
- Adds a carousel to the test stream
- Delays 2 seconds
- Adds a scheduled playout to the test stream
- Delays 1 minute
- Logs out of TSBroadcaster

# XML API, Continued

## Sample Script

A short example script is shown below.

```
<?xml version="1.0" encoding="UTF-8"?>
<session>
  <request command="login" function="users">
    <parameter name="password" value="demo"/>
    <parameter name="username" value="demo"/>
  </request>

  <message>TEST 5.8. 0bps - 24000000bps</message>
  <message>-----</message>
  <message> </message>
  <message>TS bitrate = 24000000</message>

  <request function="streams" command="addCarousel">
    <parameter name="streamName" value="TestStream1"/>
    <parameter name="carouselName" value="Carousel1"/>
    <parameter name="carouselId" value="11"/>
    <parameter name="carouselPid" value="1001"/>
    <parameter name="carouselAssociationTag" value="11"/>
    <parameter name="carouselBitRate" value="23500000"/>
  </request>

  <delay hours="0" minutes="0" seconds="2"/>

  <request function="streams" command="addScheduledPlayout">
    <parameter name="streamName" value="TestStream1"/>
    <parameter name="playoutName" value="Playout1"/>
    <parameter name="playoutApplicationSet" value="mheg"/>
    <parameter name="playoutCarousel" value="Carousel1"/>
    <parameter name="playoutBitRate" value="1000"/>
    <parameter name="PlayoutBitRateShared" value="1"/>
    <parameter name="playoutControlPolicy" value="present"/>
    <parameter name="playoutStartTime" value="2004-01-01 00:00:00"/>
    <parameter name="playoutDuration" value="01:00"/>
    <parameter name="PlayoutRepeatPolicy" value="Continuous"/>
    <parameter name="playoutCutOffTime" value="2005-01-21 00:00:00"/>
    <parameter name="playoutServiceName$$Service1" value="Service1"/>
    <parameter name="playoutParameters$$$Service1" value="" />
  </request>

  <delay hours="0" minutes="0" seconds="60"/>

  <request command="logout" function="users">
  </request>
</session>
```

# SNMP Monitoring

## Introduction

The TSBroadcaster and TSPlayer provide status monitoring via SNMP polling and traps. This section provides information on how SNMP monitoring works.

## How SNMP Monitoring Works

The SNMP monitoring is performed by standalone SNMP monitor programs. Each program polls status information from the TSBroadcaster or TSPlayer program every 30 seconds and makes it available through an SNMP interface. This implementation allows active reporting if the TSBroadcaster or TSPlayer programs stop responding.

The monitoring programs provide monitoring for the TSBroadcaster on port 2161 and the TSPlayer on port 1161. The monitoring programs forward any monitoring requests that they cannot fulfill to the standard SNMP monitoring port 161. This allows a single SNMP monitor port to provide information about the TSBroadcaster or TSPlayer and the standard reporting provided by the operating system.

The MIB for TSBroadcaster and TSPlayer is registered under enterprise 18675 and is defined in [MIB].



Cisco Systems, Inc.  
5030 Sugarloaf Parkway, Box 465447  
Lawrenceville, GA 30042

678 277-1120  
800 722-2009  
[www.cisco.com](http://www.cisco.com)

This document includes various trademarks of Cisco Systems, Inc. Please see the Notices section of this document for a list of the Cisco Systems, Inc. trademarks used in this document.

Product and service availability are subject to change without notice.

© 2006 2012 Cisco and/or its affiliates. All rights reserved.  
June 2012 Printed in USA

Part Number 4011043 Rev B